

clé GRAND PLACE LIMESTONE

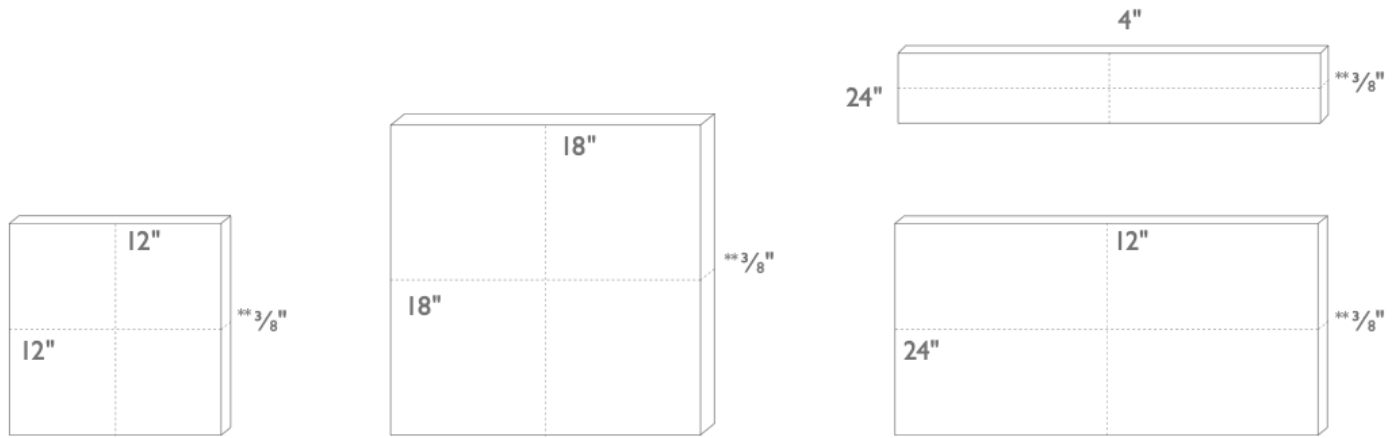

PRODUCT USAGE	interior floor	interior wall	exterior floor	exterior wall	residential light traffic	residential heavy traffic	commerical light traffic	commerical heavy traffic	radiant heating compatible	fireplace surround
CORNET, LOUPE, TABOR	Y	Y*	Y*	Y*	Y	Y	Y	N	Y	Y
CERUSE, TANNER, BARROW, MARFIL, ANGE, MOULIN, HERMITAGE, BRAE, CARTWRIGHT, ARBOR	Y	Y*	Y*	Y*	Y	Y	Y	Y	Y	Y

PRODUCT USAGE	shower	shower wall	steam shower	fountain	freeze thaw	pool	heat resistant	sink backsplash	stove backsplash	UV resistant
TANNER, CARTWRIGHT, ARBOR	Y*	Y*	N	N	Y	N	Y*	Y*	Y*	Y
CORNET, CERUSE, BARROW, MARFIL, MOULIN, HERMITAGE, BRAE, LOUPE, TABOR	Y*	Y*	N	N	N	N	Y*	Y*	Y*	Y
ANGE	N	Y*	N	N	N	N	Y*	Y*	Y*	Y

*There are specific installation requirements for this usage. Please review the "Installation Areas", "Sealing, Maintenance, & Care", and "Average Coefficient of Friction" areas below and discuss with your installer.

**Standard thickness for limestone is $3/8"$ with the exception of cornet $18" \times 18"$ which has a thickness of $5/8"$, and marfil $18" \times 18"$ and $12" \times 24"$ which have a thickness of $1/2"$.

Please note all dimensions are nominal. Please note that dimensions can vary $\pm 1/8$ inch.

clé GRAND PLACE LIMESTONE

What's in our tile: elegant, restrained, and imbued with quiet, noble simplicity, clé's grand place collection of limestone offers versatility, durability, and depth for a wide range of design styles, from traditional and classic to ultra-modern. With a smooth, fine-grained look, and ranging in color from cream to deep gray, clé limestone brings a little tonal moodiness, a bit of shadow and light that elevates any space.

Limestone is a natural stone which will exhibit degrees of variation in color and shade. Our tiles are cut from large blocks of limestone, therefore there will be variation in color and shade across production lots or batches depending on the area of the quarry a particular lot was pulled from. This means that your sample may not be a perfect match with your actual order, and that your add-on order may not be a perfect match to either. **This is the beauty of artisanal tile!**

INSPECTING YOUR SHIPMENT

- **WHAT TO EXPECT** - Limestone is a natural stone which will exhibit a smooth honed surface. ALSO- Dust and shipping residue are to be expected and should be cleaned prior to installing.
- **BLEND BLEND BLEND** - due to the natural material makeup and production process of limestone tiles, there will be degrees of variation in color, shade, and size in your order, therefore it is important to blend the tiles from all boxes once they arrive and place them in their installation area to ensure you have the layout you want before installing.
- **ORDER EXTRA!** - industry standard suggests adding at least 15% overage due to tile cuts, potential shipping breakage, or future repairs. However, if the variation in color and shade natural to limestone tiles do not fit your project's needs, we recommend ordering 20-30% overage. This will allow your contractor to cherry-pick the tiles most desirable for your project.
- **SHIPMENTS ARE SUBJECT TO WEATHER** – tiles may be exposed to moisture and/or condensation during production or shipping which may affect the color of the tiles once received. Setting the tiles out to dry prior to installation will return the color to normal. Do not install tiles until fully dried.

INSTALLATION FYIs

- **GENERAL GUIDELINES, NOT INSTRUCTIONS** - clé offers general information about our tiles and their unique qualities and usages. Proper installation will only be attained if you have selected a seasoned installer with years of experience with artisan tiles. Any installer without artisan tile experience will not know how to install clé tiles and will likely result in failed installations.

- **INSTALLATION DEEMS ACCEPTANCE OF YOUR ORDER** - if you are not 100% sure of your tiles- DO NOT INSTALL THEM. As is standard in the tile industry and with all construction materials, installation deems acceptance of materials. Do not install if there are visible issues. If you have any doubts or are unsure of what qualifies as a visible issue for the tile you are installing, please reach out to us PRIOR to installation. Our tiles are subject to variations in color, texture, size, and finish. Misuse by contractor or end-user including but not limited to negligence, physical and/or chemical abuse, as well as order shortages ARE NOT a clé responsibility and therefore, not covered by clé's warranty.
- **TILE IS A MATERIAL. INSTALLATION ERRORS ARE NOT THE FAULT OF THE MATERIAL** – clé tile is a material. Tile is merely the surface of your construction. Installation problems will arise from inexperienced artisan tile installers, substrate, or construction engineering and/or installation issues. Please refer to your project architect, structural engineer and/or installer for best results Do not use blue tape or other construction tape during product installation. We cannot guarantee that the tape will not erode or damage our products.
- **PLEASE CONFIRM YOUR INSTALLER'S LEVEL OF ARTISAN TILE EXPERIENCE** - your installation will only be as good as your installer. Please visit our blog for tips on [how to choose an installer](https://www.cletile.com/blogs/cle-notes/how-to-choose-contractor-installer) (<https://www.cletile.com/blogs/cle-notes/how-to-choose-contractor-installer>).
- **REQUIRE YOUR INSTALLER PERFORM A “DRY RUN” BEFORE BEGINNING YOUR INSTALLATION** – before installing, make sure to lay out and blend ALL BOXES of your tiles so that your variations in color, and tiles that bear chips and pits are artfully placed as you would like. clé selects our tiles for their hand-hewn variations and their inherent surface and color variations, which include pits, cracks, and chipping. The best placement of these nuances throughout your installation must be guided by you and/or your design professional to realize the best possible blend of your shipment of our limited-availability tiles. Your installation is only as good as your DRY RUN.
- **DO NOT USE TAPE, BLUE TAPE, OR OTHER TAPE** - do not use blue tape or other construction tape during product installation. We cannot guarantee that the tape will not erode or damage our products.
- **WAIT UNTIL YOUR PROJECT IS COMPLETE BEFORE INSTALLING YOUR TILES** - install the tiles as late as possible in the project to minimize the risk of damaging the tile.
- **REQUIRE MOCK-UP BOARDS** – your next step to ensure your tiles will be organized properly and your grout joint size and color, as well as your sealant, are done to your design professional's specifications- we urge you to require your installer create mock-up boards prior to your installation. This is a STANDARD PRACTICE for seasoned installers as it enables the end-user and their design professional to test all the tile layouts in mock-up form and, also will allow for the mock-up boards to be examined in the space and lighting in which the tiles will be used. Before beginning the mock-up boards- make sure to FIRST do your above-recommended DRY RUN and lay out and blend your tiles as described in that section.

- **“FINAL FINISH” – WHAT IT IS AND WHY MAY YOUR PROJECT REQUIRES THIS?** - if you plan install your tile prior to the installation of cabinets, fixtures, etc., you’ll need be refinish the tile after those other features are installed in a step we call the “final finish.” In this step, your contractor should replace any broken or chipped tiles caused by construction damage, scuffing, or any deterioration of the tile surface. They should also hire a professional refinisher for the final refinishing of your tile installation. (*NOTE – Another benefit is that shipping refinishing can alleviate common shipping imperfections.). Make sure to account for this final step in your project timeline and budget.
 - **TCNA and ANSI** - Please refer to the current edition of the TCNA Handbook for best installation results and ANSI A137:1 American National Standard Specifications for Ceramic Tile to reference specifications.
-

INSTALLATION AREAS

- Limestone tiles can be used on interior floors and walls.
- Limestone tiles can be used in areas of light commercial traffic areas. Additionally, ceruse, tanner, barrow, marfil, ange, moulin, hermitage, brae, cartwright, and arbor can be used for commercial heavy traffic areas.
- Limestone tiles can be used on exterior floors. In cold-weather areas, they must be installed above-grade on covered decks or verandas and sealed with a water-repellent sealer.
- Limestone tiles can be used on exterior walls. In cold-weather areas there must be flashing or roofing overhead and the tiles must be sealed with a water-repellent sealer.
- Limestone tiles are heat resistant and can be used on fireplace surrounds.
- Limestone tiles are radiant heating compatible.
- Limestone tiles can be installed on backsplashes, bathrooms, and showers with application of a waterproofing, penetrating sealant.
- Limestone tiles should not be installed in steam showers.
- Tanner, cartwright, arbor, cornet, ceruse, barrow, marfil, moulin, hermitage, brae, loupe, tabor can be used on showers. To increase slip resistance in these installation areas, larger tiles can be scored to create grooves on the surface of the tile. Additionally, using a thicker grout line, an off-center placement and/or using smaller 2” x 2” tiles, can also provide protection because there are more grout lines.
- Ange can be used on shower walls only

- Limestone tiles are heat resistant and can be used as a stove backsplash, please consult with your installer to see if a range splash is required for your installation.
 - Limestone tiles are not suitable for pools, fountains, or their water lines.
 - Cornet, ceruse, barrow, marfil, moulin, hermitage, brae, loupe, tabor, and ange are not freeze/thaw resistant.
 - Tanner, cartwright, and arbor are freeze/thaw resistant.
-

GROUT

- clé recommends a 1/8" grout joint with this collection.
- clé recommends using mortar and grout that comply with the ANSI A118 or ISO 13007 classifications suitable for your project. Please consult with your installation professional to make these determinations.
- Grout color selection is always up to our client and/or their design professional. However, clé is often asked for our opinion on best grout selections for our tiles. And due to the large array of grout colors that are now available, clé would like to offer this general guideline on a grout color selection for any of your clé tiles.
 - First, have your contractor complete your tile installation, except for the grout portion.
 - Next, ask your contractor to bring ALL grout color charts from his preferred grout manufacturer for your review.
 - Lastly, choose a time of day when you are most pleased with the lighting in your space (either natural lighting, installed lighting or a blend of both). During that lighting and time of day, select the grout color that best matches your tile selection.
 - If you are working with highly color-variegated tiles or a combination of tiles, we recommend that you follow the above recommendations—but match your grout to the color in your installation that you would like to accentuate.
- If your contractor is having any issues or questions regarding grout, please reach out to the grout manufacturer directly. They are the best and fastest line of contact.

SEALING, MAINTENANCE & CARE

- Shower installations
 - For these installations we recommend sealing pre-grout with Laticrete Bulletproof Sealer.
 - As a post-grout final seal, we recommend applying 2 coats of Laticrete Bulletproof Sealer. Then, after letting the sealer cure for 24 hours, applying one or two coats of Laticrete Heavy Duty Exterior Sealer.
 - Please note that all Grand Place Limestone tiles are subject to rust spots and water staining if exposed to excessive moisture.
 - To reduce the occurrence of rust spots and other water-related stains, we suggest the following maintenance plan:
 - Dry off the surface after each use. We suggest using a squeegee.
 - Frequent cleaning with Laticrete Revitalizer Cleaner & Protector. Note: this product is mild enough that it can be used as frequently as daily.
 - Spot cleaning any stains with Laticrete Soap Scum Remover or Laticrete Mold & Mildew Stain Remover.

- Please follow Laticrete's [Sealing, Maintenance, and Care](#) guide for more guidance on cleaning, maintaining, and caring for your tile installation.

- **If you have any questions regarding Laticrete products or how to use them, please contact Laticrete directly by phone: 1-800-243-4788 X 1235.**

ADDITIONAL SPECIFICATIONS







COLOR, TEXTURE AND SIZE VARIATION

Limestone is a natural stone which will exhibit degrees of variation in color and shade, therefore there will be variation in color and shade across production lots or batches depending on the area of the quarry a particular lot was pulled from. This means that your sample may not be a perfect match with your actual order, and that your add-on order may not be a perfect match to either.

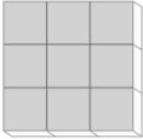
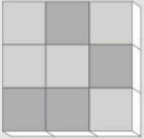
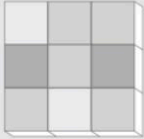
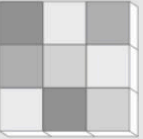
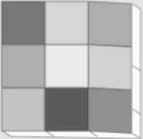
Please note that some tiles feature quartz veining that are naturally occurring in the stone.

The following is a guide for the different degrees of variation that we have assigned our tiles:

Color variation ranges from 'level 2 slight' to 'level 5 extreme'. Texture variation is rated 'level 1 smooth' and 'level 1 slight' for size variation.

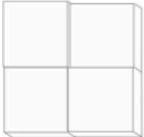
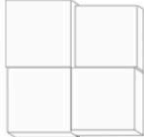
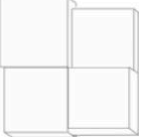
CATEGORY	LEVEL 1	LEVEL 2	LEVEL 3	LEVEL 4	LEVEL 5
COLOR VARIATION	 <p>low</p>	 <p>slight (cornet, ceruse, tanner, ange, moulin, loupe, cartwright, arbor, tabor)</p>	 <p>medium (barrow, marfil, hermitage)</p>	 <p>heavy (brae)</p>	 <p>extreme</p>
TEXTURE VARIATION	 <p>smooth</p>	 <p>slight</p>	 <p>medium</p>	 <p>heavy</p>	n/a
SIZE VARIATION	 <p>slight</p>	 <p>medium</p>	 <p>heavy</p>	 <p>extreme</p>	n/a

FLOOR RATING

clé limestone is rated III (can be used for light residential to light commercial foot traffic). All stones are suitable for light commercial foot traffic. Additionally, ceruse, tanner, barrow, marfil, ange, moulin, hermitage, brae, cartwright, and arbor are suitable for heavy commercial foot traffic.

I light residential

for residential areas with light foot traffic. examples can include bathroom, bedroom, formal dining and living rooms. please note the following:

- not suitable for shoes with hard sole profiles (cleats, stilettos, etc.)
- the floor must be kept clean from abrasive debris (gravel, mud, salt, etc.)
- immediately clean all stains (food, personal and household care products, oils, paints, chemicals etc.)

II heavy residential

for residential areas with continuous foot traffic. examples can include entry, hallway, kitchen, foyer, laundry and mud rooms. please note the following:

- the floor must be kept clean from abrasive debris (sand, gravel, mud, salt, etc.)
- immediately clean all stains (food, personal and household care products, oils, paints, chemicals etc.)

III light commercial

for commercial areas with light foot traffic. examples can include commercial offices, doctor's offices and boutiques. please note the following:

- the floor must be kept clean from abrasive debris (sand, gravel, mud, salt, etc.)
- immediately clean all stains (food, personal and household care products, oils, paints, chemicals etc.)

IV heavy commercial

for commercial areas with continuous foot traffic. examples can include hotel lobby, retail, corridors in an office building, shopping mall and restaurant. please note the following:

- the floor must be kept clean from abrasive debris (sand, gravel, mud, salt, etc.)
- immediately clean all stains (food, personal and household care products, oils, paints, chemicals etc.)

V industrial

standard industrial floor use with no extreme, heavy breakage or spillage. examples can include restaurant kitchen, bar work area, winery production, exterior hotel entry, airport, car showroom, driveway. please note the following:

- the floor must be kept clean from abrasive debris (sand, gravel, mud, salt, etc.)
- immediately clean all stains (food, personal and household care products, oils, paints, chemicals etc.)

PRODUCT DESCRIPTION

Honed limestone. Cornet, tanner, and barrow come with eased edges. Ceruse, marfil, ange, moulin, hermitage, brae, loupe, cartwright, arbor, and tabor come with micro beveled edges.

PRODUCT COMPONENTS

Natural stone.

DIMENSIONS

Square	30.48 cm x 30.48 cm x 0.95 cm (12" x 12" x 3/8 ^{**}) / 2.5 kg per tile (5.5 lb)
Square	45.72 cm x 45.72 cm x 0.95 cm (18" x 18" x 3/8 ^{**}) / 5.6 kg per tile (12.4 lb)
Rectangle	30.48 cm x 60.96 cm x 0.95 cm (12" x 24" x 3/8 ^{***}) / 5 kg per tile (11 lb)
Plank	10.16 cm x 60.96 cm x .95 cm (4" x 24" x 3/8") / 1.7 kg per tile (3.66 lb)

* Please note all dimensions are nominal. Please note that dimensions can vary +/- 1/8".

** With the exception of cornet 18"x18" which has a thickness of 5/8" and marfil 18"x18" which has a thickness of 1/2"

***With the exception of marfil 12"x24" which has a thickness of 1/2"

AVERAGE COEFFICIENT OF FRICTION (DCOF ACUTEST)

"Wet Dynamic Coefficient of Friction" (DCOF)

Ange	avg. 0.38
Arbor	avg. 0.43
Hermitage, Brae	avg. 0.46
Ceruse, Loupe	avg. 0.47
Barrow, Moulin	avg. 0.50
Marfil	avg. 0.51
Tanner, Cartwright	avg. 0.52
Cornet, Tabor	avg. 0.56

*Please note that the application of an anti-slip sealant/treatment may help increase slip-resistance.

FREEZE/THAW RESISTANCE (ASTM C1026)

Cornet, ceruse, barrow, marfil, moulin, hermitage, brae, loupe, tabor, and ange are not freeze/thaw resistant. Tanner, cartwright, and arbor are freeze/thaw resistant.

WATER ABSORPTION (ASTM C373)

Cartwright	avg. 0.11%; vitreous
Marfil	avg. 0.27%; vitreous
Barrow	avg. 0.34%; vitreous
Arbor	avg. 0.35%; vitreous
Brae	avg. 0.62%; vitreous
Hermitage	avg. 1.02%; vitreous
Tanner	avg. 1.40%; vitreous
Ceruse	avg. 1.60%; vitreous
Moulin	avg. 1.69%; vitreous
Ange	avg. 1.73%; vitreous
Loupe	avg; 3.6%; semi-vitreous
Tabor	avg. 3.78%; semi-vitreous
Cornet	avg. 5.2%; semi-vitreous

ACID RESISTANCE

clé limestone tiles are not resistant to acids and only mild, pH neutral cleaners should be used.

LEED CREDITS

The product is an inherently non-emitting source of VOCs (stone, ceramic, metals, powder-coated metals, plated or anodized metal, glass, cement, clay brick, and unfinished or untreated solid wood) and has no integral organic-based surface coatings, binders, or sealants.

Limestone tiles are considered ‘inherently non-emitting sources’ under the Low-emitting Materials Credit of LEEDv4/v4.1. **This is the only credit for our limestone tile that is eligible to be used toward LEED.**

‘Inherently non-emitting’ means that these tile types have been shown to not contribute emissions to indoor environments and are therefore exempt from demonstrating compliance with CDPH v1.1-2010 or CDPH v1.2-2017.

Use of these tiles as Wall or Flooring materials should be entered in the LEED v4.1 low-emitting materials calculator and identified as ‘inherently non-emitting’ in the Products Tab (Column L).

Disclosures for MR Credit Material Ingredient Disclosures under LEEDv4/v4.1, are not available at this time. We are exploring our disclosure options and have not established a timeline for completion.

Disclosures for MR Credit Environmental Product Declarations under LEEDv4/4.1, are not available at this time. We are exploring our disclosure options and have not established a timeline for completion.

Contribution to MR Credit Material Sourcing under LEEDv4/v4.1, does not apply as there is no recycled content, no bio-based materials, no wood, no reused products included in our tile at this time. Extended producer responsibility programs are highly difficult to manage given the nature of end-of-use tile removal methods. *Tile can last hundreds of years but fashions often change, which is the dominant reason for its removal. We work hard to ensure our stone tiles can withstand the test of time while remaining timeless.*

RECYCLED CONTENT

There is no recycled content in our limestone tiles at this time. See material sourcing disclosure above.

PERCENTAGE OF PRE-CONSUMER AND/OR POST-CONSUMER MATERIALS

There is no pre-consumer or post-consumer material content in our tiles at this time. See material sourcing disclosure above.

FIRE RATING

Typically, natural stone tile does not need to have fire rating testing performed. It is our understanding from TCNA that the explanation that natural stone is inorganic, inert, and typically free of materials that could burn or produce smoke is generally enough to satisfy a specifier and that testing is not necessary.

Natural stone tile falls under the description, “because stone tile is non-flammable and does not produce smoke in a fire, it inherently meets the flame spread and smoke development requirements of Section 803 of the International Building Code (IBC) for interior wall and ceiling materials.”