

FORNACE BRIONI + CRISTINA CELESTINO TERRACOTTA - WALL

USAGE	Y / N
interior floor	N
interior wall	Y
exterior floor	N
exterior wall	Y*
light residential traffic	N
heavy residential traffic	N
light commercial traffic	N
heavy commercial traffic	N
industrial traffic	N
shower	N
steam shower	N
fountain	N
pool	N
freeze/thaw	N
UV resistant	Y
radiant heating compatible	N/A
heat resistant	Y
fireplace surround	Y
stove backsplash	Y*
sink backsplash	Y*
grout joint size	varied*

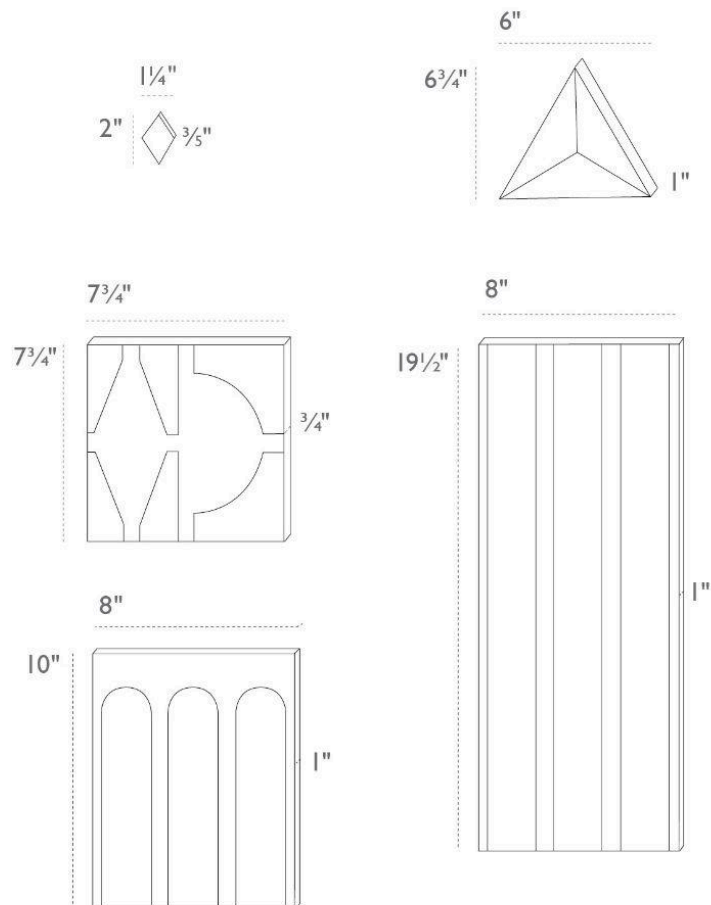

Standard thickness for Trama is 3/8", for Mantegna and Giulio Romano 1", and for Acanti 3/4".

Please note all dimensions are nominal. Additionally, dimensions can vary +/- 1/4" for Acanti and Giulio Romano, and +/- 1/8" for Trama and Mantegna.

* There are specific installation requirements for this usage. Please review the "installation Areas" and "Grout" sections below, and discuss with your installer.

FORNACE BRIONI + CRISTINA CELESTINO

TERRACOTTA—WALL

What's in our tile: Fornace Brioni features an extraordinary collection of both traditional terracotta and glazed ceramic tiles made in collaboration with architect and designer Cristina Celestino. The traditional terracotta - or cotto - heralds from Gonzaga, a small town in the Lombardy region of Italy steeped in renaissance history and renowned for its terracotta. These tiles are still created by hand by the family-run company, now in its third generation, headed by Alberto Brioni. Created from the finest clays from the floodplain of the river Po, cotto is nothing more than the combination of water and earth that when exposed to fire, creates a subtle alchemy that becomes embodied in each tile. Both natural and ecological, each hand-made tile is unique and offers the best of Italian craftsmanship.

Due to the handmade craftsmanship of our tiles and the variety of materials used, there will be degrees of variation in color, shade, size and texture across production lots or batches. This means that your sample may not be a perfect match with your actual order, and that your add-on order may not be a perfect match to either. **This is the beauty of artisanal tile!**

INSPECTING YOUR SHIPMENT

- **WHAT TO EXPECT** - Fornace Brioni + Cristina Celestino Terracotta tiles will show an earthy rustic character, a result of the craftsmanship and traditional production techniques used in their making. These techniques lend themselves to variation in surface texture, color, shade, and size, which should be foreseen. ALSO- Dust and shipping residue are to be expected and should be cleaned prior to installing.
- Efflorescence (salt deposits appearing as a white residue) is a normal occurrence in terracotta, and can be removed.
 - Store your terracotta tiles in a cool, dry place to prevent moisture build which can lead to efflorescence and other issues.
 - If efflorescence is present, have your installer do a quick sanding with an orbital sander and 120 grit sandpaper before sealing the tiles.
 - Additionally, Stonetech Restore Acidic Cleaner can also be used to remove efflorescence. See the “Sealing, Maintenance, and Care” section of this guide for more information.
- **BLEND BLEND BLEND** - due to the natural materials and production process of Fornace Brioni + Cristina Celestino Terracotta tiles, there will be degrees of variation in color, shade, and size in your order, therefore it is important to blend the tiles from all boxes once they arrive and place them in their installation area to ensure you have the layout you want before installing.

- **ORDER EXTRA!** - industry standard suggests adding at least 15% overage due to tile cuts, potential breakage, or future repairs.
 - **SHIPMENTS ARE SUBJECT TO WEATHER** – tiles may be exposed to moisture and/or condensation during production or shipping which may affect the color of the tiles once received. Setting the tiles out to dry prior to installation will return the color to normal. Do not install tiles until fully dried.
-

INSTALLATION FYIs

- **GENERAL GUIDELINES, NOT INSTRUCTIONS** - clé offers general information about our tiles and their unique qualities and usages. Proper installation will only be attained if you have selected a seasoned installer with years of experience with artisan tiles. Any installer without artisan tile experience will not know how to install clé tiles and will likely result in failed installations.
- **INSTALLATION DEEMS ACCEPTANCE OF YOUR ORDER** - if you are not 100% sure of your tiles- DO NOT INSTALL THEM. As is standard in the tile industry and with all construction materials, installation deems acceptance of materials. Do not install if there are visible issues. If you have any doubts or are unsure of what qualifies as a visible issue for the tile you are installing, please reach out to us PRIOR to installation. Our tiles are subject to variations in color, texture, size, and finish. Misuse by contractor or end-user including but not limited to negligence, physical and/or chemical abuse, as well as order shortages ARE NOT a clé responsibility and therefore, not covered by clé's warranty.
- **TILE IS A MATERIAL. INSTALLATION ERRORS ARE NOT THE FAULT OF THE MATERIAL** – clé tile is a material. Tile is merely the surface of your construction. Installation problems will arise from inexperienced artisan tile installers, substrate, or construction engineering and/or installation issues. Please refer to your project architect, structural engineer and/or installer for best results.
- **PLEASE CONFIRM YOUR INSTALLER'S LEVEL OF ARTISAN TILE EXPERIENCE** - your installation will only be as good as your installer. Please visit our blog for tips on [how to choose an installer](https://www.cletile.com/blogs/cle-notes/how-to-choose-contractor-installer) (<https://www.cletile.com/blogs/cle-notes/how-to-choose-contractor-installer>).
- **REQUIRE YOUR INSTALLER PERFORM A “DRY RUN” BEFORE BEGINNING YOUR INSTALLATION** – before installing, make sure to lay out and blend ALL BOXES of your tiles so that your variations in color, and tiles that bear chips and pits are artfully placed as you would like. clé selects our tiles for their hand-hewn variations and their inherent surface and color variations, which include pits, cracks, and chipping. The best placement of these nuances throughout your installation must be guided by you and/or your design professional to realize the best possible blend of your shipment of our limited-availability tiles. Your installation is only as good as your DRY RUN.
- **DO NOT USE TAPE, BLUE TAPE, OR OTHER TAPE** - do not use blue tape or other construction tape during product installation. We cannot guarantee that the tape will not erode or damage our products.

- **WAIT UNTIL YOUR PROJECT IS COMPLETE BEFORE INSTALLING YOUR TILES** – install the tiles as late as possible in the project to minimize the risk of damaging the tile.
 - **REQUIRE MOCK-UP BOARDS** – your next step to ensure your tiles will be organized properly and your grout joint size and color, as well as your sealant, are done to your design professional’s specifications- we urge you to require your installer create mock-up boards prior to your installation. This is a **STANDARD PRACTICE** for seasoned installers as it enables the end-user and their design professional to test all the tile layouts in mock-up form and, also will allow for the mock-up boards to be examined in the space and lighting in which the tiles will be used. Before beginning the mock-up boards- make sure to **FIRST** do your above-recommended **DRY RUN** and lay out and blend your tiles as described in that section.
 - **“FINAL FINISH” – WHAT IT IS AND WHY MAY YOUR PROJECT REQUIRES THIS?** - if you plan install your tile prior to the installation of cabinets, fixtures, etc., you’ll need be refinish the tile after those other features are installed in a step we call the “final finish.” In this step, your contractor should replace any broken or chipped tiles caused by construction damage, scuffing, or any deterioration of the tile surface. They should also hire a professional refinisher for the final refinishing of your tile installation. (*NOTE – Another benefit is that shipping refinishing can alleviate common shipping imperfections.). Make sure to account for this final step in your project timeline and budget.
 - **TCNA and ANSI** - please refer to the current edition of the TCNA Handbook for best installation results and ANSI A137:1 American National Standard Specifications for Ceramic Tile to reference specifications.
-

INSTALLATION AREAS

- Fornace Brioni + Cristina Celestino Terracotta tiles are intended only for interior and exterior walls. They are not freeze/thaw resistant. For outdoor installations in cold-weather areas, there must be flashing or roofing overhead and the tiles must be sealed with a water-repellent sealer.
- Fornace Brioni + Cristina Celestino Terracotta tiles are not suitable for use on showers, steam showers, pools, fountains, or their water lines.
- Fornace Brioni + Cristina Celestino Terracotta tiles are heat resistant, and suitable for fireplace surrounds.
- Fornace Brioni + Cristina Celestino Terracotta tiles can be used in a sink or stove backsplash installation, however they have high porosity and probability to stain. Additional sealing requirements must be taken into account in these installation areas. Please consult with your installer to see if a range splash is required for your installation.

GROUT

- For dry applications of Acanti, Mantegna, Trama and Giulio Romano tiles it is not necessary to grout, however it is necessary for exterior applications. If your installation requires grout, use a grout bag to fill the joints due to the shape and depth of the tile.

- For grout installations, clé recommends the following grout joint sizes:
 - Trama 1/8"
 - Mantegna 1/8"
 - Acanti 3/8"
 - Giulio Romano: 3/8"

- clé recommends using mortar and sanded cementitious grout that comply with the ANSI A118 or ISO 13007 classifications suitable for your project. Please consult with your installation professional to make these determinations.

- clé recommends using non-pigmented cementitious sanded grout to reduce the risk of grout haze and staining.

- Fornace Brioni + Cristina Celestino Terracotta tiles are extremely porous and must be sealed before grouting and as the final step of installation in order maintain their appearance and avoid staining.

- Grout color selection is always up to our client and/or their design professional. However, clé is often asked for our opinion on best grout selections for our tiles. And due to the large array of grout colors that are now available, clé would like to offer this general guideline on a foolproof grout color selection for any of your clé tiles.
 - First, have your professional tile contractor complete your tile installation, except for the grout portion.
 - Next, when ready to grout, ask your contractor to bring ALL grout color charts from his preferred grout manufacturers, for your review.
 - Lastly, choose a time of day when you are most pleased with the lighting in your space (either natural lighting, installed lighting or a blend of both). During that lighting and time of day, select the grout color that best matches your tile selection.

- If you are working with highly color-variegated tiles or a combination of tiles, we recommend that you follow the above recommendations—but match your grout to the color in your installation that you would like to accentuate.

- If you are working with highly color-variegated tiles or a combination of tiles, we recommend that you follow the above recommendations—but match your grout to the color in your installation that you would like to accentuate.

- If your contractor is having any issues or questions regarding grout, please reach out to the grout manufacturer directly. They are the best and fastest line of contact.

SEALING, MAINTENANCE, AND CARE

- Please follow Laticrete’s [Sealing, Maintenance, and Care guide](#) for more guidance on sealing, cleaning, maintaining, and caring for your tile installation.
- **If you have any questions regarding Laticrete products or how to use them, please contact Laticrete directly by phone: 1-800-243-4788 X 1235.**

ADDITIONAL SPECIFICATIONS

COLOR, TEXTURE AND SIZE VARIATION

Due to the handmade craftsmanship of many of our tiles and the variety of materials used, there are degrees of variation in our tiles color, shade and texture. These differences are more pronounced in certain types of tiles than others, especially in tiles from separate production lots, or “batches”. This makes it unlikely that your sample will be a perfect match with your actual order or that your add-on order will be a perfect match to your first order.

The following is a guide for the different degrees of variation that we have assigned our tiles:

Fornace Brioni Terracotta wall tiles are rated 'level 2 slight' for color variation, and 'level 3 medium' for texture variation. For size variation, Trama and Mantegna are rated 'level 2 medium', Acanti and Giulio Romano are rated 'level 3 heavy'.

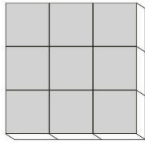
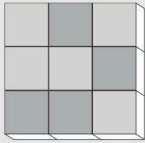
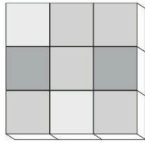
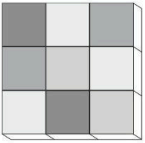
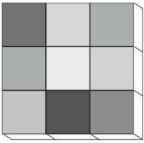
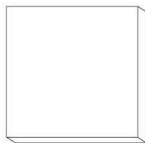
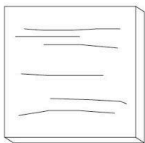
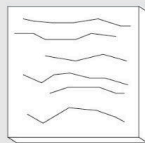
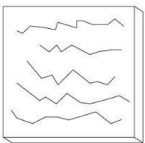
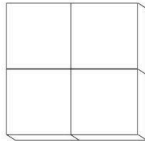
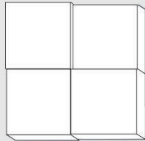
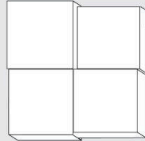
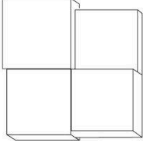
CATEGORY	LEVEL 1	LEVEL 2	LEVEL 3	LEVEL 4	LEVEL 5
COLOR VARIATION	 low	 slight	 medium	 heavy	 extreme
TEXTURE VARIATION	 smooth	 slight	 medium	 heavy	n/a
SIZE VARIATION	 slight	 medium (for Trama and Mantegna)	 heavy (for Acanti and Giulio Romano)	 extreme	n/a

PRODUCT DESCRIPTION

Non-vitreous terracotta tiles, which are hand formed, and fired.

PRODUCT COMPONENTS

Clay.

DIMENSIONS

Trama Mosaic	3.2 cm x 5.1 cm x 3.8 cm per tile (1 1/4" x 2" x 3/4" per tile) / .01 kg per tile (.03 lb)
Mantegna Triangle	15.2 cm x 17.1 cm x 2.5 cm (6" x 6 3/4" x 1") / .45 kg per tile (1 lb)
Acanti	19.7 cm x 19.7 cm x 1.9 cm (7 3/4" x 7 3/4" x 3/4") / 1.18 kg per tile (2.6 lbs)
Giulio Romano – End cap	20.3 cm x 25.4 cm x 2.5 cm (8" x 10" x 1") / 1.36 kg (3 lbs)
Giulio Romano – Column	20.3 cm x 49.5 cm x 2.5 cm (8" x 19 1/2" x 1") / 9.95 kg per tile (6.5 lbs)

* Please note all dimensions are nominal. Additionally, dimensions can vary +/- 1/4" for Acanti and Giulio Romano, and +/- 1/8" for Trama and Mantegna.

AVERAGE COEFFICIENT OF FRICTION (DCOF ACUTEST)

DCOF testing is not performed as these are strictly wall tiles.

FREEZE/THAW RESISTANCE (ASTM C1026)

Fornace Brioni terracotta tiles are not freeze/thaw resistant.

WATER ABSORPTION (ASTM C373)

avg. 26.4%; non-vitreous.

ACID RESISTANCE

Fornace Brioni tiles are not resistant to acids and should be cleaned with pH neutral cleaners.

LEED CREDITS

The product is an inherently non-emitting source of VOCs (stone, ceramic, metals, powder-coated metals, plated or anodized metal, glass, cement, clay brick, and unfinished or untreated solid wood) and has no integral organic-based surface coatings, binders, or sealants.

Fornace Brioni tiles are considered 'inherently non-emitting sources' under the Low-emitting Materials Credit of LEEDv4/v4.1. **This is currently the only credit for our Fornace Brioni tile that is eligible to be used toward LEED.**

'Inherently non-emitting' means that these tile types have been shown to not contribute emissions to indoor environments and are therefore exempt from demonstrating compliance with CDPH v1.1-2010 or CDPH v1.2-2017.

Use of these tiles as Wall or Flooring materials should be entered in the LEED v4.1 low-emitting materials Calculator and identified as 'inherently non-emitting' in the Products Tab (Column L).

Disclosures for MR Credit Material Ingredient Disclosures under LEEDv4/v4.1, are not available at this time. We are exploring our disclosure options and have not established a timeline for completion.

Disclosures for MR Credit Environmental Product Declarations under LEEDv4/4.1, are not available at this time. We are exploring our disclosure options and have not established a timeline for completion.

Contribution to MR Credit Material Sourcing under LEEDv4/v4.1, does not apply as there is no recycled content, no bio-based materials, no wood, no reused products included in our tile at this time. Extended producer responsibility programs are highly difficult to manage given the nature of end-of-use tile removal methods. *Tile can last hundreds of years but fashions often change, which is the dominant reason for its removal. We work hard to ensure our terracotta tiles can withstand the test of time while remaining timeless.*

RECYCLED CONTENT

There is no recycled content in our Fornace Brioni tiles at this time. See material sourcing disclosure above.

PERCENTAGE OF PRE-CONSUMER AND/OR POST-CONSUMER MATERIALS

There is no pre-consumer or post-consumer material content in our Fornace Brioni tiles at this time. See material sourcing disclosure above.

FIRE RATING

Typically, ceramic tile does not need to have fire rating testing performed. It is our understanding from TCNA that the explanation that ceramic is inorganic, inert, and typically free of materials that could burn or produce smoke is generally enough to satisfy a specifier and that testing is not necessary. Also, the temperatures observed in the testing are typically lower than the temperatures at which ceramic tiles are fired.

Terracotta is a ceramic tile and falls under the description, “because ceramic tile is non-flammable and does not produce smoke in a fire, it inherently meets the flame spread and smoke development requirements of Section 803 of the International Building Code (IBC) for interior wall and ceiling materials.”