

kraenzle®

EN Operating manual

High-pressure cleaner

quadro 800 TST

quadro 1000 TS

quadro 1000 TST

quadro 1200 TS

quadro 1200 TST

quadro 1500 TS

quadro 1500 TST

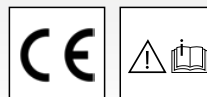

www.kraenzle.com

Operating manual

EN

High-pressure cleaner

quadro 800 TST

quadro 1000 TS

quadro 1000 TST

quadro 1200 TS

quadro 1200 TST

quadro 1500 TS

quadro 1500 TST

Operating manual!

This manual is a translation of the original manual. Read and conform safety instructions before use! Keep instructions in a safe place for later use and pass them on to any future user.

Dear customer:

We would like to congratulate you on the purchase of your new high pressure cleaner and thank you for your confidence in our products!

Your choice has fallen on an absolute quality product! Kränzle high pressure cleaners are characterized by their convenient and compact design as well as their high suitability for everyday use.

Highest precision and dimensional accuracy in addition to a technology package consisting of a multitude of details mark the difference when it comes to performance, safety and durability.

In order to facilitate handling of the high pressure cleaner, the following pages are intended to further explain its use. The illustrations may be subject to deviation depending on the type of equipment or accessory of high pressure cleaner purchased by you.

Contents	4
Explanatory symbols	5
Safety notes	6
Description of high pressure cleaner	10
General rules	14
Functional details	16
Putting into operation	21
Direct suction	25
Applying additives	26
Taking out of operation	27
Small repairs - do it yourself	28
Kränzle accessories	32
EC declaration of conformity	34
Warranty	35
Inspection reports	36

Explanatory symbols used in the operating manual



Failure to observe this note may entail environmental damage.



Note on the use of the high pressure cleaner that failure to adhere to the instructions may cause excessive wear or total breakdown of the large quadro series.



Warning!
Failure to observe this note may result in serious injuries!

Explanatory symbols affixed to the high pressure cleaner



In case of improper use, the high pressure jets can be very dangerous. Do not direct high pressure jet at persons, animals or active electrical equipment or the high pressure cleaner itself.



The high pressure cleaner may not be connected directly to the public drinking water supply network.

User operating the high pressure cleaner should wear the necessary protective clothing, i.e. waterproof clothing, rubber boots, safety goggles, headwear etc. It is prohibited to use the high pressure cleaner in close vicinity to people lacking suitable protective clothing.

Do not spray against matter containing asbestos or other hazardous substances!

Never spray liquids containing solvents like varnish solvents, petrol, oil or similar liquids! There is an explosion hazard due to spraying such materials!

Due to the high pressure jet, damage may occur on the objects to be cleaned, e.g. car tires; therefore, a minimum distance of 30 cm is to be kept!

Prior to putting the high pressure cleaners into operation, check its components (High pressure hose, power supply cables, safety trigger gun) for any damage. Replace defect or damaged components!

Replacement of the power supply cables is only permitted by use of an original power supply cable of the manufacturer and must be performed by a qualified electrician.

The high pressure cleaner is to be properly used. The user is required to adhere to local requirements and to watch out for the persons in the danger zone!

The high pressure cleaner is not intended for use by persons with reduced physical, sensory or mental capabilities, unless such persons are supervised and capable of perceiving the risks involved in the use of high pressure cleaners!

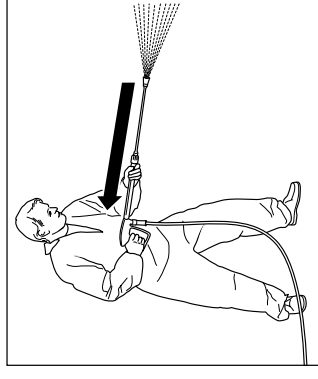

When using high pressure water for cleaning, make sure that there is a clearly noticeable recoil effect on the lance. Therefore ensure a firm footing (see technical data).

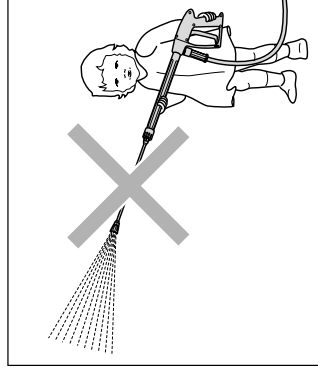

Never allow children or untrained persons to use the high pressure cleaner or to play with it!

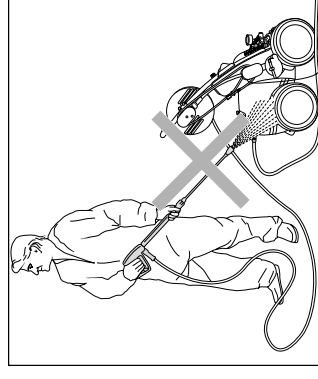

Never direct the high pressure jet at the high pressure cleaner itself!

The high pressure cleaner may not be placed within reach of the high pressure jet spray mist!

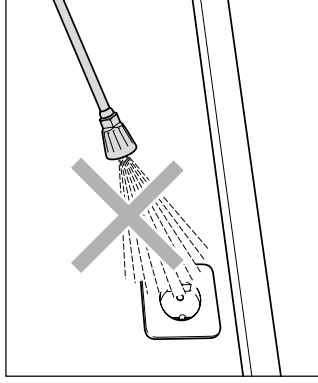

Never direct the high pressure jet at power sockets or any other electrical installations!
Within the working area, all live parts are to be protected from both water jet and spray mist.

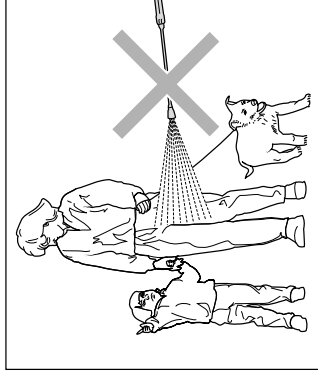

Never direct the high pressure jet at people or animals!
Never direct the high pressure jet at yourself or other persons, not even to clean clothing or shoes.

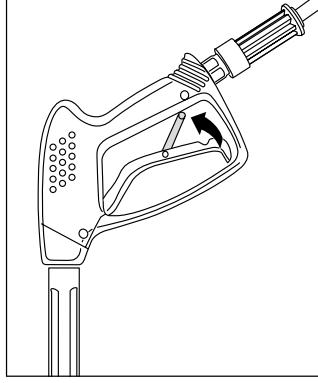

Apply the safety catch on the safety trigger gun after each use in order to prevent unintentional spraying!

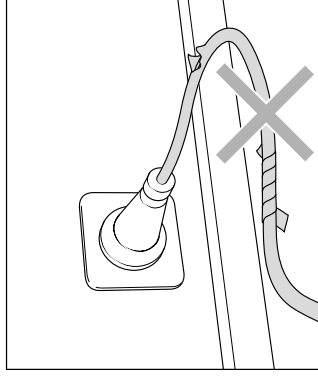

Only use a power supply cable in perfect working order!
Do not damage or improperly repair the power cable (tearing, squeezing, running over, ...).

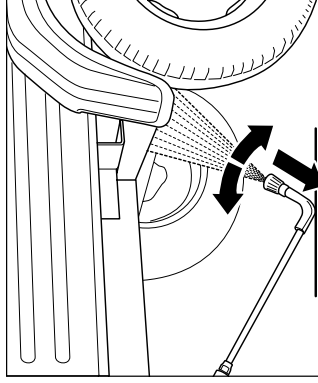

Always pay attention to the underbody lance resting on the surface!
Bear in mind when using a curved or angled spraying lance that there is a significant amount of torque in the recoil!
(the underbody lance is available as optional accessory).

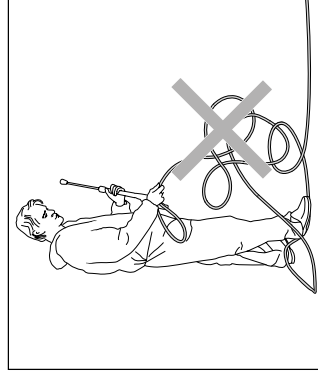

Never pull the high pressure hose if it has formed kinks or "nooses"!
Never pull the high pressure hose over sharp edges!

Design: large quadro series without hose drum

The quadro 1000 TS, quadro 1200 TS, quadro 1500 TS cleaner is a mobile high pressure cleaner with an advanced arrangement system. Please see construction scheme for more details.

1. Ergonomically shaped handle (detachable)
2. Pump head made of special brass
3. Cleaning agent injection hose
4. Detergent valve
5. Start/Stop switch
6. Holder for lance
7. Holders for safety trigger gun with lance
8. Safety trigger gun
9. Large stainless steel pressure gauge
10. On/Off switch with motor protection and control light
11. Integrated trolley takes steps and rough ground in its stride
12. Cable reel for the power supply cable
13. Infinitely variable pressure and quantity regulation
14. Cover for water tank

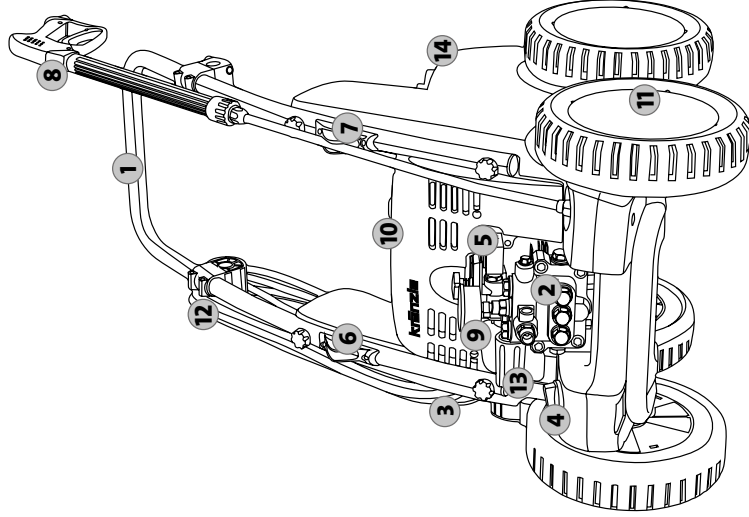

This is what you have purchased: large quadro series without hose drum

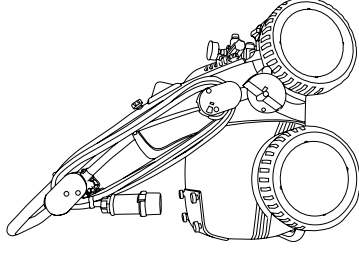

1. Kränzle high pressure cleaner quadro 1000 TS
quadro 1200 TS
quadro 1500 TS
2. Safety trigger gun with screwing
3. Turbokiller lance with stainless steel pipe (optional)
4. Stainless steel lance with flat jet nozzle
5. Operating manual
Spare parts list
6. High pressure hose

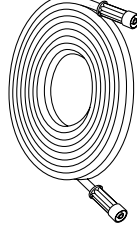
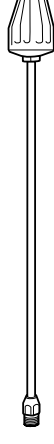
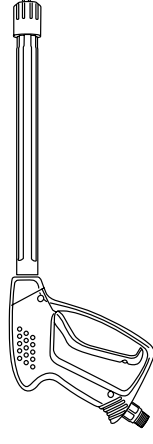

Design: large quadro series with hose drum

The quadro 800 TST, quadro 1000 TST, quadro 1200 TST, quadro 1500 TST cleaner is a mobile high pressure cleaner with an advanced arrangement system. Please see construction scheme for more details.

1. Ergonomically shaped handle (detachable)
2. Pump head made of special brass
3. Hose drum with 20 m steel weave high pressure hose
4. Cleaning agent injection hose
5. Detergent valve
6. Start/Stop switch
7. Holder for lance
8. Holders for safety trigger gun with lance
9. Safety trigger gun
10. Large stainless steel pressure gauge
11. On/Off switch with motor protection and control light
12. Integrated trolley takes steps and rough ground in its stride
13. Cable reel for the power supply cable
14. Infinitely variable pressure and quantity regulation
15. Cover for water tank

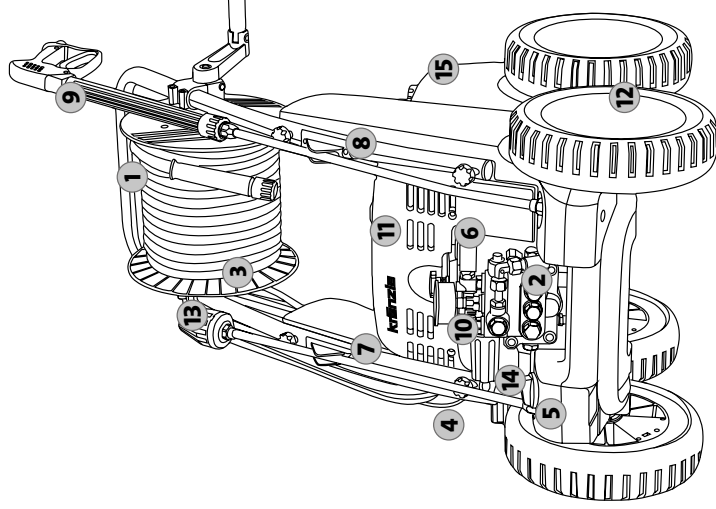
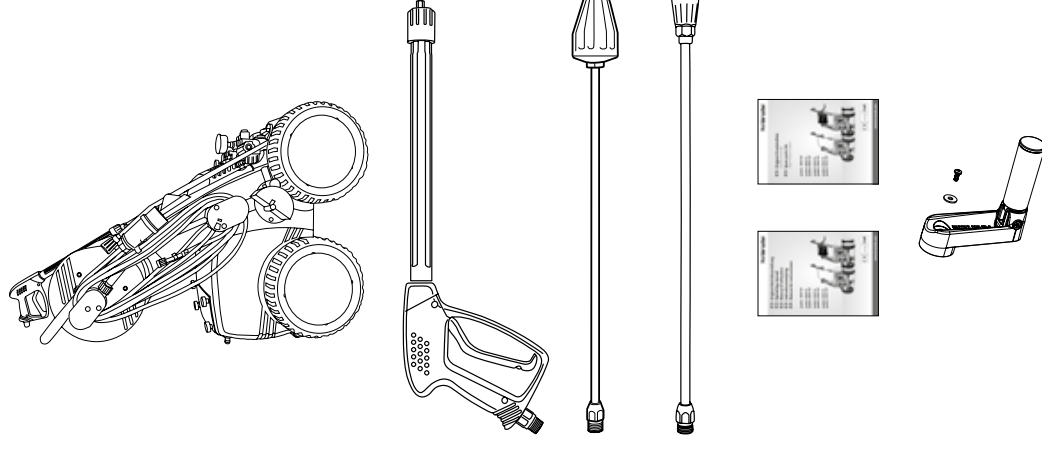
**This is what you have purchased: large quadro series with hose drum**

1. Kranzle high pressure cleaner
quadro 800 TST
quadro 1000 TST
quadro 1200 TST
quadro 1500 TST
2. Safety trigger gun with screwing
3. Turbokiller lance with stainless steel pipe
4. Stainless steel lance with flat jet nozzle
5. Operating manual
Spare parts list
6. Crank handle with fastening screw

Intended use

This high pressure cleaner is to be used solely for high pressure water jet cleaning applications without detergents or low-pressure cleaning work with detergents (e.g. with a foam injector or washing brush).

**Environmental, refuse disposal and water protection regulations must be observed!****Inspections**

The high pressure cleaner must be inspected according to the “Guidelines for Liquid Spray Devices” at least once every 12 months by a qualified person, to ensure that continued safe operation is guaranteed. The results of the inspection are to be recorded in writing (see Inspection reports).

**High pressure cleaners used for commercial purposes have to be checked by a qualified person at least every 12 months!****Accident prevention**

The high pressure cleaner is designed for accidents to be impossible if used correctly. The user is to be notified of the risk of injury from hot machine parts and the high pressure jet. The “Guidelines for Liquid Spray Devices” must be complied with.

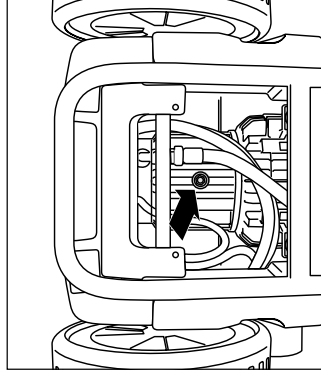
Oil change

The first oil change should be carried out after approximately **50 operating hours**, then every year or after 250 operating hours. If the oil turns grey or white, you must change the oil. In case of exchanging oil being required, the oil drain screw must be opened above a container and the high pressure cleaner be emptied. The oil is to be caught in the reservoir and disposed of in an approved manner.

New oil: 1.0 l

Kranzle Gear Oil (Item no.: 400932) or 10/W60 SAE Semisynthetic oil.

**Oil leakage**

If oil leaks contact your nearest after-sales service (dealer) at once. (environmental damage, damage to the transmission).

In case of increased humidity or fluctuations in temperature development of condensed water is possible. If the oil turns grey or white, you must change it.

Please note: Lack of water

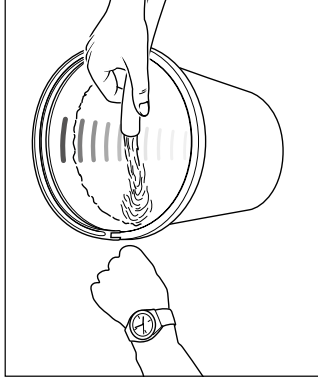

Lack of water occurs more often than you probably believe. The more powerful a high pressure cleaner is the greater is the danger that a lack of water occurs. If there is only an insufficient amount of water available, cavitation (water-gas mixture) arises inside the high pressure pump, which is normally noticed too late or even not at all. **The high pressure pump will be destroyed.** Please check the available quantity of water by filling a bucket with liter scale for one minute.

Required minimum quantity of water (see technical data).

If the metered quantity of water is too small, you have to use a different water connection, guaranteeing the necessary output.

Lack of water leads to an accelerated wear of the joints (guarantee void).

Never let the high pressure pump run dry for more than 60 seconds.



Water supply

Please pay attention to the regulations of your waterworks company! In accordance with DIN EN 61770, the high pressure cleaner may not be directly connected to the public drinking water supply lines. A brief connection however is permissible according to DVGW (German Association for Gas and Water Affairs) if a non-return valve with tube ventilator (Kranzle item no.: 410164) is built into the water supply. **Once the water has passed through the non-return valve it is no longer considered as drinking water.** Also indirect connection to the public drinking water supply lines is permissible by way of free emission in accordance with EN 61 770; e.g. by using a reservoir with a float valve. Direct connection to a non-drinking water supply line is permissible.



Insufficient quantity of electricity

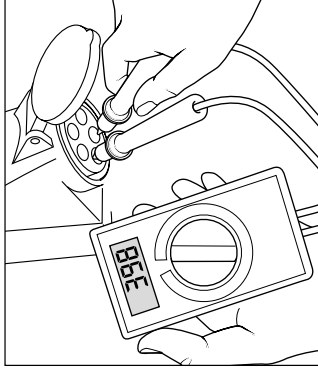

If there are too many collectors in your proximity connected to the network at the same time, the available voltage and the current intensity may decline. Consequently the motor of the high pressure cleaner does not start or even blows. The power supply may also be insufficient if the power supply cable is too long or too thin. If extension cables are too long, this may lead to a voltage drop causing malfunctions or start-up difficulties.



Check the line fusing and have the voltage and the available current intensity checked by an expert in case of uncertainty (see technical data).

Electrical connection

The high pressure cleaner is supplied with a 5 meters long power supply cable. The mains plug must be fitted to a standard grounded socket with a **30 mA** residual current operated device. The socket must be protected with a **16 A fuse lead** which is properly connected to the socket. The conductors in the extension cable must have a minimum cross section of **1.5 mm²**. Plug connections must be of a spray-proof design, and may not be located on a wet floor. For extension cables of more than **10 m** in length, the minimum cross-section must be **2.5 mm²**. When using a cable drum, the power supply cable always must be unwound all the way.

Water and cleaning system

Water can be connected at mains pressure to the high pressure pump. A float valve in the water tank regulates the water inlet. Then, the water is sucked by the high pressure pump from the water tank and supplied to the lance under pressure. The high pressure jet is formed by the nozzle at the end of the lance. Bypassing the water tank water can also be sucked directly out of a pressure-less container (see direct suction).



Environmental, refuse disposal and water protection regulations must be observed!

Safety jet pipe with safety trigger gun

The high pressure cleaner can only be operated when the trigger of the safety deactivation trigger gun's trigger is actuated. When the trigger is pulled, the safety trigger gun opens. The liquid is then transported to the nozzle. The spray pressure increases and quickly reaches the operating pressure. When the trigger is released, the safety trigger gun closes and any further spraying of liquid from the safety jet pipe is prevented. The stainless steel pressure gauge must show 0 bar. The increase in pressure when the safety trigger gun is closed causes the pressure control valve/safety valve to open. The motor is switched off by the pressure switch. When the safety trigger gun is opened, the pressure control valve/safety valve closes, the motor is started and the high pressure pump resumes pressure spraying from the safety jet pipe with the selected operating pressure.

The safety trigger gun is a safety device. Repairs should only be performed by qualified persons. Should replacement parts be required, use only components authorized by the manufacturer.



Pressure control valve/safety valve

The pressure control valve/safety valve protects the high pressure cleaner from a build up of excess pressure, and is designed not to permit an excess pressure to be selected for operation. The limit nut on the handle is sealed with a spray coating. The operating pressure and spray rate can be steplessly adjusted by turning the handle.



Replacements, repairs, new adjustments and sealing should only be performed by qualified persons.

Motor protection switch

Motor is protected against overload by means of a motor protection switch. In case of motor overload or blocking, the motor of the high pressure cleaner switches off automatically. If motor tends to switch off repeatedly, make sure to detect appears. Make sure to detect and remedy the cause of the failure.



Replacements and inspection work should only be performed by qualified persons **when the high pressure cleaner is disconnected from the power supply**, i.e. with plug pulled out from the electrical socket.

Total stop system with delayed motor cut-off

After startup and switching on the high pressure cleaner a green light is displayed. When opening the safety trigger gun the motor is started via a total-stop system. **When closing the safety trigger gun the motor is switched off only after 30 seconds.** The delayed switch-off is necessary because switching on and off motors frequently on high pressure cleaners of this size may involve heavy load on the power network and cause increased wear of internal electrical parts.

Safety shutdown

If the high pressure cleaner is accidentally not turned off after use or the safety trigger gun is not used for 20 minutes, the high pressure cleaner automatically changes into safety state by deactivation. By operating the main switch once more, the high pressure cleaner is activated again.

High pressure hose and spray device

The high pressure hose and spray device which are part of large quadro series equipment, are made of high quality material and engineered to conform with the operating conditions of the high pressure cleaner and are duly labeled.

If replacement parts are required, only such parts that are authorized by the manufacturer may be used. The warranty is automatically void if spare parts of third-party providers are used! The high pressure hose and spray device must be connected in a pressure-tight manner (without leakage).

The high pressure hose may not be driven over, pulled excessively, or twisted. The high pressure hose may under no circumstances be pulled over sharp edges. Defective high pressure hoses must not be repaired (acc. to DIN 20022) but have to be replaced by new hoses approved by the manufacturer.

Prior to putting the high pressure cleaner into operation make sure that all safety instructions be observed.

1.

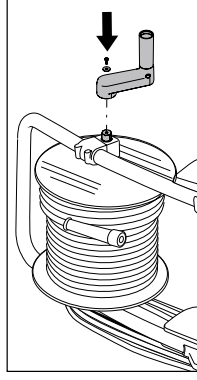

For high pressure cleaners with hose drum the enclosed hand crank must be applied prior to first operation. Plug the hand crank onto the hexagon and attach it with the enclosed screw and washer.

2.



For moving the high pressure cleaner to the place of use, please release locking break.

3.

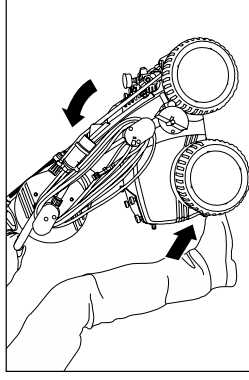

The large quadro series is a movable high pressure cleaner with sturdy trolleys ideally suited for difficult terrain.

For steering the high pressure cleaner put the foot against the tipping support and then pull the device towards you.

4.

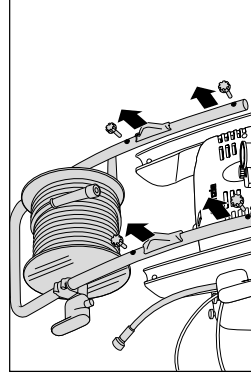

For transport purposes the handle can be taken off easily. First detach the high pressure hose from the hose drum. After that, unscrew the fixing screws and detach handle and hose drum



Neither set up or operate the large quadro series in rooms where there is a risk of fire or explosion nor put it into puddles. Do not use the high pressure cleaner under water. If, none the less, the high pressure cleaner is operated in a hazardous area, the applicable safety regulations are to be observed.

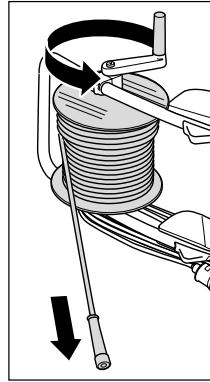

5. For high pressure cleaners with hose drum, please loosen the fixation and then completely unwind the high-pressure hose. For high pressure cleaners without hose drum the high pressure hose included in the scope of the delivery must be screwed with the pump outlet in a tight and pressure tight manner. Unwind high pressure hose straight and without nooses. The high pressure hose may leave signs of abrasion on some floors. Alternatively, please also find non-marking high pressure hoses in our range.

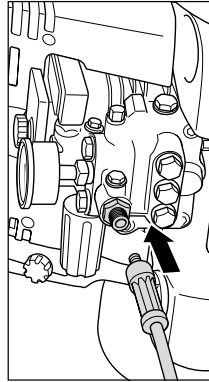

6. Tightly screw together high pressure hose and safety trigger gun.

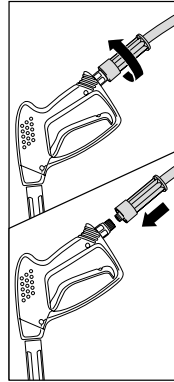

7. Lance on to safety trigger gun.

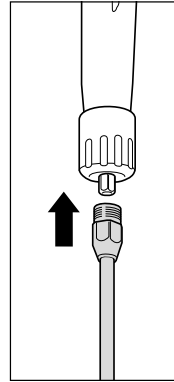

8. Screw together lance and safety trigger gun pressure tightly.

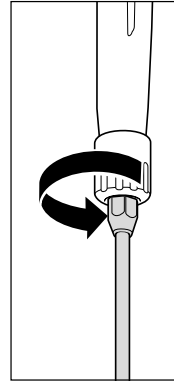

! When using high pressure hose extensions take care that the max. length of 20 m is not exceeded!

! Accessories may only be connected to a Kränzle-approved trigger gun with safety catch.

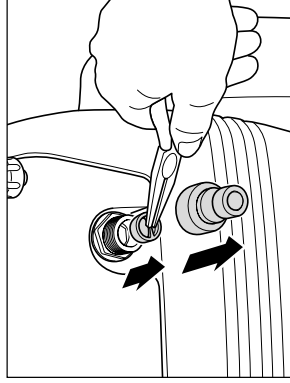

9. **Check water inlet filter for cleanliness prior to putting the high pressure cleaner into operation.**

Manually unscrew plug-in coupling. Take out the water inlet filter using needle nose pliers and thoroughly rinse it with clear water and clean it with the other parts. If the sieve is dirty, water cannot get through and pressure will not build up.



Check the water inlet sieve for damage. Do not operate the high pressure cleaner without or with a damaged filter.

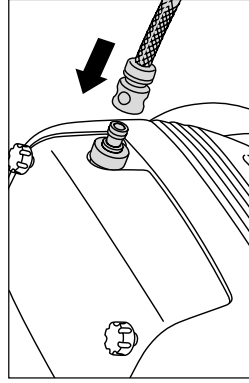

10. Connect the water hose to water inlet sieve. The high pressure cleaner may be connected to a water mains (1-10 bar pre-pressure) with either cold or hot water (up to 60 °C). The large quadro series provides the opportunity of sucking in water out of a container (see direct suction).



Be careful when using hot water!

When running your high pressure cleaner with hot water of 60 °C raised temperatures occur. Do not touch the metal parts of the high pressure cleaner without safety gloves!

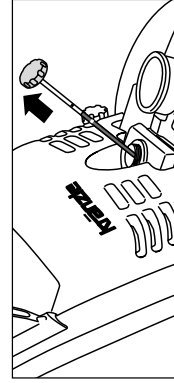

11. **Each time check oil level at the oil dipstick prior to putting the high pressure cleaner into operation.**

Oil level must reach until the upper edge of marking "OK".

12. Connect to circuit (see technical data).

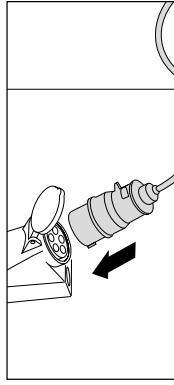

Do not touch the mains plug or any live parts with wet or moist hands.



13. Switch on high pressure cleaner with opened safety trigger gun. Bleeding of the high pressure cleaner: Pull and release trigger of safety trigger gun several times. Start cleaning task.

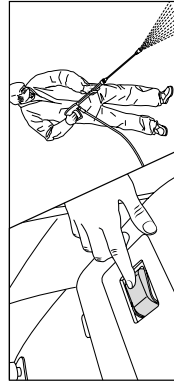

14. When using the turbokiller lance make sure that lance points downward when starting.

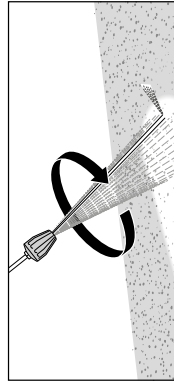

15. Adjust operating pressure infinitely using the rotary handle. The maximum pressure is factory-set.

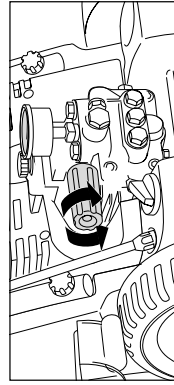

It is imperative that safety instructions be observed during use of the high pressure cleaner.



Direct water extraction

Due to the suction capacity of its high pressure pump (up to 2.5 m suction height, max. hose length 3 m) this high pressure cleaner can suck in water for cleaning purposes from separate containers or ponds. In this case the water tank must be bypassed.

1. Unsrew connecting hose between high pressure pump and water tank.

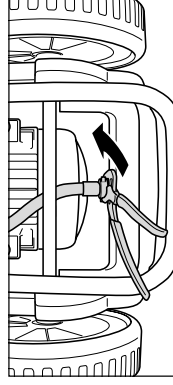

2. Screw suction hose with suction filter (Item.-no.: 150383) with connecting hose using a spreaded steel pipe fitting (Item.-no.: 46004).

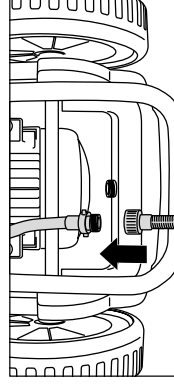

3. Put filled suction hose into the water-filled container and start the cleaning job. **Use clean water only! Never suck in water containing chlorine! Do not suction air!**

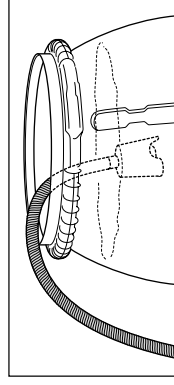

Prior to starting the first suction the high pressure pump and the suction hose has to be filled with water!

Note

Depending on the water quality it may occur after a prolonged standstill that the valves get sticky. Consequently the high pressure cleaner cannot properly suck in water from a container. In this case connect a hose with pressurized water to the pump inlet. Having started the high pressure cleaner the pressurized water opens the valves and the machine resumes sucking in water from the container. Now you can carry on with your cleaning task as usual.



Suction of additives

Due to the water tank fitted to the large quadro series it is now possible to directly suck the detergent into the high pressure pump thus reducing output loss and increasing the efficiency considerably.

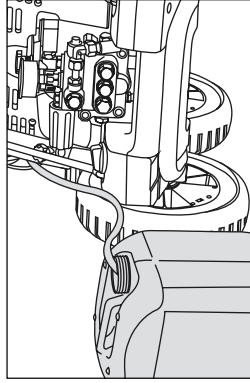

1. Place chemical filter into container with additives

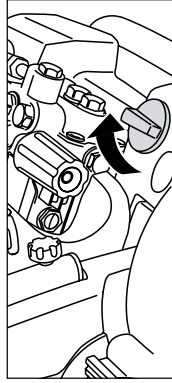

2. Dosing of detergent is done by turning the detergent valve.
By closing the detergent valve the supply of detergent is stopped.

1. Switch off the high pressure cleaner
2. Cut off the water supply
3. Open the safety trigger gun catch briefly until the pressure is released
4. Apply safety catch on the trigger gun
5. Remove high pressure hose and safety trigger gun
6. Emptying high pressure pump: Hold high pressure hose and switch motor on until water jet stops escaping at the outlet.
7. Pull the plug from the socket
8. Clean high pressure hose and wind up without loops, fix hose drum
9. Clean and wind up the power supply cable
10. Clean the water inlet sieve
11. Apply locking brake
12. Store high pressure cleaners in frost-free rooms in winter



Only open the dosing valve, if the detergent sieve is placed in a liquid! Sucked air leads to destruction of the pump seals of the high pressure cleaner (No warranty)!



The pH value neutral 7-9 is prescribed for the additive. Only use additive suitable for high pressure cleaners. Observe specifications of detergent manufacturer! E.g.: protective equipment, rules for waste water treatment etc.



Attention solvents!

Never suck in liquids containing solvents like varnish solvents, petrol, oil or similar liquids! Seals inside the high pressure cleaner are no resistant against solvents! The spray mist of solvents is highly inflammable, explosive and poisonous.



Frost protection

For protecting the high pressure cleaner against frost please empty it completely. Separate high pressure cleaner from water supply and switch it on. By opening the safety trigger gun the high pressure pump presses water out of the water tank. **However, do not allow the high pressure cleaner to operate without water for more than one minute.** Fill the anti-freeze agent into the water box and turn on the high-pressure cleaner. Wait with opened gun until the agent spurts out of the nozzle.

Problem

No water from nozzle although the high pressure cleaner is running.
The stainless steel pressure gauge shows full pressure.

Cause

Most likely the nozzle is blocked.

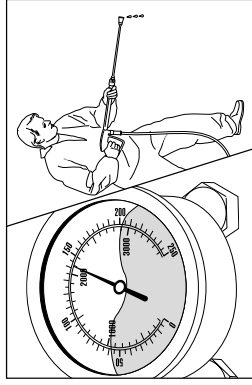

The stainless steel pressure gauge shows full pressure, but from the nozzle comes only little water or no water at all.

(Inside the stainless steel pressure gauge is no water but a filling with glycerin to damp the vibration of the pointer.)

Proceeding:

Switch off the high pressure cleaner. Pull plug from the socket. Operate safety trigger gun catch several times to decrease the pressure.

Unscrew safety trigger gun and lance first, then rinse high pressure hose to remove possible soiling.

Check water inlet filter for soiling.

If the problem still exists, take wire (paper clip) and push through nozzle opening. If this procedure is not successful, the nozzle has to be replaced.

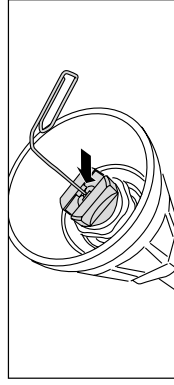

Pull plug from socket prior to starting any repair work!

Problem

Irregular jet from nozzle.
The stainless steel pressure gauge shows low pressure.

Cause

Most likely the valves are soiled or sticky.

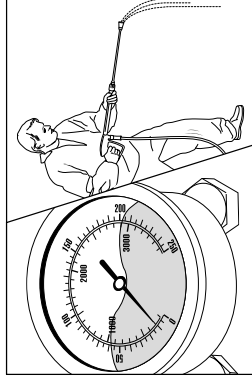

The stainless steel pressure gauge shows low pressure despite fully turned up pressure regulation. The water from the lance comes in squirts. The high pressure hose vibrates.

(Inside the stainless steel pressure gauge is no water but a filling with glycerin to damp the vibration of the pointer.)

Proceeding:

Unscrew all 6 valves, one after the other (hexagonal brass screws, 3 in a row, vertically and horizontally)

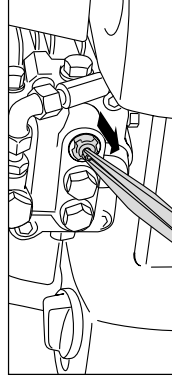
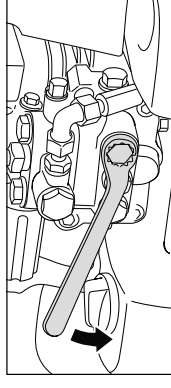

Take out valve body and O-ring by means of needle nose pliers. Check O-ring for damage. In case of a damage the O-ring has to be replaced.

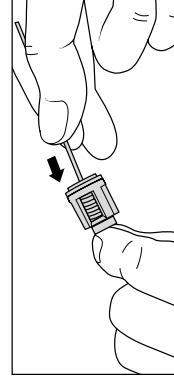

Take a wire (paper clip) and clean valves under running water.

Do not forget the O-ring during reassembly!

Problem

After closing the safety trigger gun the high pressure cleaner keeps switching on and off.

The stainless steel pressure gauge continuously displays full pressure.

Possible cause No. 1

Leakage.

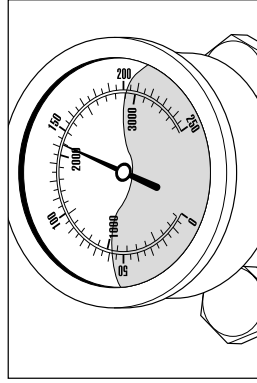

Having closed the trigger gun with safety catch, the high pressure cleaner must shut down and the stainless steel pressure gauge must show „0“ bar. If not shut down and the stainless steel pressure gauge continuously shows full pressure, this could be due to leakage at the high pressure pump, at the pressure switch, at the high pressure hose or at the trigger gun with safety catch.

Proceeding:

Check connections from the high pressure cleaner to the high pressure hose and from the high pressure hose to the safety trigger gun and also the connection between lance and safety trigger gun for tightness.

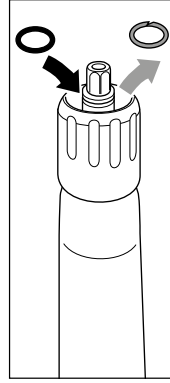

Switch off the high pressure cleaner. Shortly press the trigger of the safety trigger gun to decrease the high pressure cleaner. Unscrew high pressure hose, safety trigger gun and lance and check the O-rings. If the O-rings are damaged they have to be replaced.



In case of a leakage there is no guarantee for possible consequential damages.

Problem

After closing the safety trigger gun the high pressure cleaner keeps switching on and off.

The stainless steel pressure gauge continuously displays full pressure.

Possible cause No. 2

The non-return valve is defective.

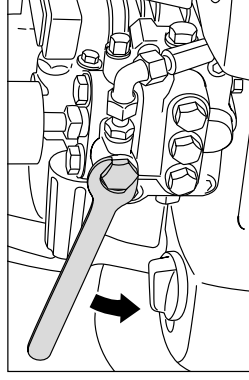
**Proceeding:**

Switch off the high pressure cleaner and pull plug from socket. Stop water supply. Operate safety trigger gun catch several times to decrease the pressure. Unscrew pump outlet.

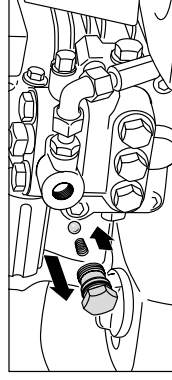

Remove check body and check O-Ring for soiling or damage. Also check seal seat inside pump housing for soiling or damage.

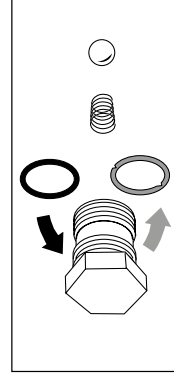

If sealing rings are defective replace O-rings at once.



There is no guarantee if the high pressure pump is damaged by defective O-rings due to air induction or lack of water (cavitation).

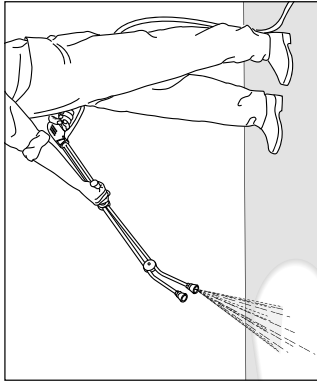

Double lance

- With insulated ISO handle
- Low pressure nozzle D3035 as standard

660 mm Item no.: 121311
1000 mm Item no.: 12131

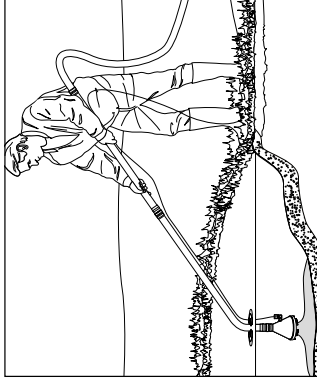

Sludge suction cleaner

- From stainless steel
- Max. suction height 3 m
- Nozzle system D00045

Item no.: 41801

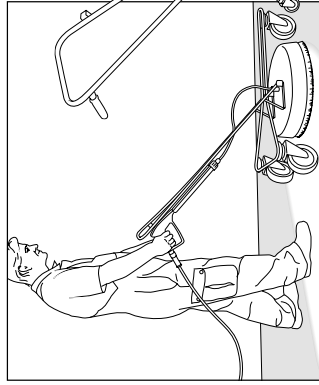

Floor washer Round Cleaner (stainless steel)

- From stainless steel
- Various executions
- Nozzle system 055

Ø 300 mm Item no.: 41105
Ø 420 mm Item no.: 41106
Ø 520 mm Item no.: 41107

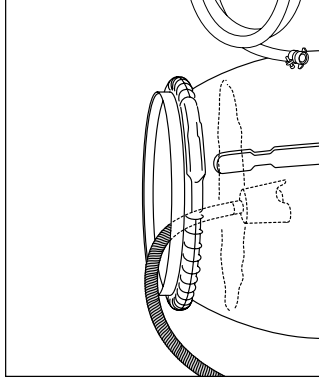

Suction hose with suction filter

- With return valve
- Hose length 3 m

Item no.: 150383

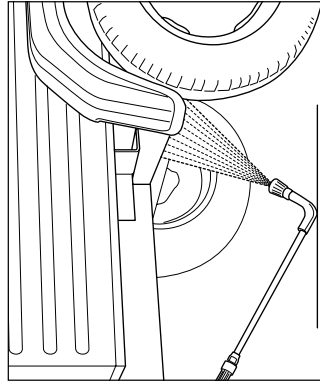

Underbody lance

- Stainless steel pipe
- 1000 mm extension
- Nozzle system 4007

Item no.: 41075

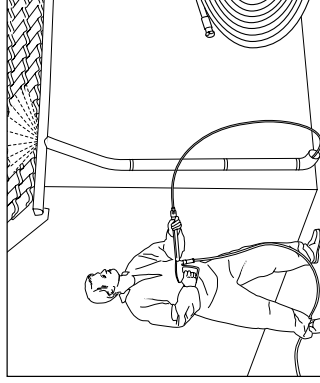

Suction hose with suction filter

- With return valve
- Hose length 3 m

10 m Item no.: 410581
15 m Item no.: 41058
20 m Item no.: 410582
25 m Item no.: 410583
30 m Item no.: 410584



The high pressure cleaner accessories are safety components!
Any warranty will be void if parts not authorised by Kränzle are used.



Please indicate the technical data of the high pressure cleaner (device type) when placing your order.

We hereby declare that the design of the high pressure cleaners:

- Kränzle quadro 800 TST**
 - Kränzle quadro 1000 TS / TST**
 - Kränzle quadro 1200 TS / TST**
 - Kränzle quadro 1500 TS / TST**
- Nominal flow:
- Kränzle quadro 800 TST: 800 l/h**
 - Kränzle quadro 1000 TS / TST: 1000 l/h**
 - Kränzle quadro 1200 TS / TST: 1200 l/h**
 - Kränzle quadro 1500 TS / TST: 1500 l/h**

technical specifications available from:

- Fa. Josef Kränzle GmbH & Co. KG**
- Manfred Bauer**
- Rudolf-Diesel-Str. 20, 89257 Illertissen**

comply with the following guidelines and their amendments for high pressure cleaners:

- Machinery directive 2006/42/EC**
- EMC-directive 2004/108/EC**
- Noise directive 2005/88/EC,**

Art. 13 HP water spraying machines Annex 3, part B, chapter 27

- Sound level measured: **89 dB (A)**
- Sound level guaranteed: **91 dB (A)**

Applied conformity assessment procedure: **Annex V, Noise directive 2005/88/EC**

- Applied specifications and standards:
- EN 60 335-2-79: 2015**
 - EN 55 014-1: 2006**
 - EN 61 000-3-2: 2014**
 - EN 61 000-3-3: 2013**

Josef Kränzle GmbH & Co. KG
Rudolf-Diesel-Straße 20
89257 Illertissen (Germany)

Illertissen, 2017-01-12

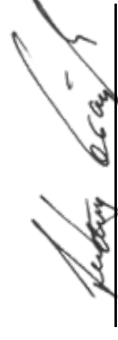

Ludwig Kränzle
(Managing director)

The warranty obligation of Josef Kränzle GmbH & Co. KG towards the dealer from whom you have purchased this Kränzle high-pressure cleaner (= product) applies to material faults only such as material and manufacturing defects.

Defects attributable to long and frequent use of the product, typically arising due to the age of the high-pressure cleaner and intensity of its use are defined as normal wear in respect of product components. Purchaser's rights to assert claims for such defects are ruled out. Parts subject to wear include in particular the pressure gauge, nozzle, valves, sleeves, high-pressure hose and spray equipment.

The product is to be operated in conformity with this operating manual. The operating manual is deemed to be part of the warranty provisions.

Any changes made to the safety devices of the product or instances of maloperation – such as exceeding the temperature and speed limits, undervoltage, insufficient water supply and sewage water, or failure to use the product for the intended purpose – may result in damage occurring to the product. Such damage is not deemed to constitute any material defect.

Should the use of accessories or spares other than original Kränzle component parts and original Kränzle replacement parts be the cause of defects on our product, this may lead to all warranty claims becoming null and void. Only the use of original Kränzle replacement parts matching the relevant Kränzle high-pressure cleaner provides adequate assurance for safe and trouble-free operation of the Kränzle high-pressure cleaner.

With regard to legal warranty claims, the limitation periods of the respective countries shall apply.

Where warranty claims apply to any other defects, please contact your local dealer, presenting the accessories together with your purchase receipt, or the nearest authorised service centre. This can also be found on the internet under **www.kraenzle.com**.

High pressure cleaners for industrial use have to be checked by an expert every 12 months! Inspection report on annually carried out Labour Safety Inspection (UVV) according to the Guidelines for Liquid Spray Equipment. (This inspection sheet serves as proof for the completion of the retest and must be kept carefully!)

Kränzle-test seals: Item no.: UVV200106

Owner: Type:
 Address: Serial no.:
 Repair order no.:

Scope of inspection	o.k.	yes	no	repaired
Type plate (on hand)				
Operating manual (on hand)				
Protective covering, Protective device				
Pressure line (tightness)				
Stainless steel pressure gauge (function)				
Float valve (tightness)				
Spraying device (marking)				
High pressure hose / connector (damage, marking)				
Safety valve opens at 10 % / 20 % exceeding power supply cable (damage)				
Protective conductor (connected)				
On / Off switch				
Used chemicals				
Allowed chemicals				

Inspection data	determined value	set value
High pressure nozzle		
Operating pressurebar		
Switch off pressurebar		
protective conductor resistance not exceeded / value		
Insulation		
Leakage current		
Safety trigger gun locked		

Inspection result (check)

- The high pressure cleaner was checked by an expert according to the Guidelines for Liquid Spray Equipment, the defects found have been rectified so that the Labour Safety can be confirmed.
- The high pressure cleaner was checked by an expert according to the Guidelines for Liquid Spray Equipment. The Labour Safety cannot be confirmed unless the defects found are rectified by repair or replacement of the faulty parts.

The next retest according to the Guidelines for Liquid Spray Equipment has to be carried out by: Month Year

Place, Date Signature

High pressure cleaners for industrial use have to be checked by an expert every 12 months! Inspection report on annually carried out Labour Safety Inspection (UVV) according to the Guidelines for Liquid Spray Equipment. (This inspection sheet serves as proof for the completion of the retest and must be kept carefully!)

Kränzle-test seals: Item no.: UVV200106

Owner: Type:
 Address: Serial no.:
 Repair order no.:

Scope of inspection	o.k.	yes	no	repaired
Type plate (on hand)				
Operating manual (on hand)				
Protective covering, Protective device				
Pressure line (tightness)				
Stainless steel pressure gauge (function)				
Float valve (tightness)				
Spraying device (marking)				
High pressure hose / connector (damage, marking)				
Safety valve opens at 10 % / 20 % exceeding power supply cable (damage)				
Protective conductor (connected)				
On / Off switch				
Used chemicals				
Allowed chemicals				

Inspection data	determined value	set value
High pressure nozzle		
Operating pressurebar		
Switch off pressurebar		
protective conductor resistance not exceeded / value		
Insulation		
Leakage current		
Safety trigger gun locked		

Inspection result (check)

- The high pressure cleaner was checked by an expert according to the Guidelines for Liquid Spray Equipment, the defects found have been rectified so that the Labour Safety can be confirmed.
- The high pressure cleaner was checked by an expert according to the Guidelines for Liquid Spray Equipment. The Labour Safety cannot be confirmed unless the defects found are rectified by repair or replacement of the faulty parts.

The next retest according to the Guidelines for Liquid Spray Equipment has to be carried out by: Month Year

Place, Date Signature

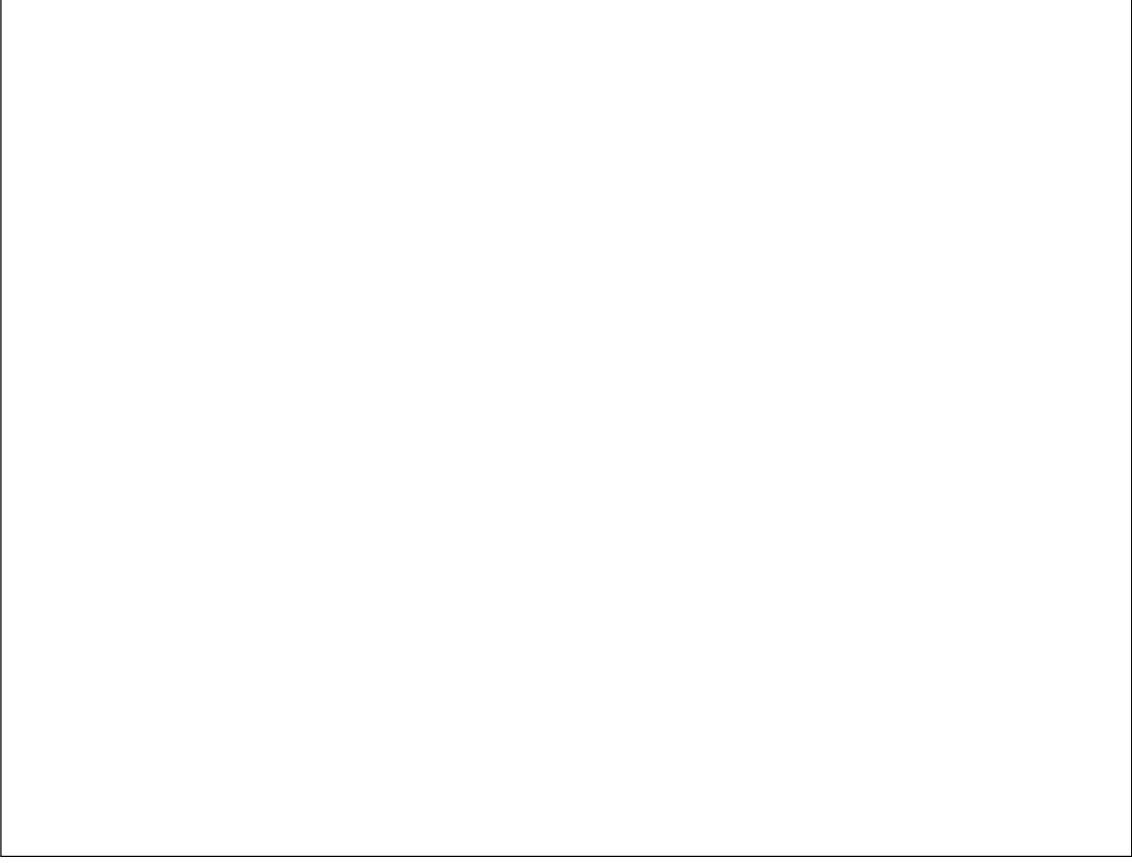

kranzle®

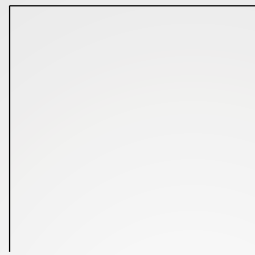

Josef Kränzle GmbH & Co. KG

Rudolf-Diesel-Straße 20
89257 Illertissen (Germany)

sales@kraenzle.com

©Kranzle 03.12.2018 / Ord. no.: 302600 / Subject to technical modifications and errors.

■ **Made**
■ **in**
■ **Germany**

www.kraenzle.com