

Technical perfection and top design

kränzle[®]
HOCHDRUCKREINIGER

w w w . k r a n z l e . c o m

Operating manual

Hot Water High-Pressure Cleaners

therm

635-1

875-1

895-1

1165-1

1525-1



Read and conform safety instructions before use !

- GB -



2 Description of appliance

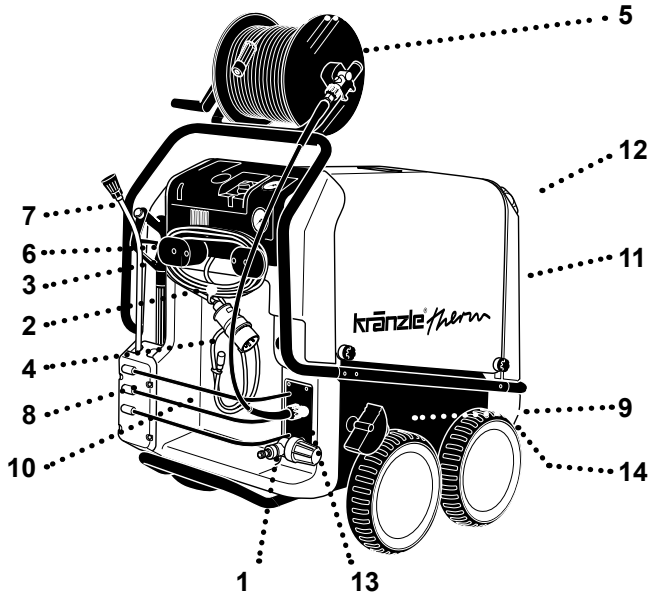

- | | | | |
|---|------------------------------------|----|------------------------------------|
| 1 | Water inlet connection with filter | 8 | Storage bin for spray gun and pipe |
| 2 | Power cable | 9 | Brake |
| 3 | Winder for cable | 10 | Storage bin for accessories |
| 4 | Suction hose for detergent | 11 | Fuel tank |
| 5 | Hose drum (option) | 12 | Filler aperture for fuel |
| 6 | Spray gun | 13 | High pressure outlet |
| 7 | Spray pipe attachment | 14 | Fuel drainage screw |

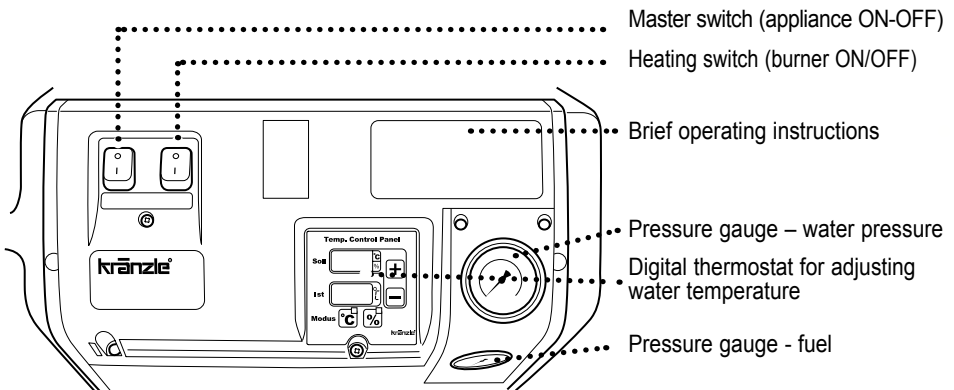

Contents

Description of appliance	2
Contents	3
Technical data	4
Overview "This is what you have purchased"	6
General rules	6
Safety precautions – accident prevention	7
That's what you have to observe	9
Kränzle- technology.....	11
Water and cleaning system.....	11
Lance and spray gun	11
Total stop system	11
High pressure hose and spray device.....	12
Pressure control valve – safety valve	12
Motor protecting switch	12
Thermostat.....	13
Heat exchanger.....	15
Commissioning	16
Usage as a cold water high pressure cleaner	18
Usage as a hot water high pressure cleaner	19
Steam level	19
When using detergents	20
Decommissioning - frost protection.....	21
Care and Maintenance (weekly/yearly)	22
Changing the oil	23
Decalcifying the heating coil	23
Fuel System.....	24
Ignition electrodes.....	24
Particular rules, directives and inspections.....	25
Circuit diagramme.....	26
Troubleshooting.....	28
Pipeline plan	35
Inspections – inspection reports	36
EG – Declaration of Conformity.....	38
Guarantee	39
Inspection sheet.....	40

4 Technical data

	therm 635-1	therm 875-1
Operating pressure, continuously adjustable	30 - 130 bar	30 - 170 bar
Admissible overpressure	145 bar	190 bar
Water output Q _{max}	635 l/h	875 l/h
Nozzle size, flat jet nozzle	D25045	D25045
Hot water output temperature (water supply 12 °C)	max. 80 °C	max. 80 °C
Steam level	max. 140 °C	max. 140 °C
Heating oil jet - Oil pressure	1,35 Gph-10 bar	1,5 Gph-10 bar
Heating oil consumption at max. heating output	4,8 kg/h = 5,7 l/h	5,8 kg/h = 6,8 l/h 4,2 kg/h = 5,0 l/h
Heating output	50 kW	60 kW
Exhaust gas mass flow	0,032 kg/s	0,035 kg/s
Fuel tank	25 l	25 l
High pressure hose for machines without hose drum	10 m	10 m
High pressure hose for machines with hose drum	20 m	20 m
Connected load	230 V, 15 A, 50 Hz	400 V, 8,7 A, 50 Hz
Power input	P 1 - 3,4 kW	P 1 - 4,8 kW
Power output	P 2 - 2,3 kW	P 2 - 4,0 kW
Weight	220 kg	220 kg
Dimensions without reel, L x W x H in mm	1050 x 800 x 1000	1050 x 800 x 1000
Sound level acc. to DIN 45 635	84 dB (A)	86 dB (A)
Guaranteed sound level L _{WA}	88 dB (A)	89 dB (A)
Vibrations at lance	ca. 20 N	ca. 21 N
Recoil at lance	2,0 m/s ²	2,2 m/s ²
Order No. without hose drum	41.349	41.342
Order No. with hose drum	41.349 1	41.342 1

	therm 895-1	therm 1165-1	therm 1525-1
Operating pressure, continuously adjustable	30 - 195 bar	30 - 165 bar	30 - 125 bar
Admissible overpressure	210 bar	180 bar	140 bar
Water output Qmax	895 l/h	1165 l/h	1500 l/h
Nozzle size, flat jet nozzle	D25045	D2507	M20125
Hot water output temperature (water supply 12 °C)	max. 80 °C	max. 80 °C	max. 60 °C
Steam level	max. 140 °C	max. 140 °C	max. 140 °C
Heating oil jet - Oil pressure	1,5 Gph-10 bar	1,65 Gph-13 bar	1,65 Gph-13 bar
Heating oil consumption at max. heating output	6,1 kg/h = 7,1 l/h 4,3 kg/h = 5,1 l/h	7,1 kg/h = 8,5 l/h 4,2 kg/h = 5,0 l/h	7,7 kg/h = 9,2 l/h 7,2 kg/h = 8,5 l/h
Heating output	65 kW	78 kW	84 kW
Exhaust gas mass flow	0,035 kg/s	0,041 kg/s	0,054 kg/s
Fuel tank	25 l	25 l	25 l
High pressure hose for machines without hose drum	10 m	10 m	10 m
High pressure hose for machines with hose drum	20 m	20 m	20 m
Connected load	400 V, 11 A, 50 Hz	400 V, 11 A, 50 Hz	400 V, 11 A, 50 Hz
Power input	P 1 - 7,5 kW	P 1 - 7,5 kW	P 1 - 7,5 kW
Power output	P 2 - 5,5 kW	P 2 - 5,5 kW	P 2 - 5,5 kW
Weight	220 kg	220 kg	220 kg
Dimensions without reel, L x W x H in mm	1050 x 800 x 1000	1050 x 800 x 1000	1050 x 800 x 1000
Sound level acc. to DIN 45 635	89 dB (A)	89 dB (A)	89 dB (A)
Guaranteed sound level L_{WA}	91 dB (A)	91 dB (A)	91 dB (A)
Vibrations at lance	ca. 22 N	ca. 22 N	ca. 24 N
Recoil at lance	2,2 m/s ²	2,2 m/s ²	2,2 m/s ²
Order No. without hose drum	41.352	41.353	41.348
Order No. with hose drum	41.352 1	41.353 1	41.348 1

6 This is what you have purchased

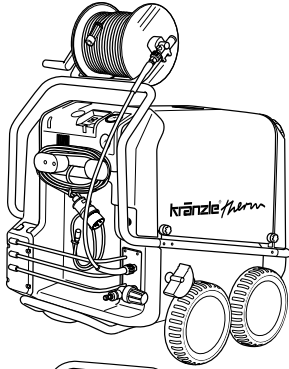

1. Kränzle high-pressure cleaner **therm** with hose drum and 20 m steel-weave high-pressure hose NW 8

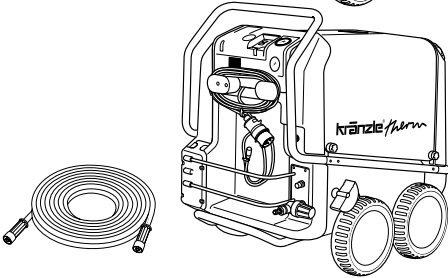

or
Kränzle high-pressure cleaner **therm** without hose drum but with 10 m steel-weave high-pressure hose NW 8

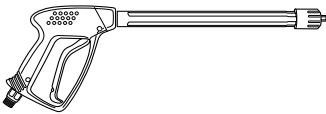

2. Safety spray gun with insulated handle and screw connection



3. Lance with flat-jet nozzle

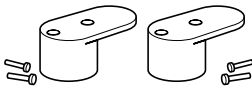

4. Holding devices for cable with screws

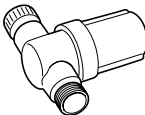

5. Water intake filter

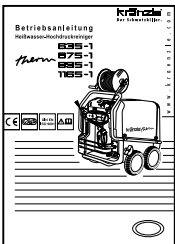

+

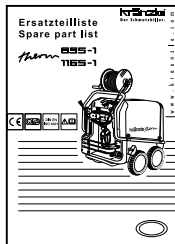

6. Operating manual + Spare parts list

General rules

■ Range of application

This machine may only be used for cleaning facades, vehicles, containers, pavement slabs, stables, machines and similar objects.

■ Inspections

The machine must be inspected according to the "Guidelines for Liquid Spray Devices" at least once every 12 months by a qualified person, to ensure that continued safe operation is guaranteed. The results of the inspection are to be recorded in writing. This may be done in any form. For inspection reports see pages 54 - 55.



High-pressure cleaners used for commercial purposes have to be checked by a qualified person at least every 12 months!

■ Accident prevention

The machine is designed for accidents to be impossible (if used according to these instructions). Please read safety notes included in these instructions carefully before using the machine and act correspondingly. Operating staff has to be instructed according to this manual. The "Guidelines for Liquid Spray Devices" must be complied with.

■ Setting up - Location

Neither set up and operate the machine in rooms where there is a risk of fire or explosion nor put it into puddles. Do not use the machine under water.



During the combustion process air is needed and exhaust gas emerges. If the machine is operated in a confined space, precautions have to be taken to safely exhaust the fumes. Furthermore a sufficient ventilation has to be provided for.

Never shut the exhaust gas outlet on top of the machine. Never stoop over this aperture and never reach into it. Emerging gases are extremely hot!

Safety notes



Do not jam the trigger of the gun during operation!
When carrying through service and maintenance tasks the machine has to be cut off the power supply system. Put main switch to "0" and pull plug out of socket.

Never operate the machine if cables or other safety-relevant parts (e.g. excess pressure valve, high-pressure hose, spraying devices, etc.) are defective.

8 Safety notes

Never operate the machine without supervision.

The machine may only be operated by persons who have been instructed accordingly.

Some parts inside the machine, all water conducting components and all metal parts of gun and lance are hot during hot water operation. Keep all hoods and protective covers closed during operation and never touch any metal parts of gun or lance.

Persons operating the machine should wear the necessary protective clothing, i.e. waterproof clothing, rubber boots, safety goggles, headwear etc. It is prohibited to use the machine in close vicinity to people lacking suitable protective clothing.

The high pressure spray can generate a high level of noise. If noise exceeds the maximum allowed levels, users and others in the vicinity must wear suitable ear protection.

Do not spray against matter containing asbestos or other hazardous substances.

Only use light heating oil EL (DIN 51 603) or diesel (DIN EN 590). The use of any other fuel may be hazardous and dangerous (risk of explosion).

For safety reasons always switch the main switch to "0"- position after having finished the cleaning task (disconnection from power supply).

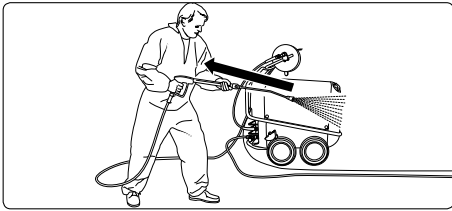

Bear in mind that during cleaning tasks with a high-pressure water jet a significant recoil at the lance arises (see technical data on page 2).

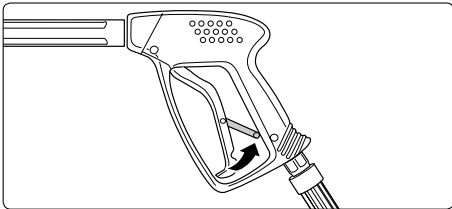

Apply the safety catch on the spray gun after each use, in order to prevent unintentional spraying!

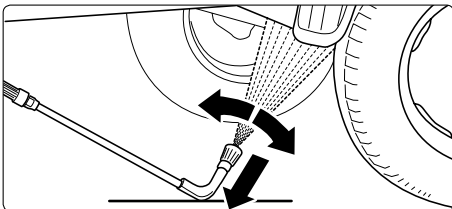

Always aim the underbody lance! Bear in mind when using a curved or angled spraying lance that there is a significant amount of torque in the recoil!

Safety notes - This is prohibited!

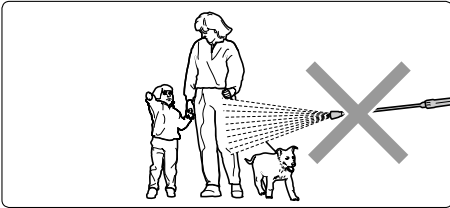

Never direct the high-pressure water jet towards the operator him-/herself or towards other persons, not even for cleaning clothing or shoes.

Never direct the water jet at animals!

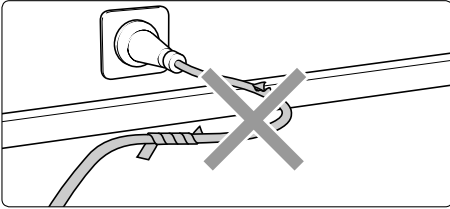

Only use power cables which are in perfect working order! Do not damage the power cable or repair it incorrectly!

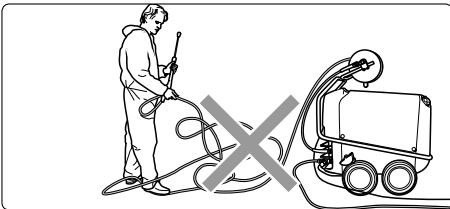

Never pull the high pressure hose if it has formed kinks or "nooses"!

Never pull the hose over sharp edges!

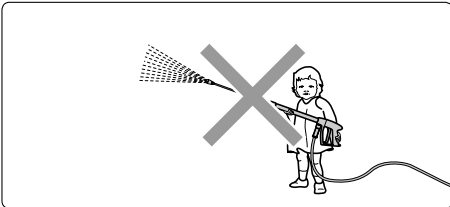

Never allow children to use the high pressure cleaner!

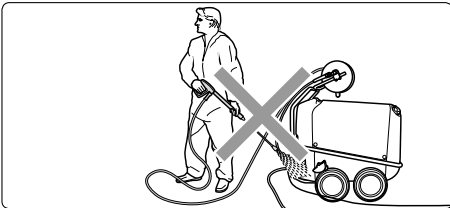

Never direct the water jet at the machine itself!

The machine may not be placed within reach of the water jet spray mist!

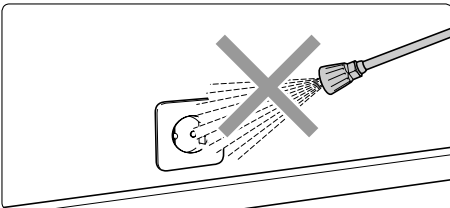

Never direct the water jet at a power socket!

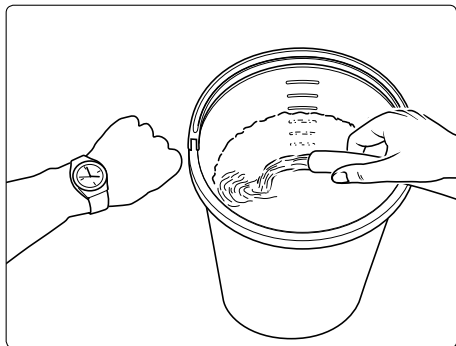
10 Please note - important!**■ Lack of water**

Lack of water occurs more often than you probably believe. The more powerful a high-cleaner is the greater is the danger that a lack of water occurs. If there is only an insufficient amount of water available, cavitation arises inside the pump, which is normally noticed too late or even not at all. **The pump will be destroyed!**

Please check the available quantity of water by filling a bucket with litre scale for half a minute.

Required minimum quantities: see technical data



If the metered quantity of water is too small, you have to use a different water connection, guaranteeing the necessary output. Lack of water leads to an accelerated wear of the joints (no guarantee)

■ Connection to water supply

Please pay attention to the regulations of your waterworks company! In accordance with DIN EN 61770, the machine may not be directly connected to the public drinking water supply lines. A brief connection however is permissible according to DVGW (German Association for Gas and Water Affairs) if a tube ventilator with check valve (Kränzle Order-No. 41.016 4) is built into the water supply. Also indirect connection to the public drinking water supply lines is permissible by way of free emission in accordance with EN 61 770; e.g. by using a reservoir with a float valve. Direct connection to a non-drinking water supply line is permissible.

Please note - important!

■ Insufficient quantity of electricity

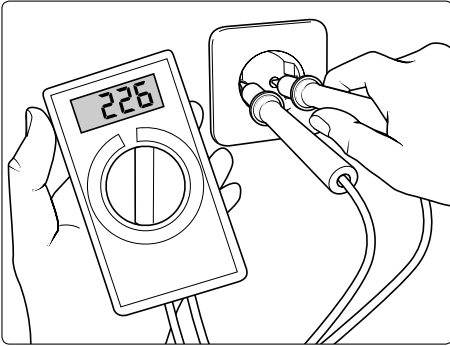

If there are too many collectors in your proximity connected to the network at the same time, the available voltage and the current intensity may decline. Consequently the motor of the high-pressure cleaner does not start or even blows. The power supply may also be insufficient if the power cable is too long or too thin. If extension cables are too long, this may lead to a voltage drop causing malfunctions or start-up difficulties.



Check the line fusing and have the voltage and the available current intensity checked by an expert in case of uncertainty.

■ Electrical connection

The machine is supplied with an electrical power cable with plug. The mains plug must be fitted to a standard grounded socket with a **30 mA** residual current operated device. The socket must be protected with a **16A** delay action fuse on the mains side. When using an extension cable, this must have an earthed lead which is properly connected to the socket. The conductors in the extension cable must have a minimum cross section of **1.5 mm²**. Plug connections must be of a spray-proof design, and may not be located on a wet floor. With extension cables of **more than 10 m** the minimum cross section must be **2.5 mm!** When using a cable drum, always keep the cable wound as far as possible.

12 Kränzle technology

■ Water and Cleaning System

The water is fed to the high-pressure cleaner under pressure (2-8 bar pre-pressure). A float valve regulates the water flow in the storage tank. Then the water is sucked directly from the storage tank by the high-pressure pump and forced with the adjusted pressure through the heat exchanger to the safety spray lance. The high pressure jet is formed by the nozzle at the end of the safety lance.



Environmental, refuse disposal and water protection regulations must be observed!

■ Lance with trigger gun

The machine can only be operated when the safety trigger is squeezed. When the lever is squeezed, the spray gun opens. The liquid is then pumped to the nozzle. The spray pressure increases and quickly reaches the selected operating pressure. When the trigger is released, the trigger gun closes and any further spraying of liquid from the lance is stopped. The motor stops.

When actuating the gun once more the pressure control valve - safety valve closes and the motor is started again. The pump resumes feeding water to the spraying lance with the selected operating pressure. When the gun is closed, the water hammer opens the pressure control valve - safety valve and the motor is switched off by the pressure switch.



The trigger gun is a safety device. Repairs should only be performed by qualified persons. Should replacement parts be required, use only components authorized by the manufacturer.

■ Total stop system

The machine is fitted with a Total-Stop-System. If the gun is closed for longer than approx. 20 seconds, the machine switches off automatically, after 20 minutes the machine moves to safety switch off and you must use the main switch to turn it back on. The machine restarts automatically when the gun is operated, provided that the master switch is on.

Kränzle technology

■ High pressure hose and spraying device

The high pressure hose and spraying device supplied with the machine are made of high grade material, they are also optimized for the machine and marked as required by the appropriate regulations.

If replacement parts are required, only such parts that are authorized by the manufacturer and which bear the markings required by the appropriate regulations may be used.

The high pressure hose and spray device must be connected in a pressure-tight manner.

The high pressure hose may not be driven over, pulled excessively, or twisted. The hose may under no circumstances be pulled over sharp edges, since otherwise the guarantee is automatically void.

Hoses are wearing parts. The guarantee only covers defects of fabrication no external damages whatsoever.

Defective high-pressure hoses and spraying devices may not be repaired. They always have to be replaced.

■ Pressure control valve-safety valve

The pressure control valve allows full adjustment of the quantity and pressure of the water. The safety valve protects the machine from excessive pressure and cannot be adjusted beyond the admissible operating pressure. The setting nuts are sealed with lacquer.



Replacements, repairs, new adjustments and sealing operations may only be performed by trained personnel.

■ Motor protection switch

The pump motor is protected from overload by a motor protection switch, which cuts out the motor in the event of overload. To start the motor again the main switch has to be switched off and then on again. However should the switch trip frequently, the cause of the malfunction should be located and rectified.



Replacements and inspection work should only be performed by qualified persons when the machine is disconnected from the power supply, i.e. with plug pulled out from the electrical socket.

14 Kränzle technology

■ Thermostat

The thermostat controls the spray water temperature.

After you switch on the device, "888" appears in both displays for approx. 1 second as a test of the functioning of the displays.

The thermostat also monitors the minimum fuel level in the tank with a floating switch. If the level is below the minimum amount, the thermostat switches the oil burner off and the "OIL" sign flashes in the set temperature display (Pos. 1). If the unit displays "FLA" in the upper display, a malfunction in burning exists.

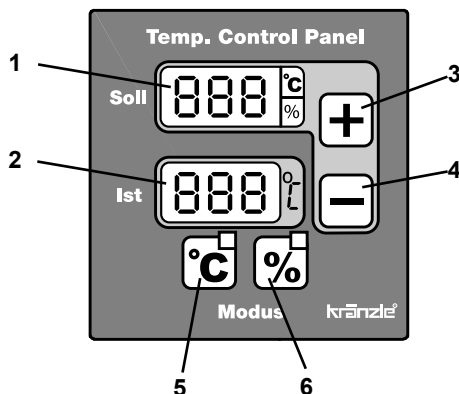

The thermostat has two operating modes:

1. Temperature mode

This mode is always activated when the unit is switched on or can be selected using the "°C" button (Pos. 5). The red LED above the "°C" button and next to the set temperature display lights up.

The desired "Set" temperature is set using the two buttons (+/-, Pos. 3+4) and can be read in the upper display (Pos. 1).

If you press the button for a longer time, the set temperature is quickly adjusted in 5°C increments.

The last set value set is also stored after the unit is switched off and is available again immediately after switching back on.

The current spray temperature can be read from the bottom display (Pos. 2).

2. Percentage mode

This mode is activated by pressing the "%" button (Pos. 6). The yellow LED above the "%" button and next to the set temperature display flashes.

In the temperature control system in conventional high pressure cleaners, and in temperature mode for this unit, the water temperature is measured at the outlet of the heater, and the heater is switched on an off according to the temperature desired by the user. Due to the large amount of water in the heating coil, it takes a long time until the temperature sensor registers that the burner has switched on and the desired temperature has been reached. This means that the temperature increases far above the desired value or falls far below the desired value.

Kränzle technology

The innovative new percent mode now lets the user specify the switching duration of the heater in percent using the "+" and "-" buttons (Pos. 3+4) (100% being the max. temperature) rather than setting the desired temperature. Now the result of the setting must be checked by using the "Actual" temperature display. If the desired temperature has not yet been reached, the percentage must be increased.

By setting percentages of the heating duration, the temperature of the high pressure jet is kept constant in a very narrow range.

The last value set is also saved after the unit is switched off in percent mode.

Operating hour meter

The cleaner is equipped with an operating hour meter.

If during normal operation the momentary operating mode button ("°C" or "%") is actuated for more then 2 seconds, the operating time of the pump is displayed for 5 seconds and afterwards the combustion time for 5 seconds as well. Thereafter the display shows the original values again.

As long as the operating hours are displayed no further inputs on the monitor are possible.

The operating time is displayed in hours [h] either in the "TARGET" or in the „ACTUAL“ window. The 1000 and 100 hours are displayed in the „TARGET“ window and the 10, 1 and 1/10 hours in the "ACTUAL" window:

Pump operating time: Target-Display: P 9 9 Actual-Display: 9 9. 9 for 9 999.9h

Combustion time: Target-Display: F 9 9 Actual-Display: 9 9. 9 for 9 999.9h

e.g.: F00 27.3 = Cumbustion time 27 hours and 18 minutes

Heat exchanger

The water is forced through a heating coil by the high pressure pump. Heating coil: 38 m long - Content: 5 l of water - Heating capacity: max. 90 kW

The fuel pump draws the oil from the tank through a filter and pumps it to the injector nozzle. The oil pressure is shown on the fuel manometer.

The heat exchanger is heated by a high pressure fan heater.

A ventilator draws in the cold, fresh air from the bottom end of the machine and forces it upwards between the outer mantle and the inner mantle. In the process, the fresh air is pre-heated and the outer mantle of the heat exchanger is cooled.

The pre-heated air is pressed through a mixing unit. Here finely atomized fuel is injected via a nozzle and mixed with the air. The electrodes located below then ignite the fuel-air mixture.

The flame burns from top to bottom, turns round and the hot gas flows past the heating coil on its way back up. The burned gases collect in the exhaust chamber and are emitted from the chimney.

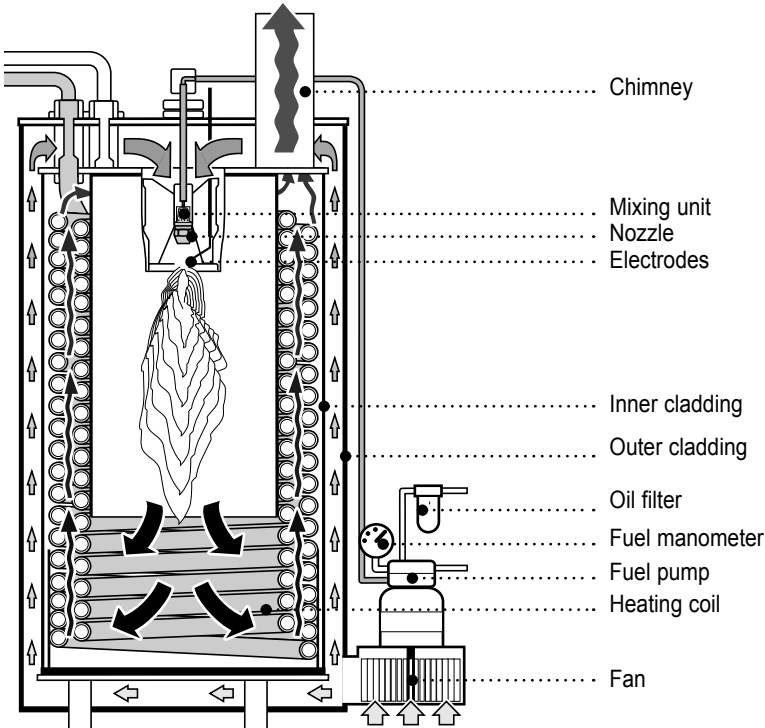

Commissioning

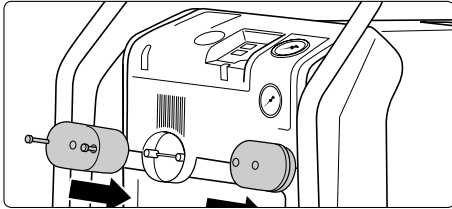

1. Install holding devices for power cable.

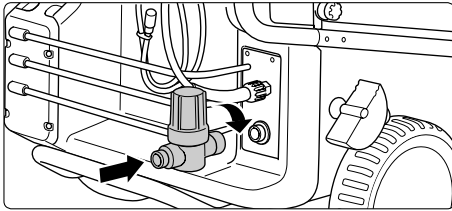

2. Install water inlet filter.

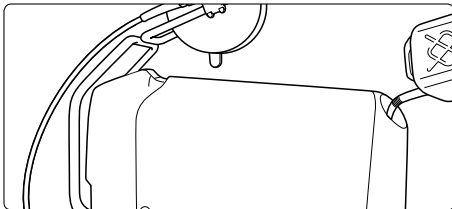

3. Fill fuel tank with fuel. (Light heating oil EL DIN 51 603 or diesel fuel)
Max. quantity 25 litres.

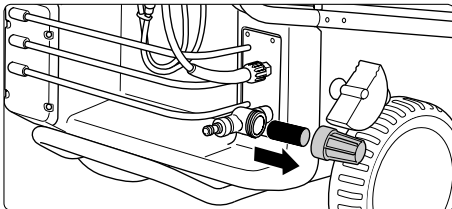

4. Check water inlet filter for cleanliness prior to putting the machine into operation! Unscrew glass body of the inlet filter and check if metal sieve is soiled.

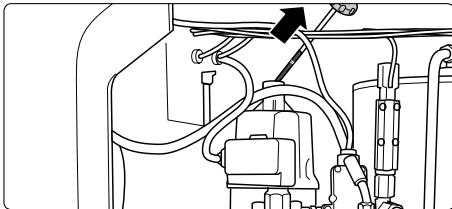

5. Each time check oil!
Do not start the machine if there is no oil visible on the oil clipstick. Refill with oil if necessary. See page 23

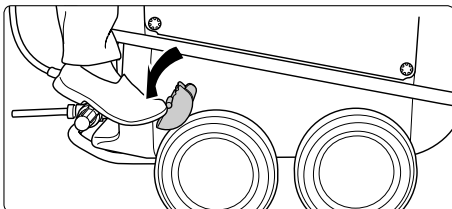
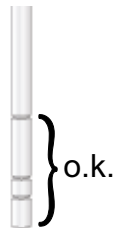

6. Release fixing brake.

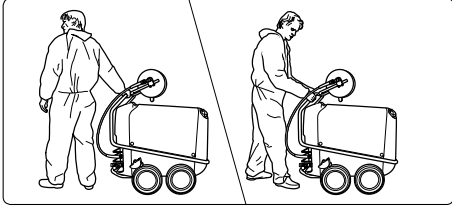

7. Move machine to job site.
Kränzle-therm appliances are movable machines with a sturdy chassis.

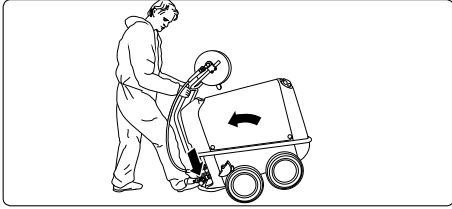

8. Steering the machine: To change direction tilt machine by pressing a foot against the footrest and pull the handle at the same time. Then turn machine into desired direction.

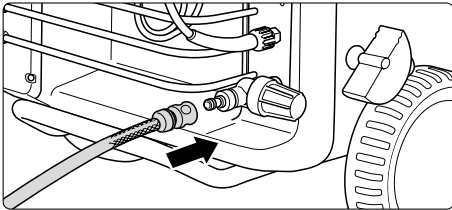

9. Connect machine to water mains (2 - 8 bar pre-pressure).
Inside diameter of hose minimum 1/2 ". The water storage tank is filled with water. The float valve shuts the water intake as soon as the tank is full.

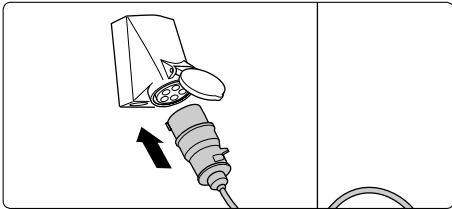

10. Connect to power circuit. **Make sure that the main switch is on the "OFF" position.**
The socket must be protected with a 16A delay action fuse on the mains side.

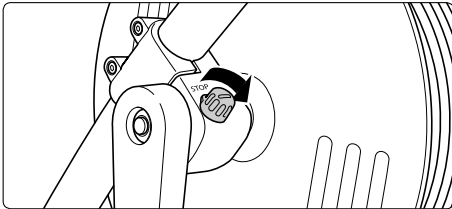

11. Release fixation of hose drum.

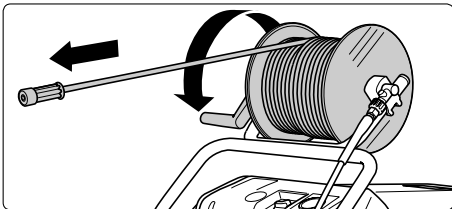

12. Unwind HP hose from hose drum without kinks and nooses.
Open gun before reeling up or unreeling the hose in order to bleed pressure from hose.

Commissioning

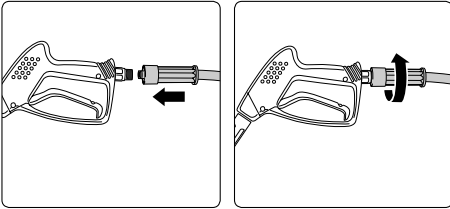

13. Push on HP hose to gun.
14. Screw together HP hose and gun pressure-tightly.



Take care that all screw connections are pressure-tight. A leakage of gun, high-pressure hose or hose drum has to be repaired at once. Leakages lead to an increased wear and to a possible malfunction of the delayed motor cut-out.

■ Usage as a cold water high-pressure cleaner

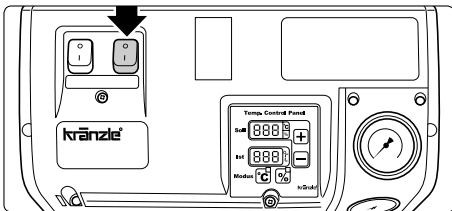

1. Ignition switch to -OFF- position

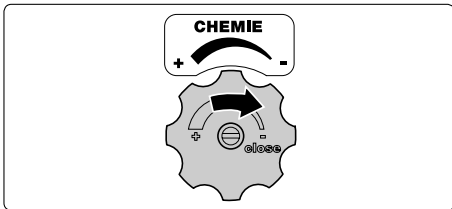

Detergent valve must be closed!
(Turn knob to extreme right position "close")

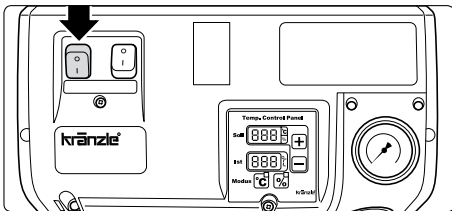

2. Switch on main switch with disengaged spray gun. Vent high-pressure cleaner: Pull and release trigger of spray gun various times.

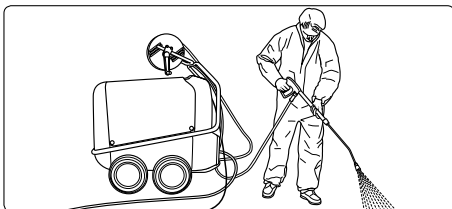

When starting the cleaning process do not aim the water jet towards the object you want to clean for at least 30 seconds. Maybe the water inside the combustion chamber has changed colour due to the rest time.
Start cleaning process.

■ Usage as a hot water high pressure cleaner

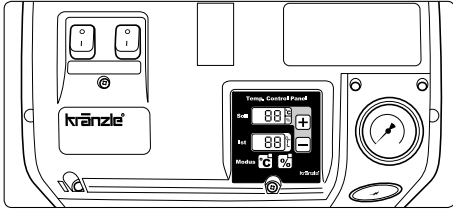

Method same as with cold water high-pressure cleaner, then ...

1. Set desired temperature at the thermostat.
(Min. temperature 40 °C)

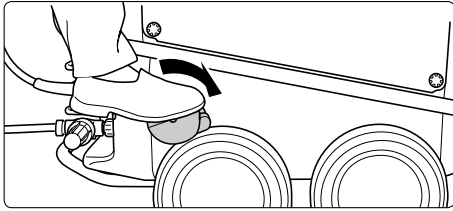

2. Engage fixing brake before starting the cleaning process!

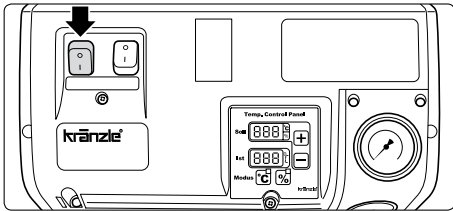

3. Switch on main switch with disengaged spray gun. Vent high-pressure cleaner: Pull and release trigger of spray gun various times.

Detergent valve must be closed!
(Turn knob to extreme right position "close")

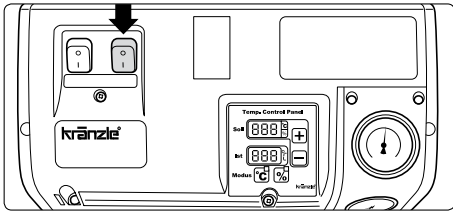

4. Start ignition. The water is heated up and constantly kept at the set temperature.

Start cleaning.



During high-pressure operation (above 30 bars) the temperature may not exceed 90 °C.

■ Steam level (90 °C - 150 °C)



During steam operation the pressure may not exceed 30 bar!

To reach the steam level (above 90 °C water temperature) adjust the pressure below 30 bar and choose by means of the thermostat the desired temperature of up to max. 150 °C.



In the case of machines with hose drums, the high pressure hose must always be unwound completely.

Suction of detergents

■ with detergent supply from the suction side:

Detergent injection on the pressur side, as you probably know it from other HP cleaners, consume approx. 30 % of the cleaning energy, no matter if they are used or not. Due to the water tank fitted to the Kränzle therm cleaners it is now possible to directly suck the detergent into the pump thus reducing output loss and increasing the efficiency considerably.

The detergents are applied without having to reduce the working pressure.

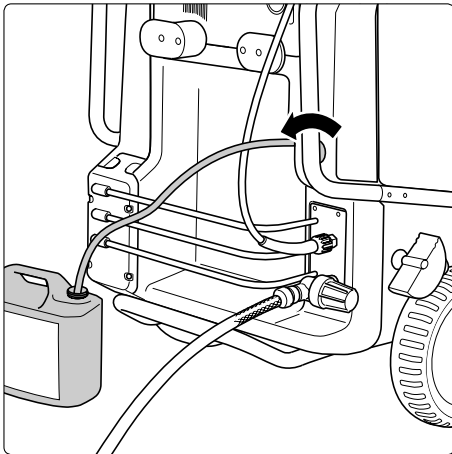

1. Place detergent filter into detergent container.
 2. Dosing of detergent is done by turning the detergent valve.
-
3. By closing the detergent valve the supply of detergent is stopped.
 4. After having used detergents rinse the appliance with open spray gun and clear water for at least 2 minutes.



Only open the dosing valve, if the detergent sieve is placed in a liquid. Sucked air leads to destruction of the pump seals! No guarantee!



Keep detergent-ph-value neutral 7 - 9!
Observe specifications of detergent manufacturer!
e.g.: protective equipment, rules for waste water treatment etc.



Never suck in liquids containing solvents like varnish solvents, petrol, oil or similar liquid! Observe specifications of detergent manufacturers!



Seals inside the appliance are no resistant against solvents! The spray mist of solvents is highly inflammable, explosive and poisonous.

22 Decommissioning - frost protection

1. Switch off the machine - main switch to „0“- position
2. Cut off the water supply
3. Open the spray gun briefly until the pressure is released
4. Apply the safety catch on the spray gun
5. Remove the water hose and spray gun
6. Drain the pump: switch on the motor for approx. 20 seconds
7. Pull the plug from the socket
8. Clean HP hose and wind up; fix drum
9. Clean power cable and wind up
10. Clean water filter

■ Frost protection

The machine is normally still partially filled with water after work has been completed.

To protect the appliance from frost, completely empty it of water:

Disconnect the machine from the water supply and switch off the ignition. Switch on the master switch and open the gun. The pump now presses the remaining water out of the water tank, the pump and the heating coil.

Do not allow the machine to run for longer than a minute without water.

If the machine is not in use for lengthy frosty periods of time, it is advisable to pump anti-freeze into the machine: For this purpose, fill the antifreeze agent into the water tank and switch on the machine without ignition. Wait with opened gun, until the agent comes from the nozzle.

However, the best protection against frost is to keep the machine in a place that is safe from frost.

Care and Maintenance



The machine must be disconnected from the power supply when servicing work is being carried out. The main switch should be in position "0" and the plug out of the socket.

■ Weekly, or after approx. 40 hours of operation:

- Check the oil level of the high pressure pump. If the oil level is too low, add oil until the oil level is between the two markings on the oil measuring rod. Change the oil if it has a grey or whitish appearance. The oil should be disposed of responsibly.
- Check the water filter in front of the float valve in the water tank and the fuel filter in front of the solenoid valve. Clean the filters if necessary.

■ Yearly, or after approx. 500 hours of operation:

- Desulphurise and decarbonize the heating coil.
- Check heating coil for calcification, decalcify if necessary.
- Check the oil burner and ignition system.
- Clean the oil nozzle, oil filter, solenoid valve and filter, clean and adjust the ignition transformer, ignition cable and ignition electrodes and replace defective parts.
- Change the oil



Oil leakage: If oil leaks out, go to the nearest customer service (dealer) immediately. (Environmental damages, transmission damages, loss of guarantee.)

In case of increased humidity or fluctuations in temperature development of condensed water is possible; if the oil turns grey, you must change it.

■ Changing the oil:

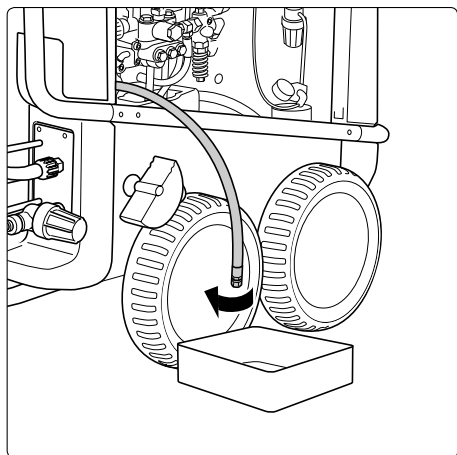

First oil change after approximately **50 operating hours**. Thereafter the oil should be changed every 500 operating hours or yearly.

Take the oil drainage hose, which is connected to the oil drainage screw from the inside of the appliance.

Open the red oil filler plug at the top side of the black oil housing.

Open the cap at the end of the hose.

Drain off the oil into an oil pan and dispose of it responsibly. Close the end of the hose. Refill with new oil.

therm 635-1 - 875-1: 0,8 l - 10 W 60

therm 895-1 - 1525-1: 1,0 l - 10 W 60

■ Decalcifying the heating coil:

Calcified machines use an unnecessary amount of energy because the water can only be heated slowly and the excess pressure valve feeds a part of the water back into the pump circuit.

Calcified machines can be recognised by increased pipeline resistance.

Check pipeline resistance by disconnecting the high pressure lance from the gun and switching the machine on. A full jet of water emerges from the gun. The machine must be decalcified if the pressure shown on the manometer is greater than **25 bar**.

Proceed as follows to decalcify the machine:

1. Unscrew the high pressure hose from the machine and decalcify it separately.
2. Put the detergent suction hose into a container of decalcifying solution.
3. Set the dispenser valve to the maximum concentration.
4. Switch on the machine.

Care and Maintenance

5. Hold the gun in a separate container and press the trigger.
6. Wait for about a minute until the decalcifier comes out of the gun (recognisable by its whitish colour)
7. Switch off the machine and allow the solution to act for about 15-20 minutes.
8. Switch the machine back on and rinse it through with clear water for about 2 minutes.
9. Now check whether pipeline resistance is back to an acceptable level.

Repeat the decalcifying process if the pressure without the high pressure lance is still above 25 bars.



Decalcifiers are caustic!

Observe the instructions for usage and accident prevention. Wear protective clothing to prevent the decalcifying agent from contacting your skin, eyes and clothing (e.g. gloves, safety mask etc.)

■ Fuel System:

Your fuel may contain particles of dirt, or impurities or water may get into the tank during refuelling. To protect the fuel pump the machine is equipped with a fuel filter. Check this filter regularly for impurities and clean if necessary.

Check the tank for impurities on a regular basis. Clean the tank when necessary. Empty the fuel tank using the drainage screw at the bottom of the tank. Clean tank and fuel pipes thoroughly. Screw drainage screw back in.



Detergent and dirty fuel must be disposed of responsibly.

■ Adjusting ignition electrodes:

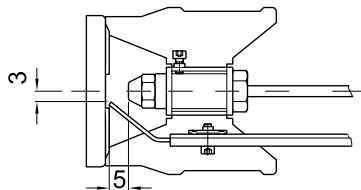
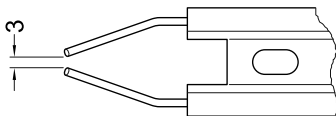

For a smooth ignition, the setting of the ignition electrode must be controlled regularly (after 500 operating hours at the latest).

26 Particular rules, directives and inspections

■ Inspections performed by Kränzle

- measurement of earth line resistance
- measurement of voltage and current
- inspection of tension consistency with +/- 1530 V
- pressure check of heating coil at 300 bar
- visual and functional check as per the inspection sheet provided
- exhaust fume analysis (see test strips provided)

■ Guidelines for liquid sprayers

The machine conforms with the "Guidelines for liquid sprayers". These guidelines are issued by the organisation of trade associations and may be obtained from Carl Heymann-Verlag KG, Luxemburger Str. 49, 50939 Köln. These guidelines specify that this machine is to be inspected by qualified personnel whenever necessary, but no less than once every 12 months. These inspections must be recorded in the inspection log at the end of this manual.

■ Pressure container and steam boiler directives

Kränzle high pressure cleaning equipment conforms to the pressure container and steam boiler directive. No construction approval, notification of licence and takeover inspection are required. The water capacity is less than 10 l.

■ Duties of owner

The owner is to ensure that all safety-relevant components are in a serviceable condition before the sprayer is used. (e.g., safety valves, hose and electric cables, spray equipment etc).

■ Emission control legislation

With stationary installation, the emission levels of the machine must be checked once a year by a qualified organisation or person according to German law. The first inspection must be carried out four weeks after the machine is commissioned. The owner is responsible for having the inspection performed.

Pipeline plan

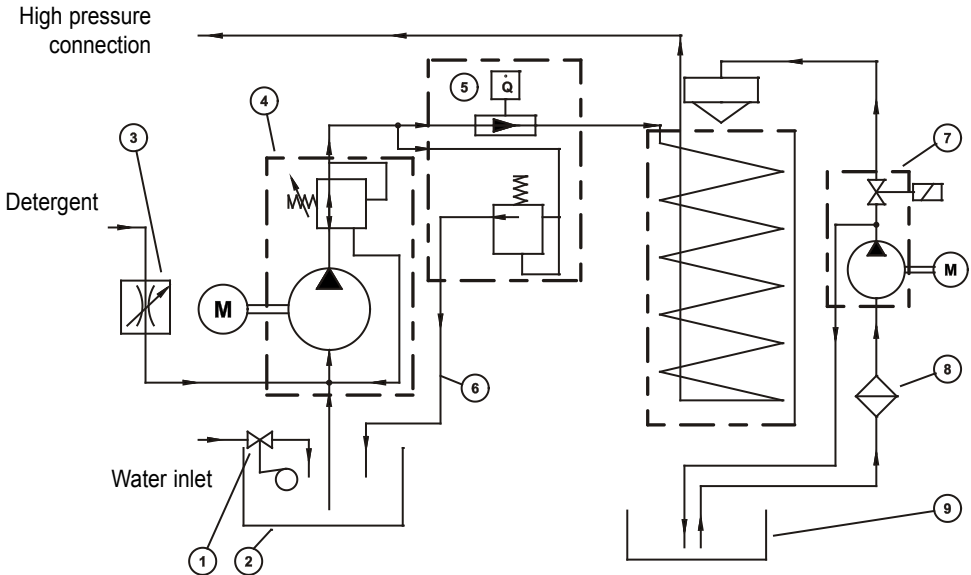

Safety valve, number 5 must be set approx. 15 % higher than the unloader valve on the HP pump.

- 1 Float valve, water inlet
- 2 Water tank
- 3 Control valve detergent
- 4 High pressure pump with integrated unloader valve
- 5 Flow-Safety-Block with integrated safety valve for heating coil and flow monitoring device
- 6 By-Pass line
- 7 Fuel pump with solenoid valve
- 8 Fuel filter
- 9 Fuel tank

30 Troubleshooting

Malfunction Cause of malfunction / remedy

Water supply

Water tank runs over. Float valve is dirty or defect.

Water tank does not fill completely. Float valve is defect. Water filter is dirty. Insufficient water inlet quantity.

Pump does not suck. Valves stick or are dirty. Suction hose leaks. Chemistry valve is open or leaks. Check hose clips (connections). High-pressure nozzle is clogged.

Test: check water and chemical system for tightness. Connect water inlet directly to the pump (2-4 bar pre-pressure). Disconnect suction lines below the pump

High-pressure pump

Pump makes loud noises. Operating pressure is not reached. Pump sucks air. Check suction connections. Check high-pressure nozzle. Check valves. Check O-rings under valves. Check sleeves. Manometer is defect. Unloader: check stainless steel seat and ball. Check seals on the control piston.

Water drops from the pump. Replace sleeves in the pump. Replace O-rings.

Oil drops from the transmission. Check oil seals (replace). Check plunger and plunger guides. Check water supply, since water deficiency or air suction can cause damage to seals and O-rings (chemistry valve leaks?)

Pressure is too low. Worn high pressure nozzle. Stainless steel seat, ball, O-ring in unloader is dirty or defect. Manometer is defect.

Machine does not switch off Check return body and O-ring in unloader of the valve housing.

Test: Bridge pressure switch (red) Check pressure switch (red). Check micro switch. Check cable connections. Board is defect.

Appliance does not start or stops during operation Check electricity supply. Check main switch. Check cable connections. Check board. Check pressure switch. Switch off by overcurrent release.

Troubleshooting

Displayed malfunctions

DISPLAY		Cause	Action
TARGET	ACTUAL		
Err	OFF	Water temperature at heating chamber outlet above 147 °C	Operate appliance without heating „Heating OFF“ until the temperature has dropped below 147°C. Switch main switch „OFF“ and then back „ON“ again.
AUS	E7	Appliance has not been operated for more than 20 minutes -> Safety cut-off	Switch main switch „OFF“ and then back „ON“ again.
Err	E2	Temperature sensor defective	Replace temperature sensor
FLA	E8	Warning Flame monitoring; No combustion was detected by the flame sensor after 2s	Check flame sensor; Check combustion system Switch main switch „OFF“ and then back „ON“ again.
OIL	Actual value	Brennstoffstand im Tank ist zu niedrig	Refill fuel (Heating oil EL)
UES	Actual value	Overload protection of motor High pressure pump is actuated	Check energy supply, Remove extension cord, Nozzle clogged? Use master switch „AUS“ / „EIN“ to switch off or on.

■ Excess temperature release

As an additional safety device the appliance is equipped with an excess temperature sensor inside the chimney. Should the safety devices as e.g. the float monitoring device be defective and the burner continues to heat although the heating coil does not conduct away heat a destruction of the heating coil would be inevitable. As soon as the temperature inside the chimney exceeds 260 °C the excess temperature release triggers and cuts out the appliance.

The display of the excess temperature release is located on the back of the switchbox inside the appliance.

RED: Excess temperature released, let appliance cool down, no hot water operation possible

YELLOW: Appliance cooled down, activation of hot water operation possible by pressing the **RESET**-button

Überhitzung / Overheating

 Heißwasserbetrieb erst nach Abkühlung möglich.
Hot-water operation only possible after cooling down phase.

 Gerät abgekühlt, Heißwasserbetrieb nach RESET wieder möglich.
Machine cooled down, hot-water operation possible after RESET.

 **Bei Überhitzung Kundendienst rufen**
In case of overheating call customer service





ATTENTION !!!

Immediately contact service in case of recurrence

32 Troubleshooting

Hot water mode

The fuel manometer shows the fuel pressure.

If no pressure is shown, check if

- there is heating oil in the tank.
- the fuse in the electric box (below the operating panel) for the motor has blown.
- the fuel sieve or the fuel sieve in the pump is dirty.
- the fuel pump does not operate smoothly or is blocked.
- the ventilator jams.

The thermostat grants permission to open the solenoid valve. The burner starts and heats the water to the temperature preset by you. As soon as the temperature is reached the burner switches off.

If the temperature drops again, the burner switches on automatically, so that the desired temperature is constantly kept.

The thermostat is controlled by a thermosensor, mounted to the outlet of the heating coil.

In the electro distributor box (below the operating panel), there is a fuse (Circuit diagramme, F1) on the PCB which protects the motor for fuel pump and ventilator. If the motor is overloaded, the fuse blows. This can happen when the fuel pump is blocked or does not work freely, when the ventilator is blocked or does not operate freely or when there is an electrical problem.

A second fuse (Circuit diagramme, F2) on the PCB triggers, if the ignition transformer is faulty.

The transformer on the PCB is protected by two fuses (32 mA, 630 mA).

To avoid an overheating of the combustion chamber, a flow monitoring device is installed between high-pressure pump and combustion chamber, which only permits fuel injection if water is running through the heating coil at the same time.

Troubleshooting

Malfunction Cause of malfunction / remedy

Heating (burner)

Fuel pump/blower operates, but burner does not heat.

Set water temperature is reached. Increase temperature on thermostat with rotary control switch. Open gun, until temperature drops. Fuel tank is empty. Fuel filter is dirty. Fuel nozzle is dirty.

Fuel pump/blower does not operate.

Coupling between burner motor and fuel pump is defect. Blower/fuel pump motor is defect. Check electrical equipment. Check fuse in electric box. Water in fuel tank.

- Pump makes loud noises
Fuel operating press. is not reached

Dirt or rust in the fuel pump. Clean tank. Replace fuel pump.

Smoke during operation.
Smoke after switching off.

Fuel is dirty. Nozzle or nozzle stock leaks. Water in tank.

Solenoid valve on the fuel pump does not open

Test: Pressure switch (black)
Bridge in terminal box between terminal 3 +4

Check pressure switch (black). Solenoid valve is defect or dirty. Clean filter, clean supply line, clean

Test: Connect solenoid valve 230 V externally.

fuel pump. Setting is wrong. Clean fuel nozzle, or replace it.

Oil pressure on the fuel pump is too low/too high.

Ignition does not function.

Check ignition cable. Charring of plug-in contacts by moisture. Cable is broken. Check ignition transformer connections. Transformer is defect. Ignition electrode has been falsely set or burnt up.

Ventilator does not operate.

Blower-/fuel pump motor is defect. Check electrical equipment. Check fuse in terminal box. Coupling between burner motor and fuel pump is defect.

Leakage

Gun drips. High pressure hose drips.

Clean nozzle. Replace seals.
Replace O-ring under screwed connection.

Manometer shows pressure but no water comes out.

Clean nozzle.

Sucking detergent

Detergent is not sucked.

Pump sucks air. Check hose clips.

Test: Connect water line to the pump. Water inlet: 2 - 8 bar pre-pressure. No water must come from the detergent hose.

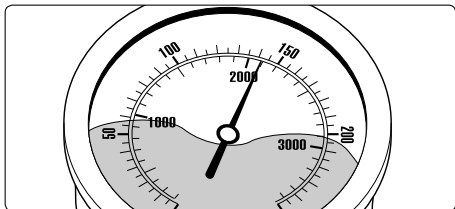
34 Small repairs do it yourself

■ **No water from the nozzle but the gauge shows full pressure: Most likely the nozzle is blocked.**

(Inside the pressure gauge there is no water but a filling with glycerin to damp the vibration of the pointer.)

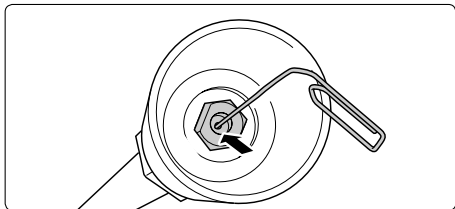
**Proceeding:**

Switch off the cleaner. Pull plug from the socket.

Operate gun several times to decrease the pressure. First unscrew gun and lance, then rinse hose from any residues.

Check water inlet filter for soiling. If the problem still exists, take wire (paper clip) and push cautiously through nozzle opening.

If this procedure is not successful, the nozzle has to be dismantled and cleaned (from the backside) or even replaced, if necessary.

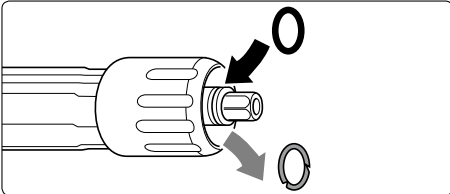
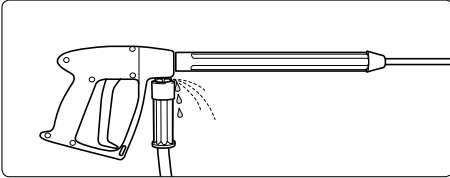
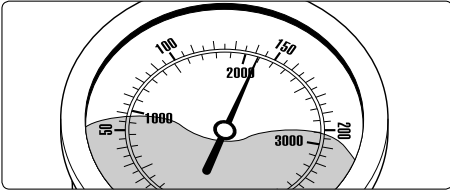

■ The pressure gauge shows full pressure although the gun has been closed. The pressure switch valve switches constantly.

Possible cause no.1: Leakage

Having closed the gun, the HP cleaner must shut down and the pressure gauge must show „0“ bar. If the pressure gauge still shows full pressure and the motor constantly switches on and off, the possible reason for this can be a leakage of the pump, the HP hose or the lance.

Proceeding:

Check the connections from the HP cleaner to the HP hose, from the hose to the gun and also the connection between lance and gun for tightness. Switch off the cleaner. Shortly press the trigger of the gun to decrease the pressure. Unscrew HP hose, gun and lance and check the O-rings. If the O-rings are damaged they have to be replaced.

In case of a leakage there is no guarantee for possible consequential damages.

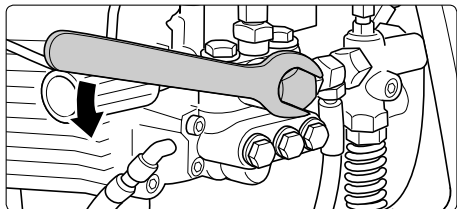

Possible cause no. 2:
The non-return valve is soiled or defective

Proceeding:
Unscrew pump outlet.

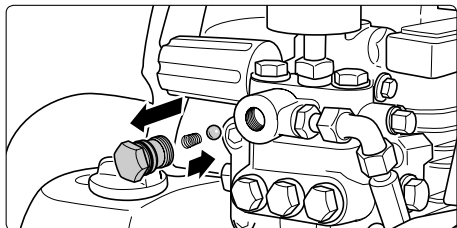

Take out non-return valve body and check for soiling or damage of the O-ring.

Replace non-return valve if necessary.

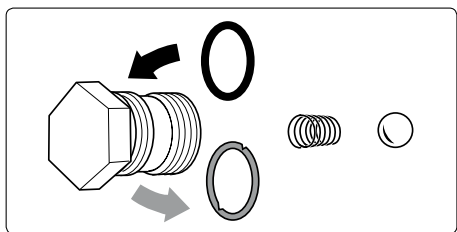

There is no guarantee if the pump is damaged by defective O-rings due to air induction or lack of water (cavitation).

Small repairs do it yourself

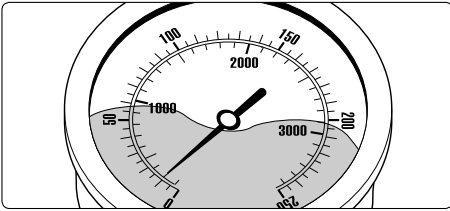

■ Pressure gauge shows little pressure, the water from the nozzle comes in squirts, The high-pressure hose vibrates. Most likely the valves are soiled.

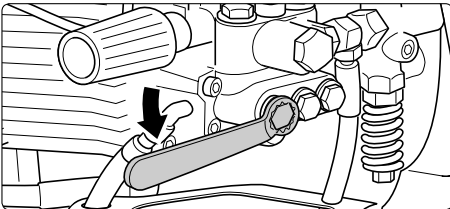

Proceeding:
Unscrew all 6 valves, one after the other (hexagonal brass screws, 3 in a row, vertically and horizontally)

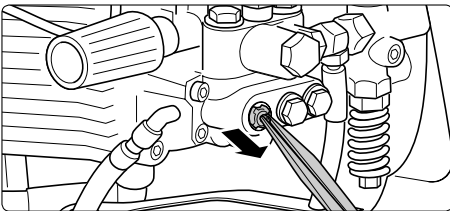

Take out valve body (with green or red plastic coating) and O-ring by means of needle nose pliers. Check O-ring for damage. In case of a damage the O-ring has to be replaced.

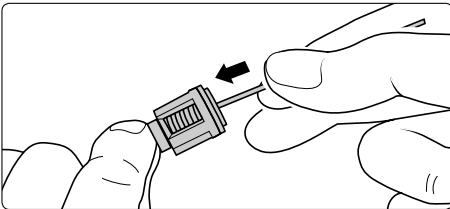

Take a wire (paper clip) and clean valves under running water. Also clean valve seating inside the pump.

Do not forget the O-ring during reassembly!

38 Inspection report for HP cleaners

Inspection report on annually carried out Labour Safety Inspection (UVV) according to the Guidelines for Liquid Spray Equipment. (This inspection sheet serves as proof for the completion of the retest and must be kept carefully!) Kränzle-Test Stamp Mark: Order Number UVV200106

Owner: Type therm:
 Address: Serial no.:
 Rep.-order-no.:

Scope of inspection:	ok	yes	no	repaired
Type plate (on hand)				
Operating manual (on hand)				
Protective covering, -device				
Pressure line (tightness)				
Pressure gauge (function)				
Float valve (tightness)				
Spraying device (marking)				
HP-hose/ connector (damage, marking)				
Safety valve opens at 10% / 20% excess				
Pressure reservoir				
Heating oil line (tightness)				
Solenoid valve (function)				
Thermostat (function)				
Flow controller (function)				
Power cable (damage)				
Power plug (damage)				
Protective conductor (connected)				
Emergency Off Switch (function)				
On/Off-switch				
Water quantity safety device (function)				
Used chemicals				
Allowed chemicals				

Inspection data	determ. value	set value
High-pressure nozzle		
Operating pressurebar		
Cutting-off pressure.....bar		
Smoke spot number.....acc. to Bacharach scale		
CO ² -value.....% CO ²		
Efficiency rating.....%		
Conductor resist. not exceeded / value:		
Insulation		
Leakage current:		
Gun locked		

Inspection result (tick)

- The appliance was checked by an expert according to the Guidelines for Liquid Spray Equipment, the defects found have been rectified so that the Labour Safety can be confirmed.
- The appliance was checked by an expert according to the Guidelines for Liquid Spray Equipment. The Labour Safety cannot be confirmed unless the defects found are rectified by repair or replacement of the faulty parts.
- The next retest according to the Guidelines for Liquid Spray Equipment has to be carried out by: Month Year

Place, Date Signature

Inspection report for HP cleaners

Inspection report on annually carried out Labour Safety Inspection (UVV) according to the Guidelines for Liquid Spray Equipment. (This inspection sheet serves as proof for the completion of the retest and must be kept carefully!) Kränzle-Test Stamp Mark: Order Number UVV200106

Owner: Type **therm**:
 Address: Serial no.:
 Rep.-order-no.:

Scope of inspection:	ok	yes	no	repaired
Type plate (on hand)				
Operating manual (on hand)				
Protective covering, -device				
Pressure line (tightness)				
Pressure gauge (function)				
Float valve (tightness)				
Spraying device (marking)				
HP-hose/ connector (damage, marking)				
Safety valve opens at 10% / 20% excess				
Pressure reservoir				
Heating oil line (tightness)				
Solenoid valve (function)				
Thermostat (function)				
Flow controller (function)				
Power cable (damage)				
Power plug (damage)				
Protective conductor (connected)				
Emergency Off Switch (function)				
On/Off-switch				
Water quantity safety device (function)				
Used chemicals				
Allowed chemicals				

Inspection data	determ. value	set value
High-pressure nozzle		
Operating pressurebar		
Cutting-off pressure.....bar		
Smoke spot number.....acc. to Bacharach scale		
CO ² -value.....% CO ²		
Efficiency rating.....%		
Conductor resist. not exceeded / value:		
Insulation		
Leakage current:		
Gun locked		

Inspection result (tick)

- The appliance was checked by an expert according to the Guidelines for Liquid Spray Equipment, the defects found have been rectified so that the Labour Safety can be confirmed.
- The appliance was checked by an expert according to the Guidelines for Liquid Spray Equipment. The Labour Safety cannot be confirmed unless the defects found are rectified by repair or replacement of the faulty parts.
 The next retest according to the Guidelines for Liquid Spray Equipment has to be carried out by: Month Year

Place, Date Signature

EC declaration of conformity

Hereby we declare that:	Kränzle therm 895-1, 1165-1
technical specifications available from:	Manfred Bauer, Fa. Josef Kränzle Rudolf-Diesel-Str. 20, 89257 Illertissen
Nominal flow	K therm 635-1: 635 l/h K therm 875-1: 875 l/h K therm 895-1: 895 l/h K therm 1165-1: 1165 l/h K therm 1525-1: 1525 l/h
comply with the following guidelines and their amendments for high-pressure cleaners:	machinery directive 2006/42/EEC, EMV-directive 2004/108/EEC, noise directive 2005/88/EC, Art. 13, HP water spraying machines annex 3, part B, chapter 27
Sound level measured:	89 dB (A)
Sound level guaranteed:	91 dB (A)
Applied conformity evaluation procedures	annex V, noise directive 2005/88/EC
Applied specifications and standards	EN 60 335-2-79 :2009 EN 55 014-1 :2006 EN 55 014-2 / A2:2008 EN 61 000-3-2 : 2006 EN 61 000-3-3 : 2008
I. Kränzle GmbH Elpke 97 D - 33605 Bielefeld	
Bielefeld, den 03.09.2012	Kränzle Josef (Managing director)

Guarantee

■ The guarantee is only valid for material and manufacturing errors. Wearing does not fall within this guarantee.

The instructions in our operating manual must be complied with.. The operating instructions form part of the guarantee. The Guarantee is void if other parts are used than genuine Kränzle accessory parts or genuine Kränzle spare parts.

For high-pressure cleaners sold to the user the guarantee period is **24 month**.
For high-pressure cleaners sold for industrial use the guarantee period is **12 month**.

In the case of a guarantee please contact your dealer or authorized seller delivering accessories and your purchase receipt. You can find them in the internet under **www.kraenzle.com**.

The guarantee is also void if the machine is used with exceeding the temperature and speed limits, a voltage below the required rating, with less than the required amount of water or with dirty water.

Pressure gauge, nozzle, valves, sleeves, high pressure hose and spray equipment are wear parts and are not covered by the warranty.

Customer

- All lines connected
- Hose clamps tight
- Screws all installed and tightened
- Ignition cable plugged in
- Visual check carried out
- Brake function checked

Leak test

- Water tank filled and checked
- Water inlet checked for tightness
- Float valve function checked
- Machine checked for tightness under pressure

Electrical check

- Earth line checked

Current intake

- Operating pressure
- Switch-off pressure

- Steam phase checked
- Chemical valve checked
- Start/Stop automatic and re-run delay checked
- Fuel shortage switch checked
- Thermostat function checked
- Burner function checked

Water inlet temperature

°C

Water outlet temperature

°C

Fuel pressure bar

bar

Measured smoke spot number

Result of flue gas analysis

Safety equipment sealed with lacquer

The appliance fulfills all requirements according to this inspection sheet

Name of inspector

Date

Signature

**Kränzle - world-wide:
Technical perfection at its best.**

kränzle®

w w w . k r ä n z l e . c o m



**I. Kränzle GmbH
Elpke 97
D - 33605 Bielefeld**

Reprint only allowed with the authorization of Kränzle.

As date of 03.09.2012

Subject to technical modifications. Order no. 30.768 0