

Furrion Aurora™ TV Series

Instruction Manual



*Product picture is for reference only.

Model: FDUP43CBR / FDUP49CBR / FDUF55CBR / FDUP65CBR
FDUF43CBR / FDUF49CBR / FDUP55CBR / FDUF65CBR

Welcome

Thank you and congratulations for purchasing this Furrion Aurora™ TV. Before placing your new appliance into operation, please read these operating instructions carefully. This instruction manual contains important information for safe use, installation and maintenance of the appliance.

The manufacturer does not accept responsibility for any damages that may arise due to non-observation of these instructions.

If you have any further questions regarding our products, please contact us at **support@furrion.com**

Supplier's Declaration of Conformity

47 CFR § 2.1077 Compliance Information

Unique Identifier

Trade Name: Furrion

Model No.: FDUP43CBR, FDUP49CBR, FDUF55CBR, FDUP65CBR,
FDUF43CBR, FDUF49CBR, FDUP55CBR, FDUF65CBR

Responsible Party – U.S. Contact Information

Furrion Innovation Center & Institute of Technology
52567 Independence Ct., Elkhart, IN 46514, USA
Toll free:1-888-354-5792; Email: support@furrion.com

FCC Compliance Statement

This device complies with Part 15 of the FCC Rules. Operation is subject to the following two conditions: (1) This device may not cause harmful interference, and (2) this device must accept any interference received, including interference that may cause undesired operation.

Contents

Welcome	2
Contents	3
Safety Warnings	4
Function Overview	8
Control Panel	8
Rear Panel	9
Connection	10
Remote Control	12
Before Operation	14
What's in the Box	14
Prepare your Remote Control	14
Choose a Proper Location for your TV	15
Cable Management	15
Mount on Wall	17
Getting Started	18
TV Settings	19
Setup Settings	19
Picture Settings	22
Audio Settings	23
Time Settings	25
Lock Settings	26
Channel Settings	29
PC Settings	30
USB Operation	31
Troubleshooting	32
Specifications	33
Care and Clean	34

Safety Warnings



CAUTION

RISK OF ELECTRIC SHOCK
DO NOT OPEN



CAUTION: TO REDUCE THE RISK OF ELECTRIC SHOCK, DO NOT REMOVE COVER (OR BACK). NO USER-SERVICEABLE PARTS INSIDE. REFER SERVICING TO QUALIFIED SERVICE PERSONNEL.

WARNING: TO REDUCE THE RISK OF FIRE OR ELECTRIC SHOCK, DO NOT EXPOSE THIS APPARATUS TO RAIN OR MOISTURE.



This 'bolt of lightning' indicates uninsulated material within your unit which may cause an electric shock. For the safety of everyone in your household, please do not remove product covering.



The 'exclamation mark' calls attention to features within the enclosed literature to prevent operating and maintenance problems.

Important Safety Instructions

1. Read these instructions.
2. Keep these instructions.
3. Heed all warnings.
4. Follow all instructions.
5. Clean only with dry cloth.
6. Do not block any ventilation openings. Install in accordance with the manufacturer's instructions.
7. Do not install near any heat sources such as radiators, heat registers, stoves, or other apparatus (including amplifiers) that produce heat.
8. Do not mount this TV near a motor or transformer where strong magnetism is generated. Images on the television will become distorted and the colour irregular.
9. Do not defeat the safety purpose of the polarized or grounding-type plug. A polarized plug has two blades with one wider than the other. A grounding type plug has two blades and a third grounding prong. The wide blade or the third prong are provided for your safety. When the provided plug does not fit into your outlet, consult an electrician for replacement of the obsolete outlet.
10. Protect the power cord from being walked on or pinched, particularly at plugs, convenience receptacles, and the point where they exit from the apparatus.
11. Only use attachments/accessories specified by the manufacturer.
12. Do not place the product on an unstable cart, stand, tripod, table, or anywhere the unit is not permanently installed. Placing the product on an unstable place can cause the product to fall, resulting in potential serious personal injuries, as well as damage to the product.
13. Use only with a cart, stand, tripod, bracket or table specified by the manufacturer or sold with the apparatus. When a cart is used, use caution when moving the cart/apparatus to avoid injury from tip-over. 
14. Unplug this apparatus during lightning storms or when unused for long periods of time.
15. Do not touch this apparatus or antenna during a thunder or lightning storm.
16. Refer all servicing to qualified service personnel. Servicing is required when the apparatus has been damaged in any way, such as if the power-supply cord or plug is damaged, liquid has been spilled or objects have fallen into the apparatus, or when the apparatus has been exposed to rain or moisture, does not operate normally, or has been dropped.
17. Naked flame sources such as lit candles, should not be placed on apparatus.
18. Do not overload wall outlets, extension cords, or integral convenience receptacles as this can result in a risk of fire or electric shock.
19. The power cord must be routed properly to prevent people from stepping on it, or objects from resting on it. Check the cords at the plugs and product.
20. Never push objects of any kind into this product through openings as they may touch short-out parts or dangerous voltage points that could result in a fire or electric shock.
21. If an outside antenna is connected to the television equipment, be sure the antenna system is grounded so as to provide some

Safety Warnings

protection against voltage surges and built up static charges. Section 810 of the National Electrical Code provides information with respect to proper grounding of the mast and supporting structure, grounding of the lead-in wire to an antenna discharge unit, size of grounding conductors, location of antenna discharge unit, connection to grounding electrodes, and requirements for the grounding electrodes.

22. An outside antenna system should not be located in the vicinity of overhead power lines or other electrical light or power circuits, or where it can fall into such power lines or circuits. When installing an outside antenna system, extreme care should be taken to keep from touching such power lines or circuits as contact with them might be fatal.

EXAMPLE OF ANTENNA GROUNDING AS PER THE NATIONAL ELECTRICAL CODE

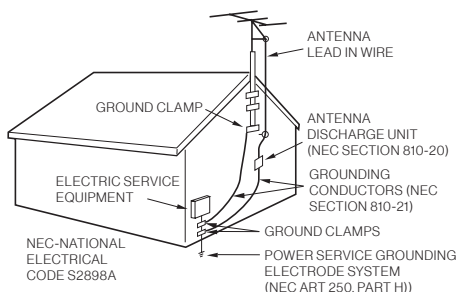

23. NOTE TO CABLE/TV INSTALLER: This reminder is provided to call the CATV system installer's attention to Article 820-40 of the National Electric Code (U.S.A.). The code provides guidelines for proper grounding and, in particular, specifies that the cable ground shall be connected to the grounding system of the building, as close to the point of the cable entry as practical.
24. When replacement parts are required, be sure the service technician uses replacement parts specified by the manufacturer or those that have the same characteristics as the original part. Unauthorized substitutions may result in fire, electric shock or other hazards.
25. Upon completion of any service or repairs to this unit, ask the service technician to perform safety checks to determine that the unit is in proper operating condition.
26. When you connect the product to other equipment, turn off the power and unplug from the wall outlet. Failure to do so may cause an electric shock and serious personal injury. Read the owner's manual of the other equipment carefully and follow the instructions when making any connections.
27. The socket-outlet must be installed near the unit and easily accessible.
28. Where the mains plug is used as the disconnect device, the disconnect device shall remain readily operable.
29. Never remove the back cover of the TV as this can expose you to very high voltages and other hazards. If the TV does not operate properly, unplug the TV and call your authorized dealer or service center. Adjust only those controls that are covered in the instructions, as improper changes or modifications not expressly approved by Furriion could void the user's warranty.
30. Do not submerge this TV in water or pressure wash it. It is not designed to be submerged in water, withstand pressure washers, high-pressure water jets, or hurricane-type weather.
31. Cleaning : With your TV turned off, gently wipe the surface of the display panel with a damp (with water) microfiber, cotton or flannel cloth. (Do not use tissues, rags, sponges or paper towels because they may damage the screen and leave lint pieces behind). Remove any dirt and salt deposits from the unit, being careful to rinse the cloth frequently to avoid scratching the TV or screen surface. Avoid using harsh chemicals, abrasives, or solvents when cleaning any surface on the unit.
32. The operation temperature for the unit is -20°C (-4°F) to $+50^{\circ}\text{C}$ ($+122^{\circ}\text{F}$) . The storage temperature is -33°C (-27.4°F) to $+58^{\circ}\text{C}$ ($+136.4^{\circ}\text{F}$). Protect the TV from damage by the extreme temperature. This is not a commercial TV.
33. Batteries (battery pack or batteries installed) shall not be exposed to excessive heat such as sunshine, fire or the like.
34. The apparatus should be connected to a mains socket outlet with a protective earthing connection.
35. To prevent injury, this apparatus must be securely attached to the wall in accordance with the installation instructions.

Safety Warnings

HOW TO HANDLE THE LED PANEL

- Do not press hard or jolt the LED panel. It may cause the LED panel glass to break and injury may occur.
- If the LED panel is broken, make absolutely sure that you do not touch the liquid in the panel. This may cause skin inflammation.
- If the liquid gets in your mouth, immediately rinse and consult with your doctor. Also, if the liquid gets in your eyes or touches your skin, consult your doctor after rinsing for at least 15 minutes in clean water.

Possible Adverse Effects on LED Panel: If

a fixed image displays on the TV screen for a long period of time, it may cause a permanent disfigurement on the screen with image burn-in or ghosting. This type of damage is NOT COVERED BY THE WARRANTY.

- Avoid displaying a static picture or a picture with static elements (black bars, black borders, logos, etc.) on the TV screen for more than two hours at a time. Make sure you change the image on your screen periodically.
- If the aspect ratio of the TV is set to 4:3 for a long period of time, image burn may occur on the letterboxed area of the screen. Make sure you change the size of the picture occasionally.

The following symptoms are not signs of malfunction but technical limitation. Therefore we disclaim any responsibility for these symptoms.

- LED panels are manufactured using an extremely high level of precision technology, however sometimes parts of the screen may be missing picture elements or have luminous spots. This is not a sign of a malfunction.
- Do not install the LED panel near electronic equipment that produces electromagnetic waves. Some equipment placed too close to LED may cause interference.
- Effect on infrared devices – There may be interference while using infrared devices such as infrared cordless headphones.

COMPLIANCE

FCC Statement

Note: This equipment has been tested and found to comply with the limits for a Class B digital device, pursuant to Part 15 of the FCC Rules. These limits are designed to provide reasonable protection against harmful interference in a

residential installation. This equipment generates, uses and can radiate radio frequency energy and, if not installed and used in accordance with the instructions, may cause harmful interference to radio communications.

However, there is no guarantee that interference will not occur in a particular installation. If this equipment does cause harmful interference to radio or television reception, which can be determined by turning the equipment off and on, the user is encouraged to try to correct the interference by one or more of the following measures:

- Reorient or relocate the receiving antenna.
- Increase the separation between the equipment and receiver.
- Connect the equipment into an outlet on a circuit different from that to which the receiver is connected.
- Consult the dealer or an experienced radio/TV technician for help.

WARNING: Changes or modifications to this unit not expressly approved by the party responsible for compliance could void the user's authority to operate this equipment under FCC Rules.

This device complies with part 15 of the FCC Rules. Operation is subject to the following two conditions:

1. This device may not cause harmful interference.
2. This device must accept any interference received, including interference that may cause undesired operation.

POWER SOURCE

This TV is designed to operate on 100-240 volt 50/60 Hz, AC current. Connect the power cord to a GFCI protected AC outlet with an "in-use" waterproof cover.

Warning: TV and GFCI receptacle must be installed away from any water source in a safety distance. Be sure to check local electrical codes and comply with their local standards.

To reduce the risk of fire or electric shock, do not expose this apparatus to rain or moisture.

Safety Warnings

CARE OF THE ENVIRONMENT

Disposal of your old product and battery



Your product is designed and manufactured with high quality materials and components, which can be recycled and reused.

- Never dispose of your product with other household waste. Please familiarize yourself with the local rules on the separate collection of electrical and electronic products and batteries.
- The correct disposal of these products helps prevent potentially negative consequences on the environment and human health.
- Your product contains batteries which cannot be disposed of with normal household waste. The battery must be recycled or disposed of properly. Contact your local waste management office for information on battery recycling or disposal.

All registered and unregistered trademarks are property of their respective owners.

CAUTION: Changes or modifications not expressly approved by the party responsible for compliance could void the user's authority to operate the equipment.

SAFETY PRECAUTIONS

WARNING: Never place a television set in an unstable location. A television set may fall, causing serious personal injury or death. Many injuries, particularly to children, can be avoided by taking simple precautions such as:

- Using cabinets or stands recommended by the manufacturer of the television set.
- Only using furniture that can safely support the television set.
- Ensuring the television set is not overhanging the edge of the supporting furniture.
- Not placing the television set on tall furniture (for example, cupboards or bookcases) without anchoring both the furniture and the television set to a suitable support.
- Not placing the television set on cloth or other materials that may be located between the television set and supporting furniture.
- Educating children about the dangers of climbing on furniture to reach the television set or its controls.

If your existing television set is being retained and relocated, the same considerations as above should be applied.

NOTES WHEN MOUNTING THE TV ON THE WALL

IMPORTANT: The TV must be installed away from any water source in a safe distance.

If the unit is to be mounted on the wall, contact the retailer where you purchased the TV for advice, and have the equipment professionally installed. Incomplete or improper installation may cause injury to you, and/or damage to the TV. Please refer to the VESA mounting pattern to ensure the correct VESA mounting is used for the TV.

VESA MOUNTING PATTERN

Model	Width mm	Height mm	Screw Size	Quantity
FDUP43CBR	200	200	M6 * 15mm	4
FDUF43CBR	200	200		
FDUP49CBR	200	400		
FDUF49CBR	200	400		
FDUP55CBR	400	400		
FDUF55CBR	400	400		
FDUP65CBR	400	400		
FDUF65CBR	400	400		

CAUTION: To prevent personal injury and/or damage to the TV or personal property, use at least two people to install or move the TV.

Function Overview

Control Panel

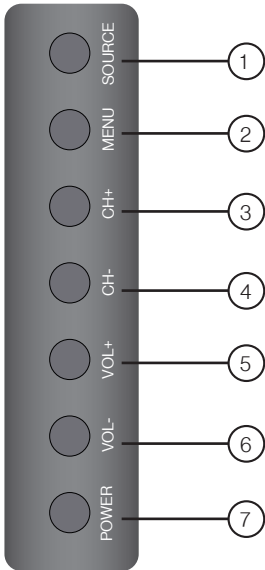

Item	Button	Function
①	SOURCE	Select the input source
②	MENU	Enter the main menu
③	CH+	Skip to the next channel
④	CH-	Skip to the previous channel
⑤	VOL+	Increase volume
⑥	VOL-	Decrease volume
⑦	POWER	Switch the TV on/off

* Please note that the button layout of the controls may vary from model to model.

Function Overview

Rear Panel

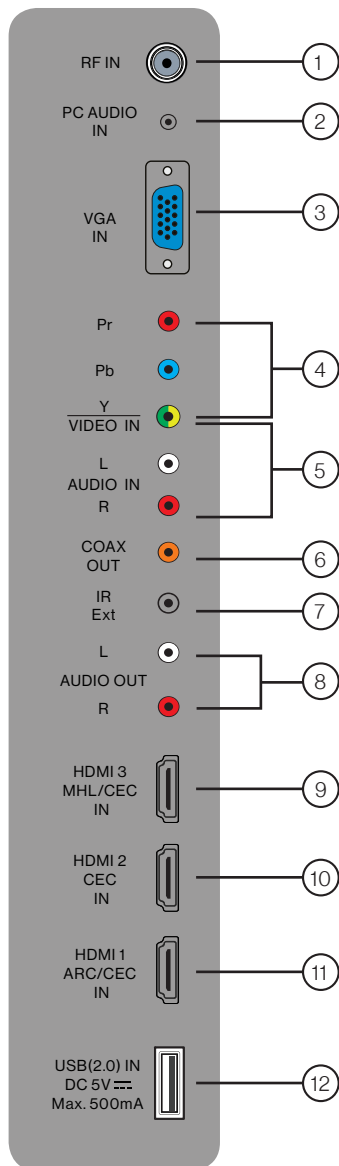

* The configuration of the connection ports may vary from model to model.

No.	I/O port	Description
①	RF IN	Connect to the ANTENNA, CABLE or CABLE BOX .
②	PC AUDIO IN	Connect to the AUDIO OUT port of a PC.
③	VGA IN	Connect to the VGA OUT port of a PC to use the TV as a monitor.
④	Y/Pb/Pr	Connect to the COMPONENT VIDEO OUT ports of a DVD Player, Cable Box or other compatible devices.
⑤	VIDEO IN AUDIO IN (L-R)	Connect to the COMPOSITE VIDEO/AUDIO OUT ports of a DVD Player, Cable Box or other compatible devices.
⑥	COAX OUT	Connect to the COAXIAL AUDIO IN port of an audio device.
⑦	IR Ext	Connect with an IR extender . Note: Please purchase an IR extender with the spec as below: 3.5 mini plug/Tip-VCC 5V/Center-Data/Lower-Ground; With 30ft range from remote control to IR receiver; Operating voltage 3.3-5v and supported by 38Khz bandwidth.
⑧	AUDIO OUT (L-R)	Connect to the AUDIO IN ports of an audio device.
⑨	HDMI 3 IN (MHL/CEC)	Connect to the HDMI OUT port of a DVD Player, Games Console, Cable Box or other HDMI device. MHL (Mobile High-Definition Link) You can connect an MHL-enabled device, such as certain models of smart phones & tablets, and view the device's screen on the TV. Connecting an MHL-enabled device to the HDMI3 input requires a special MHL cable (not included).
⑩	HDMI 2 IN (CEC)	CEC (Consumer Electronics Control) When connected to the CEC compatible Furriion Entertainment Systems or other CEC Compatible devices, the TV links with the system to give extra functionality.
⑪	HDMI 1 IN (ARC/CEC)	ARC (Audio Return Channel) When connected with a HDMI 1.4 cable to an ARC compatible audio system, the TV links with the device to give extra audio functionality.
⑫	USB IN	USB Port: view pictures/movies/text and listen to MP3s via a compatible USB stick.

Function Overview

Connection

Your Furrion Aurora™ TV offers multiple connection options. Please consult the manual of DVD player, Games Console or other devices to ensure proper connection and use.

You can choose one or more of the connections below to operate.

Note: All external devices and cables shown in the diagram are for reference only and not included in the package.

A

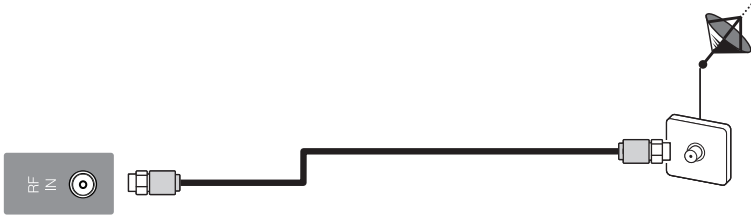

B

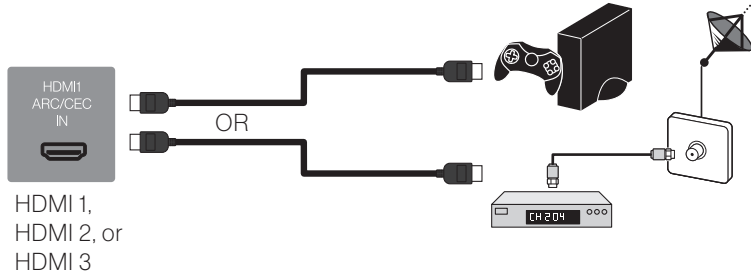

C

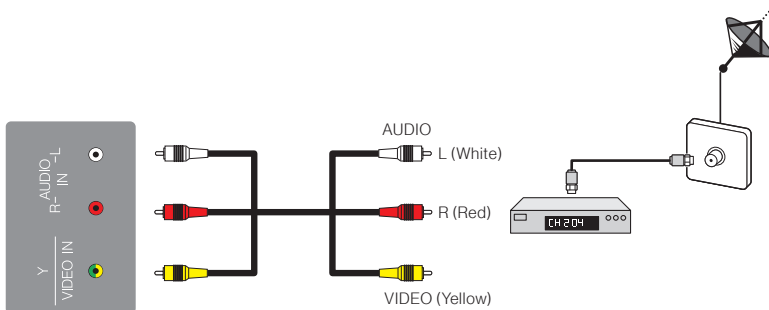

Function Overview

Connection

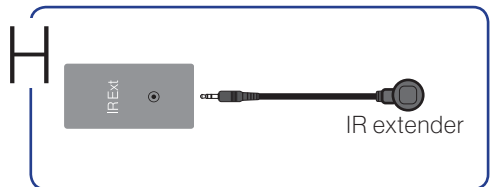
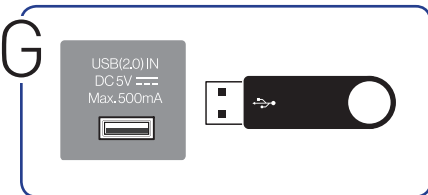
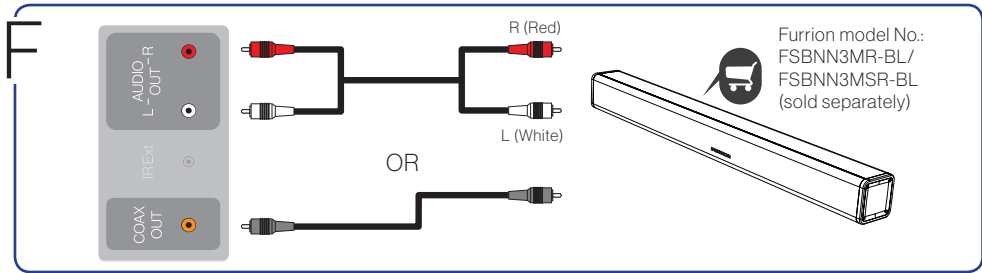
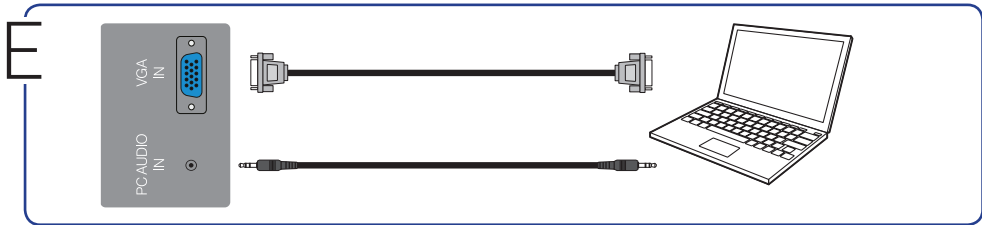
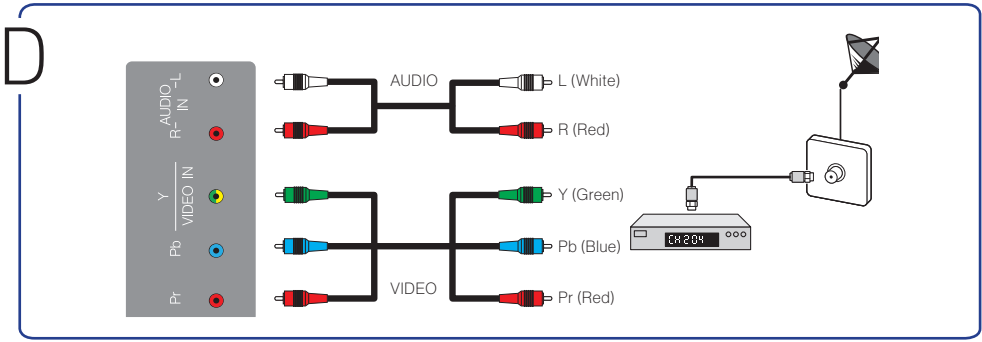





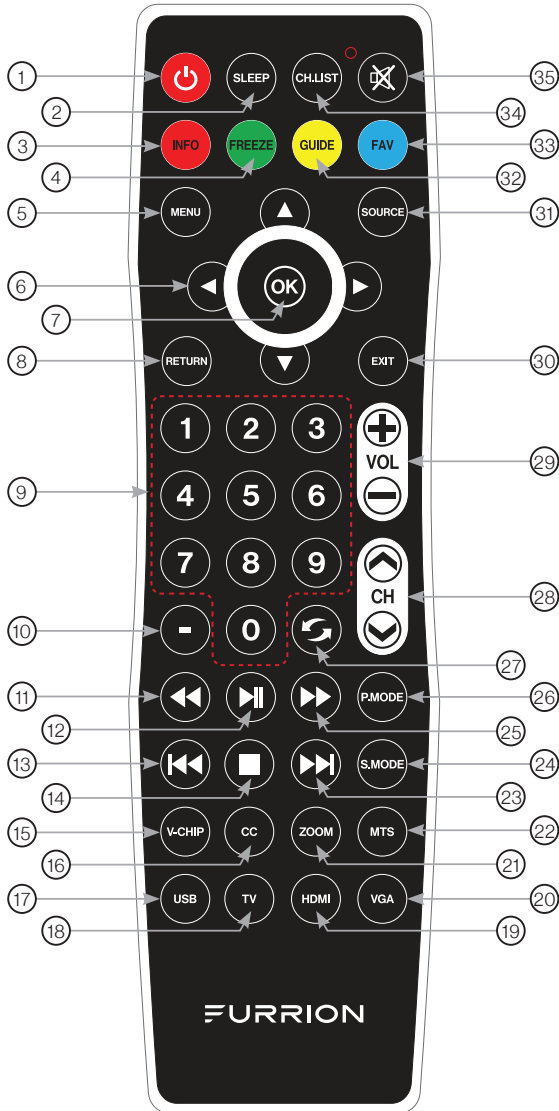



Function Overview





Remote Control



Function Overview

Remote Control

No.	Button	Function
①		Turn the TV on/off
②	SLEEP	Set time for the TV to turn off
③	INFO	Display information about the current input source
④	FREEZE	Freeze current picture
⑤	MENU	Enter the main menu
⑥	  /  / 	Navigate in a menu
⑦	OK	Confirm the selection
⑧	RETURN	Return to the previous menu
⑨	NUMBER BUTTONS	Enter numbers or select channels
⑩	-	Insert the dash for selecting digital channels directly (For example, channel 28-2 would be selected by the button sequence 2 8 - 2.)
⑪		Fast backward
⑫		Start or pause the playback
⑬		Skip to the beginning of the previous chapter/track/photo.
⑭		Stop playback
⑮	V-CHIP	Set up parental control
⑯	CC	Select Closed Caption: ON/OFF/CC On Mute
⑰	USB	Switch the source to USB
⑱	TV	Switch the source to TV
⑲	HDMI	Switch the source to HDMI
⑳	VGA	Switch the source to VGA

No.	Button	Function
㉑	ZOOM	Enlarge screen images
㉒	MTS	Select Stereo, Mono, or Second Audio Programming
㉓		Skip to the beginning of the next chapter/track/photo.
㉔	S.MODE	Select sound mode
㉕		Fast forward
㉖	P.MODE	Select picture mode
㉗		Toggle between the current and previous channels
㉘	CH ^/∨	Channel Up/Down
㉙	VOL +/-	Increase/Decrease the volume
㉚	EXIT	Exit the current menu
㉛	SOURCE	Select the input source
㉜	GUIDE	Open the current digital channel information guide (antenna only).
㉝	FAV	Add the channel to favorite list
㉞	CH.LIST	Display the channel list
㉟		Mute or unmute the audio

Before Operation

What's in the Box

Thanks for purchasing this Furrion Aurora™ TV. This manual will help you set up and begin using your TV. First, check the contents of your box with the parts checklist below:

- TV
- Weather proof remote with button battery (x1) and tool to open battery cover (x1)
- Wall mount screws (x4)
- Screw adaptors (x4)
- RCA cable
- Printing materials

Now you can get started!

Prepare your Remote Control

BATTERY INSTALLATION

1. Open the battery cover with the tool supplied with the remote control.
2. Install the supplied button battery CR2025.
3. Close the battery cover.

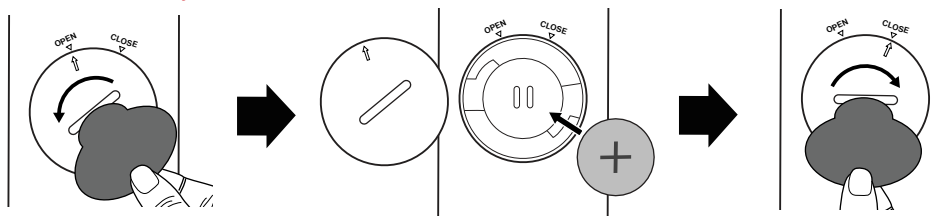

BATTERY PRECAUTIONS

These precautions should be followed when using battery in this device:

- Use only the size and type of battery specified.
- Danger of explosion if batteries are incorrectly replaced.
- If the device is not to be used for a long period of time, remove the battery to prevent damage or injury from possible battery leakage.
- The batteries should not be exposed to excessive heat due to sunlight, fire or other heat sources.

WARNING: This product contains a button battery on the remote control.

Before Operation

- Do not ingest the battery contained within the remote control supplied with the unit as this battery represents a chemical burn hazard.
- If the button battery is swallowed, it can cause severe internal burns in just 2 hours and can lead to death. If you think batteries might have been swallowed or placed inside any part of the body, seek immediate medical attention.
- Keep new and used batteries away from children. If the battery compartment does not close securely, stop using the product and keep it away from children.

Choose a Proper Location for your TV

Important: The TV must be installed away from any water source in a safety distance.

For best viewing we recommend you install it in a shaded environment.

- Avoid to install the TV where the screen is facing direct sunlight. The ideal location is in one place where the TV is shaded by structures, or under a patio cover or gazebo.
- If the sun shines directly on the screen for long periods of time, dark areas may appear on the screen. This is a normal reaction for the LED panel, and will not cause damage to the screen. Either turn the screen away from the sun, or shade the TV, and the dark areas will soon disappear.

Note: DO NOT use the TV if ambient air temperature exceeds the operating temperature limits.

Cable Management

WARNING: Do not connect the power source before making connections.

1. Open the cable access door in the rear panel by loosening the thumb screws. (Figure 1)
2. Connect the cables and lead all connecting cables downwards through the duct at the bottom of the cable access door.
3. Leave a drip loop when cables enter the compartment. This will prevent water from dripping down the cord and possibly entering the door area.
4. Close the door and tighten the thumb screws for the best waterproof effect. (Figure 2)

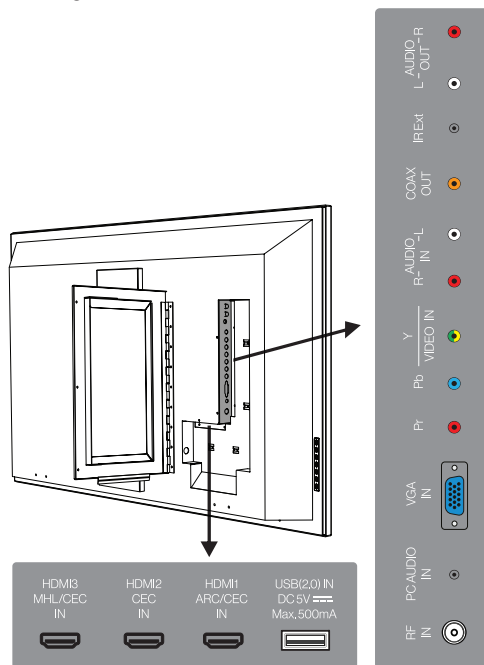

Figure 1

Before Operation

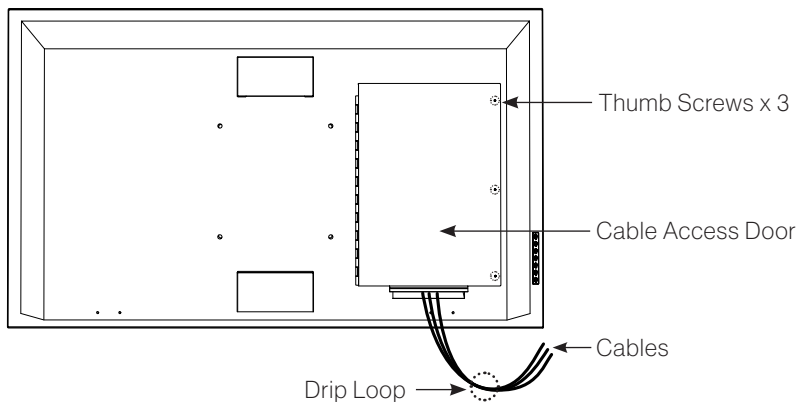

Figure 2

Tip: If a TV streaming stick is connected and stays inside the rear cable compartment, the RF/Wifi signal will be reduced when passing through the closed cable door.

Connect the Power Cord

Connect the power cord to a GFCI protected AC outlet with an "in-use" waterproof cover.

Caution:

- Do not connect power cord during cable connecting and TV installation.

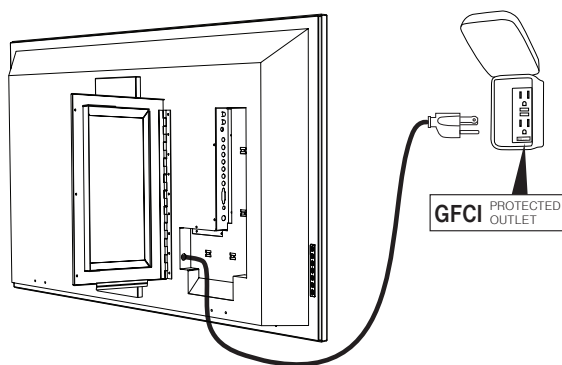

WARNING: TV and GFCI receptacle must be installed away from any water source in a safety distance. Be sure to check local electrical codes and comply with their local standards.

Before Operation

POWER SOURCE

NOTE: Please make sure to insert the cord securely at both the TV and the wall outlet.

WARNING:

- DO NOT USE WITH A VOLTAGE OTHER THAN THE POWER VOLTAGE SPECIFIED. DOING SO MAY CAUSE FIRE, ELECTRIC SHOCK, OR DAMAGE.
- DO NOT PLUG/UNPLUG THE POWER ADAPTER WHEN YOUR HANDS ARE WET. DOING SO MAY CAUSE ELECTRIC SHOCK.

CAUTION:

- WHEN THIS UNIT IS NOT BEING USED FOR EXTENDED PERIODS OF TIME (E.G., AWAY ON A TRIP), BE SURE TO UNPLUG IT FROM THE OUTLET.

Mount on Wall

You are recommended to install the TV in an area shaded by trees, landscape and/or structures, or under a patio cover or gazebo.



FULL SHADE (Covered gazebos, patios, porches)

TV designed for fully shade outdoor spaces.

(Model: *FDUF43CBR / FDUF49CBR / FDUF55CBR / FDUF65CBR*)

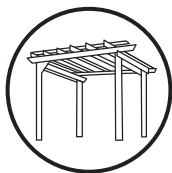

PARTIAL SUN (Pergolas, partially covered decks)

TV designed for partial sun exposure and brighter outdoor spaces.

(Model: *FDUP43CBR / FDUP49CBR / FDUP55CBR / FDUP65CBR*)

Before Operation

IMPORTANT: Connect all cables to the rear panel prior to mounting TV on wall. The cable access door in rear panel will be obstructed once the TV is mounted.

- Follow the installation guide supplied with the Wall-Mount Bracket (purchased separately) when installing the TV.
- Choose an appropriate location and refer to VESA pattern for mounting.
- Recommend you to contact a professional for installation and use at least two people to move or install the TV.

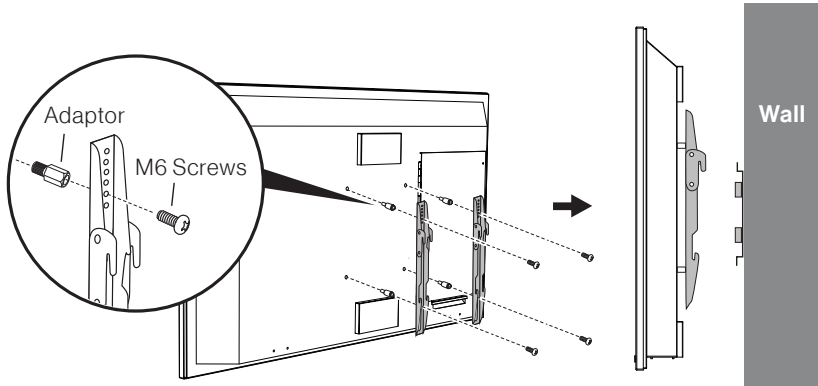

Getting Started

The **Setup Wizard** window appears only the first time you turn on the TV. It will assist you to configure the TV and scan for available channels.

IMPORTANT: Make sure the antenna or cable connection is made.

1. Press **POWER** button on the TV control panel or  button on the remote control to switch on the TV. The **Setup Wizard** window appears on the screen.

NOTE: It may take a few seconds before the **Setup Wizard** window appears on the screen.

2. Use **▲ / ▼ / ◀ / ▶** to navigate and select your desired settings.



Setup Wizard	
Menu Language	Use ▲ Or ▼ to highlight Menu Language , then press ◀ or ▶ to select English, French or Spanish .
Air/Cable	Use ▲ Or ▼ to highlight Air/Cable , then press ◀ or ▶ to select Air or Cable .
Cable System	Use ▲ Or ▼ to highlight Cable System , then press ◀ or ▶ to select Auto, STD, IRC or HRC . NOTE: Only adjustable when "Air/Cable" is set as "Cable" mode.
Auto Scan	Use ▲ Or ▼ to highlight Auto Scan , then press OK or ▶ to start scanning all the channels available in your area.

NOTE: You may press **MENU** at any time to exit the menu.

TV Settings

Setup Settings

1. Press **MENU** button, the setup window will appear on the screen.
2. Use ◀ or ▶ to highlight **Setup** mode.
3. Use ▲ or ▼ to highlight the item you would like to reset, then press ◀ or ▶ to select the settings.
4. Press **MENU** to return to the previous menu or press **EXIT** at any time to exit the setting.



Setup Menu

Menu Language	Select the menu language	Press ◀ or ▶ to select English, Français, Español or Deutsch .
Transparency	Control the menu transparency	Press ◀ or ▶ to select Off /On .
Zoom Mode	Set the picture proportion	Press ◀ or ▶ to select Zoom, Normal, Cinema or Wide . * The selection for Zoom Mode may vary from model to model.
Noise Reduction	Reduce the roughness of the picture	Press ◀ or ▶ to select Off, Weak, Middle or Strong .
Advanced	Control the PC settings.	*Only available after a PC connected.
Source Label	Allow labeling the input source	TV
		AV
		YPBPR
		HDMI1
		HDMI2
		HDMI3
		PC
USB	Press ◀ or ▶ to select Custom, Default, Antenna, Cable, Satellite, DTV, DVD, Blu-ray, HD-DVD, XBOX, Wii, PS3, Game, Computer, VCR or DV * The selection for Source Label may vary from model to model.	

TV Settings

Setup Menu

Closed Caption	Set the Closed Caption features.	CC Mode	Press ◀ or ▶ to select Off, On or CC On Mute .
		Basic Selection	Press ◀ or ▶ to select CC1, CC2, CC3, CC4, Text 1, Text 2, Text 3 or Text 4 .
		Advanced	Press ◀ or ▶ to select Service 1, Service 2, Service 3, Service 4, Service 5 or Service 6 .
		Mode	Press ◀ or ▶ to select Default or Custom .
		Font Style	Press ◀ or ▶ to select Default, Font 0, Font 1, Font 2, Font 3, Font 4, Font 5, Font 6 or Font 7 .
		Font Size	Press ◀ or ▶ to select Default, Normal, Large or Small .
		Font Edge Style	Press ◀ or ▶ to select Default, None, Raised, Depressed, Uniform, Left Shadow or Right Shadow .
		Font Edge Color	Press ◀ or ▶ to select Default, Black, Red, Green, Blue, Yellow, Magenta or Cyan .
		FG Color	Press ◀ or ▶ to select Default, White, Red, Green, Blue, Yellow, Magenta or Cyan .
		BG Color	Press ◀ or ▶ to select Default, Cyan, Magenta, Yellow, Blue, Green, Red or Black .
FG Opacity	Press ◀ or ▶ to select Default, Solid, Flashing, Translucent or Transparency .		
BG Opacity	Press ◀ or ▶ to select Default, Solid, Flashing, Translucent or Transparency .		
DLC	Adjust the picture contrast.	Press ◀ or ▶ to select Off or On .	
Setup Wizard	Start the Setup Wizard.	Press ◀ or ▶ to enter setup wizard menu.	

TV Settings

Setup Menu

HDMI CEC	Press ▶ to enter sub-menu, then press ◀ or ▶ to select Off /On for HDMI CEC . When selecting On , the sub-menu in the right column will be available to set up.	Auto Standby	Press ◀ or ▶ to select Off /On . In On mode, TV will shut down when there is no signal for several minutes.
		Auto TV on	Press ◀ or ▶ to select Off /On . In On mode, TV will automatically turn on when the connected CEC device is turned on.
		HDMI ARC	Press ◀ or ▶ to select Off /On . Set the HDMI ARC On if you want to enable the ARC function with a connected 5.1/7.1 Home Theater System.
		Device control	Press ◀ or ▶ to select Off /On . In On mode, it allows a connected CEC device to be controlled by TV remote control.
		Device list	Press ▶ to display a list of HDMI CEC devices currently connected to the TV.
EDID Switch	Select the EDID version.	Press ◀ or ▶ to select Auto, EDID 1.4 or EDID 2.0 .	
Restore Default	Reset to factory default settings.	Press ◀ or ▶ to select Yes or No .	
NOTE: HDMI CEC function is only available when connecting with a CEC device.			

TV Settings

Picture Settings

1. Press **MENU** button, the setup window will appear on the screen.
2. Use ◀ or ▶ to highlight **Picture** mode.
3. Use ▲ or ▼ to highlight the item you would like to reset, then press ◀ or ▶ to select the settings.
4. Press **MENU** to return to the previous menu or press **EXIT** at any time to exit the setting.

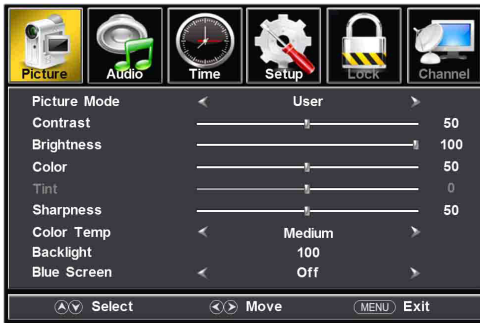

Picture Menu

Picture Mode	Select the display mode	Press ◀ or ▶ to select User/Standard/Dynamic/Mild .	
Contrast	Control the contrast level of the picture	Press ◀ or ▶ to increase or decrease contrast intensity. * Only adjustable after set "Picture Mode" as "User" mode	
Brightness	Control the brightness level of the picture	Press ◀ or ▶ to increase or decrease the overall brightness. * Only adjustable after set "Picture Mode" as "User" mode	
Color	Control the color level of the picture	Press ◀ or ▶ to increase or decrease the color intensity. * Only adjustable after set "Picture Mode" as "User" mode	
Tint	Control picture tint	Press ◀ or ▶ to adjust colors toward green or reddish tint. * Only adjustable under NTSC signal	
Sharpness	Control the sharpness of the picture	Press ◀ or ▶ to soften or enhance edges in the picture. * Only adjustable after set "Picture Mode" as "User" mode	
Color Temp	Select the color mode	Press ◀ or ▶ to select Medium / Warm / Cool .	
Blue Screen	If this is set as On , the screen changes to blue when no signal input.	Press ◀ or ▶ to set as On or Off .	
Advanced Setting	Press ▶ to enter sub-menu to set the features in right column.	Aspect Ratio	Press ◀ or ▶ to select Wide / Normal/Cinema/ Zoom .
		Noise Reduction	Press ◀ or ▶ to select Off / Weak / Middle / Strong .
		Dynamic Contrast	Press ◀ or ▶ to set as On or Off .
		HDMI mode	Press ◀ or ▶ to set as Video .
		Auto Brightness	Press ◀ or ▶ to set as On or Off .

TV Settings

Audio Settings

1. Press **MENU** button, the setup window will appear on the screen.
2. Use **◀** or **▶** to highlight **Audio** mode.
3. Use **▲** or **▼** to highlight the item you would like to reset, then press **◀** or **▶** to select the settings.
4. Press **MENU** to return to the previous menu or press **EXIT** at any time to exit the settings.

For DTV mode



For ATV mode



TV Settings

Audio Menu

Sound Mode	Select the sound mode	Press ◀ or ▶ to select Standard / Music / Movie / Sport / User mode. Standard: Optimizes a balanced sound in all environments. Music: Preserves the original sound clear and dynamic like that on a concert. Movie: Enhances treble and bass for a rich surround sound experience. Sport: Reproduces a realistic sound like that in a stadium. User: Customizes audio setting.	
Bass	Control the bass level	Press ◀ or ▶ to increase or decrease low frequency intensity.	
Treble	Control the treble level	Press ◀ or ▶ to increase or decrease high frequency intensity.	
Balance	Control the balance level	Press ◀ or ▶ to adjust the desired level between 0-100.	
Surround	Control the surround effect	Press ◀ or ▶ to set as On or Off .	
AVC	(Auto Volume Control) Control the maximum power output	Press ◀ or ▶ to set as On or Off .	
SPDIF Type	Select the SPDIF sound mode	Press ◀ or ▶ to select Off / RAW / PCM .	
Audio Languages	Select the menu language	Press ◀ or ▶ to select English / French / Spanish . * Only available on DTV channel	
MTS	Select the sound mode	Press ◀ or ▶ to select Stereo / SAP / Mono . * Only available on ATV channel.	
Accessibility	Control the Voice Guide functions	Voice Guide	Press ◀, ▶ or Enter to enter sub menu settings. Then press ◀ or ▶ to set as On or Off . When the Voice Guide is On , the OSD will read out via voice once you operate the TV.
		Volume	Press ◀ or ▶ to select Weak / Middle / Strong to change the volume. * Only available after Voice Guide is set as On mode
		Speed	Press ◀ or ▶ to select Weak / Middle / Strong to change the voice speed. * Only available after Voice Guide is set as On mode
		Pitch	Press ◀ or ▶ to select Weak / Middle / Strong to change the voice pitch. * Only available after Voice Guide is set as On mode
	Video Description	Press ◀ or ▶ to set as On or Off . When setting as On , the video description function is enabled and the video commentary text will appear.	

TV Settings

Time Settings

1. Press **MENU** button, the setup window will appear on the screen.
2. Use ◀ or ▶ to highlight **Time** mode.
3. Use ▲ or ▼ to highlight the item you would like to reset, then press ◀ or ▶ to select the settings.
4. Press **MENU** to return to the previous menu or press **EXIT** at any time to exit the setting.



Time Menu

Sleep Timer	Set the countdown time before TV automatically shutdown	Press ◀ or ▶ to select Off, 5Min, 10Min, 15Min, 30Min, 45Min, 60Min, 90Min, 120Min, 180Min or 240Min .
Time Zone	Set the time zone	Press ◀ or ▶ to select Pacific, Alaska, Hawaii, Atlantic, Eastern, Central or Mountain
Daylight Saving Time	Turn on/off daylight saving time	Press ◀ or ▶ to set as On or Off . * Only adjustable on DTV channel
Time Format	Select the time display format	Press ◀ or ▶ to set as 12-hour or 24-hour . * Only adjustable on DTV channel
Auto Clock	Set automatic time	Press ◀ or ▶ to set as On or Off . * Only adjustable on DTV channel
Clock	When Auto Clock is set as Off , you can set the time manually. Clock and Date are automatically set on the first time when the tuner receives a broadcast channel. * Only adjustable on DTV channel	

TV Setting

Lock Settings

1. Press **MENU** button, the setup window will appear on the screen.
2. Use **◀** or **▶** to highlight **Lock** mode.
3. Use **▲** or **▼** to highlight **"Enter Password"** and input **"0000"** to enter the sub menu.
4. Use **▲** or **▼** to highlight the item you would like to reset, then press **◀** or **▶** to select the settings.
5. Press **MENU** to return to the previous menu or press **EXIT** at any time to exit the setting.

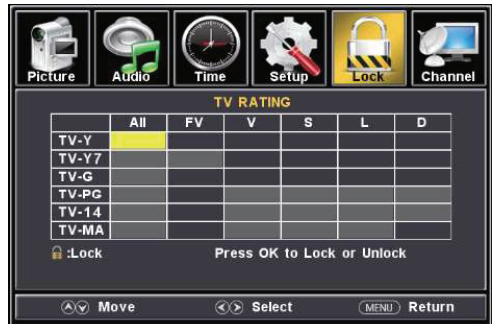

TV Setting

Lock Menu

Enter Password	Input the password to access the Lock menu.	Use the Number Buttons (0-9) to enter the password, the Lock menu will appear. * Default password is 0000. * If you forgot the password, use 8888 to enter any locked menu.	
Set Password	Change the user password.	Set Password	Use Number buttons (0-9) to enter a new password.
		Confirm Password	Repeat the password to confirm.
System Lock	Change the parental controls.	Press ◀ or ▶ to set as On or Off .	
US	Set up parental locks based on US rating system. * Only available when System Lock is set as On mode.	TV	Press ▶ to enter the TV Ratings menu and use ▲/▼/◀/▶ to select your TV rating preference.(refer to the following tables of Age and Genre)
		MPPAA	Press ◀/▶ buttons to select your movie rating preference based on US Rating System .
Canada	Set up parental locks based on Canadian rating system. * Only available when System Lock is set as On mode	Canada English	Use ◀/▶ buttons to select your ratings preference based on Canadian Rating System (English) .
		Canada French	Use ◀/▶ buttons to select your ratings preference based on Canadian Rating System(French) .
RRT Setting	Not adjustable by user.		
Reset RRT	Restore to default RRT settings.	Press OK or ▶ to enter the sub menu, then press ◀ or ▶ to select Yes or No .	
Clear Lock	Restore to default V-chip settings and clear the lock setting.	Press OK or ▶ to enter the sub menu, then press ◀ or ▶ to select Yes or No .	

TV Settings

Age

TV-Y	All Children
TV-Y7	Suitable for 7 years old or above
TV-G	General Audience
TV-PG	Parental Guidance
TV-14	Suitable for 14 years old or above
TV-MA	Suitable for 17 years old or above

Genre

ALL	All
FV	Fantasy Violence
V	Violence
S	Sex
L	Language
D	Dialogue

US Rating System

N/A	All Ages
G	General Audience
PG	Parental Guidance
PG-13	Parental Guidance below 13 years
R	Parental Guidance below 17 years
NC-17	Suitable for 17 years old or above
X	Adults Only

Canadian Rating System (English)

E	Exempt from the ratings (All ages)
C	Suitable for children age of 0–7 years
C8+	Suitable for children age over 8 years
G	General Audience
PG	Parental Guidance
14+	Suitable for viewers age over 14 years
18+	Suitable for adults over 18 years

Canadian Rating System (French)

E	Exempt from the ratings (All ages)
G	General Audience
8 ans+	Suitable for children ages over 8 years
13 ans+	Suitable for children ages over 13 years
16 ans+	Suitable for viewers ages over 16 years
18 ans+	Suitable for adults over 18 years

TV Settings

Channel Settings

1. Press **MENU** button, the setup window will appear on the screen.
2. Use **▲** or **▼** to highlight **Channel** mode.
3. Use **▲** or **▼** to highlight the item you would like to reset, then press **◀** or **▶** to select the settings.
4. Press **OK** to confirm your selections or settings and enter the sub menus.
5. Press **MENU** to return to the previous menu or press **EXIT** at any time to exit the setting.

Note: For Cable or Satellite users with a set-top box, there is no need to run channel Auto Scan. Connect your cable or satellite set top box to one of the available inputs on the TV for viewing.

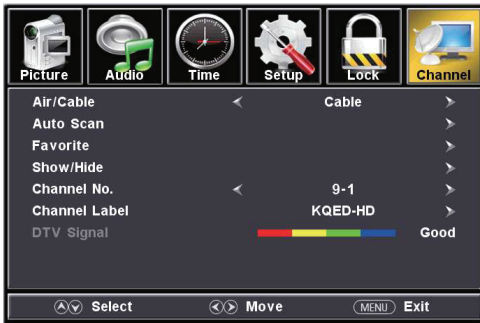

Channel Menu

Air/Cable	Set the reception type.	Press ◀ or ▶ to select Air or Cable . <ul style="list-style-type: none"> • Select Air when TV is connected to an indoor / outdoor antenna. • Select Cable if you subscribe to a pay television service WITHOUT a set top box. 	
Auto Scan	Press ▶ or OK to enter sub menu.	Cable System	Press ◀ or ▶ to select Auto , STD , IRC or HRC . (Only available when you select Cable as the reception type.)
		Start to Scan	Press ▶ or OK to start scanning available channels..
Favorite	Add or delete a channel in the favorite list.	Press ▲ or ▼ to select a channel, then press ▶ or OK to add or delete the channel in the favorite list.	
Show/Hide	Show or hide available channels already in memory.	Press ▲ or ▼ to select a channel, then press ▶ or OK to show or hide the channel.	
Channel No.	Select a channel number to be labeled	Press ◀ or ▶ to select a channel.	
Channel Label	Allow custom labeling to name or rename a channel	Press ▲ or ▼ to select each letter, number or character. Press ◀ or ▶ to skip to the next space. (Maximum of 7 characters)	
DTV Signal	Dynamically display the DTV signal status.		

TV Settings

PC Settings

The PC menu is only accessible when a PC is connected to the TV via the VGA connection. Press **Source** button to select **VGA** as the input source.

1. Press **MENU** button, the setup window will appear on the screen.
2. Use **◀** or **▶** to highlight **Setup** mode.
3. Use **▲** or **▼** to highlight **Advanced**, then press **OK** or **▶** to enter the sub menu.
4. Use **▲** or **▼** to highlight the item you would like to reset, then press **◀** or **▶** to select the settings.
5. Press **MENU** to return to the previous menu or press **EXIT** at any time to exit the setting.

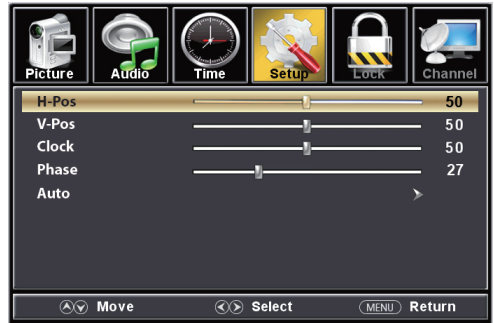

Advanced Sub-Menu

H-Pos	Configure the horizontal position of the TV image	Press ◀ or ▶ to move the screen horizontally.
V-Pos	Configure the vertical position of the TV image	Press ◀ or ▶ to move the screen vertically.
Clock	Adjust the pixel Clock (vertical) for a clearer image	Press ◀ or ▶ to adjust the pixel clock vertically.
Phase	Adjust the phase Clock (horizontal) for a clearer image	Press ◀ or ▶ to adjust the phase clock horizontally.
Auto	Automatically adjust the PC settings	Press OK or ▶ to adjust all PC settings automatically.

PC MONITOR DISPLAY MODES

Mode	Resolution	Refresh Rate
VGA	640 x 480	60/75 Hz
VGA	720 x 400	70 Hz
VGA	1366 x 768	60Hz
SVGA	800 x 600	60/75 Hz
XGA	1024 x 768	60/70/75 Hz
WXGA	1280 x 720	60 Hz

PC MONITOR DISPLAY MODES

Mode	Resolution	Refresh Rate
WXGA	1360 x 768	60 Hz
SXGA	1280 x 1024	60 Hz
WXGA+	1440 x 900	60 Hz
WSXGA+	1680 x 1050	60 Hz
FHD	1920 x 1080	60 Hz

USB Operation

1. After connecting a flash drive, press **SOURCE** button and select **MEDIA**. Press **OK** or **▶** to enter.
2. Use **◀** or **▶** to select **Photo** or **Music**. Press **OK** or **▶** to enter.
3. Use **▲** or **▼** to navigate the files or folders on the USB drive.
4. Press **MENU** to return to the previous menu or press **EXIT** at any time to exit the setting.

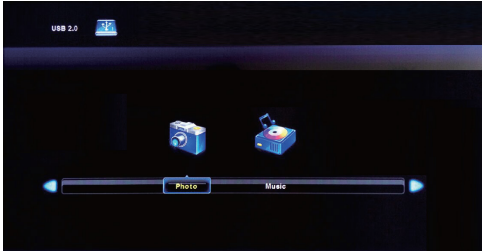

When viewing photos, you can use this photo viewer tool to control slide show, play music and show file information.

The photo viewer displays .jpg photo format files.

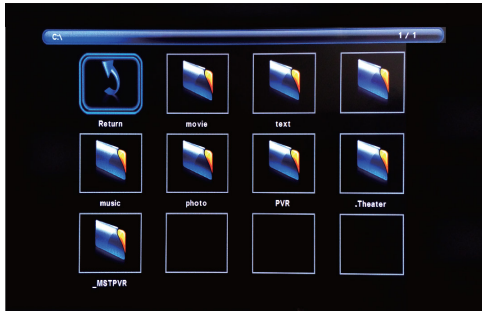
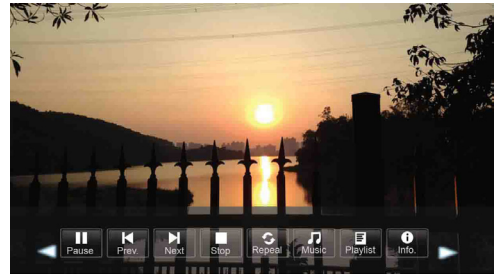

Playback of music is via this music player, which gives playback controls and information on the file.

The music player plays MP3 audio format files.



Troubleshooting

Problem	Solution/Issue
TV does not operate	<ul style="list-style-type: none"> ● Make sure the power cord is plugged in. ● Try another AC outlet. ● Power is off, check fuse or circuit breaker. ● Unplug unit for an hour, then plug it back in.
Normal picture, but no sound	<ul style="list-style-type: none"> ● Check the volume settings. ● Sound muted? Press MUTE button. ● Try another channel. ● Check audio cable connections.
The remote control does not work	<ul style="list-style-type: none"> ● Make sure the remote control is in range with no obstructions. ● Check the batteries. ● Correct operating mode set: TV, VCR etc.
Poor sound or no sound	<ul style="list-style-type: none"> ● Station or Cable TV experiencing problems, tune to another station. ● Check sound adjustments (Volume or Mute). ● Check for sources of possible interference.
Poor picture or no picture	<ul style="list-style-type: none"> ● Station or Cable TV experiencing problems, tune to another station. ● Make sure channels are set into memory. ● Check antenna or Cable TV connections, adjust antenna. ● Check for sources of possible interference. ● Check picture control adjustments.
Poor TV reception	<ul style="list-style-type: none"> ● Ensure the antenna amplifier is turned on for Antenna TV. ● Adjust the antenna position to a stronger signal receiving angle. ● Check if the Antenna connection is tight to the TV. ● Check if there is power supplied to the Antenna distribution box. ● Check if your incoming cable is connected to the correct cable / antenna wall connection inside the RV. ● Ensure the internal RV coax jump cable is connected to the correct port.
Poor Cable / Satellite TV Reception	<ul style="list-style-type: none"> ● Ensure antenna amp is turned off for cable signal. ● Check if incoming cable is connected correctly to RV. ● Ensure cable splitter box has power. ● Check if the incoming cable is connected to the correct cable / Satellite wall connection inside your RV. ● Ensure the internal RV coax jump cable is connected to the correct port. ● Ensure Dish has no obstruction.
TV shuts off	<ul style="list-style-type: none"> ● Sleep Timer is set. ● Power interrupted.
Black and white image from the connected AV device	<ul style="list-style-type: none"> ● Check video connections on both the TV and connected AV device. Ensure the colors match between the connectors and sockets: green (Y), blue (Pb/Cb) and red (Pr/Cr) for component connection, and yellow (VIDEO) for composite connection. ● Ensure all video cables are connected firmly.

Specifications

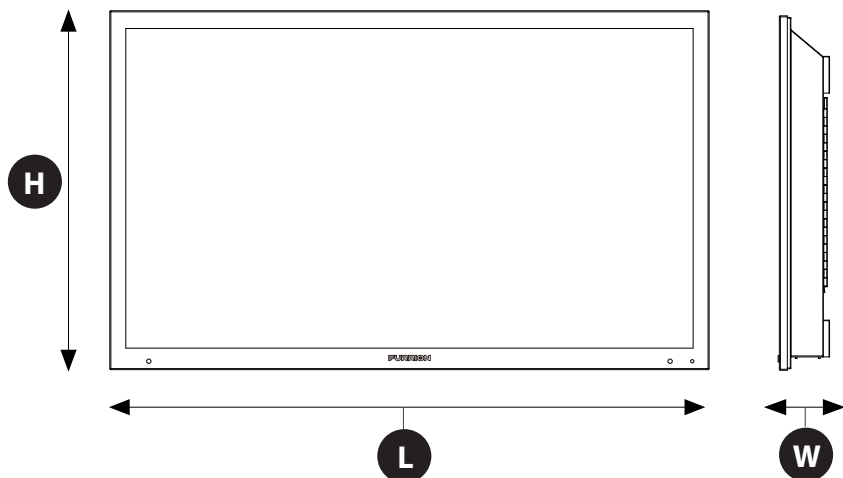

MODEL, DIMENSION & RESOLUTION

TV Model	Dimension without Stand (L x H x W)	Max Resolution
FDUP43CBR	39 ³ / ₄ " x 23 ⁷ / ₈ " x 3 ³ / ₄ " (1010 x 605 x 96 mm)	3840 x 2160@ 60Hz UHD
FDUF43CBR		
FDUP49CBR	44 ¹¹ / ₁₆ " x 26 ¹³ / ₁₆ " x 3 ⁷ / ₈ " (1135 x 680 x 98 mm)	
FDUF49CBR		
FDUP55CBR	50 ³ / ₁₆ " x 29 ³ / ₄ " x 4 ³ / ₁₆ " (1274 x 756 x 105 mm)	
FDUF55CBR		
FDUP65CBR	59 ¹ / ₁₆ " x 34 ⁷ / ₈ " x 3 ⁷ / ₈ " (1499 x 885 x 97 mm)	
FDUF65CBR		

INPUT & OUTPUT CONNECTIONS

Model	L-AUDIO OUT-R	IR Ext	Coaxial Out	L-AUDIO IN-R	Component Video in	Component YP _b P _r Video in	HDMI in	VGA (PC) in	Audio (PC) in	RF in	USB
FDUP43CBR FDUP49CBR FDUP55CBR FDUP65CBR FDUF43CBR FDUF49CBR FDUF55CBR FDUF65CBR	1	1	1	1 x Left (White) 1 x Right (Red)	1 x Yellow/Green*		3	1	1	1	1
					1 x Blue 1 x Red						

Care and Clean

TV Cleaning

Remove any dirt and salt deposits from the unit, being careful to rinse the cloth frequently to avoid scratching the TV or screen surface. Avoid using harsh chemicals, abrasives, or solvents when cleaning any surface on the unit.

- **If there is snow or ice on the TV surface**, use a soft brush and towel to remove snow and ice from the unit.
- **Cleaning the LED panel:** With your TV turned off, gently wipe the surface of the display panel with a damp (with water) microfiber, cotton or flannel cloth. (Do not use tissues, rags, sponges or paper towels because they may damage the screen and leave lint pieces behind). If the LED panel is very dirty, you can mix equal parts of isopropyl alcohol and distilled water in a clean spray bottle, spray the mixture onto the cloth (do not spray the solution directly on the panel) and gently clean the panel.
- **When the TV is not in use, keep it covered with the Furrion Weatherproof TV Cover.** The fitted cover is designed to protect the LED panel from the harmful UV rays from direct sunlight, the ingress of water, and keeps wind-blown objects from scratching the surface of the TV. **To order a Furrion Weatherproof TV Cover**, you can contact the authorized dealer or buy from Furrion website.

FURRION

Furrion Innovation Center & Institute of Technology

- 52567 Independence Ct., Elkhart, IN 46514, USA • Toll free: 1-888-354-5792
- Email: info@furrion.com

©2007-2019 Furrion Ltd. Furrion® and the Furrion logo are trademarks licensed for use by Furrion Ltd. and registered in the U.S. and other countries.

FURRION.COM