

FURRION

40" BUILT-IN ELECTRIC FIREPLACE FF40SC15A-BL

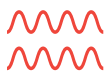

WORKS WITH
UNIMOTE



VIBRATIONSMART™



CLIMATESMART™



OVERHEATING
SAFETY
CUT-OFF



SLIDE-OUT
SAFETY
CUT-OFF



TEMPERATURE
CONTROL
SETTINGS



HEAT UP
TO 500sq.ft



CRYSTAL
WITH 4-LEVEL LED
FLAME TECHNOLOGY



3 FLAME
COLORS



TIMER

- Flame effect technology: traditional flame
- Three flame color options: orange, blue and red
- 4 flame brightness settings
- Black tempered glass front panel
- Dimmer and heating

- Adjustable temperature settings from 65°F to 95°F
- Temperature control
- Timer setting up to 5 hours
- LED control board
- Remote control included



FF40SC15A-BL | 40" BUILT-IN ELECTRIC FIREPLACE

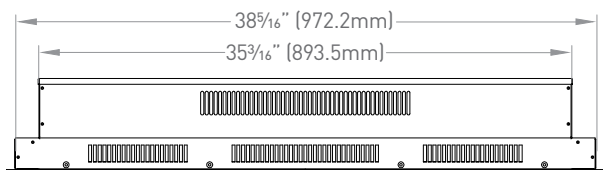
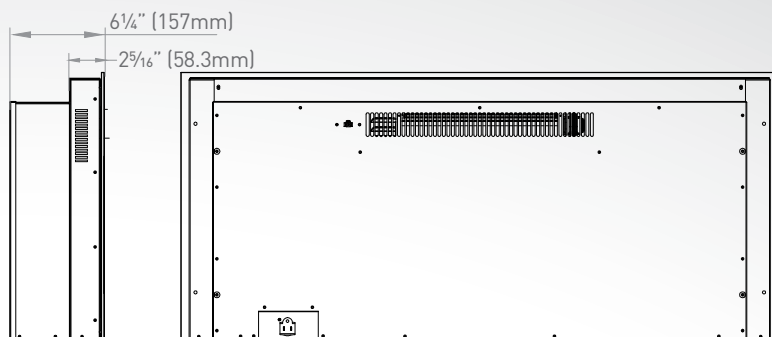
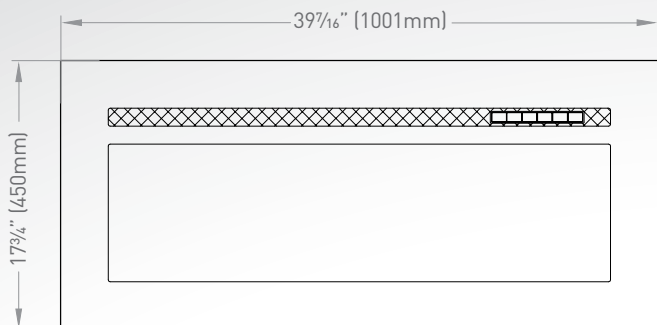

Specifications

Rated Voltage	AC 120V/60Hz
Heating Output	750W/1465W
LED Control Board	✓
Timer	✓
Log Fuel Effect	✓
Remote Type	IR

Dimensions

Product Size (W x H x D)	39 7/16" x 17 3/4" x 6 1/4" (1001 x 450 x 157mm)
--------------------------	---

Packaging Information

Packaging Type	Brown Carton Box
Quantity Per Box (pcs)	1
Individual Packaging Dimensions (W x H x D)	41" x 19 1/2" x 8" (1045 x 495 x 202mm)
Individual Packaging Gross Weight (kg/lbs)	22/49.5
Individual Packaging Net Weight (kg/lbs)	20/44

Box Container Qty

20' - Box Container Qty	246
40' - Box Container Qty	522
40'H - Box Container Qty	605