

FURRION

17" 2-IN-1 RANGE OVEN WITH WIRED GRATE

+ DRAWER (OPTION)

FSRE17SA



FSRE17SA-BL

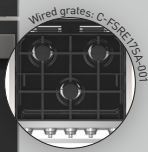

FSRE17SA-SS



FSRE17SA-SB

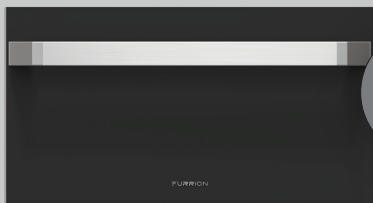
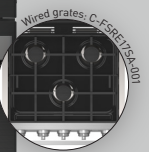

Drawer: FDO12A-BL

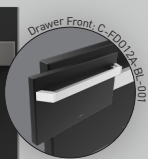

Drawer: FDO12A-SS

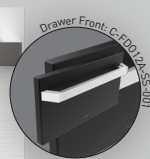

Drawer: FDO12A-SB

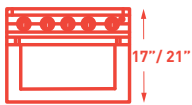
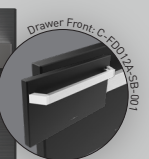

PROFILE
OPTIONS



CAVITY
LIGHTING



LED
KNOB



IMPROVED HEAT
DISTRIBUTION

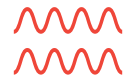

VIBRATIONSMART™



CLIMATESMART™



FLUSH
MOUNTED



GLASS
COVER



DIE-CAST GRATES OPTION
(C-FSRE21SA-002)



FSRE17SA | 17" 2-IN-1 RANGE OVEN WITH WIRED GRATE (DRAWER OPTION)

Oven Drawer (front only) (C-FD012A-BL/SS/SB-001)

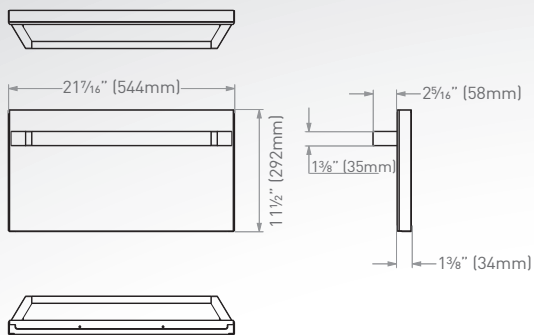

Oven Drawer (FD012A-BL/SS/SB)

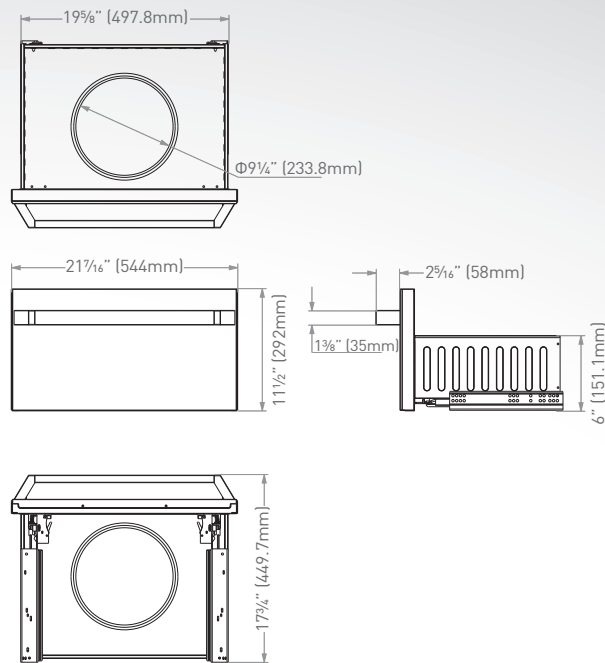

Range Oven (FSRE17SA-BL/SS/SB)

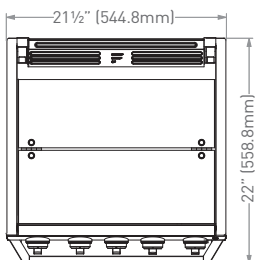
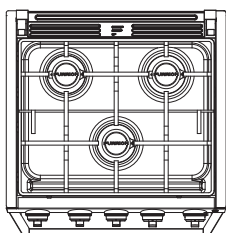
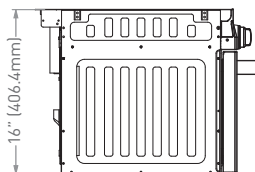
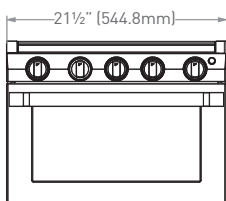
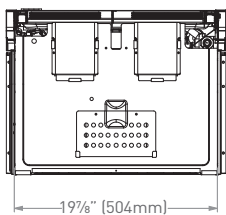
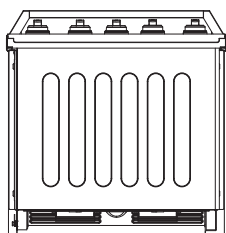

Top view without glass cover



FSRE17SA | 17" 2-IN-1 RANGE OVEN WITH WIRED GRATE (DRAWER OPTION)

Part No.	Product Description
FSRE17SA-BL/SS/SB	17" Range oven stainless steel with top glass, black/stainless steel/black stainless steel
C-FD012A-BL/SS/SB-001	Oven drawer front only, stainless steel, black/stainless steel/black stainless steel
FD012A-BL/SS/SB	Oven drawer for 17" Range oven & 21" Range oven, black/stainless steel/black stainless steel

Note: All are sold separately

Specifications

Left Cooktop Burner	6500 BTU
Front Cooktop Burner	8000 BTU
Right Cooktop Burner	6500 BTU
Oven Burner	7100 BTU
Pulse Ignition	12VDC
Cavity Light	12VDC
LED Manual Knob	✓
Gas Safety Cut-off Valve	✓
Triple Layer Glass Door	✓
Glass Cover	2-piece folding cover

Dimensions

Range Oven (W x H x D)	21½" x 16" x 22" (544.8 x 406.4 x 558mm)
Drawer (W x H x D)	21⅞" x 11½" x 17¾" (544 x 292 x 449.7mm)

Packaging Information (Range Oven)

Packaging Type	Brown Box
Quantity Per Box (pcs)	1
Individual Packaging Dimensions (W x H x D)	24 ¹³ / ₁₆ " x 19 ¹⁵ / ₁₆ " x 25" (630 x 505 x 635mm)
Individual Packaging Gross Weight (kg/lbs)	29.2/64.4
Individual Packaging Net Weight (kg/lbs)	26.3/58.0

Container Load Information (Range Oven)

40'HQ Container Load (pcs)	286
----------------------------	-----

Packaging Information (Drawer)

Packaging Type	Brown Box
Quantity Per Box (pcs)	1
Individual Packaging Dimensions (W x H x D)	22 ⁵ / ₈ " x 13" x 18 ¹¹ / ₁₆ " (574 x 330 x 474mm)
Individual Packaging Gross Weight (kg/lbs)	12/26.5
Individual Packaging Net Weight (kg/lbs)	9/19.8

Container Load Information (Drawer)

40' Container Load (pcs)	650
--------------------------	-----

Packaging Information (Drawer front)

Packaging Type	Brown Box
Quantity Per Box (pcs)	6
Individual Packaging Dimensions (W x H x D)	22½" x 12½" x 2⅝" (570 x 316 x 60mm)
Individual Packaging Gross Weight (kg/lbs)	
Individual Packaging Net Weight (kg/lbs)	

Container Load Information (Drawer front)

40' HQ Container Load (pcs)	2400
-----------------------------	------