

ASSEMBLY INSTRUCTION

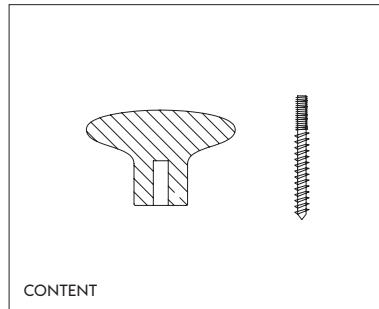

1.

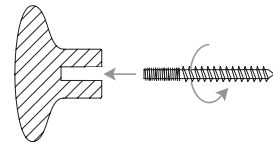

2. Before mounting, drill a 4 mm hole when mounting Dot Wood on a wooden wall.

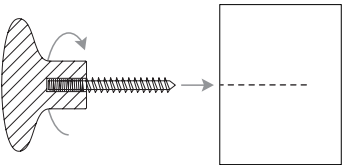

3.

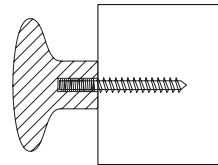

MUUTO ØSTERGADE 36-38
DK-1100 KØBENHAVN K DENMARK

FOR MORE INFORMATION
VISIT MUUTO.COM

DOTS WOOD

— Lars Tornøe

MUUTO

WALL MOUNTING GUIDE

When mounting your Muuto product to a wall, it is important that it is mounted both securely and correctly. The best way to mount your product depends on the type of wall it is being attached to. If a wall plug is required, it is vital that you find one that fits both the screw and the wall material.

If in doubt, ask for advice in your local hardware store. They will be able to assist you in finding the right wall plug and screw.

1. DRYWALL

Drywall is made from a porous material. When mounting, it is vital that you drill a 8 mm hole and use a wall plug suitable for drywall.

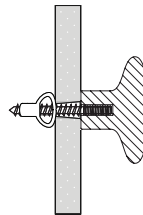

2. BRICK WALL

It is essential to use a wall plug of minimum Ø8 mm when mounting onto a brick wall. Make sure that you drill holes in the bricks and not in the sealer surrounding the bricks.

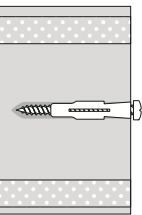

3. CONCRETE

When mounting to concrete walls, a wall plug is needed. Please be aware that concrete walls, especially in newer buildings can be thin, meaning a special plug of minimum Ø8 mm is required.

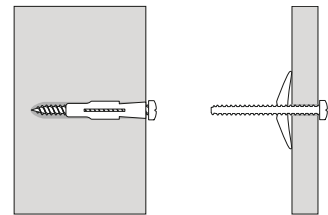

4. AERATED CONCRETE & HOLLOW BLOCKS

Aerated concrete and hollow blocks are both porous materials. Therefore, the use of a wall plug of minimum Ø8 mm is vital when mounting. If the wall is extra porous, an extra-long wall plug is needed, and it is important that the screw is equally long.

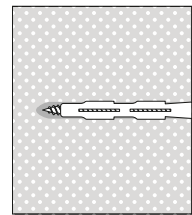

5. WOOD

When mounting your product to a wooden surface, special wood screws are required.

