

kraenzle®

GB Operating manual

Cold and hot water high-pressure cleaner

therm 715

therm 1017



Operating manual!

Read and conform safety instructions before use!
Keep instructions in a safe place for later use and
pass them on to any future user.

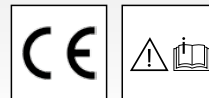

www.kraenzle.com

Dear customer:

We would like to congratulate you on the purchase of your new high-pressure cleaner and thank you for your confidence in our products!

Your choice has fallen on an absolute quality product! Kränzle high-pressure cleaners are characterized by their convenient and compact design as well as their high suitability for everyday use.

Highest precision and dimensional accuracy in addition to a technology package consisting of a multitude of details mark the difference when it comes to performance, safety and durability.

In order to facilitate handling of the high-pressure cleaner, the following pages are intended to further explain its use. The illustrations may be subject to deviation depending on the type of equipment or accessory of high-pressure cleaner purchased by you.

Contents	2
Explanatory symbols	3
Safety notes	6
Description of high-pressure cleaner	10
General rules	16
Functional details	20
Putting into operation	27
Direct suction	33
Applying additives	34
Taking out of operation	35
Small repairs - do it yourself	36
Pipeline plan	44
Warranty	45
Kränzle accessories	46
Inspection reports	48
Kränzle final report	52
EC declaration of conformity	54

Explanatory symbols used in the operating manual



Failure to observe this note may entail environmental damage.



Note on the use of the high-pressure cleaner that failure to adhere to the instructions may cause excessive wear or total breakdown of the large therm series.



Warning!
Failure to observe this note may result in serious injuries!

Explanatory symbols affixed to the high-pressure cleaner



In case of improper use, the high-pressure jets can be very dangerous. Do not direct high-pressure jet at persons, animals or active electrical equipment or the high-pressure cleaner itself.



The high-pressure cleaner may not be connected directly to the public drinking water supply network.



Warning! Attention hot surfaces.
Non-observance of this note will involve risk of burns.



Warning! Attention high voltage.
Prior to opening high-pressure cleaner the main switch must be set "OFF" and the mains plug must be pulled out.

Explanatory symbols used on the control panel

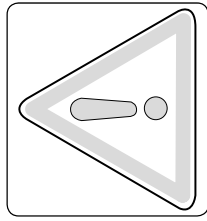

Attention:

For safety reasons switch off main switch after completing the washing procedure (= supply isolation)

Prior to putting the high-pressure cleaner into operation make sure that all safety instructions be observed.

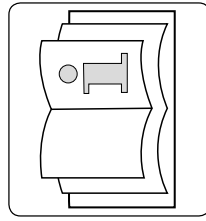

Before starting up the high-pressure cleaner for the first time, please read the original operating instructions as well as the technical data in the original spare-parts list.

Explanatory symbols used on the short instruction manual

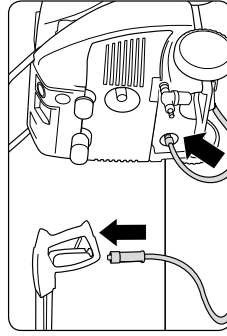

Step 1:

Screw high-pressure hose down and pressure-tight using safety trigger gun and lance.

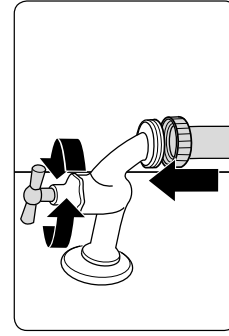

Step 2:

Connect water hose to water inlet. Open water tap.

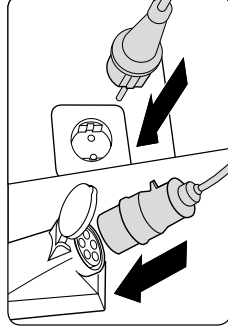

Step 3:

Connect to circuit (see technical data).

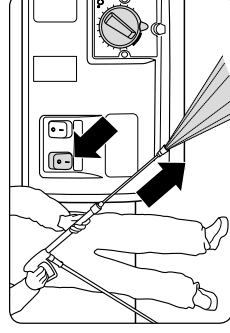

Step 4:

Switch on HP cleaner at main switch with opened safety trigger gun. Start cleaning process.

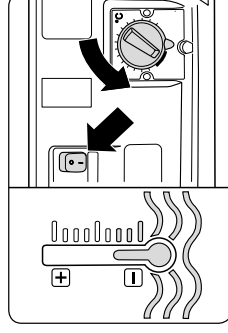

Step 5:

Usage as a cold water high-pressure cleaner.
Set temperature at the thermal switch on "0".
Switch on heater switch.

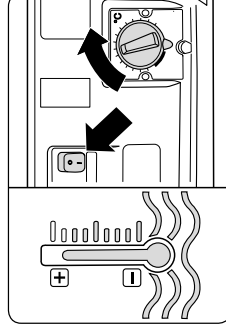

Step 6:

Usage as a hot water high pressure cleaner.
Set desired temperature at the thermostat.
Switch on heater switch.

User operating the high-pressure cleaner should wear the necessary protective clothing, i.e. waterproof clothing, rubber boots, safety goggles, headwear etc. It is prohibited to use the high-pressure cleaner in close vicinity to people lacking suitable protective clothing.

Do not spray against matter containing asbestos or other hazardous substances!

Never spray liquids containing solvents like varnish solvents, petrol, oil or similar liquids! There is an explosion hazard due to spraying such materials!

Due to the high-pressure jet, damage may occur on the objects to be cleaned, e.g. car tires; therefore, a minimum distance of 30 cm is to be kept!

Prior to putting the high-pressure cleaners into operation, check its components (High-pressure hose, power supply cables, safety trigger gun) for any damage. Replace defect or damaged components!

Replacement of the power supply cables is only permitted by use of an original power supply cable of the manufacturer and must be performed by a qualified electrician.

The high-pressure cleaner is to be properly used. The user is required to adhere to local requirements and to watch out for the persons in the danger zone!

If noise exceeds the maximum allowed levels, users and others in the vicinity must wear suitable ear protection.

Some parts inside the machine, all metal parts of trigger gun with safety catch and lance are hot during hot water operation. Keep all hoods and protective covers closed during operation and never touch any metal parts of gun or lance without wearing appropriate protective gloves.

The high-pressure cleaner is not intended for use by persons with reduced physical, sensory or mental capabilities, unless such persons are supervised and capable of perceiving the risks involved in the use of high-pressure cleaners!

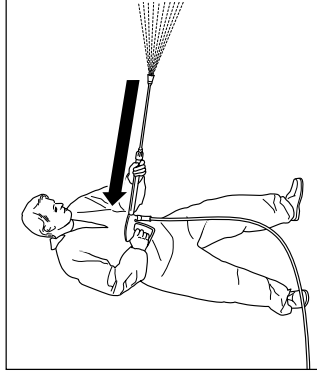

When using high-pressure water for cleaning, make sure that there is a clearly noticeable recoil effect on the lance. Therefore ensure a firm footing (see technical data).

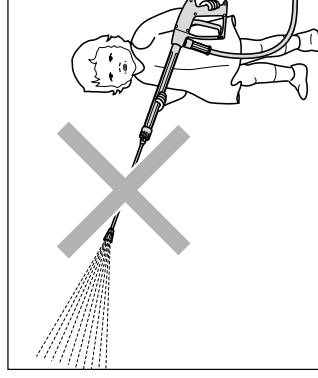

Never allow children or untrained persons to use the high-pressure cleaner or to play with it!

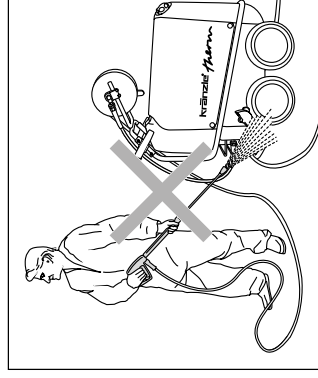

Never direct the high-pressure jet at the high-pressure cleaner itself!

The high-pressure cleaner may not be placed within reach of the high-pressure jet spray mist!

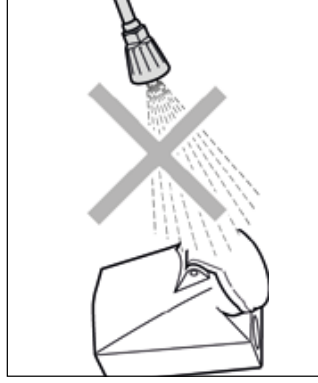

Never direct the high-pressure jet at power sockets or any other electrical installations!
Within the working area, all live parts are to be protected from both water jet and spray mist.

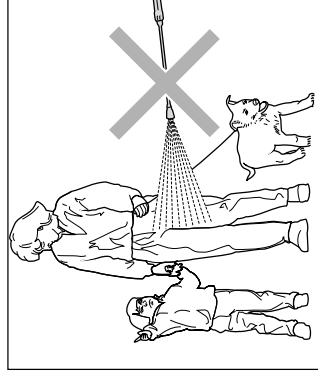

Never direct the high-pressure jet at people or animals!
Never direct the high-pressure jet at yourself or other persons, not even to clean clothing or shoes.

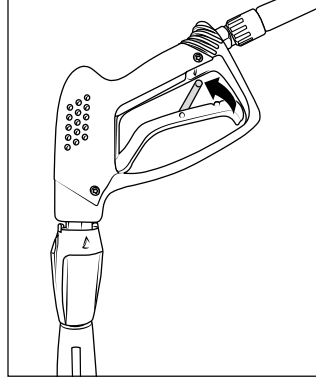

Apply the safety catch on the safety trigger gun after each use in order to prevent unintentional spraying!

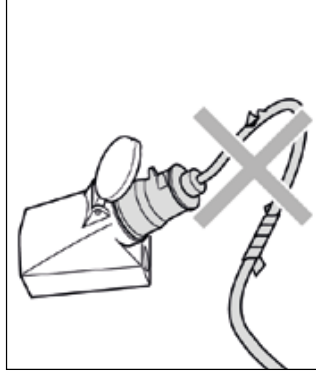

Only use a power supply cable in perfect working order!
Do not damage or improperly repair the power cable (tearing, squeezing, running over, ...).

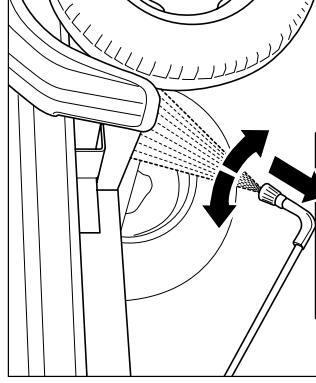

Always pay attention to the underbody lance resting on the surface!
Bear in mind when using a curved or angled spraying lance that there is a significant amount of torque in the recoil!
(the underbody lance is available as optional accessory).

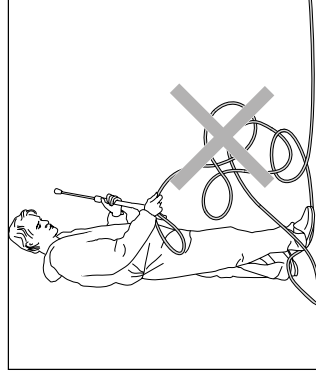

Never pull the high-pressure hose if it has formed kinks or "nooses"!
Never pull the high-pressure hose over sharp edges!

Design: therm series without hose drum

The therm series is a mobile high-pressure cleaner with an advanced arrangement system. Please see construction scheme for more details.

1. Ergonomically shaped handle
2. Holders for safety trigger gun with lance
3. Operating panel (refer to page 14)
4. Cable reel for the power supply cable
5. Storages for lances
6. Cleaning agent injection hose
7. Pump outlet / high-pressure hose connection
8. Feed line water inlet, water hose connection
9. Storage bin for accessories
10. Integrated trolley takes steps and rough ground in its stride
11. Parking brake
12. large removable caps (refer to page 15)
13. Filler aperture for fuel

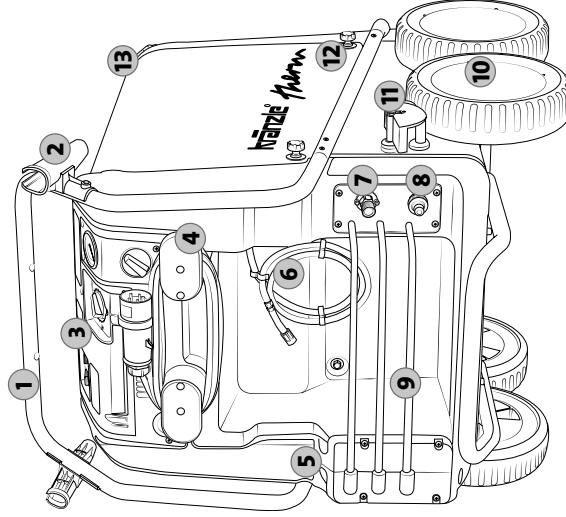
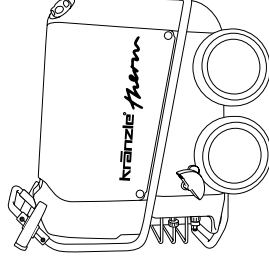
**This is what you have purchased: therm series without hose drum**

1. Kranzle high-pressure cleaner therm 715
therm 1017

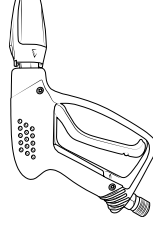

2. Trigger gun with safety catch Starlet, short design with quick release coupling



3. Stainless steel lance 1100 mm with flat jet nozzle and quick release coupling



4. operating manual
spare parts list

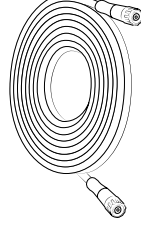

5. 10 m high-pressure hose

Optional:

Turbokiller 1100 mm with stainless steel pipe and quick release coupling

Item no.: 12.430-07

Water inlet filter

Item no.: 13.310

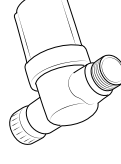

Design: therm series with hose drum

The therm series is a mobile high-pressure cleaner with an advanced arrangement system. Please see construction scheme for more details.

1. Ergonomically shaped handle
2. Holders for safety trigger gun with lance
3. Operating panel (refer to page 14)
4. Cable reel for the power supply cable
5. Storages for lances
6. Cleaning agent injection hose
7. Hose drum with 20 m steel weave high-pressure hose
8. Feed line water inlet, water hose connection
9. Storage bin for accessories
10. Integrated trolley takes steps and rough ground in its stride
11. Parking brake
12. large removable caps (refer to page 15)
13. Filler aperture for fuel

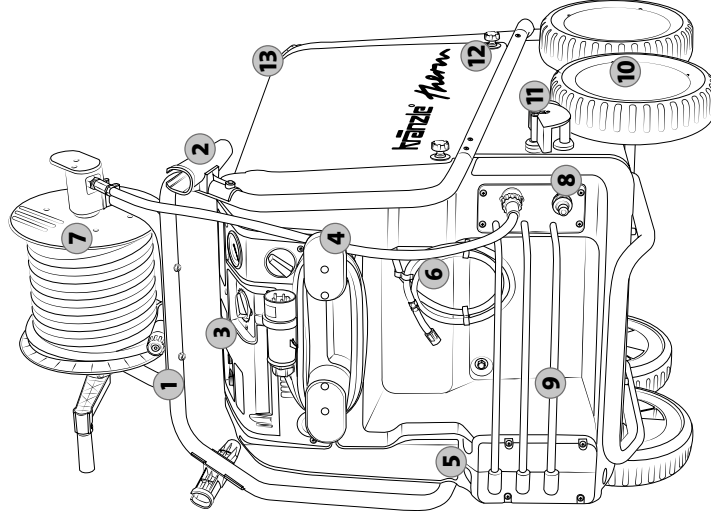
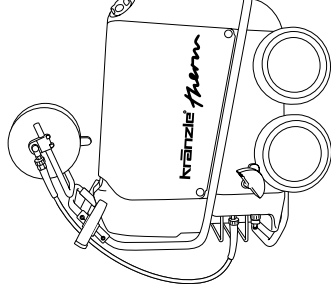
**This is what you have purchased: therm series with hose drum**

1. Kranzle high-pressure cleaner therm 715 therm 1017
2. Trigger gun with safety catch Starlet, short design with quick release coupling
3. Stainless steel lance 1100 mm with flat jet nozzle and quick release coupling
4. operating manual spare parts list

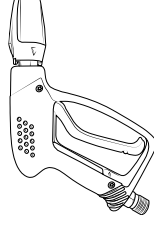
**Optional:**

Turbokiller 1100 mm with stainless steel pipe and quick release coupling

Item no.: 12.430-07

Water inlet filter

Item no.: 13.310

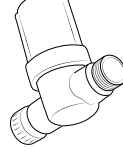

Design: Operating panel

The therm series provides a clear operating panel. Please see construction scheme for more details.

1. On/Off switch with motor protection and control light
2. Heater switch for hot water use
3. Short operating manual
4. Thermal switch for regulating water temperature
5. Large stainless steel pressure gauge
6. Detergent valve

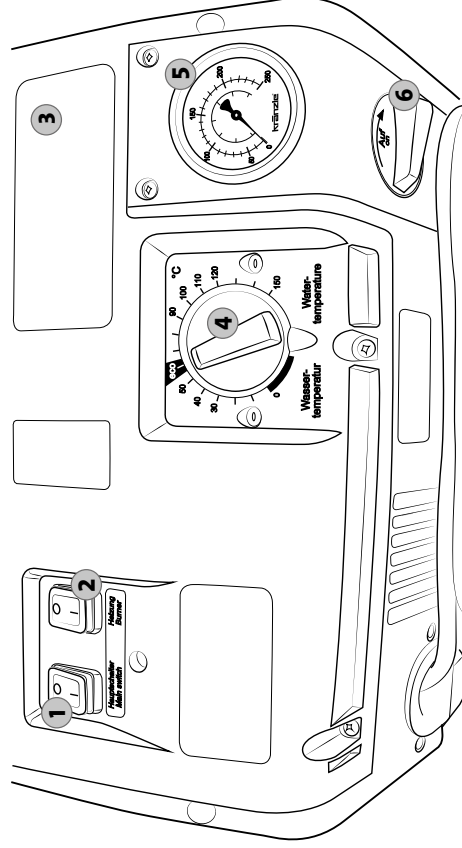
**Design: Interior fittings**

The therm series is a cold and hot water high-pressure cleaner. It provides a variety of functions and electronics located in the interior of the high-pressure cleaner. Please see construction scheme for more details.

1. Pump head made of special brass
2. infinitely variable pressure and quantity regulation
3. Oil drain hose
4. Water tank
5. Exhaust gas outlet
6. Combustion chamber
7. Fan with fuel pump
8. Fuel filter
9. Connecting hose between high-pressure pump and water tank
10. High-voltage ignition transformer
11. Display of the excess temperature sensor

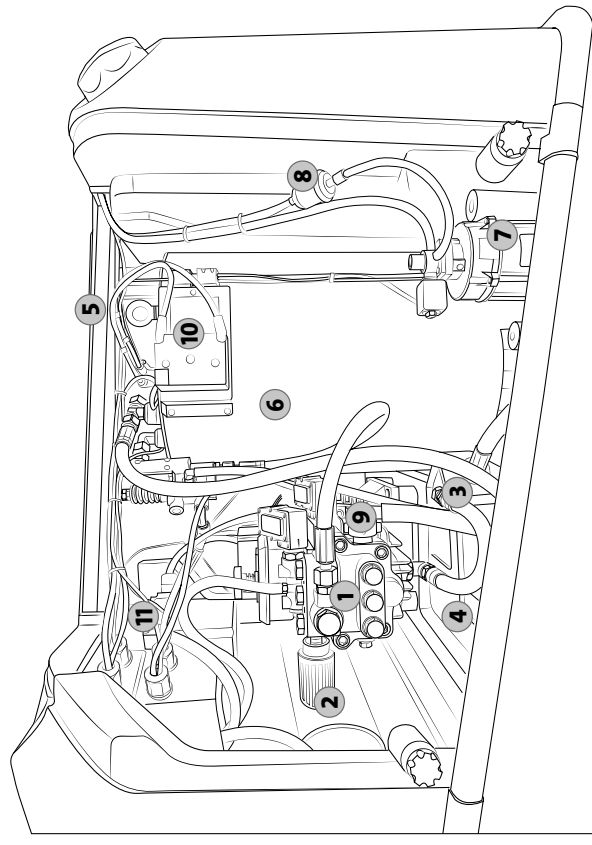

Range of application

Use high-pressure cleaner for cleaning purposes only using high-pressure jet with or without cleaning detergent.



Environmental, refuse disposal and water protection regulations must be observed!

Inspections

The high-pressure cleaner was finally inspected by the company Kränzle (refer to Kränzle final report).

The high-pressure cleaner must be inspected according to the "Guidelines for Liquid Spray Devices" at least once every 12 months by a qualified person, to ensure that continued safe operation is guaranteed. The results of the inspection are to be recorded in writing (see Inspection reports).



High-pressure cleaners used for commercial purposes have to be checked by a qualified person at least every 12 months!



The owner is to ensure that all safety-relevant components are in a serviceable condition before the high-pressure cleaner is used.

Accident prevention

The high-pressure cleaner is designed for accidents to be impossible if used correctly. The user is to be notified of the risk of injury from hot machine parts and the high-pressure jet. The "Guidelines for Liquid Spray Devices" must be complied with.



During the combustion process air is needed and exhaust gas emerges. If the high-pressure cleaner is operated in a confined space, precautions have to be taken to safely exhaust the fumes. Furthermore a sufficient ventilation has to be provided for.



During the combustion process air is needed and exhaust gas emerges. If the high-pressure cleaner is operated in a confined space, precautions have to be taken to safely exhaust the fumes. Furthermore a sufficient ventilation has to be provided for.

Oil change

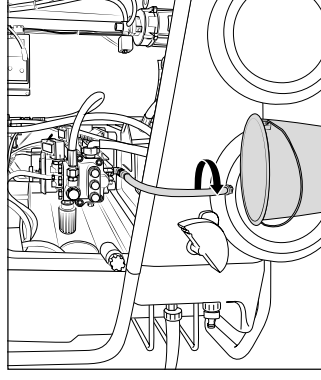

The first oil change should be carried out after approximately **50 operating hours**, then every year or after 250 operating hours. If the oil turns grey or white, you must change the oil. In case of exchanging oil being required, the oil drain screw must be opened above a container and the high-pressure cleaner be emptied. The oil is to be caught in the reservoir and disposed of in an approved manner.

New oil: 0,8 l

Kränzle high-performance transmission oil (Item no. 40.093 2) or Motor oil 10 W - 60 SAE.



Oil leakage

If oil leaks contact your nearest after-sales service (dealer) at once. (environmental damage, damage to the transmission).



In case of increased humidity or fluctuations in temperature development of condensed water is possible. If the oil turns grey or white, you must change it.

Decalcifying

Calcified heat exchanger use an unnecessary amount of energy because the water can only be heated slowly and the excess pressure valve feeds a part of the water back into the high-pressure pump circuit.

The calcified heat exchanger is known by the increased pipeline resistance.

Check pipeline resistance by disconnecting the lance from the trigger gun with safety catch and switching the high-pressure cleaner on. A full jet of water emerges from the gun. The high-pressure cleaner must be decalcified if the pressure shown on the stainless steel pressure gauge is greater than 25 bar.

Decalcify high-pressure cleaner as follows:

1. Decouple the lance from the trigger gun with safety catch and decalcify it separately.
2. Put detergent injector hose in a container with descaling agent.
3. Set detergent valve on highest concentration.
4. Set high-pressure cleaner at the main switch on "ON".
5. Hold the gun in a separate container and press the trigger gun with safety catch.
6. Wait until descaling agent escapes at the trigger gun with safety catch (recognizable by whitish colour)
7. Switch high-pressure cleaner at the main switch on "OFF" and let descaling agent work for 15 - 20 minutes.
8. Switch high-pressure cleaner at the main switch on "ON" again and rinse it for two minutes using clear water.
9. Please check whether the flow resistance has a lower value now again. If necessary, please repeat the decalcification process.



Decalcifiers are caustic! Observe the instructions for usage and accident prevention. Wear protective clothing to prevent the decalcifying agent from contacting your skin, eyes and clothing.

Fuel System

Your fuel may contain particles of dirt, or impurities or water may get into the tank during refuelling. To protect the fuel pump the high-pressure cleaner is equipped with a fuel filter. Check it regularly for dirt and exchange if applicable.

Check the tank for impurities on a regular basis. Clean the tank when necessary. Empty the fuel tank using the drainage screw at the bottom of the tank. Clean tank and fuel pipes thoroughly. Screw drainage screw back in.



Detergent and dirty fuel must be disposed of responsibly.



Check fuel system for dirt regularly.

No warranty is assumed for damage to the fuel system because of dirt. The laws and regulations shall be observed and met by the operator.

Adjusting ignition electrodes

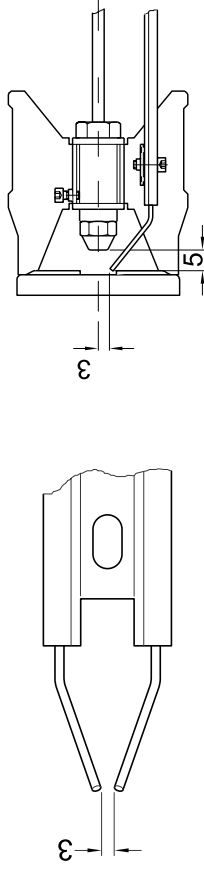

For a smooth ignition, the setting of the ignition electrode must be controlled regularly.



Excess temperature sensor

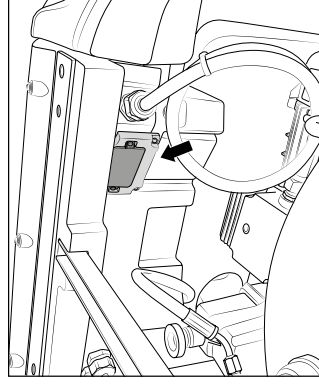

As an additional safety device the high-pressure cleaner is equipped with an excess temperature sensor inside the chimney. Should the safety devices as e.g. the float monitoring device be defective and the burner continues to heat although the heating coil does not conduct away heat a destruction of the heating coil would be inevitable. As soon as the temperature inside the chimney exceeds 260 °C the excess temperature release triggers and cuts out the appliance. The display of the excess temperature sensor is located on the back of the switchbox inside the high-pressure cleaner.



**Attention!
Immediately contact service in case of recurrence.**

Heat exchanger

The water is forced through a heating coil by the high-pressure pump. The fuel pump sucks the fuel oil from the fuel tank via a fuel filter and transports it to the injection nozzle. The heat exchanger is heated by a high-pressure fan heater. A ventilator draws in the cold, fresh air from the bottom end of the high-pressure cleaner and forces it upwards between the outer mantle and the inner mantle. In the process, the fresh air is pre-heated and the outer mantle of the heat exchanger is cooled. The pre-heated air is pressed through a mixing unit. Here finely atomized fuel is injected via a nozzle and mixed with the air. The electrodes located below then ignite the fuel-air mixture. The electrodes arranged below ignite the fuel-air mixture. The flame burns from top to bottom, turns round and the hot gas flows past the heating coil on its way back up. The burned gases collect in the exhaust chamber and are emitted from the exhaust gas outlet.

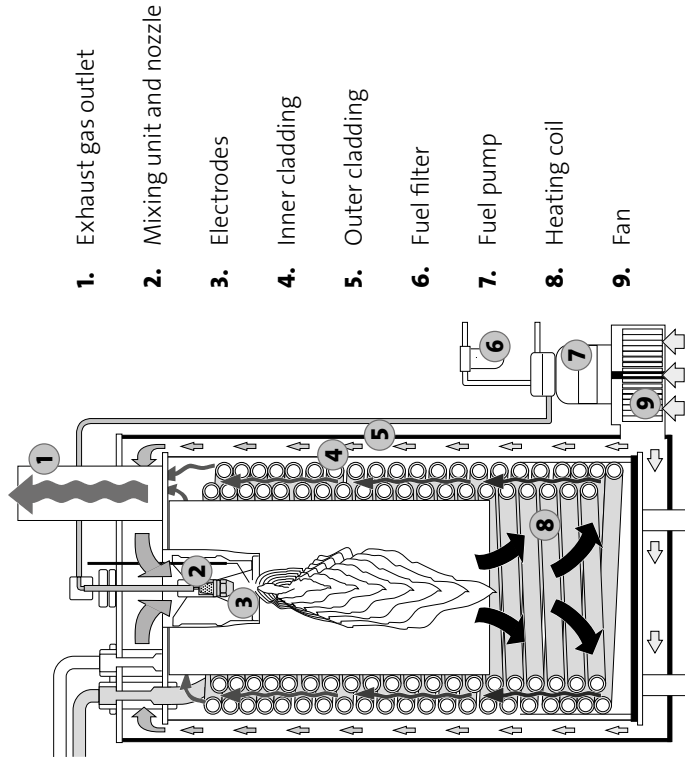

Please note: Lack of water

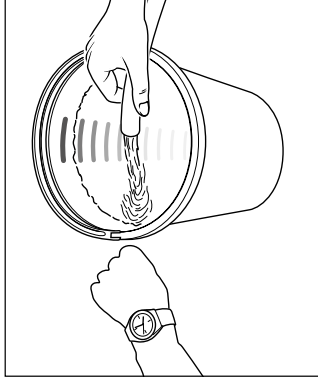

Lack of water occurs more often than you probably believe. The more powerful a high-pressure cleaner is the greater is the danger that a lack of water occurs. If there is only an insufficient amount of water available, cavitation (water-gas mixture) arises inside the high-pressure pump, which is normally noticed too late or even not at all. **The high-pressure pump will be destroyed.** Please check the available quantity of water by filling a bucket with liter scale for one minute.

Required minimum quantity of water (see technical data).

 **If the metered quantity of water is too small, you have to use a different water connection, guaranteeing the necessary output. Lack of water leads to an accelerated wear of the joints (guarantee void).**

Water supply

Please pay attention to the regulations of your waterworks company! In accordance with DIN EN 61770, the high-pressure cleaner may not be directly connected to the public drinking water supply lines. A brief connection however is permissible according to DVGW (German Association for Gas and Water Affairs) if a non-return valve with tube ventilator (Kranzle order no. 41.016 4) is built into the water supply. **Once the water has passed through the non-return valve it is no longer considered as drinking water.** Also indirect connection to the public drinking water supply lines is permissible by way of free emission in accordance with EN 61 770; e.g. by using a reservoir with a float valve. Direct connection to a non-drinking water supply line is permissible.



Insufficient quantity of electricity

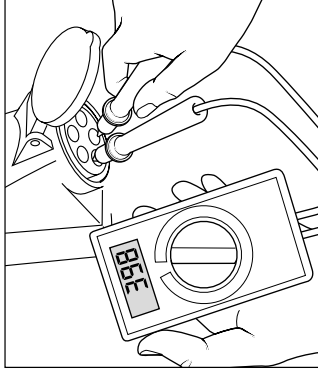

If there are too many collectors in your proximity connected to the network at the same time, the available voltage and the current intensity may decline. Consequently the motor of the high-pressure cleaner does not start or even blows. The power supply may also be insufficient if the power supply cable is too long or too thin. If extension cables are too long, this may lead to a voltage drop causing malfunctions or start-up difficulties.



Check the line fusing and have the voltage and the available current intensity checked by an expert in case of uncertainty (see technical data).

Electrical connection

The high-pressure cleaner is supplied with a 5 meters long power supply cable. The mains plug must be fitted to a standard grounded socket with a **30 mA** residual current operated device. The socket must be protected with a **16 A fuse** on the mains side. When using an extension cable, **this must have an earthed lead** which is properly connected to the socket. The conductors in the extension cable must have a minimum cross section of **1.5 mm²**. Plug connections must be of a spray-proof design, and may not be located on a wet floor. For extension cables of more than **10 m** in length, the minimum cross-section must be **2.5 mm²**. When using a cable drum, the power supply cable always must be unwound all the way.

Water and cleaning system

Water can be connected at mains pressure to the high-pressure cleaner. A float valve in the water tank regulates the water inlet. Then, the water is sucked by the high-pressure pump from the water tank and supplied to the lance under pressure. The high-pressure jet is formed by the nozzle at the end of the lance. Bypassing the water tank water can also be sucked directly out of a pressure-less container (see direct suction).



Environmental, refuse disposal and water protection regulations must be observed!

Safety jet pipe with safety trigger gun

The high-pressure cleaner can only be operated when the trigger of the safety deactivation trigger gun's trigger is actuated. When the trigger is pulled, the safety trigger gun opens. The liquid is then transported to the nozzle. The spray pressure increases and quickly reaches the operating pressure. When the trigger is released, the safety trigger gun closes and any further spraying of liquid from the safety jet pipe is prevented. The stainless steel pressure gauge must show 0 bar. The increase in pressure when the safety trigger gun is closed causes the pressure control valve-safety valve to open. The motor is switched off by the pressure switch. When the safety trigger gun is opened, the pressure control valve - safety valve closes, the motor is started and the high-pressure pump resumes pressure spraying from the safety jet pipe with the selected operating pressure.



The safety trigger gun is a safety device. Repairs should only be performed by qualified persons. Should replacement parts be required, use only components authorized by the manufacturer.

Pressure control valve - safety valve

The pressure control valve - safety valve protects the high-pressure cleaner from a build up of excess pressure, and is designed not to permit an excess pressure to be selected for operation. The limit nut on the handle is sealed with a spray coating. The operating pressure and spray rate can be steplessly adjusted by turning the handle.



Replacements, repairs, new adjustments and sealing should only be performed by qualified persons.

Motor protection switch

Motor is protected against overload by means of a motor protection switch. In case of motor overload or blocking, the motor of the high-pressure cleaner switches off automatically. If motor tends to switch off repeatedly, make sure to detect appears. Make sure to detect and remedy the cause of the failure.



Replacements and inspection work should only be performed by qualified persons **when the high-pressure cleaner is disconnected from the power supply**, i.e. with plug pulled out from the electrical socket.

Total stop system with delayed motor cut-off

After startup and switching on the high-pressure cleaner a green light is displayed. When opening the safety trigger gun the motor is started via a total-stop system. **When closing the safety trigger gun the motor is switched off only after 38 seconds.** The delayed switch-off is necessary because switching on and off motors frequently on high-pressure cleaners of this size may involve heavy load on the power network and cause increased wear of internal electrical parts.

Safety shutdown

If the high-pressure cleaner is accidentally not turned off after use or the safety trigger gun is not used for 20 minutes, the high-pressure cleaner automatically changes into safety state by deactivation. By operating the main switch once more, the high-pressure cleaner is activated again.

High-pressure hose and spray device

The high-pressure hose and spray device which are part of therm series equipment, are made of high quality material and engineered to conform with the operating conditions of the high-pressure cleaner and are duly labeled.

If replacement parts are required, only such parts that are authorized by the manufacturer may be used. The warranty is automatically void if spare parts of third-party providers are used! The high-pressure hose and spray device must be connected in a pressure-tight manner (without leakage).



The high-pressure hose may not be driven over, pulled excessively, or twisted. The high-pressure hose may under no circumstances be pulled over sharp edges. Defective high-pressure hoses must not be repaired (acc. to DIN 20022) but have to be replaced by new hoses approved by the manufacturer.



Prior to putting the high-pressure cleaner into operation make sure that all safety instructions be observed.

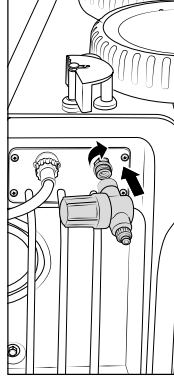

1. Install the water inlet filter (available as an option) at the water inlet.

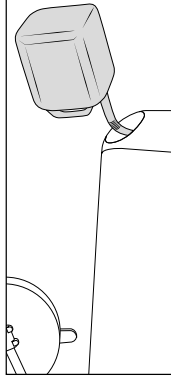

2. Prior to putting into operation fill fuel oil into the fuel tank.
(fuel oil EL DIN 51 603 or diesel fuel)
Filling quantity 25 liters

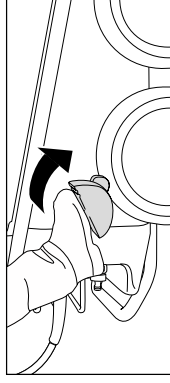

3. For moving the high-pressure cleaner to the place of use, please release locking break.

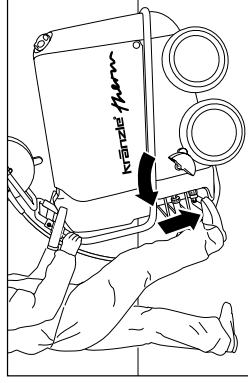

4. The therm series is a movable high-pressure cleaner with sturdy trolleys ideally suited for difficult terrain.

For steering the high-pressure cleaner put the foot against the tipping support and then pull the device towards you.



Please exclusively use the types of fuel listed above. Using other kinds of fuel may cause considerable risks (explosions).



Neither set up or operate the therm series in rooms where there is a risk of fire or explosion nor put it into puddles. Do not use the high-pressure cleaner under water. If, none the less, the high-pressure cleaner is operated in a hazardous area, the applicable safety regulations are to be observed.

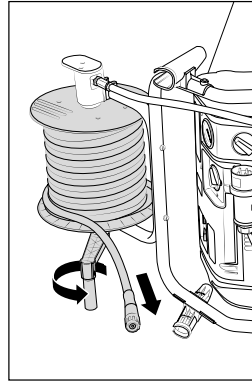

5. Unwind high-pressure hose straight and without nooses. For high-pressure cleaners with hose drum please release fixing of hose drum at first and fully uncoil it after that. (When extending the high-pressure hose please consider the maximum length of 20 m!)

 **In the case of high-pressure cleaner with hose drums, the high-pressure hose must always be unwound completely.**

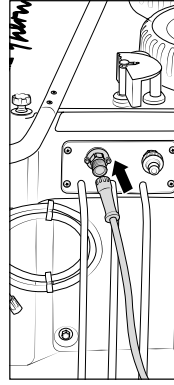

6. Without hose drum:
For high-pressure cleaners without hose drum the high-pressure hose included in the scope of the delivery must be screwed with the pump outlet in a tight and pressure tight manner.

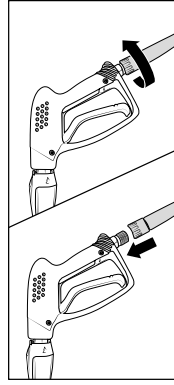

7. Tightly screw together high-pressure hose and safety trigger gun.

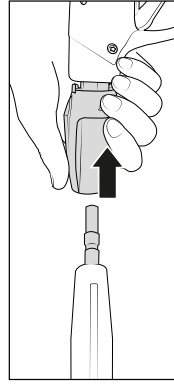

8. First pull back the retaining sleeve of the safety trigger gun, then insert lance into the plug coupling connection of the safety trigger gun.

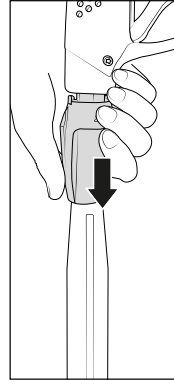

9. After insertion of the lance, release retaining sleeve and make sure that the lance is in a secure position.

Grease quick release nipple regularly using acid-free grease.

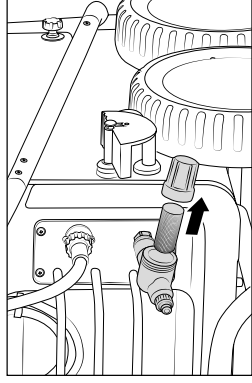

10. If using a water inlet filter check it for cleanliness prior to each startup.
Manually unscrew plug-in coupling. Take out the water inlet filter using needle nose pliers and thoroughly rinse it with clear water and clean it with the other parts.

 **Check the water inlet sieve for damage. Do not operate the high-pressure cleaner using the damaged filter.**

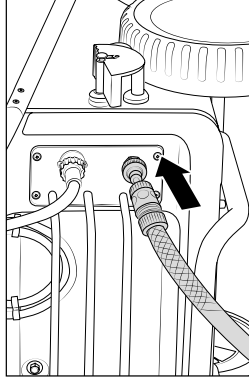

11. Connect the water hose to water inlet sieve. The high-pressure cleaner may be connected to a water mains (1-10 bar pre-pressure) with either cold or hot water (up to 60 °C). The therm 1017 series provides the opportunity of sucking in water out of a container (see direct suction).

Be careful when using hot water!

When running your high-pressure cleaner with hot water of 60 °C raised temperatures occur. Do not touch the metal parts of the high-pressure cleaner without safety gloves!

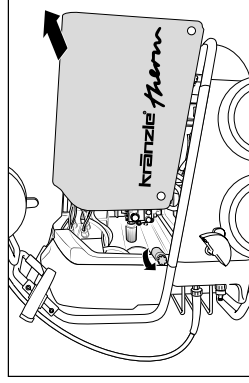

12. For getting access to the interior fitting of the high-pressure cleaner, loosen screws at the cover. Remove cap carefully.

Close cap properly prior to starting the washing procedure.

- 13. Each time check oil level at the oil dipstick prior to putting the high pressure cleaner into operation.**
Oil level must reach until the upper edge of marking "OK".

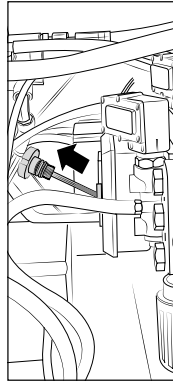

- 14. Adjust operating pressure infinitely using the rotary handle. The maximum pressure is factory-set.**

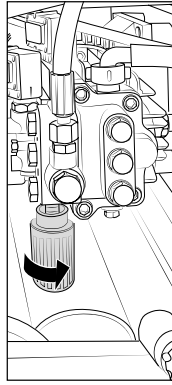

- 15. Connect to circuit (see technical data).**

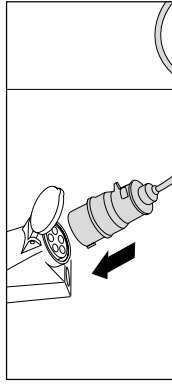

Do not touch the mains plug or any live parts with wet or moist hands.



- 16. When using the turbokiller lance (optional) make sure that lance points downward when starting.**

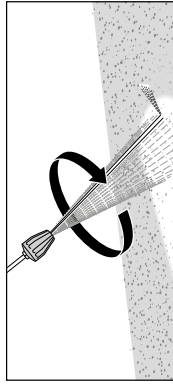

It is imperative that safety instructions be observed during use of the high-pressure cleaner.



Usage as a cold water high-pressure cleaner

- 17. Set temperature at the thermal switch on "0".**

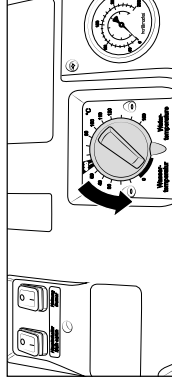

- 18. Detergent valve must be closed.**

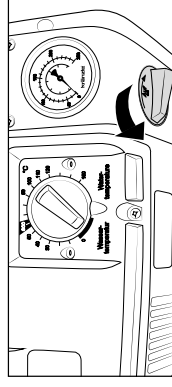

- 19. Switch on high-pressure cleaner with opened safety trigger gun. Bleeding of the high-pressure cleaner. Pull and release trigger of safety trigger gun several times. Start cleaning task.**

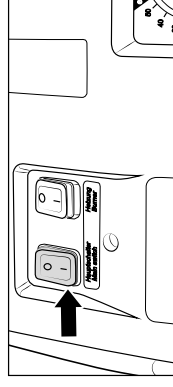

- 20. When starting the cleaning process do not aim the water jet towards the object you want to clean for at least 30 seconds. Maybe the water inside the combustion chamber has changed colour due to the rest time.**

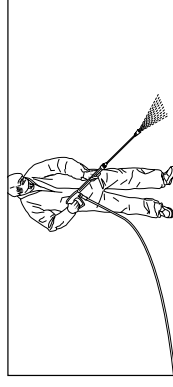

Usage as a hot water high pressure cleaner

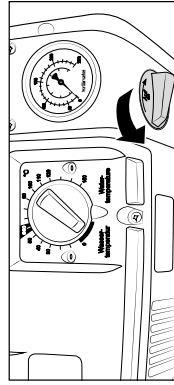

21. Detergent valve must be closed.

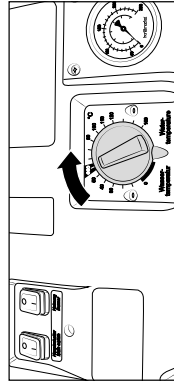

22. Set desired temperature at the thermostat. (Min. temperature 40 °C)
At eco level, the high-pressure cleaner works in the most economic temperature range.

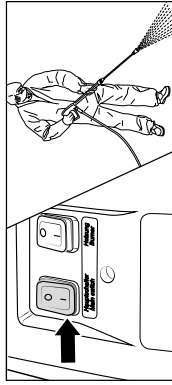

23. Switch on high-pressure cleaner with opened safety trigger gun. Bleeding of the high-pressure cleaner: Pull and release trigger of safety trigger gun several times.

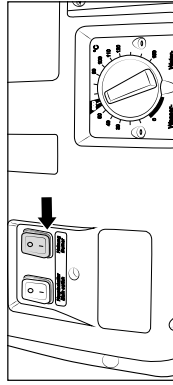

24. Switch on heater switch. The water is heated up and constantly kept at the set temperature.
Start cleaning task.



During high-pressure operation (above 30 bars) the temperature may not exceed 90 °C.



**During steam operation the pressure may not exceed 30 bar!
To reach the steam level (above 90 °C water temperature) adjust the pressure below 30 bar and choose by means of the thermostat the desired temperature of up to max. 150 °C.**

Direct water extraction

Due to the suction capacity of its high-pressure pump (up to 2.5 m suction height, max. hose length 3 m) this high-pressure cleaner can suck in water for cleaning purposes from separate containers or ponds. In this case the water tank must be bypassed.

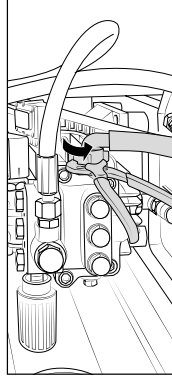

1. Unscrew connecting hose between high-pressure pump and water tank.

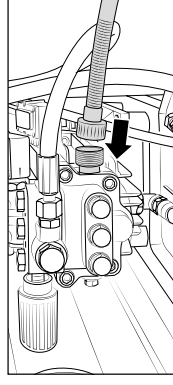

2. Screw suction hose with suction filter (Item.-no. 15.038 3) with connecting hose using a spreaded steel pipe fitting (Item.-no. 46.004).

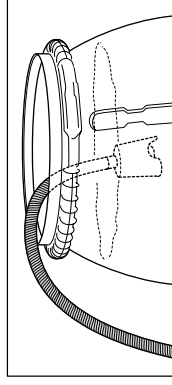

3. Put filled suction hose into the water-filled container and start the cleaning job. **Use clean water only! Never suck in water containing chlorine! Do not suction air!**



Prior to starting the first suction the high-pressure pump and the suction hose has to be filled with water!

Note

Depending on the water quality it may occur after a prolonged standstill that the valves get sticky. Consequently the high-pressure cleaner cannot properly suck in water from a container. In this case connect a hose with pressurized water to the pump inlet. Having started the high-pressure cleaner the pressurized water opens the valves and the machine resumes sucking in water from the container. Now you can carry on with your cleaning task as usual.

Suction of additives

Due to the water tank fitted to the therm 1017 series it is now possible to directly suck the detergent into the high-pressure pump thus reducing output loss and increasing the efficiency considerably.

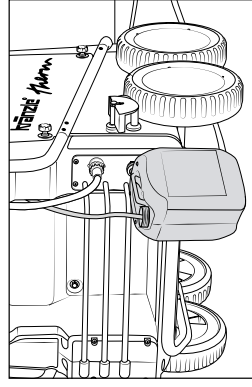

1. Put detergent injector hose in a container with additive.

2. Dosing of detergent is done by turning the detergent valve.

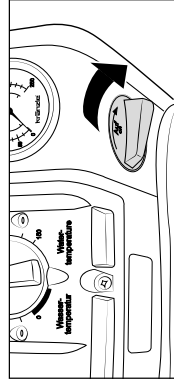

By closing the detergent valve the supply of detergent is stopped.

Rinse high-pressure cleaner after using the detergent with open trigger gun with safety catch using clear water.

1. Switch off the high-pressure cleaner
2. Cut off the water supply
3. Open the safety trigger gun catch briefly until the pressure is released
4. Apply safety catch on the trigger gun
5. Remove high-pressure hose and safety trigger gun
6. Emptying high-pressure pump: Hold high-pressure hose and switch motor on until water jet stops escaping at the outlet.
7. Pull the plug from the socket
8. Clean high-pressure hose and wind up without loops, Fix hose drum
9. Clean and wind up the power supply cable
10. Clean the water inlet sieve
11. Apply locking brake
12. Store high-pressure cleaners in frost-free rooms in winter



Only open detergent valve if detergent injector hose sticks in a liquid! Sucked air leads to destruction of the pump seals of the high-pressure cleaner (No warranty)!



The pH value neutral 7-9 is prescribed for the additive. Only use additive suitable for high-pressure cleaners. Observe specifications of detergent manufacturer! E.g.: protective equipment, rules for waste water treatment etc.



Attention solvents!

Never suck in liquids containing solvents like varnish solvents, petrol, oil or similar liquids! Seals inside the high-pressure cleaner are no resistant against solvents! The spray mist of solvents is highly inflammable, explosive and poisonous.



Frost protection

For protecting the high-pressure cleaner against frost please empty it completely. Separate high-pressure cleaner from water supply and switch it on. By opening the safety trigger gun the high-pressure pump presses water out of the water tank. **However, do not allow the high-pressure cleaner to operate without water for more than one minute.** Fill the anti-freeze agent into the water box and turn on the high-pressure cleaner. Wait with opened gun until the agent spurts out of the nozzle.

Problem

No water from nozzle although the high-pressure cleaner is running.
The stainless steel pressure gauge shows full pressure.

Cause

Most likely the nozzle is blocked.

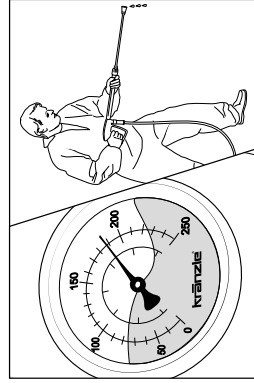

The stainless steel pressure gauge shows full pressure, but from the nozzle comes only little water or no water at all.

(Inside the stainless steel pressure gauge is no water but a filling with glycol to damp the vibration of the pointer.)

Proceeding:

Switch off the high-pressure cleaner. Pull plug from the socket. Operate safety trigger gun catch several times to decrease the pressure.

Unscrew safety trigger gun and lance first, then rinse high-pressure hose to remove possible soiling.

Check water inlet filter for soiling.

If the problem still exists, take wire (paper clip) and push through nozzle opening. If cleaning by means of a wire is not successful, replace lance.

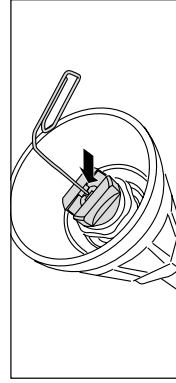

Pull plug from socket prior to starting any repair work!

Problem

Irregular jet from nozzle.
The stainless steel pressure gauge shows low pressure.

Cause

Most likely the valves are soiled or sticky.

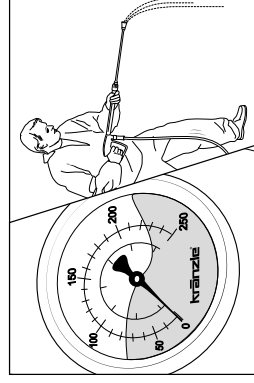

The stainless steel pressure gauge shows low pressure despite fully turned up pressure regulation. The water from the lance comes in squirts. The high-pressure hose vibrates.

(Inside the stainless steel pressure gauge is no water but a filling with glycol to damp the vibration of the pointer.)

Proceeding:

Unscrew all 6 valves, one after the other (hexagonal brass screws, 3 in a row, vertically and horizontally)

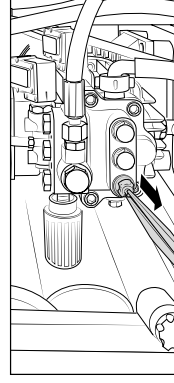
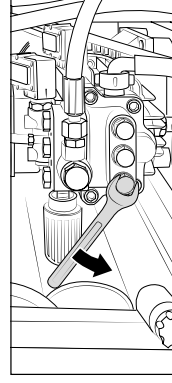

Take out valve body and O-ring by means of needle nose pliers. Check O-ring for damage. In case of a damage the O-ring has to be replaced.

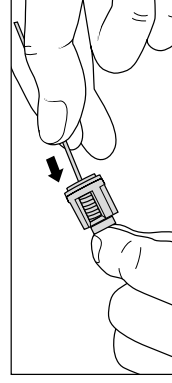

Take a wire (paper clip) and clean valves under running water.

Do not forget the O-ring during reassembly!

Problem

After closing the safety trigger gun the high-pressure cleaner keeps switching on and off.
The stainless steel pressure gauge continuously displays full pressure.

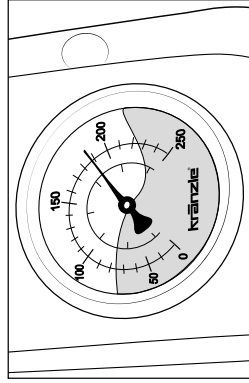
Possible cause No. 1
Leakage.

Having closed the trigger gun with safety catch, the high-pressure cleaner must shut down and the stainless steel pressure gauge must show „0“. If not shut down and the stainless steel pressure gauge continuously shows full pressure, this could be due to leakage at the high-pressure pump, at the pressure switch, at the high-pressure hose or at the trigger gun with safety catch.

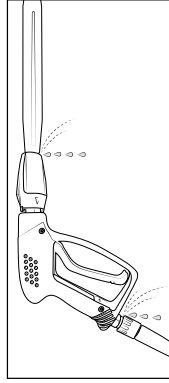
**Proceeding:**

Check connections from the high-pressure cleaner to the high-pressure hose and from the high-pressure hose to the safety trigger gun and also the connection between lance and safety trigger gun for tightness.

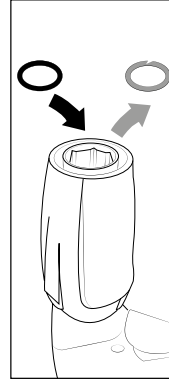

Switch off the high-pressure cleaner. Shortly press the trigger of the safety trigger gun to decrease the high-pressure cleaner. Unscrew high-pressure hose, safety trigger gun and lance and check the O-rings. If the O-rings are damaged they have to be replaced.



In case of a leakage there is no guarantee for possible consequential damages.

Problem

After closing the safety trigger gun the high-pressure cleaner keeps switching on and off.
The stainless steel pressure gauge continuously displays full pressure.

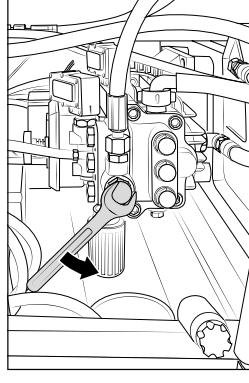
Possible cause No. 2
The non-return valve is defective.**Proceeding:**

Switch off the high-pressure cleaner and pull plug from socket. Stop water supply. Unscrew pump outlet.

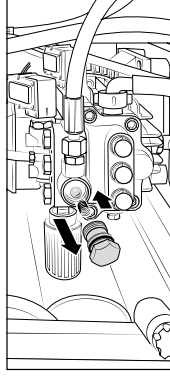

Remove check body and check O-Ring for soiling or damage. Also check seal inside pump housing for soiling or damage.

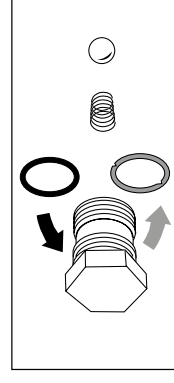

If sealing rings are defective replace O-rings at once.



There is no guarantee if the high-pressure pump is damaged by defective O-rings due to air induction or lack of water (cavitation).

Summary of additional causes of malfunction

Problem Cause

Water supply

- Water tank runs over Float valve is dirty/ defect
- Water tank does not fill completely Float valve is defect, water inlet filter dirty, water intake too low
- high-pressure pump does not suck Valves sticky or are dirty, suction hose leaks, detergent valve is open or leaks, Check hose connections, high-pressure nozzle is clogged
- Test: Check water and additive suction system for tightness Connect water inlet directly to the high-pressure pump (2-8 bar pre-pressure). Disconnect suction lines below the high-pressure pump.

high-pressure pump

- high-pressure pump makes lots of noise: Operating pressure is not reached high-pressure pump sucks air, check suction connections and high-pressure nozzle, check O-rings and valves, check valves, stainless steel pressure gauge is defect. Unloader: check stainless steel seat and ball. Check seals on the control piston
- Water drops from the high-pressure pump Replace sleeves in the high-pressure pump. Replace O-rings
- Pressure is too low Stainless steel seat, ball, O-ring in unloader is dirty or defect. Stainless steel pressure gauge is defect



In case of repeated malfunction or should you be incapable of resolving it by yourself, please contact our customer service.



Pull plug from socket prior to starting any repair work!

Oil drops from the transmission

Check/replace oil seals.
Check plunger and plunger guides.
Check water supply, since water deficiency or air suction can cause damage to seals and O-rings (detergent valve leaks).

high-pressure cleaner start/stop
high-pressure cleaner does not switch off

Check return body and O-ring in unloader of the valve housing.

Test: Jumper pressure switch
Check pressure switch. Check micro switch.
Check cable connections.

high-pressure cleaner does not start or stopps during operation
Check electricity supply, check main switch, check cable connections, board is defect. Switch off by overcurrent release.

high-pressure cleaner does not

Check electricity supply, check main switch, check cable connections. Switch off by overcurrent release.

Leakage

- Trigger gun with safety catch drips high-pressure hose drips Clean high-pressure nozzle Replace seals. Replace O-ring under screwed connection.
- Stainless steel pressure gauge shows pressure but no water comes out Clean high-pressure nozzle

Sucking detergent

- Detergent is not sucked high-pressure pump sucks air. Check hose clips.
Test: Connect water line to the high-pressure pump. No water must come from the detergent hose

Problem Cause

Heating (burner)

Fuel pump/fan operates, but burner does not heat
 Set water temperature is reached. Increase temperature on thermostat with rotary control switch. Open trigger gun with safety catch, until temperature drops. Fuel tank is empty. Fuel filter is dirty/fuel nozzle is dirty.

Fuel pump/fan does not operate.
 Fuel pump makes loud noises
 Coupling between burner motor and fuel pump is defect. Fan/fuel pump motor is defect. Check electrical equipment. Check fuse in electric box. Water in fuel tank. Dirt or rust in the fuel pump. Clean tank. Replace fuel pump.

Smoke during operation or after switching off
 Fuel is dirty. Nozzle or nozzle stock leaks. Water in tank.

Solenoid valve on the fuel pump does not open
 Check pressure switch (black). Solenoid valve is defect or dirty. Clean filter, connections and fuel pump. Setting is wrong. Clean or replace fuel nozzle.

Ignition does not function
 Check ignition cable. Charring of plug-in contacts by moisture. Cable is broken. Check ignition transformer connections.
 Transformer is defect. Ignition electrode has been falsely set or burnt up.

Ventilator does not operate.
 Fan-/fuel pump motor is defect. Check electrical equipment. Check fuse in terminal box. Coupling between burner motor and fuel pump is defect.

The control board

The control board is equipped with two LEDs for trouble shooting.

LED D3:

1. permanently illuminated:
 if the overcurrent release has tripped.

2. blinking:

if the fuel flow valve detects only a low quantity of fuel in the tank or if it is defective.

LED D4:

1. illuminated:

if the burner has been released but the flame is not burning.
 if the flame starts burning within 2 seconds, the LED goes out.
 if the LED does not go out the combustion has to be checked.
 if the LED is not illuminated at all, the flame sensor has to be checked.



Nevertheless the cleaner can be used as a cold water high-pressure cleaner even if the burner is switched off.

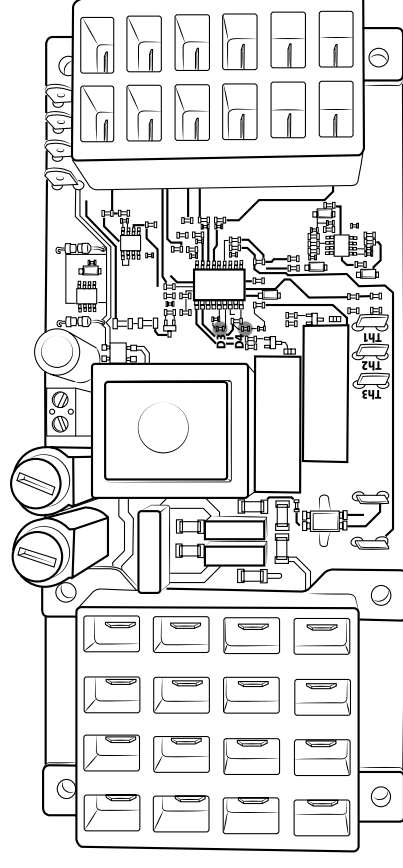

1. Float valve, water inlet
2. Water tank
3. Detergent valve
4. high-pressure pump with integrated unloader valve
5. Flow-Safety-Block with integrated safety valve for heating coil and flow monitoring device
6. By-Pass line
7. Fuel pump with solenoid valve
8. Fuel filter
9. Fuel tank

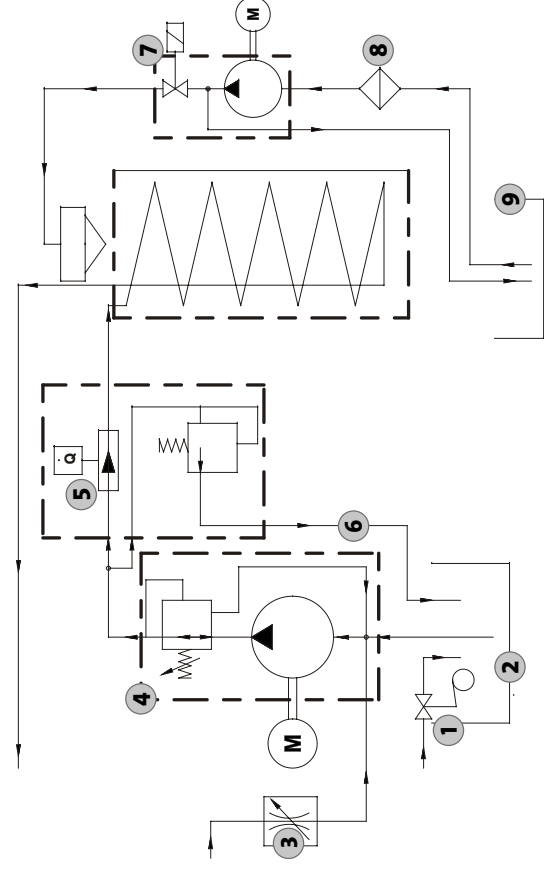

Warranty

Our warranty obligation is understood to exclusively cover material and manufacturing defects; wear is not covered by warranty.

The high pressure cleaner is to be operated in conformity with this Operating manual. The operating manual is deemed to be part of the warranty provisions. This warranty shall only apply on condition of proper use of original-Kraenzle component parts and original-Kraenzle replacement parts.

With regard to legal warranty claims, the limitation periods of the respective countries shall apply.

In the event of any warranty claims, please have your accessories and purchase voucher ready before contacting your local dealer or the nearest authorized customer service point, which you can also find in the internet under www.kraenzle.com.

In case of any modifications on the safety installations or in case of exceeding the temperature and speed limit, any warranty claims shall become invalid - this shall also apply to undervoltage, lack of water and use of wastewater as well as any other faulty or inappropriate operation of the high pressure cleaner.

Pressure gauge, nozzle, valves, sleeves, high pressure hose and spray equipment are wear parts and are not covered by the warranty obligation.

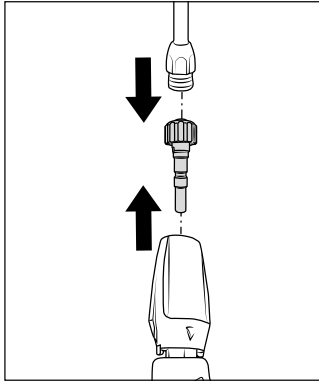

Adapter for accessories with screw connections

- with quick release nipple
- For item no. 12.400 (fig. left)
- 400 mm extension
 - with grip plates

Item no. 12.400 (fig. left)
Item no. 12.401 (fig. right)

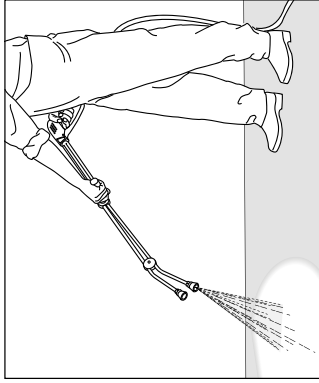

Double lance

- with ISO handle
- with quick release nipple
- Low pressure nozzle D3035 as standard

Item no. 12.133

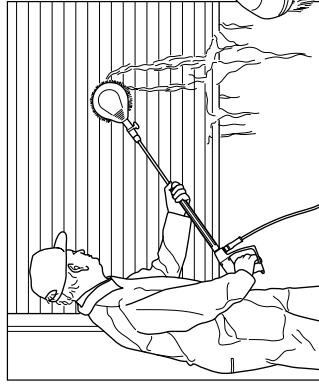
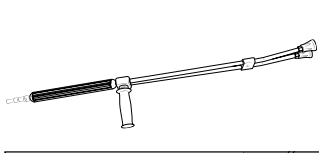

Rotating washing brush

- 400 mm
- Stainless steel extension
- Brush head Ø 180 mm
- Nozzle size 3.2 mm

*in combination with adapter only

Item no. 41.0501

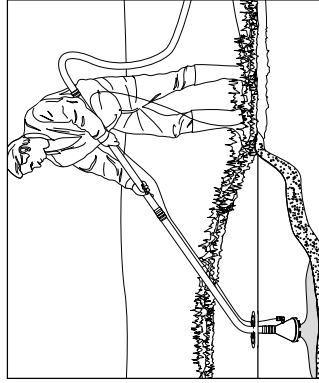

Sludge suction cleaner

- from stainless steel
- max. suction height 3 m
- Nozzle system D00045

Item no. 41.801

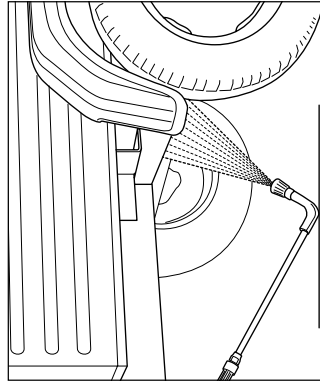
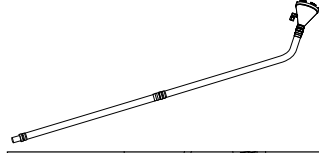

Underbody lance*

- Stainless steel pipe
- 1000 mm extension
- Nozzle system 4007

*in combination with adapter only

Item no. 41.075

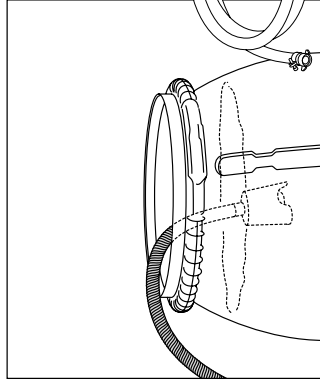

Suction hose with suction filter

- with return valve
- hose length 3 m

Item no. 15.038 3



The high-pressure cleaner accessories are safety components!
Any warranty will be void if parts not authorised by Kränzle are used.



Please indicate the technical data of the high-pressure cleaner (device type) when placing your order.

High-pressure cleaners for industrial use have to be checked by an expert every 12 months!

Inspection report on annually carried out Labour Safety Inspection (UVV) according to the Guidelines for Liquid Spray Equipment. (This inspection sheet serves as proof for the completion of the retest and must be kept carefully!)

Kranzle-test seals: item no.: UVV200106

Owner: Type:
 Address: Serial no.:
 Repair order no.:

Scope of inspection

	o.k.	yes	no	repaired
Type plate (on hand)				
Operating manual (on hand)				
Protective covering, Protective device				
Pressure line (tightness)				
Stainless steel pressure gauge (function)				
Float valve (tightness)				
Spraying device (marking)				
High-pressure hose / connector (damage, marking)				
Safety valve opens at 10 % / 20 % exceeding				
Pressure reservoir				
Heating oil line (tightness)				
Solenoid valve (function)				
Thermostat (function)				
power supply cable (damage)				
Netzanschlusskabel (Beschädigung)				
Power plug (damage)				
Protective conductor (connected)				
On / Off switch				
Water quantity safety device (function)				
Used chemicals				
Allowed chemicals				

Inspection data	determined value	set value
High-pressure nozzle		
Operating pressurebar		
Switch off pressurebar		
Smoke spot number cc. to Bacharach scale		
CO ² -value % CO ²		
Efficiency rating %		
protective conductor resistance not exceeded/value		
Insulation		
Leakage current		
Safety trigger gun locked		

Inspection result (check)

- The high-pressure cleaner was checked by an expert according to the Guidelines for Liquid Spray Equipment, the defects found have been rectified so that the Labour Safety can be confirmed.
- The high-pressure cleaner was checked by an expert according to the Guidelines for Liquid Spray Equipment. The Labour Safety cannot be confirmed unless the defects found are rectified by repair or replacement of the faulty parts.

The next retest according to the Guidelines for Liquid Spray Equipment has to be carried out by: Month Year
 Place, Date Signature

High-pressure cleaners for industrial use have to be checked by an expert every 12 months!

Inspection report on annually carried out Labour Safety Inspection (UVV) according to the Guidelines for Liquid Spray Equipment. (This inspection sheet serves as proof for the completion of the retest and must be kept carefully!)

Kranzle-test seals: item no.: UVV200106

Owner: Type:
 Address: Serial no.:
 Repair order no.:

Scope of inspection

	o.k.	yes	no	repaired
Type plate (on hand)				
Operating manual (on hand)				
Protective covering, Protective device				
Pressure line (tightness)				
Stainless steel pressure gauge (function)				
Float valve (tightness)				
Spraying device (marking)				
High-pressure hose / connector (damage, marking)				
Safety valve opens at 10 % / 20 % exceeding				
Pressure reservoir				
Heating oil line (tightness)				
Solenoid valve (function)				
Thermostat (function)				
power supply cable (damage)				
Netzanschlusskabel (Beschädigung)				
Power plug (damage)				
Protective conductor (connected)				
On / Off switch				
Water quantity safety device (function)				
Used chemicals				
Allowed chemicals				

Inspection data	determined value	set value
High-pressure nozzle		
Operating pressurebar		
Switch off pressurebar		
Smoke spot number cc. to Bacharach scale		
CO ² -value % CO ²		
Efficiency rating %		
protective conductor resistance not exceeded/value		
Insulation		
Leakage current		
Safety trigger gun locked		

Inspection result (check)

- The high-pressure cleaner was checked by an expert according to the Guidelines for Liquid Spray Equipment, the defects found have been rectified so that the Labour Safety can be confirmed.
- The high-pressure cleaner was checked by an expert according to the Guidelines for Liquid Spray Equipment. The Labour Safety cannot be confirmed unless the defects found are rectified by repair or replacement of the faulty parts.

The next retest according to the Guidelines for Liquid Spray Equipment has to be carried out by: Month Year
 Place, Date Signature

High-pressure cleaner (device type):

.....

- All lines connected
- Hose clamps tight
- Screws all installed and tightened
- Ignition cable plugged in
- Visual check carried out
- Brake function checked

Leak test

- Water tank filled and checked
- Water inlet checked for tightness
- Float valve function checked
- High-pressure cleaner checked for tightness under pressure

Electrical check

- Earth line checked

Current intake

Operating pressure
Cutting-off pressure

Result of flue gas analysis

- Steam phase checked
- Detergent valve checked
- Start/Stop automatic and re-run delay checked
- Fuel shortage switch checked
- Thermostat function checked
- Brake function checked

Water inlet temperature in °C

5 6 7 8 9 10 11 12 13 14 15

Water outlet temperature in °C

60 62 64 66 68 70 72 74 76 78 80 82 84 86 88 90

Fuel pressure 10 bar

Measured smoke spot number

0 1 2 3

- Safety equipment sealed with lacquer

- The high-pressure cleaner fulfills all requirements according to this inspection sheet

Name of inspector:

Date:

Signature:

We hereby declare that the design of
the high-pressure cleaners:

Kränzle therm 715
Kränzle therm 1017

Nominal flow:

Kränzle therm 715: 700 l/h
Kränzle therm 1017: 1000 l/h

technical specifications available
from:

Fa. Josef Kränzle GmbH & Co. KG
Manfred Bauer
Rudolf-Diesel-Str. 20, 89257 Illertissen

comply with the following guidelines
and their amendments for high-
pressure cleaners:

Machinery directive 2006/42/EC
EMC-directive 2004/108/EC
Noise directive 2005/88/EC,

Art. 13 HP water spraying machines
Annex 3, part B, chapter 27

Sound level measured:

therm 715: 88 dB (A)
therm 1017: 89 dB (A)

Sound level guaranteed:

therm 715: 90 dB (A)
therm 1017: 91 dB (A)

Applied conformity assessment
procedure:

Annex V, Noise directive
2005/88/EC

Applied specifications and standards:

EN 60 335-2-79: 2015
EN 55 014-1: 2006
EN 61 000-3-2: 2014
EN 61 000-3-3: 2013

Josef Kränzle GmbH & Co. KG
Rudolf-Diesel-Straße 20
D - 89257 Illertissen

Illertissen, March 30, 2017

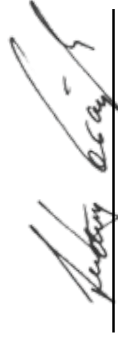

Ludwig Kränzle
(Managing director)

kranzle®

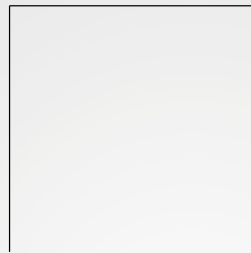

Josef Kränzle GmbH & Co. KG

Rudolf-Diesel-Straße 20
89257 Illertissen (Germany)

sales@kraenzle.com

© Kränzle 20.03.2017, Item no. 30.82.01 / Subject to technical modifications and errors.

■ **Made**
■ **in**
■ **Germany**

www.kraenzle.com