

SPECIFICATION SHEET

BLACK EDITION 100 X 75

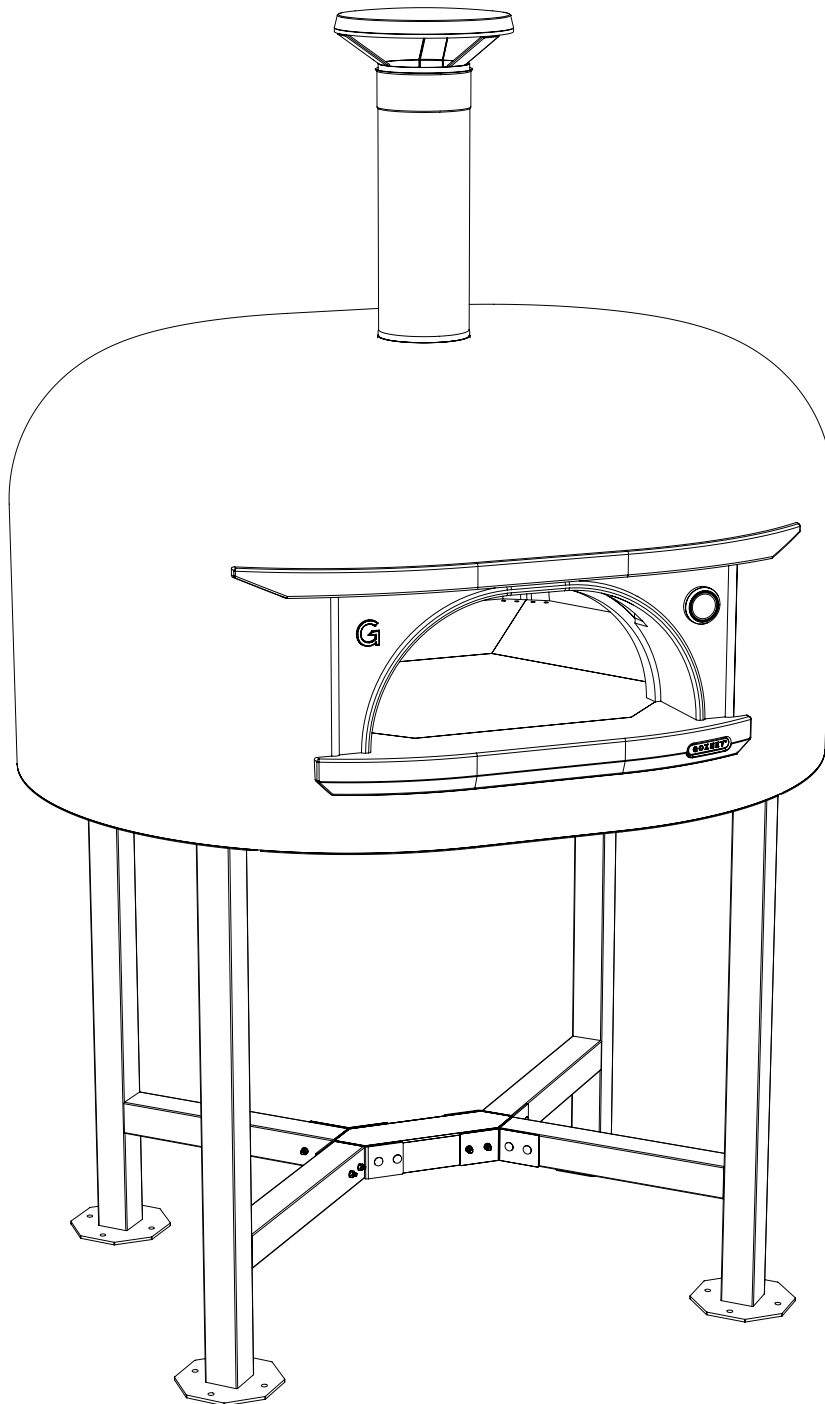

MASTER SERIES

BLACK EDITION 100 X 75

PRODUCT SPECIFICATION

Internal oven dimensions	Width 1000mm x Depth 750mm x Height 350mm
Pizza capacity	4 x 12" Pizzas
Door size	Width 510mm x Height 205mm
Oven weight	630Kg
Oven wall thickness	65mm
Clearance	Sides: 50mm Front: 1000mm Top: 350mm
Extraction	150mm Flue Spigot
Extraction flow rate	350CFM

All dimensions in mm

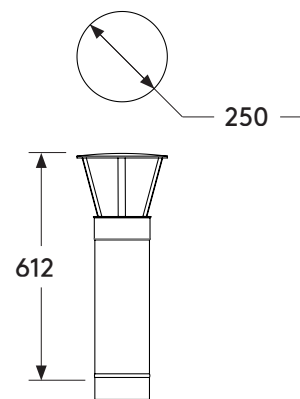
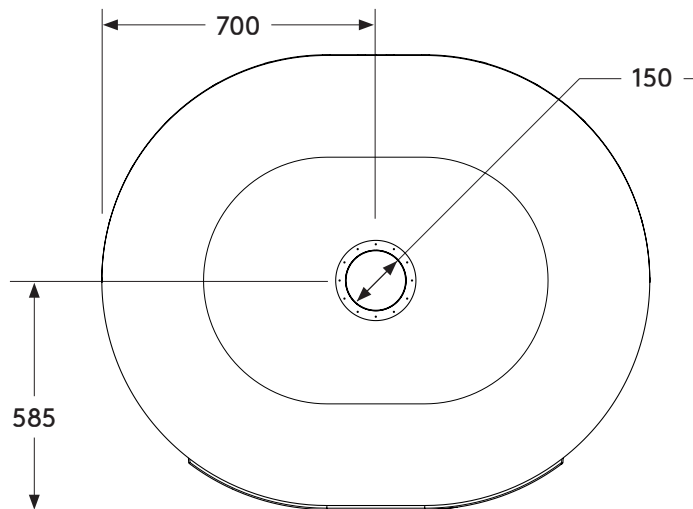

Flue pipe and rain cap.

