



# BARKBATH™

## PORTABLE DOG BATH TOOL

---

USER GUIDE  
1842 SERIES



More of a video person? Look for this icon and go online for an instructional how-to video at

**[BISSELL.com/videos](https://www.bissell.com/videos)**

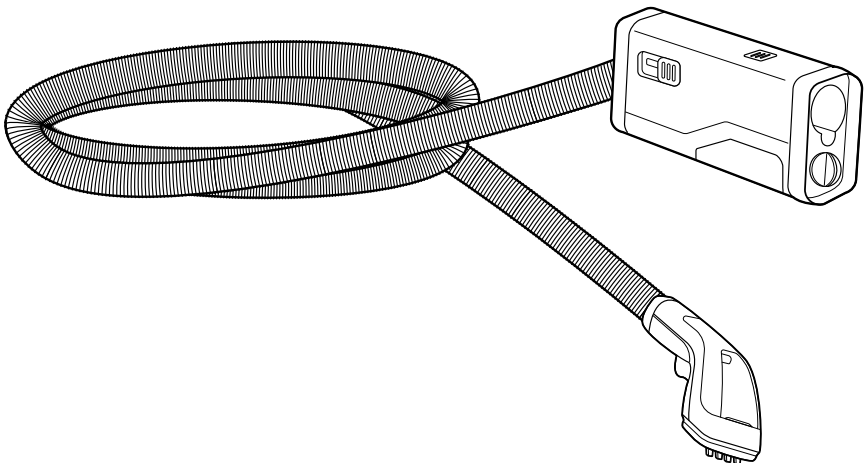

# IMPORTANT SAFETY INSTRUCTIONS

## READ ALL INSTRUCTIONS BEFORE USING YOUR BARKBATH™ TOOL.

When using an electrical appliance, basic precautions should be observed, including the following:

## WARNING

### TO REDUCE THE RISK OF FIRE, ELECTRIC SHOCK, OR INJURY:

- » Use only warm tap water. Do not use heated water.
- » Do not expose to rain. Store indoors.
- » Do not allow to be used as a toy. Close attention is necessary when used by or near children.
- » Do not use for any purpose other than described in this User's Guide.
- » Do not immerse appliance in water or place in area where splashing may occur.
- » Liquid must not be directed towards equipment containing electrical components.

## WARNING

Refer to the user guide that came with your BISSELL product for complete instructions and important safety notices regarding use of the appliance.

# SAVE THESE INSTRUCTIONS FOR FUTURE USE

This attachment is for household use only. Commercial use of this unit voids the manufacturer's warranty.

### Recommended for Use With:

- » BISSELL Little Green (1400 model series, except 1425)
- » BISSELL SpotBot (33N8 model series)
- » BISSELL SpotClean (5207 model series)
- » BISSELL SpotClean Cordless (1570 model series)
- » BISSELL SpotClean Pro (3624 model series)

### NOT for Use With:

- » BISSELL Carpet Cleaners with built-in heaters such as models 1425 and 50Y6
- » BISSELL Full Size Upright Deep Cleaners
- » Non-BISSELL Branded Deep Cleaners
- » BISSELL SpotLifter (all series)

# Thanks for buying a BISSELL BarkBath™ Tool!

We love pets, so we're excited to share one of our newest innovative pet products with you: the BarkBath™ dog bathing tool. Because the BarkBath™ easily attaches to any BISSELL portable cleaner, you can bathe your dog where it's most convenient, making bath time easier and less stressful for you and your pet.

We want to make sure your BarkBath™ works as well in years to come as it does today, so this guide includes tips on usage, maintenance, and — if there is a problem — basic troubleshooting. Once your dog is acclimated to the cleaner and you've got a bathing area prepared, a few simple assembly steps are all it takes to get started!

## What's In The Box?

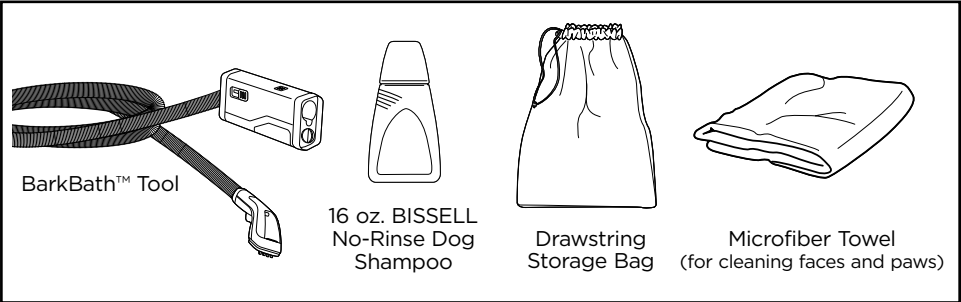

Safety Instructions . . . . .	2	Maintenance & Care . . . . .	11-12
Getting Ready . . . . .	4	Troubleshooting . . . . .	14
Product View . . . . .	5	Warranty . . . . .	15
Assembly . . . . .	6	Service . . . . .	15
Operations . . . . .	7-10	Product Registration . . . . .	16

# Before You Get Started

## Helpful Tips to Get Ready:

- Always use a BISSELL no-rinse dog shampoo.
- If your dog has long hair, brush your pet's hair before bathing.
- When selecting an area to bathe your dog, choose a place where your pet feels comfortable and safe. Usual choices include the kitchen, utility room, garage, or family room.
- Lay down a separate blanket or towel where you will be bathing your dog.
- When placing the cleaner on the floor, place a mat or towel underneath. This will help absorb and dampen the sound for your dog.
- Keep the cleaner away from walls and cabinets to facilitate sound reduction.

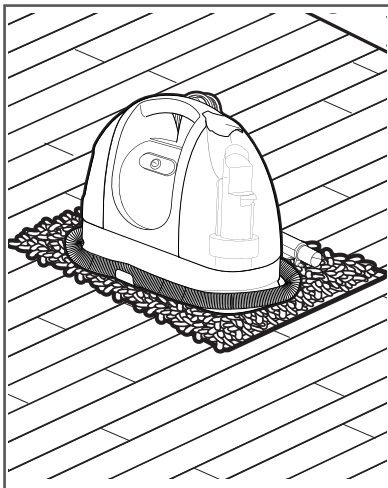

## Noise-Sensitive or Anxious Dog?

Some dogs are sensitive to loud noises, or are not fans of vacuums or other loud appliances. Here are some quick training tips to help your dog have a great experience with this new bathing method.

### Training Steps—Phase 1

- Place the unit in a room where you plan to bathe your dog. Leave the cleaner turned off and allow the dog to become accustomed to it.
- With the unit turned off, have the dog walk over to the unit and use the spray nozzle as a “comb” to brush the dog. This will allow the dog to associate good feelings with the cleaner.
- Praise your dog and offer a treat.

### Training Steps—Phase 2

- With the dog out of the room, turn the unit on. Leave the unit on and offer your dog a treat.
- Turn the unit off.
- Repeat phase one above.

### Training Steps—Phase 3

- Turn the unit on, have your dog enter the room and give the dog a treat.
- With the unit on, and without pulling the trigger to release water, “comb” your dog’s fur with the spray nozzle.
- Turn the unit off and offer a treat.

### Training Steps—Phase 4

- Turn the unit on. Have your dog enter the room.
- Comb a small section of your dog’s fur with the unit on and pull the trigger in quick, short bursts to acclimate your pet to feeling the solution on their skin.
- Once the area is fully wetted and water extracted, your dog’s bath is complete. Praise your pet and offer a treat.



For more tips and videos, visit us online at [www.BISSELL.com/videos](http://www.BISSELL.com/videos).

# Getting to Know Your BarkBath™ Tool

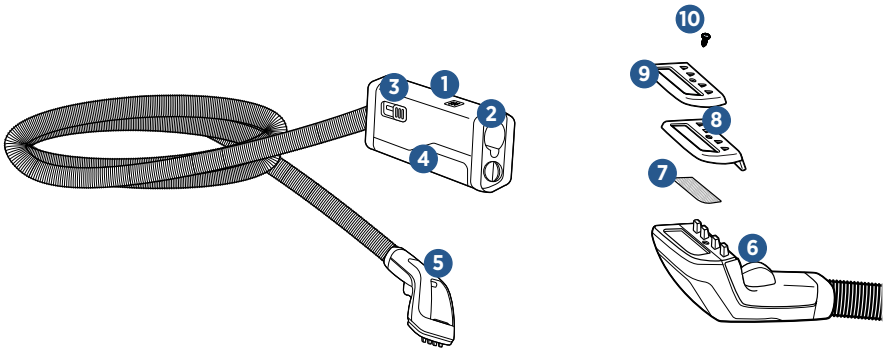

1. Flex Hose Connector Release
2. Shampoo Tool Connector
3. Rinse/Shampoo Switch
4. Shampoo Reservoir
5. Spray Nozzle
6. Nozzle Spray Trigger
7. Mesh Plate
8. Nozzle Height Selection
9. Removable Face Plate
10. Removable Face Plate Screw

## BISSELL® No-Rinse Dog Shampoo

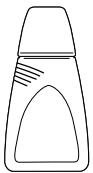

Always use genuine BISSELL No-Rinse Dog Shampoo. Other shampoos may harm the machine and will void the warranty.

**NOTICE:** Do not use dish soap, traditional dog or human shampoos and/or conditioners because they are too thick and may damage the machine. Use only BISSELL No-Rinse Dog Shampoo in your Portable Dog Bath System. Use of shampoos or soaps which contain lemon or pine oil may damage this appliance and void the warranty. These products may react with the plastic materials used in your cleaner, causing cracking or pitting.

# Preparing Your Cleaner\*

## **⚠** WARNING

Do not plug in your BarkBath™ until you are familiar with all the safety and operating instructions.

**NOTICE:** For optimal performance of your cleaner and the safety of your dog, you will need to thoroughly rinse your carpet cleaner before every use of the BarkBath™ tool to ensure all internal components of your cleaner are free of carpet cleaning formulas. Follow these steps for flushing out your cleaner.\*

\*Little Green cleaner shown. Appearance may vary by model.

1

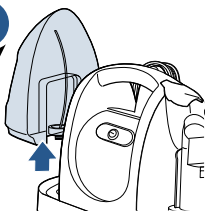

Remove the clean water tank by lifting it straight up and then away from the unit.

2

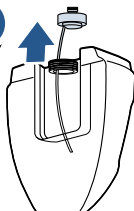

Flip the tank so the black cap is on top and unscrew. Pull up to remove cap assembly from tank.

3

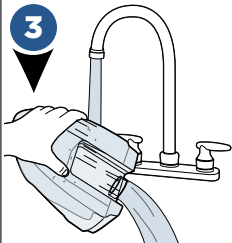

Rinse the clean water and formula tank, along with all tank components (cap, tubing, etc.) with warm tap water. Repeat as necessary to be sure all residual carpet cleaning formula is removed.

4

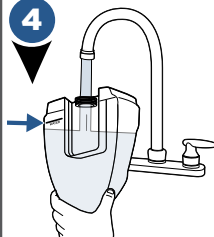

Fill the clean water tank with warm tap water to the fill line. Replace the cap and return the tank to the machine.

5

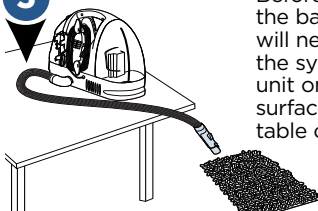

Before connecting the bathing tool, you will need to prime the system. Place the unit on a high, flat surface (such as a table or counter top).

6

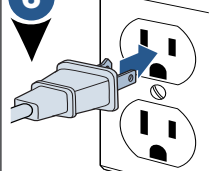

Plug the unit in and press the power switch to ON ( I ) position.

7

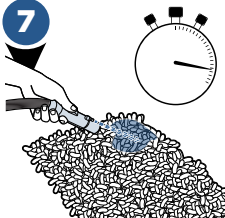

Hold the flex hose end over the microfiber mat or towel and press the trigger at the end of the flex hose for 15-20 seconds to allow water to dispense.

8

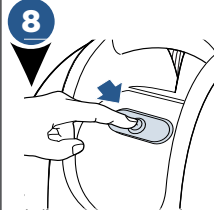

Turn the unit OFF, pressing the power switch to ( O ) OFF position.

# Filling the Clean Water Tank\*

## WARNING

To reduce the risk of injury to your pet, do not boil or microwave water. Use only warm tap water.

**NOTICE:** Although your cleaner has a formula fill line on the clean water tank, **do not put no-rinse dog shampoo in the clean water tank.** When using the BarkBath™ tool, the no-rinse dog shampoo should **ONLY** be added to the shampoo reservoir on the tool. Always put clean water **ONLY** in the clean water tank when using the BarkBath™ tool.

\*Little Green cleaner shown. Appearance may vary by model.

1

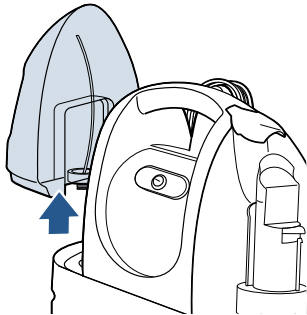

With the machine turned OFF, remove the clean water tank by lifting it straight up and then away from the unit.

2

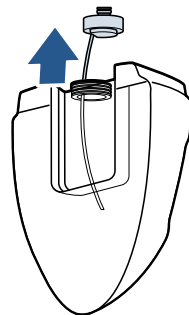

Flip the tank so the black cap is on top and unscrew. Pull up to remove cap assembly from tank.

3

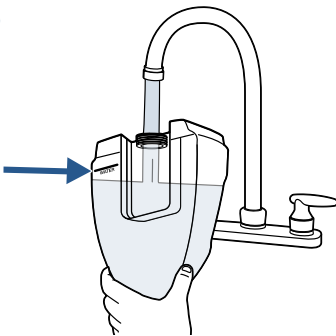

To ensure your pet has a nice bathing experience, use warm-to-the-touch tap water to the fill line on your clean water tank. Replace the cap before returning the tank to the machine.

4

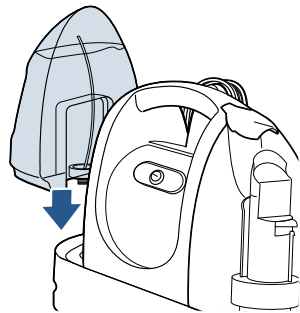

Replace the clean water tank by lining up the grooves on the clean water tank with the vertical guides on the side of the unit. Gently slide it down into position.

# Attaching the BarkBath™ Tool

**NOTICE:** Dish soap, traditional dog or human shampoos and/or conditioners should not be used as they may be too thick and may damage the machine. Use only BISSELL No-Rinse Dog Shampoo in your BarkBath™ tool. Use of shampoos or soaps which contain lemon or pine oil may damage this appliance and void the warranty. These products may react with the plastic materials used in your cleaner, causing cracking or pitting.

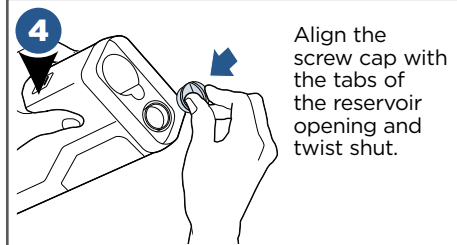
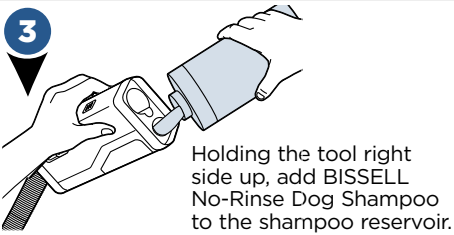
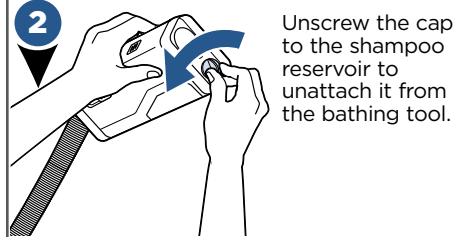

**TIP:** Since every dog is unique, first start by adding a small amount of BISSELL No-Rinse Dog Shampoo to reservoir. Continue to add more shampoo as needed to effectively clean your dog.

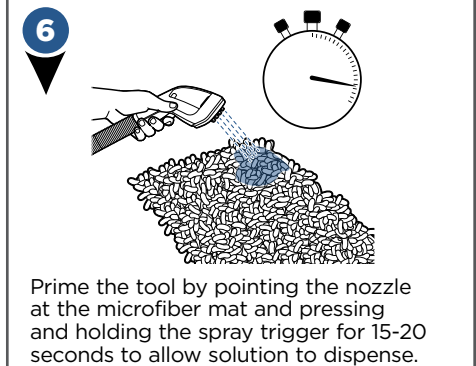
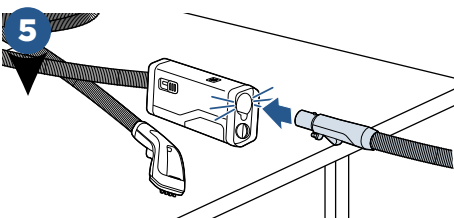

**NOTE:** The "factory setting" of the spray nozzle is optimized for use on most hair lengths/types with the exception of thick/heavy/dual and longer coated dogs.



# Bathing Your Dog

## **⚠️ WARNING**

TO REDUCE THE RISK OF ELECTRIC SHOCK, DO NOT IMMERSE APPLIANCE IN WATER OR PLACE IN AREA WHERE SPLASHING MAY OCCUR.

**NOTICE:** Always use genuine BISSELL No-Rinse Dog Shampoo. Other shampoos may harm the machine and will void the warranty.

### **Recommended areas for bathing your dog:**

- Kitchen
- Utility Room
- Garage
- Family Room

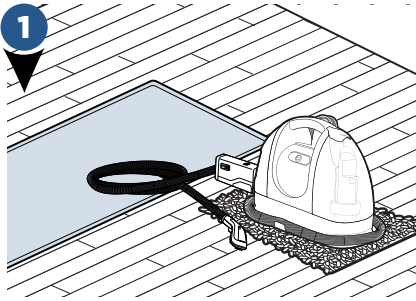

Lay down a separate blanket or towel in the area where you will be bathing your dog. When placing the cleaner on the floor, place a mat or towel underneath. This will help absorb and dampen the sound for your dog.

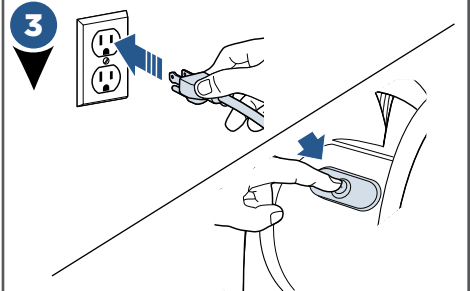

Plug in the unit and press the power switch to ON ( | ) position.

**Continue steps to next page**

# Bathing Your Dog (continued)

4

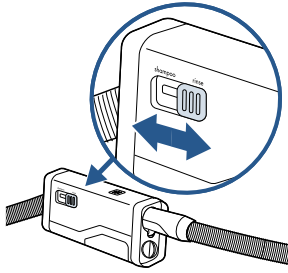

Set the Rinse/Shampoo switch to the desired setting. For Shampoo, the reservoir will dispense a mixture of shampoo and water; for Rinse, it will dispense just water.

5

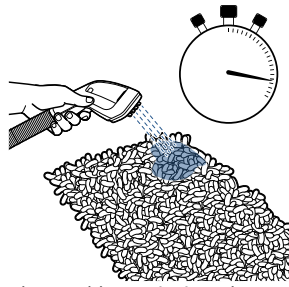

Prime the tool by pointing the nozzle at the microfiber mat and pressing and holding the spray trigger for 15-20 seconds to allow solution to dispense.

**NOTE:** The Dog Bathing Tool is always extracting dirty water. The trigger dispenses the shampoo and/or water. While pressing the trigger, it also continues extracting dirty water.

6



Place the tool directly onto the dog's coat before pressing and holding the spray trigger to release the shampoo/water onto your dog's coat.

7

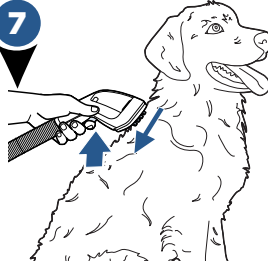

Press and hold the spray trigger while gently stroking the nozzle of the bathing tool downwards, following the fall of the dog's coat.

8

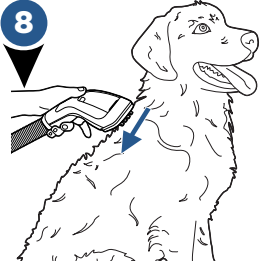

Release the spray trigger and use "drying strokes" to suction up moisture from the dog's coat. Repeat as needed.

9

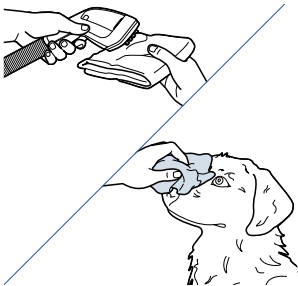

Spray shampoo/water on the microfiber towel and hand clean delicate areas such as the dog's face and paws.

10

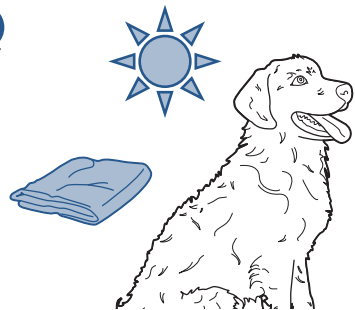

As a final step, coat should be air- or towel-dried as needed.

# Cleaning Your BarkBath™ After Use

## WARNING

To reduce the risk of electric shock, turn power OFF on your cleaner and disconnect plug from electrical outlet before performing maintenance or troubleshooting.

**NOTICE:** Do not submerge BarkBath™ tool in water or other liquid.

1

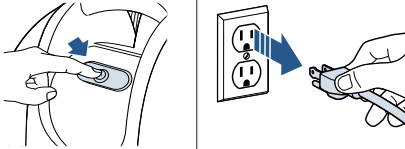

Turn power switch to the OFF (O) position and unplug power cord from outlet.

2

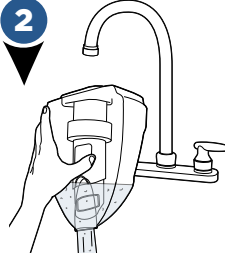

Remove and rinse out the dirty water tank following instructions in the "Emptying the Dirty Water Tank" section.

3

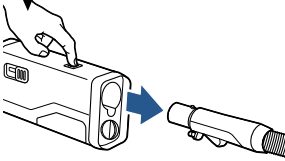

Press release button and disconnect flex hose from the dog bathing tool by pulling straight out. **(DO NOT twist tool to remove.)**

4

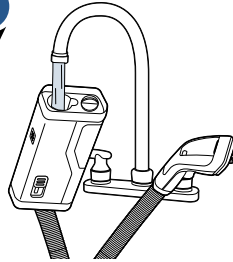

Once removed from flex hose, keep tool elevated to avoid dripping water on floor and rinse clean under running water.

5



Flip tool to release water into sink. While holding the tool in the air and reservoir in the sink, press the trigger to assure all water empties from the hose.

6

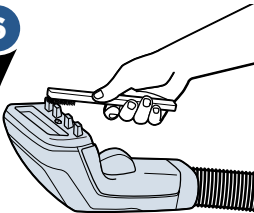

Check spray nozzle for accumulated dirt or debris. If necessary, clean with soft bristle brush.

7

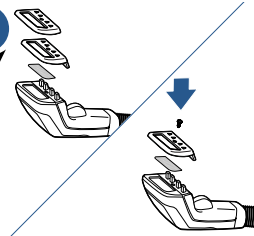

You may disassemble the spray nozzle for cleaning as needed. Removing the faceplates will expose longer spray nozzles.

8



Be sure all pieces are completely dry before returning to base unit and before storage.

# Storing Your BarkBath™ Tool

## WARNING

To reduce the risk of electric shock, turn power OFF on your cleaner and disconnect plug from electrical outlet before performing maintenance or troubleshooting.

**NOTICE:** To reduce the risk of a leaking condition, do not store unit where freezing may occur. Damage to internal components may result.

1

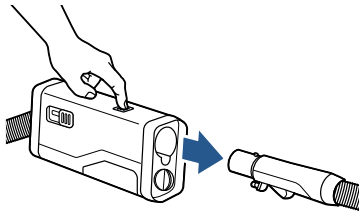

Press release button and disconnect flex hose from the BarkBath™ tool by pulling straight out. **(DO NOT twist tool to remove it from the cleaner.)**

2

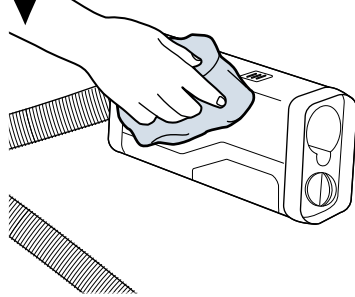

Wipe all surfaces with a soft cloth, making sure all items are clean and dry.

3

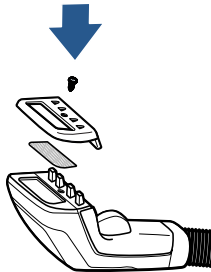

If you disassembled the spray nozzle for cleaning or to expose longer spray nozzles, remember to reassemble all pieces before storing.

4

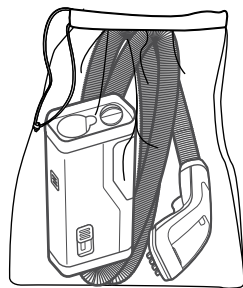

Place BarkBath™ tool and BISSELL no-rinse dog shampoo in the storage bag and store in a protected dry area at room temperature.

# Notes

# Troubleshooting

## WARNING

To reduce the risk of electric shock, turn power switch off and disconnect plug from electrical outlet before performing maintenance or troubleshooting checks.

Problem	Possible causes	Remedies
<b>Reduced or no suction</b>	Hair build-up on suction nozzle	Clean as needed while washing dog
	Using tool too far from pet	Contact dogs coat and periodically let go of spray trigger to allow for drying strokes
	Area under dirty water tank has sand, hair, or debris	Remove dirty water tank and clean any sand or debris off inlet on the base of the machine and the gasket on the bottom of dirty water tank
	Dirty tank full or not seated properly	Empty tank and replace, snapping top lid into place
	Clog or build-up in hose	Suction hot water up to clear hose
	Loose hose connection	Ensure machine hose is locked in place into the bathing tool
<b>Reduced spray or not spraying</b>	Solution or water tank is empty	Check and refill both water and bathing tool solution tanks
	Spray tip clogged	Rinse tool with warm water and use soft bristle brush on spray tips
	Loose hose connection	Ensure machine hose is locked in place into the bathing tool. Hold trigger until water comes out
	Lost prime	Turn unit off; Refill the water tank (and shampoo tank if needed), turn unit on and hold the trigger for 20-30 seconds until spray resumes
<b>Leaking</b>	Dirty water tank gasket not in place or damaged	Place gasket in correctly (notched); If damaged, replace gasket
	Loose hose connection	Ensure machine hose is locked in place into the bathing tool; Hold trigger until water comes out
	Damage or torn hose	Have an authorized technician repair unit
	Bathing tool solution cap not in place	Make sure the solution cap on the bathing tool is in place with a gasket in the cap
<b>No power to unit</b>	Outlet not working	Test outlet with a small appliance like a cell phone charger, and use another outlet if needed
	Fuse/breaker to outlet tripped	Reset the breaker
<b>Dog still dirty or smells</b>	Difficult Odor (ie. skunk)	Rewash or consult a professional for very difficult odors
<b>Shampoo not foaming</b>	Shampoo is designed to not be foamy	Continue using appropriate no rinse shampoo that is not foamy
<b>Shampoo is not flowing</b>	Not using a BISSELL no-rinse dog shampoo	Always use a BISSELL no-rinse dog shampoo
	Rinse/Shampoo switch not fully engaged	Make sure switch is securely selected to the desired function
	Lost prime	Turn unit off; Refill the water tank (and shampoo tank if needed), turn unit on and hold the trigger for 20-30 seconds until spray resumes

# Warranty

This warranty gives you specific legal rights, and you may also have other rights which may vary from state to state. If you need additional instruction regarding this warranty or have questions regarding what it may cover, please contact BISSELL Consumer Care by e-mail or telephone as described below.

## Limited One-Year Warranty

Subject to the \*EXCEPTIONS AND EXCLUSIONS identified below, upon receipt of the product BISSELL will repair or replace (with new or remanufactured components or products), at BISSELL's option, free of charge from the date of purchase by the original purchaser, for one year any defective or malfunctioning part.

See information below on "If your BISSELL product should require service".

This warranty applies to product used for personal, and not commercial or rental service. This warranty does not apply to fans or routine maintenance components such as filters, belts, or brushes. Damage or malfunction caused by negligence, abuse, neglect, unauthorized repair, or any other use not in accordance with the User's Guide is not covered.

BISSELL IS NOT LIABLE FOR INCIDENTAL OR CONSEQUENTIAL DAMAGES OF ANY NATURE ASSOCIATED WITH THE USE OF THIS PRODUCT. BISSELL'S LIABILITY WILL NOT EXCEED THE PURCHASE PRICE OF THE PRODUCT.

**Some states do not allow the exclusion or limitation of incidental or consequential damages, so the above limitation or exclusion may not apply to you.**

## \*EXCEPTIONS AND EXCLUSIONS FROM THE TERMS OF THE LIMITED WARRANTY

THIS WARRANTY IS EXCLUSIVE AND IN LIEU OF ANY OTHER WARRANTIES EITHER ORAL OR WRITTEN. ANY IMPLIED WARRANTIES WHICH MAY ARISE BY OPERATION OF LAW, INCLUDING THE IMPLIED WARRANTIES OF MERCHANTABILITY AND FITNESS FOR A PARTICULAR PURPOSE, ARE LIMITED TO THE FIVE YEAR DURATION FROM THE DATE OF PURCHASE AS DESCRIBED ABOVE.

Some states do not allow limitations on how long an implied warranty lasts so the above limitation may not apply to you.

**NOTE:** Please keep your original sales receipt. It provides proof of date of purchase in the event of a warranty claim.

# Service

## If your BISSELL product should require service:

Contact BISSELL Consumer Care to locate a BISSELL Authorized Service Center in your area.

If you need information about repairs or replacement parts, or if you have questions about your warranty, contact BISSELL Consumer Care.

### Website:

[www.BISSELL.com](http://www.BISSELL.com)

### E-mail:

[www.BISSELL.com/email-us](mailto:www.BISSELL.com/email-us)

### Call:

BISSELL Consumer Care  
1-800-237-7691  
Monday - Friday 8am - 10pm ET  
Saturday 9am - 8pm ET  
Sunday 10am - 7pm ET

## Please do not return this product to the store.

Other maintenance or service not included in the manual should be performed by an authorized service representative.

For any questions or concerns, BISSELL is happy to be of service. Contact us directly at 1-800-237-7691.

# Register your product today!

Registering is quick, easy and offers you benefits over the lifetime of your product.

## You'll receive:

### **BISSELL Rewards Points**

Automatically earn points for discounts and free shipping on future purchases.

### **Faster Service**

Supplying your information now saves you time should you need to contact us with questions regarding your product.

### **Product Support Reminders and Alerts**

We'll contact you with any important product maintenance reminders and alerts.

### **Special Promotions**

Optional: Register your email to receive notice of offers, contests, cleaning tips and more!

**Visit [www.BISSELL.com/registration!](http://www.BISSELL.com/registration!)**

## Visit the BISSELL website: [www.BISSELL.com](http://www.BISSELL.com)

When contacting BISSELL, have model number of cleaner available.

Please record your Model Number: \_\_\_\_\_

Please record your Purchase Date: \_\_\_\_\_

**NOTE: Please keep your original sales receipt. It provides proof of purchase date in the event of a warranty claim. See Warranty on page 15 for details.**

**For cleaning tips and more visit [www.BISSELL.com](http://www.BISSELL.com) or find us at:**



BISSELL



BISSELLClean



BISSELLClean



BISSELL



BISSELL

*We can't wait to hear from you!*

Rate this product and let us (and millions of your closest friends) know what you think!

**[www.BISSELL.com](http://www.BISSELL.com)**



©2017 BISSELL Homecare, Inc.  
Grand Rapids, Michigan  
All rights reserved. Printed in China  
Part Number 161-1099 01/17  
Visit our website at: [www.BISSELL.com](http://www.BISSELL.com)