

phil&teds®
adapt&survive!™

smart™
instructions

IMPORTANT:

**This document contains instructions
and must be kept for future reference.**

Please read thoroughly before use.

please register your product
purchase online now at

philandtedds.com/register



care information

check smart™ for cuts & bruises. if your product is damaged in any way, or you're not sure how to use it, please consult our web support (www.philandteds.com/support). here you can get in touch with a local customer care team, made of real live people.

caring for smart™

unlike your children, your smart™ likes to stay clean.

- smart™ fabric can be sponge cleaned with warm water, using mild natural soap. do not use detergents or bleach on smart™.
- Improper care will void any warranties. do not use smart™ if deterioration is detected or suspected.

important information

aerotech tyres

- tyres are not under warranty, however smart™ uses aerotech tyres which are immune from punctures & eliminate the need for tube replacements.
- with use, the surface of the aerotech tyre can show signs of minor pitting – this is normal for this material, & does not affect performance of the product.



for more information on caring for your smart™, visit philandteds.com/support

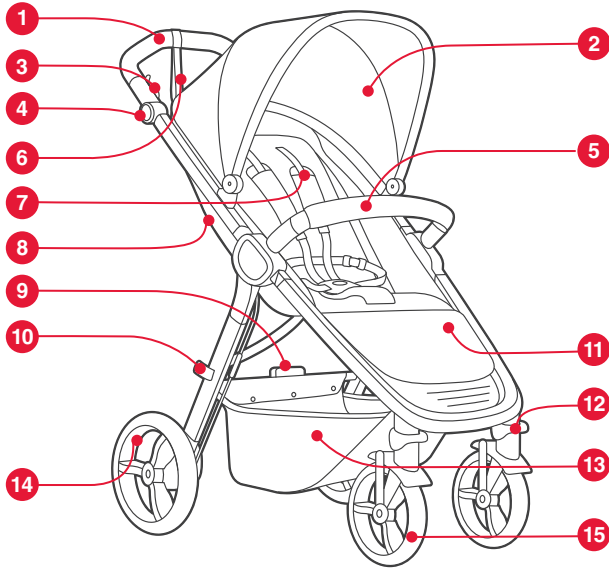

- 1 handlebar
- 2 sunhood
- 3 brake
- 4 handlebar adjustor
- 5 bumper bar
- 6 wrist strap
- 7 harness
- 8 infinite recline seat
- 9 foot fold
- 10 frame lock
- 11 adjustable foot rest
- 12 front wheel lock
- 13 parcel tray
(max load 10kg / 22lbs)
- 14 10" aerotech rear wheels
- 15 8" EVA front wheels



1 guidon multi positions	1 Mehrfach verstellbarer Griff	1 manillar	1 duwbeugel met meerdere standen
2 Capote	2 Sonnenverdeck	2 Capote	2 Achterover
3 frein à main d'un seul geste	3 One-Touch-Bremse: am Griff	3 freno en el manillar/Freno de un solo toque: en el manillar	3 Rem met één beweging: op duwbeugel
4 Ajustement du guidon	4 Verstell-mechanismus der Schiebestange	4 Ajuste del manillar	4 duwstang versteller
5 repose mains amovible	5 abnehmbarer Buggybügel	5 barra protectora delantera desmontable	5 afneembare beschermbeugel
6 dragonne de sécurité	6 Sicherheitsarmband	6 correa de seguridad para la muñeca	6 veiligheid polsband
7 Harnais 5 points standard	7 5-Punkt-Sicherheitsgurt	7 arnés de seguridad de 5 puntos	7 5-puntsveiligheidsgordel
8 Nombre d'inclinaisons infini d'assise à couchée	8 Zurückgelehnt	8 Gran inclinación	8 Traploze instelling
9 pliage rapide	9 Schnelles Zusammenklappen	9 Plegable con un solo brazo	9 Snel in te klappen
10 clip de verrouillage	10 Rahmenverschlussclip	10 seguro del chasis	10 framevergrendelingsclip
11 Repose pied ajustable de la poussette	11 verstellbare Fußstütze	11 Reposapiés regulable	11 verstellbare voetensteun
12 Verrou pour la roue avant	12 Vorderradsperr	12 seguro de la rueda delantera	12 voorwiel lock
13 Large panier de rangement (10kg / 22lbs)	13 großes Gepäckfach (10kg / 22lbs)	13 Gran cesta (10kg / 22lbs)	13 Grote boodschappenmand (10kg / 22lbs)
14 10" aerotech roues arrière	14 10" aerotech Hinterräder	14 10" aerotech ruedas traseras	14 10" aerotech achterwielen
15 8" EVA roue avant	15 8" EVA Vorderräder	15 8" EVA ruedas delanteras	15 8" EVA Voorwielen



A

max load
20kg / 44lbs



B

max load
9kg / 20lbs



C

max load
9kg / 20lbs



D

please refer to your car seat
adaptor instructions

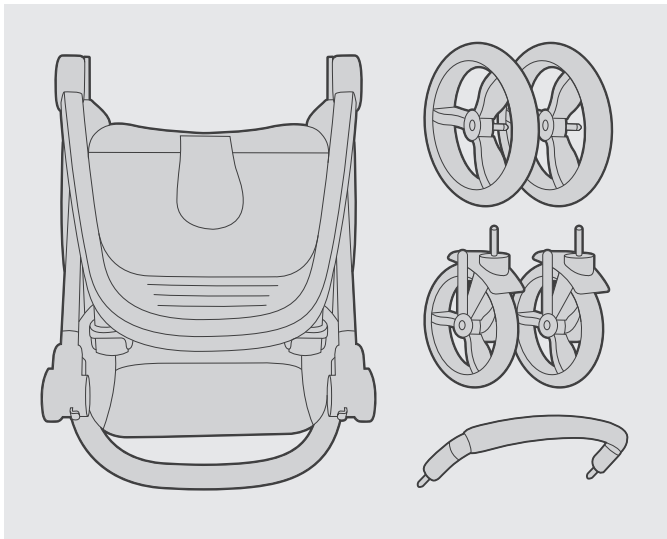



max load
20kg / 44lbs

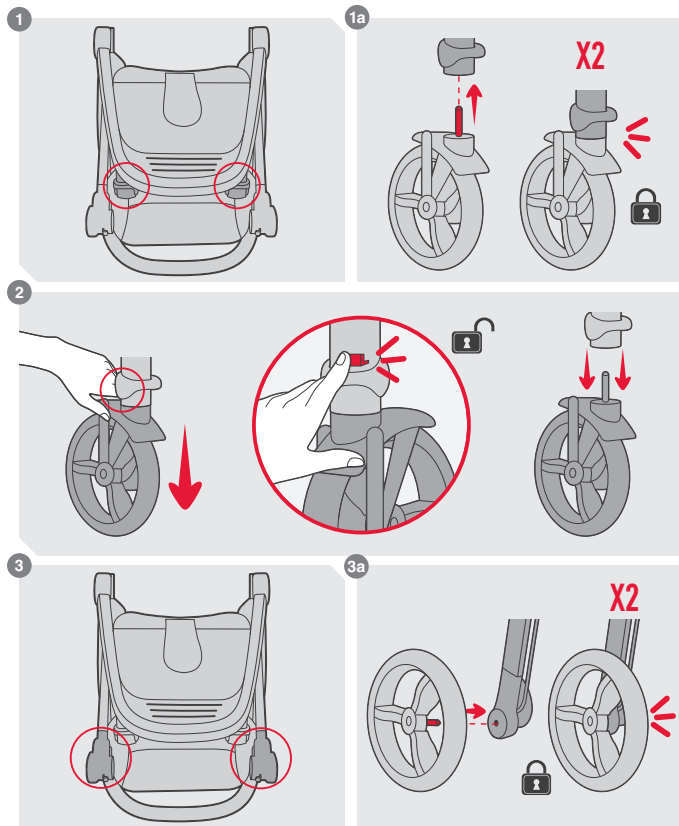

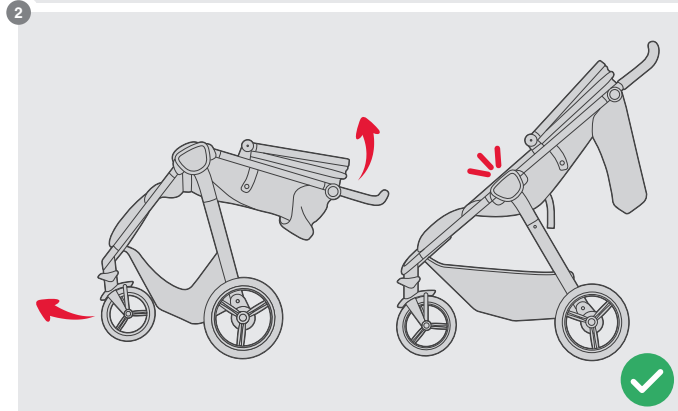
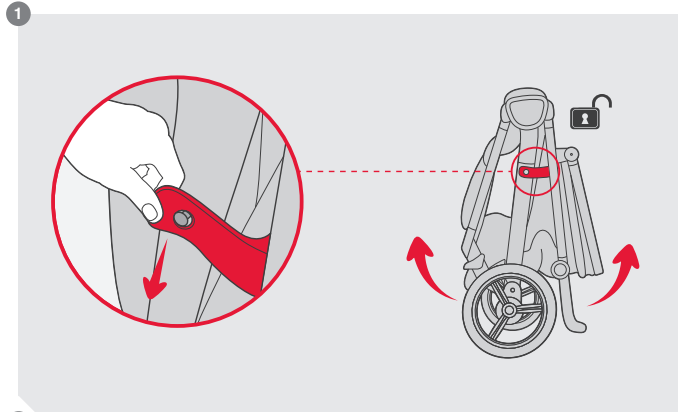
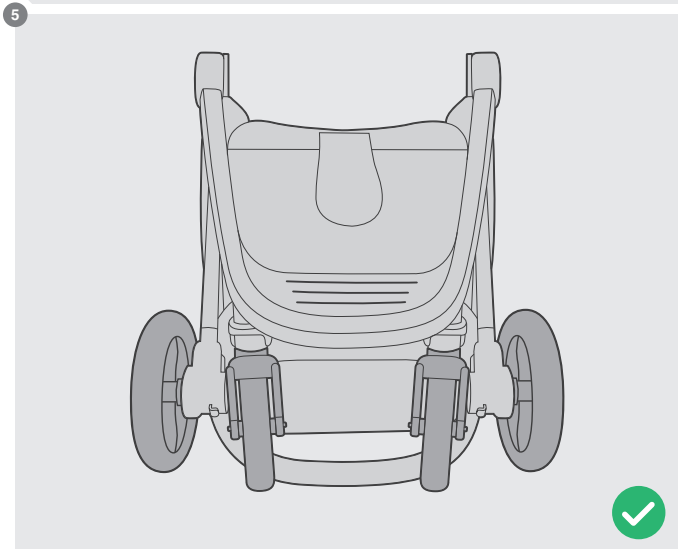
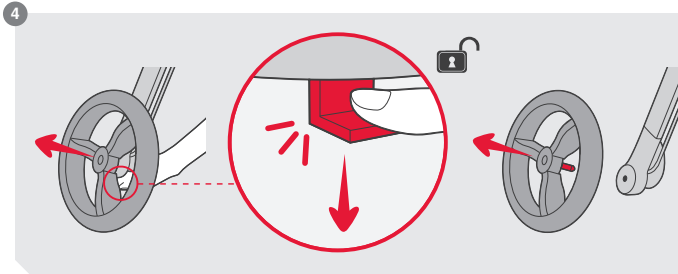

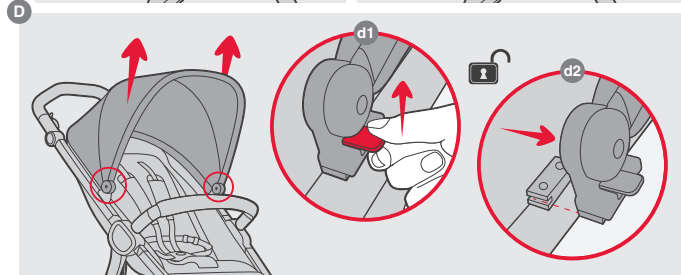
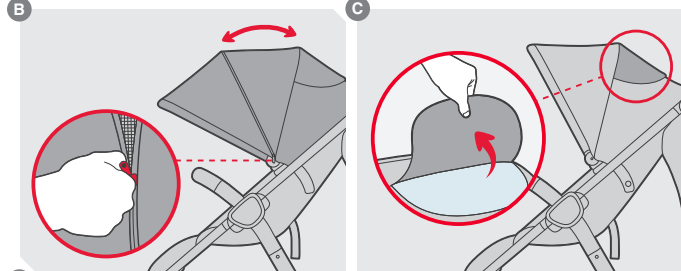
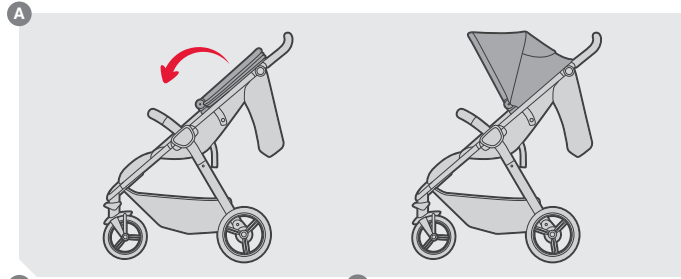
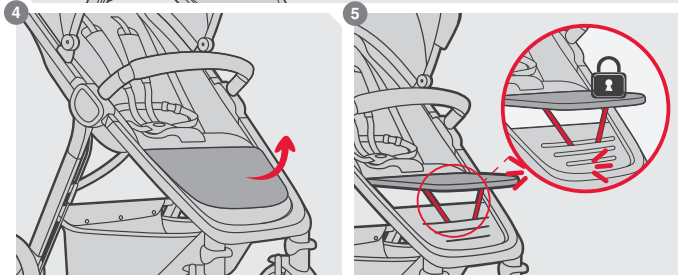
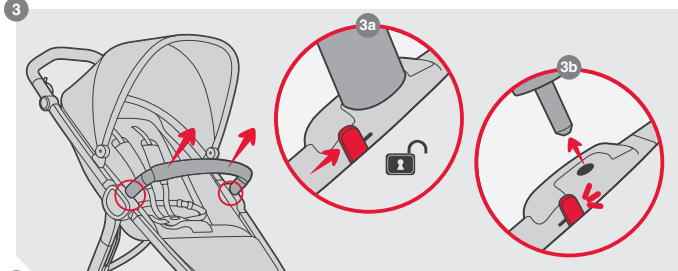
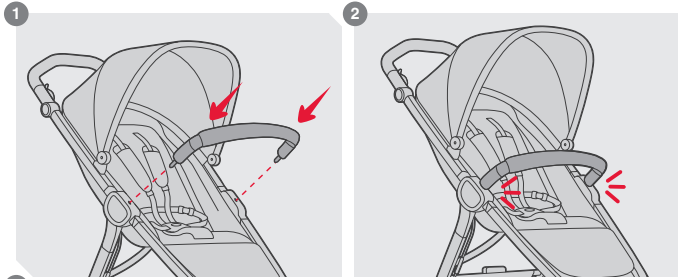

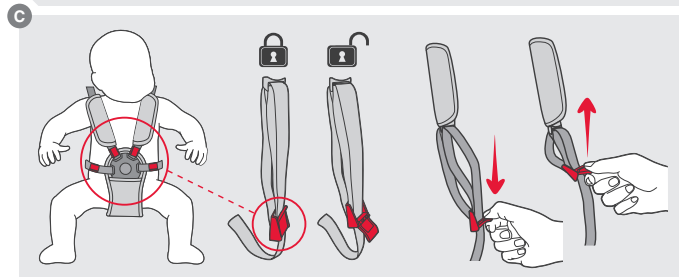
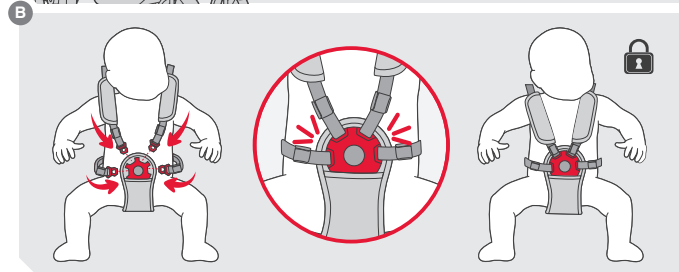
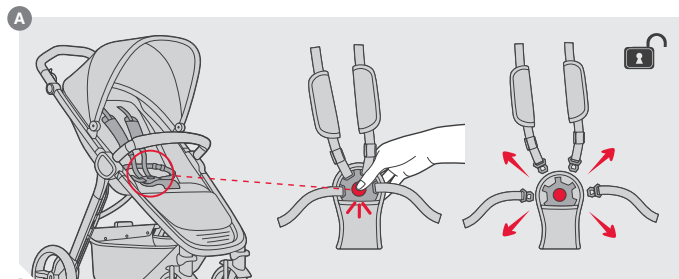
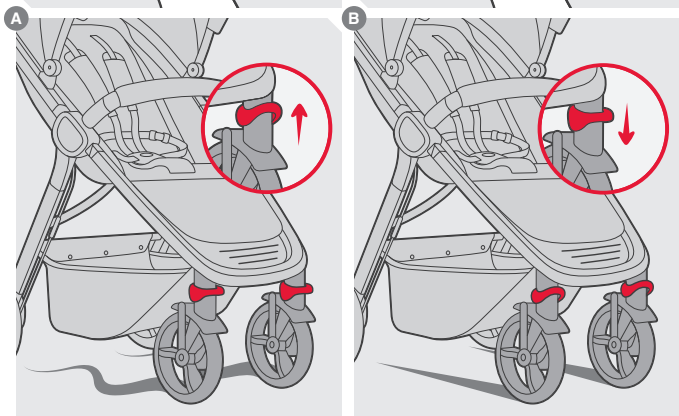
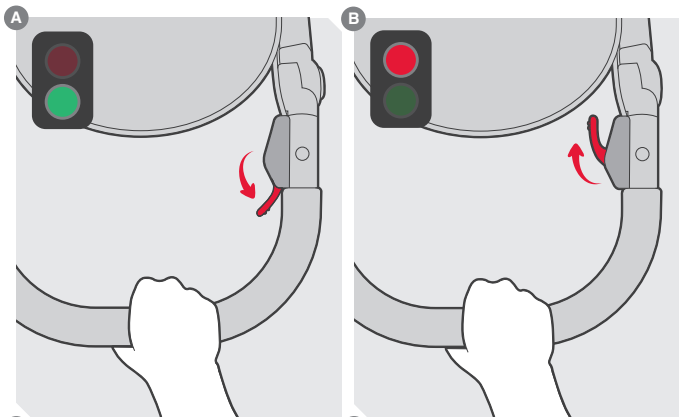

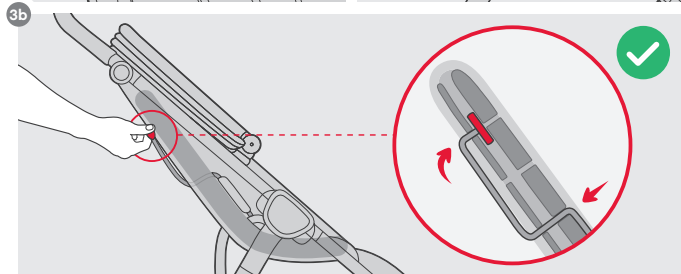
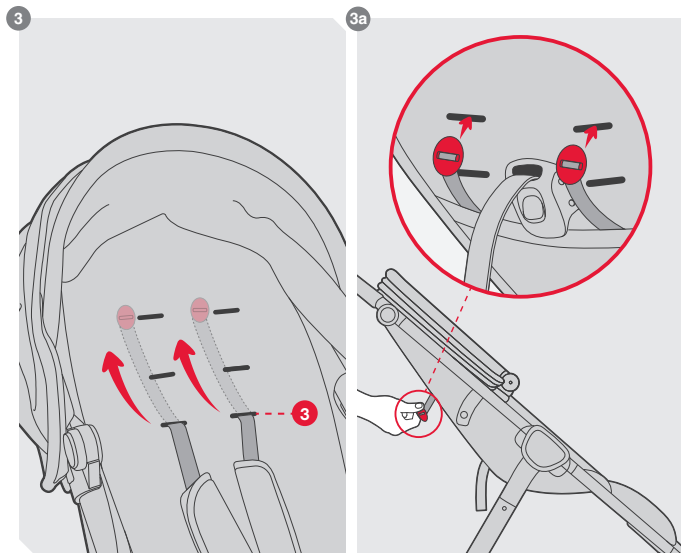
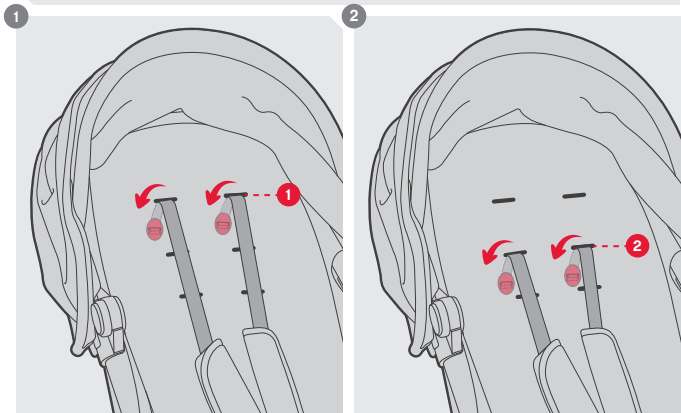
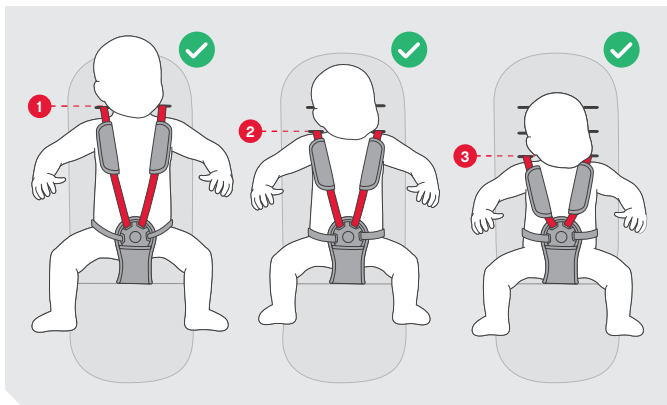

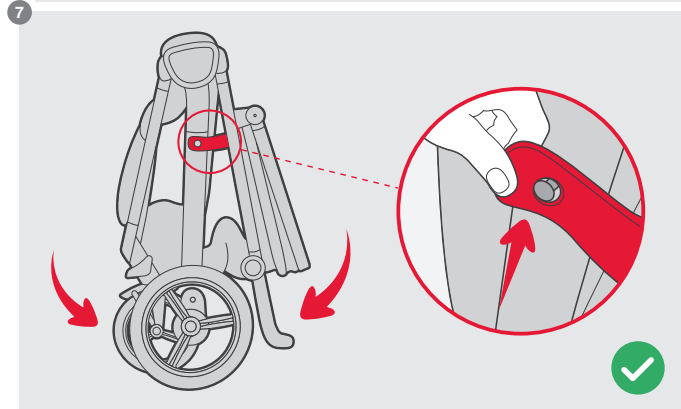
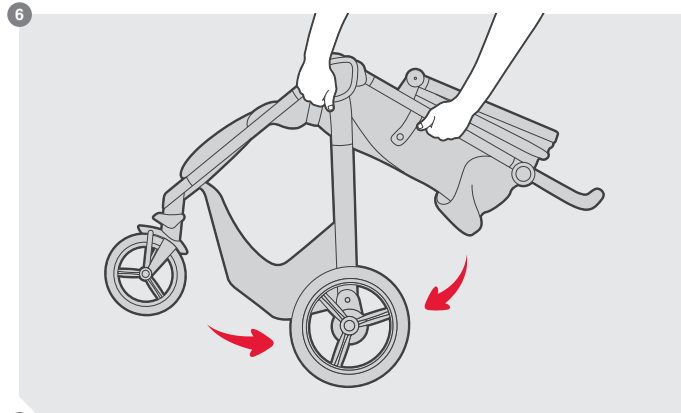
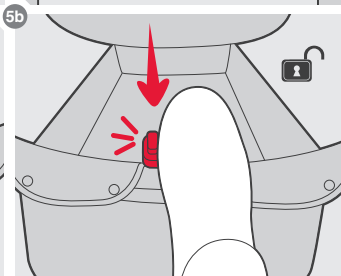
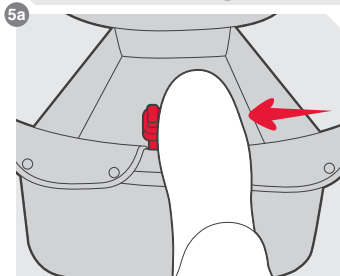
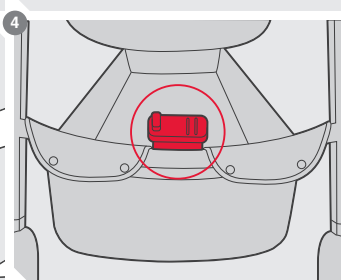
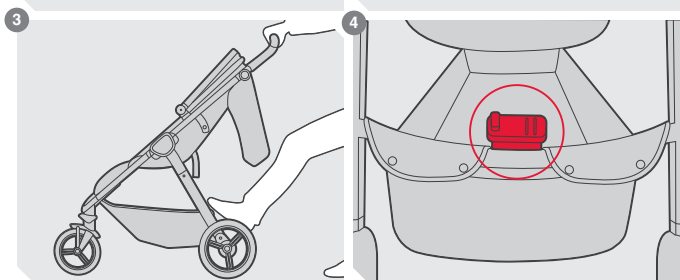
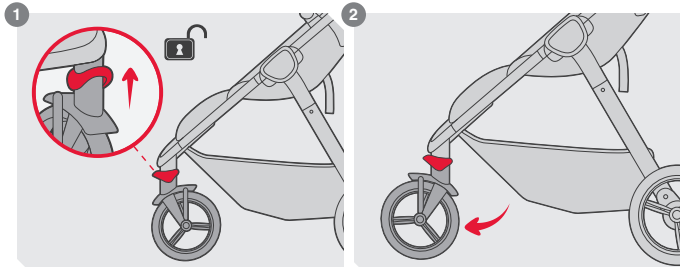

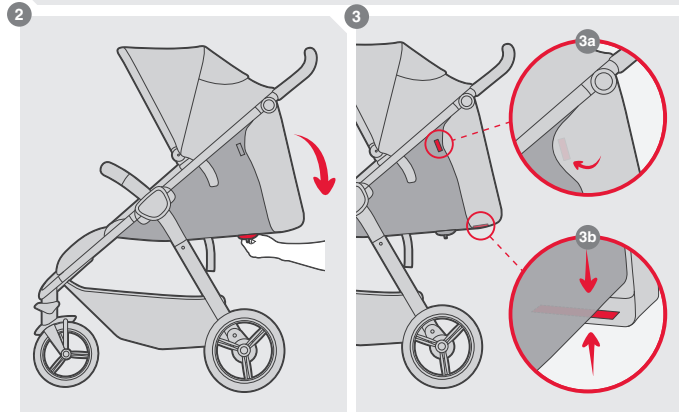
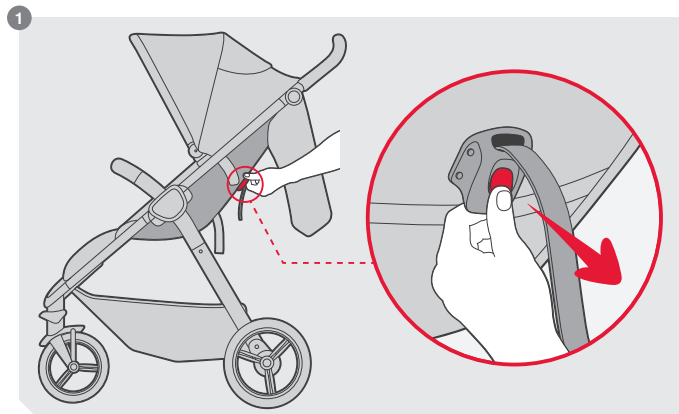

max load
9kg / 20lbs

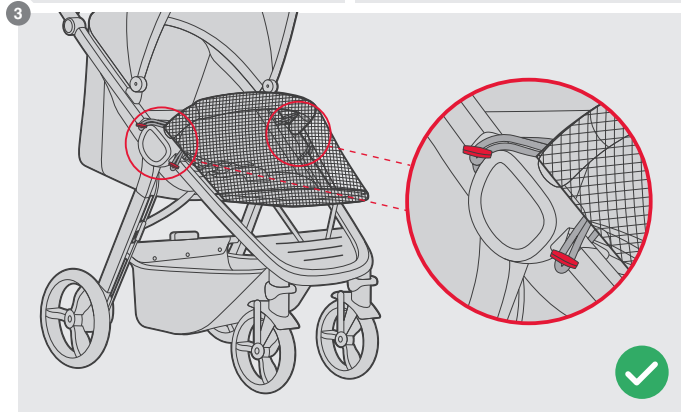
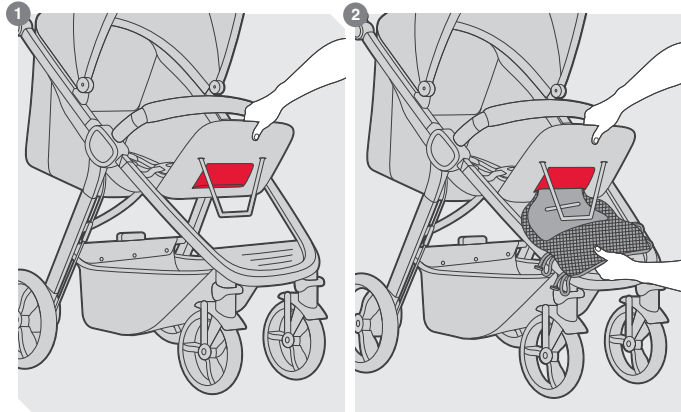
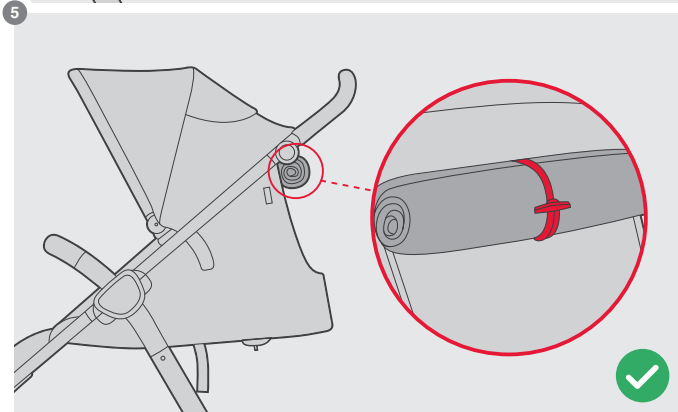
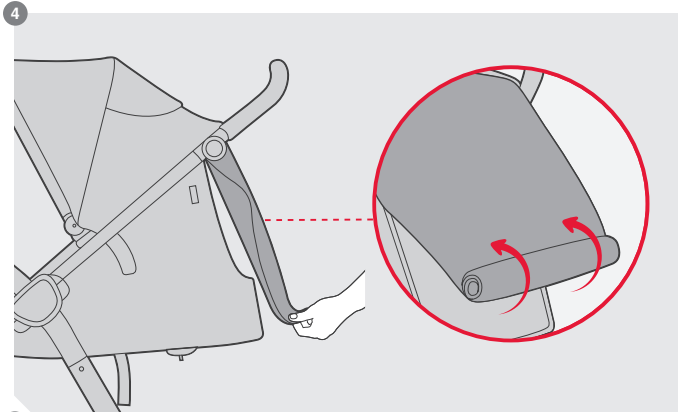



max load
9kg / 20lbs

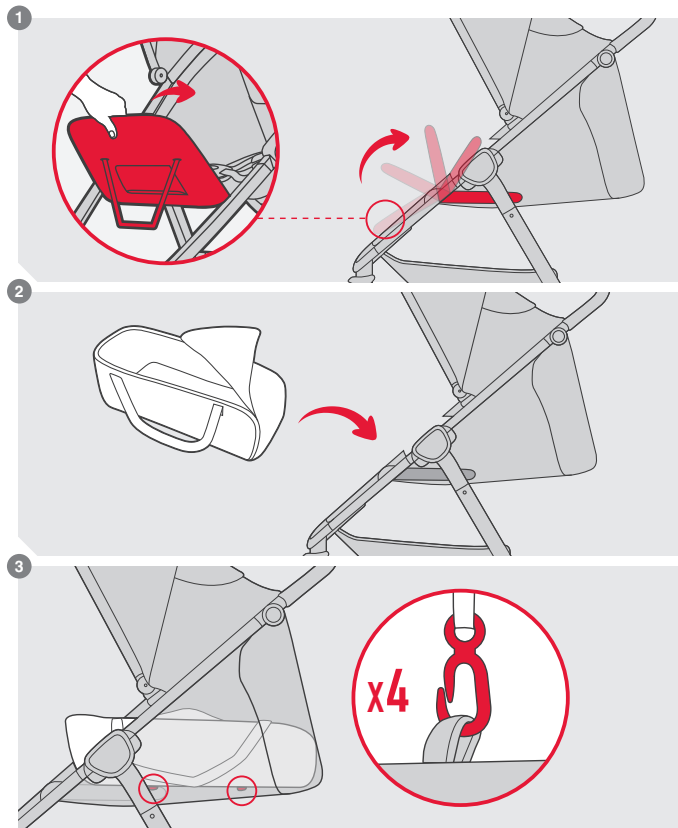

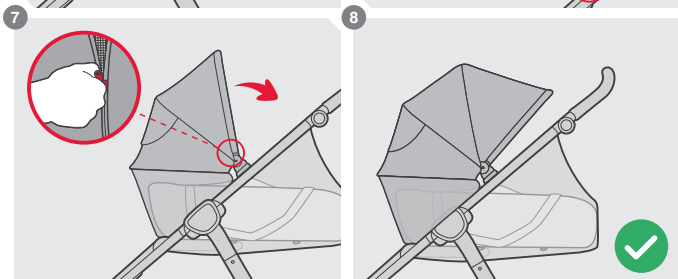
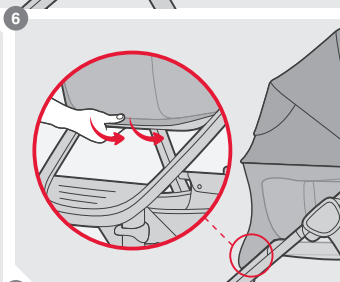
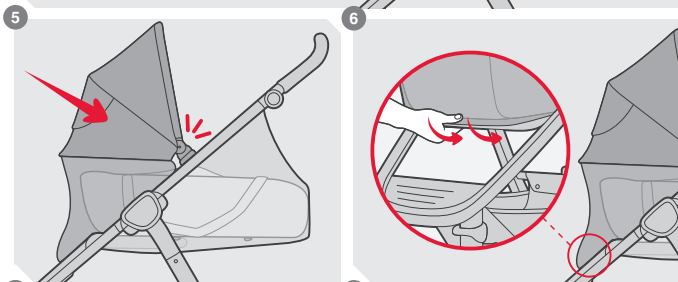
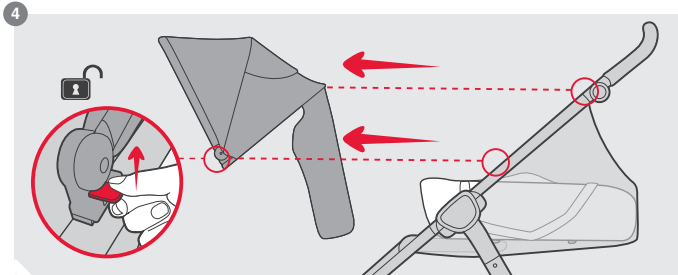



please refer to your car seat
adaptor instructions



Pour les adaptateurs de sièges autos merci de
vous reporter à la notice d'instructions.



Bitte lesen sie hierzu die Bedienungsanleitung
ihres Kindersitzadapters



Por favor consulte las instrucciones de uso de
los adaptadores de sillas de coche.



raadpleeg hiervoor de gebruiksaanwijzing van
uw kinderzitje adapter



AUS/NZL

phil&teds
102-112 Daniell Street
Newtown, Wellington 6021
New Zealand
+ 64 4 3800 833

USA/CAN

phil&teds USA Inc
221 Jefferson Street
Fort Collins, CO 80524
USA.
1 800 839 4985

GBR

phil&teds UK
71-73 Victoria St
Windsor, Berkshire
SL4 1EH, United Kingdom
+44 (0) 20-30519264

EUR/FRA

phil&teds Spain
Calle Casas de Campos
N°15, 3° Planta
Malaga 29001, Spain
+34-91-290 14 82

CHN

phil&teds China
No.10 East Chuangyeyuan
Road, Yangzhou
China
0086-514-87634533

Designed in New Zealand. Made in China
Conçu en Nouvelle-Zélande. Fabriqué en Chine

Conforme aux exigences de sécurité

8203-04