

# Hartau Series

## Hartau Double

Design by Alexandre Joncas

The Hartau series brings together classical light fittings that are, at first glance, astonishing in their line and detail. They have been handmade in Canada using frosted glass, brass, and painted aluminium.

The lampshades are the signature of this collection: with their two openings they offer both direct and indirect light to the wall or the ceiling. Each metal part of the Hartau collection is precision made in Quebec, Canada.

*J.  
Joncas*

# HARTAU double

Design by Alexandre Joncas

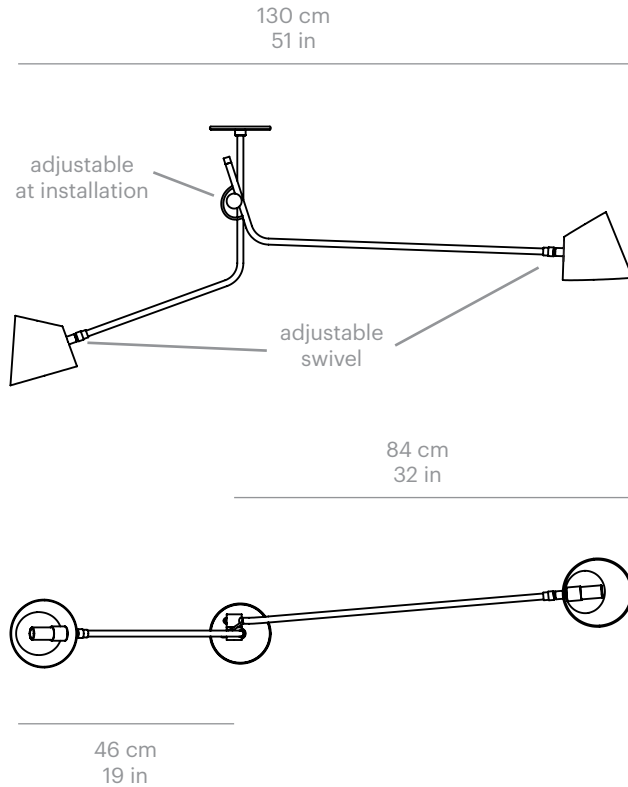

min 61 cm  
min 24 in

## Lamping Specifications

Input voltage : 120V or 220-240V  
Power input : 10W  
Technology : G9 LED bulb (included)  
CRI : >90  
CCT : 2700K (Warm white)  
Lumen source : 700 lm

## Product Weight

1.6 kg / 3.6 lbs

## Height

A	B	C	D
61 cm / 24 in	89 cm / 35 in	112 cm / 44 in	201 cm / 79 in





*\*custom height available upon request*

## Certifications



IP20  

## Materials

**Available Finish :**

-  Matt black
-  Matt white
-  Grey gloss
-  Chrome plated
-  Custom

**Swivel & details :**

-  Polished brass
-  Chrome plated
-  Black oxidized

Order code	Series	Model	Finish	Details	Voltage	Height	QTY
<b>Generator</b>	<b>HA</b> Hartau	<b>DO</b> Double	<b>BL</b> Matt black	<b>BR</b> Polished brass	<b>1</b> 120V	<b>A</b> 61 cm	.
	.	.	<b>WH</b> Matt white	<b>OX</b> Black oxidized	<b>2</b> 220-240V	<b>B</b> 89 cm	.
	.	.	<b>WG</b> Grey gloss	<b>CH</b> Chrome	.	<b>C</b> 112 cm	.
	.	.	<b>CH</b> Chrome	.	.	<b>D</b> 201 cm	.
	.	.	<b>ZZ</b> Custom	.	.	<b>Z</b> Custom	.
<b>Order code :</b>	HA	DO	—	—	—		-





# Hartau Series

## Hartau Triple

Design by Alexandre Joncas

The Hartau series brings together classical light fittings that are, at first glance, astonishing in their line and detail. They have been handmade in Canada using frosted glass, brass, and painted aluminium.

The lampshades are the signature of this collection: with their two openings they offer both direct and indirect light to the wall or the ceiling. Each metal part of the Hartau collection is precision made in Quebec, Canada.

*J.  
Joncas*

# HARTAU triple

Design by Alexandre Joncas

ø 12.7 cm  
ø 5 in

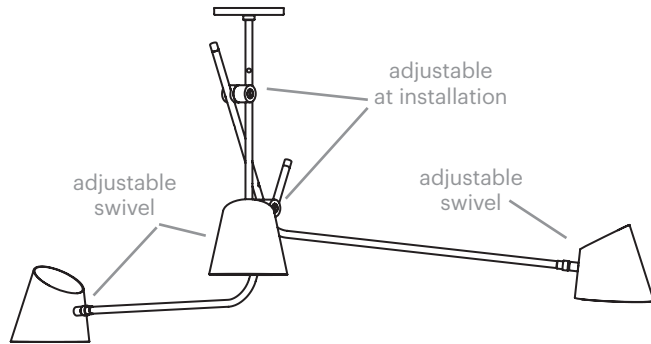

min 64 cm  
min 25 in

107 cm  
42 in

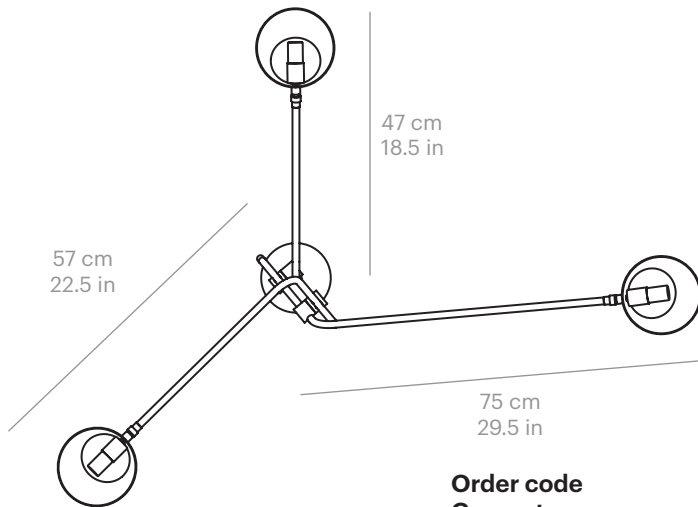

47 cm  
18.5 in

57 cm  
22.5 in

75 cm  
29.5 in

## Lamping Specifications

Input voltage : 120V or 220-240V  
Power input : 15W  
Technology : G9 LED bulb (included)  
CRI : >90  
CCT : 2700K (Warm white)  
Lumen source : 1050 lm

## Product Weight

1.8 kg / 4.2 lbs

## Height











A	B	C	D
64 cm / 25 in	89 cm / 35 in	112 cm / 44 in	201 cm / 79 in

\*custom height available upon request

## Certifications

IP20  

## Materials

- |  |  |
|--|--|
|  Available Finish : |  Swivel & details : |
|  Matt black         |  Polished brass     |
|  Matt white         |  Chrome plated      |
|  Grey gloss        |  Black oxidized    |
|  Chrome plated    |  |
|  Custom           |  |

## Order code Generator

Series	Model	Finish	Details	Voltage	Height	QTY
HA	Hartau	TR	Triple	1 120V	A 64 cm	.
.	.	.	.	2 220-240V	B 89 cm	.
.	.	BL	Matt black	.	C 112 cm	.
.	.	WH	Matt white	.	D 201 cm	.
.	.	WG	Grey gloss	.	Z Custom	.
.	.	CH	Chrome	.		.
.	.	OX	Black oxidized	.		.
.	.	CH	Chrome	.		.
.	.	ZZ	Custom	.		.

Order code :	HA	TR	—	—	—	-	—
--------------	----	----	---	---	---	---	---

