

# Braeburn®

The Best Value in Zoning Today®

The Round Damper is a 24 Volt AC, power open, power closed damper. The damper is constructed of 22 or 24 gauge galvanized steel (subject to size) formed as a rigid spiral pipe and has a circular blade that closes tightly against a neoprene gasket seal. These dampers are shipped complete and ready to install.

The damper is available in 4", 5", 6", 7", 8", 9", 10", 12", 14", 16", 18" and 20" diameters.

The damper can be used for zone control, fresh air intake, ventilation or as the motorized, modulating damper for by-pass air when controlled by the Static Pressure Switch model 149020. It is also designed to handle high velocity air conditioning systems up to 2"W.C.

## Motor Actuator

The motor actuator is a reversible motor that powers the damper both open and closed. It also has an adjustable stop for a minimum/maximum damper position setting. The motor actuator delivers up to 283 in/oz. (17.70 in/lbs.) of torque that powers the damper open and closed.

The simple 3-wire motor has two light emitting diodes (LED's) to indicate the damper position. The **RED** LED is illuminated when the damper is **closed** and the **Green** is illuminated when the damper is **open**. This motor's energy saving design uses end switches to break power to the motor once the motor reaches the end travel position. This lengthens the motor life and conserves energy. The motor has been factory tested to over 250,000 cycles.

## CHECKOUT

To checkout the operation of the damper, place 24V across terminals COM and OPN (Red/Blue). The damper will open and the Green LED will illuminate at the end of the cycle. Place 24V across terminals COM and CLS (Red/White). The damper will close and the Red LED will illuminate at the end of the cycle. All dampers are 100% factory tested.

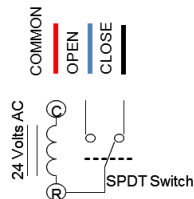

## Automatic Round Damper with Power Open/ Power Close Motor



## DIMENSIONAL DRAWING – All dimensions are nominal.

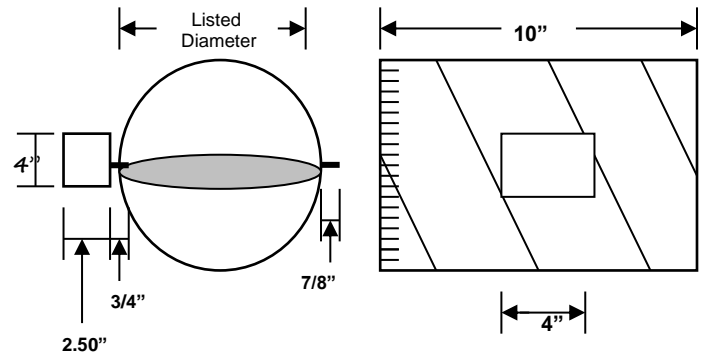

## Damper Specifications

Construction – 24 Ga. Galvanized Steel (4"-8")  
22 Ga. Galvanized Steel (9"-20")

Linkage – Zinc plated linkage arm, Delrin bushings  
Sizes – 4", 5", 6", 7", 8", 9", 10", 12", 14", 16", 18", 20"

Motor Voltage – 24 Volts AC, 50/60 Hz, 6W, 100mA

Torque – 283 in/oz. (17.70 in/lbs.) 2Nm

Temperature Rating - 0°F to 150°F Operating, -20°F to 175°F Storage

Humidity – 5% to 95% Non-Condensing

Damper Timing – Nominal 13.5 Sec. Powered

Connection – Color coded Screwless Terminals

Duct Pressure – Maximum 2.0" W.C.

## INSTALLATION

The damper is used in-line with the duct and can be installed on a take-off or in-line at any point in the duct. It is recommended the damper be installed as close to the air handler as practical.

Place the flat collar end of the damper over the crimped end of the take-off or rigid duct. Insert crimped end of round damper into un-crimped end of rigid round duct and secure with sheet metal screws. When using flexible duct, slip duct over end of the round damper and secure with duct straps (not provided).

The drawing below shows a top view of the damper in line of the duct. When mounting, it is recommended that the motor and blade shaft be horizontal to the ground.

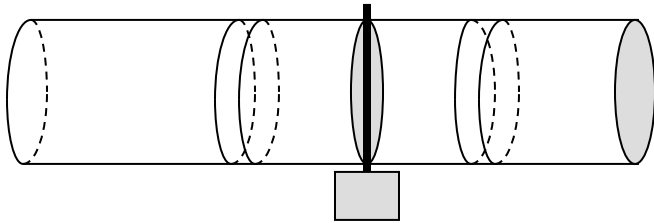

Round damper in-line with round duct.

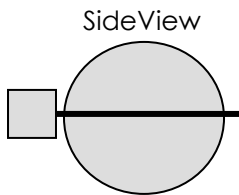

## WIRING DIAGRAM

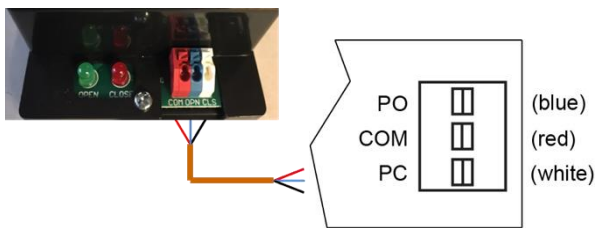

### Adjustable Minimum Close/Maximum Open Settings

Full cam extension equates to apx 40% blade open/close

#### Minimum Close Setting Adjustment

To set the adjustable Minimum Close Damper Position Stop, power the damper to the OPEN (Green LED illuminates) position. Remove the cover from the actuator by loosening the screw between the LEDs and the terminal connector block. Remove the cover by lifting the cover away from the baseplate and upward to release from 2 tabs at the top of the actuator baseplate.

To adjust the cam, loosen the stop screw on the adjustable cam located as shown on left.

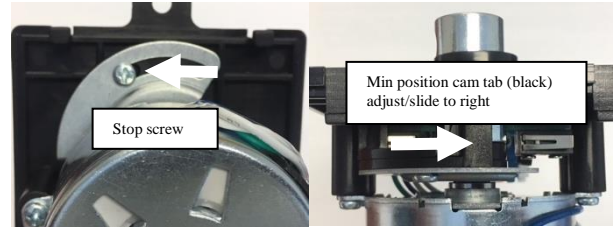

Move the adjustable cam (black section of cam) to the right to adjust the minimum position. Make sure to re-tighten the cam locking/stop screw and power damper open and close in order to check position setting. Reattach the actuator cover.

#### Maximum Open Setting Adjustment

To set the adjustable Maximum Open Damper Position Stop, power the damper to the CLOSED (Red LED illuminates) position. Remove the cover from the actuator by loosening the screw between the LEDs and the terminal connector block. Remove the cover by lifting the cover away from the baseplate and upward to release from 2 tabs at the top of the actuator baseplate. To adjust the cam, loosen the stop screw on the adjustable cam located as shown on left.

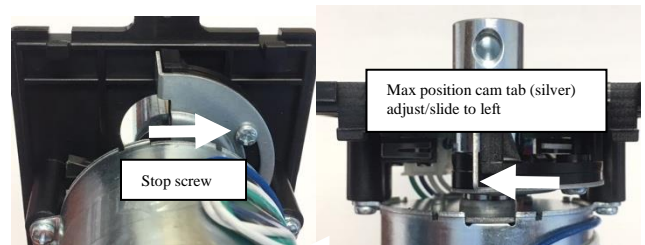

Move the adjustable cam (silver section of cam) to the left to adjust the maximum position. Make sure to re-tighten the cam locking/stop screw and power damper open and close in order to check position setting. Reattach the actuator cover.

## TROUBLESHOOTING

After performing the checkout of the damper, check the motor terminals for 24V across terminals COM and OPN (Red/Blue) if the damper should be open, and COM and CLS (Red/White) if the damper should be closed. If power is not at the proper terminals, check the wiring and control panel for power.

### Actuator Replacement

Use model 149126. If possible have the actuator in the closed position/indicator LED will be Red (damper blade closed). The set screw that attaches the actuator to the drive shaft will be @ the 12:00 position (see picture). Loosen the set screw and pull the actuator off the drive blade shaft. Replace with new actuator, ensure damper blade is closed tightly and tighten the set screw.

