

How to Install Your New Light

Please check that you received all of the components pictured in this guide. Reach out to us if anything is missing. It's very rare, but it happens. Don't forget to turn off the electrical power source.

You won't need any additional tools.

CAUTION

As a safety feature, this lamp has a polarized plug to reduce the risk of electric shock. This means it has two flat prongs and a third circular prong underneath, and it will fit in an outlet one way only. If the plug does not fit fully and easily into the outlet, do not force it; contact a qualified electrician.

ATTENTION

Par mesure de sécurité, cette lampe a une fiche polarisée pour réduire le risque de choc électrique. Cela signifie qu'il a deux broches plates et une troisième broche circulaire en dessous, et qu'il ne s'insère dans une prise que dans un seul sens. Si la fiche ne s'insère pas complètement et facilement dans la prise, ne la forcez pas; contactez un électricien qualifié.

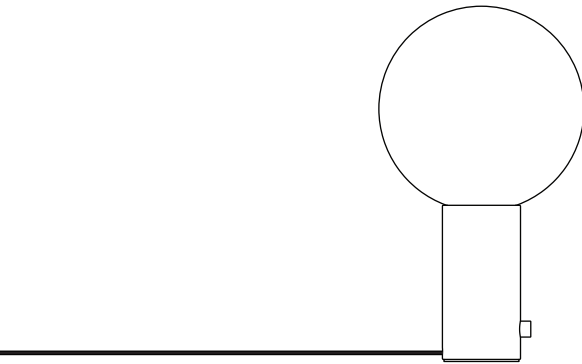

Contents

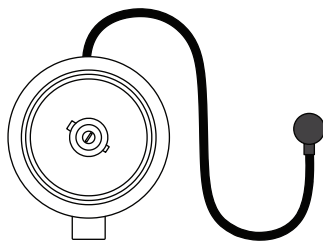

Part A
Medium Column Base

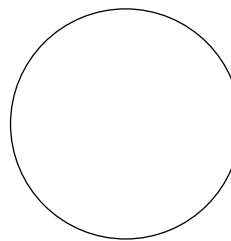

Part B
Orb 8 Diffuser



Part C
E12 LED Bulb

Step 1: Screw in the included lightbulb (C) into the fixture socket of the lamp base (A).

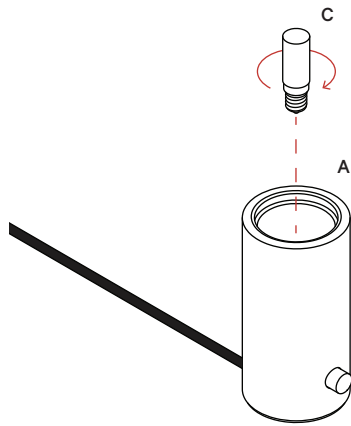

Step 2: Attach the diffuser (B) to the lamp base (A) by rotating clockwise until fixed in place.

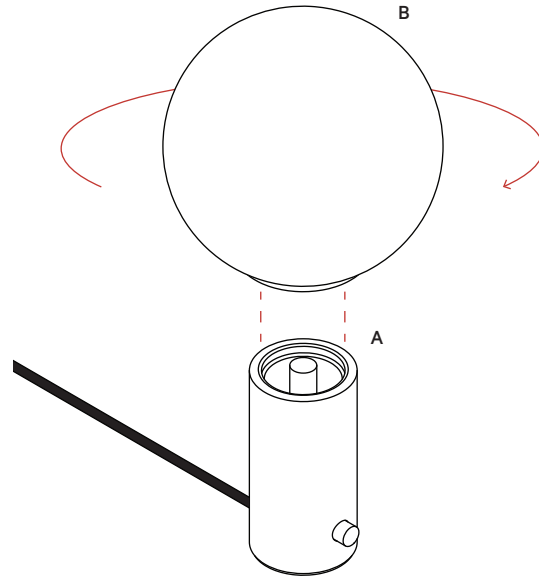

Step 3: Plug in and turn on the light.

