

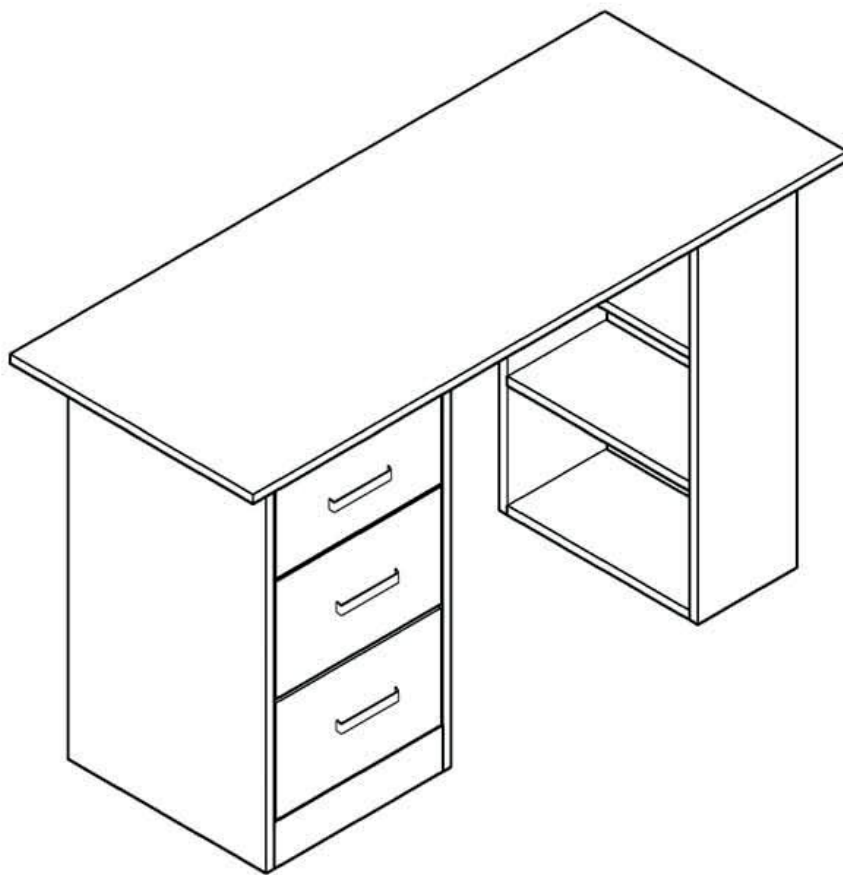

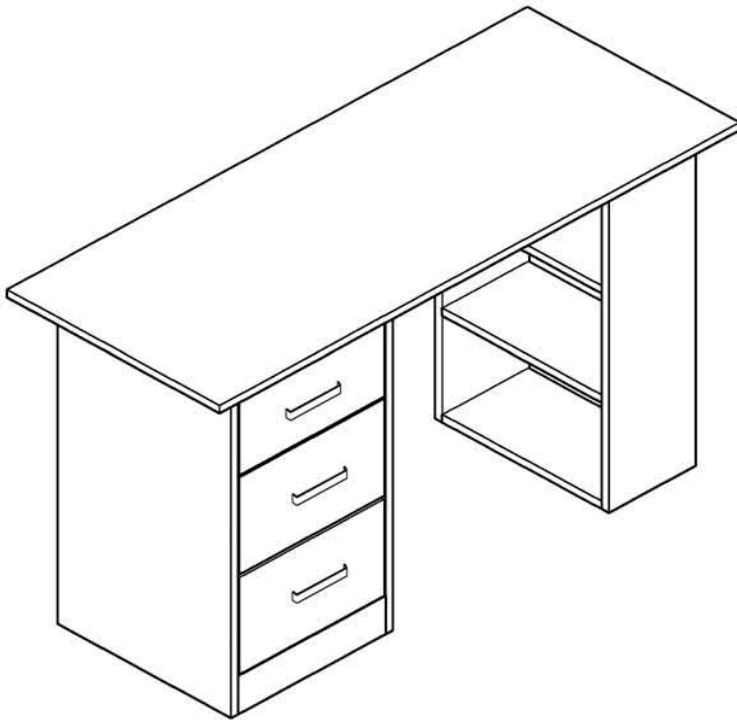









3 Drawer Desk

Assembly Instructions



Parts List

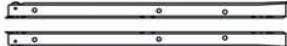

NO.	QTY.	LINEDRAWING
A	20pcs	
B	20pcs	
C	8pcs	
D	3pcs	
E	12pcs	
F	24pcs	
G	20pcs	
J	20pcs	
H		
H1		 3pcs
H2		
		 

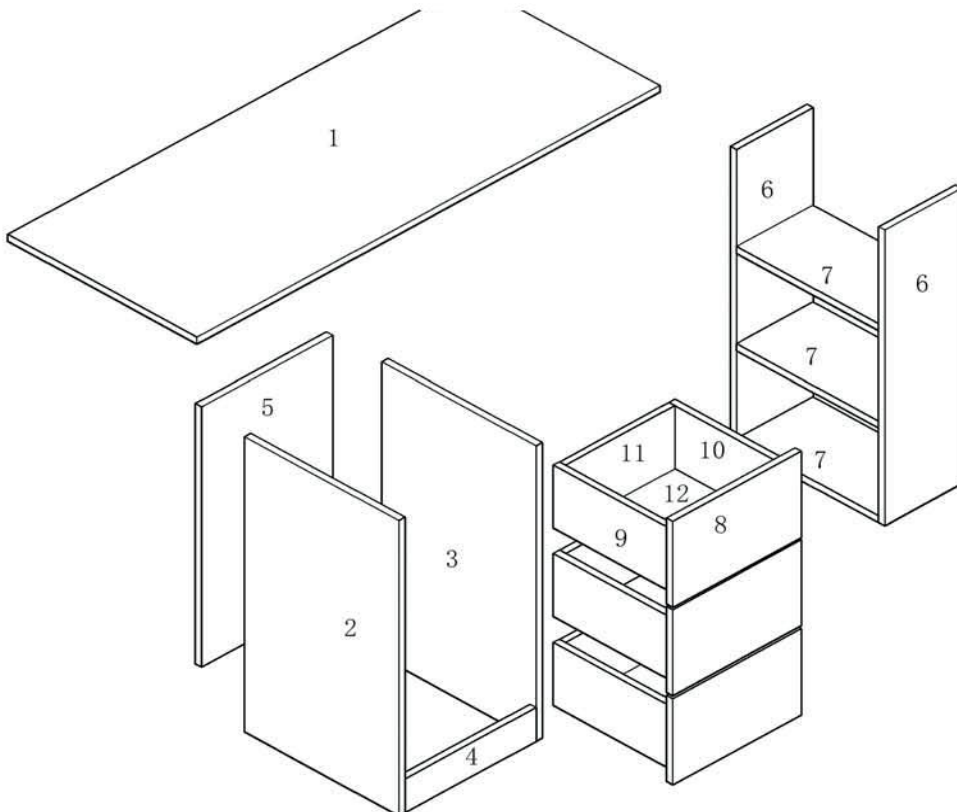

1	1200*490*15mm	1pcs
2	705*400*15mm	1pcs
3	705*400*15mm	1pcs
4	342*80*15mm	1pcs
5	620*342*15mm	1pcs
6	705*200*15mm	2pcs
7	370*198*15mm	3pcs
8	336*205*15mm	3pcs
9	300*150*15mm	3pcs
10	300*150*15mm	3pcs
11	287*150*15mm	3pcs
12	295*297*3mm	3pcs

1

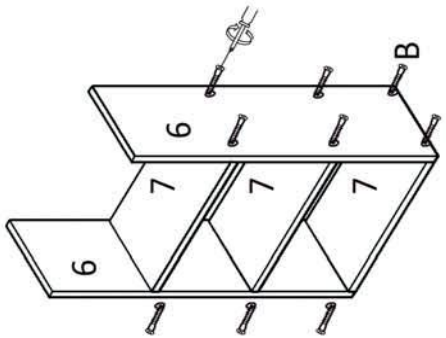

2

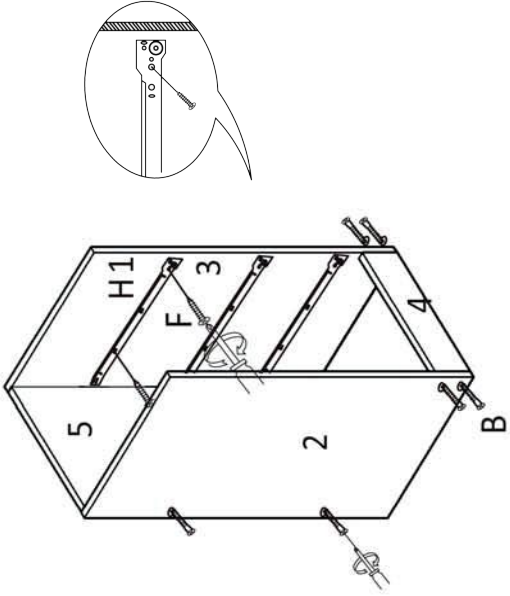

3

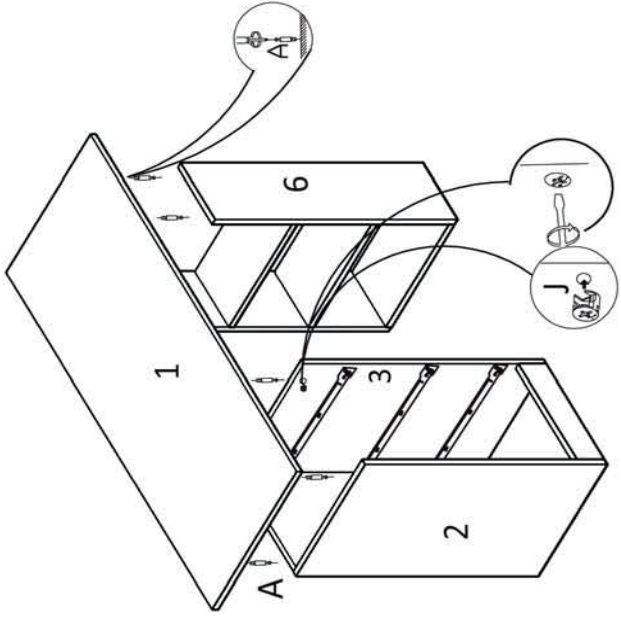

4

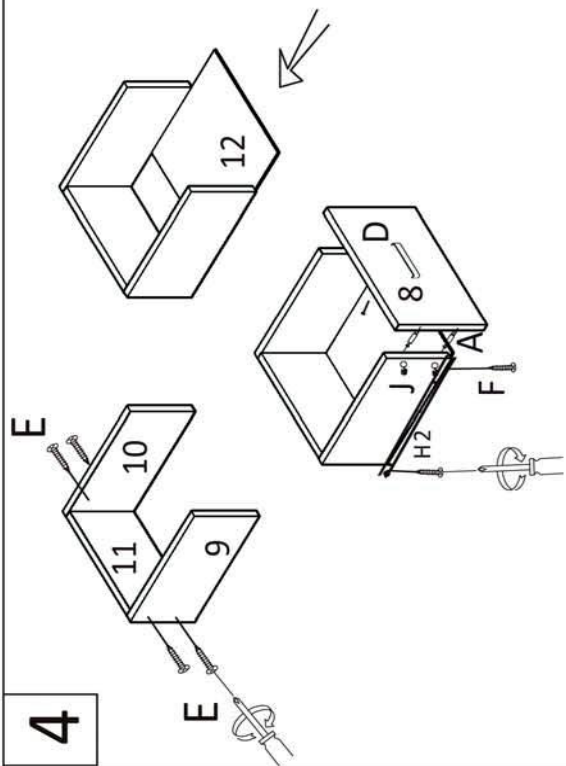

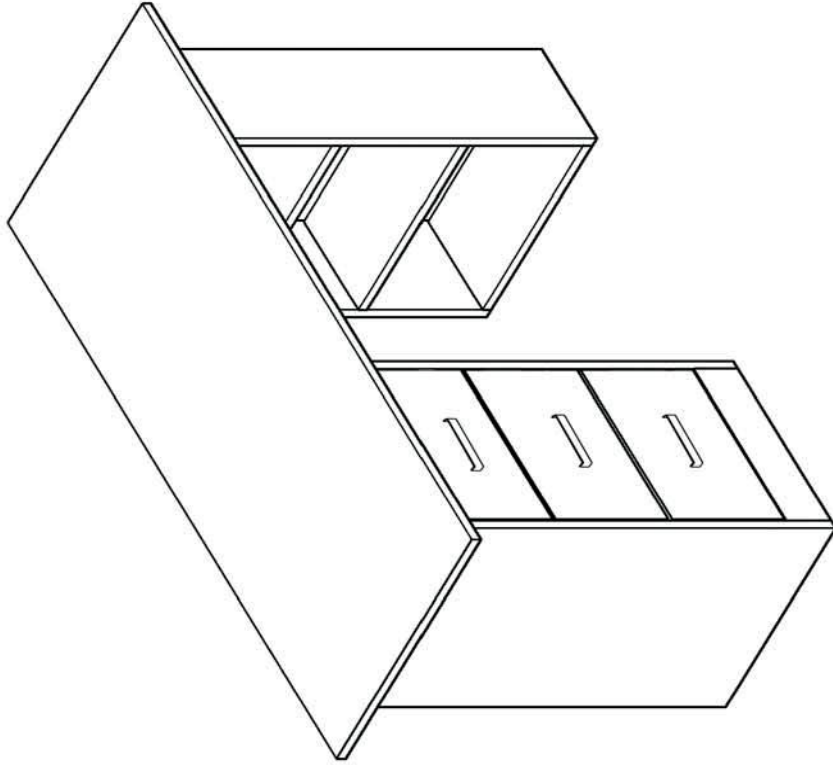

6

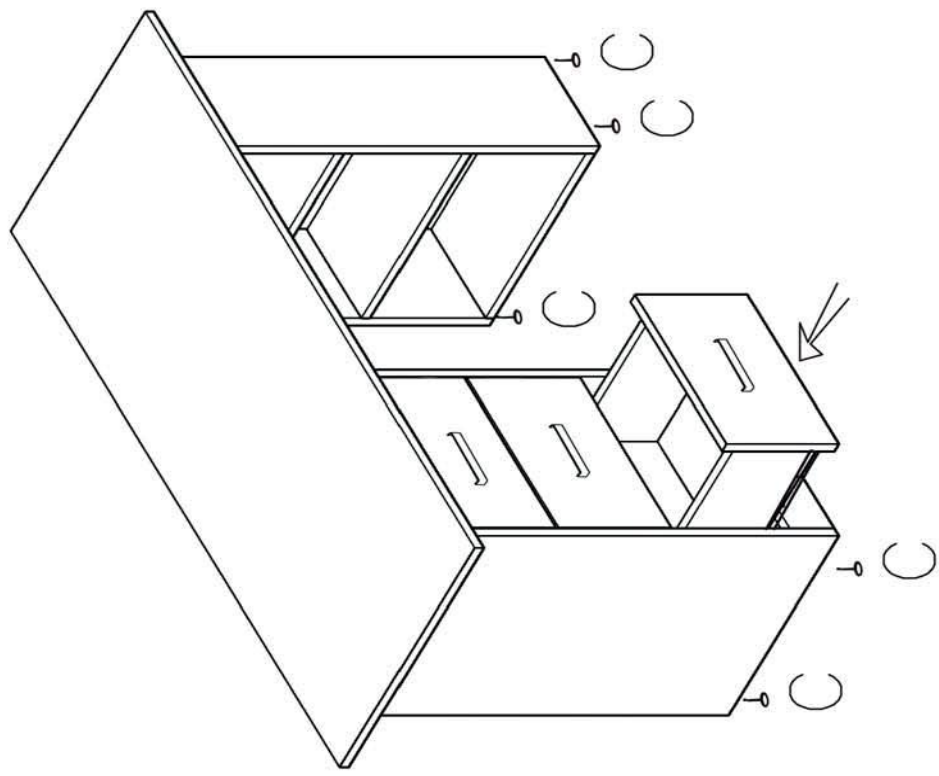

5