

COSORI

User Manual

Smart 5.5-Litre Air Fryer

Model: CS158-AF



Questions or Concerns?

support.eu@cosori.com

 *Thank you for
your purchase!* 

(We hope you love your new air fryer as much as we do.)



join

the Cosori Cooks Community on Facebook
facebook.com/CosoriUK



explore

our recipe gallery
www.cosori.com/recipes



enjoy

weekly, featured recipes
made exclusively by our in-house chefs



CONTACT OUR CHEFS

Our helpful, in-house chefs are ready to assist you with any questions you might have!

Email: recipes@cosori.com

On behalf of all of us at Cosori,

Happy cooking!

Table of Contents

Package Contents	2
Specifications	2
Important Safeguards	4
• Key Safety Points	4
• General Safety	5
• While Air Frying	5
• Plug and Cord	5
Getting to Know Your Air Fryer	6
Display Diagram	7
Display Messages	8
Before First Use	9
• Setting Up	9
• Test Run	9
• Basket Tips	10
• VeSync App Setup	10
Using Your Air Fryer	11
• Preheating	11
• Air Frying	12
• Shaking Food	15
• Cooking Guide	16
• More Functions	17
Care & Maintenance	18
Accessories	18
Troubleshooting	19
Warranty Information	21
Customer Support	21

Package Contents

- 1 x Smart 5.5-Litre Air Fryer
- 1 x Recipe Book
- 1 x Quick Reference Guide
- 1 x User Manual

Specifications

Power Supply	AC 220–240V, 50/60Hz
Rated Power	1700W
Capacity	5.5 L / 5.8 qt (serves 3–5 people)
Temperature Range	75°–205°C / 170°–400°F
Time Range	1–60 min
Dimensions (including handle and air outlet spacer)	29.9 x 39.8 x 32.1cm / 11.8 x 15.7 x 12.7 in
Weight	5.4 kg / 11.9 lb
Wi-Fi Frequency Range	2412–2472MHz
Maximum transmit power	15.0 dBm (E.I.R.P)

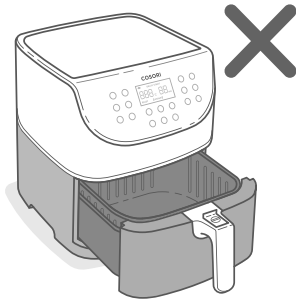
Download the free VeSync app to access smart functions and original recipes from the Cosori chefs!



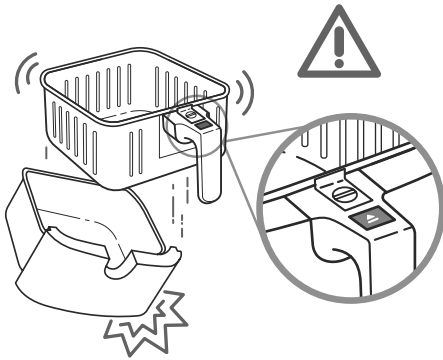
IMPORTANT SAFEGUARDS

Follow basic safety precautions when using your air fryer. Read all instructions.

Key Safety Points

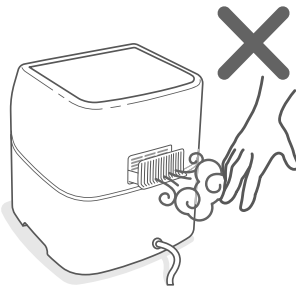


Do not touch hot surfaces.
Use handle.



Only press the basket release button with the baskets resting flat on a counter or any level, heat-resistant surface.

The handle is attached to the inner basket, not the outer basket. When you press the basket release button, the outer basket will **drop**.



Do not block any ventilation openings. Hot steam is released through openings. Keep your hands and face clear of openings.

General Safety

- **Do not** immerse the air fryer housing or plug in water or liquid.
- Children are to be supervised not to play with the appliance.
- Unplug when not in use, and before cleaning. Allow to cool before putting on or taking off parts.
- **Do not** to be used by persons (including children) with reduced physical, sensory or mental capabilities, or lack of experience and knowledge, unless they have been given supervision or instruction.
- **Do not** use your air fryer if it is damaged, not working, or if the cord or plug is damaged. Contact **Customer Support** (see page 21).
- **Do not** use third-party replacement parts or accessories, as this may cause injuries.
- **Do not** use outdoors.
- **Do not** place the air fryer or any of its parts on a stove, near gas or electric burners, or in a heated oven.
- Be extremely cautious when moving your air fryer (or removing the baskets) if it contains hot oil or other hot liquids.
- **Do not** clean with metal scouring pads. Metal fragments can break off the pad and touch electrical parts, creating a risk of electric shock.
- **Do not** place anything on top of your air fryer. **Do not** store anything inside your air fryer.
- **Only** use your air fryer as directed in this manual.
- Not for commercial use. Household use **only**.
- Cleaning and user maintenance shall not be made by children.
- Keep the appliance and its cord out of reach of children.

While Air Frying

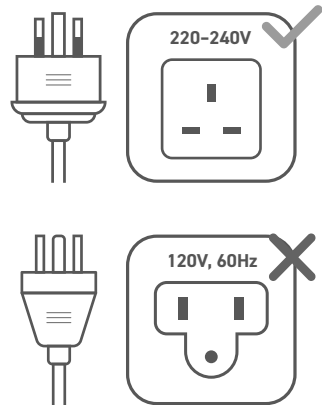
- An air fryer works with hot air **only**. **Never** fill the baskets with oil or fat.
- **Never** use your air fryer without the baskets in place.
- **Do not** place oversized foods or metal utensils into your air fryer.
- **Do not** place paper, cardboard, non-heat-resistant plastic, or similar materials into your air fryer. You may use parchment paper or foil.
- **Never** put baking or parchment paper into the air fryer without food on top. Air circulation can cause paper to lift and touch heating coils.
- **Always** use heat-safe containers. Be extremely cautious if using containers that aren't metal or glass.
- Keep your air fryer away from flammable materials (curtains, tablecloths, etc). Use on a flat, stable, heat-resistant surface away from heat sources or liquids.

- Immediately turn off and unplug your air fryer if you see dark smoke coming out. White smoke is normal, caused by heating fat or food splashing, but dark smoke means that food is burning or there is a circuit problem. Wait for smoke to clear before pulling the baskets out. If the cause was not burnt food, contact **Customer Support** (page 21).
- **Do not** leave your air fryer unattended while in use.

Plug and Cord

- **Do not** let the power cord (or any extension cord) hang over the edge of a table or counter, or touch hot surfaces.

Note: This air fryer uses a short power-supply cord to reduce the risk of entangling or tripping. Use extension cords with care. The marked electrical rating of the extension cord must be as great as the rating of the air fryer (see page 3).



Electromagnetic Fields (EMF)

The Cosori Air Fryer complies with all standards regarding electromagnetic fields (EMF). If handled properly and according to the instructions in this user manual, the appliance is safe to use based on scientific evidence currently available.

**SAVE THESE
INSTRUCTIONS**

GETTING TO KNOW YOUR AIR FRYER

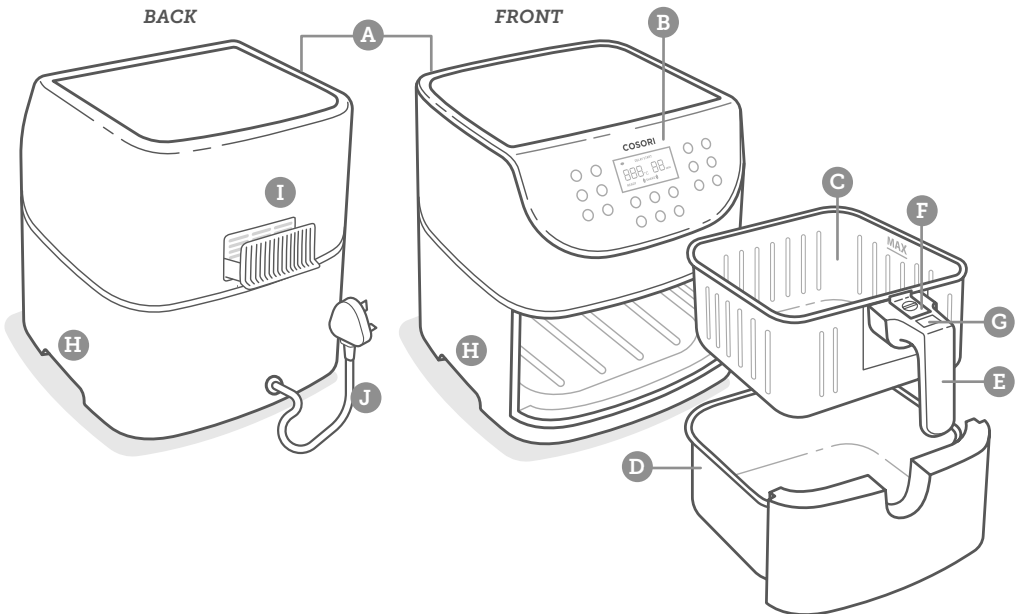
Your Cosori Air Fryer uses rapid 360° air circulation technology to cook with little-to-no oil for quick, crispy, delicious food with up to 85% fewer calories than deep fryers. With user-friendly, one-touch controls, nonstick baskets, and an intuitive, safe design, the Cosori Air Fryer is the star of your kitchen.

Air Fryer Diagram



Note:

- **Do not** try to open the top of the air fryer. It is not a lid.
- The baskets are made of aluminium metal with nonstick coating. They are PFOA-free and BPA-free.



- | | | |
|-------------------|--------------------------|---------------|
| A. Air Inlet | E. Basket Handle | I. Air Outlet |
| B. Control Screen | F. Sliding Button Guard | J. Power Cord |
| C. Inner Basket | G. Basket Release Button | |
| D. Outer Basket | H. Housing Handles | |

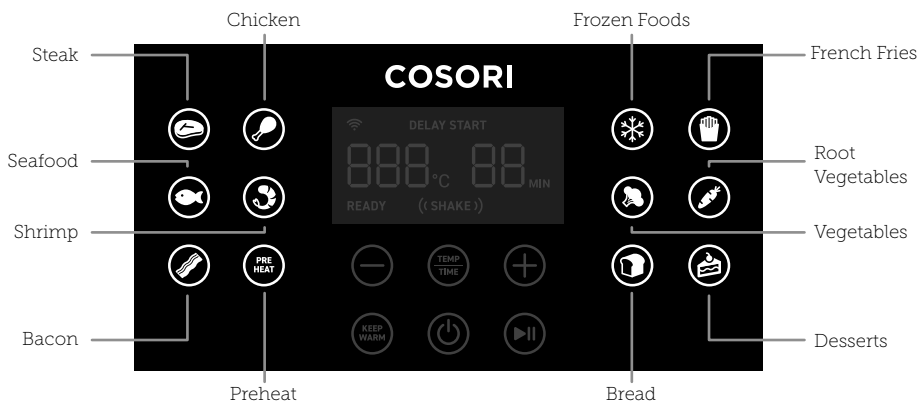
DISPLAY DIAGRAM

Note: When you press a button to use a function or program, it will turn blue to show that it's active. [Figure 1.1]

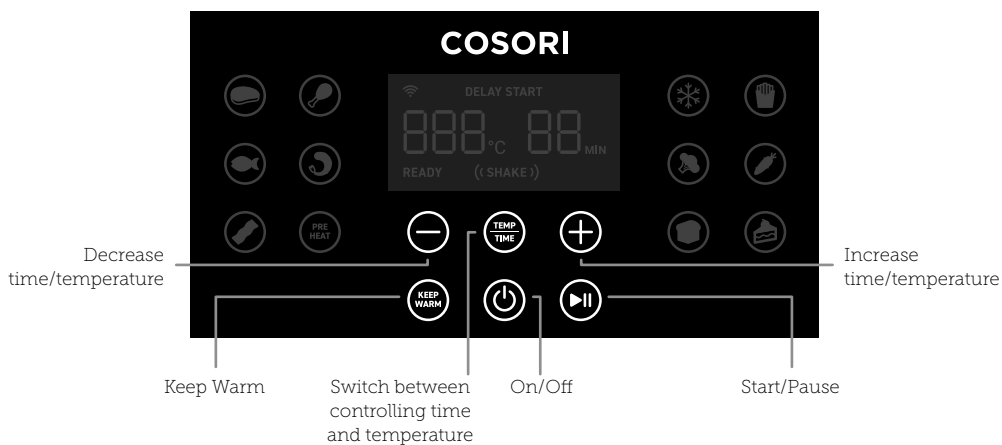



Figure 1.1

Presets



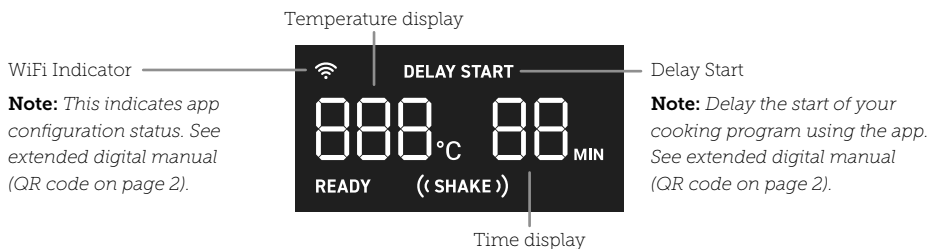
Control Panel



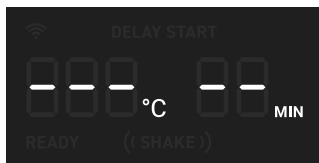
Note: Press and hold  to configure your air fryer. See extended digital manual (QR code on page 2).

DISPLAY DIAGRAM (CONT.)

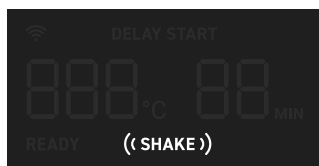
Display



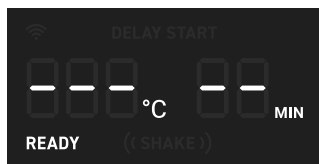
DISPLAY MESSAGES



Cooking program has ended.



Reminder to shake or flip food.



Air fryer is preheated and ready to start cooking.

BEFORE FIRST USE

Setting Up

1. Remove all packaging from the air fryer, including any temporary stickers.
2. Place the air fryer on a stable, level, heat-resistant surface. Keep away from areas that can be damaged by steam (such as walls or cupboards).

Note: Leave 13 cm / 5 in of space behind and above the air fryer. [Figure 2.1] Leave enough room to remove the baskets.

3. Pull the handle to remove the baskets. Remove all plastic from the baskets.
4. Press the basket release button to separate the inner basket from the outer basket.
5. Wash both baskets thoroughly, using either a dishwasher or a non-abrasive sponge.
6. Wipe the inside and outside of the air fryer with a slightly moist cloth. Dry with a towel.
7. Put the baskets back inside the air fryer.

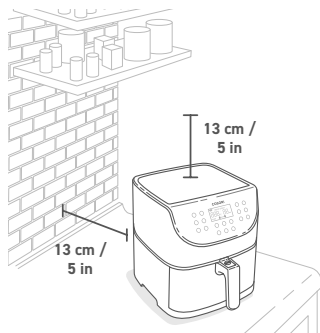


Figure 2.1

Test Run

A test run will help you become familiar with your air fryer, make sure it's working correctly, and clean it of possible residues in the process.

1. Make sure the air fryer baskets are empty and plug in the air fryer.
2. Press **Preheat**. The display will show "205°C" and "5 MIN".
3. Press **▶||** to begin preheating. When preheating is done, the air fryer will beep.
4. Pull out the baskets and let them cool for 5 minutes. Then place the empty baskets back in the air fryer.
5. Press **👉** to select the **Steak** preset. The display will show "205°C" and "6 MIN".
6. Press **Temp/Time** twice. The time will blink on the display. Press the **-** button once to change the time to 5 minutes.
7. Press **▶||** to begin. When finished, the air fryer will beep.
8. Pull out the baskets. This time, let the baskets cool completely for 10–30 minutes.

Basket Tips

- **Only** separate the baskets to clean or after cooking.
- The button guard protects the release button from being pressed accidentally. Slide the button guard forward to press the release button. [Figure 2.2]
- **Never** press the release button while carrying the baskets.
- **Only** press the basket release button with the baskets resting on a counter, or any level, heat-resistant surface.
- The handle is attached to the inner basket, not the outer basket. [Figure 2.3] When you press the release button, the outer basket will **drop**.

Note:

- **Do not** unscrew the basket handle from the baskets.
- To order accessories, please contact **Customer Support** (see page 21).

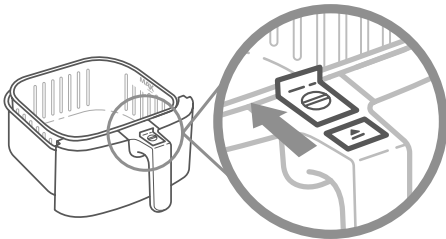


Figure 2.2

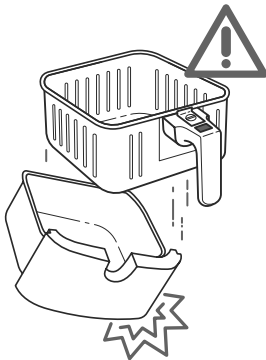


Figure 2.3

VeSync App Setup

1. To download the VeSync app, scan the QR code or search “VeSync” in the Apple App Store® or Google Play™ Store.



2. Open the VeSync app. If you already have an account, tap **Log In**. To create a new account, tap **Sign Up**.
3. Follow the in-app instructions to finish setting up your air fryer. For more information, see the extended digital manual (QR code on page 3).


Note: You can connect to the VeSync app by selecting model **CS158-AF** or **CS158-AF-RXB**.

USING YOUR AIR FRYER


Note: You can use the VeSync app to control all functions of your air fryer, follow in-app recipes, and more. For full instructions, see the extended digital manual (QR code on page 3).

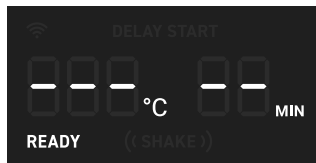
Preheating

We recommend preheating before placing food into the air fryer, unless your air fryer is already hot. Food will not cook thoroughly without preheating.

1. Plug in. Press  to turn on the air fryer.
2. Press **Preheat**. The display will show "**205°C**" and "**5 MIN**".
3. Optionally, press the + or – buttons to change the temperature. The time will adjust automatically.

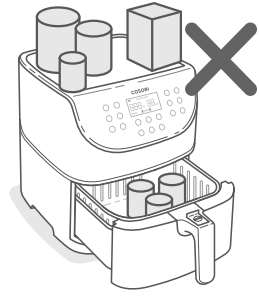
Temperature	Time
205°C	5 minutes
200°C	5 minutes
195°C	5 minutes
190°C	4 minutes
185°C	4 minutes
180°C	4 minutes
170°C	4 minutes
165°C and below	3 minutes

4. Press  to begin preheating.
5. When preheating is done, the air fryer will beep 3 times. The display will show:



Note: If no buttons are pressed for 3 minutes, the air fryer will clear all settings and go into standby.

Air Frying



Note:

- **Do not** place anything on top of your air fryer. This will disrupt airflow and cause poor air frying results. [Figure 3.1]
- An air fryer is not a deep fryer. **Do not** fill the baskets with oil, frying fat, or any liquid.
- When taking the baskets out of the air fryer, be careful of hot steam, and **do not** press the basket release button.

Figure 3.1

Preset Settings

- You can customise time (1–60 minutes) and temperature (75°–205°C / 170°–400°F), unless noted.
- Results may vary. Check out our Reference Guide and Recipe Book for a guide to customizing presets for perfect results.

Preset	Symbol	Default Temperature	Default Time	Shake Reminder?*
Steak		205°C	6 minutes	-
Chicken		195°C	25 minutes	-
Seafood		175°C	8 minutes	-
Shrimp		190°C	6 minutes	((SHAKE))
Bacon		160°C	8 minutes	-
Frozen Foods		175°C	10 minutes	((SHAKE))
French Fries**		195°C	25 minutes	((SHAKE))
Vegetables		150°C	10 minutes	((SHAKE))
Root Vegetables		205°C	12 minutes	((SHAKE))
Bread		160°C	8 minutes	-
Desserts		150°C	30 minutes	-
Preheat		205°C	5 minutes	-
Keep Warm		75°C	5 minutes	-

* See **Shaking Food** (page 15).

** See **Cooking Guide** (page 16) for tips on air frying french fries.

Preset Air Frying Programs

Using a preset is the easiest way to air fry. Presets are programmed with an ideal time and temperature for cooking certain foods.

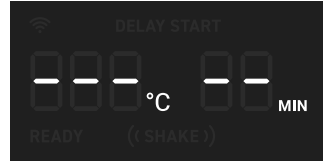
1. **Preheat your air fryer** (see page 11).
2. When your air fryer displays **"READY"**, add food to the baskets.
3. Select a preset cooking program (see page 12).
4. Optionally, customise the temperature and time. You can do this anytime during cooking.
 - a. Press **Temp/Time** once. The temperature will blink on the display. Press the + or – buttons to change the temperature (75°–205°C / 170°–400°F).
 - b. Press **Temp/Time** a second time. The time will blink on the display. Press the + or – buttons to change the time (1–60 minutes).

Note: To rapidly increase or decrease time or temperature, press and hold the + or - buttons.

5. Press **▶||** to begin air frying.
6. When using certain presets, the Shake Reminder will appear halfway through cooking time. The air fryer will beep 5 times, and **"((SHAKE))"** will blink on the display.
 - a. Take the baskets out of the air fryer, being careful of hot steam. The air fryer will pause cooking automatically, and the display will turn off until the baskets are replaced.
 - b. Shake or flip the food. Be careful not to press the basket release button.
 - c. Put the baskets back into the air fryer.

Note: See **Shaking Food** (page 15).

7. The air fryer will beep 3 times when finished. The display will show:



8. Optionally, press **Keep Warm**. Press the + or – buttons to change the time (1–60 minutes).
9. Take the baskets out of the air fryer, being careful of hot steam.
10. Remove the inner basket from the outer basket to serve food. When separating baskets:
 - a. Make sure the baskets are resting on a flat surface.
 - b. Watch for hot oil or fat collected in the outer basket. To avoid splashing, drain oil before replacing inner basket. [Figure 3.2]
11. Allow to cool before cleaning.

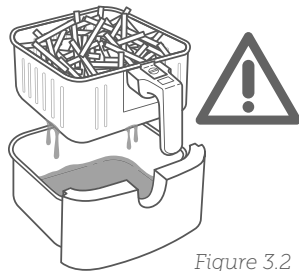


Figure 3.2

Manual Air Frying

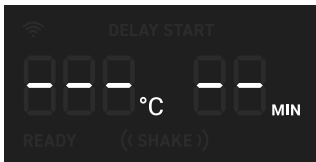
1. **Preheat your air fryer** (see page 11).
2. When your air fryer displays **"READY"**, add food to the baskets.
3. Set the temperature and time. You can change this any time during cooking.
 - a. Press **Temp/Time** once. The temperature will blink on the display. Press the + or – buttons to change the temperature (75°–205°C / 170°–400°F).
 - b. Press **Temp/Time** a second time. The time will blink on the display. Press the + or – buttons to change the time (1–60 minutes).
6. Optionally, press **Keep Warm**. Press the + or – buttons to change the time (1–60 minutes).
7. Take the baskets out of the air fryer, being careful of hot steam.
8. Remove the inner basket from the outer basket to serve food. When separating baskets:
 - a. Make sure the baskets are resting on a flat surface.
 - b. Watch for hot oil or fat collected in the outer basket. To avoid splashing, drain oil before replacing inner basket. [Figure 3.2]
9. Allow to cool before cleaning.

Note: To rapidly increase or decrease time or temperature, press and hold the + or - buttons.

4. Press ►|| to begin air frying.

Note:

- When manually air frying, there will be no Shake Reminder. You should still shake or flip appropriate foods.
 - If you want the Shake Reminder, select a preset program with the reminder (see page 12) and change the time and temperature as desired.
5. The air fryer will beep 3 times when finished. The display will show:



Shaking Food

How to Shake

- During cooking, take the baskets out of the air fryer and shake, mix, or flip the food.
 - A.** To shake food:
 - 1.** Hold the baskets just above a heat-resistant surface for safety purposes. **Do not** press the basket release button.
 - 2.** Shake the baskets.
 - B.** If the baskets are too heavy to shake:
 - 1.** Place the baskets on a heat-resistant holder or surface.
 - 2.** Separate the baskets. Make sure no liquids are dripping from the inner basket.
 - 3.** Carefully shake the inner basket.

Note: Do not use this method if there is a risk of hot liquids splashing.

- C.** If the baskets are too heavy to shake and there are hot liquids present:
 - 1.** Place the baskets on a heat-resistant holder or surface.
 - 2.** Use tongs to mix or flip the food.
- When you take the baskets out, the air fryer will pause cooking automatically. As a safety feature, the display will turn off until the baskets are replaced.
 - When you replace the baskets, cooking will automatically resume.
 - Avoid shaking longer than 30 seconds, as the air fryer may start to cool down.

What to Shake

- Small foods that are stacked will usually need shaking, such as fries or nuggets.
- Without shaking, foods may not be crispy or evenly cooked.
- You can flip other foods, such as steak, to ensure even browning.

When to Shake

- Shake or flip food once halfway through cooking, or more if desired.
- Certain presets use a Shake Reminder (see **Preset Settings**, page 12).

Shake Reminder

- The Shake Reminder will alert you with 5 beeps, and "**((SHAKE))**" will blink on the display.
- If you do not remove the baskets, the Shake Reminder will beep again after 1 minute and the display will show a solid "**((SHAKE))**".
- The Shake Reminder will go away once you take out the baskets.

Cooking Guide

Overfilling

- If the basket is overfilled, food will cook unevenly.
- Food should not be filled over the “MAX” line of the inner basket. [Figure 3.3]
Do not pack in food.



Figure 3.3

Using Oil

- Adding a small amount of oil to your food will make it crispier. Use no more than 30 mL / 2 US tbsp of oil.
- Oil sprays are excellent for applying small amounts of oil evenly to all food items.

Food Tips

- You can air fry any frozen foods or goods that can be baked in an oven.
- To make cakes, hand pies, or any food with filling or batter, place food in a heat-safe container before placing in the baskets.
- Air frying high-fat foods will cause fat to drip to the bottom of the baskets. To avoid excess smoke while cooking, pour out fat drippings after cooking.
- Liquid-marinated foods create splatter and excess smoke. Pat these foods dry before air frying.

French Fries

- Add 8–15 mL / $\frac{1}{2}$ –1 US tbs oil for crispiness.
- When making fries from raw potatoes, soak uncooked fries in water for 15 minutes to remove starch prior to frying. Pat dry with a towel before adding oil.
- Cut uncooked fries smaller for crispier results. Try cutting fries into 0.6- by 7.6-cm / $\frac{1}{4}$ - by 3-inch strips.

Note: For more from the Cosori Kitchen, check out our *Recipe Book and Tips from the Chef*.

More Functions

Pausing

- Press ►|| to pause cooking. The air fryer will stop heating, and ►|| will blink until you press ►|| to resume cooking.
- After 30 minutes of inactivity, the air fryer will turn off.
- This function allows you to pause the cooking program without removing the baskets from the air fryer.

Automatically Resume Cooking

- If you pull out the baskets, the air fryer will pause cooking automatically. The display will turn off temporarily as a safety feature.
- When you return the baskets, the air fryer will automatically resume cooking based on your previous settings.

Automatic Shutoff

- If the air fryer has no active cooking programs, the air fryer will clear all settings and turn off after 3 minutes of inactivity.

Overheat Protection

- If the air fryer overheats, it will automatically shut down as a safety feature.
- Let the air fryer cool down completely before using it again.

CARE AND MAINTENANCE

Note:

- **Always** clean the air fryer baskets and interior after every use.
 - Lining the outer basket with foil may make cleanup easier.
1. Turn off and unplug the air fryer. Allow it to cool completely before cleaning. Pull out the baskets for faster cooling.
 2. Wipe the outside of the air fryer with a moist cloth, if necessary.
 3. The baskets are dishwasher safe. You can also wash the baskets with hot, soapy water and a non-abrasive sponge. Soak if necessary.

Note: The baskets have a nonstick coating. Avoid using metal utensils and abrasive cleaning materials.

4. For stubborn grease:
 - a. In a small bowl, mix 30 mL / 2 US tbsp of baking soda and 15 mL / 1 US tbsp of water to form a spreadable paste.
 - b. Use a sponge to spread the paste on the baskets and scrub. Let the baskets sit for 15 minutes before rinsing.
 - c. Wash baskets with soap and water before using.

5. Clean the inside of the air fryer with a slightly moist, non-abrasive sponge or cloth. **Do not** immerse in water. [Figure 4.1] If needed, clean the heating coil to remove food debris.
6. Dry before using.

Note: Make sure the heating coil is completely dry before turning on the air fryer.

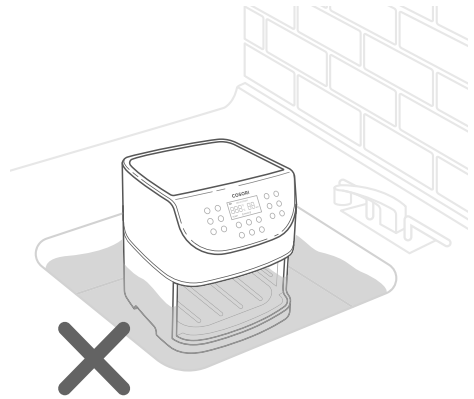


Figure 4.1

ACCESSORIES

You can purchase more accessories for your air fryer from **Amazon** by searching for "**B07PRJYGB2**" or by scanning the QR code.

If you have any questions, please contact **Customer Support** (see page 21).



TROUBLESHOOTING

Problem	Possible Solution
The air fryer will not turn on.	Make sure the air fryer is plugged in.
	Push the baskets securely into the air fryer.
Foods are not completely cooked.	Place smaller batches of food items into the inner basket. If the basket is overstuffed, then foods will be undercooked.
	Increase cooking temperature or time.
Foods are cooked unevenly.	Foods that are stacked on top of each other or close to each other need to be shaken or flipped during cooking (see Shaking Food , page 15).
Foods are not crispy after air frying.	Spraying or brushing a small amount of oil on foods can increase crispiness (see Cooking Guide , page 16).
French fries are not cooked correctly.	See French Fries , page 16.
Baskets will not slide into the air fryer securely.	Make sure the inner basket is not overfilled with food.
	Make sure the inner basket is securely inside the outer basket.
White smoke is coming out of the air fryer.	The air fryer may produce some white smoke when you use it for the first time. This is normal.
	Make sure the baskets and the inside of the air fryer are cleaned properly and not greasy.
	Cooking greasy foods will cause oil to leak into the outer basket. This oil will produce white smoke, and the baskets may be hotter than usual. This is normal, and should not affect cooking. Handle baskets with care.
Dark smoke is coming out of the air fryer.	Immediately unplug your air fryer. Dark smoke means that food is burning or there is a circuit problem. Wait for smoke to clear before pulling the baskets out. If the cause was not burnt food, contact Customer Support (page 21).

TROUBLESHOOTING (CONT.)

Problem	Possible Solution
The air fryer has a plastic smell.	Any air fryer may have a plastic smell from the manufacturing process. This is normal. Follow the instructions for a Test Run (page 9) to get rid of the plastic smell. If a plastic smell is still present, please contact Customer Support (see page 21).
Display shows Error Code "E1".	There is an open circuit in the temperature monitor. Contact Customer Support (see page 21).
Display shows Error Code "E2".	There is a short circuit in the temperature monitor. Contact Customer Support (see page 21).

If your problem is not listed, please contact **Customer Support** (see page 21).



This symbol means the product must not be discarded as household waste, and should be delivered to an appropriate collection facility for recycling. Proper disposal and recycling helps protect natural resources, human health and the environment.

For more information on disposal and recycling of this product, contact your local municipality, disposal service, or the shop where you bought this product.

WARRANTY INFORMATION

Arovast Corporation warrants all products to be of the highest quality in material, craftsmanship, and service for 2 years, effective from the date of purchase to the end of the warranty period. Warranty lengths may vary between product categories.

If you have any questions or concerns about your new product, please contact our helpful Customer Support Team.

Trademark Information

Amazon, Alexa, and all related logos are trademarks of Amazon.com, Inc. or its affiliates.

Google and Google Play are trademarks of Google LLC.

Apple App Store is a trademark of Apple Inc.

CUSTOMER SUPPORT

Arovast Corporation

1202 N. Miller St., Suite A
Anaheim, CA 92806
USA

Email: support.eu@cosori.com

*Please have your order invoice and order ID ready before contacting Customer Support.

DECLARATION OF CONFORMITY

Arovast Corporation hereby declares that this product is in compliance with the essential requirements and other relevant provisions of Directive 2014/53/EU, UK Radio Equipment Regulations 2017 and all other applicable EU and UK directive requirements.

The complete declaration of conformity can be found at: <https://cosori.com/euro/compliance>.

SHOW US WHAT YOU'RE MAKING

We hope this has been helpful to you. We can't wait to see your beautiful results, and we think you'll want to share glam shots! Our community awaits your uploads—just pick your platform of choice below.

Snap, tag, and hashtag away, Cosori chef!

#iCookCosori



@cosoricooks



Cosori Appliances

Considering what to cook? Many recipe ideas are available, both from us and the Cosori community.

COSORI

Questions or Concerns?

support.eu@cosori.com

A3-D_21K25-CS158-AF_uk