

# Dell EMC PowerEdge R540

## Installation and Service Manual

## Notes, cautions, and warnings

 **NOTE:** A NOTE indicates important information that helps you make better use of your product.

 **CAUTION:** A CAUTION indicates either potential damage to hardware or loss of data and tells you how to avoid the problem.

 **WARNING:** A WARNING indicates a potential for property damage, personal injury, or death.

<b>Chapter 1: Dell EMC PowerEdge R540 overview.....</b>	<b>7</b>
Supported configurations for the PowerEdge R540 system.....	7
Front view of the system.....	8
Left control panel view.....	10
Right control panel view.....	13
Drive indicator codes.....	14
Back panel features.....	15
NIC indicator codes.....	20
Power supply unit indicator codes.....	20
LCD panel.....	22
Viewing Home screen.....	23
Setup menu.....	23
View menu.....	24
Locating the Service Tag of your system.....	24
System information label.....	25
<b>Chapter 2: Initial system setup and configuration.....</b>	<b>28</b>
Setting up your system.....	28
iDRAC configuration.....	28
Options to set up iDRAC IP address.....	28
Log in to iDRAC.....	29
Options to install the operating system.....	29
Methods to download firmware and drivers.....	29
Downloading drivers and firmware.....	30
<b>Chapter 3: Installing and removing system components .....</b>	<b>31</b>
Safety instructions.....	31
Before working inside your system.....	32
After working inside your system.....	32
Recommended tools.....	32
Optional front bezel.....	32
Removing the front bezel.....	33
Installing the front bezel.....	33
System cover.....	34
Removing the system cover.....	34
Installing the system cover.....	35
Backplane cover.....	36
Removing the backplane cover.....	36
Installing the backplane cover.....	37
Inside the system.....	38
Air shroud.....	41
Removing the air shroud.....	41
Installing the air shroud.....	42
Cooling fans.....	44

Removing the cooling fan.....	44
Installing cooling fan.....	45
Internal PERC riser.....	47
Removing the internal PERC riser.....	47
Installing the internal PERC riser.....	49
Removing the PERC card from the internal PERC riser.....	50
Installing PERC card into the internal PERC riser.....	51
Intrusion switch.....	52
Removing the intrusion switch.....	52
Installing the intrusion switch.....	53
Drives.....	54
Removing a drive blank.....	54
Installing a drive blank.....	55
Removing a 2.5-inch drive from a 3.5-inch drive adapter.....	55
Installing a 2.5-inch drive into a 3.5-inch drive adapter.....	56
Removing a 3.5-inch drive adapter from a 3.5-inch drive carrier.....	57
Installing a 3.5-inch drive adapter into the 3.5-inch drive carrier.....	58
Removing a drive carrier.....	59
Installing a drive carrier.....	60
Removing the drive from the drive carrier.....	61
Installing a drive into the drive carrier.....	62
System memory.....	62
System memory guidelines.....	62
General memory module installation guidelines.....	63
Mode-specific guidelines.....	64
Removing a memory module.....	66
Installing a memory module.....	67
Processors and heat sinks.....	68
Removing a processor and heat sink module.....	68
Removing the non-fabric processor from the processor and heat sink module.....	69
Installing the non-fabric processor into a processor and heat sink module.....	71
Installing a processor and heat sink module.....	73
Expansion cards and expansion card risers.....	74
Expansion card installation guidelines.....	74
Removing expansion card from the expansion card riser.....	78
Installing expansion card into the expansion card riser.....	82
Removing expansion card from the system board.....	85
Installing expansion card on the system board.....	87
Removing an expansion card riser.....	89
Installing an expansion card riser.....	92
M.2 SSD module.....	94
Removing the M.2 SSD module.....	94
Installing the M.2 SSD module.....	95
Optional microSD or vFlash card.....	96
Removing the microSD card.....	96
Installing the microSD card.....	97
Optional IDSDM or vFlash module.....	98
Removing the optional IDSDM or vFlash card.....	98
Installing optional IDSDM or vFlash card.....	99
LOM riser card.....	100

Removing the LOM riser card.....	100
Installing the LOM riser card.....	101
Drive backplane.....	102
Backplane details.....	102
Removing the backplane .....	104
Installing the backplane.....	105
Removing the 3.5-inch rear drive backplane.....	105
Installing the 3.5-inch rear drive backplane.....	106
Cable routing.....	108
Rear drive cage.....	111
Removing the rear drive cage.....	111
Installing the rear drive cage.....	111
System battery.....	112
Replacing the system battery.....	112
Optional internal USB memory key.....	113
Replacing the optional internal USB memory key.....	113
Optical drive (optional).....	114
Removing the optical drive.....	114
Installing the optical drive.....	115
Power supply units.....	115
Hot spare feature.....	116
Removing a power supply unit blank.....	116
Installing a power supply unit blank.....	116
Removing a power supply unit.....	117
Installing a power supply unit.....	118
Removing a non-redundant cabled AC power supply unit.....	118
Installing a non-redundant cabled AC power supply unit.....	119
Removing a DC power supply unit.....	120
Installing DC power supply unit.....	121
Wiring instructions for a DC power supply unit.....	121
Power interposer board.....	123
Removing power interposer board.....	123
Installing power interposer board.....	123
Control panel.....	124
Removing the left control panel.....	124
Installing the left control panel.....	125
Removing the right control panel.....	126
Installing the right control panel.....	127
System board.....	128
Removing the system board.....	128
Installing the system board.....	130
Restoring the system using Easy Restore.....	132
Manually update the Service Tag.....	132
Entering the system Service Tag by using System Setup.....	132
Trusted Platform Module.....	133
Upgrading the Trusted Platform Module.....	133
Initializing TPM for BitLocker users.....	134
Initializing the TPM 1.2 for TXT users.....	134

**Chapter 4: Jumpers and connectors ..... 135**

System board jumpers and connectors.....	135
System board jumper settings.....	136
Disabling forgotten password.....	137
<b>Chapter 5: System diagnostics.....</b>	<b>138</b>
Dell Embedded System Diagnostics.....	138
Running the Embedded System Diagnostics from Boot Manager.....	138
Running the Embedded System Diagnostics from the Dell Lifecycle Controller.....	138
System diagnostic controls.....	138
<b>Chapter 6: Getting help.....</b>	<b>140</b>
Contacting Dell EMC.....	140
Documentation feedback.....	140
Accessing system information by using QRL.....	140
Quick Resource Locator for R540.....	141
Receiving automated support with SupportAssist .....	141
Recycling or End-of-Life service information.....	141
<b>Chapter 7: Documentation resources.....</b>	<b>142</b>

# Dell EMC PowerEdge R540 overview

The Dell EMC PowerEdge R540 system is a 2U, dual socket rack system that supports up to:

- Two Intel Xeon Scalable Processors
- 16 DIMM slots
- Two AC and DC redundant power supply units (PSU) or single cabled PSU
- 14 drives or solid-state drives

**NOTE:** All instances of SAS, SATA hard drives and SSDs are referred to as drives in this document, unless specified otherwise.

## Topics:

- [Supported configurations for the PowerEdge R540 system](#)
- [Front view of the system](#)
- [Back panel features](#)
- [LCD panel](#)
- [Locating the Service Tag of your system](#)
- [System information label](#)

## Supported configurations for the PowerEdge R540 system

The Dell EMC PowerEdge R540 system supports the following configurations:

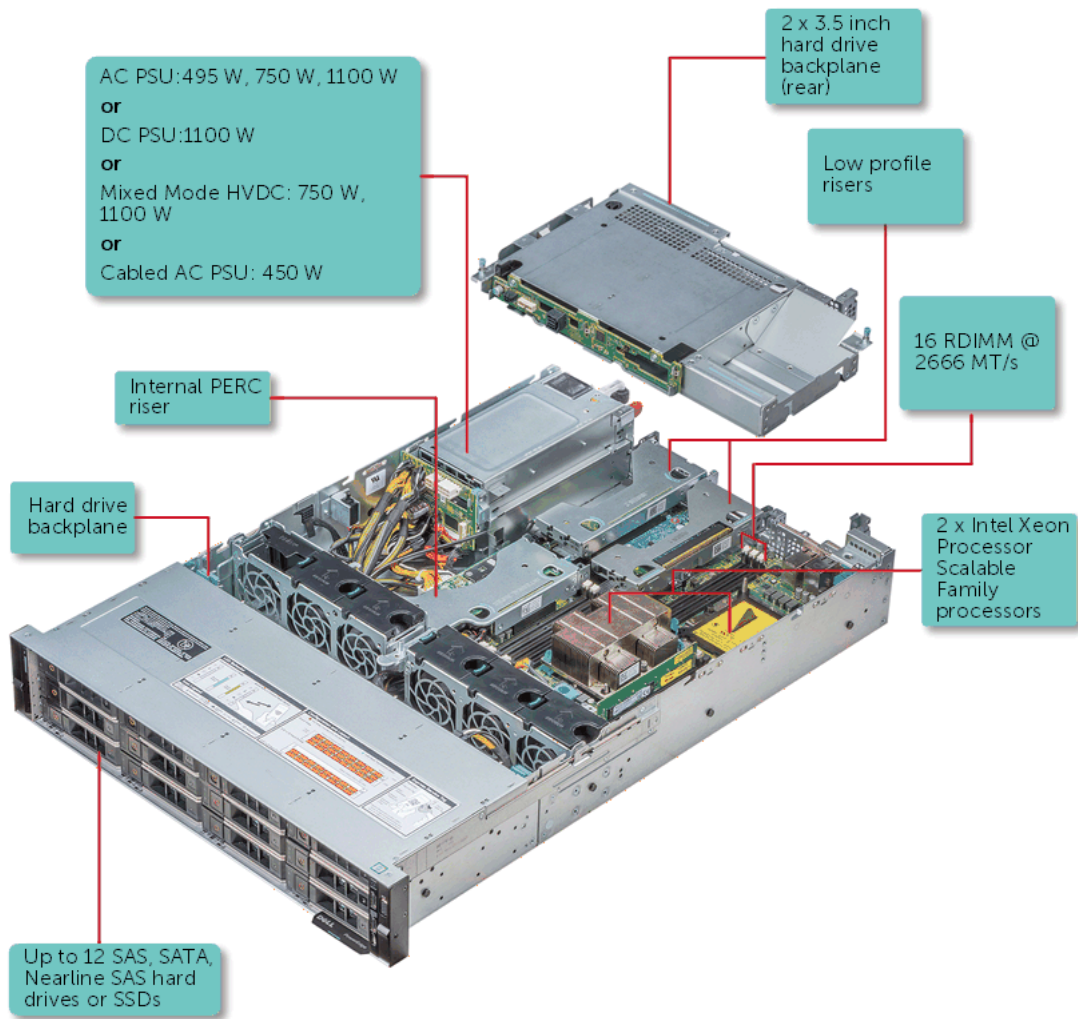


Figure 1. Supported configurations for a PowerEdge R540 system with rear drive

## Front view of the system

The front view displays the features available on the front of the system.

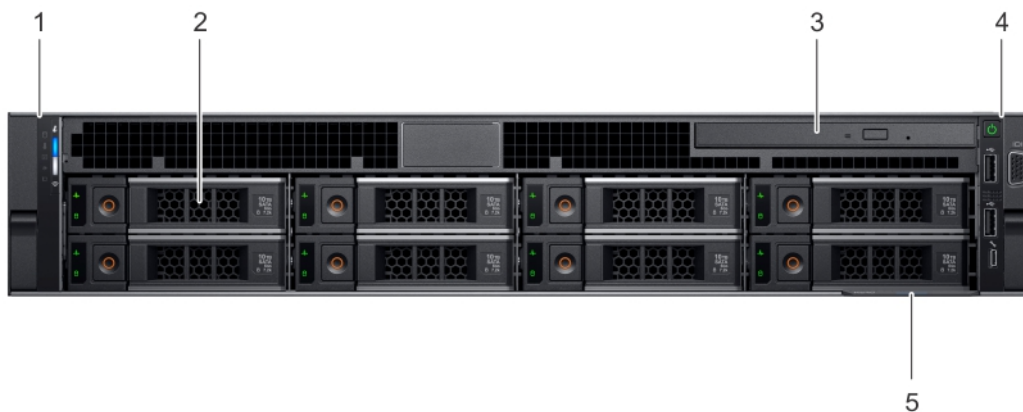


Figure 2. Front view of 12 x 3.5-inch drive system



**Table 1. Features available on the front of the system**

Item	Ports, panels, and slots	Icon	Description
1	Left control panel	N/A	<p>Contains the system health and system ID, status LED, and the iDRAC Quick Sync 2 (wireless) indicator.</p> <p><b>NOTE:</b> The iDRAC Quick Sync 2 indicator is available only on certain configurations.</p> <ul style="list-style-type: none"> <li>Status LED: Enables you to identify any failed hardware components. There are up to five status LEDs and an overall system health LED (Chassis health and system ID) bar. For more information, see the <a href="#">Status LED indicators</a> section.</li> <li>Quick Sync 2 (wireless): Indicates a Quick Sync enabled system. The Quick Sync feature is optional. This feature enables management of the system by using mobile devices. This feature aggregates hardware or firmware inventory and various system level diagnostic and error information that can be used in troubleshooting the system. For more information, see the <i>Integrated Dell Remote Access Controller User's Guide</i> at <a href="http://www.dell.com/poweredgemanuals">www.dell.com/poweredgemanuals</a>.</li> </ul>
2	Drive slots	N/A	Enable you to install drives that are supported on your system. For more information, see the Dell EMC PowerEdge R540 Technical Specifications on the product documentation page.
3	Right control panel	N/A	Contains the power button, USB ports, iDRAC Direct (Micro-AB USB), VGA port.
4	Information tag	N/A	The Information Tag is a slide-out label panel that contains system information such as Service Tag, NIC, MAC address, and so on. If you have opted for the secure default access to iDRAC, the Information tag also contains the iDRAC secure default password.



**Figure 3. Front view of 8 x 3.5-inch drive system**

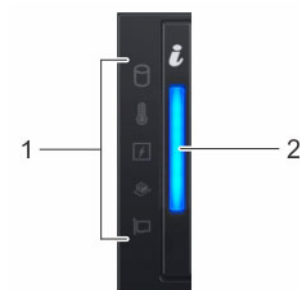
**Table 2. Features available on the front of the system**

Item	Ports, panels, and slots	Icon	Description
1	Left control panel	N/A	<p>Contains the system health and system ID, status LED, and the iDRAC Quick Sync 2 (wireless) indicator.</p> <p><b>NOTE:</b> The iDRAC Quick Sync 2 indicator is available only on certain configurations.</p>

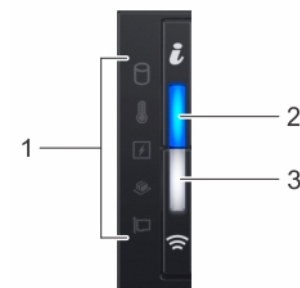
**Table 2. Features available on the front of the system (continued)**

Item	Ports, panels, and slots	Icon	Description
			<ul style="list-style-type: none"> <li>Status LED: Enables you to identify any failed hardware components. There are up to five status LEDs and an overall system health LED (Chassis health and system ID) bar. For more information, see the <a href="#">Status LED indicators</a> section.</li> <li>Quick Sync 2 (wireless): Indicates a Quick Sync enabled system. The Quick Sync feature is optional. This feature enables management of the system by using mobile devices. This feature aggregates hardware or firmware inventory and various system level diagnostic and error information that can be used in troubleshooting the system. For more information, see the <i>Integrated Dell Remote Access Controller User's Guide</i> at <a href="http://www.dell.com/idracmanuals">www.dell.com/idracmanuals</a>.</li> </ul>
2	Drive slots	N/A	Enable you to install drives that are supported on your system. For more information, see the Dell EMC PowerEdge R540 Technical Specifications on the product documentation page.
3	Optical drive (optional)	N/A	One optional slim SATA DVD-ROM drive or DVD+/-RW drive.
4	Right control panel	N/A	Contains the power button, USB ports, iDRAC Direct (Micro-AB USB), VGA port.
5	Information tag	N/A	The Information Tag is a slide-out label panel that contains system information such as Service Tag, NIC, MAC address, and so on. If you have opted for the secure default access to iDRAC, the Information tag also contains the iDRAC secure default password.

## Left control panel view





**Figure 4. Left control panel without optional iDRAC Quick Sync 2.0 indicator**




**Figure 5. Left control panel with optional iDRAC Quick Sync 2.0 indicator**







**Table 3. Left control panel**

Item	Indicator, button, or connector	Icon	Description
1	Status LED indicators	N/A	Indicate the status of the system. For more information, see the <a href="#">Status LED indicators</a> section.
2	System health and system ID indicator		Indicates the system health.
3	iDRAC Quick Sync 2 wireless indicator (optional)		Indicates if the iDRAC Quick Sync 2 wireless option is activated. The Quick Sync 2 feature allows management of the system using mobile devices. This feature aggregates hardware/firmware inventory and various system level diagnostic/error information that can be used in troubleshooting the system. You can access system inventory, Dell Lifecycle Controller logs or system logs, system health status, and also configure iDRAC, BIOS, and networking parameters. You can also launch the virtual Keyboard, Video, and Mouse (KVM) viewer and virtual Kernel based Virtual Machine (KVM), on a supported mobile device. For more information, see the <i>Integrated Dell Remote Access Controller User's Guide</i> at <a href="http://www.dell.com/poweredge/manuals">www.dell.com/poweredge/manuals</a> .

## Status LED indicators

 **NOTE:** The indicators display solid amber if any error occurs.

**Table 4. Status LED indicators and descriptions**

Icon	Description	Condition	Corrective action
	Drive indicator	The indicator turns solid amber if there is a drive error.	<ul style="list-style-type: none"> <li>Check the System Event Log to determine if the drive has an error.</li> <li>Run the appropriate Online Diagnostics test. Restart the system and run embedded diagnostics (ePSA).</li> <li>If the drives are configured in a RAID array, restart the system, and enter the host adapter configuration utility program.</li> </ul>
	Temperature indicator	The indicator turns solid amber if the system experiences a thermal error (for example, the ambient temperature is out of range or there is a fan failure).	<p>Ensure that none of the following conditions exist:</p> <ul style="list-style-type: none"> <li>A cooling fan has been removed or has failed.</li> <li>Ambient temperature is too high.</li> <li>External airflow is obstructed.</li> </ul> <p>If the problem persists, see <a href="#">Getting help</a>.</p>
	Electrical indicator	The indicator turns solid amber if the system experiences an electrical error (for example, voltage out of range, or a failed power supply unit (PSU) or voltage regulator).	<p>Check the System Event Log or system messages for the specific issue. If it is due to a problem with the PSU, check the LED on the PSU. Reseat the PSU.</p> <p>If the problem persists, see <a href="#">Getting help</a>.</p>
	Memory indicator	The indicator turns solid amber if a memory error occurs.	<p>Check the System Event Log or system messages for the location of the failed memory. Reseat the memory module.</p> <p>If the problem persists, see <a href="#">Getting help</a>.</p>
	PCIe indicator	The indicator turns solid amber if a PCIe card experiences an error.	<p>Restart the system. Update any required drivers for the PCIe card. Reinstall the card.</p> <p>If the problem persists, see <a href="#">Getting help</a>.</p> <p> <b>NOTE:</b> For more information about the supported PCIe cards, see <a href="#">Expansion card installation guidelines</a>.</p>

## System health and system ID indicator codes

The system health and system ID indicator is located on the left control panel of your system.



Figure 6. System health and system ID indicators

Table 5. System health and system ID indicator codes

System health and system ID indicator code	Condition
Solid blue	Indicates that the system is turned on, system is healthy, and system ID mode is not active. Press the system health and system ID button to switch to system ID mode.
Blinking blue	Indicates that the system ID mode is active. Press the system health and system ID button to switch to system health mode.
Solid amber	Indicates that the system is in fail-safe mode. If the problem persists, see the Getting help section.
Blinking amber	Indicates that the system is experiencing a fault. Check the System Event Log or the LCD panel, if available on the bezel, for specific error messages.  For more information about error messages, see the <i>Event and Error Message Reference Guide for 14th Generation Dell EMC PowerEdge Servers</i> at <a href="http://www.dell.com/qrl">www.dell.com/qrl</a> .

## iDRAC Quick Sync 2 indicator codes

iDRAC Quick Sync 2 module (optional) is located on the front panel of your system.

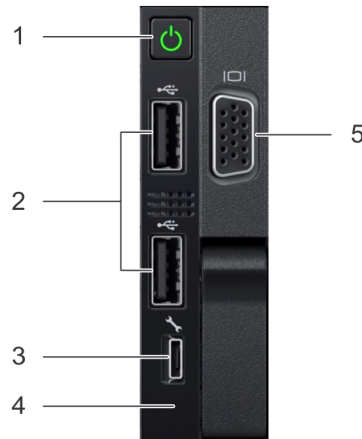
Table 6. iDRAC Quick Sync 2 indicators and descriptions

iDRAC Quick Sync 2 indicator code	Condition	Corrective action
Off (default state)	Indicates that the iDRAC Quick Sync 2 feature is turned off. Press the iDRAC Quick Sync 2 button to turn on the iDRAC Quick Sync 2 feature.	If the LED fails to turn on, reseal the cable and check. If the problem persists, see the <a href="#">Getting help</a> section.
Solid white	Indicates that iDRAC Quick Sync 2 is ready to communicate. Press the iDRAC Quick Sync 2 button to turn off.	If the LED fails to turn off, restart the system. If the problem persists, see the <a href="#">Getting help</a> section.
Blinks white rapidly	Indicates data transfer activity.	If the indicator continues to blink indefinitely, see the <a href="#">Getting help</a> section.
Blinks white slowly	Indicates that firmware update is in progress.	If the indicator continues to blink indefinitely, see the <a href="#">Getting help</a> section.
Blinks white five times rapidly and then turns off	Indicates that the iDRAC Quick Sync 2 feature is disabled.	Check if iDRAC Quick Sync 2 feature is configured to be disabled by iDRAC. If the problem persists, see the <a href="#">Getting help</a> section. For more information, see <i>Integrated Dell Remote Access Controller User's Guide</i> at <a href="http://www.dell.com/poweredgemanuals">www.dell.com/poweredgemanuals</a> or <i>Dell OpenManage Server Administrator User's Guide</i> at <a href="http://www.dell.com/openmanagemanuals">www.dell.com/openmanagemanuals</a> > OpenManage Server Administrator.

**Table 6. iDRAC Quick Sync 2 indicators and descriptions (continued)**

iDRAC Quick Sync 2 indicator code	Condition	Corrective action
Solid amber	Indicates that the system is in fail-safe mode.	Restart the system. If the problem persists, see the <a href="#">Getting help</a> section.
Blinking amber	Indicates that the iDRAC Quick Sync 2 hardware is not responding properly.	Restart the system. If the problem persists, see the <a href="#">Getting help</a> section.

## Right control panel view



**Figure 7. Right control panel**

**Table 7. Right control panel**

Item	Indicator, button, or connector	Icon	Description
1	Power button		Indicates if the system is powered on or off. Press the power button to manually power on or off the system.  <b>NOTE:</b> Press the power button to gracefully shut down an ACPI-compliant operating system.
2	USB port		The USB ports are 4-pin, 2.0-compliant. These ports enable you to connect USB devices to the system.
3	iDRAC Direct (Micro-AB USB)		The iDRAC Direct (Micro-AB USB) port enables you to access the iDRAC Direct (Micro-AB) features. For more information, see <i>Integrated Dell Remote Access Controller User's Guide</i> at <a href="http://www.dell.com/poweredgemanuals">www.dell.com/poweredgemanuals</a> .
4	iDRAC Direct (Micro-AB USB) LED	N/A	The iDRAC Direct (Micro-AB USB) LED indicator lights up to indicate that the iDRAC Direct port is connected. For more information, see the <i>Integrated Dell Remote Access Controller User's Guide</i> at <a href="http://www.dell.com/poweredgemanuals">www.dell.com/poweredgemanuals</a> .
5	VGA port		Enables you to connect a display device to the system. For more information, see the PowerEdge R540 Technical Specs at <a href="http://www.dell.com/poweredgemanuals">www.dell.com/poweredgemanuals</a> .

## iDRAC Direct LED indicator codes

The iDRAC Direct LED indicator lights up to indicate that the port is connected and is being used as a part of the iDRAC subsystem.

You can configure iDRAC Direct by using a USB to micro USB (type AB) cable, which you can connect to your laptop or tablet. The following table describes iDRAC Direct activity when the iDRAC Direct port is active:

**Table 8. iDRAC Direct LED indicator codes**

iDRAC Direct LED indicator code	Condition
Solid green for two seconds	Indicates that the laptop or tablet is connected.
Flashing green (on for two seconds and off for two seconds)	Indicates that the laptop or tablet connected is recognized.
Turns off	Indicates that the laptop or tablet is unplugged.

## Drive indicator codes

Each drive carrier has an activity LED indicator and a status LED indicator. The indicators provide information about the current status of the drive. The activity LED indicator indicates whether the drive is currently in use or not. The status LED indicator indicates the power condition of the drive.



**Figure 8. Drive indicators**

1. Drive activity LED indicator
2. Drive status LED indicator
3. Drive capacity label

**NOTE:** If the drive is in the Advanced Host Controller Interface (AHCI) mode, the status LED indicator does not turn on.

**Table 9. Drive indicator codes**

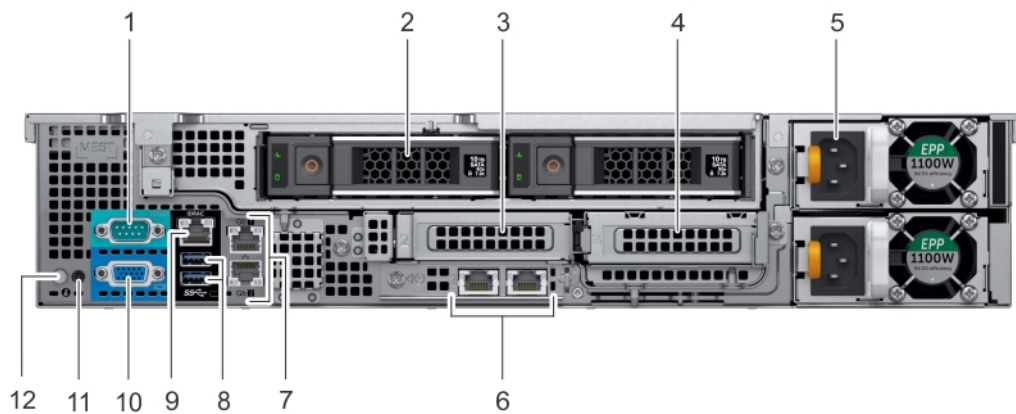
Drive status indicator code	Condition
Flashes green twice per second	Identifying drive or preparing for removal.
Off	Drive ready for removal. <b>NOTE:</b> The drive status indicator remains off until all drives are initialized after the system is turned on. Drives are not ready for removal during this time.
Flashes green, amber, and then turns off	Predicted drive failure.
Flashes amber four times per second	Drive failed.

**Table 9. Drive indicator codes (continued)**

Drive status indicator code	Condition
Flashes green slowly	Drive rebuilding.
Solid green	Drive online.
Flashes green for three seconds, amber for three seconds, and then turns off after six seconds	Rebuild stopped.


## Back panel features

This back view displays the features available on the back of the system.








**Figure 9. Back panel features of 12 x 3.5-inch + 2 x 3.5-inch (rear) drive system**

**Table 10. Back panel features of R540**

Item	Features	Icon	Description
1	Serial port	IOIOI	Use the serial port to connect a serial device to the system. For more information, see the Dell EMC PowerEdge R540 Technical Specifications on the product documentation page.
2	Drive (2)	N/A	Two optional rear drives supported for 12 x 3.5 -inch system.
3	Low profile riser right slot	N/A	Use the card slot to connect half-height PCIe expansion card on low profile riser.
4	Low profile riser left slot	N/A	Use the card slot to connect half-height PCIe expansion card on low profile riser.
5	Power supply unit (PSU) (2)	N/A	For more information, see the Dell EMC PowerEdge R540 Technical Specifications on the product documentation page.
6	LOM riser port (2)		Use the Ethernet or SFP+ ports to connect Local Area Networks (LANs) to the system. For more information

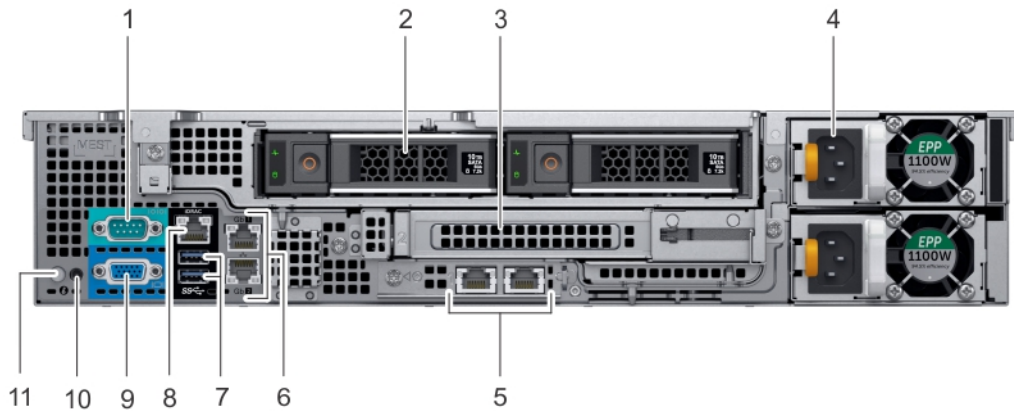
**Table 10. Back panel features of R540 (continued)**

Item	Features	Icon	Description
7	Ethernet port (2)		<p>about the supported Ethernet or SFP+ ports. For more information, see the Dell EMC PowerEdge R540 Technical Specifications on the product documentation page.</p> <p>Use the Ethernet ports to connect Local Area Networks (LANs) to the system. For more information about the supported Ethernet ports, For more information, see the Dell EMC PowerEdge R540 Technical Specifications on the product documentation page.</p>
8	USB 3.0 port (2)		<p>Use the USB 3.0 port to connect USB devices to the system. These ports are 4-pin, USB 3.0-compliant.</p>
9	iDRAC9 dedicated network port		<p>Use the iDRAC9 dedicated network port to securely access the embedded iDRAC on a separate management network, see the <i>Integrated Dell Remote Access Controller User's Guide</i> at <a href="http://www.dell.com/poweredgemanuals">www.dell.com/poweredgemanuals</a>.</p>
10	VGA port		<p>Use the VGA port to connect a display to the system. For more information about the supported VGA port, For more information, see the Dell EMC PowerEdge R540 Technical Specifications on the product documentation page.</p>
11	System status indicator cable port	N/A	<p>Enables you to connect the status indicator cable and view system status when the CMA is installed.</p>
12	System identification button		<p>Press the system ID button:</p> <ul style="list-style-type: none"> <li>• To locate a particular system within a rack.</li> <li>• To turn the system ID on or off.</li> </ul> <p>To reset iDRAC, press and hold the button for more than 15 s.</p> <p><b>NOTE:</b></p> <ul style="list-style-type: none"> <li>• To reset iDRAC using system ID, ensure that the system ID button is enabled in the iDRAC setup.</li> </ul>




**Table 10. Back panel features of R540 (continued)**

Item	Features	Icon	Description
			<ul style="list-style-type: none"> <li>If the system stops responding during POST, press and hold the system ID button (for more than five seconds) to enter the BIOS progress mode.</li> </ul>








**Figure 10. Back panel features of 12 x 3.5-inch + 2 x 3.5-inch (rear) drive system**

**Table 11. Back panel features of R540**

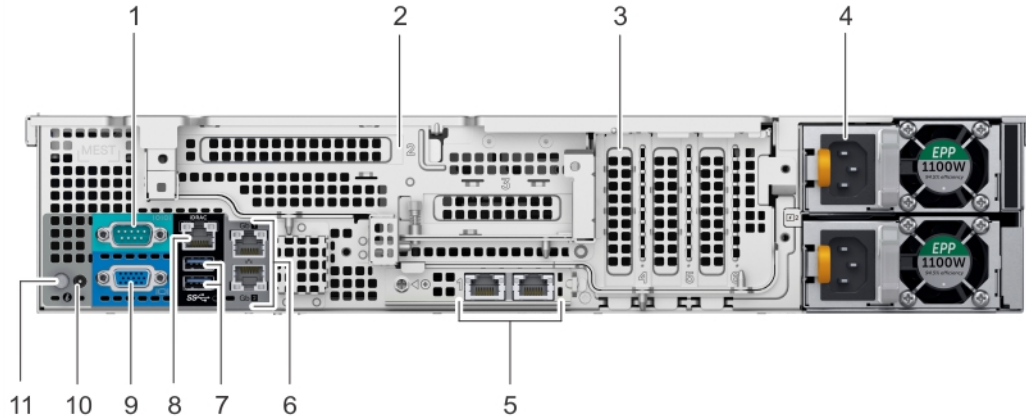
Item	Features	Icon	Description
1	Serial port	IOIOI	Use the serial port to connect a serial device to the system. For more information about the supported serial port, For more information, see the Dell EMC PowerEdge R540 Technical Specifications on the product documentation page.
2	Drive (2)	N/A	Two optional rear drives supported for 12 x 3.5 inch system.
3	Full height riser slot	N/A	Use the card slots to connect full-height PCIe expansion cards on full height riser.
4	Power supply unit (PSU) (2)	N/A	For information about supported PSUs, For more information, see the Dell EMC PowerEdge R540 Technical Specifications on the product documentation page.
5	LOM riser port (2)		Use the Ethernet or SFP+ ports to connect Local Area Networks (LANs) to the system. For more information about the supported Ethernet or SFP+ ports, For more information, see the Dell EMC

**Table 11. Back panel features of R540 (continued)**

Item	Features	Icon	Description
6	Ethernet port (2)		PowerEdge R540 Technical Specifications on the product documentation page.  Use the Ethernet ports to connect Local Area Networks (LANs) to the system. For more information about the supported Ethernet ports, For more information, see the Dell EMC PowerEdge R540 Technical Specifications on the product documentation page.
7	USB 3.0 port (2)		Use the USB 3.0 port to connect USB devices to the system. These ports are 4-pin, USB 3.0-compliant.
8	iDRAC9 dedicated network port		Use the iDRAC9 dedicated network port to securely access the embedded iDRAC on a separate management network, see the <i>Integrated Dell Remote Access Controller User's Guide</i> at <a href="http://www.dell.com/poweredgemanuals">www.dell.com/poweredgemanuals</a> .
9	VGA port		Use the VGA port to connect a display to the system. For more information about the supported VGA port, For more information, see the Dell EMC PowerEdge R540 Technical Specifications on the product documentation page.
10	System status indicator cable port	N/A	Enables you to connect the status indicator cable and view system status when the CMA is installed.
11	System identification button		Press the system ID button: <ul style="list-style-type: none"> <li>• To locate a particular system within a rack.</li> <li>• To turn the system ID on or off.</li> </ul> To reset iDRAC, press and hold the button for more than 15 seconds. <p><b>NOTE:</b></p> <ul style="list-style-type: none"> <li>• To reset iDRAC using system ID, ensure that the system ID button is enabled in the iDRAC setup.</li> <li>• If the system stops responding during POST, press and hold the system ID button</li> </ul>

**Table 11. Back panel features of R540 (continued)**

Item	Features	Icon	Description
			(for more than five seconds) to enter the BIOS progress mode.




**Figure 11. Back panel features of 12 x 3.5-inch drive system with butterfly riser**

**Table 12. Back panel features of R540**

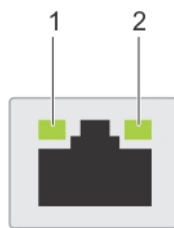
Item	Features	Icon	Description
1	Serial port	ⓂⓂⓂ	Use the serial port to connect a serial device to the system. For more information about the supported serial port, For more information, see the Dell EMC PowerEdge R540 Technical Specifications on the product documentation page.
2	Butterfly riser slot	N/A	Use the card slots to connect full-height PCIe expansion cards on butterfly riser.
3	PCIe slot (3)	N/A	Use the card slots to connect up to three half-height PCIe expansion cards on the system board.
4	Power supply unit (PSU)	N/A	For information about supported PSUs, For more information, see the Dell EMC PowerEdge R540 Technical Specifications on the product documentation page.
5	LOM riser ports	ⓂⓂ	Use the Ethernet or SFP+ ports to connect Local Area Networks (LANs) to the system. For more information about the supported Ethernet or SFP+ ports, For more information, see the Dell EMC PowerEdge R540 Technical Specifications on the product documentation page.
6	Ethernet ports (2)	ⓂⓂ	Use the Ethernet ports to connect Local Area Networks (LANs) to the system. For more information about the supported Ethernet ports, For more information, see the Dell EMC PowerEdge R540 Technical Specifications on the product documentation page.
7	USB 3.0 port	SS	Use the USB 3.0 port to connect USB devices to the system. These ports are 4-pin, USB 3.0-compliant.
8	iDRAC9 dedicated network port	Ⓜ	Use the iDRAC9 dedicated network port to securely access the embedded iDRAC on a separate management network, see the <i>Integrated Dell Remote Access Controller User's Guide</i> at <a href="http://www.dell.com/poweredgemanuals">www.dell.com/poweredgemanuals</a> .
9	VGA port	Ⓜ	Use the VGA port to connect a display to the system. For more information about the supported VGA port, For more

**Table 12. Back panel features of R540 (continued)**

Item	Features	Icon	Description
10	Status indicator cable port	N/A	information, see the Dell EMC PowerEdge R540 Technical Specifications on the product documentation page. Enables you to connect the status indicator cable and view system status when the CMA is installed.
11	System identification button		Press the system ID button: <ul style="list-style-type: none"> <li>To locate a particular system within a rack.</li> <li>To turn the system ID on or off.</li> </ul> To reset iDRAC, press and hold the button for more than 15 seconds. <p><b>NOTE:</b></p> <ul style="list-style-type: none"> <li>To reset iDRAC using system ID, ensure that the system ID button is enabled in the iDRAC setup.</li> <li>If the system stops responding during POST, press and hold the system ID button (for more than five seconds) to enter the BIOS progress mode.</li> </ul>

## NIC indicator codes

Each NIC on the back of the system has indicators that provide information about the activity and link status. The activity LED indicator indicates if data is flowing through the NIC, and the link LED indicator indicates the speed of the connected network.



**Figure 12. NIC indicator codes**

- link LED indicator
- activity LED indicator

**Table 13. NIC indicator codes**

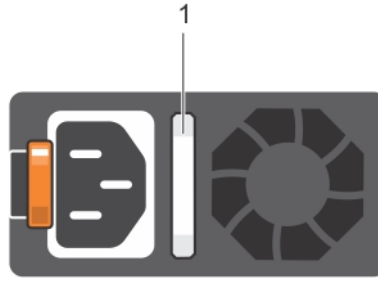
Status	Condition
Link and activity indicators are off	The NIC is not connected to the network.
Link indicator is green and activity indicator is blinking green	The NIC is connected to a valid network at its maximum port speed and data is being sent or received.
Link indicator is amber and activity indicator is blinking green	The NIC is connected to a valid network at less than its maximum port speed and data is being sent or received.
Link indicator is green and activity indicator is off	The NIC is connected to a valid network at its maximum port speed and data is not being sent or received.
Link indicator is amber and activity indicator is off	The NIC is connected to a valid network at less than its maximum port speed and data is not being sent or received.
Link indicator is blinking green and activity is off	NIC identify is enabled through the NIC configuration utility.

## Power supply unit indicator codes

AC power supply units (PSUs) have an illuminated translucent handle that serves as an indicator.

The DC PSUs have an LED that serves as an indicator.

The indicator shows whether power is present or if a power fault has occurred.

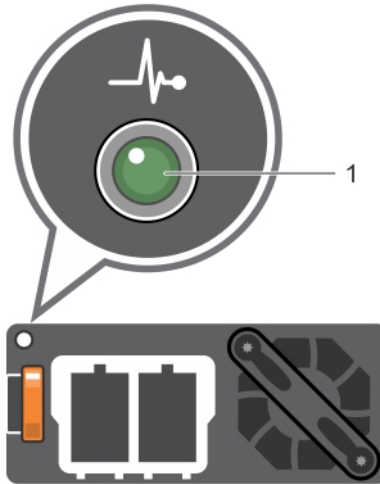


**Figure 13. AC PSU status indicator**

1. AC PSU status indicator/handle

**Table 14. AC PSU status indicator codes**

Power indicator codes	Condition
Green	A valid power source is connected to the PSU and the PSU is operational.
Blinking amber	Indicates a problem with the PSU.
Not illuminated	Power is not connected to the PSU.
Blinking green	When the firmware of the PSU is being updated, the PSU handle blinks green. <b>CAUTION:</b> Do not disconnect the power cord or unplug the PSU when updating firmware. If firmware update is interrupted, the PSUs do not function.
Blinking green and turns off	When hot-plugging a PSU, the PSU handle blinks green five times at a rate of 4 Hz and turns off. This indicates a PSU mismatch with respect to efficiency, feature set, health status, or supported voltage. <b>CAUTION:</b> If two PSUs are installed, both the PSUs must have the same type of label; for example, Extended Power Performance (EPP) label. Mixing PSUs from previous generations of PowerEdge servers is not supported, even if the PSUs have the same power rating. This results in a PSU mismatch condition or failure to turn the system on. <b>CAUTION:</b> When correcting a PSU mismatch, replace only the PSU with the blinking indicator. Swapping the PSU to make a matched pair can result in an error condition and unexpected system shutdown. To change from a high output configuration to a low output configuration or vice versa, you must turn off the system. <b>CAUTION:</b> AC PSUs support both 240 V and 120 V input voltages with the exception of Titanium PSUs, which support only 240 V. When two identical PSUs receive different input voltages, they can output different wattages, and trigger a mismatch. <b>CAUTION:</b> If two PSUs are used, they must be of the same type and have the same maximum output power. <b>CAUTION:</b> Combining AC and DC PSUs is not supported and triggers a mismatch.



**Figure 14. DC PSU status indicator**

1. DC PSU status indicator

**Table 15. DC PSU status indicator codes**

<b>Power indicator codes</b>	<b>Condition</b>
Green	A valid power source is connected to the PSU and the PSU is operational.
Blinking amber	Indicates a problem with the PSU.
Not illuminated	Power is not connected to the PSU.
Blinking green	<p>When hot-plugging a PSU, the PSU indicator blinks green. This indicates that there is a PSU mismatch with respect to efficiency, feature set, health status, or supported voltage.</p> <p><b>⚠ CAUTION: If two PSUs are installed, both the PSUs must have the same type of label; for example, Extended Power Performance (EPP) label. Mixing PSUs from previous generations of PowerEdge servers is not supported, even if the PSUs have the same power rating. This results in a PSU mismatch condition or failure to turn the system on.</b></p> <p><b>⚠ CAUTION: When correcting a PSU mismatch, replace only the PSU with the blinking indicator. Swapping the PSU to make a matched pair can result in an error condition and unexpected system shutdown. To change from a High Output configuration to a Low Output configuration or vice versa, you must turn off the system.</b></p> <p><b>⚠ CAUTION: If two PSUs are used, they must be of the same type and have the same maximum output power.</b></p> <p><b>⚠ CAUTION: Combining AC and DC PSUs is not supported and triggers a mismatch.</b></p>

## LCD panel

The LCD panel provides system information, status, and error messages to indicate if the system is functioning correctly or requires attention. The LCD panel can also be used to configure or view the system's iDRAC IP address. For information about the event and error messages generated by the system firmware and agents that monitor system components, go to [qrl.dell.com](http://qrl.dell.com) > **Look Up** > **Error Code**, type the error code, and then click **Look it up**.

The LCD panel is available only on the optional front bezel. The optional front bezel is hot pluggable.

The statuses and conditions of the LCD panel are outlined here:

- The LCD backlight is white during normal operating conditions.
- When the system needs attention, the LCD backlight turns amber, and displays an error code followed by descriptive text.

**NOTE:** If the system is connected to a power source and an error is detected, the LCD turns amber regardless of whether the system is turned on or off.

- When the system turns off and there are no errors, LCD enters the standby mode after five minutes of inactivity. Press any button on the LCD to turn it on.
- If the LCD panel stops responding, remove the bezel and reinstall it. If the problem persists, see the PowerEdge T640 Technical Specs at [www.dell.com/poweredgemanuals](http://www.dell.com/poweredgemanuals)
- The LCD backlight remains off if LCD messaging is turned off using the iDRAC utility, the LCD panel, or other tools.

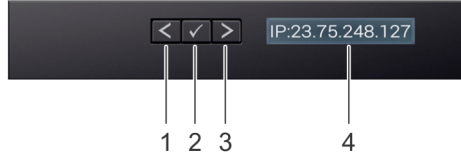


Figure 15. LCD panel features




Table 16. LCD panel features

Item	Button or display	Description
1	Left	Moves the cursor back in one-step increments.
2	Select	Selects the menu item highlighted by the cursor.
3	Right	Moves the cursor forward in one-step increments. During message scrolling: <ul style="list-style-type: none"> <li>• Press and hold the right button to increase scrolling speed.</li> <li>• Release the button to stop.</li> </ul> <b>NOTE:</b> The display stops scrolling when the button is released. After 45 seconds of inactivity, the display starts scrolling.
4	LCD display	Displays system information, status, and error messages or iDRAC IP address.

## Viewing Home screen

The **Home** screen displays user-configurable information about the system. This screen is displayed during normal system operation when there are no status messages or errors. When the system turns off and there are no errors, LCD enters the standby mode after five minutes of inactivity. Press any button on the LCD to turn it on.

### Steps

1. To view the **Home** screen, press one of the three navigation buttons (Select, Left, or Right).
2. To navigate to the **Home** screen from another menu, complete the following steps:
  - a. Press and hold the navigation button until the up arrow  is displayed.
  - b. Navigate to the **Home** icon  using the up arrow .
  - c. Select the **Home** icon.
  - d. On the **Home** screen, press the **Select** button to enter the main menu.

## Setup menu

**NOTE:** When you select an option in the **Setup** menu, you must confirm the option before proceeding to the next action.

Option	Description
iDRAC	Select <b>DHCP</b> or <b>Static IP</b> to configure the network mode. If <b>Static IP</b> is selected, the available fields are <b>IP</b> , <b>Subnet (Sub)</b> , and <b>Gateway (Gtw)</b> . Select <b>Setup DNS</b> to enable DNS and to view domain addresses. Two separate DNS entries are available.

Option	Description
<b>Set error</b>	Select <b>SEL</b> to view LCD error messages in a format that matches the IPMI description in the SEL. This enables you to match an LCD message with an SEL entry.  Select <b>Simple</b> to view LCD error messages in a simplified user-friendly description. For information about the event and error messages generated by the system firmware and agents that monitor system components, go to <a href="http://qrl.dell.com">qrl.dell.com</a> > <b>Look Up</b> > <b>Error Code</b> , type the error code, and then click <b>Look it up</b> .
<b>Set home</b>	Select the default information to be displayed on the <b>Home</b> screen. See View menu section for the options and option items that can be set as the default on the <b>Home</b> screen.

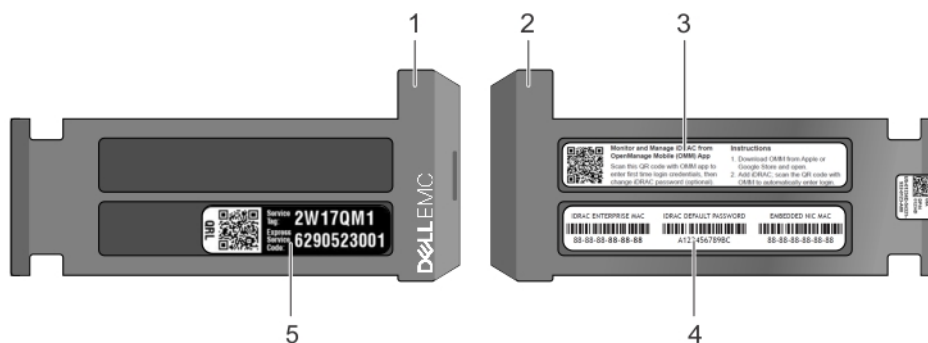
## View menu

**NOTE:** When you select an option in the **View** menu, you must confirm the option before proceeding to the next action.

Option	Description
<b>iDRAC IP</b>	Displays the <b>IPv4</b> or <b>IPv6</b> addresses for iDRAC9. Addresses include <b>DNS (Primary and Secondary)</b> , <b>Gateway, IP</b> , and <b>Subnet</b> (IPv6 does not have Subnet).
<b>MAC</b>	Displays the MAC addresses for <b>iDRAC</b> , <b>iSCSI</b> , or <b>Network</b> devices.
<b>Name</b>	Displays the name of the <b>Host</b> , <b>Model</b> , or <b>User String</b> for the system.
<b>Number</b>	Displays the <b>Asset tag</b> or the <b>Service tag</b> for the system.
<b>Power</b>	Displays the power output of the system in BTU/hr or Watts. The display format can be configured in the <b>Set home</b> submenu of the <b>Setup</b> menu.
<b>Temperature</b>	Displays the temperature of the system in Celsius or Fahrenheit. The display format can be configured in the <b>Set home</b> submenu of the <b>Setup</b> menu.

## Locating the Service Tag of your system

You can identify your system using the unique Express Service Code and Service Tag. Pull out the information tag in front of the system to view the Express Service Code and Service Tag. Alternatively, the information may be on a sticker on the chassis of the system. The mini Enterprise Service Tag (EST) is found on the back of the system. Dell uses this information to route support calls to the appropriate personnel.



**Figure 16. Locating Service Tag of your system**

1. information tag (front view)
2. information tag (back view)
3. OpenManage Mobile (OMM) label
4. iDRAC MAC address and iDRAC secure password label
5. Service Tag



# System information label

## Service Information

### System Touchpoints

- Hot swap touchpoints: Components with terracotta touchpoints can be serviced while the system is running.
- Cold swap touchpoints: Components with blue touchpoints require a full system shutdown before servicing.

### Electrical Overview

#### System Board Connections

1 System Power	15 TPM	26 Fan 6
2 SATA_C	16 PCIe Card Slot 4 (CPU 2)	27 DIMMs For CPU 1 Channels 0, 1, 2
3 SATA_B	17 LOM Riser Card	28 CPU 1
4 PIB Signal 1	18 Backplane Signal 2 (Rear)	29 DIMMs For CPU 1 Channels 3, 4, 5
5 PIB Signal 2	19 PCIe Internal Storage (CPU 1)	30 Fan 5
6 SATA_A	20 Riser 1 (CPU 1)	31 Fan 4
7 IDSDM + vFlash	21 DIMMs For CPU 2 Channels 0, 1, 2	32 CPU 1 Power
8 Front USB	22 CPU 2	33 Intrusion Switch
9 ODD/Rear Backplane Power	23 DIMMs For CPU 2 Channels 3, 4, 5	34 Fan 3
10 VGA	24 Slimline (PCIe_A0)	35 Fan 2
11 Internal USB 3.0	25 CPU 2 Power	36 Backplane Signal 1
12 PCIe Card Slot 6 (PCH)		37 Left Control Panel
13 Jumpers		38 Right Control Panel
14 PCIe Card Slot 5 (CPU 1)		

---

### Mechanical Overview

#### Top View

Hard Drives Fans Power Supplies\*  
PCIe Cards\*\*  
CPUs  
DIMMs

#### Rear View

Serial iDRAC USBs PCIe Card Slots\*\* Power Supplies\*  
System ID CMA Jack VGA NICs

#### HDD Drives

HDD Drives Power Supplies\*  
PCI Card Slots\*\*

#### HDD Drives

HDD Drives Power Supply\*  
PCI Card Slot\*\*

\*Your system may be configured with either hot- or cold-swap components. Follow the corresponding instructions.

\*\*Your system may be configured with Riser or non-Riser in PCIe Card Slots. Follow the corresponding instructions.

### Jumper Settings

Jumper	Setting	Description
PWRD_EN	(default)	BIOS password is enabled.
↓		BIOS password is disabled. iDRAC local access is unlocked at next AC power cycle. iDRAC password reset is enabled in F2 iDRAC settings menu.
NVRAM_CLR	(default)	BIOS configuration settings retained at system boot.
↓		BIOS configuration settings cleared at system boot.

Figure 17. PowerEdge R540 – Service information

Dell EMC PowerEdge R540 overview 25

## Memory Information

**⚠ Caution:** Memory (DIMMs) and CPUs may be hot during servicing

**Memory Population Configuration**

Configuration	Sequence
Memory-Optimized	C1{1}, C2{1}, C1{2}, C2{2}, C1{3}, C2{3}
Mirroring	C1{1,2,3,4,5,6}, C2{1,2,3,4,5,6}

Memory Sparring details are documented in the *Installation and Service Manual*.

Scan to see hardware servicing and software setup videos, how-to's, and documentation.

**Quick Resource Locator**  
Dell.com/QRL/Server/PER540

### Icon Legend

EST Express Service Tag	Hard Drive Activity
Memory Bank	Mgmt Port
Power Supply	Push
System Status	Fan
System Info	CPU

Figure 18. Memory information

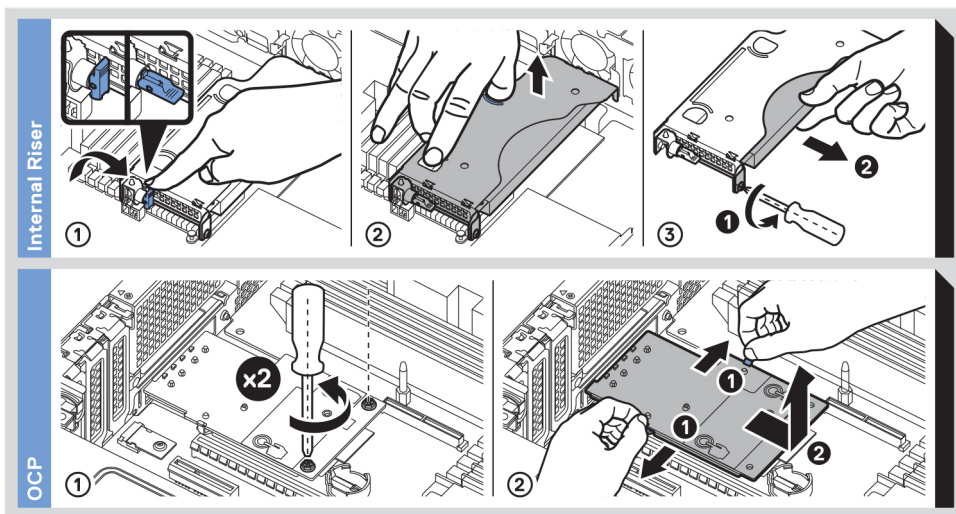


Figure 19. OCP and internal PERC riser installation

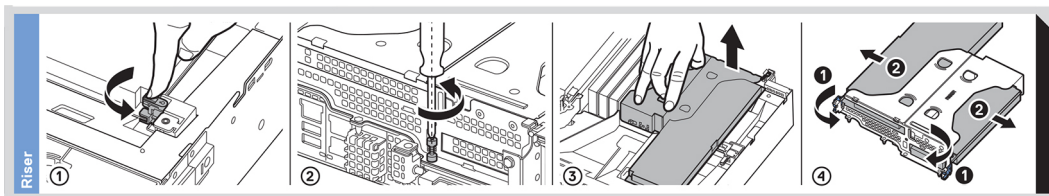


Figure 20. Riser installation

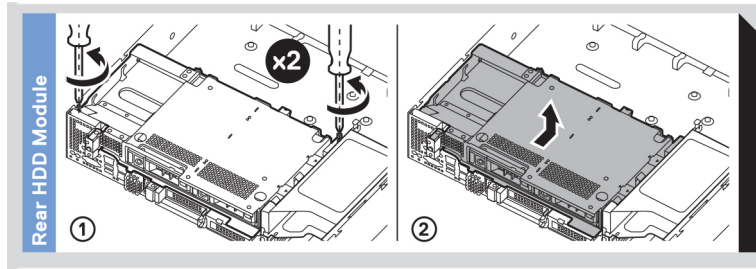


Figure 21. Rear drive installation

# Initial system setup and configuration

## Topics:

- [Setting up your system](#)
- [iDRAC configuration](#)
- [Options to install the operating system](#)

## Setting up your system

Perform the following steps to set up your system:

### Steps

1. Unpack the system.
2. Install the system into the rack. For more information about installing the system into the rack, see the *Rail Installation Guide* at [www.dell.com/poweredgemanuals](http://www.dell.com/poweredgemanuals).
3. Connect the peripherals to the system.
4. Connect the system to its electrical outlet.
5. Power on the system by pressing the power button or by using iDRAC.
6. Power on the attached peripherals.

For more information about setting up your system, see the *Getting Started Guide* that shipped with your system.


For information on how to manage basic settings and features of the system, see the Dell EMC PowerEdge R540 BIOS and UEFI Reference Guide on the product documentation page.

## iDRAC configuration

The Integrated Dell Remote Access Controller (iDRAC) is designed to make system administrators more productive and improve the overall availability of Dell systems. iDRAC alerts administrators about system issues and enables them to perform remote system management. This reduces the need for physical access to the system.

## Options to set up iDRAC IP address

To enable communication between your system and iDRAC, you must first configure the network settings based on your network infrastructure.

 **NOTE:** For static IP configuration, you must request for it at the time of purchase.

This option is set to **DHCP** by Default. You can set up the IP address by using one of the following interfaces:

Interfaces	Document/Section
<b>iDRAC Settings utility</b>	<i>Dell Integrated Dell Remote Access Controller User's Guide</i> at <a href="http://www.dell.com/poweredgemanuals">www.dell.com/poweredgemanuals</a>
<b>Dell Deployment Toolkit</b>	<i>Dell Deployment Toolkit User's Guide</i> at <a href="http://www.dell.com/openmanagemanuals">www.dell.com/openmanagemanuals</a> > OpenManage Deployment Toolkit
<b>Dell Lifecycle Controller</b>	<i>Dell Lifecycle Controller User's Guide</i> at <a href="http://www.dell.com/poweredgemanuals">www.dell.com/poweredgemanuals</a>
<b>Server LCD panel</b>	<a href="#">LCD panel</a> section

## Interfaces Document/Section

**iDRAC Direct and Quick Sync 2 (optional)** See *Dell Integrated Dell Remote Access Controller User's Guide* at [www.dell.com/poweredge/manuals](http://www.dell.com/poweredge/manuals)

**NOTE:** To access iDRAC, ensure that you connect the ethernet cable to the iDRAC9 dedicated network port. You can also access iDRAC through the shared LOM mode, if you have opted for a system that has the shared LOM mode enabled.

## Log in to iDRAC

You can log in to iDRAC as:

- iDRAC user
- Microsoft Active Directory user
- Lightweight Directory Access Protocol (LDAP) user

If you have opted for secure default access to iDRAC, you must use the iDRAC secure default password available on the system Information tag. If you have not opted for secure default access to iDRAC, then use the default user name and password `-root` and `calvin`. You can also log in by using your Single Sign-On or Smart Card.

**NOTE:** You must have the iDRAC credentials to log in to iDRAC.

**NOTE:** Ensure that you change the default username and password after setting up the iDRAC IP address.

For more information about logging in to the iDRAC and iDRAC licenses, see the latest *Integrated Dell Remote Access Controller User's Guide* at [www.dell.com/poweredge/manuals](http://www.dell.com/poweredge/manuals).

You can also access iDRAC by using RACADM. For more information, see the *RACADM Command Line Interface Reference Guide* at [www.dell.com/poweredge/manuals](http://www.dell.com/poweredge/manuals).

## Options to install the operating system

If the system is shipped without an operating system, install a supported operating system by using one of the following resources:

**Table 17. Resources to install the operating system**

Resources	Location
iDRAC	<a href="http://www.dell.com/idracmanuals">www.dell.com/idracmanuals</a>
Lifecycle Controller	<a href="http://www.dell.com/idracmanuals">www.dell.com/idracmanuals</a> > Lifecycle Controller
OpenManage Deployment Toolkit	<a href="http://www.dell.com/openmanagemanuals">www.dell.com/openmanagemanuals</a> > OpenManage Deployment Toolkit
Dell certified VMware ESXi	<a href="http://www.dell.com/virtualizationsolutions">www.dell.com/virtualizationsolutions</a>
Installation and How-to videos for supported operating systems on PowerEdge systems	<a href="#">Supported Operating Systems for Dell EMC PowerEdge systems</a>

## Methods to download firmware and drivers

You can download the firmware and drivers by using any of the following methods:

**Table 18. Firmware and drivers**

Methods	Location
From the Dell EMC support site	<a href="http://www.dell.com/support/home">www.dell.com/support/home</a>
Using Dell Remote Access Controller Lifecycle Controller (iDRAC with LC)	<a href="http://www.dell.com/idracmanuals">www.dell.com/idracmanuals</a>

**Table 18. Firmware and drivers (continued)**

<b>Methods</b>	<b>Location</b>
Using Dell Repository Manager (DRM)	<a href="http://www.dell.com/openmanagemanuals">www.dell.com/openmanagemanuals</a> > Repository Manager
Using Dell OpenManage Essentials	<a href="http://www.dell.com/openmanagemanuals">www.dell.com/openmanagemanuals</a> > OpenManage Essentials
Using Dell OpenManage Enterprise	<a href="http://www.dell.com/openmanagemanuals">www.dell.com/openmanagemanuals</a> > OpenManage Enterprise
Using Dell Server Update Utility (SUU)	<a href="http://www.dell.com/openmanagemanuals">www.dell.com/openmanagemanuals</a> > Server Update Utility
Using Dell OpenManage Deployment Toolkit (DTK)	<a href="http://www.dell.com/openmanagemanuals">www.dell.com/openmanagemanuals</a> > OpenManage Deployment Toolkit
Using iDRAC virtual media	<a href="http://www.dell.com/idracmanuals">www.dell.com/idracmanuals</a>


## Downloading drivers and firmware

Dell EMC recommends that you download and install the latest BIOS, drivers, and systems management firmware on your system.

### Prerequisites

Ensure that you clear the web browser cache before downloading the drivers and firmware.

### Steps


1. Go to [www.dell.com/support/home](http://www.dell.com/support/home).
2. In the **Drivers & Downloads** section, type the Service Tag of your system in the **Enter a Service Tag or product ID** box, and then click **Submit**.  
 **NOTE:** If you do not have the Service Tag, select **Detect Product** to allow the system to automatically detect the Service Tag, or click **View products**, and navigate to your product.
3. Click **Drivers & Downloads**.  
The drivers that are applicable to your system are displayed.
4. Download the drivers to a USB drive, CD, or DVD.

# Installing and removing system components

## Topics:


- Safety instructions
- Before working inside your system
- After working inside your system
- Recommended tools
- Optional front bezel
- System cover
- Backplane cover
- Inside the system
- Air shroud
- Cooling fans
- Internal PERC riser
- Intrusion switch
- Drives
- System memory
- Processors and heat sinks
- Expansion cards and expansion card risers
- M.2 SSD module
- Optional MicroSD or vFlash card
- Optional IDSDM or vFlash module
- LOM riser card
- Drive backplane
- Cable routing
- Rear drive cage
- System battery
- Optional internal USB memory key
- Optical drive (optional)
- Power supply units
- Power interposer board
- Control panel
- System board
- Restoring the system using Easy Restore
- Entering the system Service Tag by using System Setup
- Trusted Platform Module

## Safety instructions

 **NOTE:** Whenever you need to lift the system, get others to assist you. To avoid injury, do not attempt to lift the system by yourself.

 **WARNING:** Opening or removing the system cover while the system is powered on may expose you to a risk of electric shock.

 **CAUTION:** Do not operate the system without the cover for a duration exceeding five minutes. Operating the system without the system cover can result in component damage.

 **CAUTION:** Many repairs may only be done by a certified service technician. You should only perform troubleshooting and simple repairs as authorized in your product documentation, or as directed by the online or

telephone service and support team. Damage due to servicing that is not authorized by Dell is not covered by your warranty. Read and follow the safety instructions that are shipped with your product.

**i** **NOTE:** It is recommended that you always use an antistatic mat and antistatic strap while working on components inside the system.

**△** **CAUTION:** To ensure proper operation and cooling, all bays in the system and system fans must be always populated with a component or a blank.

## Before working inside your system

### Prerequisites

Follow the safety guidelines listed in [Safety instructions](#).

### Steps

1. Turn off the system, including all attached peripherals.
2. Disconnect the system from the electrical outlet and disconnect the peripherals.

## After working inside your system

### Prerequisites

Follow the safety guidelines listed in [Safety instructions](#).

### Steps

1. Reconnect the peripherals and connect the system to the electrical outlet.
2. Turn on the attached peripherals and then turn on the system.

## Recommended tools

You need the following tools to perform the removal and installation procedures:

- Key to the bezel lock  
The key is required only if your system includes a bezel.
- Phillips #1 screwdriver
- Phillips #2 screwdriver
- Torx #T30 screwdriver
- Torx #T8 screwdriver
- Wrist grounding strap

You need the following tools to assemble the cables for a DC power supply unit:

- AMP 90871-1 hand-crimping tool or equivalent
- Tyco Electronics 58433-3 or equivalent
- Wire-stripper pliers to remove insulation from size 10 AWG solid or stranded, insulated copper wire

**i** **NOTE:** Use alpha wire part number 3080 or equivalent (65/30 stranding).

## Optional front bezel

**i** **NOTE:** The procedure to remove the front bezel with and without the LCD panel is the same.



## Removing the front bezel

### Prerequisites

Follow the safety guidelines listed in [Safety instructions](#).

### Steps

1. Unlock the bezel by using the bezel key.
2. Press the release button, and pull the left end of the bezel.
3. Unhook the right end, and remove the bezel.

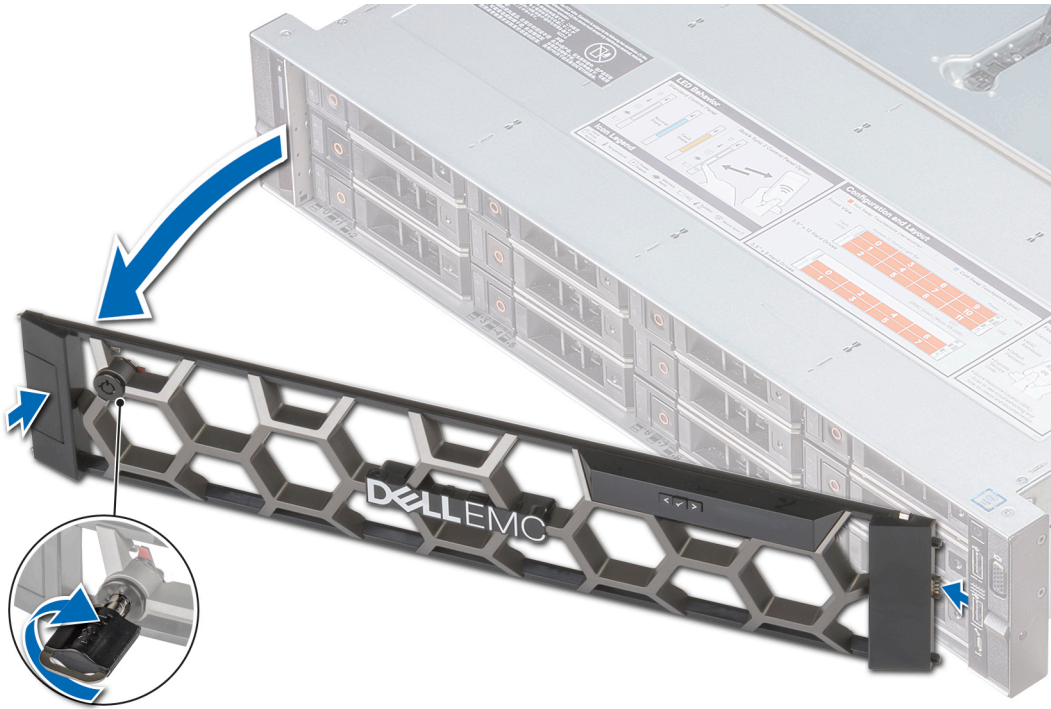


Figure 22. Removing the front bezel with the LCD panel

## Installing the front bezel

### Prerequisites

Follow the safety guidelines listed in [Safety instructions](#).

### Steps

1. Locate and remove the bezel key.
  - NOTE:** The bezel key is part of the LCD bezel package.
2. Align and insert the right end of the bezel onto the system.
3. Press the bezel until the button clicks in place and fit the left end of the bezel onto the system.
4. Lock the bezel by using the key.

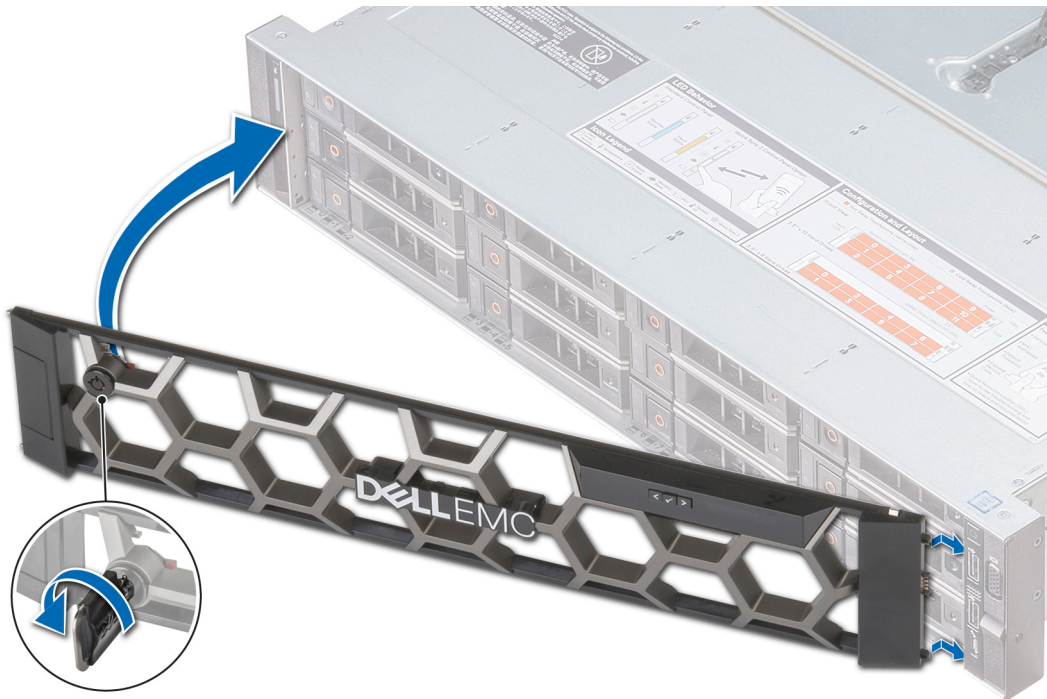


Figure 23. Installing the front bezel with the LCD panel

## System cover

**NOTE:** The system cover of 12 x 3.5-inch + 2 x 3.5-inch (rear) system is different from other systems. The cover has one additional mylar and foam layer on the front side of the system cover.

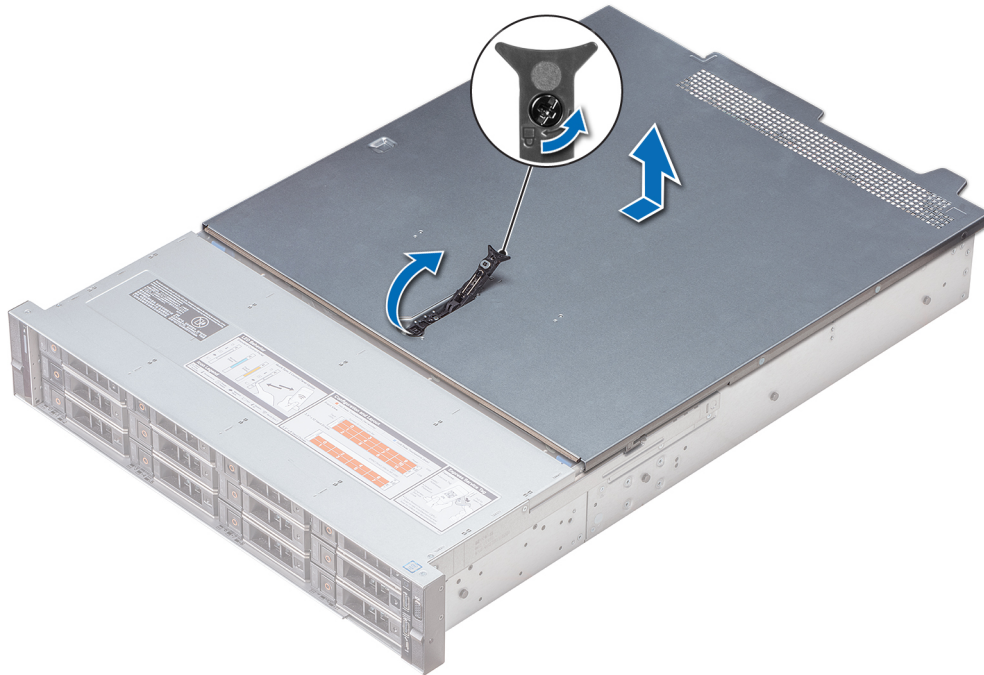
## Removing the system cover

### Prerequisites

1. Follow the safety guidelines listed in [Safety instructions](#).
2. Turn off the system, including any attached peripherals.
3. Disconnect the system from the electrical outlet and disconnect the peripherals.

### Steps

1. Using a 1/4 inch flat head or a Phillips #2 screwdriver, rotate the latch release lock counter clockwise to the unlocked position.
2. Lift the latch till the system cover slides back and the tabs on the system cover disengage from the guide slots on the system.
3. Hold the cover on both sides, and lift the cover away from the system.



**Figure 24. Removing the system cover**

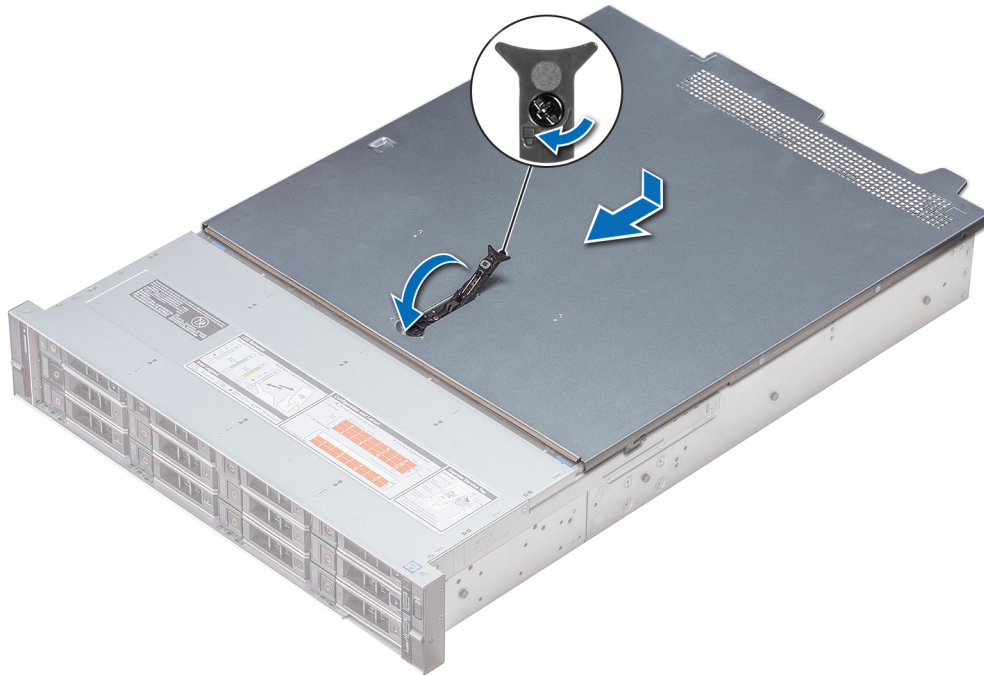
## Installing the system cover

### Prerequisites

1. Follow the safety guidelines listed in [Safety instructions](#).
2. Ensure that all internal cables are routed correctly and connected, and no tools or extra parts are left inside the system.

### Steps

1. Align the tabs on the system cover with the guide slots on the system.
2. Push the system cover latch down.  
The system cover slides forward, the tabs on the system cover engage with the guide slots on the system and the system cover latch locks into place.
3. Using a 1/4 inch flat head or Phillips #2 screwdriver, rotate the latch release lock clockwise to the locked position.



**Figure 25. Installing system cover**

#### **Next steps**

1. Reconnect the peripherals and connect the system to the electrical outlet.
2. Turn on the system, including any attached peripherals.

## **Backplane cover**

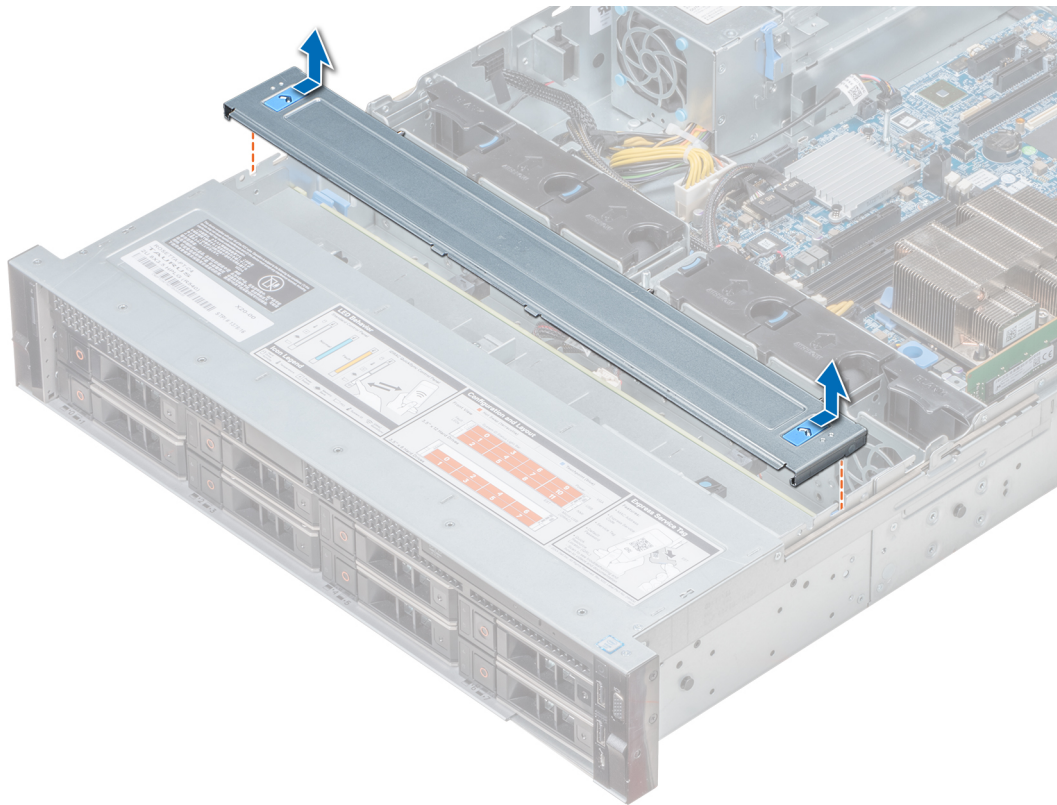
### **Removing the backplane cover**

#### **Prerequisites**

1. Follow the safety guidelines listed in [Safety instructions](#).
2. Follow the procedure listed in [Before working inside your system](#).
3. [Removing the system cover](#).

#### **Steps**

1. Slide the backplane cover in the direction of the arrows marked on the backplane cover.
2. Lift the backplane cover away from the system.



**Figure 26. Removing backplane cover**

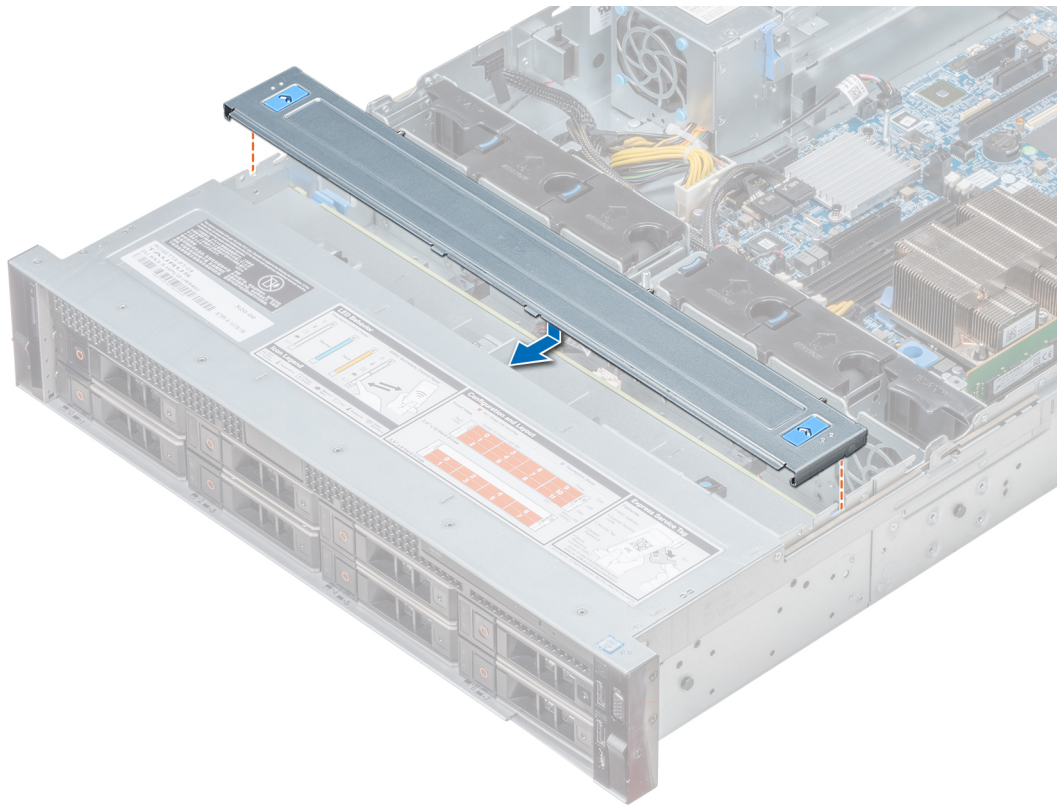
## Installing the backplane cover

### Prerequisites

1. Follow the safety guidelines listed in [Safety instructions](#).
2. Follow the procedure listed in [Before working inside your system](#).
3. [Installing the system cover](#).

### Steps

1. Align the tabs on the backplane cover with the guide slots on the system.
2. Slide the backplane cover toward the front of the system until the cover locks into place.



**Figure 27. Installing backplane cover**

### **Next steps**

Follow the procedure listed in [After working inside your system.](#)

## **Inside the system**

**NOTE:** Components that are hot swappable are marked orange and touch points on the components are marked blue.

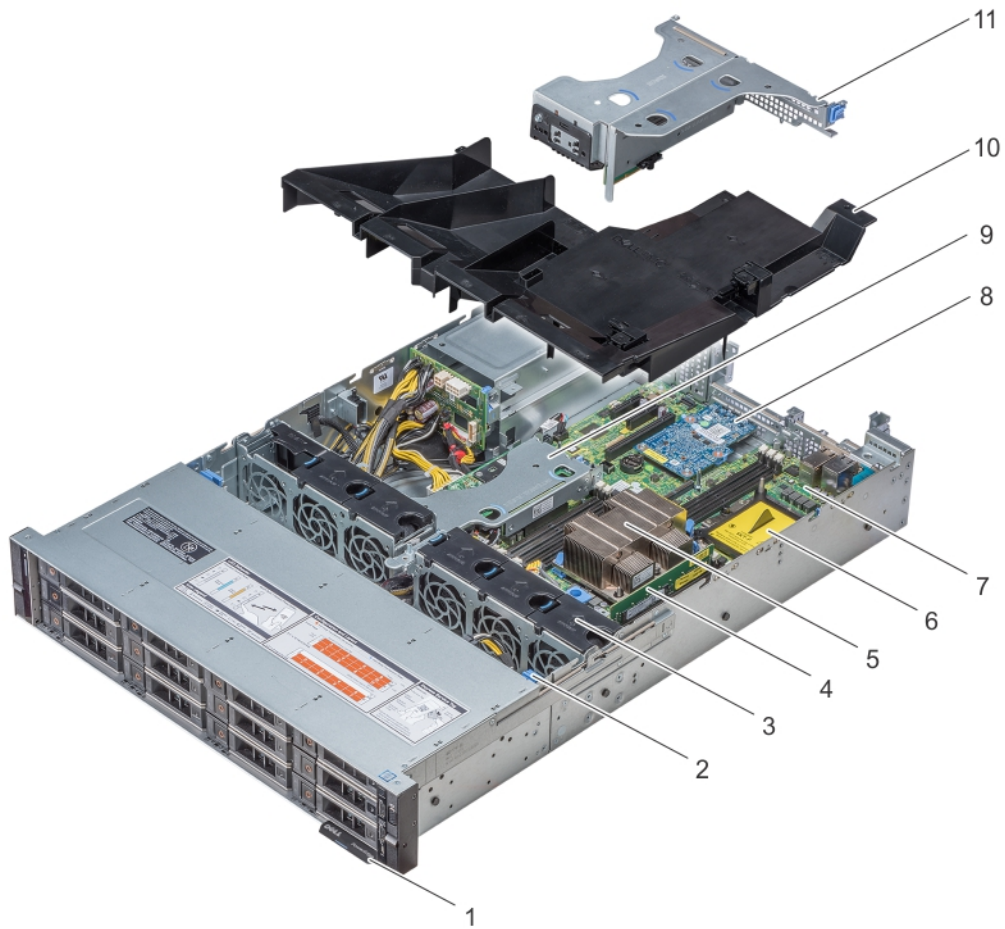
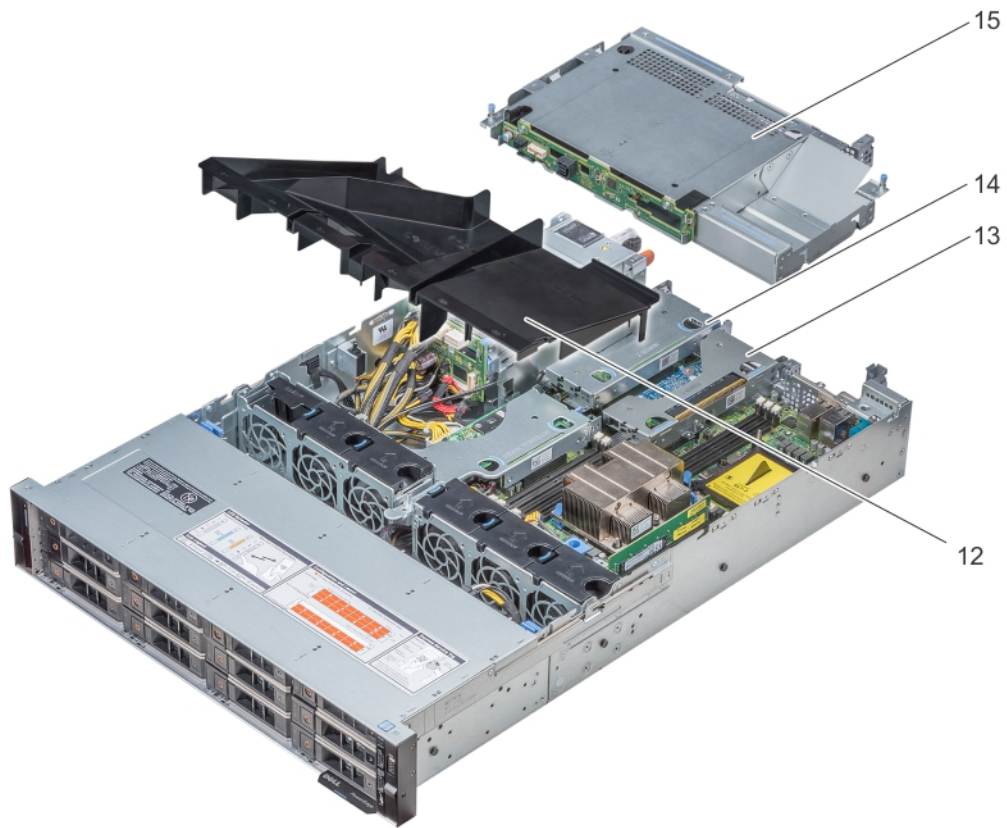


Figure 28. Inside the system without rear drive cage



**Figure 29. Inside the system with rear drive cage**

- |                             |  |
|-----------------------------|--|
| 1. Information tag          | 2. Drive backplane   |
| 3. Cooling fans             | 4. Memory module   |
| 5. CPU 1                    | 6. CPU 2   |
| 7. System board             | 8. LOM riser card  |
| 9. Internal PERC riser      | 10. Air shroud   |
| 11. Butterfly riser         | 12. Air shroud (12 x 3.5 inch + 2 x 3.5 inch rear hard drive system) |
| 13. Low profile riser right | 14. Low profile riser left   |
| 15. Drive cage (rear)       |  |



# Air shroud

## Removing the air shroud

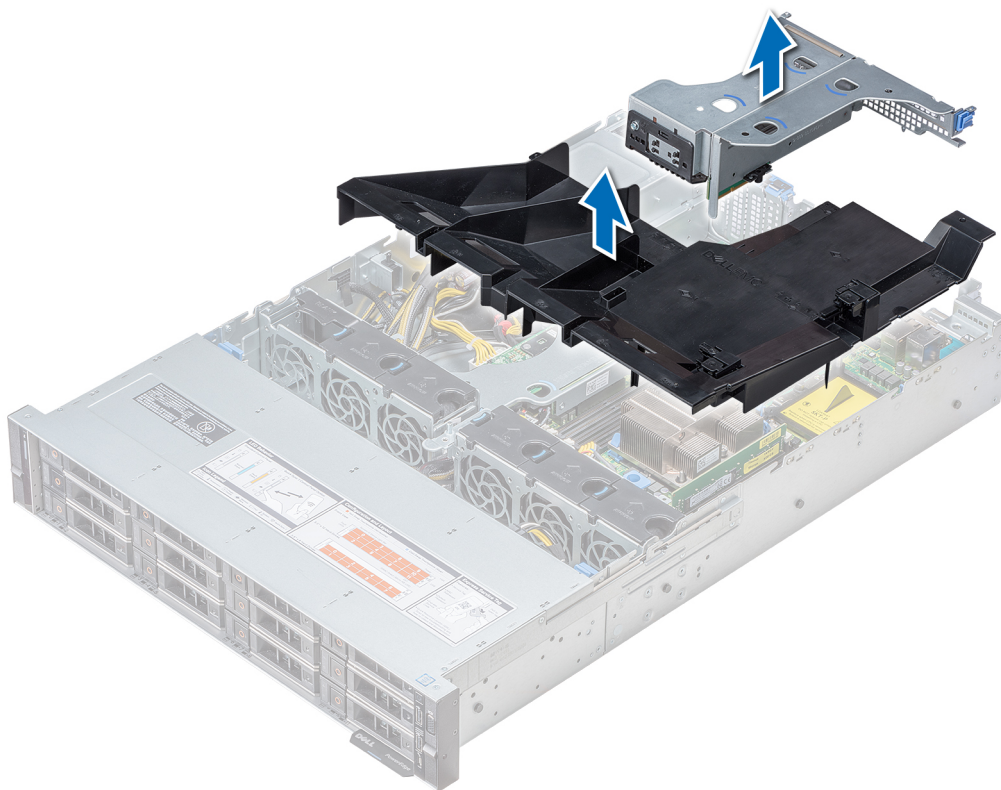
### Prerequisites

**CAUTION:** Never operate your system with the air shroud removed. The system may get overheated quickly, resulting in shutdown of the system and loss of data.

1. Follow the safety guidelines listed in [Safety instructions](#).
2. Follow the procedure listed in [Before working inside your system](#).
3. If installed, [remove the butterfly riser](#).

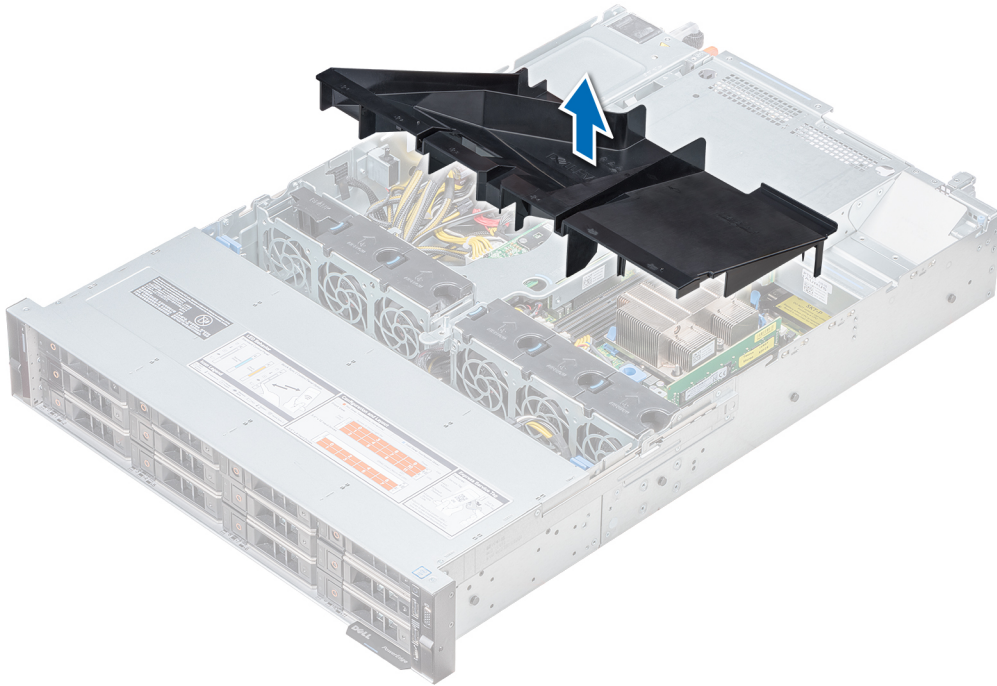
### Steps

Hold the air shroud at both ends and lift it away from the system.



**Figure 30. Removing air shroud**

**NOTE:** The system with 2 x 3.5-inch rear drive has a different air shroud. However, the procedure to remove the air shroud is identical.



### Next steps

1. If applicable, [Installing the air shroud](#)
2. Follow the procedure listed in [After working inside your system.](#)

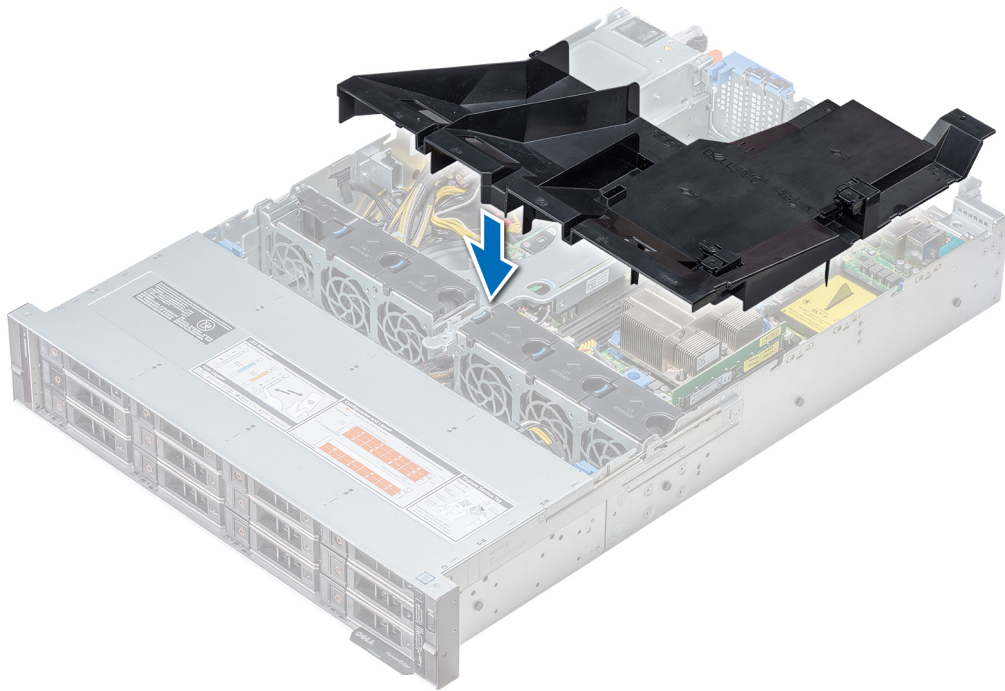
## Installing the air shroud

### Prerequisites

1. Follow the safety guidelines listed in [Safety instructions.](#)
2. Follow the procedure listed in [Before working inside your system.](#)
3. If applicable, route the cables inside the system along the system wall and secure the cables by using the cable latch.

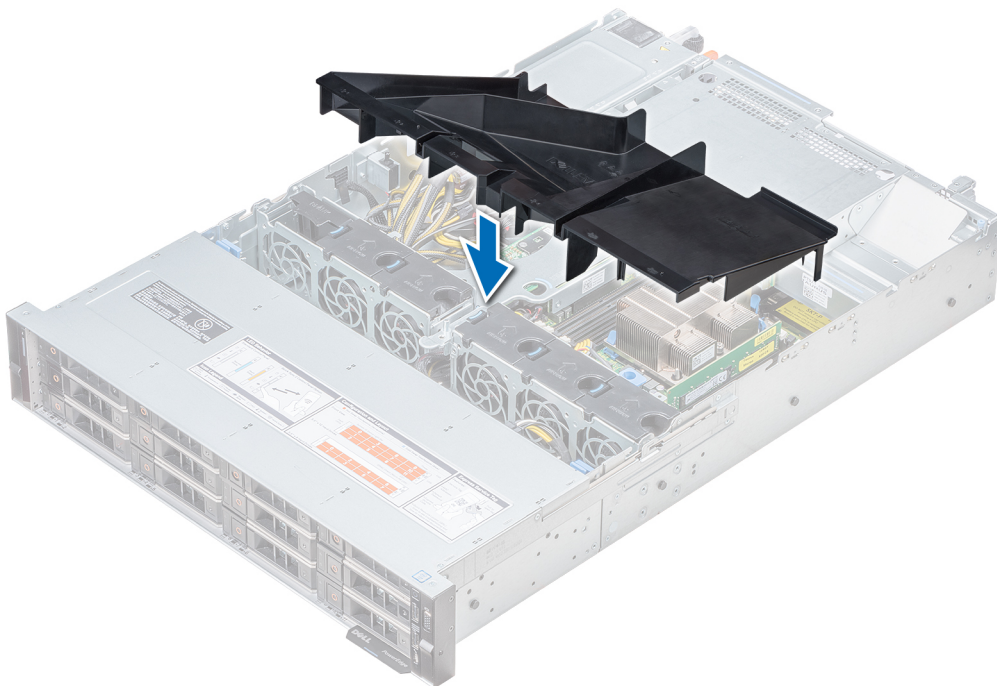
### Steps

1. Align the tabs on the air shroud with the slots on the system.
2. Lower the air shroud into the system until it is firmly seated.  
When firmly seated, the memory socket numbers marked on the air shroud align with the respective memory sockets.



**Figure 31. Installing air shroud**

**NOTE:** The procedure to install the air shroud for 2 x 3.5-inch rear drive system is identical.



**Next steps**

1. If removed, [install the butterfly riser](#).

2. Follow the procedure listed in [After working inside your system](#).

## Cooling fans

### Removing the cooling fan


The procedure for removing standard and high performance fans are identical.

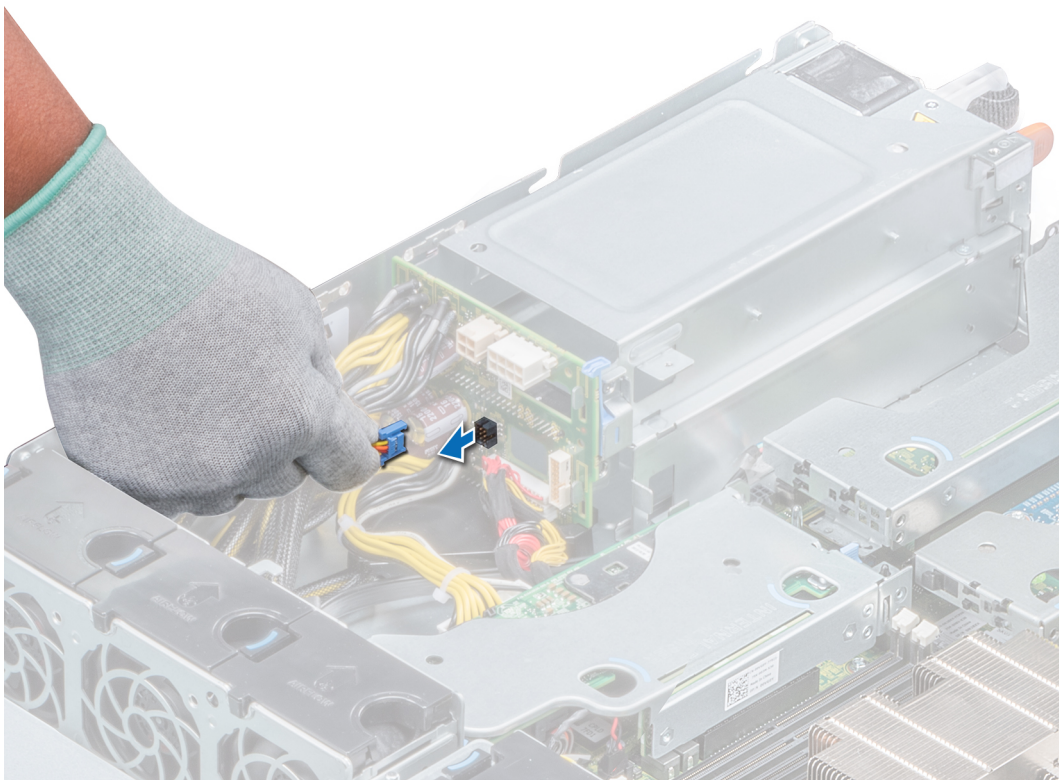
#### Prerequisites

1. Follow the safety guidelines listed in [Safety instructions](#).
2. Follow the procedure listed in [Before working inside your system](#).
3. [Removing the air shroud](#)
4. [Removing the internal PERC riser](#)
5. Move the cables out of the way to access the cooling fan cable connector on the system board.

#### Steps

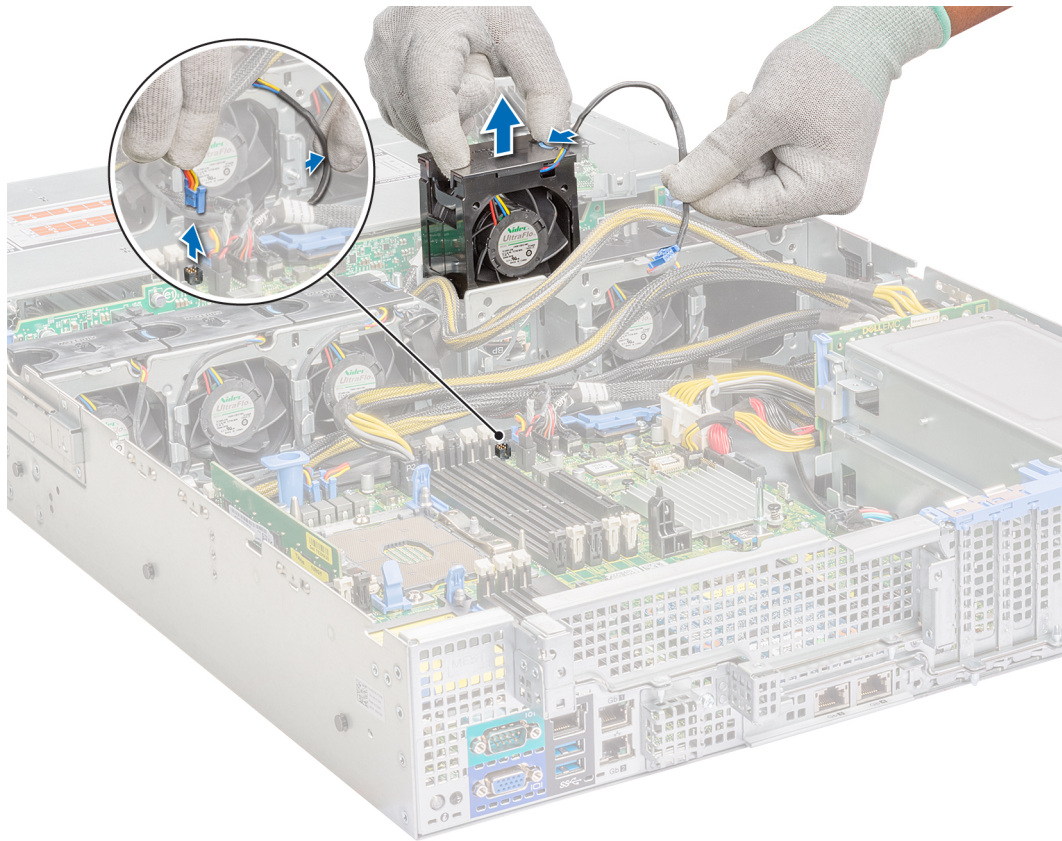
1. Lift the fan out holding the blue touch point.
2. Disconnect the cooling fan cable connected to the system board connector.

 **NOTE:** In the 12 x 3.5-inch drive system, disconnect the fan 1 cable from the power interposer board connector.



**Figure 32. Disconnecting fan cable from PIB connector**

3. Press the release tab and lift the cooling fan out of the cooling fan cage.



**Figure 33. Removing cooling fan**

#### **Next steps**

1. [Installing cooling fan.](#)
2. [Installing the internal PERC riser](#)
3. [Installing the air shroud](#)
4. Follow the procedure listed in [After working inside your system.](#)

## **Installing cooling fan**

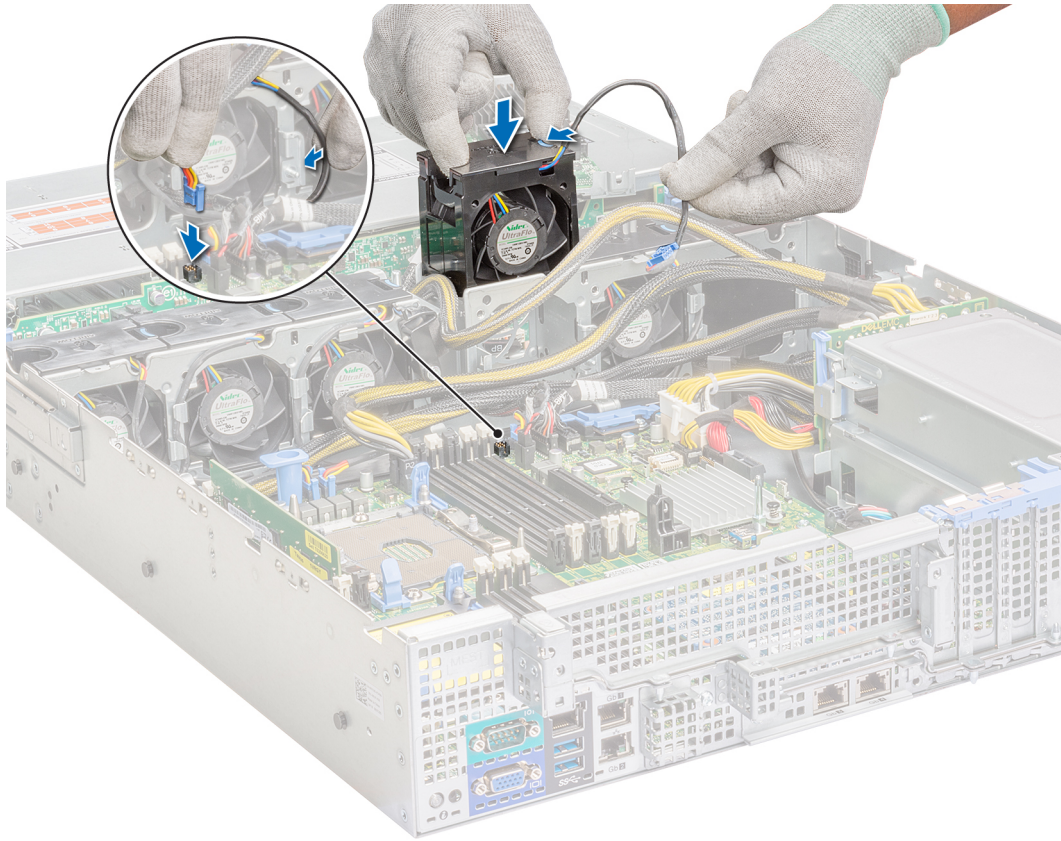
The procedure for installing standard and high performance fans are identical.

#### **Prerequisites**

1. Follow the safety guidelines listed in [Safety instructions.](#)
2. Follow the procedure listed in [Before working inside your system.](#)
3. [Removing the air shroud](#)
4. [Removing the internal PERC riser](#)
5. Remove the power cable.
6. Move the cables out of the way to access the cooling fan cable connector on the system board.

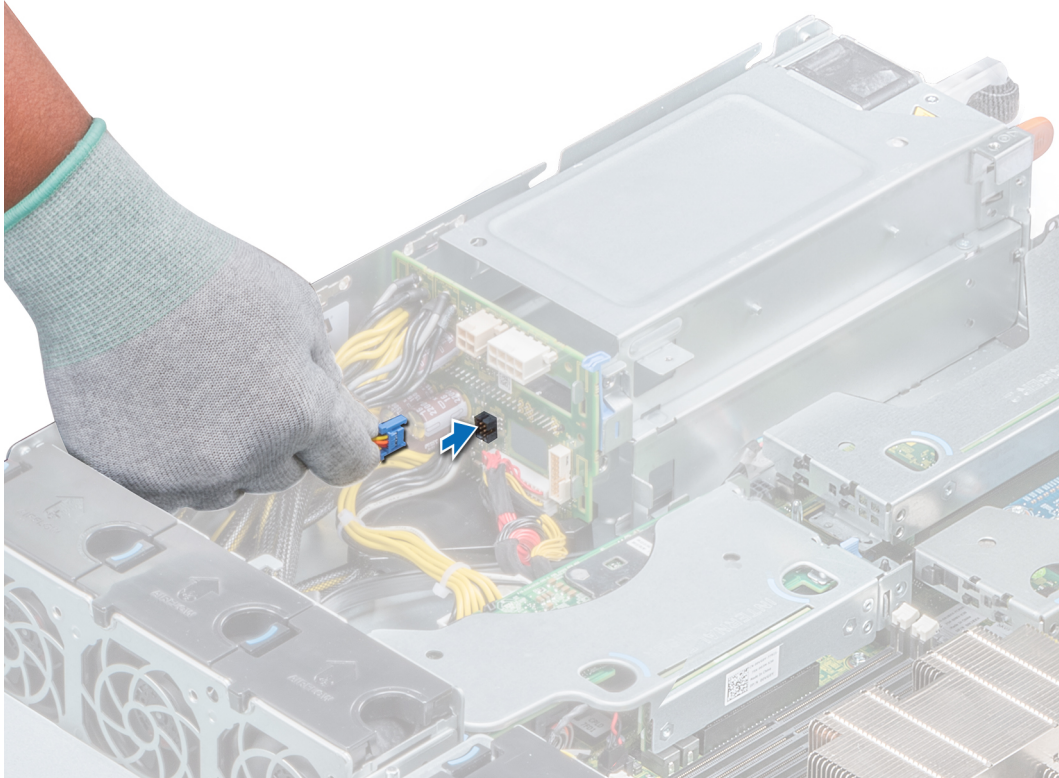
#### **Steps**

1. Holding the release tab blue touch point, place the cooling fan into the cooling fan cage.
2. Route the cooling fan cable and connect it to the connector on the system board.



**Figure 34. Installing cooling fan**

**NOTE:** In the 12 x 3.5-inch drive system, connect the fan 1 cable to the power interposer board connector.



**Figure 35. Connecting fan cable to PIB connector**

#### Next steps

1. [Installing the internal PERC riser](#)
2. Ensure all the cables are routed correctly.
3. [Installing the air shroud](#)
4. Follow the procedure listed in [After working inside your system](#).

## Internal PERC riser

### Removing the internal PERC riser

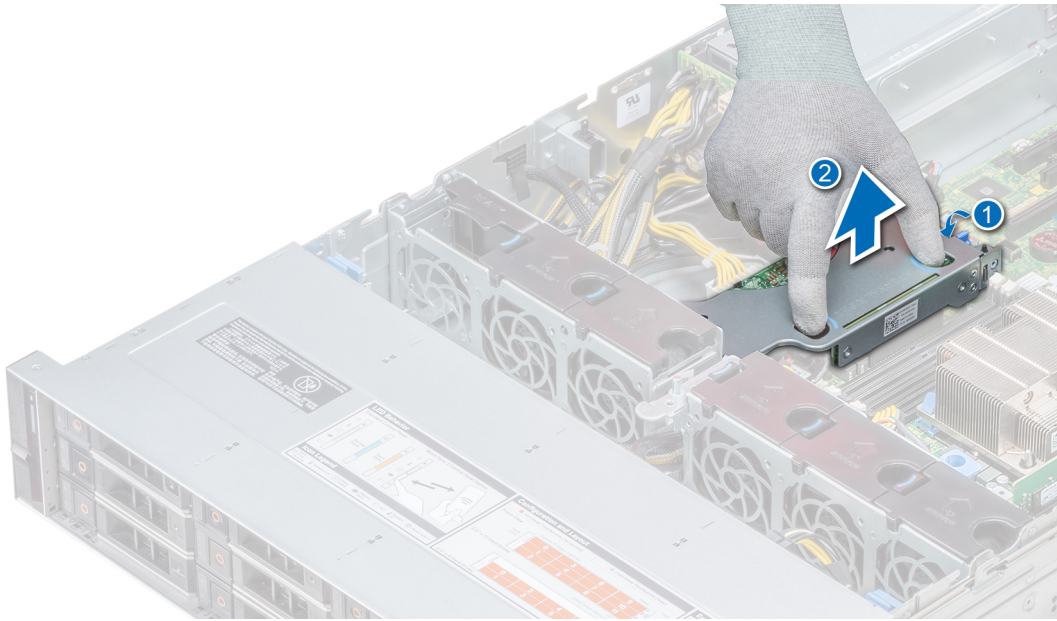
**NOTE:** The new generation PERC 11 H750, H350, and HBA350i adapters cannot be mixed with the PERC H740P, H730P, H330, HBA330 adapters of the previous generations in one system. For more information, see [Cable routing](#).

#### Prerequisites

1. Follow the safety guidelines listed in [Safety instructions](#).
2. Follow the procedure listed in [Before working inside your system](#).
3. [Removing the air shroud](#).

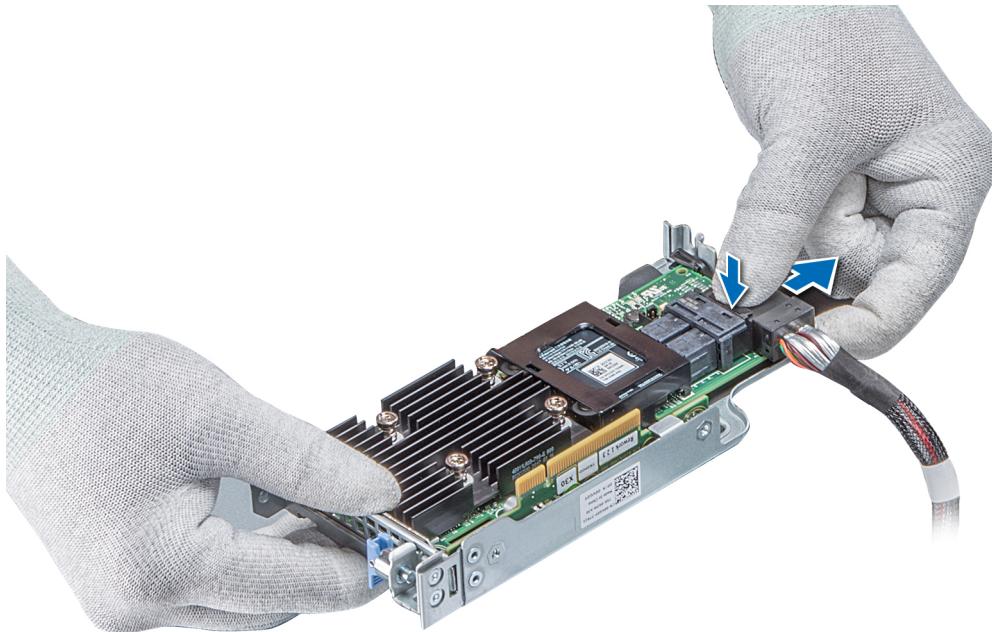
#### Steps

1. Open the cable guiding latch for easy access.
2. Lower the plunger.
3. Press the cable connector and disconnect the PERC cable from the backplane.
4. Hold the blue touch points and lift the internal PERC riser out of the system.



**Figure 36. Removing internal PERC riser**

5. Turn the internal riser so that the PERC card is facing up.
6. Press the cable connector and disconnect the cable connected to the internal PERC card.



**Figure 37. Disconnecting the cable from internal PERC card**

#### **Next steps**

1. [Installing the air shroud](#)
2. Follow the procedure listed in [After working inside your system.](#)
3. [Installing the internal PERC riser](#)



## Installing the internal PERC riser

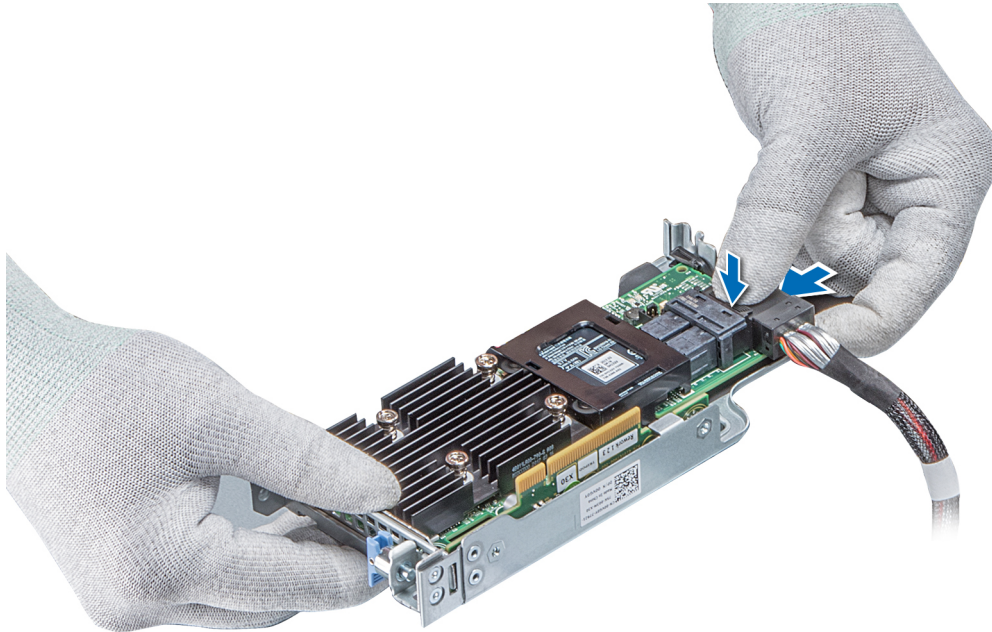
**NOTE:** The new generation PERC 11 H750, H350, and HBA350i adapters cannot be mixed with the PERC H740P, H730P, H330, HBA330 adapters of the previous generations in one system. For more information, see [Cable routing](#).

### Prerequisites

Follow the safety guidelines listed in [Safety instructions](#).

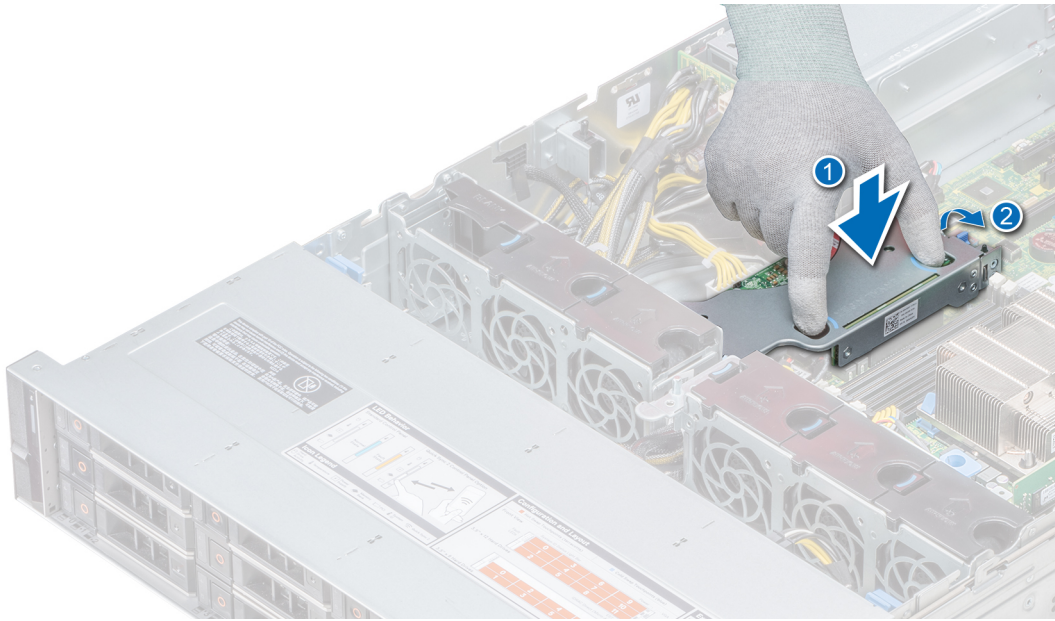
### Steps

1. Connect the cable to the internal PERC card.



**Figure 38. Connecting the cable to internal PERC riser**

2. Holding the blue touch points, align the slot on the internal PERC riser to the guide on the system board.
3. Insert the internal riser card's edge connector firmly into the system board connector until the riser is fully seated.
4. Lift the plunger to lock the riser in place.



**Figure 39. Installing internal PERC riser**

5. Connect the cables to the backplane and then route the cables to the cable guiding latch to close the latch.

#### **Next steps**

1. [Installing the air shroud](#)
2. Follow the procedure listed in [After working inside your system.](#)

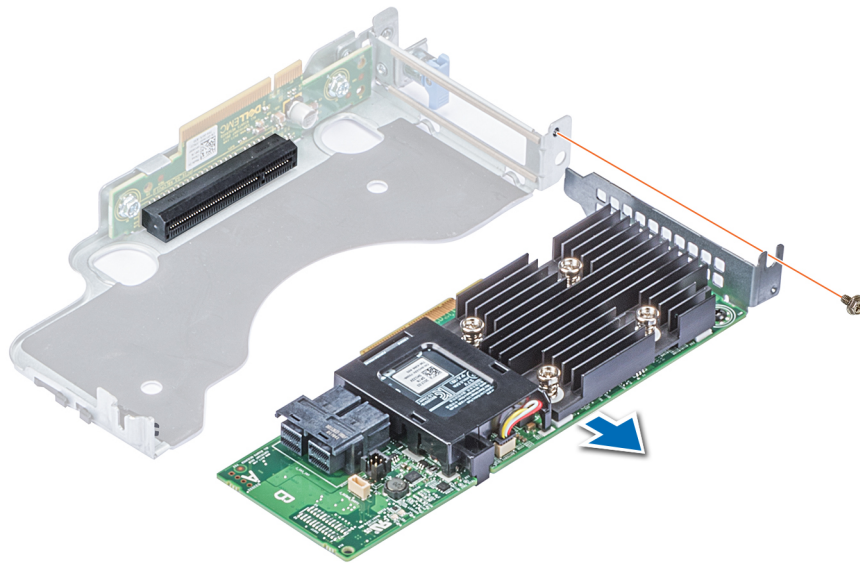
## **Removing the PERC card from the internal PERC riser**

#### **Prerequisites**

1. Follow the safety guidelines listed in [Safety instructions.](#)
2. Follow the procedure listed in [Before working inside your system.](#)
3. [Removing the air shroud](#)
4. [Removing the internal PERC riser](#)

#### **Steps**

1. Using a Phillips #2 screwdriver, remove the screw that secures the PERC card to the internal PERC riser.
2. Pull the PERC card out of the connector on the internal PERC riser.



**Figure 40. Removing the PERC card from the internal PERC riser**

#### **Next steps**

1. [Installing the internal PERC riser](#)
2. [Installing the air shroud](#)
3. Follow the procedure listed in [After working inside your system.](#)

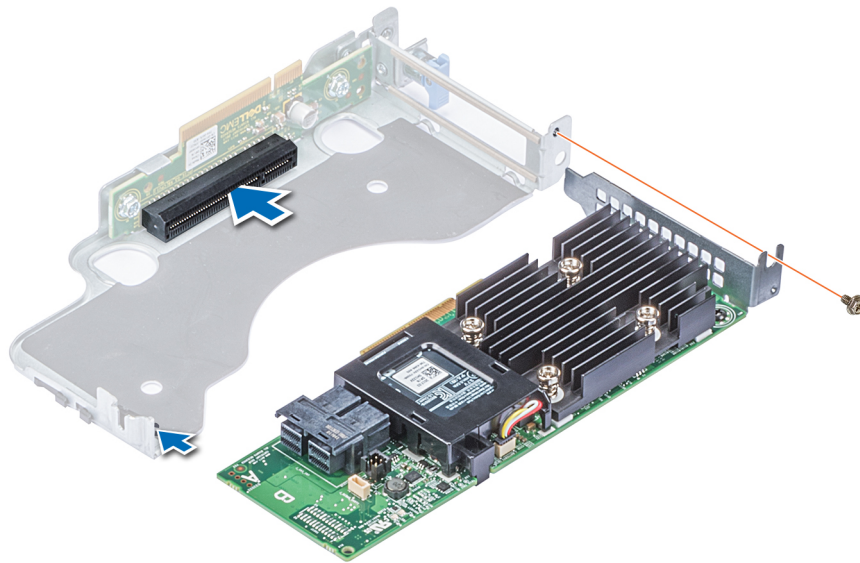
## **Installing PERC card into the internal PERC riser**

#### **Prerequisites**

1. Follow the safety guidelines listed in [Safety instructions.](#)

#### **Steps**

1. Insert the PERC card into the internal PERC riser and push the card in.
2. Using a Phillips #2 screwdriver, replace the screw to secure the PERC card on the internal PERC riser.



**Figure 41. Installing PERC card into internal PERC riser**

#### Next steps

1. [Installing the internal PERC riser](#)
2. [Installing the air shroud](#)
3. Follow the procedure listed in [After working inside your system.](#)

## Intrusion switch

### Removing the intrusion switch

#### Prerequisites

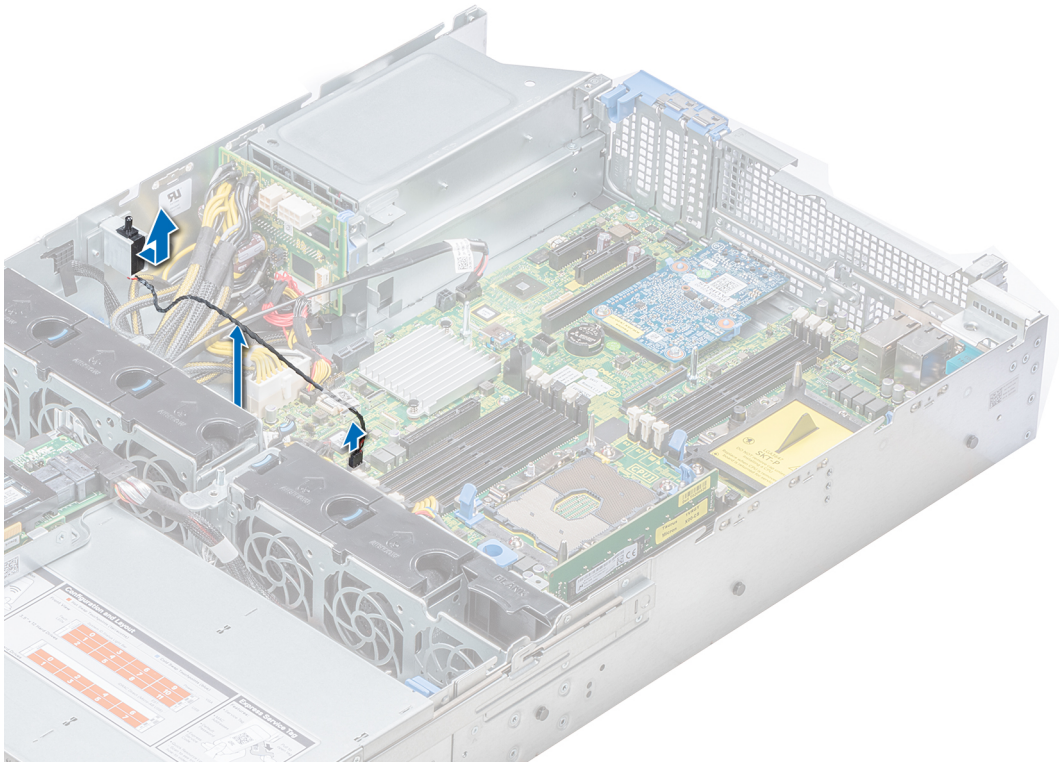
1. Follow the safety guidelines listed in [Safety instructions.](#)
2. Follow the procedure listed in [Before working inside your system.](#)
3. [Removing the air shroud](#)
4. [Removing the internal PERC riser](#)

#### Steps

1. Disconnect the intrusion switch cable connected to the system board.

**NOTE:** Ensure that you note the routing of the cables as you remove them from the system board.

2. Slide the intrusion switch out of the intrusion switch slot.



**Figure 42. Removing an intrusion switch**

### Next steps

Installing the intrusion switch.

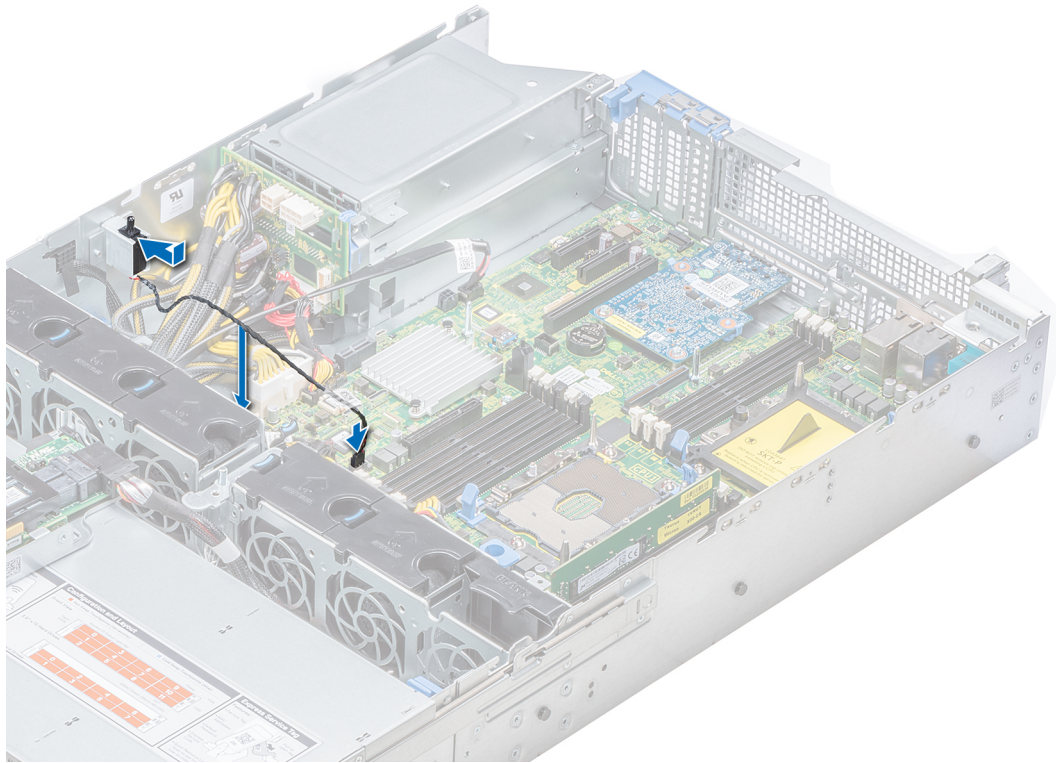
## Installing the intrusion switch

### Prerequisites

1. Follow the safety guidelines listed in [Safety instructions](#).
2. Follow the procedure listed in [Before working inside your system](#).

### Steps

1. Align the intrusion switch with the intrusion switch slot.



**Figure 43. Installing intrusion switch**

2. Slide the intrusion switch until it is firmly seated in the intrusion switch slot.
3. Connect the intrusion switch cable to the connector on the system board.

#### **Next steps**

1. [Installing the internal PERC riser](#)
2. Follow the procedure listed in [After working inside your system](#).

## **Drives**

The PowerEdge R540 system supports:

- Up to 14 x 3.5 inch drives or 2.5 inch drives with drive adapter, internal, hot swappable SAS, SATA, or Nearline SAS drives
- Up to 8 x 3.5 inch drives or 2.5 inch drives with drive adapter, internal, hot swappable SATA SSDs

## **Removing a drive blank**

The procedure for removing 2.5-inch and 3.5-inch drive blanks is identical.

#### **Prerequisites**

1. Follow the safety guidelines listed in [Safety instructions](#).
2. If installed, [Removing the front bezel](#)

**⚠ CAUTION: To maintain proper system cooling, drive blanks must be installed in all empty drive slots.**

**⚠ CAUTION: Mixing drive blanks from previous generations of PowerEdge servers is not supported.**

#### **Steps**

Press the release button, and slide the drive blank out of the drive slot.

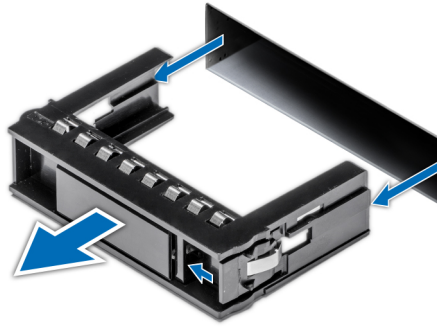


Figure 44. Removing a drive blank

#### Next steps

1. [Installing a drive blank](#)

## Installing a drive blank

The procedure for installing 2.5-inch and 3.5-inch drive blanks is identical.

#### Prerequisites

1. Follow the safety guidelines listed in [Safety instructions](#).
2. If installed, [Removing the front bezel](#)

**CAUTION:** Mixing drive blanks from previous generations of PowerEdge servers is not supported.

#### Steps

Insert the drive blank into the drive slot, and push the blank until the release button clicks into place.

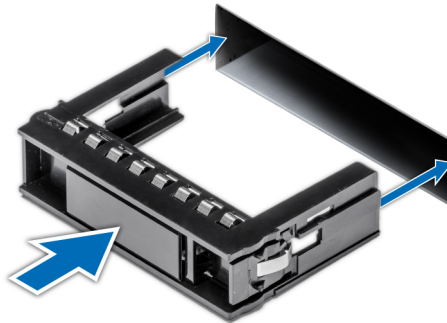


Figure 45. Installing a drive blank

#### Next steps

If removed, [Installing the front bezel](#)

## Removing a 2.5-inch drive from a 3.5-inch drive adapter


#### Prerequisites

1. Follow the safety guidelines listed in [Safety instructions](#).
2. [Removing a 3.5-inch drive adapter from a 3.5-inch drive carrier](#)

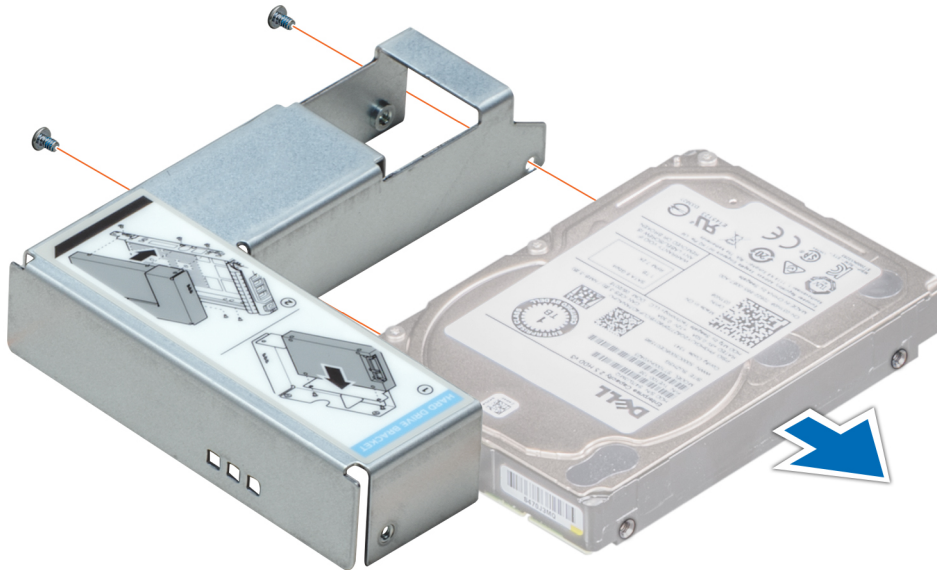
**NOTE:** A 2.5 inch drive is installed in a 3.5 inch drive adapter, which is then installed in the 3.5-inch drive carrier.

### Steps

1. Using a Phillips #2 screwdriver, remove the screws from the side of the 3.5-inch drive adapter.

**NOTE:** If the hard drive or SSD carrier has Torx screw, use Torx 6 screwdriver to remove the drive. 

2. Remove the 2.5-inch drive from the 3.5-inch drive adapter.



**Figure 46. Removing a 2.5 inch drive from a 3.5-inch drive adapter**

### Next steps

Installing a 2.5-inch drive into a 3.5-inch drive adapter


## Installing a 2.5-inch drive into a 3.5-inch drive adapter

### Prerequisites

1. Follow the safety guidelines listed in [Safety instructions](#).
2. [Removing a 3.5-inch drive adapter from a 3.5-inch drive carrier](#)

### Steps

1. Align the screw holes on the 2.5-inch drive with the screw holes on the 3.5-inch drive adapter.
2. Using a Phillips #2 screwdriver, secure the 2.5-inch drive to the 3.5-inch drive adapter.

**NOTE:** If the hard drive or SSD carrier has Torx screw, use Torx 6 screwdriver to remove the drive. 



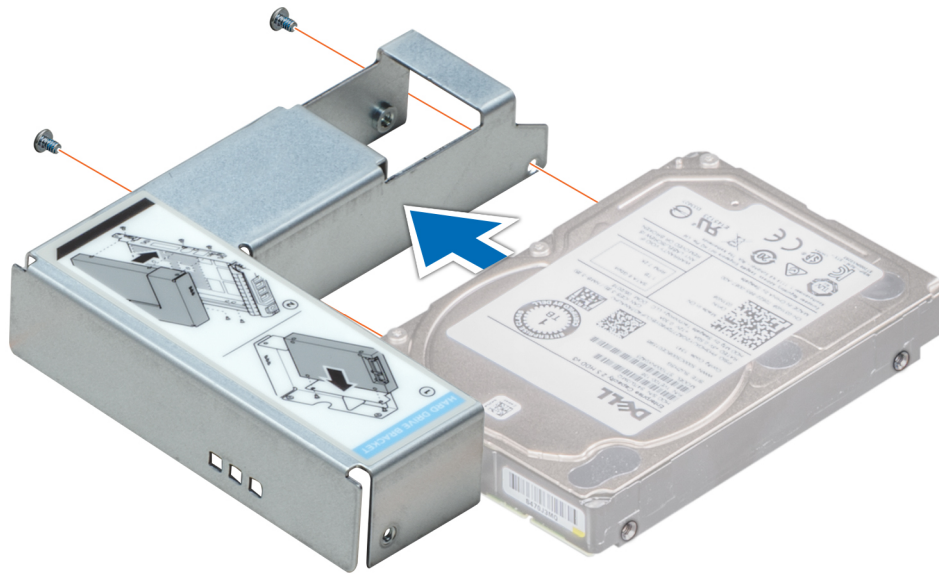


Figure 47. Installing a 2.5-inch drive into a 3.5-inch drive adapter

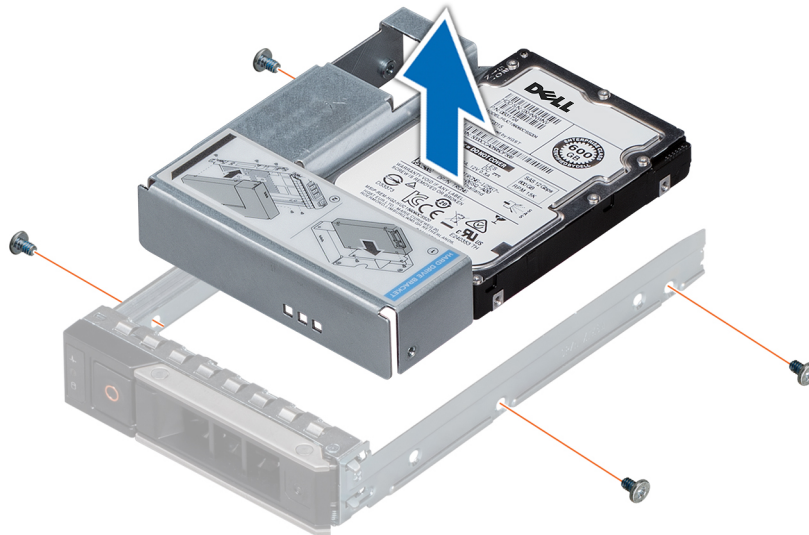
## Removing a 3.5-inch drive adapter from a 3.5-inch drive carrier

### Prerequisites

1. Follow the safety guidelines listed in [Safety instructions](#).
2. If installed, [Removing the front bezel](#)
3. Remove the 3.5-inch drive carrier from the system.

### Steps

1. Using a Phillips #1 screwdriver, remove the screws from the rails on the drive carrier.  
**i** **NOTE:** If the 3.5-inch drive has Torx screw, use Torx 6 screwdriver to remove the drive from a 3.5-inch drive adapter.
2. Lift the 3.5 inch drive adapter out of the 3.5-inch drive carrier.



**Figure 48. Removing a 3.5-inch drive adapter from a 3.5-inch drive carrier**

### Next steps

Installing a 3.5-inch drive adapter into the 3.5-inch drive carrier

## Installing a 3.5-inch drive adapter into the 3.5-inch drive carrier

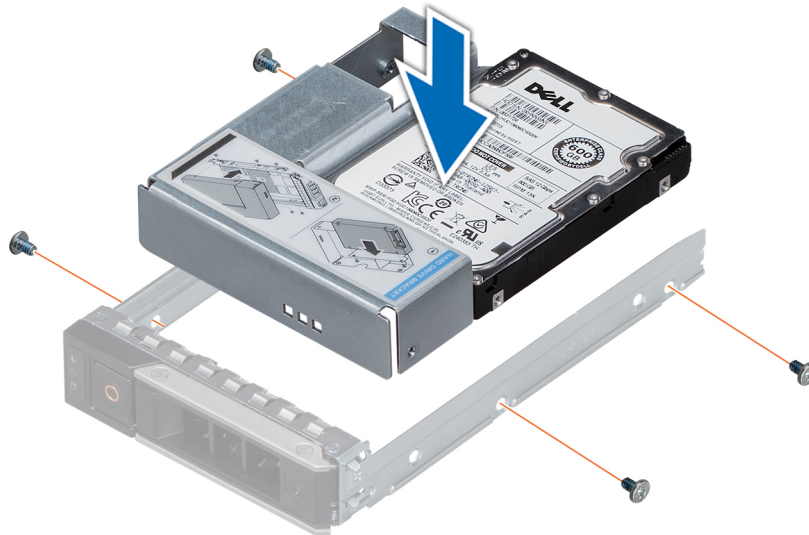
### Prerequisites

1. Follow the safety guidelines listed in [Safety instructions](#).
2. [Install the 2.5-inch drive into the 3.5-inch drive adapter](#).

### Steps

1. Insert the 3.5-inch drive adapter into the 3.5-inch drive carrier with the connector end of the drive toward the back of the 3.5-inch drive carrier.
2. Align the screw holes on the 3.5-inch drive adapter with the holes on the 3.5-inch drive carrier.
3. Using a Phillips #1 screwdriver, secure the 3.5-inch drive adapter to the 3.5-inch carrier.

**NOTE:** If the 3.5-inch drive has Torx screw, use Torx 6 screwdriver to remove the drive from a 3.5-inch drive adapter.



**Figure 49. Installing a 3.5-inch drive adapter into the 3.5-inch drive carrier**

### Next steps

1. Install the 3.5-inch drive carrier into the system.
2. If removed, install the front bezel.

## Removing a drive carrier

### Prerequisites

1. Follow the safety guidelines listed in [Safety instructions](#).
2. If applicable, remove the front bezel.
3. Using the management software, prepare the drive for removal.

If the drive is online, the green activity or fault indicator flashes while the drive is turning off. When the drive indicators are off, the drive is ready for removal. For more information, see the documentation for the storage controller.

**CAUTION:** Before attempting to remove or install a drive while the system is running, see the documentation for the storage controller card to ensure that the host adapter is configured correctly to support drive removal and insertion.

**CAUTION:** Mixing drives from previous generations of PowerEdge servers is not supported.

**CAUTION:** To prevent data loss, ensure that your operating system supports drive installation. See the documentation supplied with your operating system.

### Steps

1. Press the release button to open the drive carrier release handle.
2. Holding the handle, slide the drive carrier out of the drive slot.



Figure 50. Removing a drive carrier

### Next steps

1. Follow the procedure listed in [After working inside your system](#).
2. [Install a drive carrier](#).
3. If you are not replacing the drive immediately, [Insert a drive blank](#) in the empty drive slot to maintain proper system cooling.

## Installing a drive carrier

### Prerequisites

- ⚠ **CAUTION:** Before attempting to remove or install a drive while the system is running, see the documentation for the storage controller card to ensure that the host adapter is configured correctly to support drive removal and insertion.
- ⚠ **CAUTION:** Mixing drives from previous generations of PowerEdge servers is not supported.
- ⚠ **CAUTION:** Combining SAS and SATA drives in the same RAID volume is not supported.
- ⚠ **CAUTION:** When installing a drive, ensure that the adjacent drives are fully installed. Inserting a drive carrier and attempting to lock its handle next to a partially installed carrier can damage the partially installed carrier's shield spring and make it unusable.
- ⚠ **CAUTION:** To prevent data loss, ensure that your operating system supports hot-swap drive installation. See the documentation supplied with your operating system.
- ⚠ **CAUTION:** When a replacement hot swappable drive is installed and the system is powered on, the drive automatically begins to rebuild. Ensure that the replacement drive is blank or contains data that you wish to overwrite. Any data on the replacement drive is immediately lost after the drive is installed.

1. Follow the safety guidelines listed in [Safety instructions](#).
2. If applicable, [remove the drive blank](#).

### Steps

1. Press the release button on the front of the drive carrier to open the release handle.
2. Insert the drive carrier into the drive slot and slide until the drive connects with the backplane.
3. Close the drive carrier release handle to lock the drive in place.



Figure 51. Installing a drive carrier

### Next steps

If applicable, install the front bezel.

## Removing the drive from the drive carrier

### Prerequisites

**CAUTION:** Mixing drives from previous generations of PowerEdge servers is not supported.

### Steps

1. Using a Phillips #1 screwdriver, remove the screws from the slide rails on the drive carrier.
2. Lift the drive out of the drive carrier.



Figure 52. Removing the drive from the drive carrier

## Next steps

If applicable, [Installing a drive into the drive carrier](#)

# Installing a drive into the drive carrier

## Prerequisites

**CAUTION:** Mixing drive carriers from other generations of PowerEdge servers is not supported.

**NOTE:** When installing a drive into the drive carrier, ensure that the screws are torqued to 4 in-lbs.

## Steps

1. Insert the drive into the drive carrier with the connector end of the drive towards the back of the carrier.
2. Align the screw holes on the drive with the screws holes on the drive carrier.  
When aligned correctly, the back of the drive is flush with the back of the drive carrier.
3. Using a Phillips #1 screwdriver, secure the drive to the drive carrier with screws.



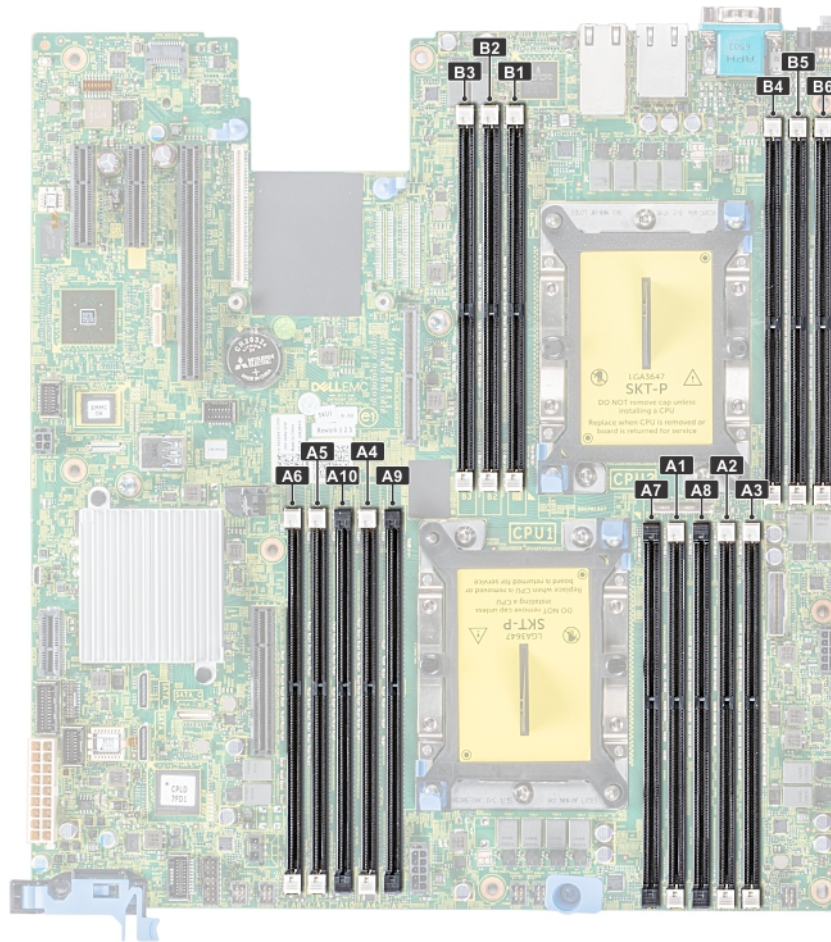
Figure 53. Installing a drive into the drive carrier

# System memory

## System memory guidelines

The PowerEdge systems support DDR4 Registered DIMMs (RDIMMs), and Load Reduced DIMMs (LRDIMMs). The processor runs the instructions that are held by the system memory.

Your system contains 16 memory sockets. Processor 1 supports up to 10 memory sockets and Processor 2 supports up to six memory sockets. Six memory channels are allocated to each processor. Processor 1 has four 2xDIMM slots per channel and two 1xDIMM slot per channel. Processor 2 has six 1xDIMM per channel.



**Figure 54. Memory socket locations**

Memory channels are organized as follows:

**Table 19. Memory channels**

Processor	Channel 0	Channel 1	Channel 2	Channel 3	Channel 4	Channel 5
Processor 1	Slots A1 and A7	Slots A2 and A8	Slots A3	Slots A4 and A9	Slots A5 and A10	Slots A6
Processor 2	Slots B1	Slots B2	Slots B3	Slots B4	Slots B5	Slots B6

## General memory module installation guidelines

To ensure optimal performance of your system, observe the following general guidelines when configuring your system memory. If your system's memory configurations fail to observe these guidelines, your system might not boot, stop responding during memory configuration, or operate with reduced memory.

- System profile selected (for example, Performance Optimized, or Custom [can be run at high speed or lower])
- Maximum supported DIMM speed of the processors.
- Maximum supported DIMM speed of the processors.
- Maximum supported speed of the DIMMs

**i** **NOTE:** MT/s indicates DIMM speed in MegaTransfers per second.

The system supports Flexible Memory Configuration, enabling the system to be configured and run in any valid chipset architectural configuration. The following are the recommended guidelines for installing memory modules:

- All DIMMs must be DDR4.

- RDIMMs and LRDIMMs must not be mixed.
  - 64 GB LRDIMMs that are DDP (Dual Die Package) LRDIMMs must not be mixed with 128 GB LRDIMMs that are TSV (Through Silicon Via/3DS) LRDIMMs.
  - x4 and x8 DRAM based memory modules can be mixed.
  - Up to two RDIMMs can be populated per channel regardless of rank count.
  - Up to two LRDIMMs can be populated per channel regardless of rank count.
  - A maximum of two different ranked DIMMs can be populated in a channel regardless of rank count.
  - If memory modules with different speeds are installed, they will operate at the speed of the slowest installed memory module(s).
  - Populate memory module sockets only if a processor is installed.
    - For single-processor systems, sockets A1 to A10 are available.
    - For dual-processor systems, sockets A1 to A10 and sockets B1 to B6 are available.
  - Populate all the sockets with white release tabs first, followed by the black release tabs.
  - When mixing memory modules with different capacities, populate the sockets with memory modules with the highest capacity first.
    - i** **NOTE:** For example, if you want to mix 8 GB and 16 GB memory modules, populate 16 GB memory modules in the sockets with white release tabs and 8 GB memory modules in the sockets with black release tabs.
  - Memory modules of different capacities can be mixed provided other memory population rules are followed.
    - i** **NOTE:** For example, 8 GB and 16 GB memory modules can be mixed.
  - In a dual-processor configuration, the memory configuration for each processor must be identical.
    - i** **NOTE:** For example, if you populate socket A1 for processor 1, then populate socket B1 for processor 2, and so on.
  - Mixing of more than two memory module capacities in one system is not supported.
  - Unbalanced memory configurations will result in a performance loss so always populate memory channels identically with identical DIMMs for best performance.
  - Populate six identical memory modules per processor (one DIMM per channel) at a time to maximize performance.
- DIMM population update for Performance Optimized mode with quantity of 4 and 8 DIMMs per processor.
- When the DIMM quantity is 4 per processor, the population is slot 1, 2, 4, 5.
  - When the DIMM quantity is 8 per processor, the population is slot 1, 2, 4, 5, 7, 8, 9, 10.

## Mode-specific guidelines

The configurations allowed depend on the memory mode selected in the System BIOS.

**Table 20. Memory operating modes**

Memory Operating Mode	Description
<b>Optimizer Mode</b>	The <b>Optimizer Mode</b> if enabled, the DRAM controllers operate independently in the 64-bit mode and provide optimized memory performance.
<b>Mirror Mode</b>	The <b>Mirror Mode</b> if enabled, the system maintains two identical copies of data in memory, and the total available system memory is one half of the total installed physical memory. Half of the installed memory is used to mirror the active memory modules. This feature provides maximum reliability and enables the system to continue running even during a catastrophic memory failure by switching over to the mirrored copy. The installation guidelines to enable Mirror Mode require that the memory modules be identical in size, speed, and technology, and they must be populated in sets of 6 per processor.
<b>Single Rank Spare Mode</b>	<b>Single Rank Spare Mode</b> allocates one rank per channel as a spare. If excessive correctable errors occur in a rank or channel, while the operating system is running, they are moved to the spare area to prevent errors from causing an uncorrectable failure. Requires two or more ranks to be populated in each channel.
<b>Multi Rank Spare Mode</b>	<b>Multi Rank Spare Mode</b> allocates two ranks per channel as a spare. If excessive correctable errors occur in a rank or channel, while the operating system is running, they are moved to the spare area to prevent errors from causing an uncorrectable failure. Requires three or more ranks to be populated in each channel.



**Table 20. Memory operating modes (continued)**

Memory Operating Mode	Description
	<p>With single rank memory sparing enabled, the system memory available to the operating system is reduced by one rank per channel.</p> <p>For example, in a dual-processor configuration with sixteen 16 GB dual-rank memory modules, the available system memory: 16 GB x 16(memory modules) - 8GB(1 rank sparing/channel) x 12(channel) = 256 GB - 96 GB = 160 GB. For multi rank sparing, in a dual-processor configuration with sixteen 64 GB quad-rank memory modules, the available system memory: 64 GB x 16(memory modules) - 32 GB(2 rank sparing/channel) x 12 (channel) = 1024 GB - 384 GB = 640 GB.</p> <p><b>NOTE:</b> To use memory sparing, this feature must be enabled in the BIOS menu of System Setup.</p> <p><b>NOTE:</b> Memory sparing does not offer protection against a multi-bit uncorrectable error.</p>
<b>Dell Fault Resilient Mode</b>	<p>The <b>Dell Fault Resilient Mode</b> if enabled, the BIOS creates an area of memory that is fault resilient. This mode can be used by an OS that supports the feature to load critical applications or enables the OS kernel to maximize system availability.</p> <p><b>NOTE:</b> This feature is only supported in Gold and Platinum Intel processors.</p> <p><b>NOTE:</b> Memory configuration has to be of same size DIMM, speed, and rank.</p>

## Optimizer Mode

This mode supports Single Device Data Correction (SDDC) only for memory modules that use x4 device width. It does not impose any specific slot population requirements.

- Dual processor: Populate the slots in round robin sequence starting with processor 1.
- NOTE:** Processor 1 and processor 2 population should match.

**Table 21. Memory population rules**

Processor	Configuration	Memory population	Memory population information
Single processor	Optimizer (Independent channel) population order	1, 2, 3, 4, 5, 6, 7, 8, 9, 10	<ul style="list-style-type: none"> <li>Populate in this order, odd amount allowed.</li> <li>Odd number of DIMM population is allowed.</li> <li><b>NOTE:</b> Odd number of DIMMs will result in unbalanced memory configurations, which in turn will result in performance loss. It is recommended to populate all memory channels identically with identical DIMMs for best performance.</li> <li>Optimizer population order is not traditional for 4 and 8 DIMM installations of single processor.</li> </ul>

**Table 21. Memory population rules (continued)**

Processor	Configuration	Memory population	Memory population information
			<ul style="list-style-type: none"> <li>○ For 4 DIMMs: A1, A2, A4, A5</li> <li>○ For 8 DIMMs: A1, A2, A4, A5, A7, A8, A9, A10</li> </ul>
	Mirror population order	{1, 2, 3, 4, 5, 6}	Mirroring is supported with 6 DIMM slots per processor.
	Single rank sparing population order	1, 2, 3, 4, 5, 6, 7, 8, 9, 10	Populate in this order, odd amount allowed. Requires two ranks or more per channel.
	Multi rank sparing population order	1, 2, 3, 4, 5, 6, 7, 8, 9, 10	Populate in this order, odd amount allowed. Requires three ranks or more per channel.
Dual processor (Populate round robin starting with processor1)	Optimized (Independent channel) population order	A{1}, B{1}, A{2}, B{2}, A{3}, B{3}...	<ul style="list-style-type: none"> <li>● Odd amount of DIMM slots per processor allowed.</li> <li>● Odd number of DIMM population is allowed.</li> <li> <span style="color: blue;">i</span> <b>NOTE:</b> Odd number of DIMMs will result in unbalanced memory configurations, which in turn will result in performance loss. It is recommended to populate all memory channels identically with identical DIMMs for best performance.                 </li> <li>● Optimizer population order is not traditional for 8 and 14 DIMM installations of dual processor.                     <ul style="list-style-type: none"> <li>○ For 8 DIMMs: A1, A2, A4, A5, B1, B2, B4, B5</li> <li>○ For 14 DIMMs: A1, A2, A4, A5, A7, A8, A9, A10, B1, B2, B3, B4, B5, B6</li> </ul> </li> </ul>
	Mirroring population order	A{1, 2, 3, 4, 5, 6}, B{1, 2, 3, 4, 5, 6}	Mirroring is supported with 6 DIMM slots per processor.
	Single rank sparing population order	A{1}, B{1}, A{2}, B{2}, A{3}, B{3}...	Populate in this order, odd amount per processor allowed. Requires two ranks or more per channel.
	Multi rank sparing population order	A{1}, B{1}, A{2}, B{2}, A{3}, B{3}...	Populate in this order, odd amount per processor allowed. Requires three ranks or more per channel.

## Removing a memory module

### Prerequisites

1. Follow the safety guidelines listed in [Safety instructions](#).
2. Follow the procedure listed in [Before working inside your system](#).
3. If applicable, [Removing the air shroud](#)

**WARNING:** Allow the memory modules to cool after you power off the system. Handle the memory modules by the card edges and avoid touching the components or metallic contacts on the memory module.

### Steps

1. Locate the appropriate memory module socket.

**CAUTION:** Handle each memory module only by the card edges, ensuring not to touch the middle of the memory module or metallic contacts.

2. Push the ejectors outward on both ends of the memory module socket to release the memory module from the socket.
3. Lift and remove the memory module from the system.

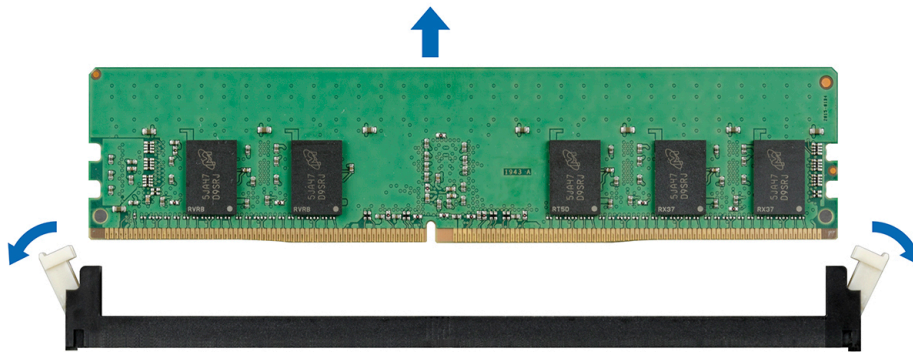


Figure 55. Removing a memory module

## Installing a memory module

### Prerequisites

Follow the safety guidelines listed in [Safety instructions](#).

### Steps

1. Locate the appropriate memory module socket.

**CAUTION:** Handle each memory module only by the card edges, ensuring not to touch the middle of the memory module or metallic contacts.

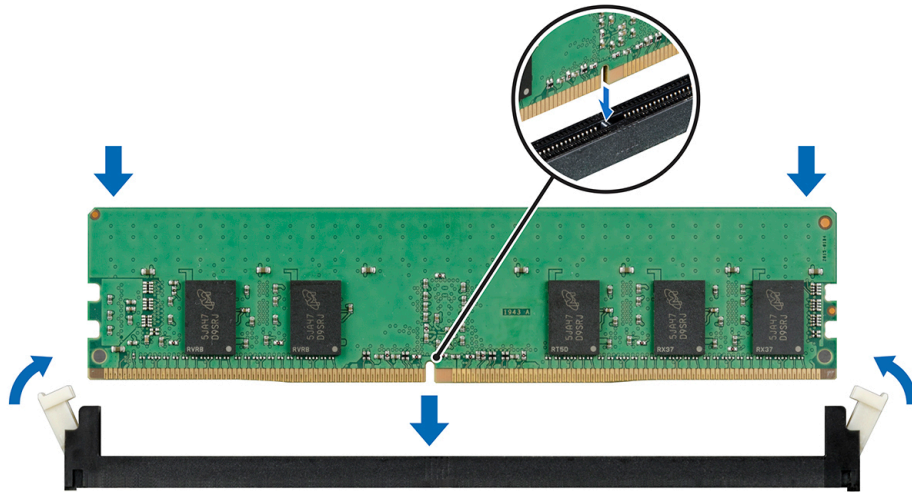
**CAUTION:** To prevent damage to the memory module or the memory module socket during installation, do not bend or flex the memory module. You must insert both ends of the memory module simultaneously.

2. Open the ejectors on the memory module socket outward to allow the memory module to be inserted into the socket.
3. Align the edge connector of the memory module with the alignment key of the memory module socket, and insert the memory module in the socket.

**CAUTION:** Do not apply pressure at the center of the memory module; apply pressure at both ends of the memory module evenly.

**NOTE:** The memory module socket has an alignment key that enables you to install the memory module in the socket in only one orientation.

4. Press the memory module with your thumbs until the socket levers firmly click into place.



**Figure 56. Installing a memory module**

### Next steps

1. [Installing the air shroud](#)
2. Follow the procedure listed in [After working inside your system](#).
3. To verify if the memory module has been installed properly, press F2 and navigate to **System Setup Main Menu > System BIOS > Memory Settings**. In the **Memory Settings** screen, the System Memory Size must reflect the updated capacity of the installed memory.
4. If the value is incorrect, one or more of the memory modules may not be installed properly. Ensure that the memory module is firmly seated in the memory module socket.
5. Run the system memory test in system diagnostics.

## Processors and heat sinks

### Removing a processor and heat sink module

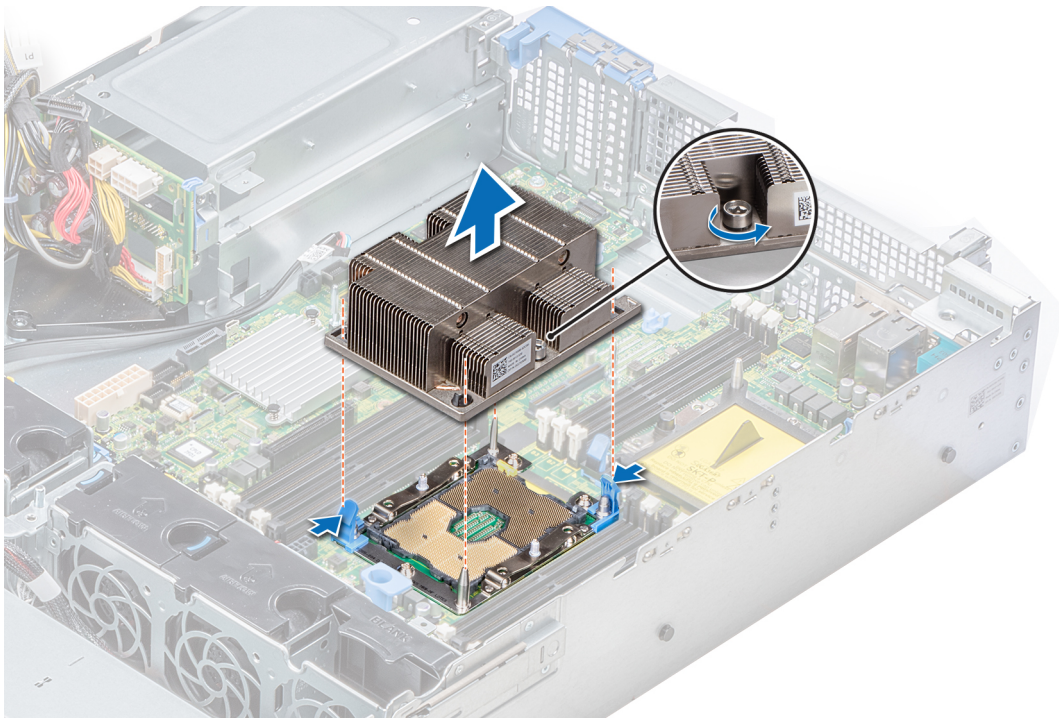
#### Prerequisites

**⚠ WARNING:** The heat sink may be hot to touch for some time after the system is powered down. Allow the heat sink to cool before removing it.

1. Follow the safety guidelines listed in [Safety instructions](#).
2. Follow the procedure listed in [Before working inside your system](#).
3. [Remove the air shroud](#).

#### Steps

1. Using a Torx #T30 screwdriver, loosen the screws on the heat sink in the order below:
  - a. Loosen the first screw three turns.
  - b. Loosen the second screw completely.
  - c. Return to the first screw and loosen it completely.
2. Pushing both blue retention clips simultaneously, lift the processor and heat sink module (PHM) processor and heat sink module
3. Set the PHM aside with the processor side facing up.



**Figure 57. Removing processor and heat sink module**

### Next steps

Installing a processor and heat sink module

## Removing the non-fabric processor from the processor and heat sink module

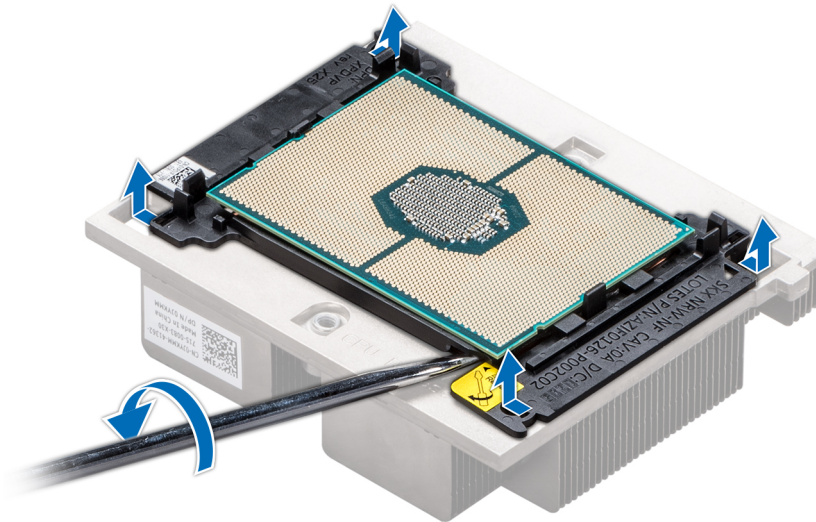
### Prerequisites

**i** **NOTE:** Only remove the processor from the processor and heat sink module if you are replacing the processor or heat sink. This procedure is not required when replacing a system board.

1. Follow the safety guidelines listed in [Safety instructions](#).
2. Follow the procedure listed in [Before working inside your system](#).
3. [Removing the air shroud](#)
4. [Removing a processor and heat sink module](#)

### Steps

1. Place the heat sink with the processor side facing up.
2. Insert a flat blade screwdriver into the release slot marked with a yellow label. Twist (do not pry) the screwdriver to break the thermal paste seal.
3. Push the retaining clips on the processor bracket to unlock the bracket from the heat sink.



**Figure 58. Loosening the processor bracket**

4. Lift the bracket and the processor away from the heat sink, and place the processor connector side down on the processor tray.
5. Flex the outer edges of the bracket to release the bracket from the processor.

**NOTE:** Ensure that the processor and the bracket are placed in the tray after you remove the heat sink.



**Figure 59. Removing the processor bracket**

### Next steps

Installing a processor and heat sink module

# Installing the non-fabric processor into a processor and heat sink module

## Prerequisites

Follow the safety guidelines listed in [Safety instructions](#).

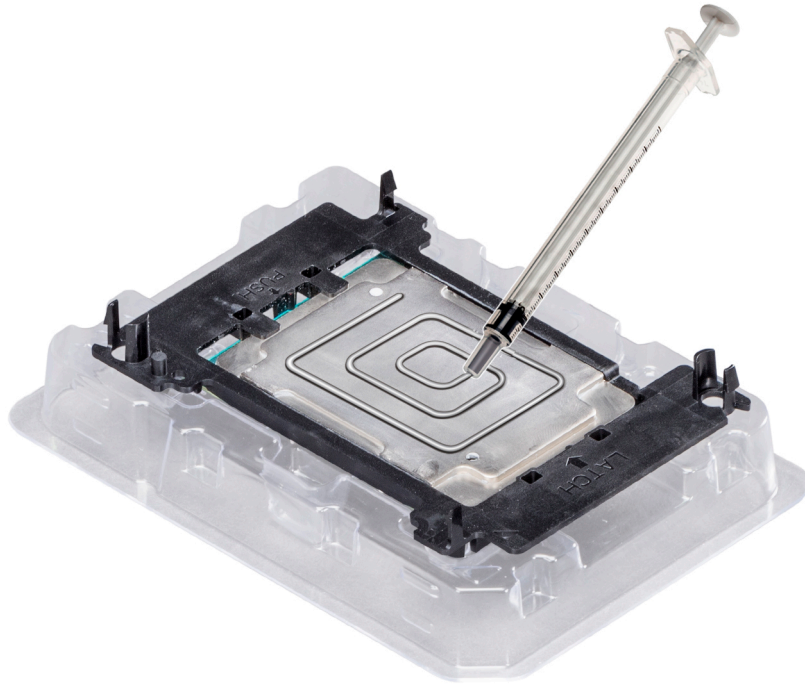
## Steps

1. Place the processor in the processor tray.
  - i** **NOTE:** Ensure that the pin 1 indicator on the processor tray is aligned with the pin 1 indicator on the processor.
2. Flex the outer edges of the bracket around the processor ensuring that the processor is locked into the clips on the bracket.
  - i** **NOTE:** Ensure that the pin 1 indicator on the bracket is aligned with the pin 1 indicator on the processor before placing the bracket on the processor.
  - i** **NOTE:** Ensure that the processor and the bracket are placed in the tray before you install the heat sink.



**Figure 60. Installing the processor bracket**

3. If you are using an existing heat sink, remove the thermal grease from the heat sink by using a clean lint-free cloth.
4. Use the thermal grease syringe included with your processor kit to apply the grease in a quadrilateral design on the top of the processor.
  - ⚠ CAUTION:** Applying too much thermal grease can result in excess grease coming in contact with and contaminating the processor socket.
  - i** **NOTE:** The thermal grease syringe is intended for single use only. Dispose the syringe after you use it.



**Figure 61. Applying thermal grease on top of the processor**

5. Place the heat sink on the processor and push down on the base of the heat sink until the bracket locks onto the heat sink.

**i NOTE:**

- Ensure that the two guide pin holes on the bracket match the guide holes on the heat sink.
- Do not press on the heat sink fins.
- Ensure that the pin 1 indicator on the heat sink is aligned with the pin 1 indicator on the bracket before placing the heat sink onto the processor and bracket.



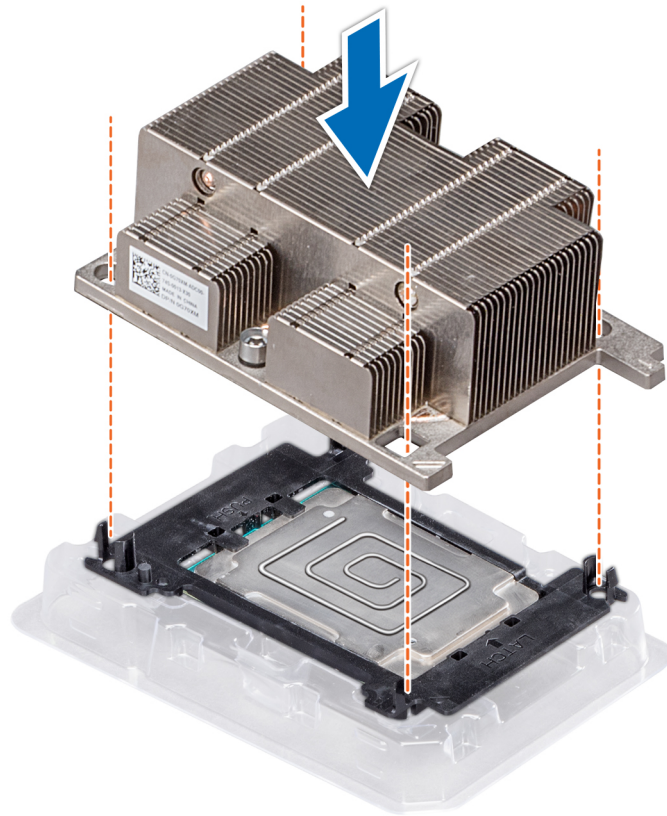


Figure 62. Installing the heat sink onto the processor

#### Next steps

1. [Installing a processor and heat sink module](#)
2. [Installing the air shroud](#)
3. Follow the procedure listed in [After working inside your system](#).

## Installing a processor and heat sink module

#### Prerequisites

**CAUTION:** Never remove the heat sink from a processor unless you intend to replace the processor. The heat sink is necessary to maintain proper thermal conditions.

1. Follow the safety guidelines listed in [Safety instructions](#).
2. If installed, remove the CPU dust cover.

#### Steps

1. Align the pin 1 indicator of the heat sink to the system board and then place the processor and heat sink module (PHM) on the processor socket.

**CAUTION:** To avoid damaging the fins on the heat sink, do not press down on the heat sink fins.

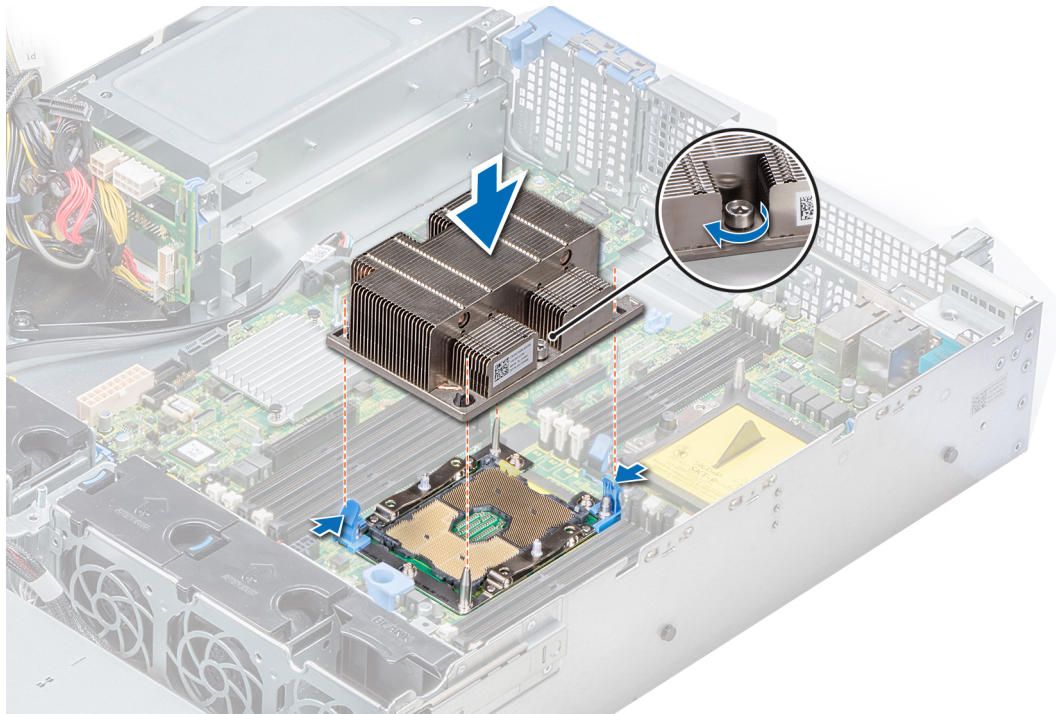
**NOTE:** Ensure that the PHM is held parallel to the system board to prevent damaging the components.

2. Push the blue retention clips inward to allow the heat sink to drop into place.
3. Using the Torx #T30 screwdriver, tighten the screws on the heat sink in the order below:
  - a. Partially tighten the first screw (approximately 3 turns).

- b. Tighten the second screw completely.
- c. Return to the first screw and tighten it completely.

If the PHM slips off the blue retention clips when the screws are partially tightened, follow these steps to secure the PHM:

- a. Loosen both the heat sink screws completely.
- b. Lower the PHM on to the blue retention clips, following the procedure described in step 2.
- c. Secure the PHM to the system board, following the replacement instructions listed in this step above. 4.



**Figure 63. Installing the processor and heat sink module**

**Next steps**

- 1. Install the air shroud.
- 2. Follow the procedure listed in [After working inside your system.](#)

## Expansion cards and expansion card risers

### Expansion card installation guidelines

The following table describes the supported expansion cards:

**Table 22. Expansion card riser configurations**

Expansion card riser	PCIe slots on the riser	Processor connection	Height	Length	Slot width
Full height right riser	Slot 2	Processor 1	Full Height	Half Length	x16
Low profile right riser	Slot 2	Processor 1	Low Profile	Half Length	x16
Low profile left riser	Slot 3	Processor 2	Low Profile	Half Length	x16
Butterfly riser	Slot 2	Processor 1	Full Height	Half Length	x16
Butterfly riser	Slot 3	Processor 1	Low Profile	Half Length	x8

**NOTE:** The expansion-card slots are not hot-swappable.

The following table provides guidelines for installing expansion cards to ensure proper cooling and mechanical fit. The expansion cards with the highest priority should be installed first using the slot priority indicated. All the other expansion cards should be installed in the card priority and slot priority order.

**Table 23. Riser configurations: No RSR - 1 CPU**

Card Type	Slot Priority	Form factor
LOM riser ; 2x1G BCM5720L (ODM)	1	OCP
LOM riser ; 2x10G BCM57416 (BASeT/SFP+) (ODM)	1	OCP
PCIe SSD PCIe Card (Samsung/INTEL)	5	LP
Card, Network (Broadcom/INTEL/Mellanox/Solarflare)	5	LP
Card, Controller (EMULEX/QLOGIC)	5	LP
BOSS M.2 (SATA) (Dell)	5	LP
Card, Network (Broadcom/INTEL)	6, 5	LP
PERC9.14G (Foxconn)	Integrated Slot	FH or LP
HBA: External adapter	5	LP
RAID - PERC9.14G/PERC10 (Internal)/PERC11 (Dell)	Integrated Slot	FH or LP
Non-RAID - PERC11 (Internal) (Dell)	Integrated Slot	FH or LP
Non-RAID - PERC11 (External) (Dell)	5	LP
PERC 10 External adapter (Dell)	5	LP

**Table 24. Riser configurations: No RSR - 2 CPU**

Card type	Slot priority	Form factor
LOM riser ; 2x1G BCM5720L (ODM)	1	OCP
LOM riser ; 2x10G BCM57416 (BASeT/SFP+) (ODM)	1	OCP
PCIe SSD PCIe Card (Samsung/INTEL)	4, 5	LP
Card, Network (Broadcom/INTEL/Mellanox/Solarflare)	4, 5	LP
Card, Controller (EMULEX/QLOGIC)	4, 5	LP
Intel OPA NIC (Intel OPA)	4	LP
BOSS M.2 (SATA) (Dell)	4, 5	LP
Card, Network (Braodcom/INTEL)	6, 5, 4	LP
PERC9.14G (Foxconn)	Integrated Slot	LP
HBA: External adapter	4, 5	LP
RAID - PERC9.14G/PERC10 (Internal)/PERC11 (Dell)	Integrated Slot	LP
Non-RAID - PERC11 (Internal) (Dell)	Integrated Slot	LP
Non-RAID - PERC11 (External) (Dell)	4, 5	LP
PERC 10 External adapter (Dell)	4, 5	LP

**Table 25. Riser configurations: FH - 1 CPU and 2 CPU**

Card type	Slot priority	Form factor
LOM riser ; 2x1G BCM5720L (ODM)	1	OCP
LOM riser ; 2x10G BCM57416 (BAsE/T/SFP+) (ODM)	1	OCP
PCIe SSD PCIe Card (Samsung/INTEL)	2	FH
NIC (Broadcom/INTEL/EMULEX/Mellanox/Solarflare)	2	FH
Card, Network (Broadcom/INTEL/Mellanox/INTEL)	2	FH
Card, Controller (EMULEX/QLOGIC)	2	FH
Intel OPA NIC (Intel OPA)	2	FH
BOSS M.2 (SATA) (Dell)	2	FH
PERC9.14G (Foxconn/Dell)	2	FH
PERC9.14G (Foxconn)	Integrated Slot	LP
RAID - PERC9.14G/PERC10 (Internal)/PERC 11 (Dell)	Integrated Slot	LP
Non-RAID - PERC 11 (Internal) (Dell)	Integrated Slot	LP
Non-RAID - PERC 11 (External) (Dell)	2	FH
RAID PERC10 (External) (Dell)	2	FH
PERC10 - External adapter (Dell)	2	FH

**Table 26. Riser configurations: LP + LP - 2 CPU**

Card type	Slot priority	Form factor
LOM riser ; 2x1G BCM5720L (ODM)	1	OCP
LOM riser ; 2x10G BCM57416 (BAsE/T/SFP+) (ODM)	1	OCP
PCIe SSD PCIe Card (Samsung/INTEL)	3, 2	LP
Card, Network (Broadcom/INTEL/Mellanox/Solarflare)	3, 2	LP
Card, Controller (EMULEX/QLOGIC)	3, 2	LP
Intel OPA NIC (Intel OPA)	3, 2	LP
BOSS M.2 (SATA) (Dell)	3, 2	LP
PERC9.14G (Foxconn)	Integrated Slot	LP
HBA: External adapter	3, 2	LP
RAID - PERC9.14G/PERC10 (Internal)/PERC11 (Dell)	Integrated Slot	LP
Non-RAID - PERC11 (Internal) (Dell)	Integrated Slot	LP
Non-RAID - PERC11 (External) (Dell)	3, 2	LP
PERC 10 External adapter (Dell)	3, 2	LP

**Table 27. Riser configurations: BTF + 3 XLP - 1 CPU**

Card type	Slot priority	Form factor
LOM riser ; 2x1G BCM5720L (ODM)	1	OCP
LOM riser ; 2x10G BCM57416 (BAsE/T/SFP+) (ODM)	1	OCP
PERC9.14G/PERC10 (ODM)	2	FH
PERC9.14G/PERC10 (Dell)	2, 3, 5	FH
NIC (Broadcom/INTEL/Emulex/Mellanox/Solarflare)	2	FH
Card, Network (Broadcom/INTEL/Mellanox/Solarflare)	2	FH
Card, Controller (EMULEX/QLOGIC)	2	FH
BOSS M.2 (SATA) (Dell)	2	FH
PCIe SSD PCIe Card (Samsung/INTEL)	3, 2, 5	FH or LP
Card, Controller (QLOGIC/EMULEX)	3, 2, 5	FH or LP
Card, Network (Broadcom/INTEL/Mellanox/QLOGIC/Solarflare)	3, 5	LP
Card, Controller (QLOGIC)	3, 5	LP
Intel OPA NIC (Intel OPA)	2	FH
BOSS M.2 (SATA) (Dell)	3, 5	LP
Card, Network (Broadcom)	6, 5, 3	LP
Card, Network (INTEL)	6, 5, 3	LP
PERC9.14G (Foxconn)	Integrated Slot	NONE
RAID - PERC9.14G/PERC10 (Internal) (Dell)	Integrated Slot	NONE
HBA: External adapter	3, 5	LP
RAID - PERC9.14G/PERC10 (Internal)/PERC11 (Dell)	Integrated Slot	LP
Non-RAID - PERC11 (Internal) (Dell)	Integrated Slot	LP
Non-RAID - PERC11 (External) (Dell)	2, 3, 5	FH or LP
RAID - PERC 10 (External) (Dell)	2, 3, 5	FH
PERC 10 External adapter (Dell)	3, 5	LP
PERC 10 External adapter (Dell)	2, 3, 5	FH or LP

**Table 28. Riser configurations: BTF + 3 XLP - 2 CPU**

Card type	Slot priority	From Factor
LOM riser ; 2x1G BCM5720L (ODM)	1	OCP
LOM riser ; 2x10G BCM57416 (BAsE/T/SFP+) (ODM)	1	OCP
PERC9.14G/PERC10 (FXN)	2	FH
ERC9.14G/PERC10 (Dell)	2, 4, 3, 5	FH or LP
Broadcom NIC (Broadcom)	2	FH
Card, Network (Broadcom/INTEL)	2	FH

**Table 28. Riser configurations: BTF + 3 XLP - 2 CPU (continued)**

Card type	Slot priority	From Factor
NIC (Intel/Emulex/Mellanox/Solarflare)	2	FH
Card, Controller (EMULEX/QLOGIC)	2	FH
Card, Network (Mellanox/QLOGIC/INTEL/Solarflare)	2	FH
BOSS M.2 (SATA) (Dell)	2	FH
PCIe SSD PCIe Card (Samsung)	3, 4, 2, 5	FH or LP
Card, Controller (QLOGIC)	3, 4, 2, 5	FH or LP
Card, Network (Broadcom/INTEL/Mellanox/QLOGIC)	4, 3, 5	LP
Card, Controller (EMULEX/QLOGIC)	4, 3, 5	LP
Intel OPA NIC (Intel OPA)	4	LP
Intel OPA NIC (Intel OPA)	2	FH
Card, Network (Solarflare)	4, 3, 5	LP
BOSS M.2 (SATA) (Dell)	4, 3, 5	LP
Card, Network (Broadcom/INTEL)	6, 5, 4, 3	LP
PERC9.14G (Foxconn)	Integrated Slot	NONE
RAID - PERC9.14G/PERC10 (Internal) (Dell)	Integrated Slot	NONE
HBA: External adapter	2, 4, 3, 5	LP
RAID - PERC9.14G/PERC10 (Internal)/PERC11 (Dell)	Integrated Slot	LP
Non-RAID - PERC11 (Internal) (Dell)	Integrated Slot	LP
Non-RAID - PERC11 (External) (Dell)	2, 4, 3, 5	FH or LP
RAID - PERC 10 (External) (Dell)	2	FH
PERC 10 External adapter (Dell)	4, 3, 5	LP
PERC 10 External adapter (Dell)	2, 4, 3, 5	FH or LP

## Removing expansion card from the expansion card riser

### Prerequisites

1. Follow the safety guidelines listed in [Safety instructions](#).
2. Follow the procedure listed in [Before working inside your system](#).
3. If applicable, [Removing the air shroud](#).
4. If applicable, disconnect the cables from the expansion card.
5. When removing a card from low profile, full height X1, or butterfly riser, ensure that the PCIe card holder latch is closed.

### Steps

1. Pull and lift up the expansion card retention latch lock to open.
2. Hold the expansion card by its edges, and pull the card until the card edge connector disengages from the expansion card connector on the riser.

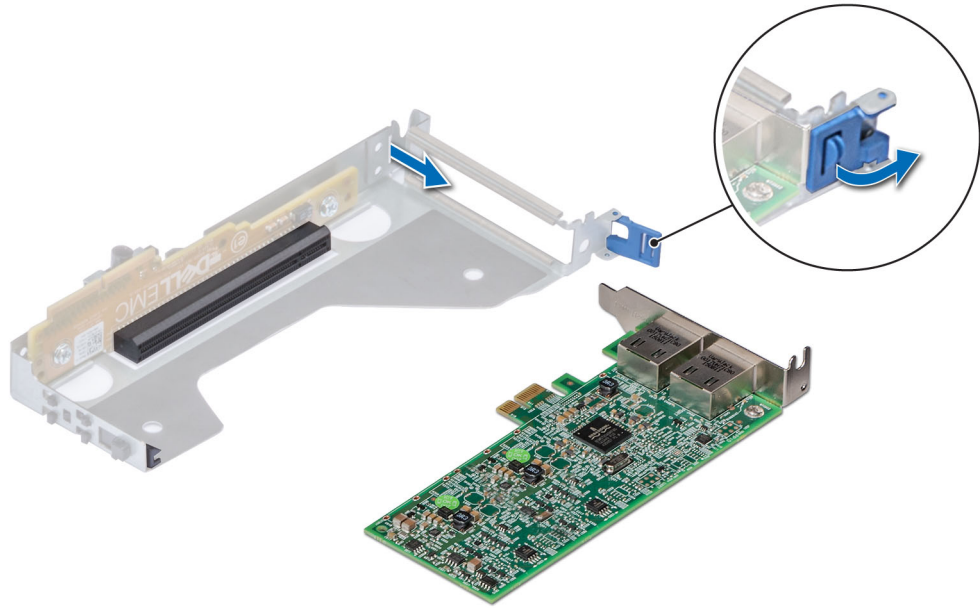


Figure 64. Removing expansion card from low profile riser

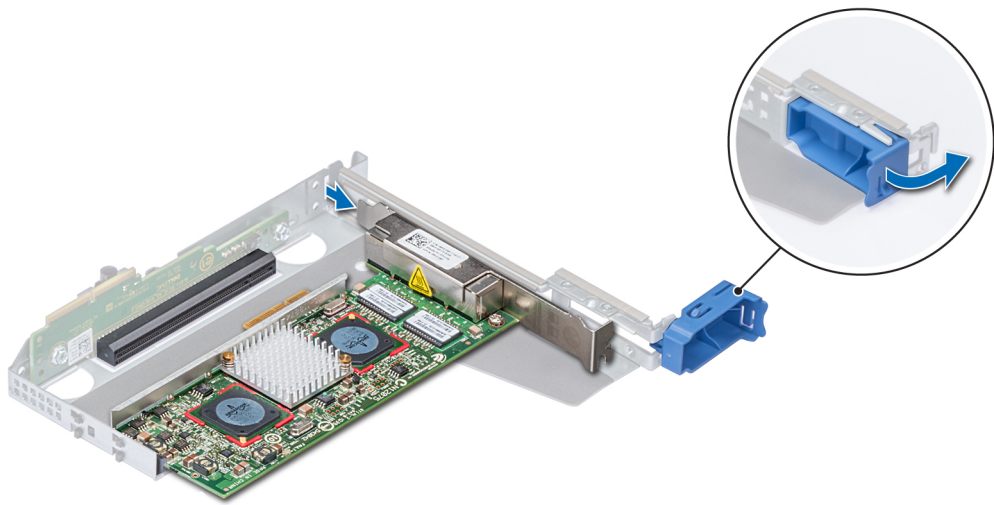
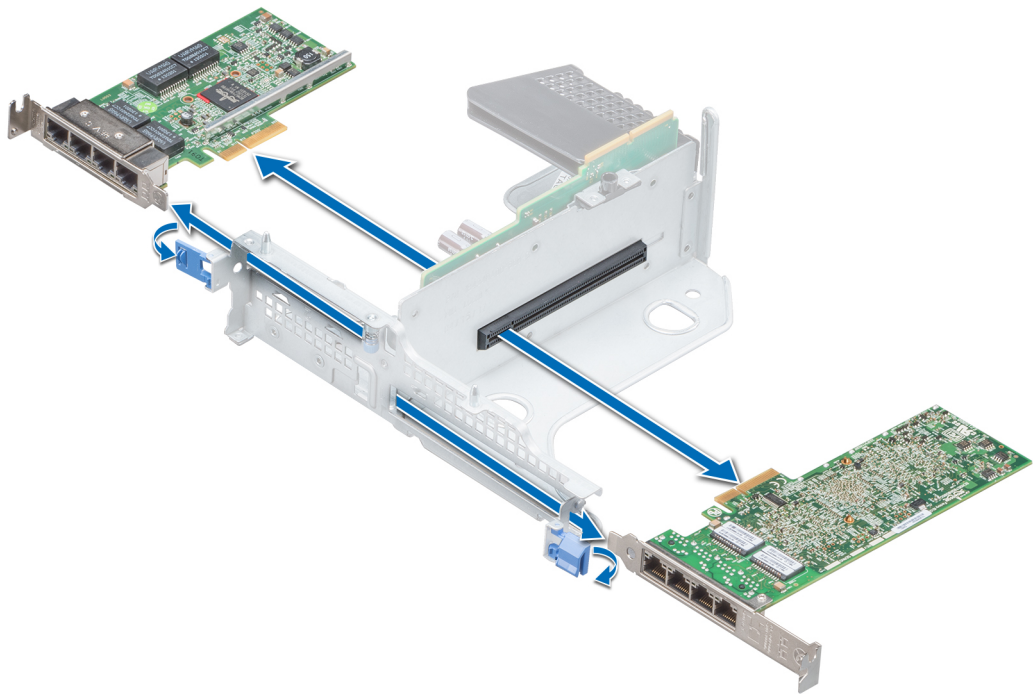
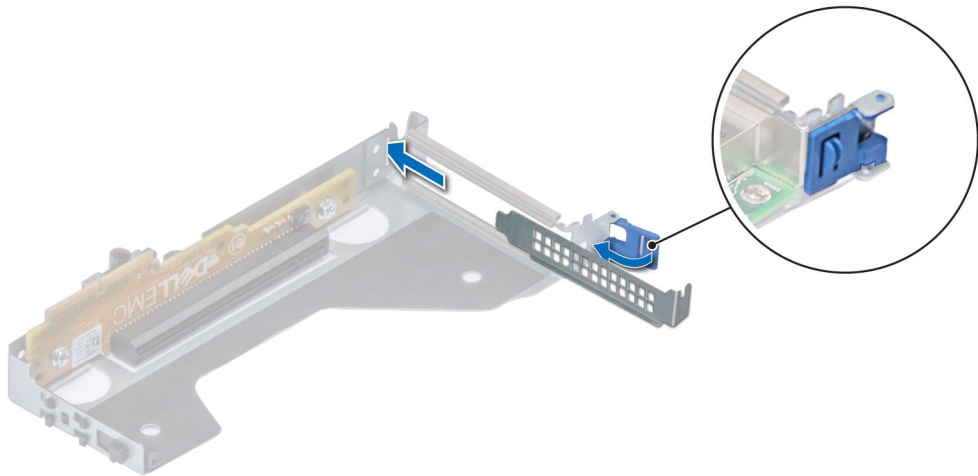


Figure 65. Removing expansion card from full height X1 riser



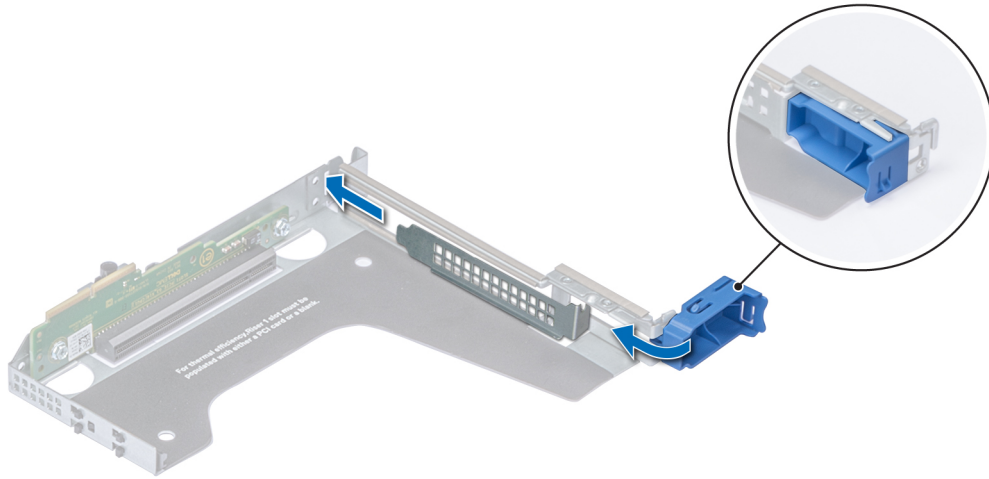
**Figure 66. Removing expansion card from butterfly riser**

3. If the expansion card is not going to be replaced, install a filler bracket.

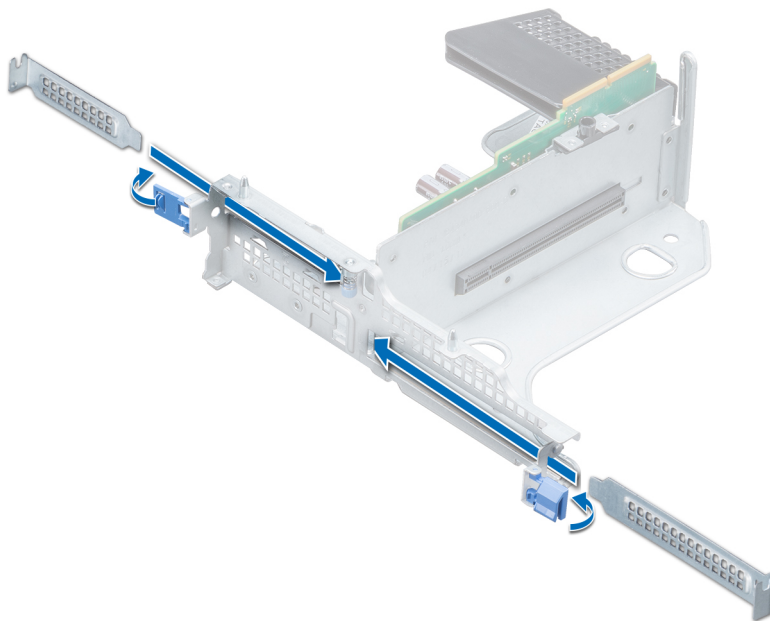


**Figure 67. Installing filler bracket for low profile riser**





**Figure 68. Installing filler bracket for full height X1 riser**



**Figure 69. Installing filler bracket for butterfly riser**

**Next steps**

1. [Install expansion card into the expansion card riser.](#)
2. If you are removing the card permanently, install a metal filler bracket over the empty expansion slot opening and push the expansion card latch.

**NOTE:** You must install a filler bracket over an empty expansion card slot to maintain Federal Communications Commission (FCC) certification of the system. The brackets also keep dust and dirt out of the system and aid in proper cooling and airflow inside the system.

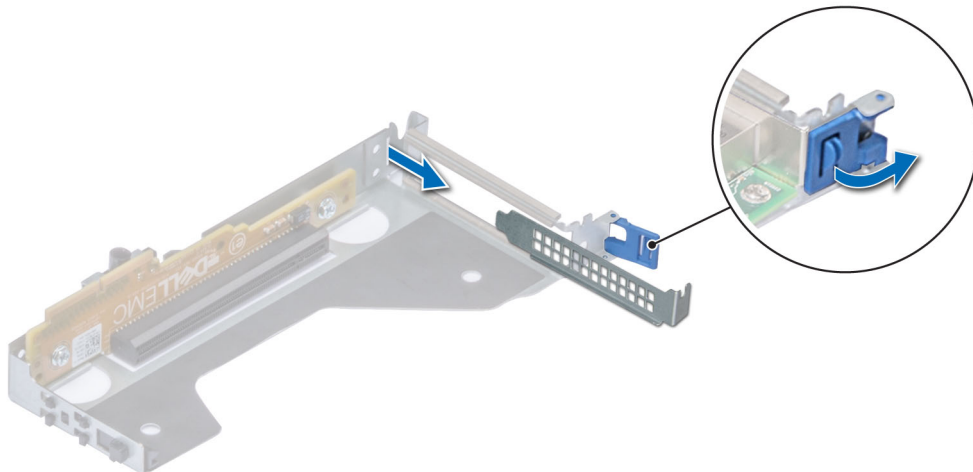
## Installing expansion card into the expansion card riser

### Prerequisites

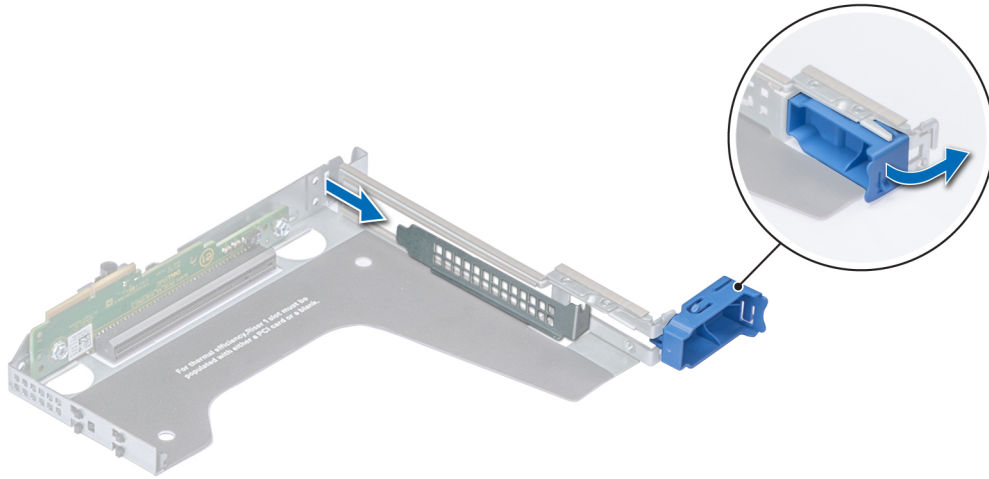
1. Follow the safety guidelines listed in [Safety instructions](#).
2. If installing a new expansion card, unpack it and prepare the card for installation.  
**NOTE:** For instructions, see the documentation accompanying the card.
3. When installing a card into low profile, full height X1, or butterfly riser, open the PCIe card holder latch.

### Steps

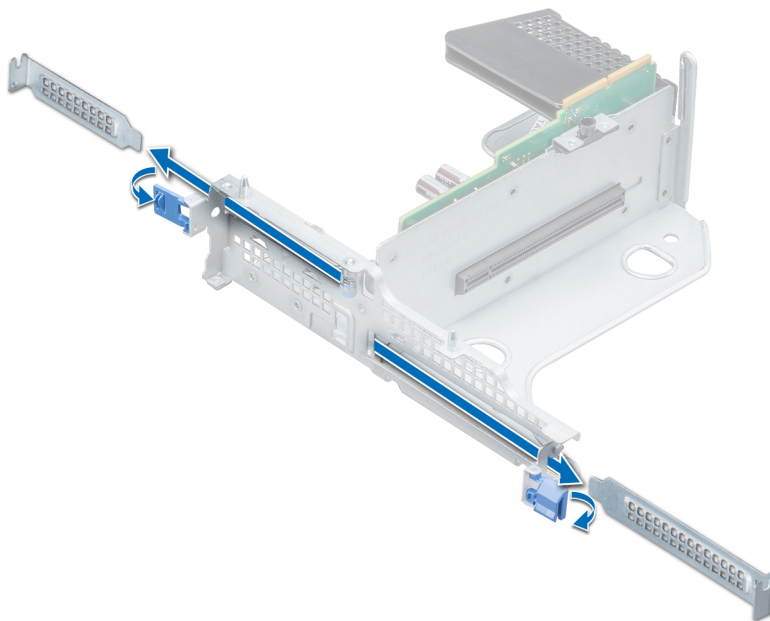
1. Pull and lift up the expansion card retention latch lock to open
  2. If installed, remove the filler bracket.
- NOTE:** Store the filler bracket for future use. Filler brackets must be installed in empty expansion card slots to maintain Federal Communications Commission (FCC) certification of the system. The brackets also keep dust and dirt out of the system and aid in proper cooling and airflow inside the system.



**Figure 70. Removing filler bracket for low profile riser**



**Figure 71. Removing filler bracket for full height X1 riser**



**Figure 72. Removing filler bracket for butterfly riser**

3. Hold the card by its edges, and align the card edge connector with the expansion card connector on the riser.
4. Insert the card edge connector firmly into the expansion card connector until the card is fully seated.
5. Close the expansion card retention latch.

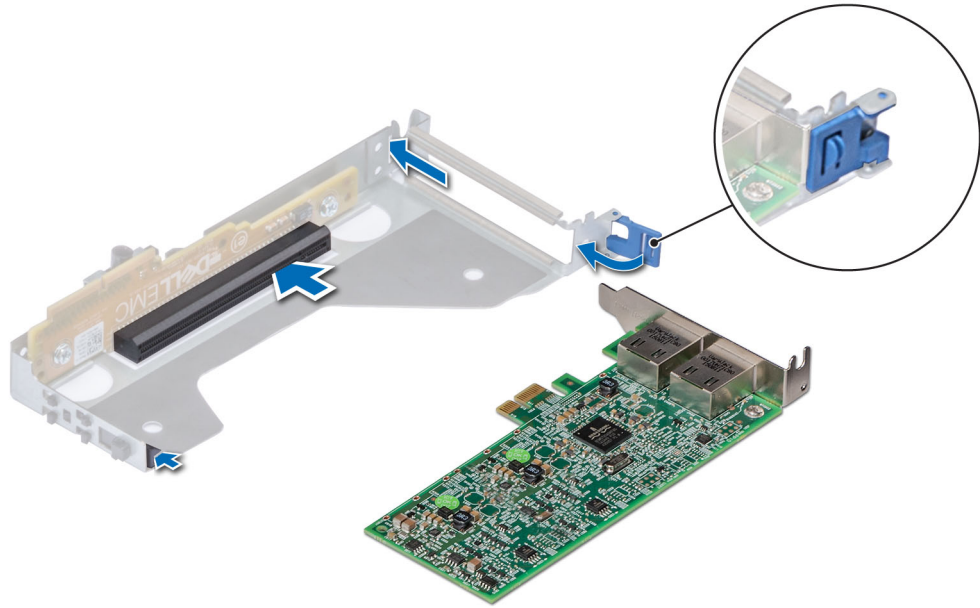


Figure 73. Installing expansion card into low profile riser

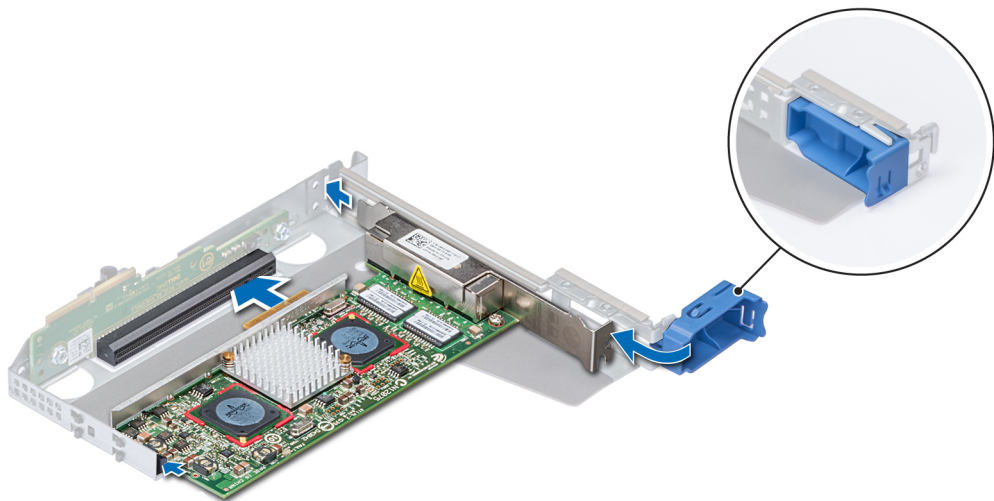
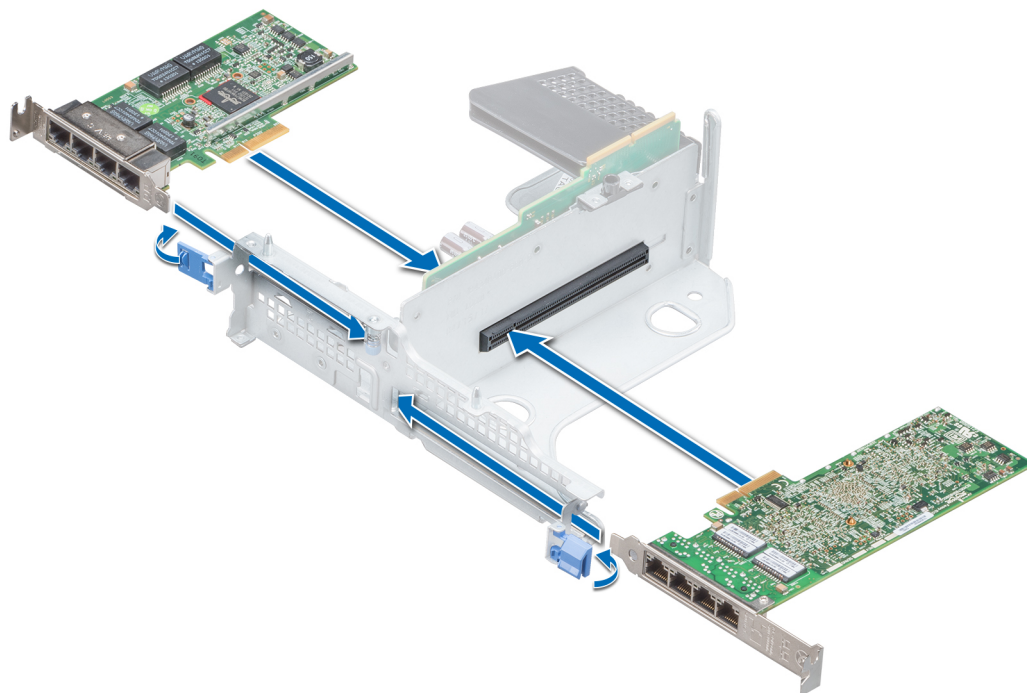


Figure 74. Installing expansion card into full height X1 riser



**Figure 75. Installing expansion card into butterfly riser**

### Next steps

1. If applicable, connect the cables to the expansion card.
2. If applicable, [install air shroud](#).
3. Follow the procedure listed in [After working inside your system](#).
4. Install any device drivers required for the card as described in the documentation for the card.

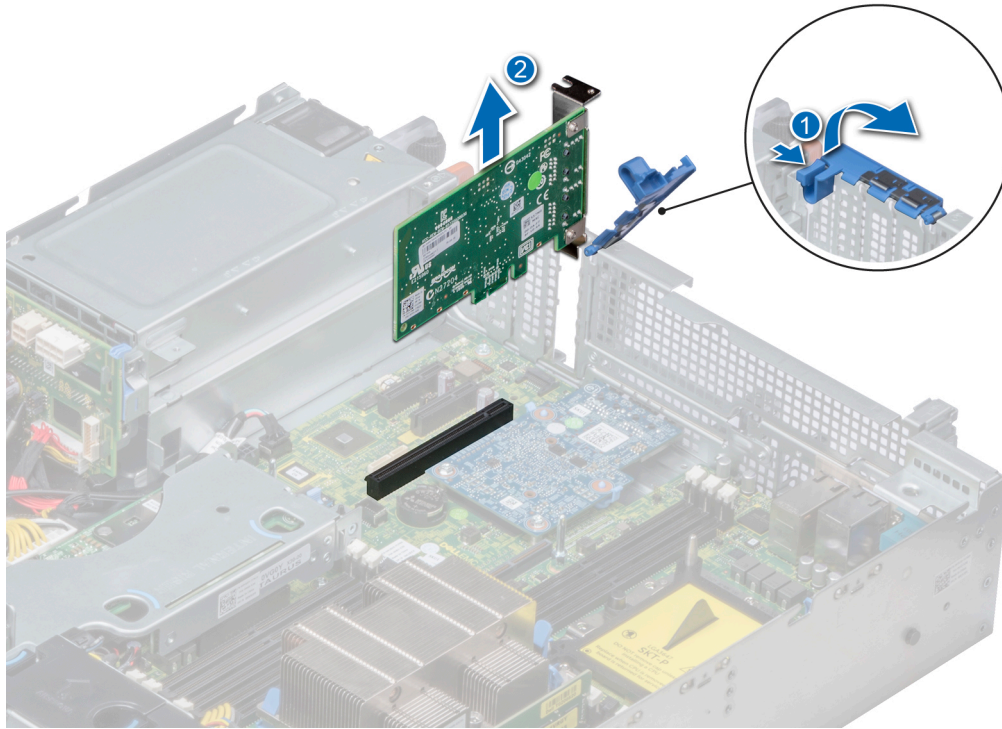
## Removing expansion card from the system board

### Prerequisites

1. Follow the safety guidelines listed in [Safety instructions](#).
2. Follow the procedure listed in [Before working inside your system](#).
3. Disconnect any cables connected to the expansion card.

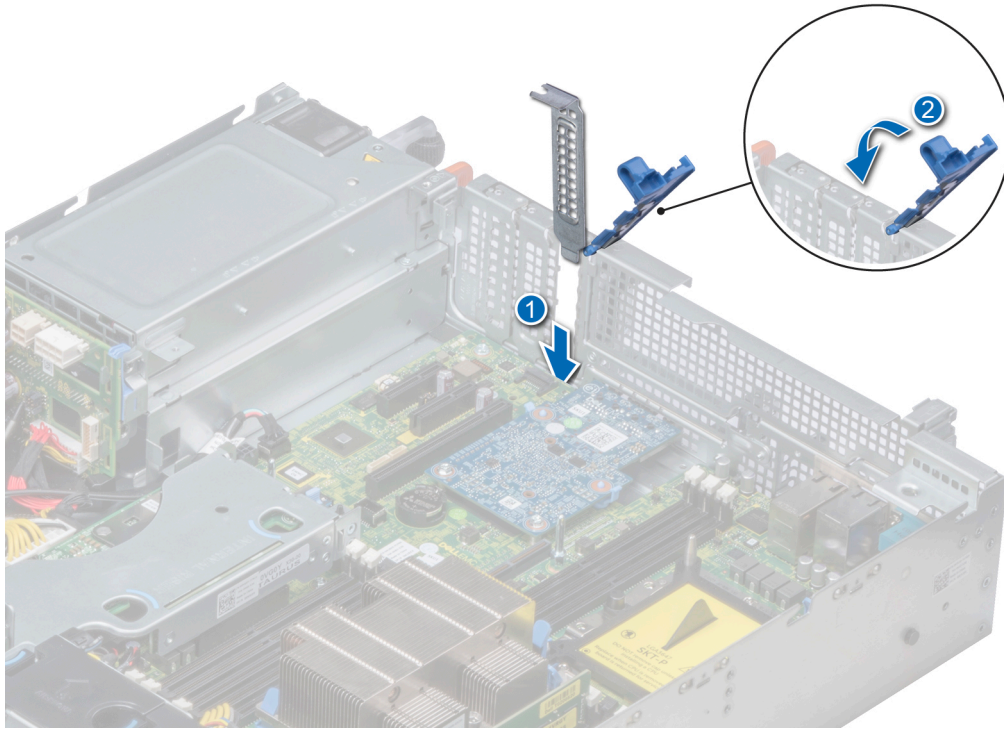
### Steps

1. Pull and lift up the expansion card retention latch lock to open.
2. Hold the expansion card by the edge and pull the card to disconnect from the system board connector.



**Figure 76. Removing expansion card from system board**

3. If the expansion card is not going to be replaced, install a filler bracket by performing the following steps:
  - a. Align the filler bracket with the slot on the system.
  - b. Push the filler bracket downward until firmly seated.
  - c. Close the expansion card retention latch by pushing the latch down until the latch snaps into place.



**Figure 77. Installing the filler bracket**

**NOTE:** Filler brackets must be installed over empty expansion card slots to maintain FCC certification of the system. The brackets also keep dust and dirt out of the system and aid in proper cooling and airflow inside the system.

### Next steps

1. [Install the expansion card on the system board](#)

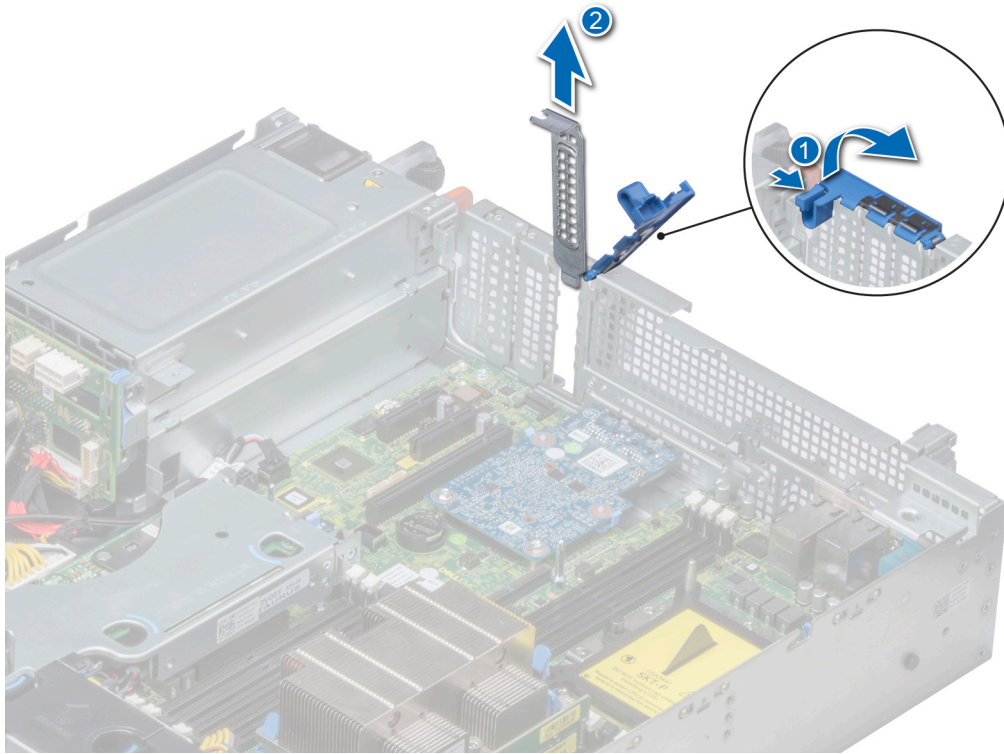
## Installing expansion card on the system board

### Prerequisites

1. Follow the safety guidelines listed in [Safety instructions](#).

### Steps

1. Unpack the expansion card and prepare it for installation.  
For instructions, see the documentation accompanying the card.
2. If you are installing a new card, remove the filler bracket.
  - a. Pull and lift up the expansion card retention latch lock to open.
  - b. Pull the filler bracket upward out of the system.

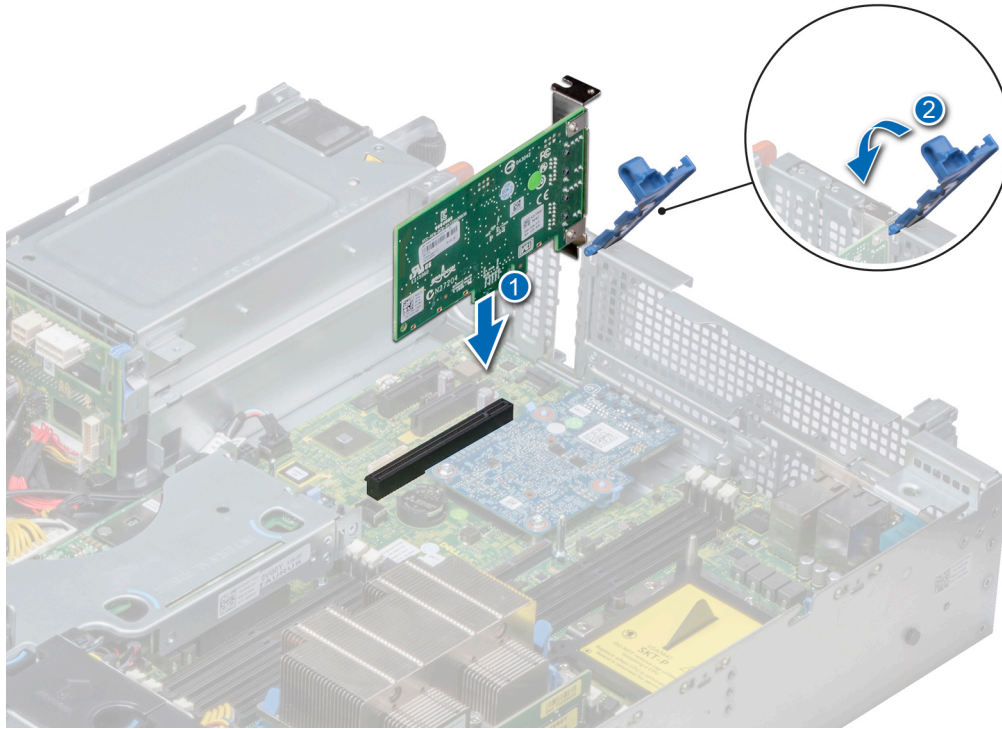


**Figure 78. Removing the filler bracket**

**i NOTE:** Store the filler bracket for future use. Filler brackets must be installed in empty expansion card slots to maintain FCC certification of the system. The brackets also keep dust and dirt out of the system and aid in proper cooling and airflow inside the system.

3. Holding the card on the edges, align the card with the expansion card connector on the system board.
4. Press the expansion card firmly into the expansion card connector on the system board until the card is fully seated.
5. Close the expansion card retention latch by pushing the latch down until the latch snaps into place.





**Figure 79. Installing expansion card on system board**

#### **Next steps**

1. Connect the required cables to the expansion card.
2. Follow the procedure listed in [After working inside your system](#).

## **Removing an expansion card riser**

#### **Prerequisites**

1. Follow the safety guidelines listed in [Safety instructions](#).
2. Follow the procedure listed in [Before working inside your system](#).
3. Disconnect any cables connected to the expansion card.

#### **Steps**

Hold the touch points, and lift the expansion card riser, from the riser connector, on the system board.

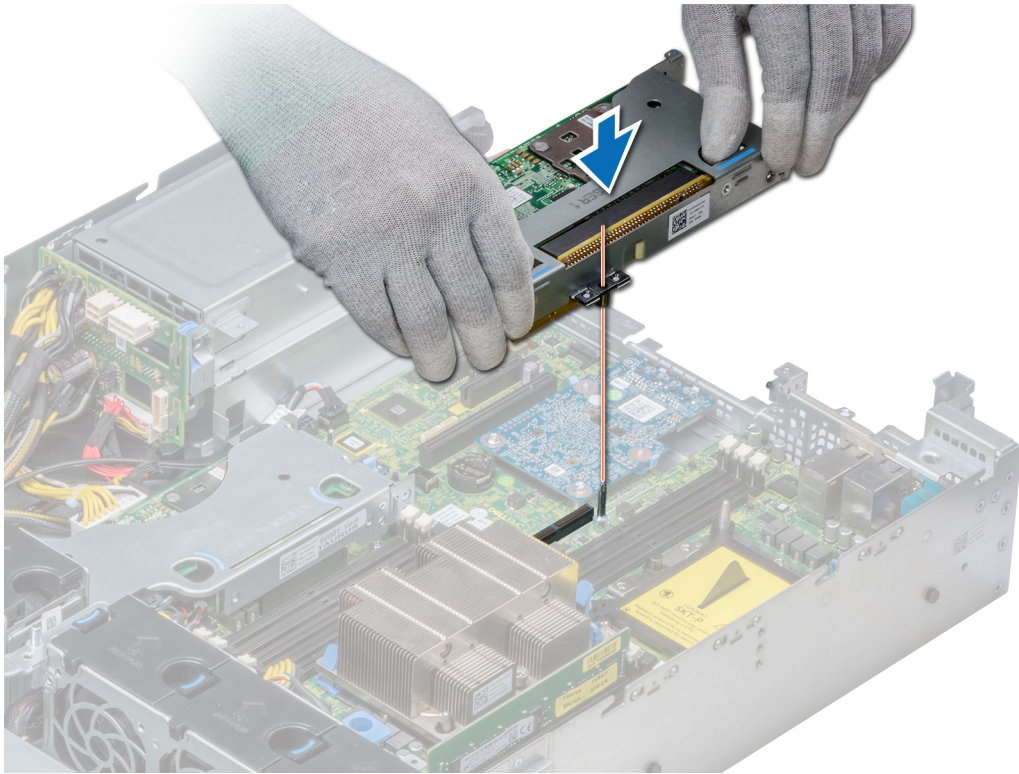


Figure 80. Removing low profile riser right

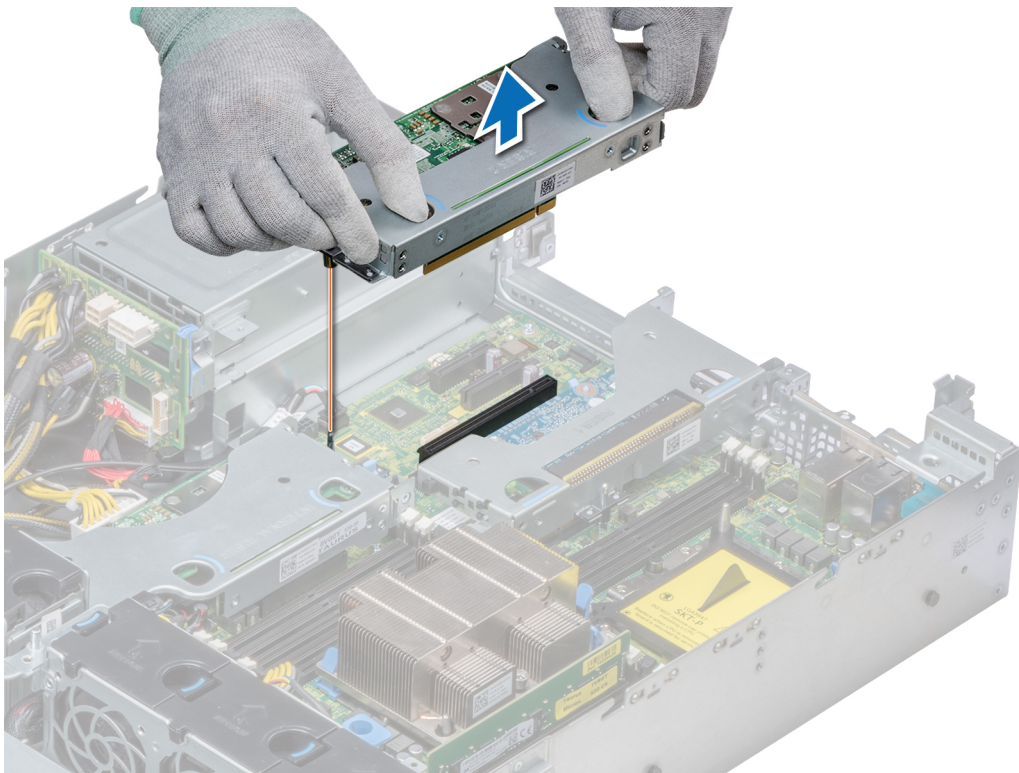
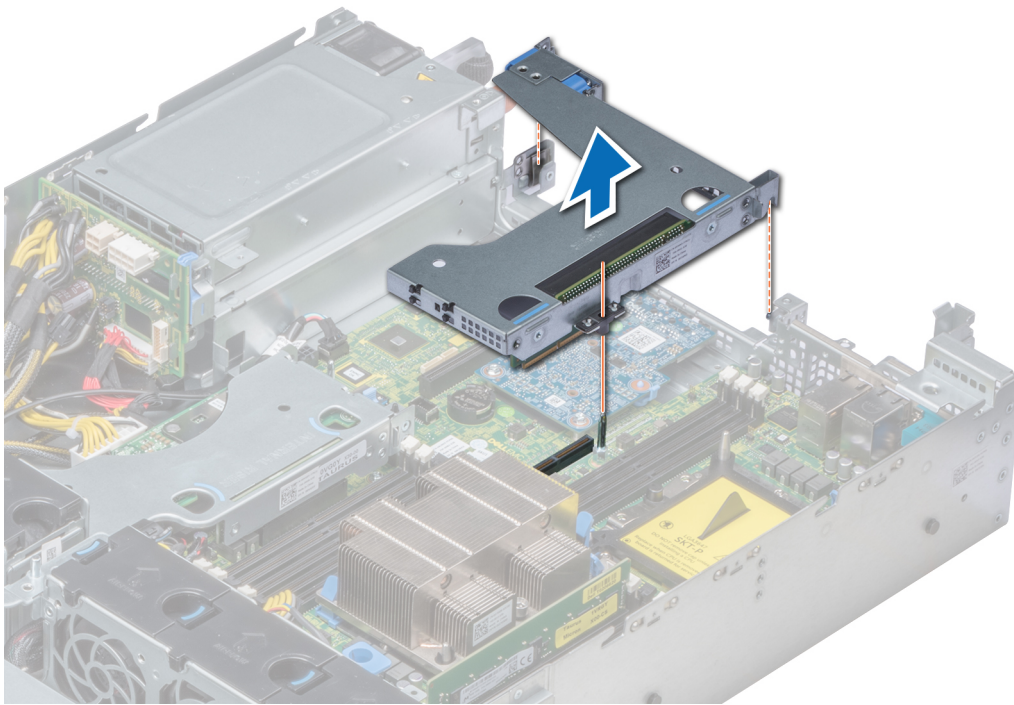
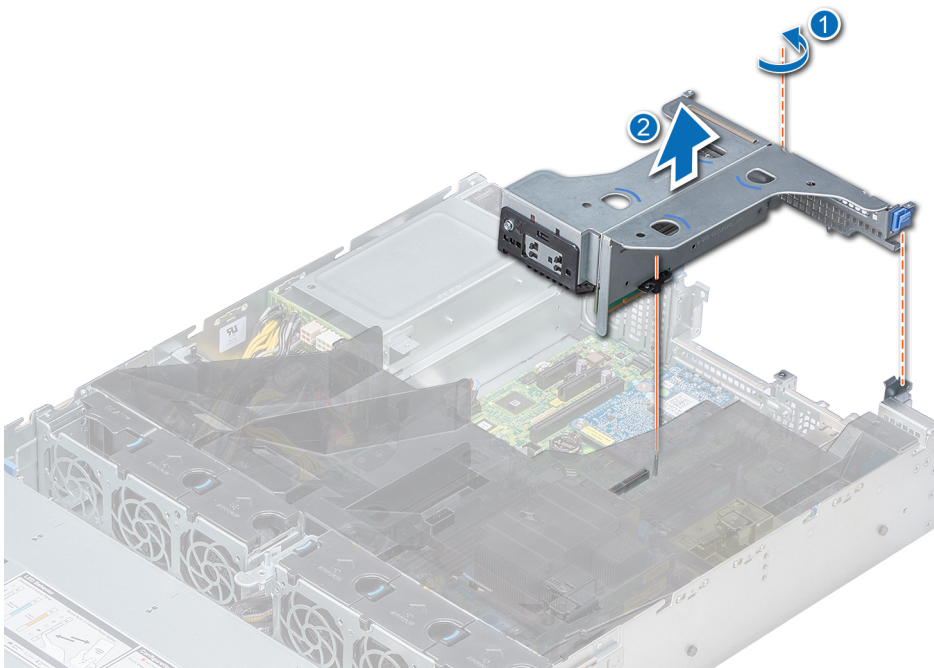


Figure 81. Removing low profile riser left



**Figure 82. Removing full height X1 riser**

**NOTE:** For butterfly riser, loosen the captive screw and holding the touch points lift the riser away from the system.



**Figure 83. Removing butterfly riser**

**Next steps**

Install the expansion card riser.

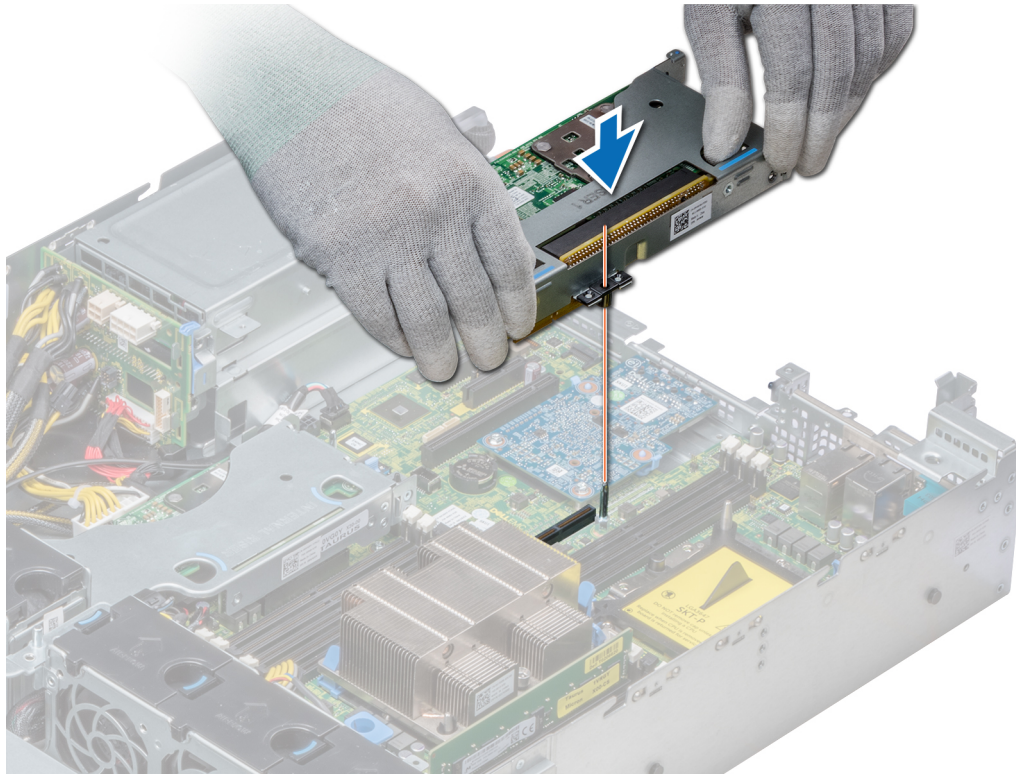
## Installing an expansion card riser

### Prerequisites

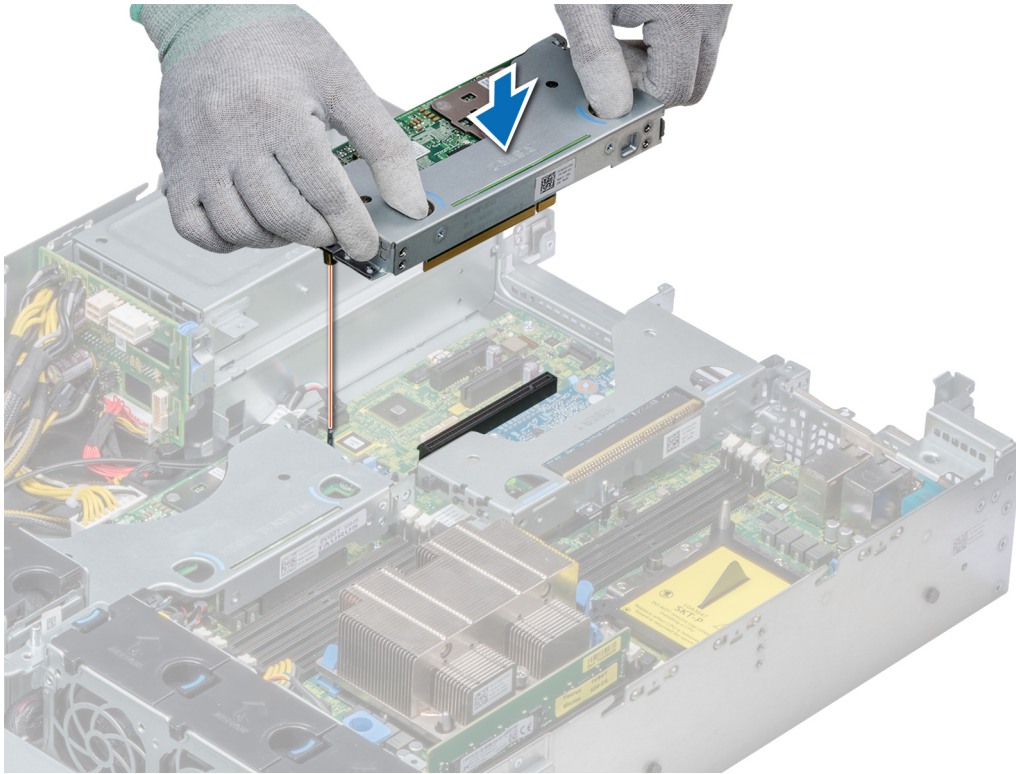
1. Follow the safety guidelines listed in [Safety instructions](#).

### Steps

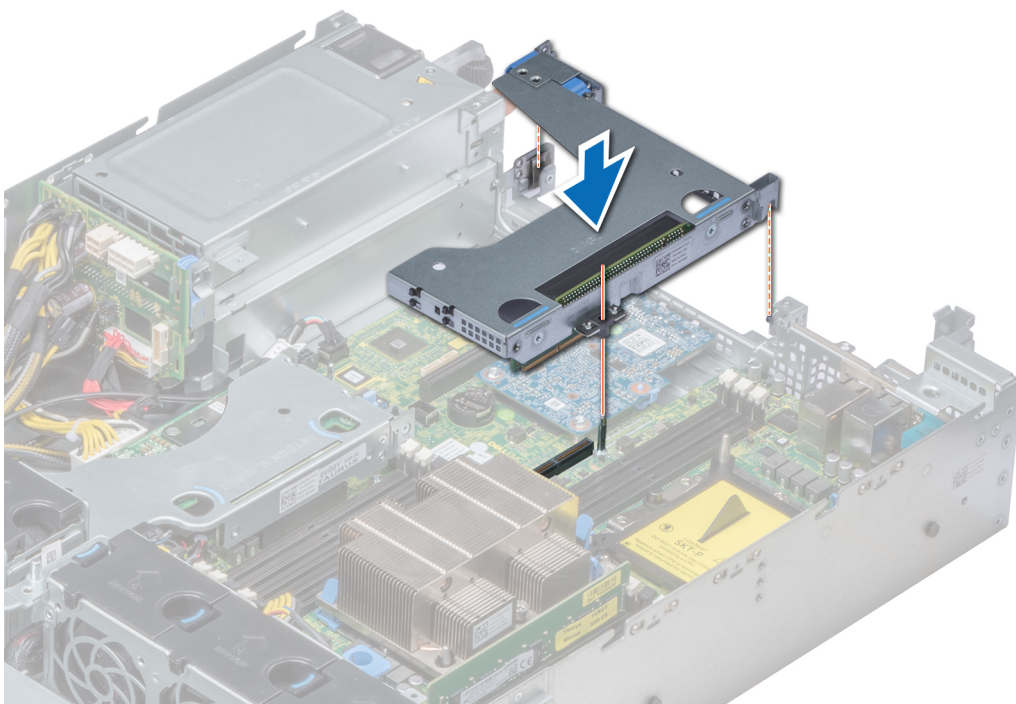
1. If removed, install the expansion cards into the expansion card riser.
2. Holding the touch points, align the expansion card riser with the connector and the riser guide pin on the system board.
3. Lower the expansion card riser into place until the expansion card riser connector is fully seated in the connector.



**Figure 84. Installing low profile riser right**

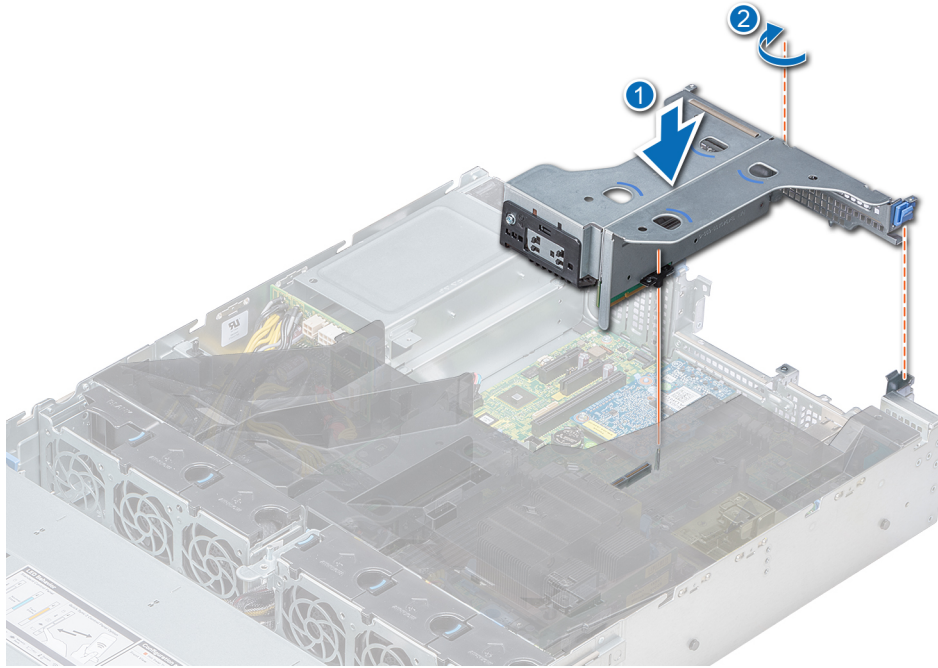


**Figure 85. Installing low profile riser left**



**Figure 86. Installing full height X1 riser**

**NOTE:** For butterfly riser, tighten the captive screw to firmly hold the riser to the system board.



**Figure 87. Installing butterfly riser**

#### Next steps

1. Follow the procedure listed in [After working inside your system](#).
2. Install any device drivers required for the card as described in the documentation for the card.

## M.2 SSD module

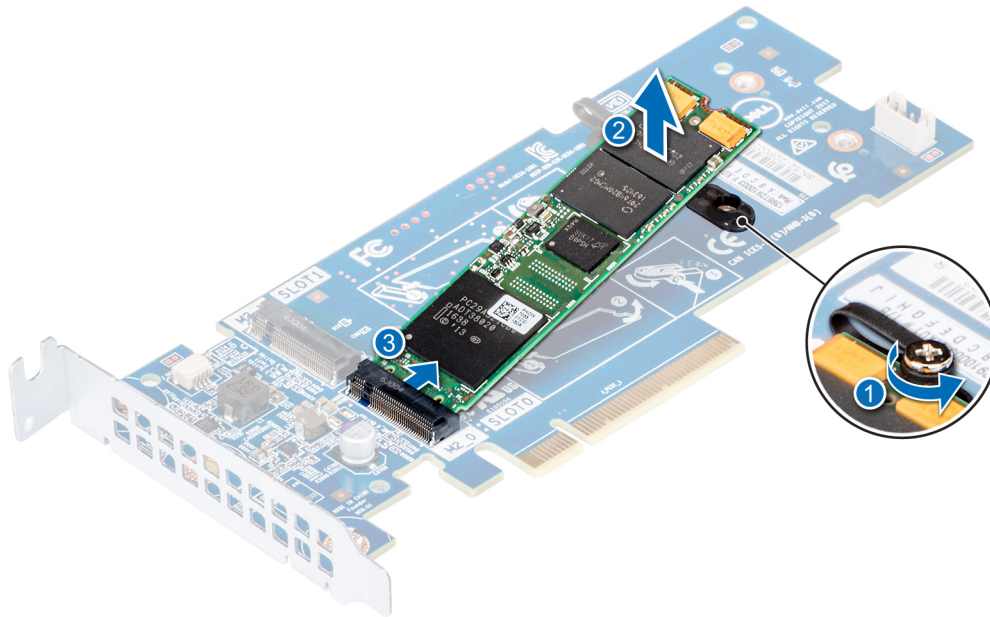
### Removing the M.2 SSD module

#### Prerequisites

1. Follow the safety guidelines listed in [Safety instructions](#).
2. Follow the procedure listed in [Before working inside your system](#).
3. [Remove the air shroud](#).
4. If installed, [remove the rear drive cage](#).
5. Remove the BOSS card.  
**i** **NOTE:** The procedure to remove the BOSS card is similar to the [removing an expansion card](#).

#### Steps

1. Loosen the screw and lift the retention strap that secures the M.2 SSD module on the BOSS card.
2. Lift the M.2 SSD module and slide it out of the connector on the BOSS card.



**Figure 88. Removing the M.2 SSD module**

### Next steps

Replace the M.2 SSD module.

## Installing the M.2 SSD module

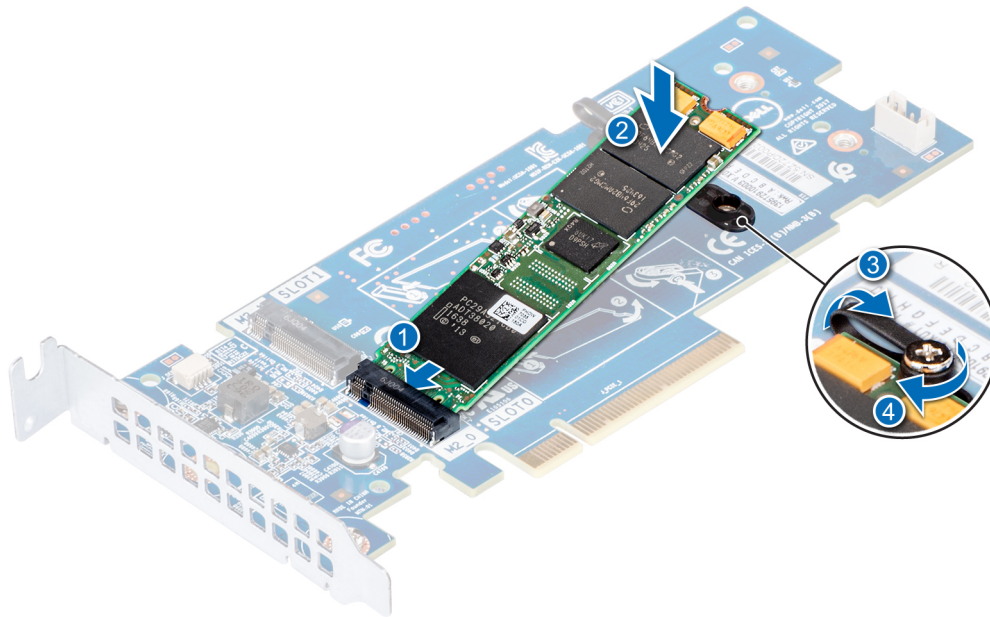
### Prerequisites

1. Follow the safety guidelines listed in [Safety instructions](#).
2. Follow the procedure listed in [Before working inside your system](#).
3. [Remove the air shroud](#).
4. [Remove the BOSS card](#)

**NOTE:** The procedure to remove the BOSS card is similar to the [removing an expansion card](#).

### Steps

1. Connect the M.2 SSD module to the connector on the BOSS card.
2. Place the retention strap on the M.2 SSD module, and tighten the screw to secure the module.



**Figure 89. Installing the M.2 SSD module**

#### Next steps

1. Install the BOSS card.  
**i** **NOTE:** The procedure to install the BOSS card is similar to the [Installing expansion card on the system board](#).
2. [Install the applicable air shroud](#).
3. Follow the procedure listed in [After working inside your system](#).

## Optional MicroSD or vFlash card

### Removing the MicroSD card

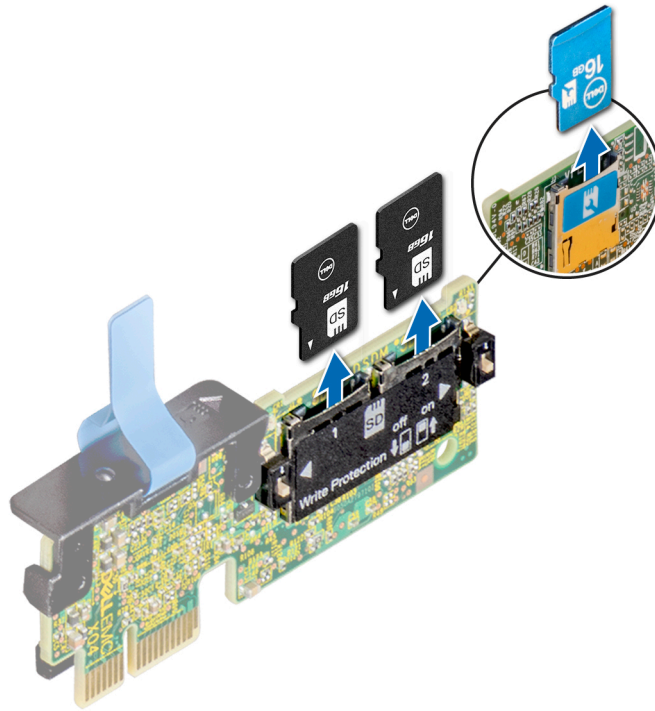
#### Prerequisites

1. Follow the safety guidelines listed in [Safety instructions](#).
2. Follow the procedure listed in [Before working inside your system](#).

#### Steps

1. Locate the MicroSD card slot on the vFlash/IDSDM module, and press the card to partially release it from the slot. To locate IDSDM/vFlash module, see the [System board jumpers and connectors](#) section.
2. Hold the MicroSD card and remove it from the slot.





**Figure 90. Removing the MicroSD card**

**NOTE:** Temporarily label each MicroSD card with its corresponding slot number after removal.

#### Next steps

1. Follow the procedure listed in [After working inside your system](#).
2. [Installing the MicroSD card](#)

## Installing the MicroSD card

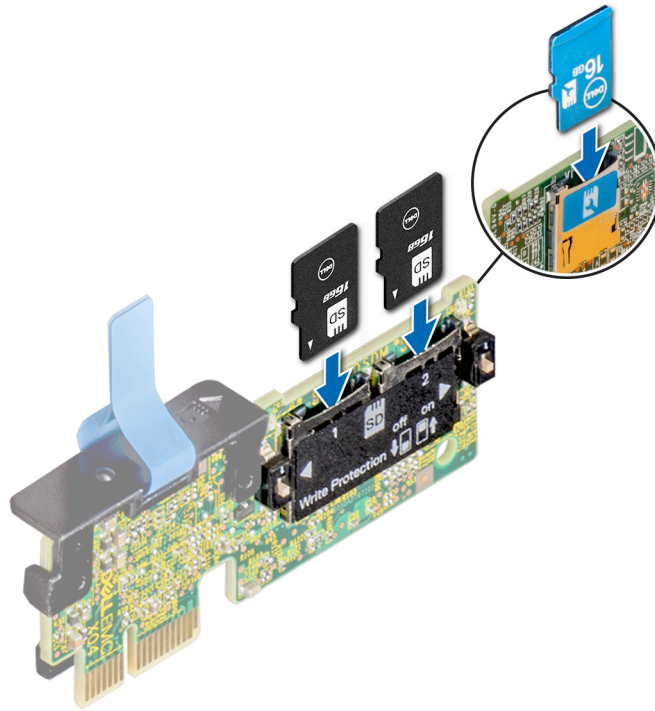
#### Prerequisites

Follow the safety guidelines listed in [Safety instructions](#).

- NOTE:** To use an MicroSD card with your system, ensure that the **Internal SD Card Port** is enabled in System Setup.
- NOTE:** If reinstalling, ensure that you install the MicroSD cards into the same slots based on the labels you had marked on the cards during removal.

#### Steps

1. Locate the MicroSD card connector on the IDSDM/vFlash module. Orient the MicroSD card appropriately and insert the contact-pin end of the card into the slot. To locate IDSDM/vFlash, see the [System board jumpers and connectors](#) section.  
**NOTE:** The slot is keyed to ensure correct insertion of the card.
2. Press the card into the card slot to lock it into place.



**Figure 91. Installing the MicroSD card**

#### **Next steps**

Follow the procedure listed in [After working inside your system](#).

## **Optional IDSDM or vFlash module**

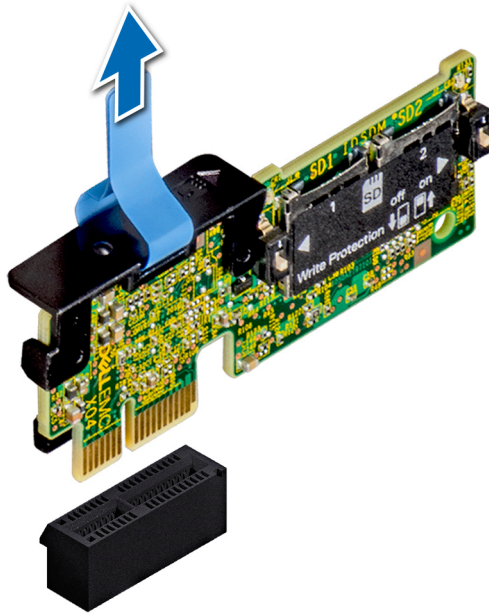
### **Removing the optional IDSDM or vFlash card**

#### **Prerequisites**

1. Follow the safety guidelines listed in [Safety instructions](#).
2. Follow the procedure listed in [Before working inside your system](#).

#### **Steps**

1. Locate the IDSDM/vFlash connector on the system board.  
To locate IDSDM/vFlash connector, see the [System board jumpers and connectors](#) section.
2. Holding the pull tab, lift the IDSDM/vFlash card out of the system.



**Figure 92. Removing the optional IDSDM/vFlash card**

**NOTE:** There are two dip switches on the IDSDM/vFlash card for write-protection.

### Next steps

Installing optional IDSDM or vFlash card

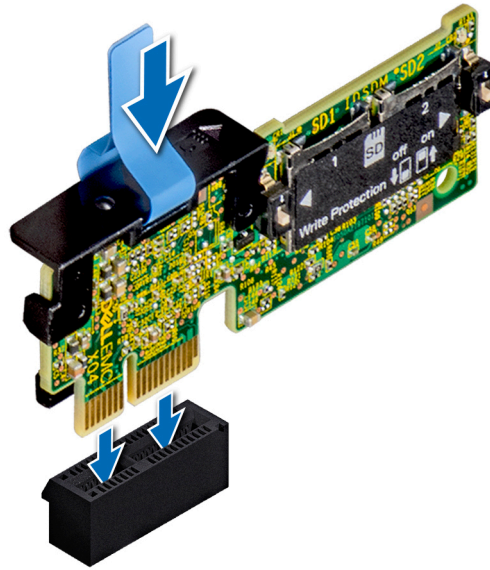
## Installing optional IDSDM or vFlash card

### Prerequisites

Follow the safety guidelines listed in [Safety instructions](#).

### Steps

1. Locate the IDSDM/vFlash connector on the system board.  
To locate IDSDM/vFlash connector, see the [System board jumpers and connectors](#) section.
2. Align the IDSDM/vFlash card with the connector on the system board.
3. Push the IDSDM/vFlash card until it is firmly seated on the system board.



**Figure 93. Installing optional IDSDM/vFlash card**

### Next steps

1. Install the MicroSD cards.  
**NOTE:** Reinstall the MicroSD cards into the same slots based on the labels you had marked on the cards during removal.
2. Follow the procedure listed in [After working inside your system](#).

## LOM riser card

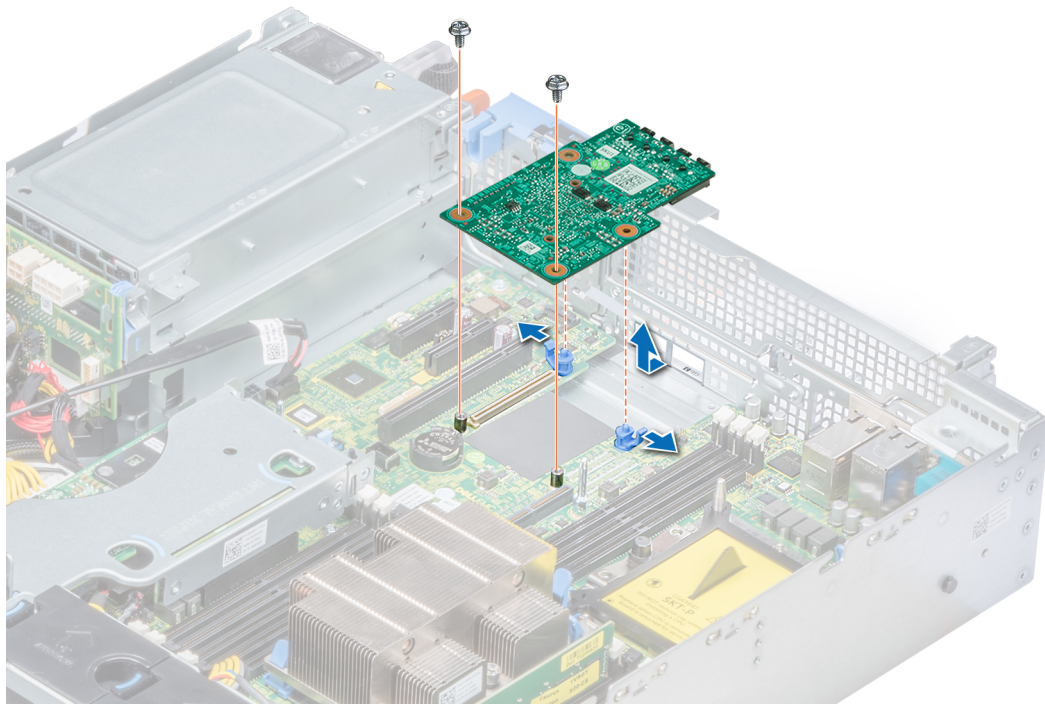
### Removing the LOM riser card

#### Prerequisites

1. Follow the safety guidelines listed in [Safety instructions](#).
2. Follow the procedure listed in [Before working inside your system](#).
3. If installed, [remove the risers](#).
4. If installed, [remove the rear drive cage](#).

#### Steps

1. Using a Phillips #2 screwdriver, loosen the screws that secure the LOM riser card to the system board.
2. Release the two blue side plastic snaps holding the LOM riser card.
3. Hold the LOM riser card by the edges on either side, and lift to remove it from the connector on the system board.
4. Slide the LOM riser card towards the front of the system until the Ethernet connectors or the Small form-factor pluggable (SFP) are clear of the slot in the back of the system.



**Figure 94. Removing LOM riser card**

### **Next steps**

Installing the LOM riser card

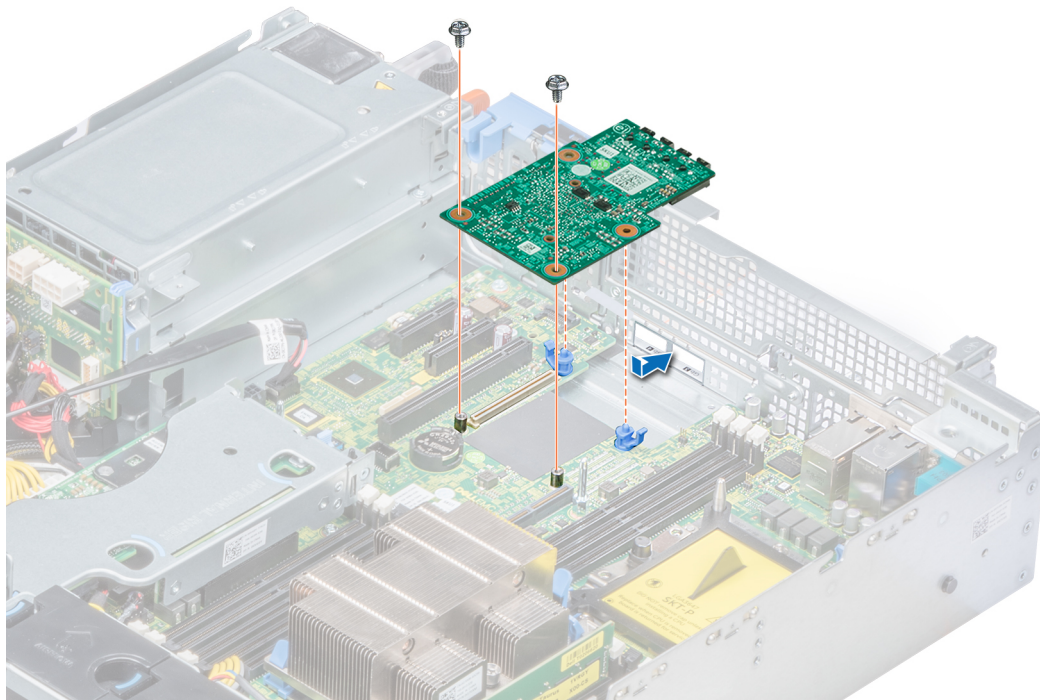
## **Installing the LOM riser card**

### **Prerequisites**

Follow the safety guidelines listed in [Safety instructions](#).

### **Steps**

1. Align the connectors on the LOM riser card with the slot on the system.
2. Press the LOM riser card until the card is firmly seated on the system board connector and the two blue plastic snap hold the LOM riser card in place.
3. Using a Phillips #2 screwdriver, replace the screws to secure the LOM riser card to the system board.



**Figure 95. Installing LOM riser card**

**Next steps**

1. If removed, [install the risers](#).
2. If removed, [install the rear drive cage](#).
3. Follow the procedure listed in [After working inside your system](#).

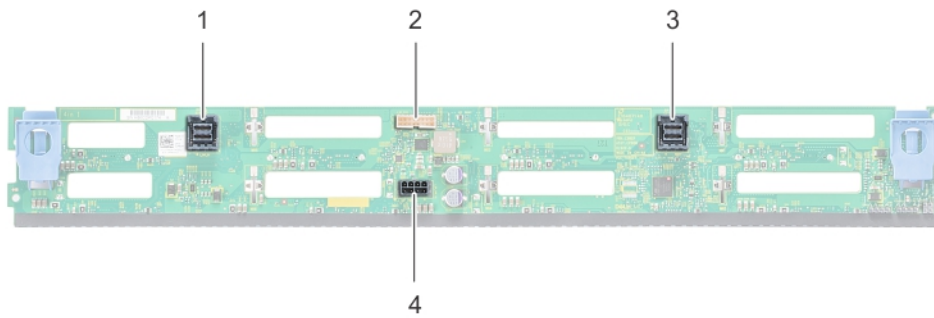
## Drive backplane

### Backplane details

Depending on your system configuration, the drive backplanes supported in PowerEdge R540 are listed here:

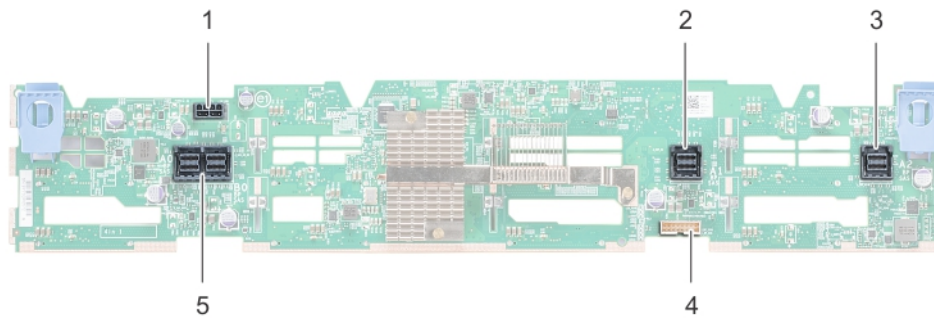
**Table 29. Supported backplane options for PowerEdge R540 systems**

System	Supported hard drives options
PowerEdge R540	3.5 inch (x8) SAS, SATA backplane 3.5 inch (x12) SAS or SATA backplane and 3.5 inch (x2) SAS or SATA backplane (rear)



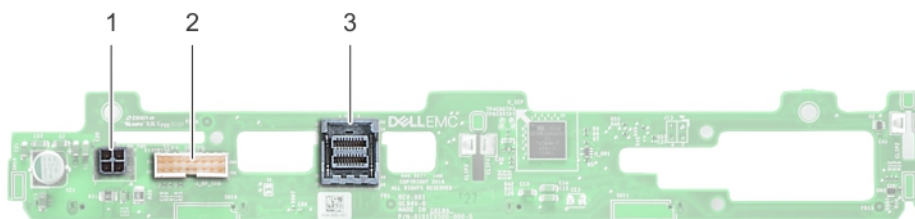
**Figure 96. 8 X 3.5 inch drive backplane**

- 1. SAS/SATA B cable connector
- 2. Signal connector
- 3. SAS/SATA A cable connector
- 4. Power connector



**Figure 97. 12 X 3.5 inch drive backplane**

- 1. Power cable connector
- 2. SAS/SATA cable connector
- 3. SAS/SATA cable connector
- 4. Backplane signal connector
- 5. SAS cable connector






**Figure 98. 2 x 3.5 inch drive backplane (rear)**

- 1. Power connector
- 2. Signal connector
- 3. SAS cable connector

# Removing the backplane

## Prerequisites

-  **CAUTION:** To prevent damage to the drives and backplane, remove the drives from the system before removing the backplane.
-  **CAUTION:** Note the number of each drive and temporarily label them before you remove the drive so that you can replace them in the same location.
-  **NOTE:** The procedure to remove the backplane is similar for all backplane configurations.

1. Follow the safety guidelines listed in [Safety instructions](#).
2. Follow the procedure listed in [Before working inside your system](#).
3. [Remove the air shroud](#).
4. [Remove the backplane cover](#).
5. [Remove all the drives](#) from the hard-drive slots from the front of the system.
6. Disconnect all the cables from the backplane.

## Steps

Press the blue release tabs and lift the backplane to disengage the backplane from the hooks on the system.

**Figure 99. Removing backplane**



**Figure 100. Removing backplane**

## Next steps

[Install the backplane.](#)



## Installing the backplane

### Prerequisites

Follow the safety guidelines listed in [Safety instructions](#).

**NOTE:** The procedure to install the backplane is similar for all backplane configurations.

### Steps

1. Use the hooks on the system as guides to align the slots on the backplane with the guides on the system.
2. Lower the drive backplane until the blue release tabs snap into place.



**Figure 101. Installing the backplane**

### Next steps

1. Connect all the cables to the backplane.
2. [Install all the drives.](#)
3. [Install the backplane cover.](#)
4. [Install the air shroud](#)
5. Follow the procedure listed in [After working inside your system](#).

## Removing the 3.5-inch rear drive backplane

### Prerequisites

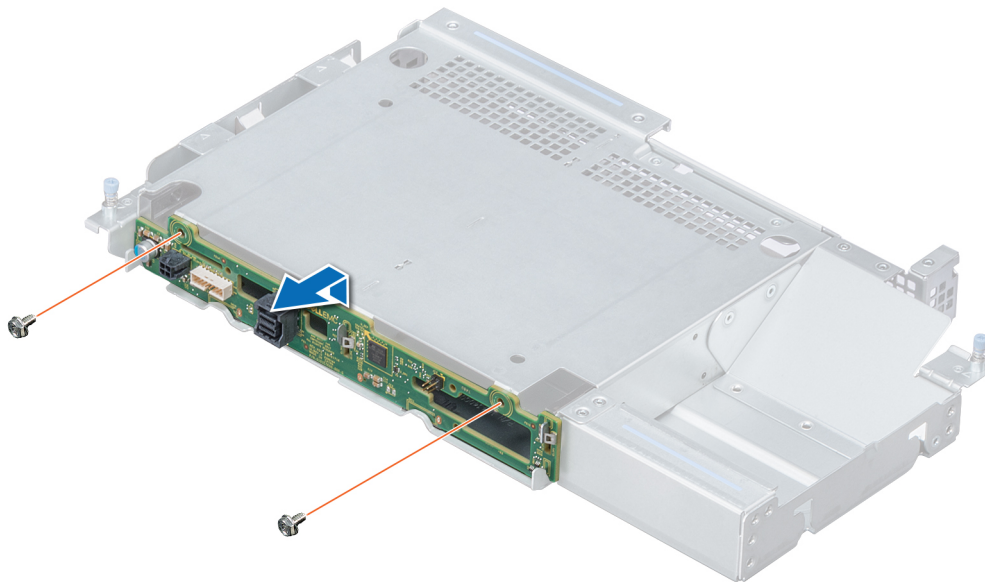
**CAUTION:** To prevent damage to the drives and backplane, you must remove the drives from the system before removing the backplane.

**CAUTION:** You must note the number of each hard drive and temporarily label them before removal so that you can replace them in the same locations.

1. Follow the safety guidelines listed in [Safety instructions](#).
2. Follow the procedure listed in [Before working inside your system](#).
3. Remove all the drives from the rear drive cage.
4. Disconnect all the cables from the backplane.
5. [Remove the rear drive cage](#).

### Steps

1. Using Phillips #2 screwdriver, remove the screws that secure the drive backplane to the rear drive cage.
2. Disengage the backplane from the hooks on the rear drive cage, and remove it from the rear drive cage.



**Figure 102. Removing 3.5-inch rear drive backplane**

### Next steps

Install the [3.5-inch rear drive backplane](#).

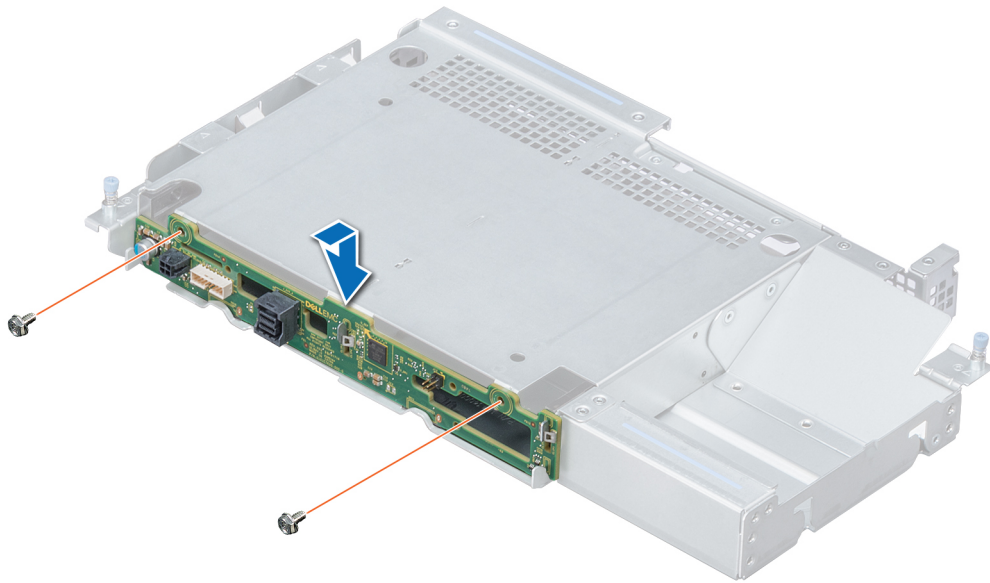
## Installing the 3.5-inch rear drive backplane

### Prerequisites

Follow the safety guidelines listed in [Safety instructions](#).

### Steps

1. Use the hooks on the rear drive cage as guides to align the drive backplane.
2. Lower the backplane into the system until it is firmly seated.
3. Using Phillips #2 screwdriver, replace the screws to secure the backplane to the rear drive cage.

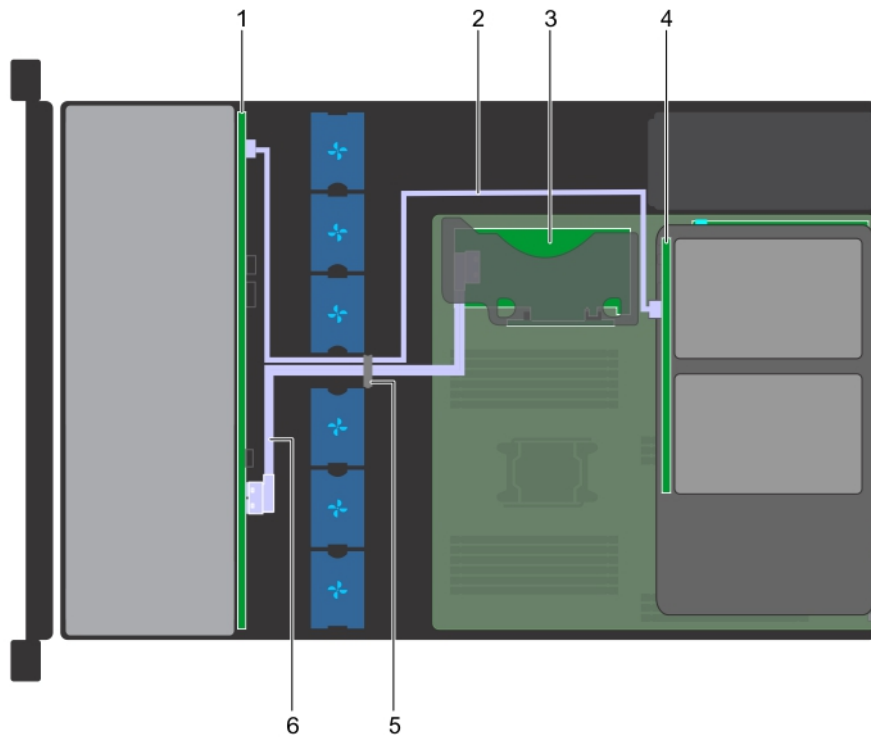


**Figure 103. Installing 3.5-inch rear drive backplane**

**Next steps**

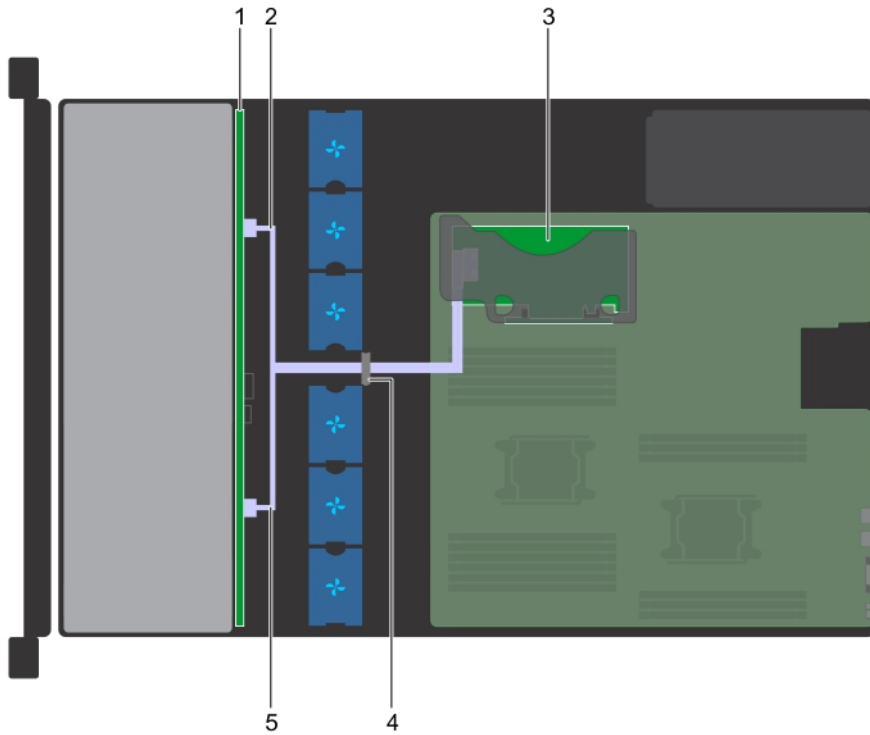
1. [Install the rear drive cage.](#)
2. [Install all the drives.](#)
3. Connect all the cables to the backplane.
4. Follow the procedure listed in [After working inside your system.](#)

## Cable routing



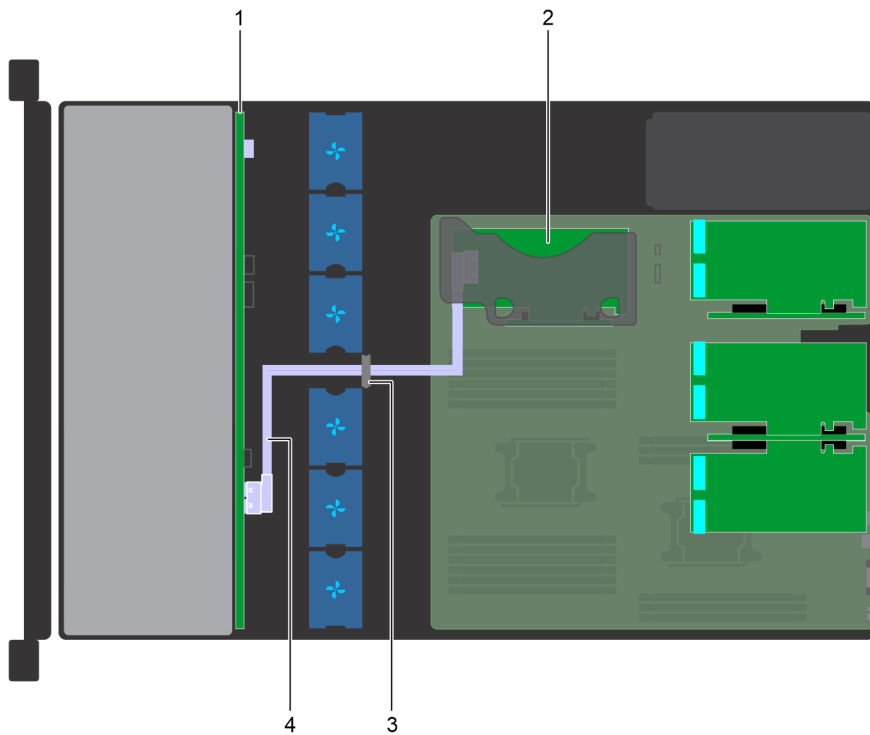
**Figure 104. Cable routing - 12 x 3.5-inch drive backplane and 2 x 3.5-inch rear drive backplane with internal PERC riser**

- |                        |   |
|------------------------|---|
| 1. Drive backplane     | 2. SAS cable (BP: SAS A2 to rear drive backplane)   |
| 3. Internal PERC       | 4. Drive backplane (rear)                           |
| 5. Cable guiding latch | 6. SAS cable (BP: SAS A0/B0 to internal PERC riser) |



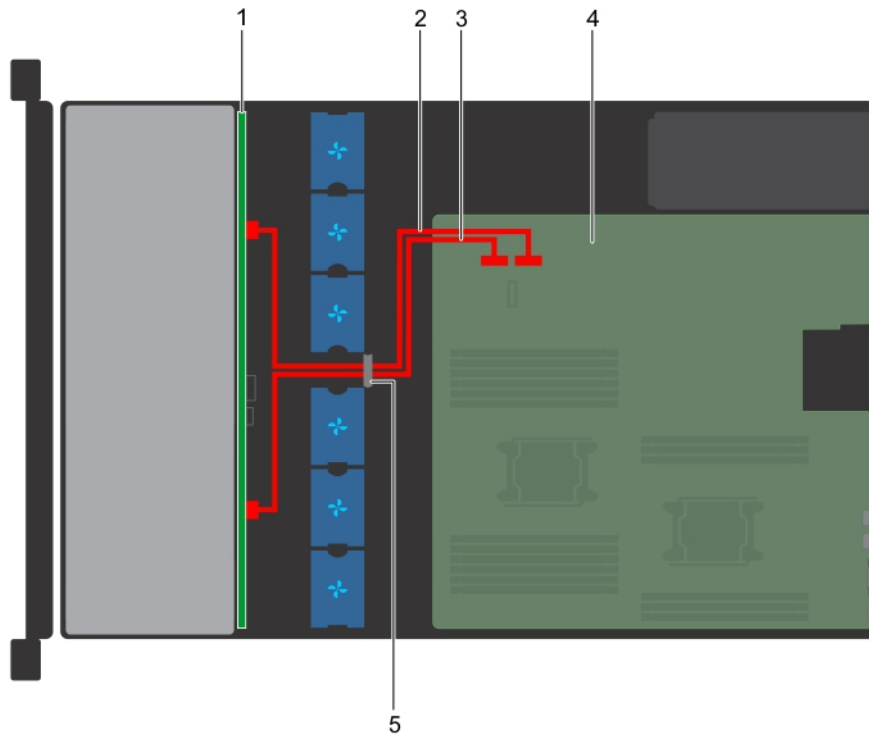
**Figure 105. Cable routing - 8 x 3.5-inch drive backplane with internal PERC riser**

- |   |   |
|---|---|
| 1. Drive backplane                                      | 2. SATA cable (BP: BP_A to internal PERC riser: SATA_A) |
| 3. Internal PERC  | 4. Cable guiding latch                                  |
| 5. SATA cable (BP: BP_B to internal PERC riser: SATA_B) |   |



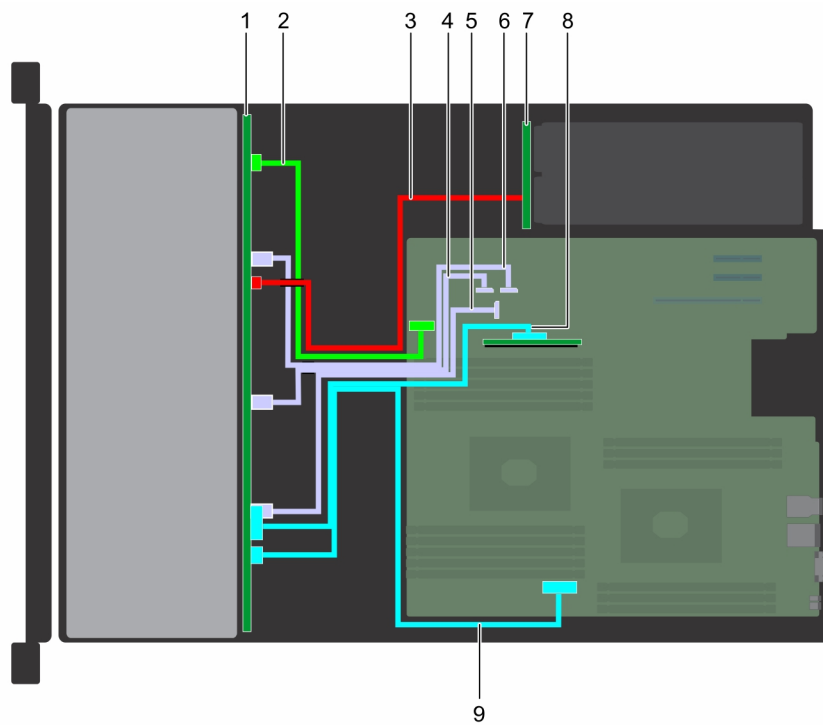
**Figure 106. Cable routing - 12 x 3.5-inch drive backplane with internal PERC riser**

- |                        |   |
|------------------------|---|
| 1. Drive backplane     | 2. Internal PERC                                    |
| 3. Cable guiding latch | 4. SAS cable (BP: SAS A0/B0 to internal PERC riser) |



**Figure 107. Cable routing - 8 x 3.5-inch drive backplane**

- |  |  |
|--|--|
| 1. Drive backplane                       | 2. SATA A cable (BP: BP_A to MB: SATA_A) |
| 3. SATA B cable (BP: BP_B to MB: SATA_B) | 4. System board                          |
| 5. Cable guiding latch                   |  |



**Figure 108. Cable routing - 2 x 3.5-inch Hybrid backplane with NVMe U.2 SSD**

- |  |  |
|--|--|
| 1. drive backplane                     | 2. backplane signal cable (BP:BP_SIG1 to MB:BP_SIG1) |
| 3. backplane power cable               | 4. SATA cable (BP:BP_B0 to MB SATA_B1)               |
| 5. SATA cable (BP:BP_C0 to MB SATA_C1) | 6. SATA cable (BP:BP_A0 to MB SATA_A1)               |
|  | 7. backplane signal cable (BP:BP_SIG2 to MB:BP_SIG2) |
|  | 8. backplane power cable                             |
|  | 9. SATA cable (BP:BP_D0 to MB SATA_D1)               |

7. Power interposer board (PIB)
9. PCIe cable (BP:BP PCIe A0 to MB PCIe\_A0)

8. PCIe cable (BP:BP PCIe B0 to MB Interposer\_A)

## Rear drive cage

### Removing the rear drive cage

#### Prerequisites

1. Follow the safety guidelines listed in [Safety instructions](#).
2. Follow the procedure listed in [Before working inside your system](#).
3. [Remove all the drives](#).
4. Disconnect all the cables from the rear drive backplane.

#### Steps

1. Using Phillips #2 screwdriver, loosen the screws that secure the drive cage to the system.
2. Pull and hold the screws to lift the drive cage away from the system.

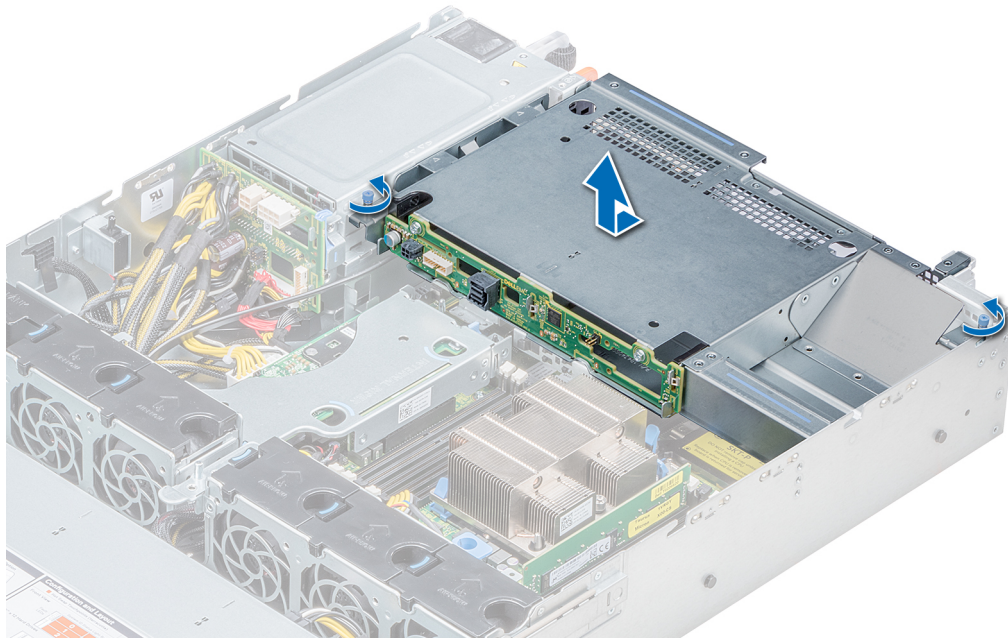


Figure 109. Removing the rear drive cage

#### Next steps

[Install the rear drive cage](#).

### Installing the rear drive cage

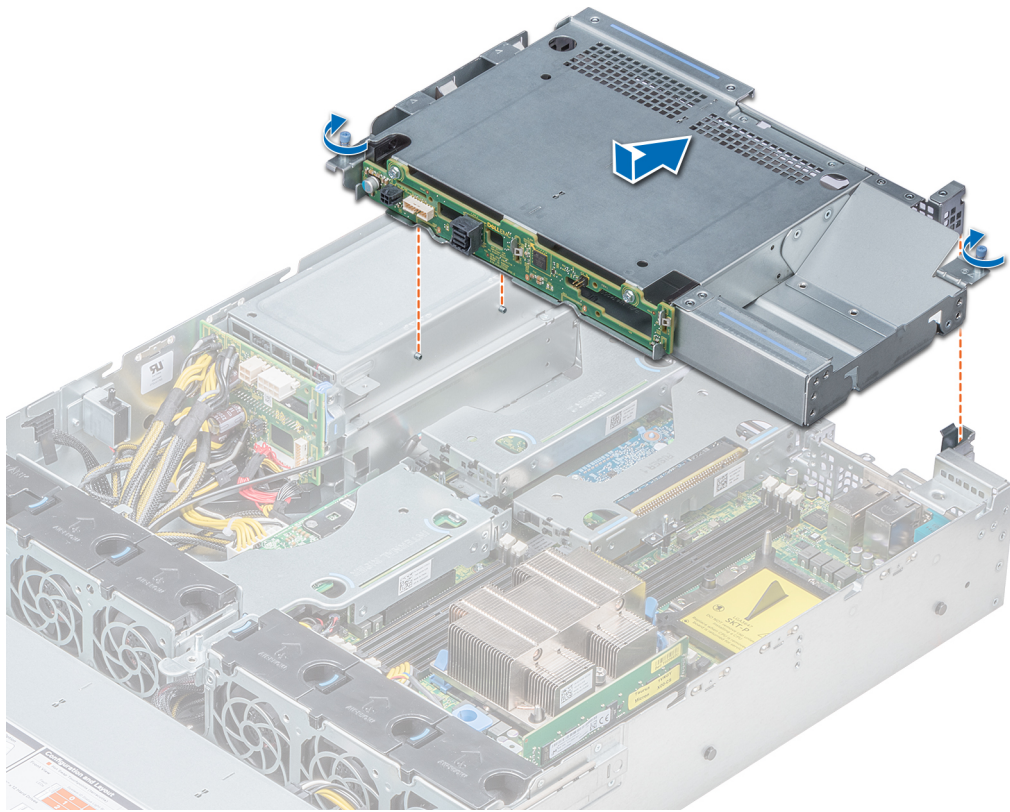
#### Prerequisites

Follow the safety guidelines listed in [Safety instructions](#).

#### Steps

1. Align the screws on the drive cage with the screw holes on the system chassis.

2. Lower the drive cage into the system until it is firmly seated and the screws locks into place.
3. Using Phillips #2 screwdriver, tighten the screws.



**Figure 110. Installing the rear drive cage**

#### Next steps

1. Reconnect all the disconnected cables to the rear drive backplane.
2. [Install all the drives.](#)
3. Follow the procedure listed in [After working inside your system.](#)

## System battery

The Dell EMC PowerEdge R540 system supports CR 2032 3.0-V lithium coin cell system battery.

## Replacing the system battery

#### Prerequisites

**⚠ WARNING:** There is a danger of a new battery exploding if it is incorrectly installed. Replace the battery only with the same or equivalent type recommended by the manufacturer. For more information, see the safety information that shipped with your system.

1. Follow the safety guidelines listed in [Safety instructions.](#)
2. Follow the procedure listed in [Before working inside your system.](#)
3. If applicable, disconnect the power or data cables from expansion card(s).
4. If installed, [remove the low profile or full height X1 expansion card risers.](#)

#### Steps

1. Locate the battery socket. For more information, see the [System board jumpers and connectors.](#)



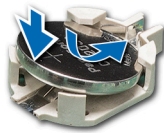
**CAUTION:** To avoid damage to the battery connector, you must firmly support the connector while installing or removing a battery.

2. Use a plastic scribe to pry out the system battery.



**Figure 111. Removing the system battery**

3. To install a new system battery, hold the battery with the positive side facing up and slide it under the securing tabs.
4. Press the battery into the connector until it snaps into place.



**Figure 112. Installing the system battery**

#### Next steps

1. If removed, [Install the low profile or full height X1 expansion card risers](#).
2. If applicable, connect the cables to the expansion card(s).
3. Follow the procedure listed in [After working inside your system](#).
4. While booting, press F2 to enter the System Setup and ensure that the battery is operating properly.
5. Enter the correct time and date in the System Setup **Time** and **Date** fields.
6. Exit the System Setup.

## Optional internal USB memory key

### Replacing the optional internal USB memory key

#### Prerequisites

**CAUTION:** To avoid interference with other components in the server, the maximum permissible dimensions of the USB memory key are 15.9 mm wide x 57.15 mm long x 7.9 mm high.

1. Follow the safety guidelines listed in [Safety instructions](#).
2. Follow the procedure listed in [Before working inside your system](#).
3. If installed, [remove the low profile expansion card riser](#).

#### Steps

1. Locate the USB port or USB memory key on the system board.  
To locate the USB port, see the [System board jumpers and connectors](#).
2. If installed, remove the USB memory key from the USB port.

3. Insert the replacement USB memory key into the USB port.

#### Next steps

1. If removed, [Install the low profile expansion card riser](#).
2. Follow the procedure listed in [After working inside your system](#).
3. While booting, press F2 to enter **System Setup** and verify that the system detects the USB memory key.

## Optical drive (optional)

### Removing the optical drive

#### Prerequisites

1. Follow the safety guidelines listed in [Safety instructions](#).
2. Follow the procedure listed in [Before working inside your system](#).
3. If applicable, [remove the front bezel](#).
4. Disconnect the power and data cables from the connectors on the optical drive.  
**i** **NOTE:** Ensure that you note the routing of the power and data cable on the side of the system and drive. Route these cables properly when you replace them to prevent them from being pinched or crimped.

#### Steps

1. Press the release tab to release the optical drive.
2. Slide the optical drive out of the system until it is out of the optical drive slot.
3. If you are not adding a new optical drive, install the optical drive blank. The procedure to install the optical drive blank is the same as the optical drive.

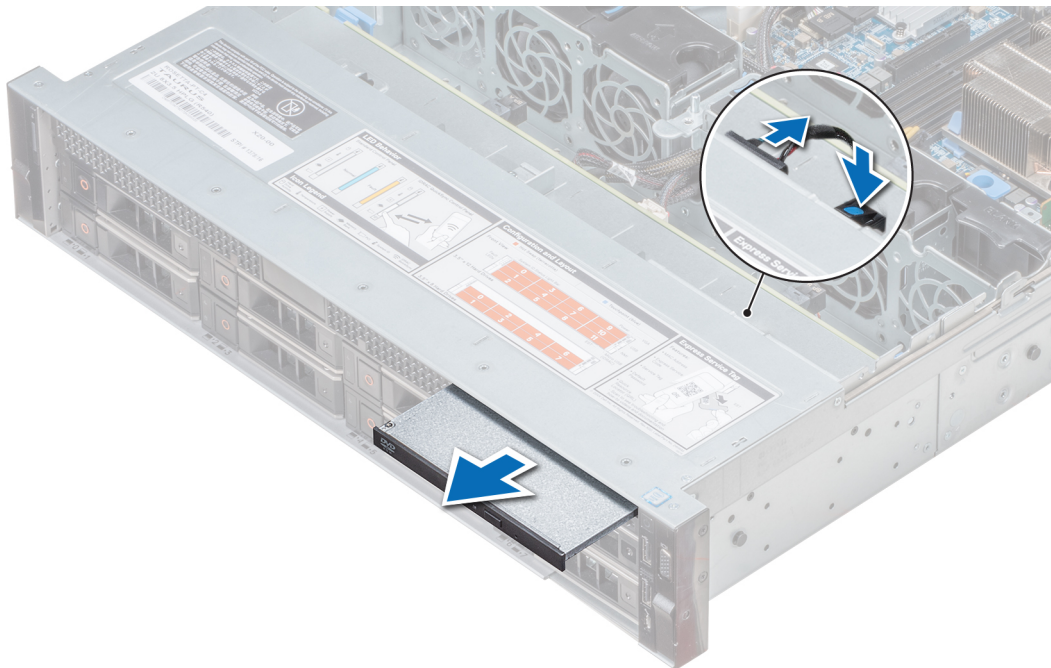


Figure 113. Removing optical drive

#### Next steps

[Install an optical drive.](#)

# Installing the optical drive

## Prerequisites

Follow the safety guidelines listed in [Safety instructions](#).

## Steps

1. Align the optical drive with the optical drive slot on the front of the system.
2. Slide in the optical drive until the release tab snaps into place.

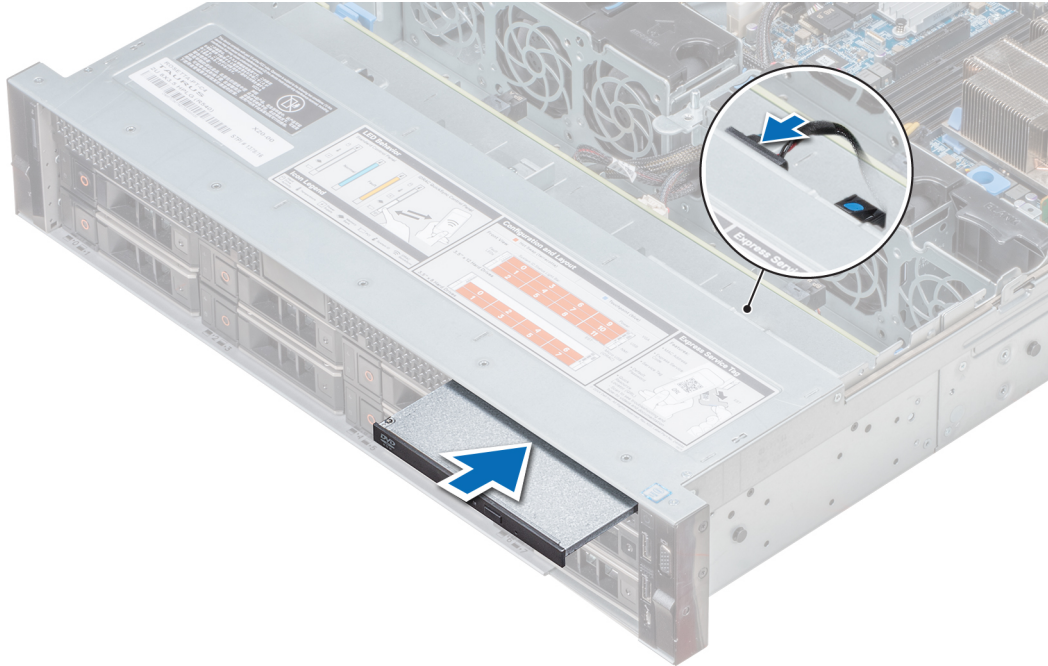


Figure 114. Installing the optical drive

## Next steps

1. Connect the power and data cables to the connector on the optical drive and the connector on the system board.  
**i** **NOTE:** Route the cable properly on the side of the system to prevent it from being pinched or crimped.
2. Follow the procedure listed in [After working inside your system](#).

# Power supply units

**i** **NOTE:** For more information, For more information, see the PowerEdge R540 Technical Specs at [www.dell.com/poweredgemanuals](http://www.dell.com/poweredgemanuals).

**⚠ CAUTION:** If two PSUs are installed, both the PSUs must have the same type of label. For example, **Extended Power Performance (EPP) label**. Mixing PSUs from previous generations of PowerEdge servers is not supported, even if the PSUs have the same power rating. Mixing PSUs will result in mismatch condition or failure to turn the system on.

**i** **NOTE:** When two identical PSUs are installed, power supply redundancy (1+1 – with redundancy or 2+0 – without redundancy) is configured in system BIOS. In redundant mode, power is supplied to the system equally from both PSUs when Hot Spare is disabled. When Hot Spare is enabled, one of the PSUs is put into the sleep mode when system utilization is low in order to maximize efficiency.

**i** **NOTE:** If two PSUs are used, they must be of the same maximum output power.

## Hot spare feature

Your system supports the hot spare feature that significantly reduces the power overhead associated with power supply unit (PSU) redundancy.

When the hot spare feature is enabled, one of the redundant PSUs is switched to the sleep state. The active PSU supports 100 percent of the load, thus operating at higher efficiency. The PSU in the sleep state monitors output voltage of the active PSU. If the output voltage of the active PSU drops, the PSU in the sleep state returns to an active output state.

If having both PSUs active is more efficient than having one PSU in the sleep state, the active PSU can also activate the sleeping PSU.

The default PSU settings are as follows:

- If the load on the active PSU is more than 50 percent, then the redundant PSU is switched to the active state.
- If the load on the active PSU falls below 20 percent, then the redundant PSU is switched to the sleep state.

You can configure the hot spare feature by using the iDRAC settings. For more information about iDRAC settings, see the *Integrated Dell Remote Access Controller User's Guide* available at <https://www.dell.com/idracmanuals>.

## Removing a power supply unit blank

### Prerequisites

Follow the safety guidelines listed in [Safety instructions](#).

### Steps

If you are installing a second power supply unit, remove the power supply unit blank in the bay by pulling the blank outward.

**CAUTION:** To ensure proper system cooling, the power supply unit blank must be installed in the second power supply unit bay in a non-redundant configuration. Remove the power supply unit blank only if you are installing a second power supply unit.

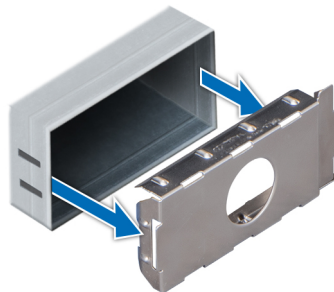


Figure 115. Removing a power supply unit blank

### Next steps

[Installing a power supply unit](#)

## Installing a power supply unit blank

### Prerequisites

1. Follow the safety guidelines listed in [Safety instructions](#).

**NOTE:** Install the power supply unit (PSU) blank only in the second PSU bay.

### Steps

Align the PSU blank with the PSU slot and push it into the PSU slot until it clicks into place.

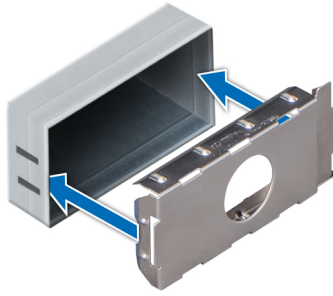


Figure 116. Installing a power supply unit blank

### Next steps

Follow the procedure listed in [After working inside your system](#).

## Removing a power supply unit

The procedure for removing AC and DC PSUs is identical.

### Prerequisites

**CAUTION:** The system needs one power supply unit (PSU) for normal operation. On power-redundant systems, remove and replace only one PSU at a time in a system that is powered on.

1. Follow the safety guidelines listed in [Safety instructions](#).
2. Disconnect the power cable from the power source and from the PSU you intend to remove, and then remove the cable from the strap on the PSU handle.
3. Unlatch and lift the optional cable management arm if it interferes with the PSU removal.

For information about the cable management arm, see the system's rack documentation at [www.dell.com/poweredgemanuals](http://www.dell.com/poweredgemanuals).

### Steps

Press the release latch and slide the PSU out of the system by using the PSU handle.

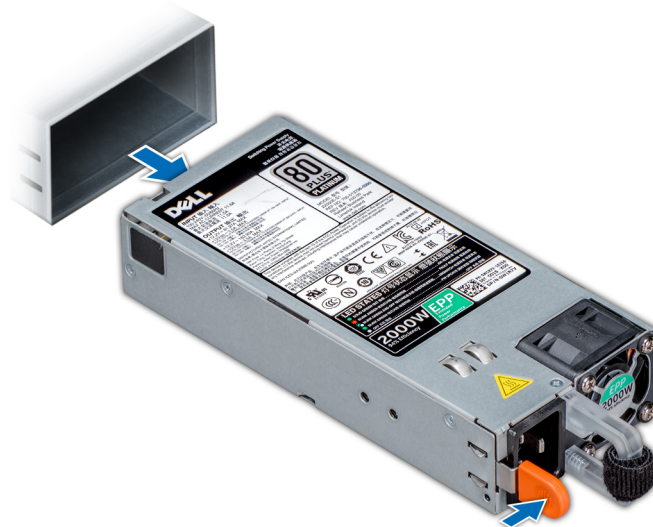


Figure 117. Removing a power supply unit

## Next steps

[Installing a processor and heat sink module](#)

# Installing a power supply unit

The procedure for installing AC and DC PSUs is identical.

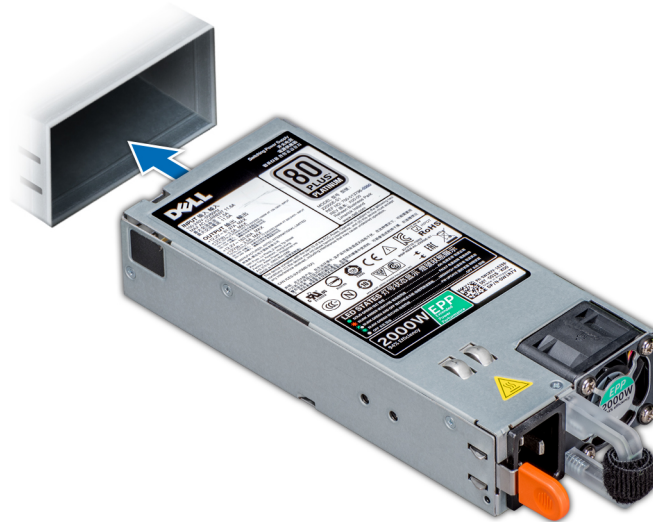
## Prerequisites

1. Follow the safety guidelines listed in [Safety instructions](#).
2. For systems that support redundant PSU, ensure that both the PSUs are of the same type and have the same maximum output power.

**NOTE:** The maximum output power (shown in watts) is listed on the PSU label.

## Steps

Slide the PSU into the system until the PSU is fully seated and the release latch snaps into place.



**Figure 118. Installing a power supply unit**

## Next steps

1. If you have unlatched the cable management arm, relatch it. For information about the cable management arm, see the system's rack documentation at [www.dell.com/poweredge/manuals](http://www.dell.com/poweredge/manuals).
2. Connect the power cable to the PSU, and plug the cable into a power outlet.

**CAUTION:** When connecting the power cable to the PSU, secure the cable to the PSU with the strap.

**NOTE:** When installing, hot swapping, or hot adding a new PSU, wait for 15 seconds for the system to recognize the PSU and determine its status. The PSU redundancy may not occur until discovery is complete. Wait until the new PSU is discovered and enabled before you remove the other PSU. The PSU status indicator turns green to signify that the PSU is functioning properly.

# Removing a non-redundant cabled AC power supply unit

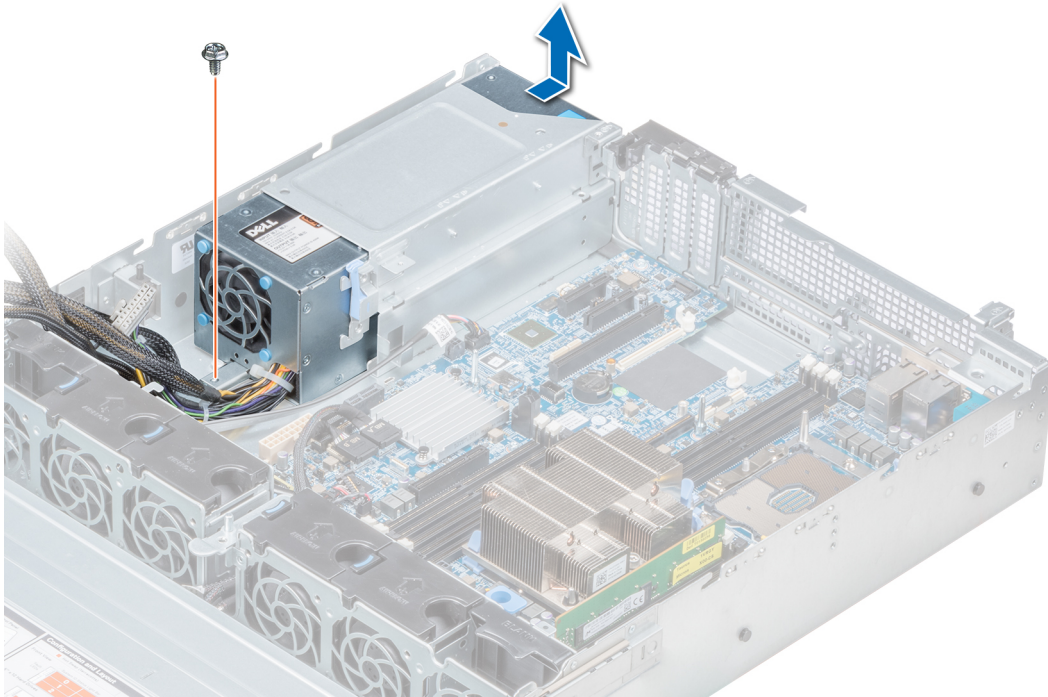
## Prerequisites

1. Follow the safety guidelines listed in [Safety instructions](#).
2. Follow the procedure listed in [Before working inside your system](#).

3. [Removing the air shroud.](#)
4. Disconnect the system from the electrical outlet.
5. Disconnect all the cables connected from the PSU to the system board.
6. If applicable, [Removing an expansion card riser](#)

### Steps

1. Using a Phillips #2 screwdriver, remove the screw securing the PSU to the system.
2. Slide the PSU out of the PSU cage.



**Figure 119. Removing non-redundant cabled AC PSU**

### Next steps

1. [Installing a non-redundant cabled AC power supply unit](#)

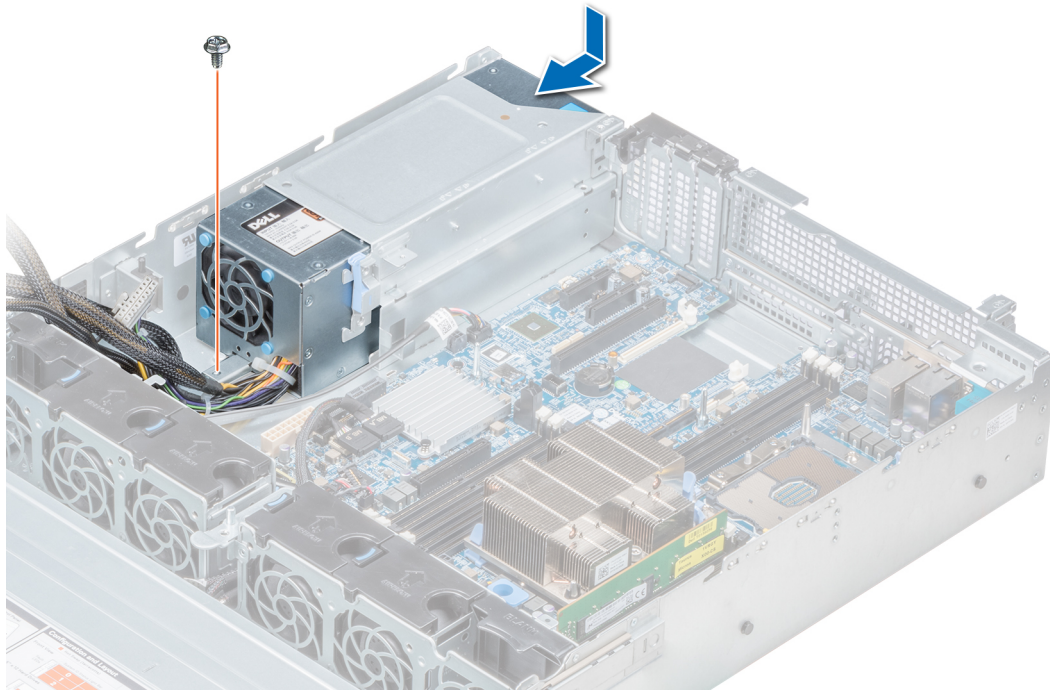
## Installing a non-redundant cabled AC power supply unit

### Prerequisites

1. Follow the safety guidelines listed in [Safety instructions.](#)

### Steps

1. Unpack the new power supply unit (PSU).
2. Slide the new PSU into the PSU cage until the PSU is fully seated.
3. Using a Phillips #2 screwdriver, replace the screw to secure the PSU to the system.



**Figure 120. Installing non-redundant cabled AC PSU**

### Next steps

1. Connect the PSU cables to the connectors on the system board.
2. If applicable, [Installing an expansion card riser](#)
3. [Installing the air shroud](#)
4. Follow the procedure listed in [After working inside your system](#).

## Removing a DC power supply unit

### Prerequisites

**NOTE:** For equipment using  $-(48-60)$  V DC power supply units (PSUs), a qualified electrician must perform all connections to DC power and to safety grounds. Do not attempt connecting to DC power or installing grounds yourself. All electrical wiring must comply with applicable local or national codes and practices. Damage due to servicing that is not authorized by Dell is not covered by your warranty. Read and follow all safety instructions that came with the product.

**CAUTION:** The system needs one PSU for normal operation. On power-redundant systems, remove and replace only one PSU at a time in a system that is powered on.

1. Follow the safety guidelines listed in [Safety instructions](#).
2. Disconnect the power wires from the power source and the connector from the PSU you intend to remove.
3. Disconnect the safety ground wire.
4. Unlatch and lift the optional cable management arm if it interferes with PSU removal. For information about the cable management arm, see the system's rack documentation at [www.dell.com/poweredge manuals](http://www.dell.com/poweredge manuals).

### Steps

Press the release latch and slide the PSU out of the system by using the PSU handle.

### Next steps

Install the DC PSU.



# Installing DC power supply unit

## Prerequisites

**NOTE:** For equipment using  $-(48-60)$  V DC power supply units (PSUs), a qualified electrician must perform all connections to DC power and to safety grounds. Do not attempt connecting to DC power or installing grounds yourself. All electrical wiring must comply with applicable local or national codes and practices. Damage due to servicing that is not authorized by Dell is not covered by your warranty. Read and follow all safety instructions that came with the product.

1. Follow the safety guidelines listed in [Safety instructions](#).
2. For systems that support redundant power supply units (PSUs), ensure that both the PSUs are of the same type and have the same maximum output power.

**NOTE:** The maximum output power (shown in watts) is listed on the PSU label.

## Steps

Slide the PSU into the system until the PSU is fully seated and the release latch snaps into place.

## Next steps

1. If you have unlatched the cable management arm, relatch it. For information about the cable management arm, see the system's rack documentation at [www.dell.com/poweredge/manuals](http://www.dell.com/poweredge/manuals).
2. Connect the safety ground wire.
3. Install the DC power connector in the PSU.

**CAUTION:** When connecting the power wires, ensure that you secure the wires with the strap to the PSU handle.

4. Connect the wires to a DC power source.

**NOTE:** When installing, hot-swapping, or hot-adding a new PSU, wait for 15 seconds for the system to recognize the PSU and determine its status. The PSU status indicator turns green to signify that the PSU is functioning properly.

# Wiring instructions for a DC power supply unit

Your system supports up to two  $-(48-60)$  V DC power supply units (PSUs).

**NOTE:** For equipment using  $-(48-60)$  V DC power supply units (PSUs), a qualified electrician must perform all connections to DC power and to safety grounds. Do not attempt connecting to DC power or installing grounds yourself. All electrical wiring must comply with applicable local or national codes and practices. Damage due to servicing that is not authorized by Dell is not covered by your warranty. Read and follow all safety instructions that came with the product.

**CAUTION:** Wire the unit with copper only, unless otherwise specified, use only 10 American Wire Gauge (AWG) wire rated minimum 90°C for source and return. Protect the  $-(48-60)$  V DC (1 wire) with a branch circuit over-current protection rated 50 A for DC with a high interrupt current rating.

**CAUTION:** Connect the equipment to a  $-(48-60)$  V DC supply source that is electrically isolated from the AC source (reliably grounded  $-(48-60)$  V DC SELV source). Ensure that the  $-(48-60)$  V DC source is efficiently secured to earth (ground).

**NOTE:** A readily accessible disconnect device that is suitably approved and rated shall be incorporated in the field wiring.

## Input requirements

- Supply voltage:  $-(48-60)$  V DC
- Current consumption: 32 A (maximum)

## Kit contents

- Dell part number 6RYJ9 terminal block or equivalent (1)

- #6-32 nut equipped with lock washer (1)

## Required tools

Wire-stripper pliers capable of removing insulation from size 10 AWG solid or stranded, insulated copper wire.

**i** **NOTE:** Use alpha wire part number 3080 or equivalent (65/30 stranding).

## Required wires

- One UL 10 AWG, 2 m maximum (stranded) black wire [–(48–60) V DC].
- One UL 10 AWG, 2 m maximum (stranded) red wire (V DC return).
- One UL 10 AWG, 2 m maximum, green with a yellow stripe, stranded wire (safety ground).

## Assembling and connecting safety ground wire

### Prerequisites

**i** **NOTE:** For equipment using –(48–60) V DC power supply units (PSUs), a qualified electrician must perform all connections to DC power and to safety grounds. Do not attempt connecting to DC power or installing grounds yourself. All electrical wiring must comply with applicable local or national codes and practices. Damage due to servicing that is not authorized by Dell is not covered by your warranty. Read and follow all safety instructions that came with the product.

### Steps

1. Strip the insulation from the end of the green or yellow wire, exposing approximately 4.5 mm (0.175 inch) of copper wire.
2. Using a hand-crimping tool (Tyco Electronics, 58433-3 or equivalent), crimp the ring-tongue terminal (Jeason Terminals Inc., R5-4SA or equivalent) to the green and yellow wire (safety ground wire).
3. Connect the safety ground wire to the grounding post on the back of the system by using a #6-32 nut equipped with a locking washer.

## Assembling DC input power wires

### Prerequisites

**i** **NOTE:** For equipment using –(48–60) V DC power supply units (PSUs), a qualified electrician must perform all connections to DC power and to safety grounds. Do not attempt connecting to DC power or installing grounds yourself. All electrical wiring must comply with applicable local or national codes and practices. Damage due to servicing that is not authorized by Dell is not covered by your warranty. Read and follow all safety instructions that came with the product.

### Steps

1. Strip the insulation from the ends of the DC power wires, exposing approximately 13 mm (0.5 inch) of copper wire.  
**i** **NOTE:** Reversing polarity when connecting DC power wires can permanently damage the power supply or the system.
2. Insert the copper ends into the mating connectors and tighten the captive screws at the top of the mating connector using a Phillips #2 screwdriver.  
**i** **NOTE:** To protect the power supply from electrostatic discharge, the captive screws must be covered with the rubber cap before inserting the mating connector into the power supply.
3. Rotate the rubber cap clockwise to fix it over the captive screws.
4. Insert the mating connector into the power supply.

# Power interposer board

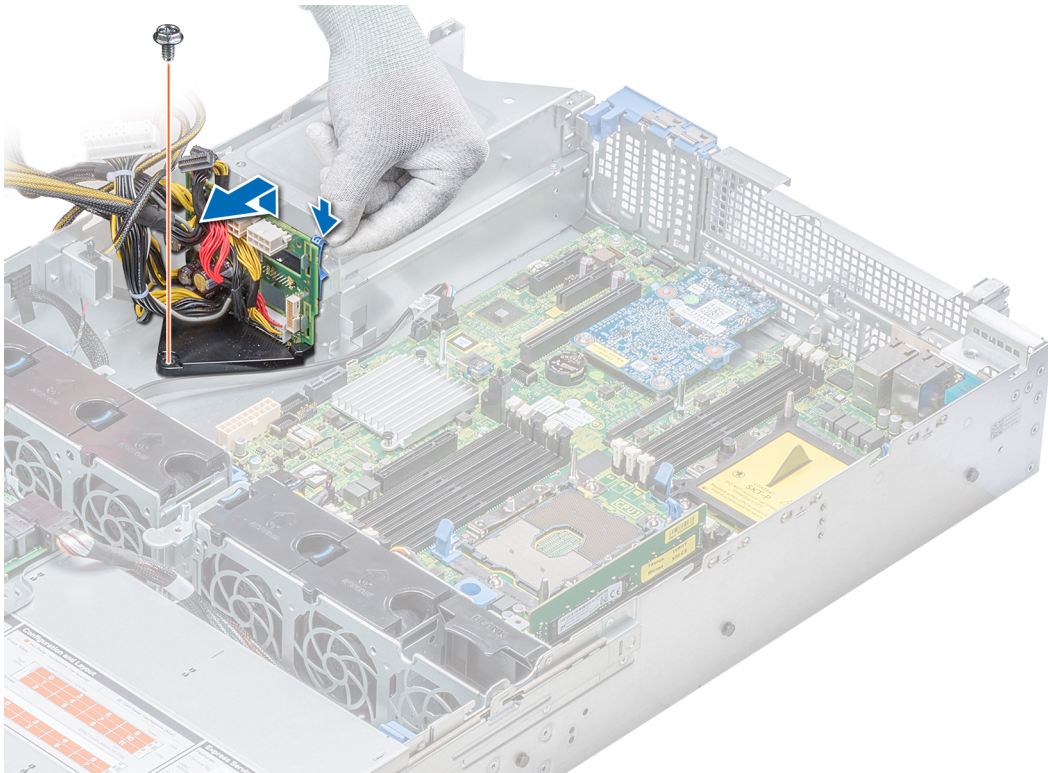
## Removing power interposer board

### Prerequisites

1. Follow the safety guidelines listed in [Safety instructions](#).
2. Follow the procedure listed in [Before working inside your system](#).
3. [Removing the air shroud](#)
4. Disconnect all the cables connected from the PIB to the system board.
  - i** **NOTE:** Ensure that you note the routing of the cables as you remove them from the system board.
5. [Removing a processor and heat sink module](#)

### Steps

1. Using a Phillips #2 screwdriver, remove the screw securing the power interposer board (PIB) to the system.
2. Press the blue release latch on the PIB to release it from the hook on the PSU cage.
3. Lift the board and slide it out at an angle to disengage the guide pins on the board.



**Figure 121. Removing power interposer board**

4. Lift the board away from the system.

### Next steps

1. [Installing power interposer board](#)

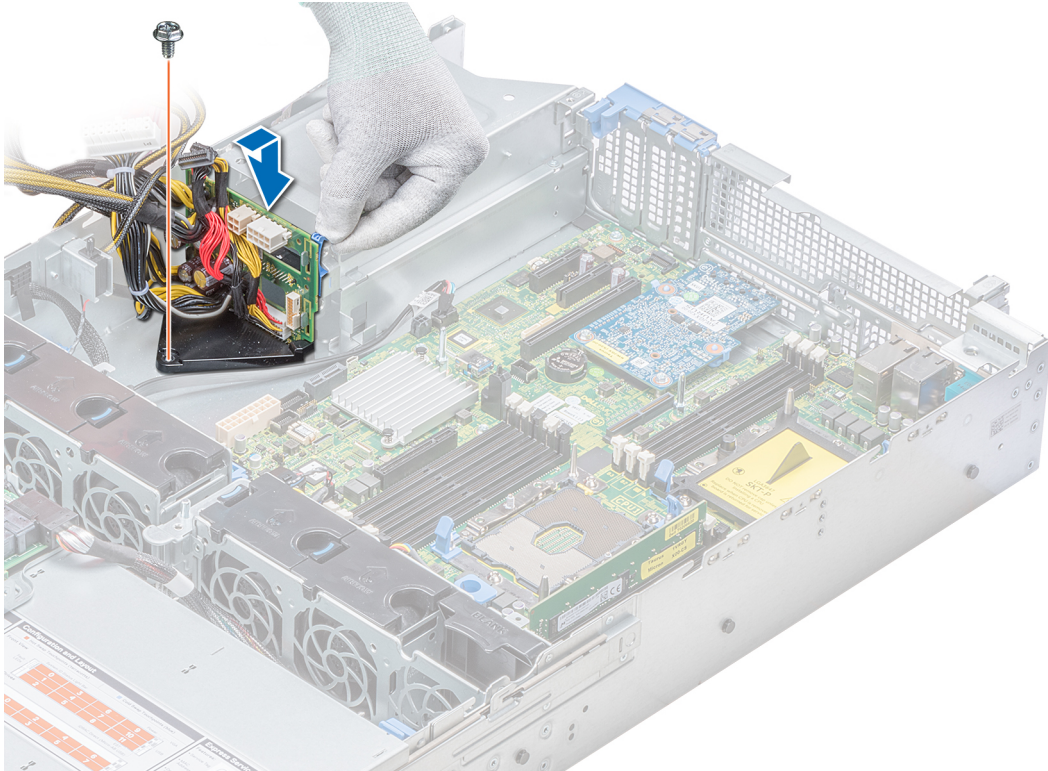
## Installing power interposer board

### Prerequisites

Follow the safety guidelines listed in [Safety instructions](#).

## Steps

1. Align the slots on the PIB with the hook on the PSU cage and slide it into place.
2. Using a Phillips #2 screwdriver, tighten the screw to secure the PIB to the system.
3. Route the cables and connect it to the system board.



**Figure 122. Installing power interposer board**

## Next steps

1. [Installing a processor and heat sink module](#)
2. [Installing the air shroud](#)
3. Follow the procedure listed in [After working inside your system.](#)

# Control panel

## Removing the left control panel

### Prerequisites

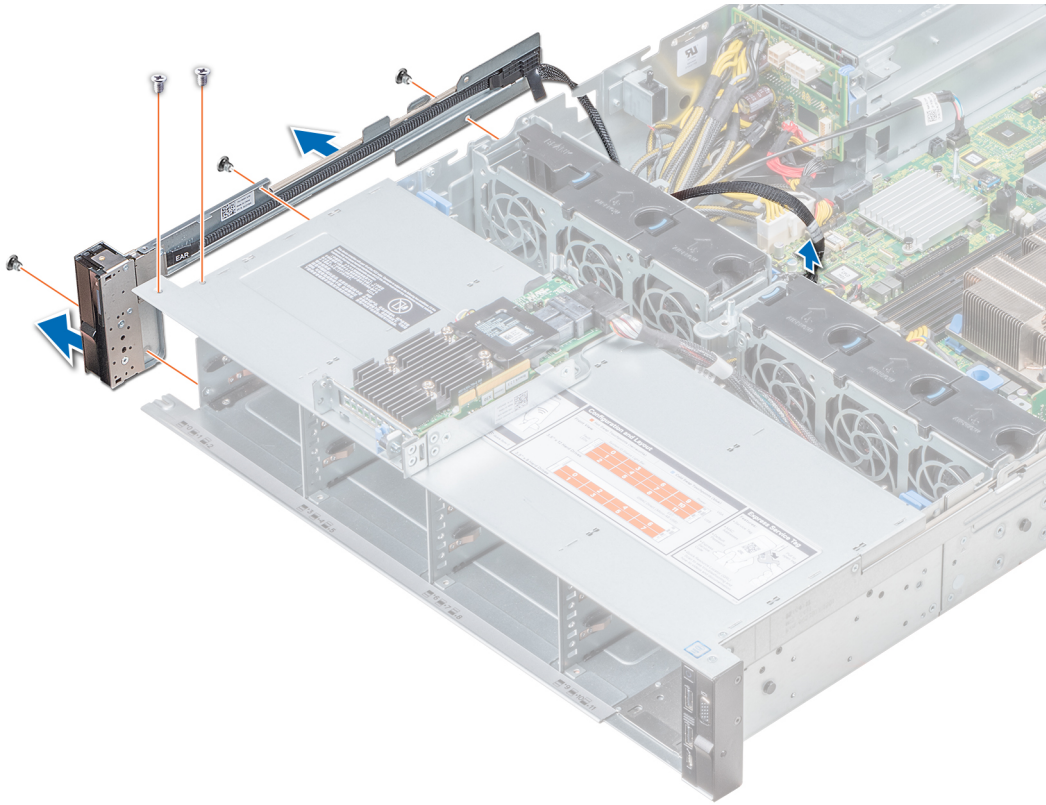
1. Follow the safety guidelines listed in [Safety instructions.](#)
2. Follow the procedure listed in [Before working inside your system.](#)
3. [Removing the air shroud](#)
4. [Removing the PERC card from the internal PERC riser](#)

### Steps

1. Disconnect the control panel cable from the system board connector.

**NOTE:** Ensure that you note the routing of the cables as you remove them from the system board. You must route the cables properly when you replace them to prevent the cables from being pinched or crimped.

2. Using a Phillips #1 screwdriver, remove the screws that secure the left control panel assembly to the system.



**Figure 123. Removing left control panel**

3. Holding by the sides, remove the left control panel assembly away from the system.

#### **Next steps**

[Installing the left control panel](#)

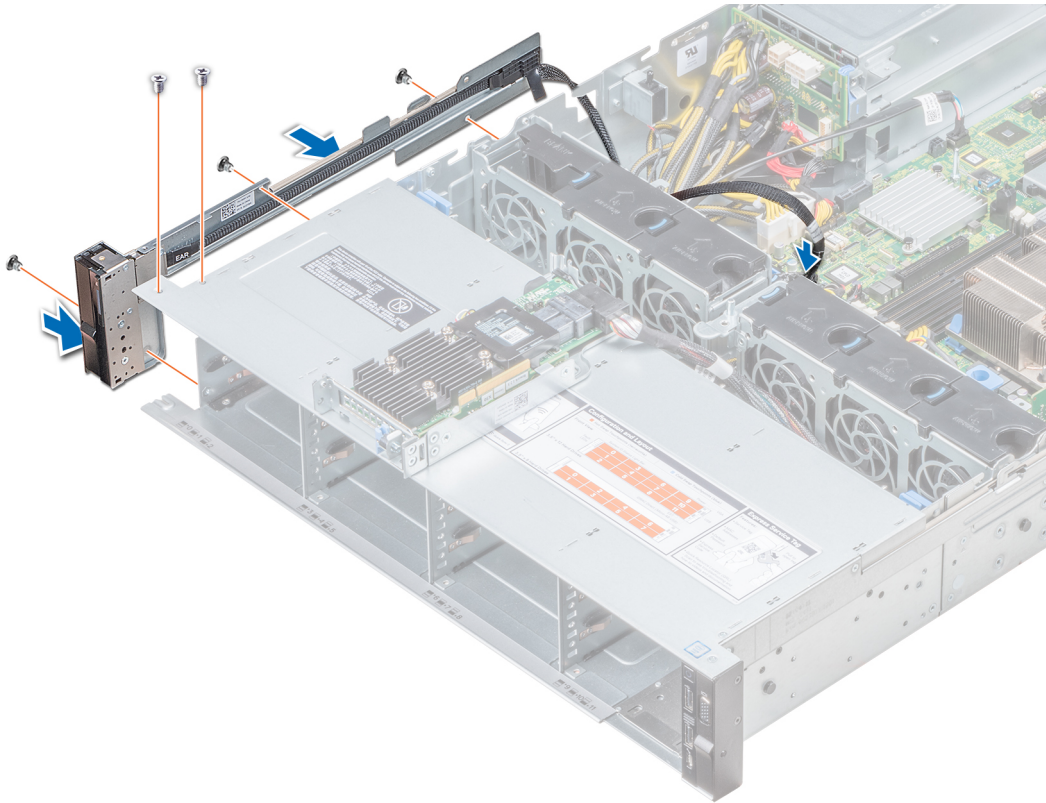
## **Installing the left control panel**

#### **Prerequisites**

Follow the safety guidelines listed in [Safety instructions](#).

#### **Steps**

1. Route the control panel cable through the side wall of the system.
2. Align the left control panel assembly with the control panel slot on the system and place the assembly in the slot on the system.
3. Connect the control panel cable to the system board connector.
4. Using Phillips #1 screwdriver, tighten the screws to secure the left control panel assembly to the system.



**Figure 124. Installing left control panel**

#### Next steps

1. [Installing the air shroud](#)
2. [Installing PERC card into the internal PERC riser](#)
3. Follow the procedure listed in [After working inside your system.](#)

## Removing the right control panel

#### Prerequisites

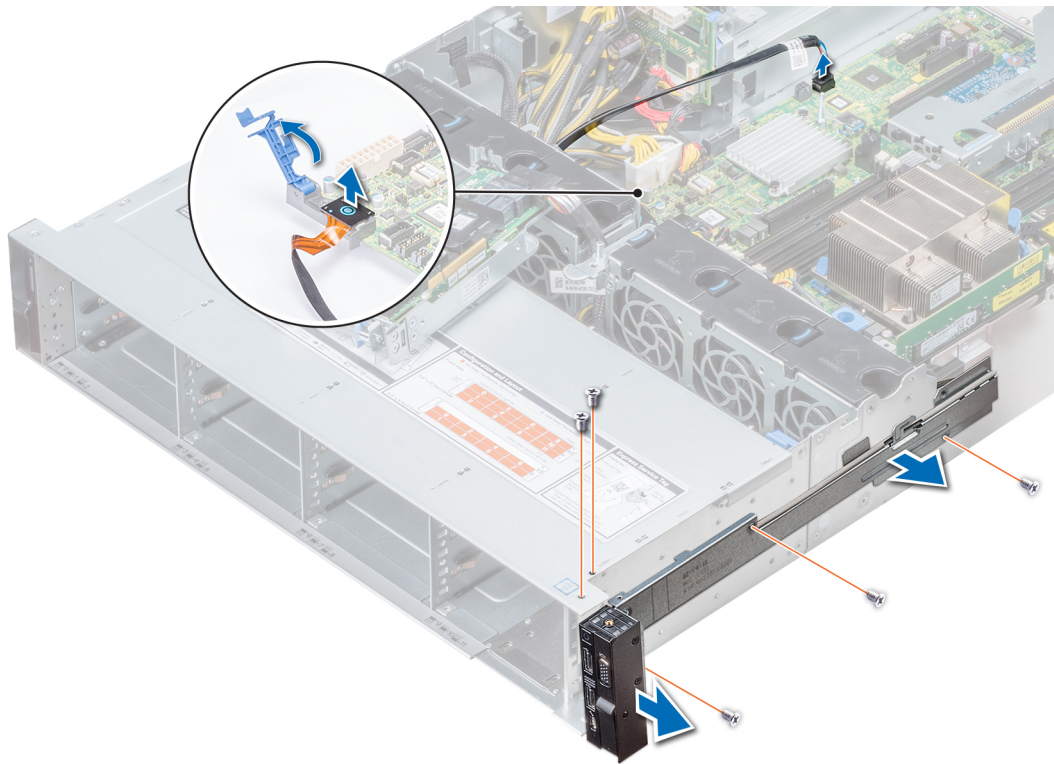
1. Follow the safety guidelines listed in [Safety instructions.](#)
2. Follow the procedure listed in [Before working inside your system.](#)
3. [Removing the PERC card from the internal PERC riser](#)

#### Steps

1. Lift the cable latch and disconnect the control panel cable from the connector on the system board.

**NOTE:** Ensure that you note the routing of the cables as you remove them from the system board. You must route the cables properly when you replace them to prevent the cables from being pinched or crimped.

2. Using Phillips #1 screwdriver, remove the screws that secure the right control panel assembly to the system.



**Figure 125. Removing right control panel**

3. Holding by the sides, remove the right control panel assembly away from the system.

#### **Next steps**

[Installing the right control panel](#)

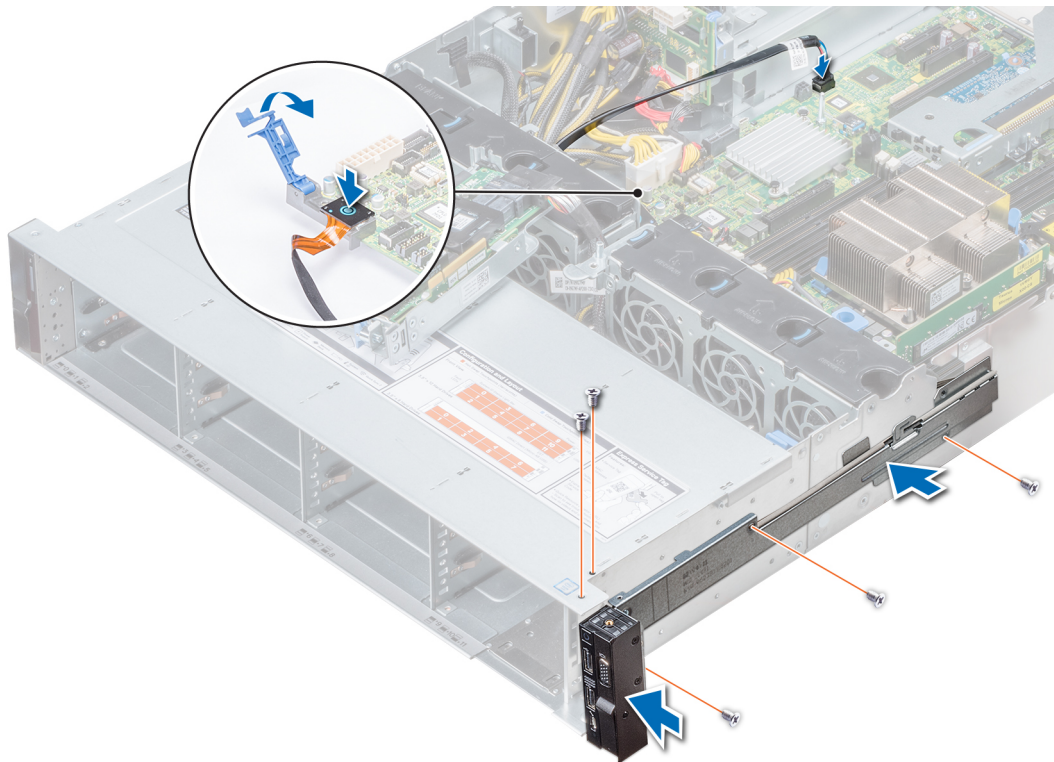
## **Installing the right control panel**

#### **Prerequisites**

Follow the safety guidelines listed in [Safety instructions](#).

#### **Steps**

1. Route the control panel cable through the side wall of the system.
2. Align the right control panel assembly with the control panel slot on the system and attach the control panel assembly to the system.
3. Connect the control panel cable to the connector on the system board and lower the cable latch to secure the cable in place.
4. Using a Phillips #1 screwdriver, tighten the screws to secure the right control panel assembly to the system.



**Figure 126. Installing right control panel**

### Next steps

1. [Installing PERC card into the internal PERC riser](#)
2. Follow the procedure listed in [After working inside your system](#).

## System board

### Removing the system board

#### Prerequisites

**CAUTION:** If you are using Trusted Platform Module (TPM) with an encryption key, you may be prompted to create a recovery key during program or System Setup. Be sure to create and safely store this recovery key. If you replace this system board, you must supply the recovery key when you restart your system or program before you can access the encrypted data on your drives.

**CAUTION:** Do not attempt to remove the TPM plug-in module from the system board. Once the TPM plug-in module is installed, it is cryptographically bound to that specific system board. Any attempt to remove an installed TPM plug-in module breaks the cryptographic binding, and it cannot be re-installed or installed on another system board.

1. Follow the safety guidelines listed in [Safety instructions](#).
2. Follow the procedure listed in [Before working inside your system](#).
3. Remove the following:

**CAUTION:** Do not lift the system board by holding a memory module, processor, or other components.

- a. [Air shroud](#)
- b. [All expansion cards and risers](#)
- c. [Internal PERC riser](#)



- d. vFlash/IDSDM module
- e. Internal USB key (if installed)
- f. USB 3.0 module (if installed)
- g. Processors and heat sink modules
- h. Processors blanks (if installed)

**CAUTION:** To prevent damage to the processor socket when replacing a faulty system board, ensure that you cover the processor socket with the processor dust cover.

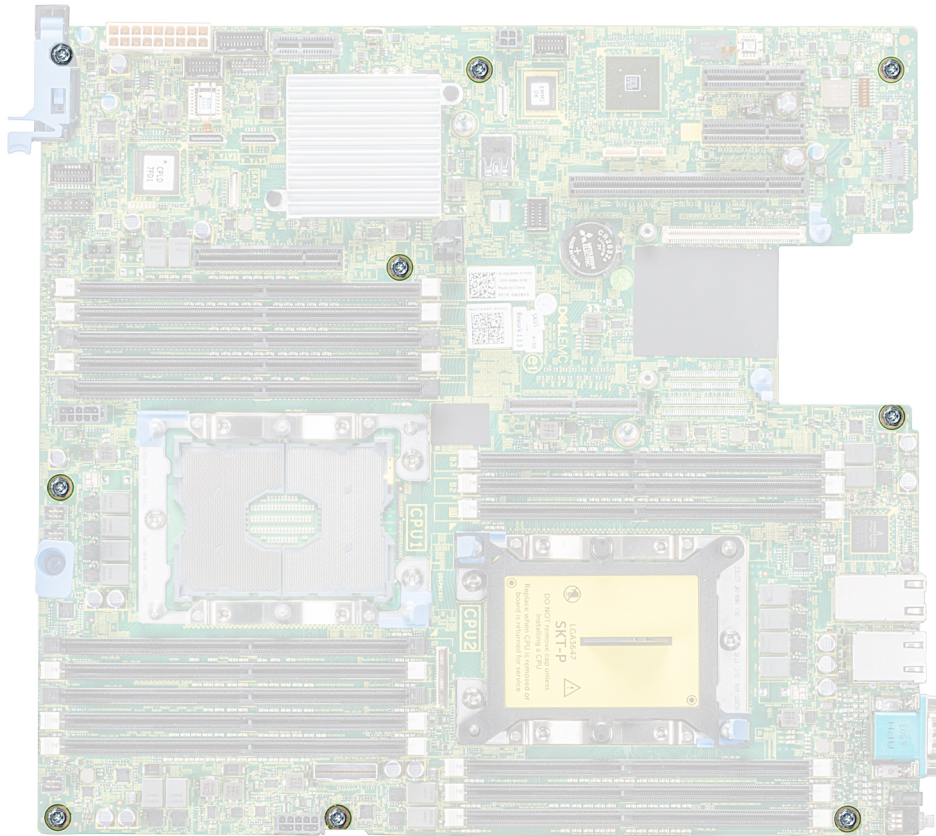
- i. Memory modules
- j. LOM riser card
- k. Drive cage (rear) (if installed)

### Steps

1. Disconnect all cables from the system board.

**CAUTION:** Take care not to damage the system identification button while removing the system board from the chassis.

2. Using a Torx #T30 screwdriver, remove nine screws securing the system board to the chassis.



**Figure 127. System board screws**

3. Hold the system board holder, slightly lift the system board, and then slide it toward the front of the chassis.
4. Incline the system board at an angle, and lift the system board out of the chassis.

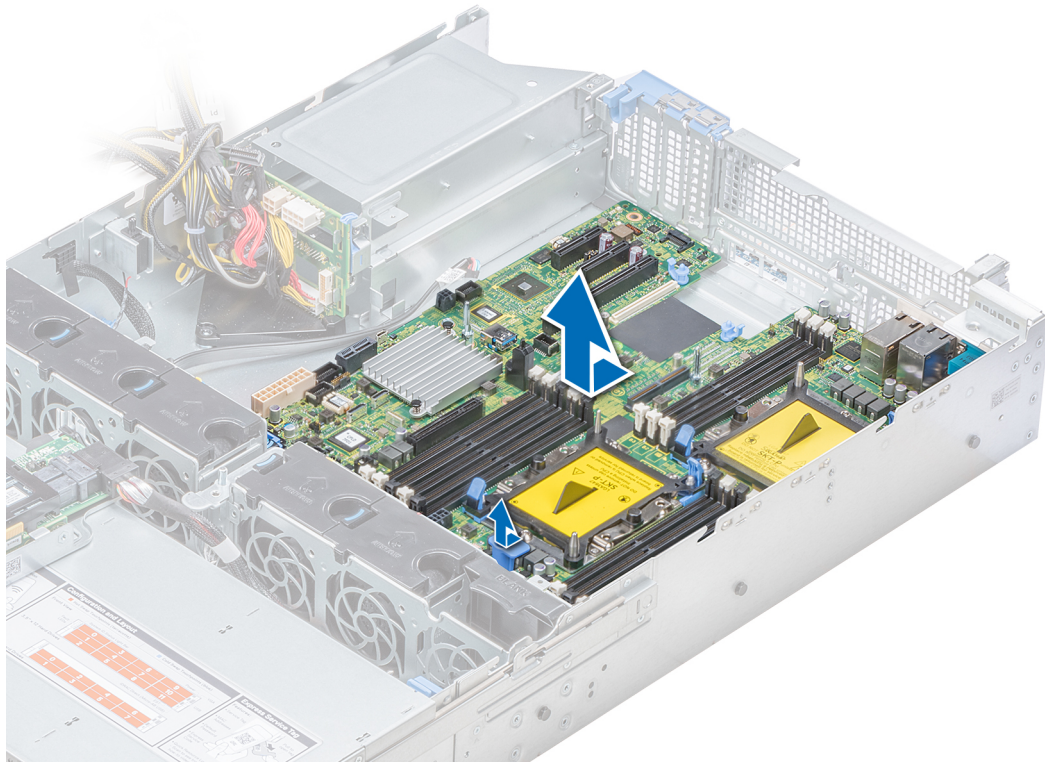


Figure 128. Removing the system board

### Next steps

[Installing the system board.](#)

## Installing the system board

### Prerequisites

Follow the safety guidelines listed in [Safety instructions](#).

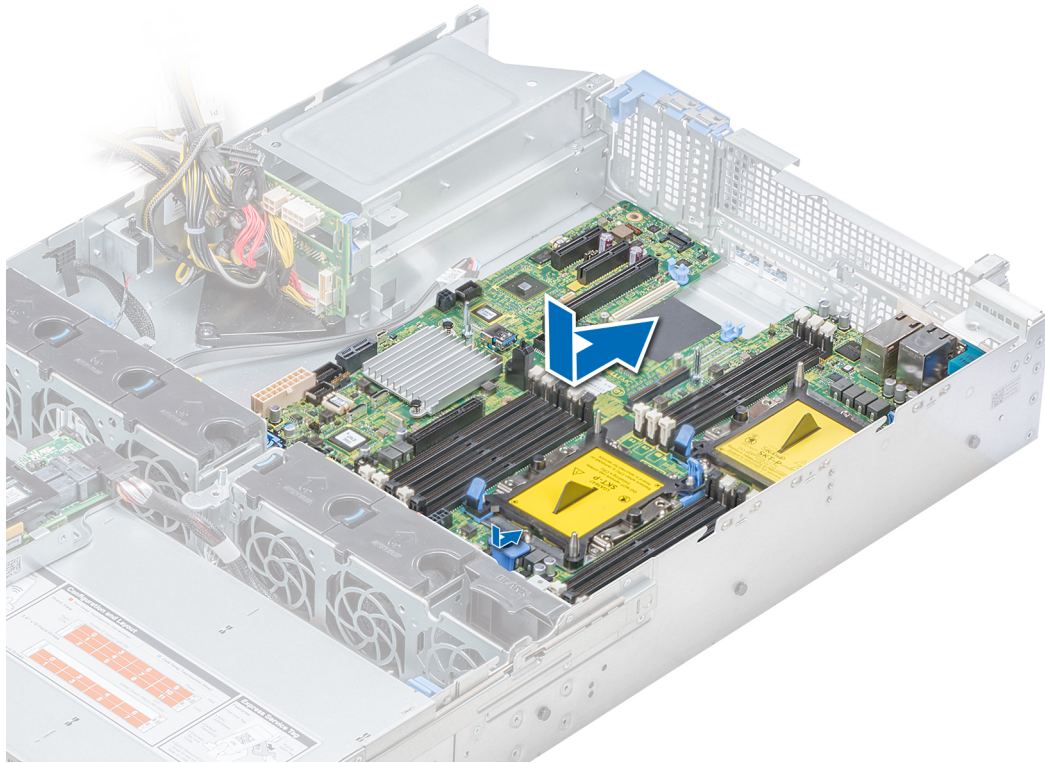
### Steps

1. Unpack the new system board assembly.

**CAUTION:** Do not lift the system board by holding a memory module, processor, or other components.

**CAUTION:** Take care not to damage the system identification button while placing the system board into the chassis.

2. Holding the system board holder, push the system board toward the back of the system until it is seated.
3. Using Phillips #2 screwdriver, tighten the screws to secure the system board to the chassis.



**Figure 129. Installing system board**

**Next steps**

1. Replace the following:
  - a. [Upgrading the Trusted Platform Module](#)
  - b. [Installing PERC card into the internal PERC riser](#)
  - c. [Optional internal USB memory key](#)
  - d. [USB 3.0 module \(if applicable\)](#)
  - e. [IDSDM/vFlash module card](#)
  - f. [All expansion cards and risers](#)
  - g. [Processors and heat sink modules](#)
  - h. [Processors blanks \(if applicable\)](#)
  - i. [Memory modules](#)
  - j. [LOM riser card](#)
  - k. [Air shroud](#)
  - l. [Drive cage \(rear\) \(if applicable\)](#)
2. Reconnect all cables to the system board.
 

**i** **NOTE:** Ensure that the cables inside the system are routed along the chassis wall and secured using the cable securing bracket.
3. Follow the procedure listed in [After working inside your system](#).
4. Ensure that you:
  - a. Use the Easy Restore feature to restore the Service Tag. For more information, see the [Restoring the service tag using Easy Restore](#) section.
  - b. If the Service Tag is not backed up in the backup flash device, enter the Service Tag manually. For more information, see the [Manually update the Service Tag](#) section.
  - c. Update the BIOS and iDRAC versions.
  - d. Re-enable the Trusted Platform Module (TPM). For more information, see the [Upgrading the Trusted Platform Module](#) section.
5. Import your new or existing iDRAC Enterprise license.



For more information, see *Integrated Dell Remote Access Controller User's Guide*, at [www.dell.com/poweredgemanuals](http://www.dell.com/poweredgemanuals).

# Restoring the system using Easy Restore

The easy restore feature enables you to restore your service tag, license, UEFI configuration, and the system configuration data after replacing the system board. All data is backed up in a backup flash device automatically. If BIOS detects a new system board, and the service tag in the backup flash device, BIOS prompts the user to restore the backup information.

## About this task

Below is a list of options available:

- Restore the service tag, license, and diagnostics information, press **Y**
- Navigate to the Lifecycle Controller based restore options, press **N**.
- Restore data from a previously created **Hardware Server Profile**, press **F10**  
 **NOTE:** When the restore process is complete, BIOS prompts to restore the system configuration data.
- To restore the system configuration data, press **Y**
- To use the default configuration settings, press **N**  
 **NOTE:** After the restore process is complete, system reboots.


## Manually update the Service Tag

After replacing a system board, if Easy Restore fails, follow this process to manually enter the Service Tag, using **System Setup**.

## About this task

If you know the system service tag, use the **System Setup** menu to enter the service tag.


### Steps

1. Power on the system.
2. To enter the **System Setup**, press **F2**.
3. Click **Service Tag Settings**.
4. Enter the service tag.  
 **NOTE:** You can enter the service tag only when the **Service Tag** field is empty. Ensure that you enter the correct service tag. Once the service tag is entered, it cannot be updated or changed.
5. Click **OK**.

# Entering the system Service Tag by using System Setup

If Easy Restore fails to restore the Service Tag, use System Setup to enter the Service Tag.

### Steps

1. Turn on the system.
2. Press F2 to enter System Setup.
3. Click **Service Tag Settings**.
4. Enter the Service Tag.  
 **NOTE:** You can enter the Service Tag only when the **Service Tag** field is empty. Ensure that you enter the correct Service Tag. After the Service Tag is entered, it cannot be updated or changed.
5. Click **OK**.
6. Import your new or existing iDRAC Enterprise license.

# Trusted Platform Module

## Upgrading the Trusted Platform Module


### Prerequisites

1. Follow the safety guidelines listed in [Safety instructions](#).
2. Follow the procedure listed in [Before working inside your system](#).

#### NOTE:

- Ensure that your operating system supports the version of the TPM module being installed.
- Ensure that you download and install the latest BIOS firmware on your system.
- Ensure that the BIOS is configured to enable UEFI boot mode.


### About this task

 **CAUTION:** Once the TPM plug-in module is installed, it is cryptographically bound to that specific system board. Any attempt to remove an installed TPM plug-in module breaks the cryptographic binding, the removed TPM cannot be reinstalled or installed on another system board.

## Removing the TPM

### Steps

1. Locate the TPM connector on the system board.

 **NOTE:** To locate the TPM connector on the system board, see the [Jumpers and connectors](#) section.

2. Press to hold the module down and remove the screw using the security Torx 8-bit shipped with the TPM module.
3. Slide the TPM module out from its connector.
4. Push the plastic rivet away from the TPM connector and rotate it 90° counterclockwise to release it from the system board.
5. Pull the plastic rivet out of its slot on the system board.

## Installing the TPM

### Steps

1. To install the TPM, align the edge connectors on the TPM with the slot on the TPM connector.
2. Insert the TPM into the TPM connector such that the plastic rivet aligns with the slot on the system board.
3. Press the plastic rivet until the rivet snaps into place.

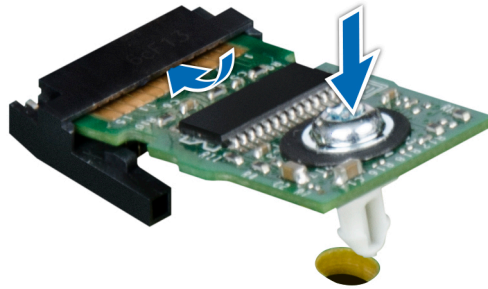


Figure 130. Installing the TPM

#### Next steps

1. [Install the system board.](#)
2. Follow the procedure listed in [After working inside your system.](#)

## Initializing TPM for BitLocker users

#### Steps

Initialize the TPM.

For more information, see <http://technet.microsoft.com/en-us/library/cc753140.aspx>.

The **TPM Status** changes to **Enabled, Activated**.

## Initializing the TPM 1.2 for TXT users

#### Steps

1. While booting your system, press F2 to enter System Setup.
2. On the **System Setup Main Menu** screen, click **System BIOS > System Security Settings**.
3. From the **TPM Security** option, select **On with Pre-boot Measurements**.
4. From the **TPM Command** option, select **Activate**.
5. Save the settings.
6. Restart your system.
7. Enter **System Setup** again.
8. On the **System Setup Main Menu** screen, click **System BIOS > System Security Settings**.
9. From the **Intel TXT** option, select **On**.

# Jumpers and connectors

This topic provides specific information about the jumpers. It also provides some basic information about jumpers and switches and describes the connectors on the various boards in the system. Jumpers on the system board help to disable the system and setup passwords. You must know the connectors on the system board to install components and cables correctly.

## Topics:

- System board jumpers and connectors
- System board jumper settings
- Disabling forgotten password

## System board jumpers and connectors

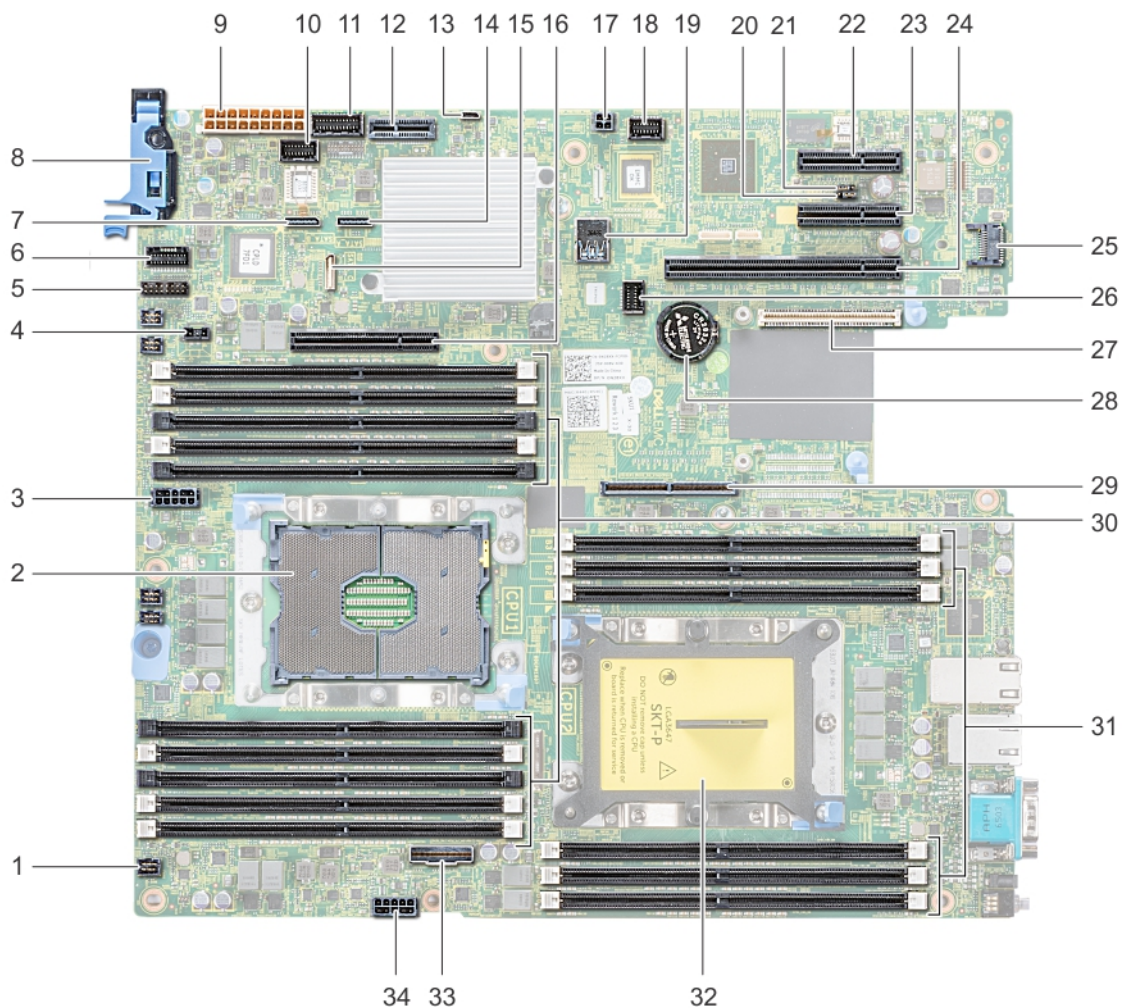


Figure 131. System board jumpers and connectors

**Table 30. System board jumpers and connectors**

Item	Connector	Description
1.	FAN6	Cooling fan 6 connector
2.	CPU1	Processor socket 1
3.	CPU1_PWR_CONN(P2)	CPU1 power connector
4.	J_INTRU	Intrusion switch connector
5.	J_BP_SIG1	Backplane signal connector 1
6.	LFT_CP_CONN	Left control panel connector
7.	J_SATA_B1	Internal SATA B connector
8.	RGT_CP_CONN	Right panel connector
9.	SYS_PWR_CONN(P1)	System power connector
10.	J_PIB_SIG1	Power interface board signal connector 1
11.	J_PIB_SIG2	Power interface board signal connector 2
12.	J_ACE	Internal Dual SD Module
13.	J_CP_USB2	Front USB connector
14.	J_SATA_A1	Internal SATA A connector
15.	J_SATA_C1	Internal SATA C connector
16.	PCIE_G3_X8(CPU1)	Internal PERC controller connector
17.	J_REAR_BP_PWR1	ODD power connector
18.	J_FRONT_VIDEO	VGA connector
19.	INT_USB_3.0	USB connector
20.	NVRAM_CLR	Clear NVRAM
21.	PWRD_EN	Reset BIOS password
22.	SLOT6	PCIe slot 6
23.	SLOT5	PCIe slot 5
24.	SLOT4	PCIe slot 4
25.	J_TPM_MODULE	TPM module connector
26.	J_BP_SIG0	Backplane signal connector
27.	J_MEZZ_A1	LOM riser card connector
28.	BATTERY	Battery connector
29.	PCIE_G3_X16(CPU1)	Riser 1 connector
30.	A6, A5, A10, A4, A9, A7, A1, A8, A2, A3	Memory module sockets
31.	B3, B2, B1, B4, B5, B6	Memory module sockets
32.	CPU2	Processor socket 2
33.	PCIE_A0	NVMe connector
34.	CPU2_PWR_CONN(P3)	CPU2 power connector

## System board jumper settings


For information on resetting the password jumper to disable a password, see the [Disabling a forgotten password](#) section.



# Disabling forgotten password

The software security features of the system include a system password and a setup password. The password jumper enables or disables password features and clears any password(s) currently in use.


## Prerequisites

 **CAUTION:** Many repairs may only be done by a certified service technician. You should only perform troubleshooting and simple repairs as authorized in your product documentation, or as directed by the online or telephone service and support team. Damage due to servicing that is not authorized by Dell is not covered by your warranty. Read and follow the safety instructions that are shipped with your product.

## Steps

1. Power off the system, including any attached peripherals, and disconnect the system from the electrical outlet.
2. Remove the system cover.
3. Move the jumper on the system board jumper from pins 2 and 4 to pins 4 and 6.
4. Install the system cover.

The existing passwords are not disabled (erased) until the system boots with the jumper on pins 4 and 6. However, before you assign a new system and/or setup password, you must move the jumper back to pins 2 and 4.

 **NOTE:** If you assign a new system and/or setup password with the jumper on pins 4 and 6, the system disables the new password(s) the next time it boots.

5. Reconnect the system to its electrical outlet and power on the system, including any attached peripherals.
6. Power off the system, including any attached peripherals, and disconnect the system from the electrical outlet.
7. Remove the system cover.
8. Move the jumper on the system board jumper from pins 4 and 6 to pins 2 and 4.
9. Install the system cover.
10. Reconnect the system to its electrical outlet and power on the system, including any attached peripherals.
11. Assign a new system and/or setup password.

# System diagnostics

If you experience a problem with your system, run the system diagnostics before contacting Dell for technical assistance. The purpose of running system diagnostics is to test your system hardware without using additional equipment or risking data loss. If you are unable to fix the problem yourself, service and support personnel can use the diagnostics results to help you solve the problem.

## Topics:

- [Dell Embedded System Diagnostics](#)

## Dell Embedded System Diagnostics

**NOTE:** The Dell Embedded System Diagnostics is also known as Enhanced Pre-boot System Assessment (ePSA) diagnostics.

The Embedded System Diagnostics provides a set of options for particular device groups or devices allowing you to:

- Run tests automatically or in an interactive mode
- Repeat tests
- Display or save test results
- Run thorough tests to introduce additional test options to provide extra information about the failed device(s)
- View status messages that inform you if tests are completed successfully
- View error messages that inform you of problems encountered during testing

## Running the Embedded System Diagnostics from Boot Manager

Run the Embedded System Diagnostics (ePSA) if your system does not boot.

### Steps

1. When the system is booting, press F11.
2. Use the up arrow and down arrow keys to select **System Utilities > Launch Diagnostics**.
3. Alternatively, when the system is booting, press F10, select **Hardware Diagnostics > Run Hardware Diagnostics**. The **ePSA Pre-boot System Assessment** window is displayed, listing all devices detected in the system. The diagnostics starts executing the tests on all the detected devices.

## Running the Embedded System Diagnostics from the Dell Lifecycle Controller

### Steps

1. As the system boots, press F10.
2. Select **Hardware Diagnostics → Run Hardware Diagnostics**. The **ePSA Pre-boot System Assessment** window is displayed, listing all devices detected in the system. The diagnostics starts executing the tests on all the detected devices.

## System diagnostic controls

Menu	Description
<b>Configuration</b>	Displays the configuration and status information of all detected devices.

<b>Menu</b>	<b>Description</b>
<b>Results</b>	Displays the results of all tests that are run.
<b>System health</b>	Provides the current overview of the system performance.
<b>Event log</b>	Displays a time-stamped log of the results of all tests run on the system. This is displayed if at least one event description is recorded.

# Getting help

## Topics:

- [Contacting Dell EMC](#)
- [Documentation feedback](#)
- [Accessing system information by using QRL](#)
- [Receiving automated support with SupportAssist](#)
- [Recycling or End-of-Life service information](#)

## Contacting Dell EMC

Dell EMC provides several online and telephone based support and service options. If you do not have an active internet connection, you can find contact information about your purchase invoice, packing slip, bill, or Dell EMC product catalog. Availability varies by country and product, and some services may not be available in your area. To contact Dell EMC for sales, technical assistance, or customer service issues:

### Steps

1. Go to [www.dell.com/support/home](http://www.dell.com/support/home).
2. Select your country from the drop-down menu on the lower right corner of the page.
3. For customized support:
  - a. Enter your system Service Tag in the **Enter your Service Tag** field.
  - b. Click **Submit**.  
The support page that lists the various support categories is displayed.
4. For general support:
  - a. Select your product category.
  - b. Select your product segment.
  - c. Select your product.  
The support page that lists the various support categories is displayed.
5. For contact details of Dell EMC Global Technical Support:
  - a. Click [Contact Technical Support](#).
  - b. Enter your system Service Tag in the **Enter your Service Tag** field on the Contact Us webpage.

## Documentation feedback

You can rate the documentation or write your feedback on any of our Dell EMC documentation pages and click **Send Feedback** to send your feedback.

## Accessing system information by using QRL

You can use the Quick Resource Locator (QRL) located on the information tag in the front of the system, to access the information about the PowerEdge system.

### Prerequisites

Ensure that your smartphone or tablet has the QR code scanner installed.

The QRL includes the following information about your system:

- How-to videos

- Reference materials, including the Installation and Service Manual, LCD diagnostics, and mechanical overview
- Your system service tag to quickly access your specific hardware configuration and warranty information
- A direct link to Dell to contact technical assistance and sales teams

### Steps

1. Go to [www.dell.com/qrl](http://www.dell.com/qrl) and navigate to your specific product or
2. Use your smartphone or tablet to scan the model-specific Quick Resource (QR) code on your system or in the Quick Resource Locator section.

## Quick Resource Locator for R540

### Quick Resource Locator for PowerEdge R540



## Receiving automated support with SupportAssist

Dell EMC SupportAssist is an optional Dell EMC Services offering that automates technical support for your Dell EMC server, storage, and networking devices. By installing and setting up a SupportAssist application in your IT environment, you can receive the following benefits:

- **Automated issue detection** — SupportAssist monitors your Dell EMC devices and automatically detects hardware issues, both proactively and predictively.
- **Automated case creation** — When an issue is detected, SupportAssist automatically opens a support case with Dell EMC Technical Support.
- **Automated diagnostic collection** — SupportAssist automatically collects system state information from your devices and uploads it securely to Dell EMC. This information is used by Dell EMC Technical Support to troubleshoot the issue.
- **Proactive contact** — A Dell EMC Technical Support agent contacts you about the support case and helps you resolve the issue.

The available benefits vary depending on the Dell EMC Service entitlement purchased for your device. For more information about SupportAssist, go to [www.dell.com/supportassist](http://www.dell.com/supportassist).


## Recycling or End-of-Life service information

Take back and recycling services are offered for this product in certain countries. If you want to dispose of system components, visit [www.dell.com/recyclingworldwide](http://www.dell.com/recyclingworldwide) and select the relevant country.

## Documentation resources

This section provides information about the documentation resources for your system.

To view the document that is listed in the documentation resources table:

- From the Dell EMC support site:
  1. Click the documentation link that is provided in the Location column in the table.
  2. Click the required product or product version.
-  **NOTE:** To locate the product name and model, see the front of your system.
- On the Product Support page, click **Manuals & documents**.
- Using search engines:
  - Type the name and version of the document in the search box.

**Table 31. Documentation resources**

Task	Document	Location
Setting up your system	<p>For more information about installing and securing the system into a rack, see the Rail Installation Guide included with your rack solution.</p> <p>For information about setting up your system, see the <i>Getting Started Guide</i> document that is shipped with your system.</p>	<a href="https://www.dell.com/poweredgemanuals">https://www.dell.com/poweredgemanuals</a>
Configuring your system	<p>For information about the iDRAC features, configuring and logging in to iDRAC, and managing your system remotely, see the Integrated Dell Remote Access Controller User's Guide.</p> <p>For information about understanding Remote Access Controller Admin (RACADM) subcommands and supported RACADM interfaces, see the RACADM CLI Guide for iDRAC.</p> <p>For information about Redfish and its protocol, supported schema, and Redfish Eventing implemented in iDRAC, see the Redfish API Guide.</p> <p>For information about iDRAC property database group and object descriptions, see the Attribute Registry Guide.</p> <p>For information about Intel QuickAssist Technology, see the Integrated Dell Remote Access Controller User's Guide.</p>	<a href="https://www.dell.com/poweredgemanuals">https://www.dell.com/poweredgemanuals</a>
	<p>For information about earlier versions of the iDRAC documents.</p> <p>To identify the version of iDRAC available on your system, on the iDRAC web interface, click <b>? &gt; About</b>.</p>	<a href="https://www.dell.com/idracmanuals">https://www.dell.com/idracmanuals</a>
	For information about installing the operating system, see the operating system documentation.	<a href="https://www.dell.com/operatingsystemmanuals">https://www.dell.com/operatingsystemmanuals</a>

**Table 31. Documentation resources (continued)**

Task	Document	Location
	For information about updating drivers and firmware, see the Methods to download firmware and drivers section in this document.	<a href="http://www.dell.com/support/drivers">www.dell.com/support/drivers</a>
Managing your system	For information about system management software offered by Dell, see the Dell OpenManage Systems Management Overview Guide.	<a href="https://www.dell.com/poweredgemanuals">https://www.dell.com/poweredgemanuals</a>
	For information about setting up, using, and troubleshooting OpenManage, see the Dell OpenManage Server Administrator User's Guide.	<a href="http://www.dell.com/openmanagemanuals">www.dell.com/openmanagemanuals</a> > OpenManage Server Administrator
	For information about installing, using, and troubleshooting Dell OpenManage Enterprise, see the Dell OpenManage Enterprise User's Guide.	<a href="https://www.dell.com/openmanagemanuals">https://www.dell.com/openmanagemanuals</a>
	For information about installing and using Dell SupportAssist, see the Dell EMC SupportAssist Enterprise User's Guide.	<a href="https://www.dell.com/serviceabilitytools">https://www.dell.com/serviceabilitytools</a>
	For information about partner programs enterprise systems management, see the OpenManage Connections Enterprise Systems Management documents.	<a href="https://www.dell.com/openmanagemanuals">https://www.dell.com/openmanagemanuals</a>
Working with the Dell PowerEdge RAID controllers	For information about understanding the features of the Dell PowerEdge RAID controllers (PERC), Software RAID controllers, or BOSS card and deploying the cards, see the Storage controller documentation.	<a href="http://www.dell.com/storagecontrollermanuals">www.dell.com/storagecontrollermanuals</a>
Understanding event and error messages	For information about the event and error messages generated by the system firmware and agents that monitor system components, go to <a href="http://qrl.dell.com">qrl.dell.com</a> > <b>Look Up</b> > <b>Error Code</b> , type the error code, and then click <b>Look it up</b> .	<a href="http://www.dell.com/qrl">www.dell.com/qrl</a>
Troubleshooting your system	For information about identifying and troubleshooting the PowerEdge server issues, see the Server Troubleshooting Guide.	<a href="https://www.dell.com/poweredgemanuals">https://www.dell.com/poweredgemanuals</a>