

Dell EMC PowerEdge R340

Installation and Service Manual

Notes, cautions, and warnings

 **NOTE:** A NOTE indicates important information that helps you make better use of your product.

 **CAUTION:** A CAUTION indicates either potential damage to hardware or loss of data and tells you how to avoid the problem.

 **WARNING:** A WARNING indicates a potential for property damage, personal injury, or death.

Chapter 1: About this document.....	6
Chapter 2: Dell EMC PowerEdge R340 system overview.....	7
Front view of the system.....	7
Control panels.....	8
Rear view of the system.....	9
Inside the system.....	10
Locating the information tag of your system.....	10
System Information label.....	11
Chapter 3: Initial system setup and configuration.....	15
Setting up your system.....	15
iDRAC configuration.....	15
Options to set up iDRAC IP address.....	15
Log in to iDRAC.....	16
Options to install the operating system.....	16
Methods to download firmware and drivers.....	16
Downloading drivers and firmware.....	17
Chapter 4: Installing and removing system components.....	18
Safety instructions.....	18
Before working inside your system.....	19
After working inside your system.....	19
Recommended tools.....	19
Front bezel.....	19
Removing the optional front bezel.....	19
Installing the optional front bezel.....	20
System cover.....	21
Removing the system cover.....	21
Installing the system cover.....	21
Air shroud.....	23
Removing the air shroud.....	23
Installing the air shroud.....	23
Cooling fans.....	24
Removing the cooling fan blank.....	24
Installing the cooling fan blank.....	25
Removing a cooling fan.....	25
Installing a cooling fan.....	26
Drives.....	27
Removing a drive blank.....	27
Installing the drive blank.....	28
Removing the drive carrier.....	28
Installing the drive carrier.....	29
Removing the drive from the drive carrier.....	30

Installing the drive into the drive carrier.....	31
Removing a 2.5 inch drive from the 3.5 inch drive adapter.....	32
Installing a 2.5 inch drive into the 3.5 inch drive adapter.....	33
Intrusion switch.....	34
Removing the intrusion switch.....	34
Installing the intrusion switch.....	35
System memory.....	36
System memory guidelines.....	36
General memory module installation guidelines.....	37
Removing a memory module.....	38
Installing a memory module.....	38
Expansion cards and expansion card risers.....	39
Expansion card installation guidelines.....	40
Removing the expansion card riser.....	41
Installing the expansion card riser.....	42
Removing an expansion card from the expansion card riser.....	43
Installing an expansion card into the expansion card riser.....	45
Storage controller card.....	46
Removing the PERC card.....	46
Installing the PERC card.....	47
System battery.....	48
Replacing the system battery.....	48
Optional internal USB memory key.....	50
Replacing the optional internal USB memory key.....	50
Optional optical drive.....	50
Removing the optical drive.....	50
Installing the optional optical drive.....	51
Processor and heat sink.....	52
Removing the heat sink.....	52
Removing the processor.....	53
Installing the processor.....	54
Installing the heat sink.....	55
Optional IDSDM or vFlash module.....	56
Removing the optional IDSDM or vFlash card.....	56
Installing optional IDSDM or vFlash card.....	56
Removing the MicroSD card.....	57
Installing the MicroSD card.....	58
M.2 SSD module.....	59
Removing the M.2 SSD module.....	59
Installing the M.2 SSD module.....	60
Drive backplane.....	61
Drive backplane.....	61
Removing the drive backplane.....	62
Installing the drive backplane.....	63
Cable routing.....	64
Power supply unit.....	65
Hot spare feature.....	65
Removing a power supply unit blank.....	66
Installing a power supply unit blank.....	66
Removing a power supply unit.....	67

Installing a power supply unit.....	68
Power distribution board.....	68
Removing the power distribution board.....	68
Installing the power distribution board.....	69
System board.....	70
Removing the system board.....	70
Installing the system board.....	72
Trusted Platform Module.....	74
Upgrading the Trusted Platform Module.....	74
Initializing TPM for BitLocker users.....	75
Initializing the TPM 1.2 for TXT users.....	75
Initializing the TPM 2.0 for TXT users.....	75
Control panel.....	76
Removing the left control panel.....	76
Installing the left control panel.....	76
Removing the right control panel.....	77
Installing the right control panel.....	78
Chapter 5: Jumpers and connectors	80
System board connectors.....	80
System board jumper settings.....	81
Disabling forgotten password.....	81
Chapter 6: System diagnostics and indicator codes	83
System health and system ID indicator codes.....	83
iDRAC Direct LED indicator codes.....	84
NIC indicator codes.....	84
Power supply unit indicator codes.....	85
Drive indicator codes.....	86
System diagnostics.....	86
Dell Embedded System Diagnostics.....	86
Chapter 7: Getting help.....	88
Contacting Dell.....	88
Recycling or End-of-Life service information.....	88
Accessing system information by using QRL.....	88
Quick Resource Locator for Dell EMC PowerEdge R340 system.....	89
Receiving automated support with SupportAssist	89
Chapter 8: Documentation resources.....	90

About this document

This document provides an overview about the system, information about installing and replacing components, technical specifications, diagnostic tools, and guidelines to be followed while installing certain components.

Dell EMC PowerEdge R340 system overview

The Dell EMC PowerEdge R340 system is a 1U server that supports:

- One Intel Xeon, Core i3, Pentium, or Celeron processor
- Four DIMM slots
- Two AC power supply units
- Up to eight 2.5-inch or four 3.5-inch SAS, SATA drives.

For more information, see the Dell EMC PowerEdge R340 Technical Specifications on the product documentation page.

NOTE: All instances of SAS, SATA drives, and SSDs are referred to as drives in this document, unless specified otherwise.

Topics:

- [Front view of the system](#)
- [Rear view of the system](#)
- [Inside the system](#)
- [Locating the information tag of your system](#)
- [System Information label](#)

Front view of the system

NOTE: The 8 x 2.5-inch configuration is shorter than the 4 x 3.5-inch configuration.

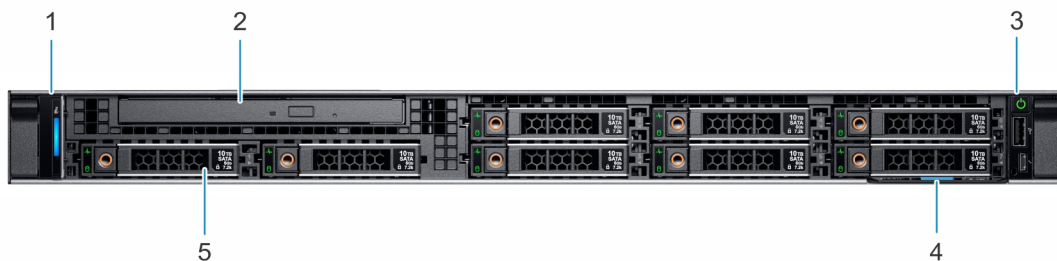

Figure 1. Front view of the 8 x 2.5-inch drive system

- | | |
|------------------------|-----------------------------|
| 1. Left control panel | 2. Optical drive (optional) |
| 3. Right control panel | 4. Information tag |
| 5. Drives (8) | |



Figure 2. Front view of the 4 x 3.5-inch drive system

- | | |
|------------------------|-----------------------------|
| 1. Left control panel | 2. Optical drive (optional) |
| 3. Right control panel | 4. Information tag |
| 5. Drives (4) | |

For more information, see the Dell EMC PowerEdge R340 Technical Specifications on the product documentation page.

Control panels

Left control panel



Figure 3. Left control panel view

1. System health and system ID indicator

Right control panel



Figure 4. Right control panel view

1. Power button
2. USB 2.0-compliant port
3. iDRAC direct Micro USB port

NOTE: For more information on the ports, see the Dell EMC PowerEdge R240 Technical Specifications.

Rear view of the system

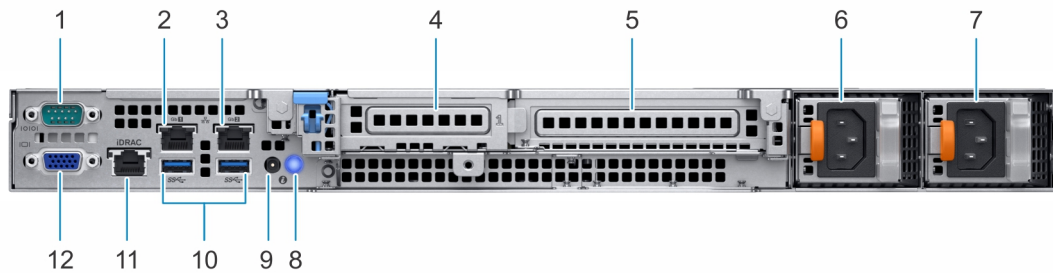

Figure 5. Rear view of the system

- 1. Serial port
- 2. NIC port (GB 1)
- 3. NIC port (GB 2)
- 4. Half-height PCIe expansion card slot
- 5. Full-height PCIe expansion card slot
- 6. Power supply unit 1
- 7. Power supply unit 2
- 8. System identification button
- 9. System status indicator cable port (CMA)
- 10. USB 3.0 port (2)
- 11. iDRAC9 dedicated network port
- 12. VGA port

NOTE: For more information about the ports and connectors, see the Dell EMC PowerEdge R340 Technical Specifications Guide.

For more information, see the Dell EMC PowerEdge R340 Technical Specifications on the product documentation page.

Inside the system

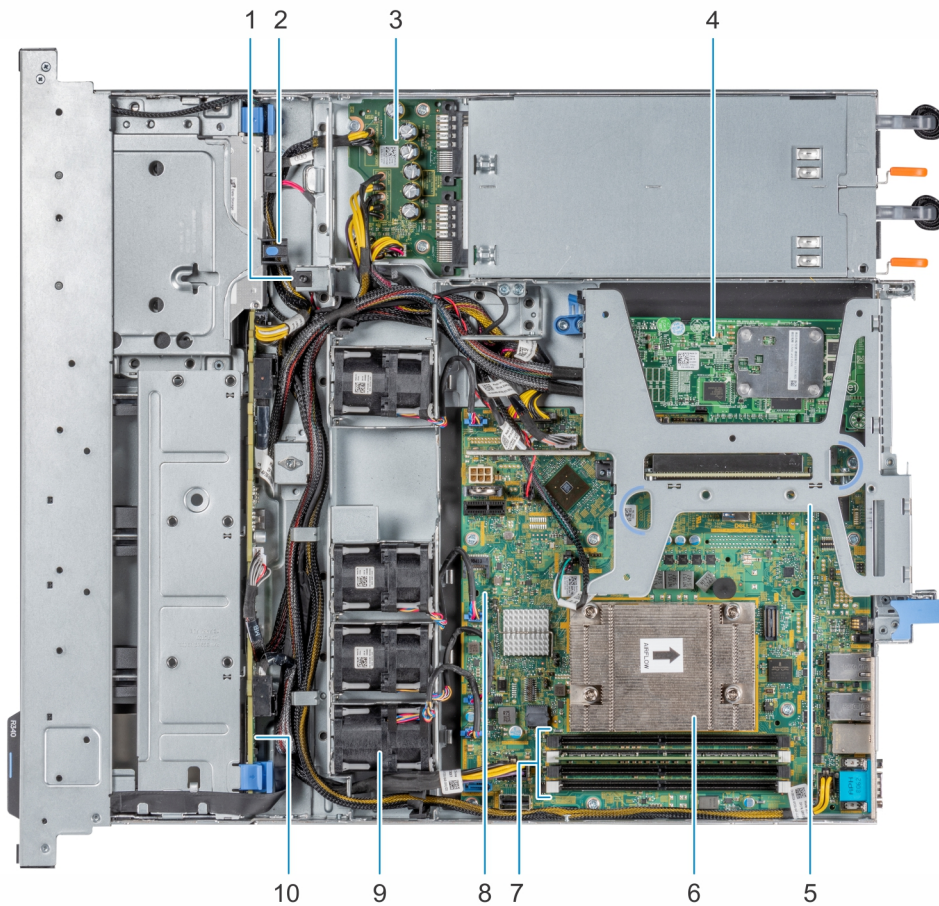

Figure 6. Inside the system

- | | |
|-----------------------------|---------------------|
| 1. Intrusion switch | 2. Optical drive |
| 3. Power distribution board | 4. PERC card |
| 5. Expansion card riser | 6. Heat sink |
| 7. Memory module sockets | 8. System board |
| 9. Fan (4) | 10. Drive backplane |

Locating the information tag of your system

Your system is identified by a unique Express Service Code and Service Tag number. You can view the Express Service Code and Service Tag by pulling out the information tag located on the front of the system. Alternatively, the information may be on the Mini Enterprise Service Tag (MEST) label on the chassis, on the rear of the system. This information is used by Dell to route support calls to the appropriate personnel.

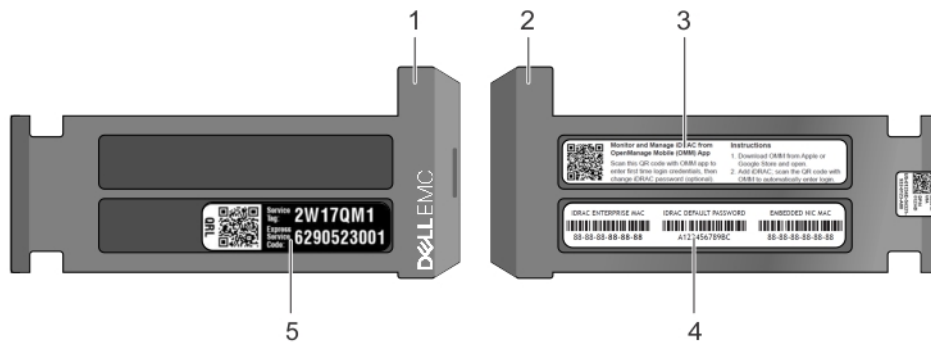

Figure 7. Locating Service Tag of your system

1. Information tag (front view)
2. Information tag (back view)
3. OpenManage Mobile (OMM) label
4. iDRAC MAC address and iDRAC secure password label
5. Service Tag, Express Service Code, QRL label

System Information label

PowerEdge R340 – System Information Label

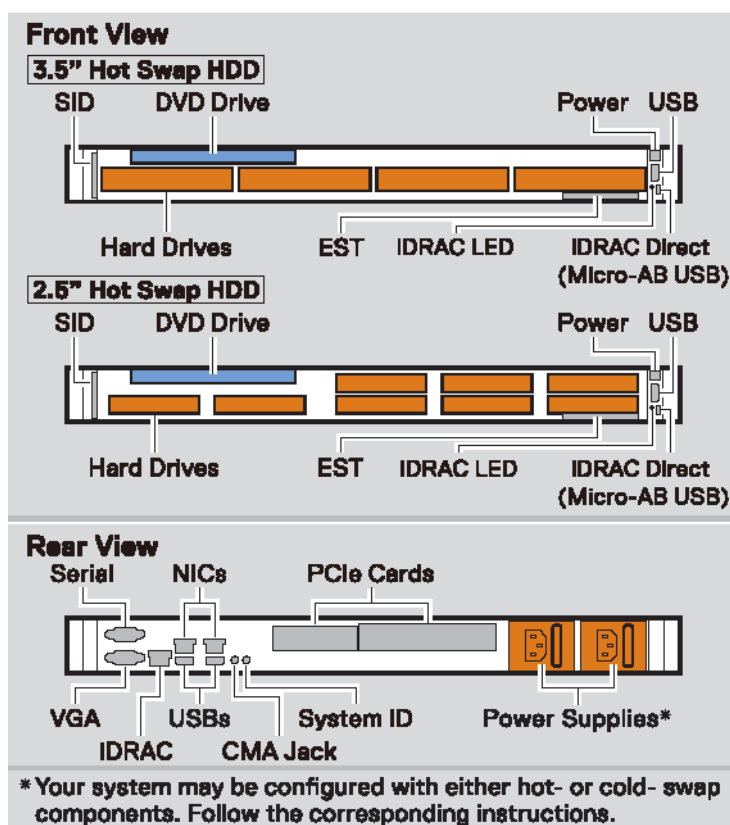

Figure 8. Front and rear view configuration





Jumper Settings		
Jumper	Setting	Description
PWRD_EN	 (default)	BIOS password is enabled.
		BIOS password is disabled. iDRAC local access is unlocked at next AC power cycle.
	 (default)	BIOS configuration settings retained at system boot.
NVRAM_CLR		BIOS configuration settings cleared at system boot.

Figure 9. Jumper settings

Memory Information

⚠ Caution: Memory (DIMMs) and CPUs may be hot during servicing.

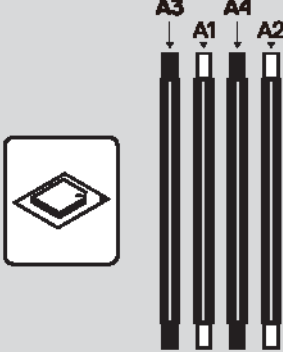

Memory Population

Configuration	Sequence
Memory-Optimized	1, 2, 3, 4

Memory Sparing details are documented in the *Installation and Service Manual*.

Figure 10. Memory information

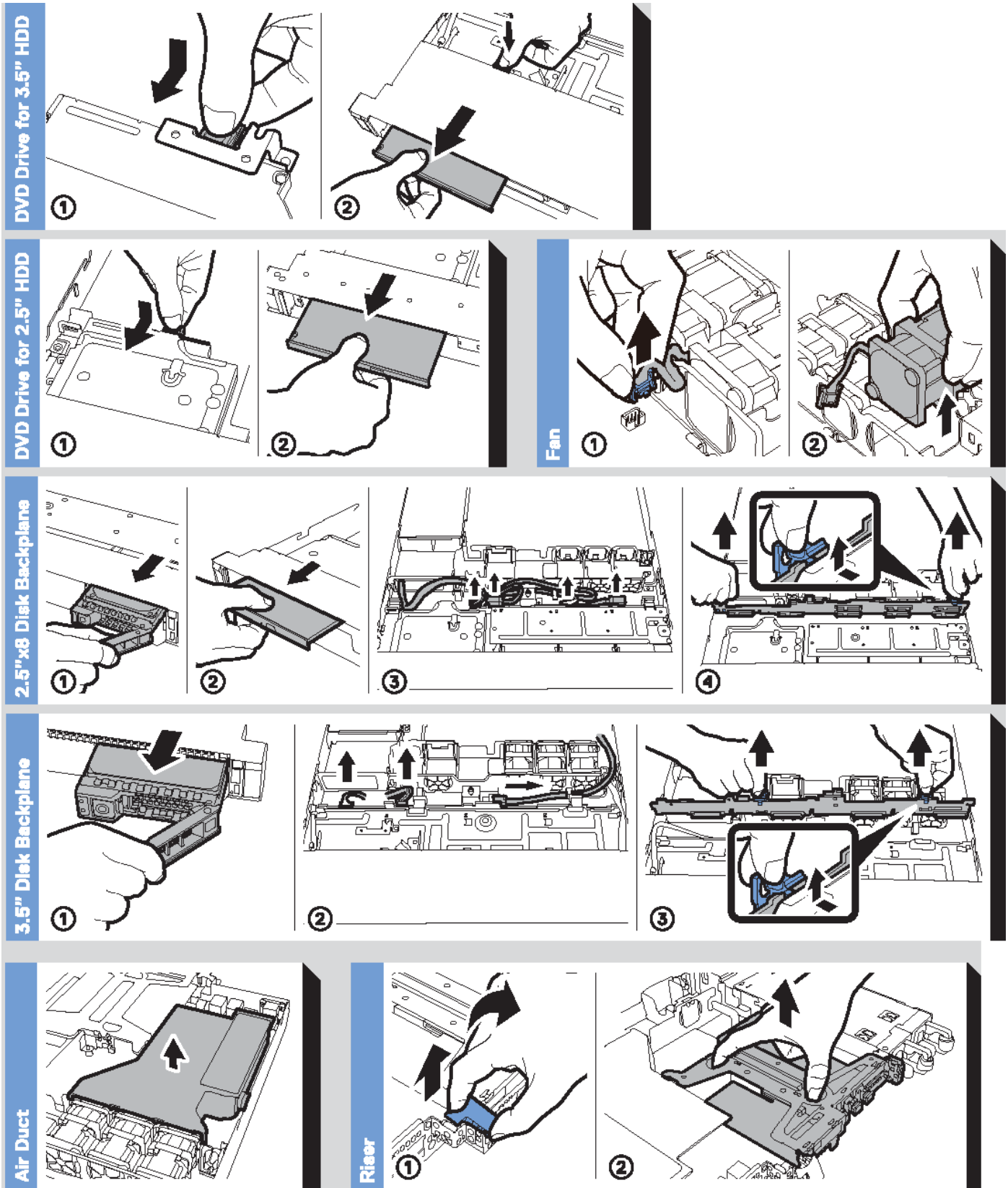

Figure 11. System information

Electrical Overview

System Board Information

- | | |
|-------------------------------------|-------------------------------|
| 1 Internal Storage Connector | 13 FAN 2 |
| 2 Riser Connector | 14 ID Button |
| 3 Internal USB | 15 TPM |
| 4 Jumper | 16 IDSDM + vFlash |
| 5 CPU Power | 17 Battery |
| 6 DIMMs | 18 HDD/ODD Power |
| 7 CPU | 19 FAN 1 |
| 8 SATA 0-3 | 20 Control Panel |
| 9 SATA ODD | 21 PIB Connector |
| 10 System Power | 22 Backplane Signal |
| 11 FAN 4 | 23 Intrusion Connector |
| 12 FAN 3 | |

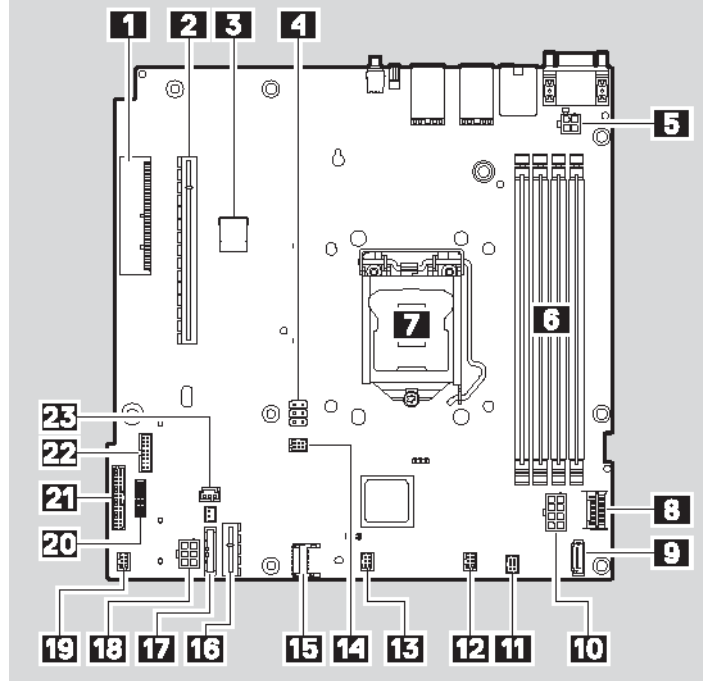

Figure 12. Electrical overview

Initial system setup and configuration

Topics:

- [Setting up your system](#)
- [iDRAC configuration](#)
- [Options to install the operating system](#)

Setting up your system

Perform the following steps to set up your system:

Steps

1. Unpack the system.
2. Install the system into the rack. For more information about installing the system into the rack, see the *Rail Installation Guide* at www.dell.com/poweredgemanuals.
3. Connect the peripherals to the system.
4. Connect the system to its electrical outlet.
5. Power on the system by pressing the power button or by using iDRAC.
6. Power on the attached peripherals.

For more information about setting up your system, see the *Getting Started Guide* that shipped with your system.

For information on how to manage basic settings and features of the system, see the Dell EMC PowerEdge R340 BIOS and UEFI Reference Guide on the product documentation page.

iDRAC configuration

The Integrated Dell Remote Access Controller (iDRAC) is designed to make system administrators more productive and improve the overall availability of Dell systems. iDRAC alerts administrators about system issues and enables them to perform remote system management. This reduces the need for physical access to the system.

Options to set up iDRAC IP address

To enable communication between your system and iDRAC, you must first configure the network settings based on your network infrastructure.

 **NOTE:** For static IP configuration, you must request for it at the time of purchase.

This option is set to **DHCP** by Default. You can set up the IP address by using one of the following interfaces:

Interfaces	Document/Section
iDRAC Settings utility	<i>Dell Integrated Dell Remote Access Controller User's Guide</i> at www.dell.com/poweredgemanuals
Dell Deployment Toolkit	<i>Dell Deployment Toolkit User's Guide</i> at www.dell.com/openmanagemanuals > OpenManage Deployment Toolkit
Dell Lifecycle Controller	<i>Dell Lifecycle Controller User's Guide</i> at www.dell.com/poweredgemanuals

 **NOTE:** To access iDRAC, ensure that you connect the ethernet cable to the iDRAC9 dedicated network port. You can also access iDRAC through the shared LOM mode, if you have opted for a system that has the shared LOM mode enabled.

Log in to iDRAC

You can log in to iDRAC as:

- iDRAC user
- Microsoft Active Directory user
- Lightweight Directory Access Protocol (LDAP) user

If you have opted for secure default access to iDRAC, you must use the iDRAC secure default password available on the system Information tag. If you have not opted for secure default access to iDRAC, then use the default user name and password `-root` and `calvin`. You can also log in by using your Single Sign-On or Smart Card.

 **NOTE:** You must have the iDRAC credentials to log in to iDRAC.

 **NOTE:** Ensure that you change the default username and password after setting up the iDRAC IP address.

For more information about logging in to the iDRAC and iDRAC licenses, see the latest *Integrated Dell Remote Access Controller User's Guide* at www.dell.com/poweredgemanuals.

You can also access iDRAC by using RACADM. For more information, see the *RACADM Command Line Interface Reference Guide* at www.dell.com/poweredgemanuals.

Options to install the operating system

If the system is shipped without an operating system, install a supported operating system by using one of the following resources:

Table 1. Resources to install the operating system

Resources	Location
iDRAC	www.dell.com/idracmanuals
Lifecycle Controller	www.dell.com/idracmanuals > Lifecycle Controller
OpenManage Deployment Toolkit	www.dell.com/openmanagemanuals > OpenManage Deployment Toolkit
Dell certified VMware ESXi	www.dell.com/virtualizationsolutions
Installation and How-to videos for supported operating systems on PowerEdge systems	Supported Operating Systems for Dell EMC PowerEdge systems

Methods to download firmware and drivers

You can download the firmware and drivers by using any of the following methods:

Table 2. Firmware and drivers

Methods	Location
From the Dell EMC support site	www.dell.com/support/home
Using Dell Remote Access Controller Lifecycle Controller (iDRAC with LC)	www.dell.com/idracmanuals
Using Dell Repository Manager (DRM)	www.dell.com/openmanagemanuals > Repository Manager
Using Dell OpenManage Essentials	www.dell.com/openmanagemanuals > OpenManage Essentials
Using Dell OpenManage Enterprise	www.dell.com/openmanagemanuals > OpenManage Enterprise
Using Dell Server Update Utility (SUU)	www.dell.com/openmanagemanuals > Server Update Utility

Table 2. Firmware and drivers (continued)

Methods	Location
Using Dell OpenManage Deployment Toolkit (DTK)	www.dell.com/openmanagemanuals > OpenManage Deployment Toolkit
Using iDRAC virtual media	www.dell.com/idracmanuals

Downloading drivers and firmware

Dell EMC recommends that you download and install the latest BIOS, drivers, and systems management firmware on your system.

Prerequisites

Ensure that you clear the web browser cache before downloading the drivers and firmware.

Steps

1. Go to www.dell.com/support/home.
2. In the **Drivers & Downloads** section, type the Service Tag of your system in the **Enter a Service Tag or product ID** box, and then click **Submit**.

 **NOTE:** If you do not have the Service Tag, select **Detect Product** to allow the system to automatically detect the Service Tag, or click **View products**, and navigate to your product.

3. Click **Drivers & Downloads**.
The drivers that are applicable to your system are displayed.
4. Download the drivers to a USB drive, CD, or DVD.

Installing and removing system components

Topics:

- Safety instructions
- Before working inside your system
- After working inside your system
- Recommended tools
- Front bezel
- System cover
- Air shroud
- Cooling fans
- Drives
- Intrusion switch
- System memory
- Expansion cards and expansion card risers
- Storage controller card
- System battery
- Optional internal USB memory key
- Optional optical drive
- Processor and heat sink
- Optional IDSDM or vFlash module
- M.2 SSD module
- Drive backplane
- Cable routing
- Power supply unit
- Power distribution board
- System board
- Trusted Platform Module
- Control panel

Safety instructions

 **NOTE:** Whenever you need to lift the system, get others to assist you. To avoid injury, do not attempt to lift the system by yourself.

 **WARNING:** Opening or removing the system cover while the system is powered on may expose you to a risk of electric shock.

 **CAUTION:** Do not operate the system without the cover for a duration exceeding five minutes. Operating the system without the system cover can result in component damage.

 **CAUTION:** Many repairs may only be done by a certified service technician. You should only perform troubleshooting and simple repairs as authorized in your product documentation, or as directed by the online or telephone service and support team. Damage due to servicing that is not authorized by Dell is not covered by your warranty. Read and follow the safety instructions that are shipped with your product.

 **CAUTION:** To ensure proper operation and cooling, all bays in the system and system fans must be always populated with a component or a blank.

 **NOTE:** It is recommended that you always use an antistatic mat and antistatic strap while working on components inside the system.

Before working inside your system

Prerequisites

Follow the safety guidelines listed in [Safety instructions](#).

Steps

1. Power off the system and all attached peripherals.
2. Disconnect the system from the electrical outlet, and disconnect the peripherals.
3. If applicable, remove the system from the rack.
For more information, see the *Rail Installation Guide* at www.dell.com/poweredgemanuals.
4. Remove the system cover.

After working inside your system

Prerequisites

Follow the safety guidelines listed in [Safety instructions](#).

Steps

1. Replace the system cover.
2. If applicable, install the system into the rack.
For more information, see the *Rail Installation Guide* at www.dell.com/poweredgemanuals.
3. Reconnect the peripherals and connect the system to the electrical outlet.
4. Power on the attached peripherals and then power on the system.

Recommended tools

You need the following tools to perform the removal and installation procedures:

- Key to the bezel lock
The key is required only if your system includes a bezel.
- Phillips #1 screwdriver
- Phillips #2 screwdriver
- Torx #T15 screwdriver
- Plastic scribe
- 1/4 inch flat blade screwdriver
- Wrist grounding strap connected to the ground
- ESD mat

Front bezel

Removing the optional front bezel

Prerequisites

1. Follow the safety guidelines listed in the [Safety instructions](#).

 **NOTE:** The bezel key is part of the bezel package.

Steps

1. Unlock the bezel.
2. Press the release button, and remove the left end of the bezel.
3. Slide the tabs on the right end of the bezel out of the slots on the chassis and remove the bezel.



Figure 13. Removing the optional front bezel

Installing the optional front bezel

Prerequisites

1. Follow the safety guidelines listed in the [Safety instructions](#).

NOTE: The bezel key is part of the bezel package.

Steps

1. Align and insert the tabs on the bezel into the slots on the chassis.
2. Press the bezel until the release button clicks in place.
3. Lock the bezel.



Figure 14. Installing the optional front bezel

System cover

Removing the system cover

Prerequisites

1. Follow the safety guidelines listed in the [Safety instructions](#).
2. Power off the system, including any attached peripherals.
3. Disconnect the system from the electrical outlet and peripherals.

Steps

1. Use a 1/4 inch flat head or a Phillips #2 screwdriver to turn the lock counterclockwise to the unlock position.
2. Open the release latch until the system cover slides back.
3. Lift the cover from the system.

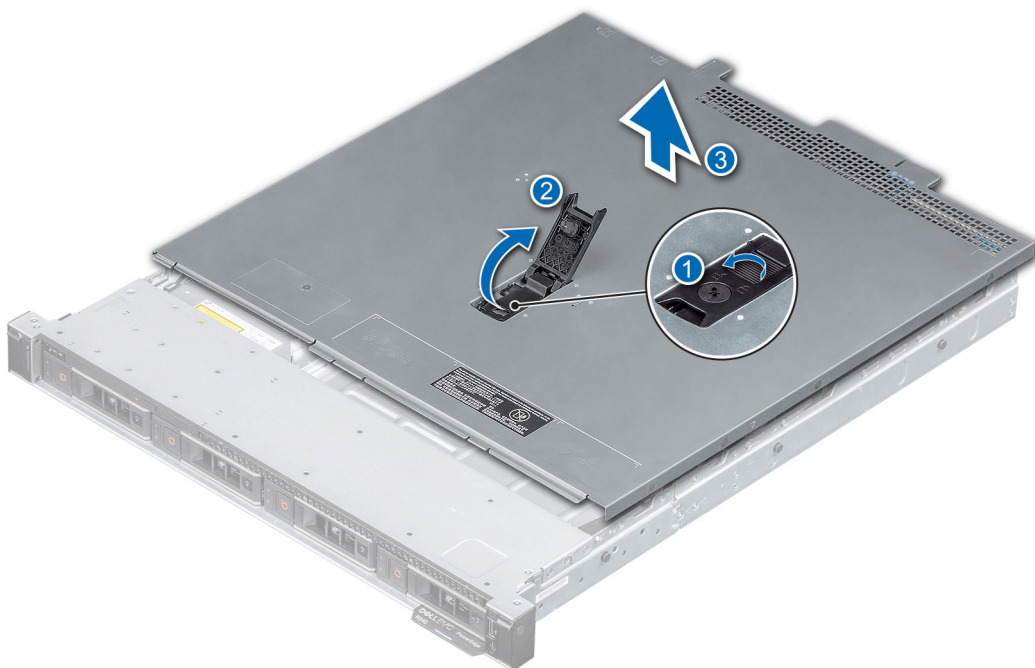

Figure 15. Removing the system cover

Next steps

1. [Replace the system cover](#).

Installing the system cover

Prerequisites

1. Follow the safety guidelines listed in the [Safety instructions](#).
2. Follow the procedure listed in the [Before working inside your system](#).
3. Ensure that all internal cables are connected and placed out of the way, and no tools or extra parts are left inside the system.

Steps

1. Align the tabs on the system cover with the guide slots on the chassis.
2. Close the system cover release latch.

3. Using a 1/4 inch flat head or Phillips #2 screwdriver, turn the lock clockwise to the lock position.



Figure 16. Installing the system cover

Next steps

1. Follow the procedure listed in the [After working inside your system.](#)

Air shroud

Removing the air shroud

Prerequisites

CAUTION: Never operate your system with the air shroud removed. The system may get overheated, resulting in shutdown of the system and loss of data.

1. Follow the safety guidelines listed in [Safety instructions](#).
2. Follow the procedure listed in [Before working inside your system](#).

CAUTION: Never operate your system with the air shroud removed. The system may get overheated quickly, resulting in shutdown of the system and loss of data.

Steps

Using the blue touch points, lift the air shroud out of the system.

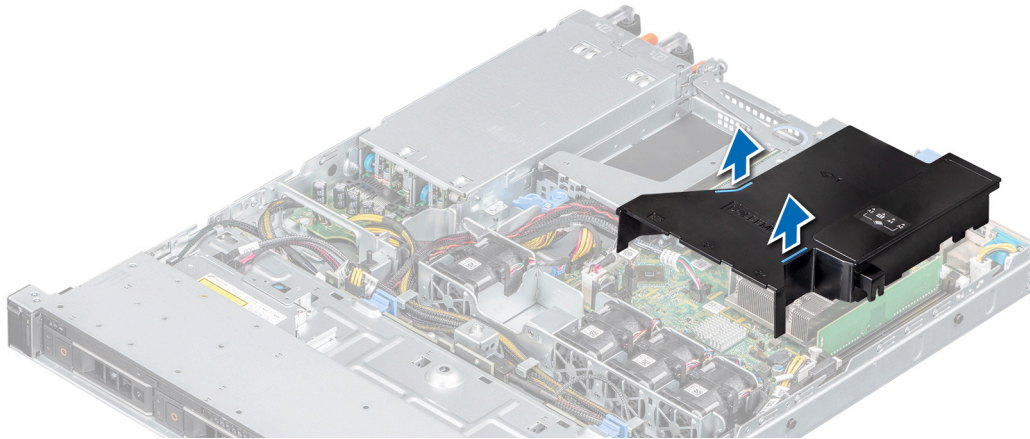

Figure 17. Removing the air shroud

Next steps

1. [Replace the air shroud](#).

Installing the air shroud

Prerequisites

1. Follow the safety guidelines listed in [Safety instructions](#).
2. Follow the procedure listed in [Before working inside your system](#).

Steps

1. Align the slot on the air shroud with the standoff on the chassis.

NOTE: Route the cable properly to prevent the cable from being pinched or crimped.

2. Lower the air shroud into the system until it is firmly seated.

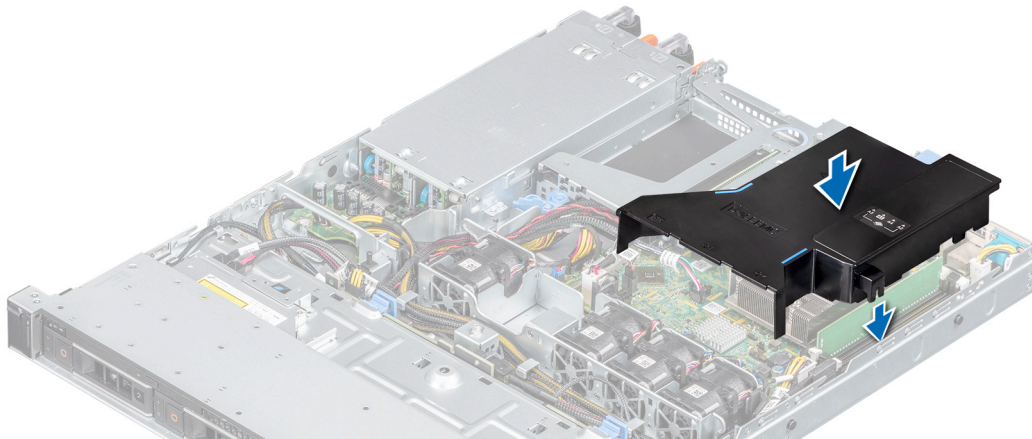

Figure 18. Installing the air shroud

Next steps

1. Follow the procedure listed in [After working inside your system.](#)

Cooling fans

Removing the cooling fan blank

Prerequisites

1. Follow the safety guidelines listed in [Safety instructions.](#)
2. Follow the procedure listed in the [Before working inside your system.](#)

Steps

1. Press the release tab to disengage the blank from the cooling fan cage.
2. Lift the cooling fan blank out of the fan cage.

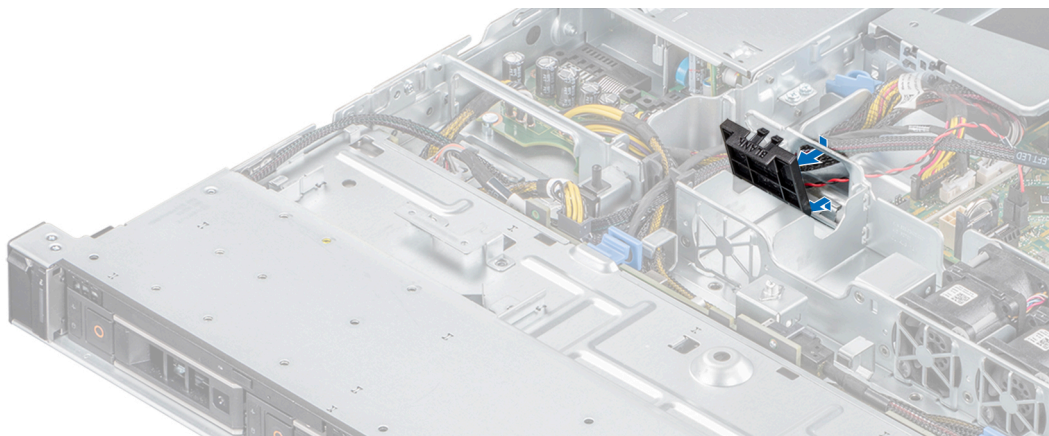

Figure 19. Removing a fan blank

Next steps

1. [Install the cooling fan](#) or [replace the cooling fan blank.](#)

Installing the cooling fan blank

Prerequisites

1. Follow the safety guidelines listed in [Safety instructions](#).
2. Follow the procedure listed in the [Before working inside your system](#).

Steps

1. Holding the release tab, insert the fan blank into the slots on the cooling fan cage.
2. Press the fan blank until it clicks into place.

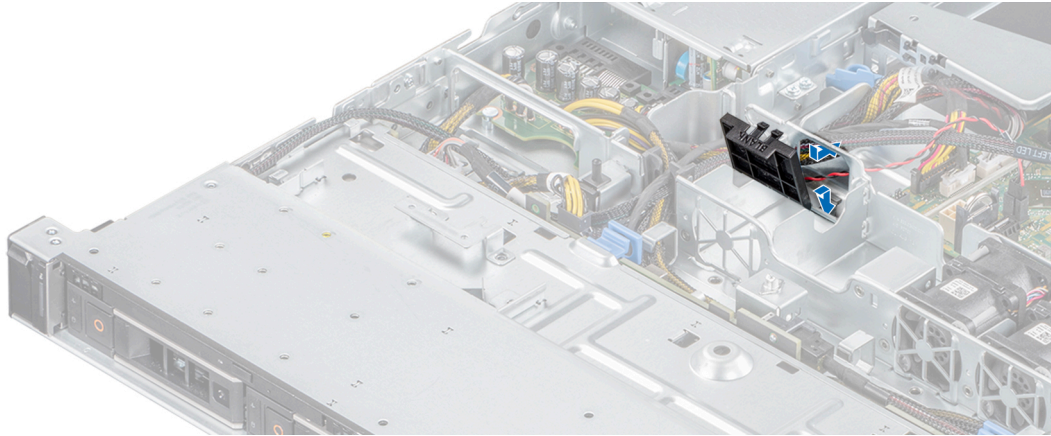



Figure 20. Installing a fan blank

Next steps

1. Follow the procedure listed in the [After working inside your system](#).

Removing a cooling fan

Prerequisites

1.  **WARNING:** Opening or removing the system cover when the system is on may expose you to a risk of electric shock. Exercise utmost care while removing or installing the fans.

Follow the safety guidelines listed in the [Safety instructions](#).

2. Follow the procedure listed in the [Before working inside your system](#).
3. [Remove the air shroud](#).

Steps

1. Press the release tabs on the fan cable connector and disconnect the cable from the system board.

 **NOTE:** Observe the routing of the cable as you remove it from the system.

2. Lift the cooling fan out of the cooling fan cage.

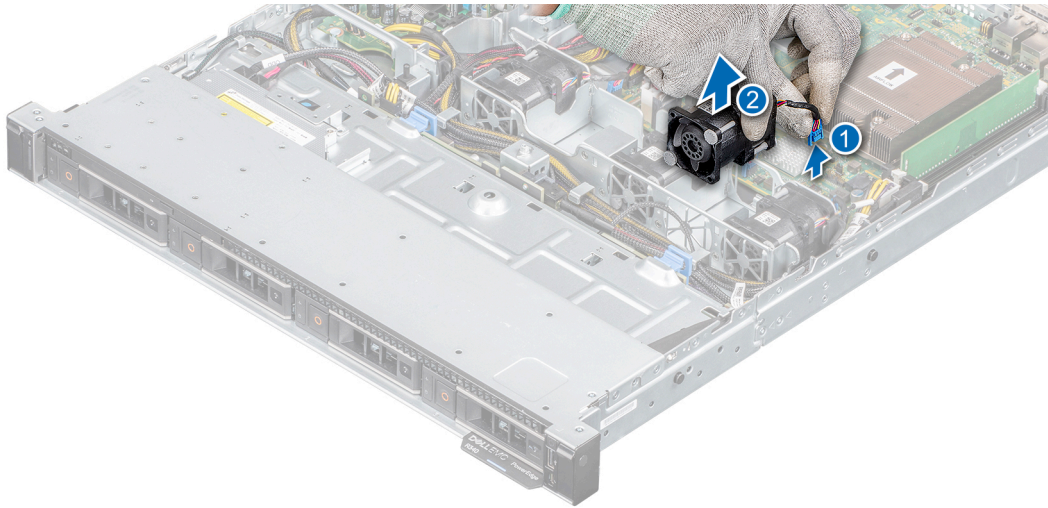

Figure 21. Removing a fan

Next steps

1. [Replace the cooling fan or install the cooling fan blank.](#)
2. [Replace the air shroud.](#)

Installing a cooling fan

Prerequisites

1. Follow the safety guidelines listed in the [Safety instructions](#).
2. Follow the procedure listed in the [Before working inside your system](#).
3. [Remove the air shroud.](#)
4. If installed, [remove the cooling fan blank.](#)

Steps

1. Lower the cooling fan into the fan cage.
2. Press the release tabs on the fan cable connector and connect the cable to the system board.

NOTE: Route the cable properly to prevent the cable from being pinched or crimped.

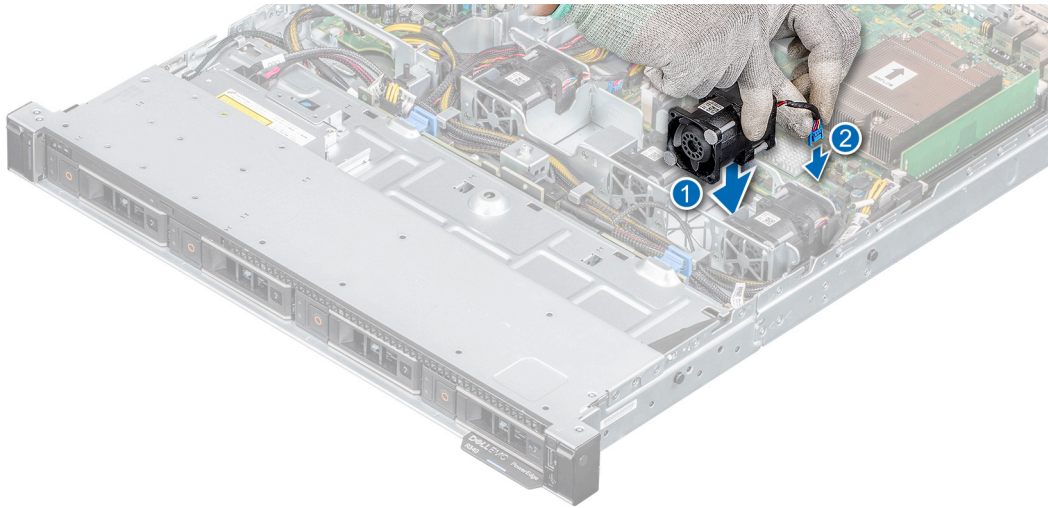

Figure 22. Installing a fan

Next steps

1. [Install the air shroud.](#)
2. Follow the procedure listed in the [After working inside your system.](#)

Drives

Removing a drive blank

Prerequisites

1. Follow the safety guidelines listed in [Safety instructions.](#)
2. If installed, [remove the front bezel.](#)

CAUTION: To maintain proper system cooling, drive blanks must be installed in all empty drive slots.

CAUTION: Mixing drive blanks from previous generations of PowerEdge servers is not supported.

Steps

Press the release button, and slide the drive blank out of the drive slot.

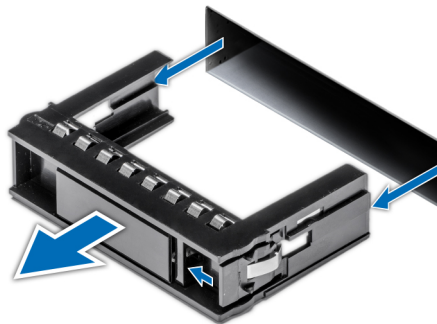

Figure 23. Removing a drive blank

Next steps

1. [Install a drive or replace the drive blank.](#)

Installing the drive blank

Prerequisites

1. Follow the safety guidelines listed in [Safety instructions](#).
2. If installed, [remove the front bezel](#).

Steps

Insert the drive blank into the drive slot, and push the blank until the release button clicks into place.

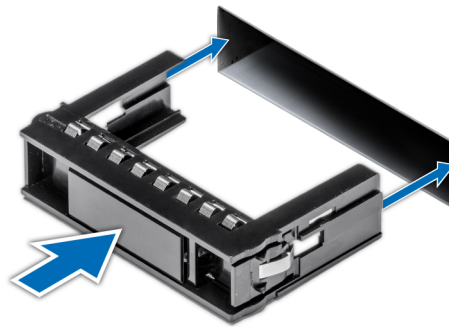

Figure 24. Installing the drive blank

Next steps

1. [Install the front bezel](#).

Removing the drive carrier

Prerequisites

1. Follow the safety guidelines listed in [Safety instructions](#).
2. Using the management software, prepare the drive for removal.

If the drive is online, the green activity or fault indicator flashes while the drive is turning off. When the drive indicators are off, the drive is ready for removal. For more information, see the documentation for the storage controller.

CAUTION: Before attempting to remove or install a drive while the system is running, see the documentation for the storage controller card to ensure that the host adapter is configured correctly to support drive removal and insertion.

CAUTION: To prevent data loss, ensure that your operating system supports drive installation. See the documentation supplied with your operating system.

3. If installed, [remove the front bezel](#).

Steps

1. Press the release button to open the drive carrier release handle.
2. Holding the drive carrier release handle, slide the drive carrier out of the drive slot.



Figure 25. Removing the drive carrier

Next steps

1. [Install a drive carrier or a drive blank.](#)

Installing the drive carrier

Prerequisites

- ⚠ **CAUTION:** Before removing or installing a drive while the system is running, see the documentation for the storage controller card to ensure that the host adapter is configured correctly to support drive removal and insertion.
- ⚠ **CAUTION:** Combining SAS and SATA drives in the same RAID volume is not supported.
- ⚠ **CAUTION:** When installing a drive, ensure that the adjacent drives are fully installed. Inserting a drive carrier and attempting to lock its handle next to a partially installed carrier can damage the partially installed carrier's shield spring and make it unusable.
- ⚠ **CAUTION:** To prevent data loss, ensure that your operating system supports hot-swap drive installation. See the documentation supplied with your operating system.
- ⚠ **CAUTION:** When a replacement hot swappable drive is installed and the system is powered on, the drive automatically begins to rebuild. Ensure that the replacement drive is blank or contains data that you wish to overwrite. Any data on the replacement drive is immediately lost after the drive is installed.

i **NOTE:** Ensure that the drive carrier's release handle is in the open position before inserting the carrier into the slot.

1. Follow the safety guidelines listed in [Safety instructions](#).
2. If installed, [remove the front bezel](#).
3. [Remove the drive carrier or drive blank](#).

Steps

1. Slide the drive carrier into the drive slot.
2. Close the drive carrier release handle to lock the drive in place.



Figure 26. Installing the drive carrier

Next steps

1. If removed, install the front bezel.

Removing the drive from the drive carrier

Prerequisites

1. Follow the safety guidelines listed in [Safety instructions](#).
2. If installed, [remove the front bezel](#).
3. [Remove the drive](#).

Steps

1. Using a Phillips #1 screwdriver, remove the screws from the slide rails on the drive carrier.

i **NOTE:** If the hard drive or SSD carrier has Torx screw, use Torx 6 (for 2.5-inch drive) or Torx 8 (for 3.5-inch drive) screw driver to remove the drive.



2. Lift the drive out of the drive carrier.



Figure 27. Removing the drive from the drive carrier

Next steps

1. [Install the drive into the drive carrier.](#)

Installing the drive into the drive carrier

Prerequisites

1. Follow the safety guidelines listed in [Safety instructions](#).
2. If installed, [remove the front bezel](#).
3. [Remove the drive blank](#).

Steps

1. Insert the drive into the drive carrier with the drive connector facing towards the rear of the carrier.
2. Align the screw holes on the drive with the screws holes on the drive carrier.
3. Using a Phillips #1 screwdriver, replace the screws to secure the drive to the drive carrier.

 **NOTE:** If the hard drive or SSD carrier has Torx screw, use Torx 6 (for 2.5-inch drive) or Torx 8 (for 3.5-inch drive) screw driver to install the drive.



 **NOTE:** When installing a drive into the drive carrier, ensure that the screws are torqued to 4 in-pounds.

 **NOTE:** Use the screws shipped with the drive carrier to secure the drive to the drive carrier.



Figure 28. Installing a drive into the drive carrier

Next steps

1. [Install the drive carrier.](#)
2. If removed, [install the front bezel.](#)

Removing a 2.5 inch drive from the 3.5 inch drive adapter

Prerequisites

1. Follow the safety guidelines listed in [Safety instructions.](#)
2. If installed, [remove the front bezel.](#)
3. [Remove the drive carrier.](#)
4. [Remove the drive adapter from the drive carrier.](#)

Steps

1. Using a Phillips #1 screwdriver, remove the screws that secure the 2.5-inch drive to the 3.5-inch drive adapter.

 **NOTE:** If the 2.5-inch drive has Torx screw, use Torx 6 screwdriver to remove the drive from a 3.5-inch drive adapter.



2. Remove the drive from the 3.5-inch drive adapter.

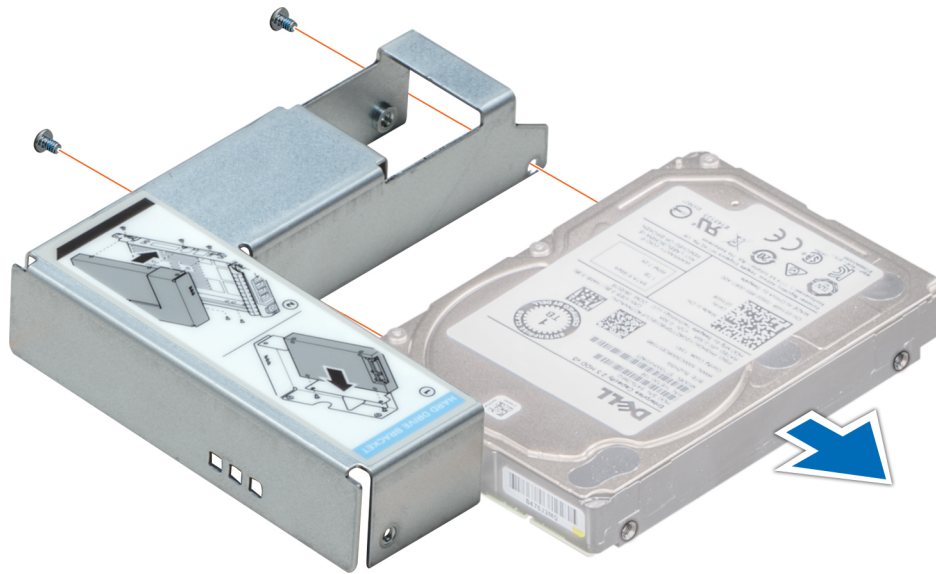

Figure 29. Removing a 2.5-inch drive from the 3.5-inch drive adapter

Next steps

1. Install a 2.5-inch drive into the 3.5-inch drive adapter.

Installing a 2.5 inch drive into the 3.5 inch drive adapter

Prerequisites

1. Follow the safety guidelines listed in [Safety instructions](#).
2. If installed, [remove the front bezel](#).
3. [Remove the drive carrier](#).

Steps

1. Align the screw holes on the 2.5-inch drive with the screw holes on the 3.5-inch drive adapter.
2. Using a Phillips #1 screwdriver, install the screws to secure the drive to the 3.5-inch drive adapter.

 **NOTE:** If the 2.5-inch drive has Torx screw, use Torx 6 screwdriver to install the drive to a 3.5-inch drive adapter.



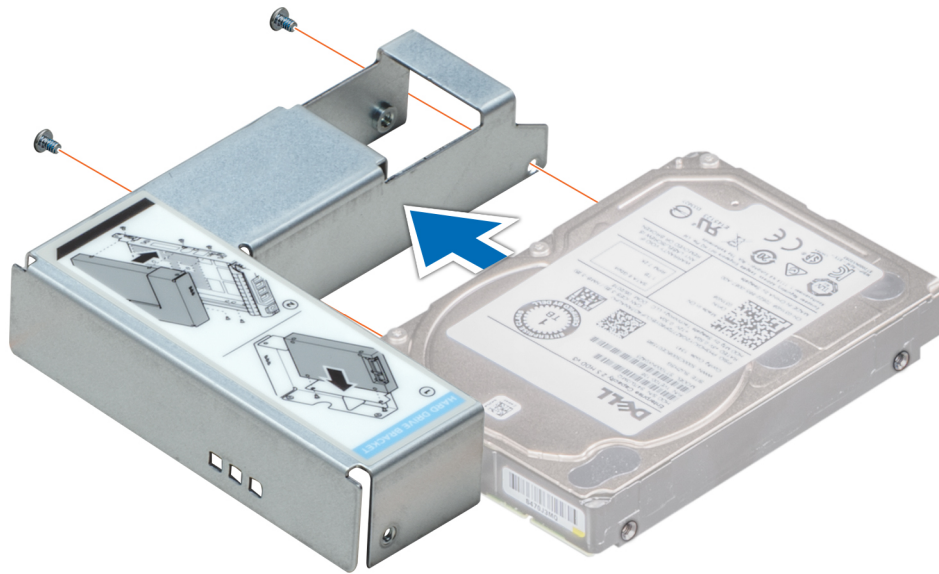

Figure 30. Installing a 2.5-inch drive into the 3.5-inch drive adapter

Next steps

1. Install the drive adapter into the drive carrier.
2. Install the drive carrier.
3. If removed, install the front bezel.

Intrusion switch

Removing the intrusion switch

Prerequisites

1. Follow the safety guidelines listed in [Safety instructions](#).
2. Follow the procedure listed in the [Before working inside your system](#).
3. Keep the plastic scribe ready.

Steps

1. Disconnect and remove the intrusion switch cable connector from connector on the system board.

NOTE: Observe the routing of the cable as you remove it from the system.

2. Using a plastic scribe, slide the intrusion switch out of the intrusion switch slot.

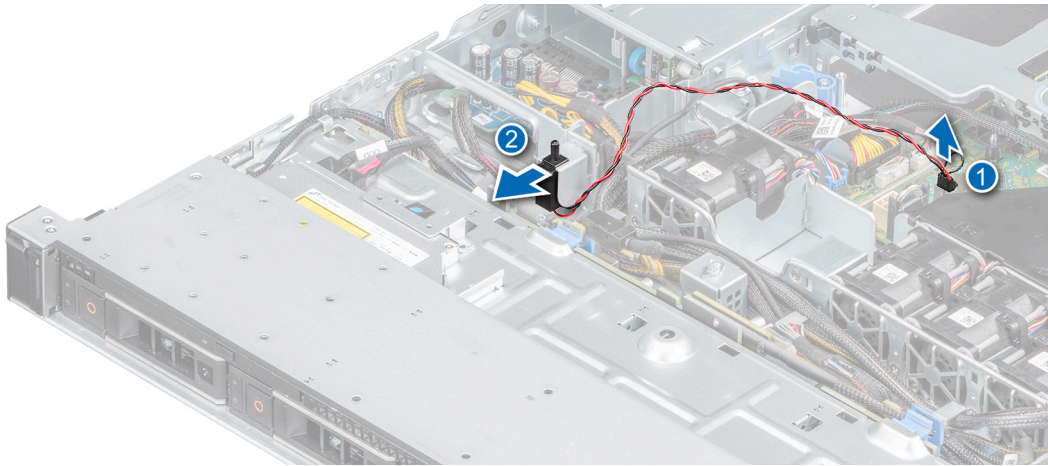

Figure 31. Removing the intrusion switch

Next steps

1. [Replace the intrusion switch.](#)

Installing the intrusion switch

Prerequisites

1. Follow the safety guidelines listed in the [Safety instructions](#).
2. Follow the procedure listed in the [Before working inside your system](#).

Steps

1. Align and insert the intrusion switch in the slot until it is firmly seated in the slot on the chassis.

NOTE: Route the cable properly when you replace it to prevent the cable from being pinched or crimped.

2. Connect the intrusion switch cable to the connector on the system board.

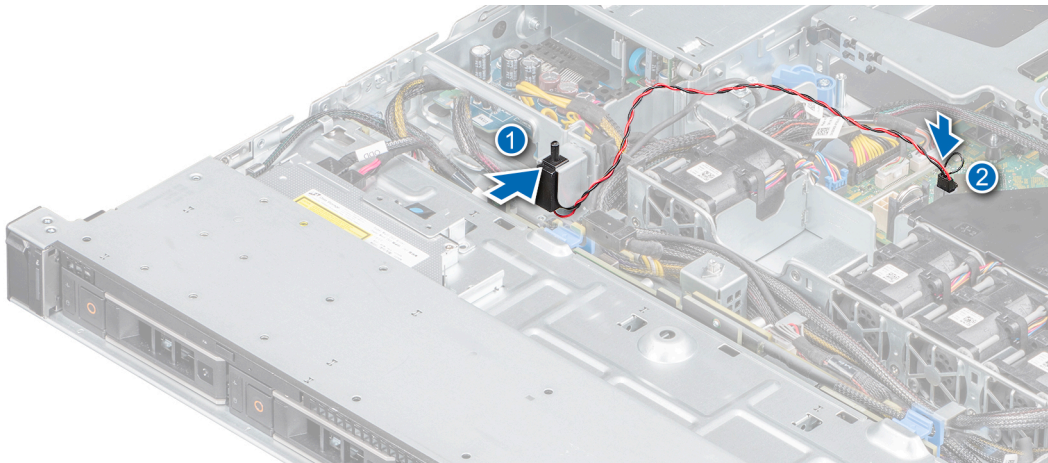

Figure 32. Installing the intrusion switch

Next steps

1. Follow the procedure listed in [After working inside your system](#).

System memory

System memory guidelines

Your system contains four memory sockets that are organized into two channels. In each channel, the first socket is marked white and the second socket black.

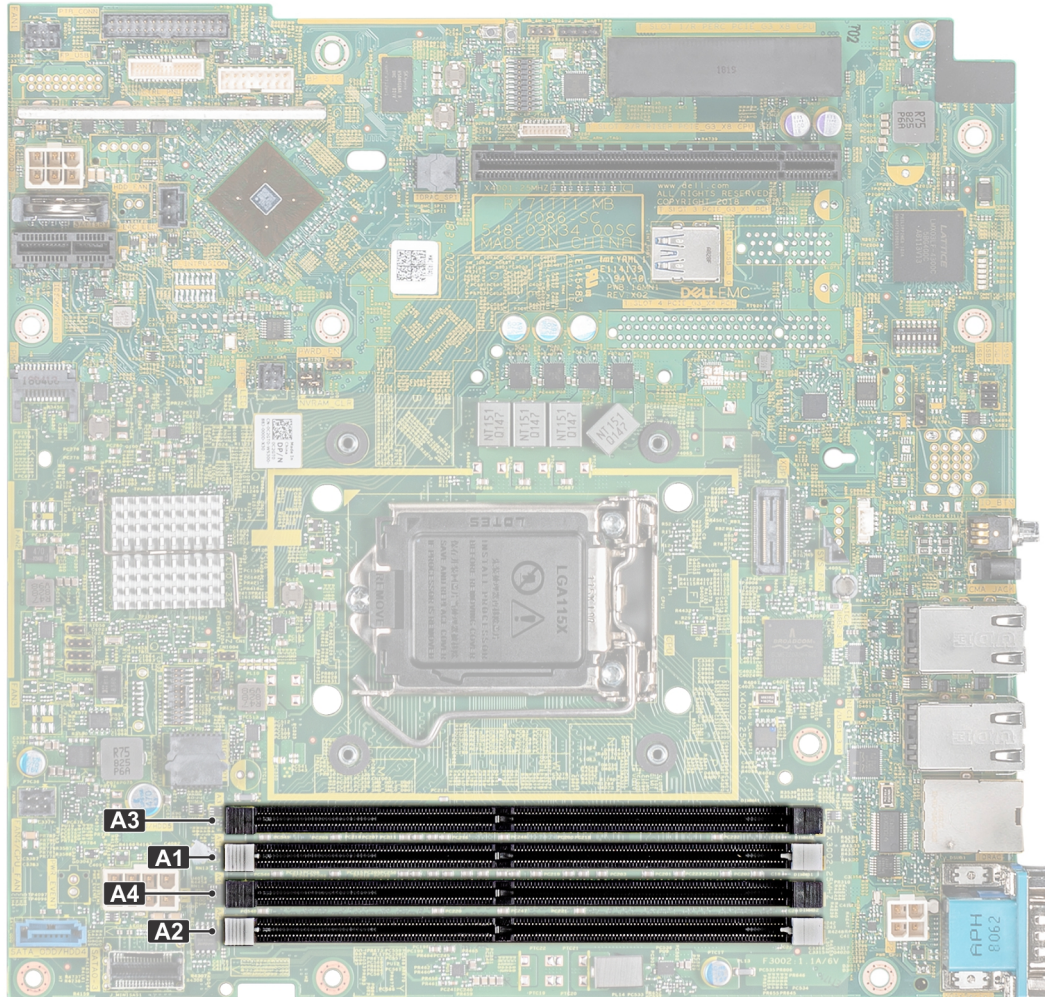

Figure 33. Memory socket locations

Memory channels are organized as follows:

Table 3. Memory channels

Channel 0	Channel 1
Slot A1 and A3	Slot A2 and A4

Table 4. Memory population

DIMM Type	DIMMs Populated/ Channel	Voltage	Operating Frequency	Maximum DIMM Rank/ Channel
UDIMM	1	1.2 V	2666 MT/s	Dual rank or Single rank
	2			

NOTE: 3200 MT/s UDIMM is compatible from BIOS version 2.5.1 but downshift to 2666 MT/s operational speed.

The following table shows sample memory configurations.

NOTE: 1R and 2R in the following table indicate single and dual-rank memory modules respectively.

Table 5. Memory configurations

Populated system capacity (in GB)	Memory module size (in GB)	Number of memory modules	Memory module rank, organization, and frequency	Memory module slot population
8	8	1	1R, x8, 2666 MT/s	A1
16	8	2	1R, x8, 2666 MT/s	A1, A2
	16	1	2R, x8, 2666 MT/s	A1
32	16	2	2R, x8, 2666 MT/s	A1, A2
	8	4	1R, x8, 2666 MT/s	A1, A2, A3, A4
64	16	4	2R, x8, 2666 MT/s	A1, A2, A3, A4

General memory module installation guidelines

To ensure optimal performance of your system, observe the following general guidelines when configuring your system memory. If your system's memory configurations fail to observe these guidelines, your system might not boot, stop responding during memory configuration, or operate with reduced memory.

The memory bus may operate at frequencies 2666 MT/s, 2400 MT/s, or 2133 MT/s depending on the following factors:

- System profile selected (for example, Performance Optimized, or Custom [can be run at high speed or lower])
- Maximum supported DIMM speed of the processors.
- Maximum supported DIMM speed of the processors.
- Maximum supported speed of the DIMMs

NOTE: MT/s indicates DIMM speed in MegaTransfers per second.

The system supports Flexible Memory Configuration, enabling the system to be configured and run in any valid chipset architectural configuration. The following are the recommended guidelines for installing memory modules:

- All DIMMs must be DDR4.
- A maximum of two different ranked DIMMs can be populated in a channel regardless of rank count.
- If memory modules with different speeds are installed, they will operate at the speed of the slowest installed memory module(s).
- Populate memory module sockets only if a processor is installed.
 - For single-processor systems, sockets A1 to A4 are available.
 - In **Optimizer Mode**, the DRAM controllers operate independently in the 64-bit mode and provide optimized memory performance.

Table 6. Memory population rules

Processor	Configuration	Memory population	Memory population information
Single processor	Optimizer (Independent channel) population order	1, 2, 3, 4	Odd amount of DIMMs per processor allowed.

- Populate all the sockets with white release tabs first, followed by the black release tabs.
- When mixing memory modules with different capacities, populate the sockets with memory modules with the highest capacity first.
 - **NOTE:** For example, if you want to mix 8 GB and 16 GB memory modules, populate 16 GB memory modules in the sockets with white release tabs and 8 GB memory modules in the sockets with black release tabs.
- Memory modules of different capacities can be mixed provided other memory population rules are followed.

NOTE: For example, 8 GB and 16 GB memory modules can be mixed.

- Mixing of more than two memory module capacities in one system is not supported.
- Unbalanced memory configurations will result in a performance loss so always populate memory channels identically with identical DIMMs for best performance.

Removing a memory module

Prerequisites

1. Follow the safety guidelines listed in [Safety instructions](#).
2. Follow the procedure listed in [Before working inside your system](#).
3. [Remove the air shroud](#).

NOTE: The memory modules are hot to touch for some time after the system has been powered down. Allow the memory modules to cool before handling them. Handle the memory modules by the card edges and avoid touching the components or metallic contacts on the memory module.

Steps

1. Locate the appropriate memory module socket.
2. To release the memory module from the socket, simultaneously press the ejectors on both ends of the memory module socket.

CAUTION: Handle each memory module only by the card edges, ensuring not to touch the middle of the memory module or metallic contacts.

3. Lift the memory module away from the system.

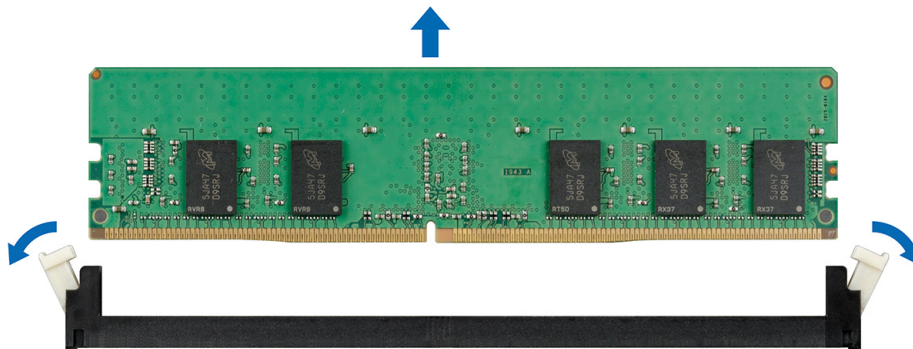

Figure 34. Removing a memory module

Next steps

1. [Replace the memory module](#), if you are removing a memory module permanently, install a memory module blank.

NOTE: The procedure to install a memory module blank is similar to the procedure to install a memory module.

Installing a memory module

Prerequisites

1. Follow the safety guidelines listed in [Safety instructions](#).
2. Follow the procedure listed in [Before working inside your system](#).
3. [Remove the air shroud](#).
4. If installed, remove a memory module blank.

NOTE: The procedure to remove a memory module blank is similar to the procedure to remove a memory module.

NOTE: Retain the removed memory module blank(s) for future use.

Steps

1. Locate the appropriate memory module socket.

CAUTION: To prevent damage to the memory module or the memory module socket during installation, do not bend or flex the memory module; insert both ends of the memory module simultaneously.

2. If a memory module or a memory module blank is installed in the socket, remove it.
3. Align the edge connector of the memory module with the alignment key of the memory module socket, and insert the memory module in the socket.

NOTE: The memory module socket has an alignment key that enables you to install the memory module in the socket in only one orientation.

CAUTION: Do not apply pressure at the center of the memory module; apply pressure at both ends of the memory module evenly.

4. Press the memory module with your thumbs until the ejectors firmly click into place.

When the memory module is properly seated in the socket, the levers on the memory module socket align with the levers on the other sockets that have memory modules installed.

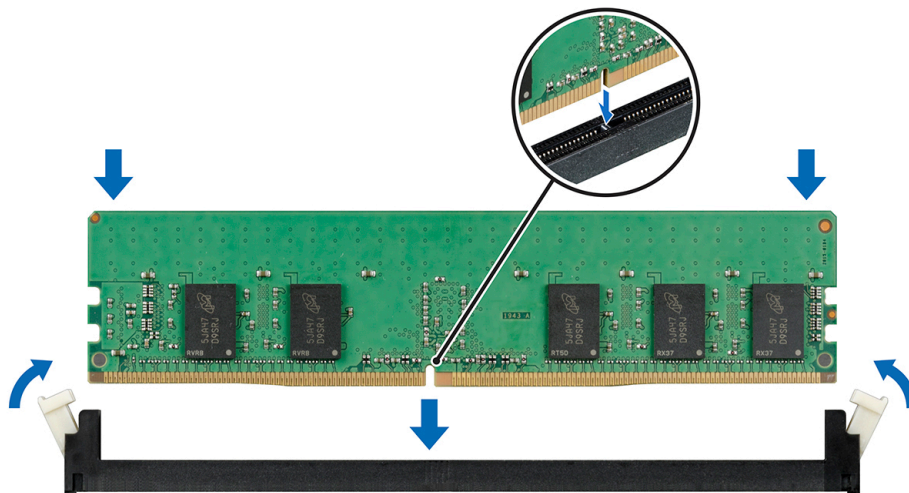

Figure 35. Installing a memory module

Next steps

1. Install the air shroud.
2. Follow the procedure listed in [After working inside your system](#).
3. Press F2 to enter System Setup, and check the **System Memory** setting.

The **System Memory Size** indicates the installed memory.

4. If the **System Memory Size** is incorrect, one or more of the memory modules may not be installed properly. Ensure that the memory modules are firmly seated in their sockets.
5. Run the system memory test in the system diagnostics.

Expansion cards and expansion card risers

NOTE: A System Event Log (SEL) event is logged if an expansion card riser is not supported or missing. It does not prevent your system from turning on. However, if a F1/F2 pause occurs with an error message, see *Troubleshooting expansion cards* section in the *Dell EMC PowerEdge Servers Troubleshooting Guide* at www.dell.com/poweredgemanuals.

Expansion card installation guidelines

Your system supports PCIe Express Generation 3 cards. The PowerEdge R340 expansion card riser includes a low profile (LP) slot and full height (FH) slot. The following table provides riser configurations for the PowerEdge R340 system:

NOTE: The expansion card riser is not hot-swappable.

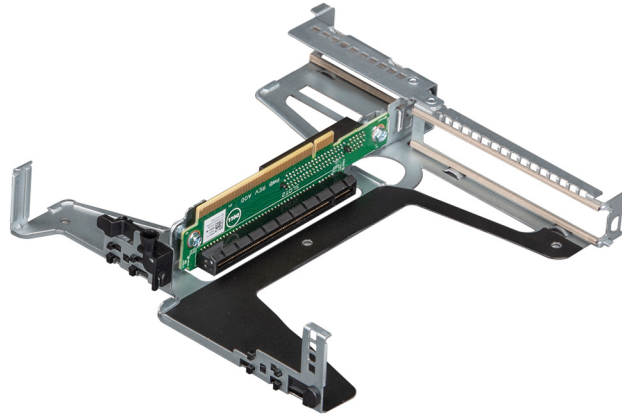

Figure 36. Expansion card riser

Table 7. Expansion card slots available on the expansion card riser

PCIe slot on the expansion card riser	Height	Length	Link width	Slot width
LP SLOT 1	Half Height	Half Length	x4	x8
FH SLOT 2	Full Height	Half Length	x8	x16

Table 8. Expansion card slots (PERC slot) available on the system board

PERC slot on the system board	Height	Length	Link width	Slot width
PCIE_G3_X8	Half Height	Half Length	x8	x8

The following table provides a guide for installing expansion cards to ensure proper cooling and mechanical fit. The expansion cards with the highest priority must be installed first using the slot priority indicated. All other expansion cards must be installed in card priority and slot priority order.

Table 9. Expansion card installation order

Card description	Card type	Maximum allowed	Slot Priority	Slot width	Link width	Card width	Card length	Card height
H730P+ PERC	PERC 9: Internal Adapter	1	Integrated Slot	x8	x8	SW	HL	LP
H330+ PERC		1	Integrated Slot	x8	x8	SW	HL	LP
HBA330 HBA: Internal Adapter	HBA: Internal Adapter	1	Integrated Slot	x8	x8	SW	HL	LP
12 Gb/s Ext SAS HBA / HBA355e	HBA: External Adapter	1	2	x16	x8	SW	HL	FH

Table 9. Expansion card installation order (continued)

Card description	Card type	Maximum allowed	Slot Priority	Slot width	Link width	Card width	Card length	Card height
10G Network card	NIC: 10Gb	1	2	x16	x8	SW	HL	FH
		1	1	x8	x4	SW	HL	LP
		1	2	x16	x8	SW	HL	FH
		1	1	x8	x4	SW	HL	LP
FC8 HBA	HBA: FC8	1	2	x16	x8	SW	HL	FH
		1	1	x8	x4	SW	HL	LP
BOSS2 card	Internal Storage	1	2	x16	x8	SW	HL	FH
		1	1	x8	x4	SW	HL	LP
1G Network card	NIC: 1Gb	1	2	x16	x8	SW	HL	FH
		1	1	x4	x4	SW	HL	LP
		1	1	x8	x4	SW	HL	LP

Removing the expansion card riser

Prerequisites

1. Follow the safety guidelines listed in [Safety instructions](#).
2. Follow the procedure listed in the [Before working inside your system](#).
3. [Remove the air shroud](#).

Steps

1. Open the blue expansion card riser retention-latch located on the system.
2. Holding the blue touch points, lift the expansion card riser from the system.

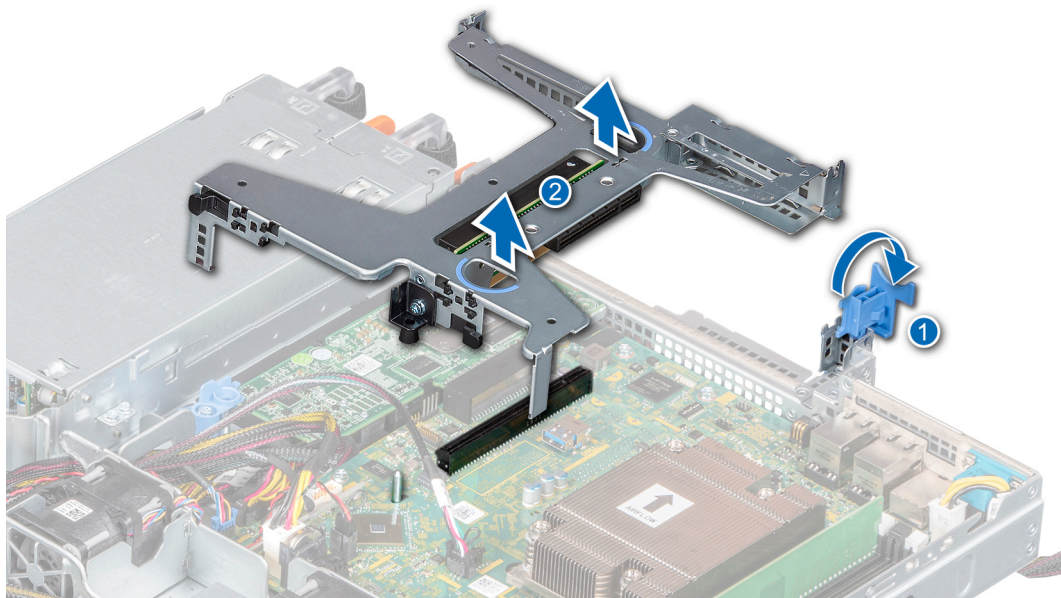

Figure 37. Removing the expansion card riser

3. If you are not replacing the expansion card riser, install a expansion card riser filler bracket by performing the following steps:
 - a. Align the expansion card riser filler bracket with the slot on the system.

- b. Push the expansion card riser filler bracket downward until firmly seated.
 - c. Close the blue expansion card retention latch by pushing the latch down until the latch snaps into place.
 - d. Using a Phillips #2 screwdriver, tighten the screw to secure the expansion card riser filler to the chassis.
4. Using a Phillips #2 screwdriver, fasten the screw to secure the expansion card riser filler to the chassis.

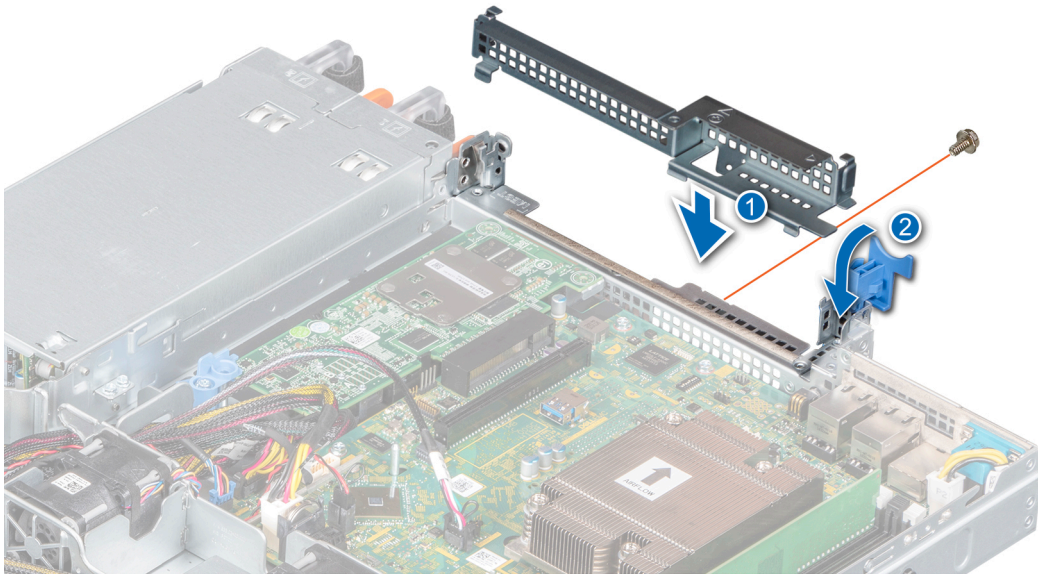

Figure 38. Installing the expansion card riser filler

Next steps

1. [Replace the expansion card riser.](#)

Installing the expansion card riser

Prerequisites

1. Follow the safety guidelines listed in the [Safety instructions](#).
2. Follow the procedure listed in the [Before working inside your system](#).
3. If applicable, [install the expansion card in the expansion card riser](#).
4. Open the expansion card riser latch.

Steps

1. If applicable, remove the expansion card riser filler bracket by performing the following steps:
 - a. Open the blue expansion card retention latch lock.
 - b. Using a Phillips #2 screwdriver, remove the screw securing the system card riser filler to the system board.
 - c. Slide the expansion card riser filler bracket up and out of the system.

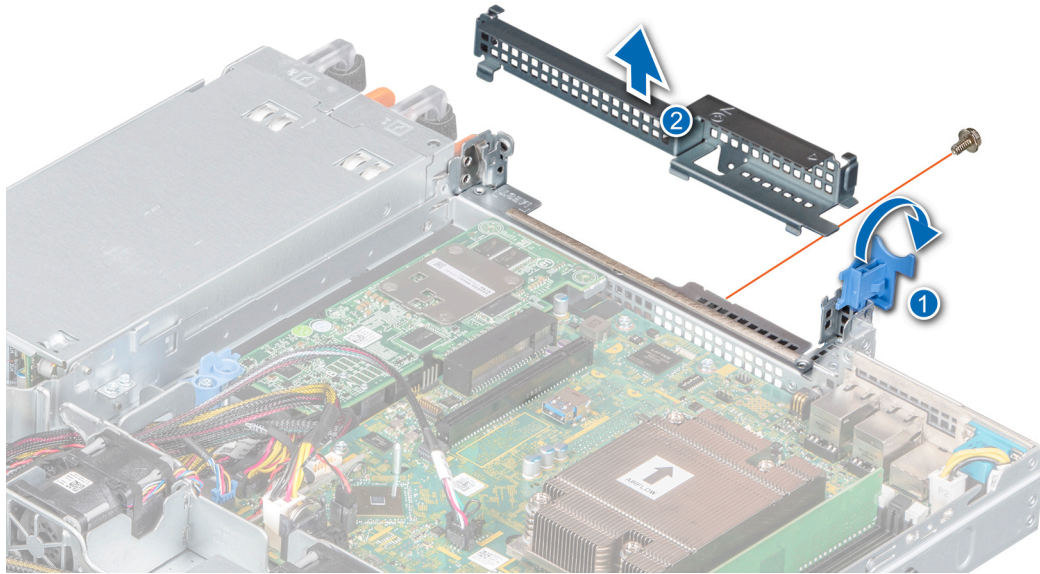

Figure 39. Removing the expansion card riser filler

2. Align the guide on the expansion card riser with the guide pin on the chassis.
3. Lower the expansion card riser until the expansion card riser is firmly seated in the slot.
4. Close the expansion card riser latch.

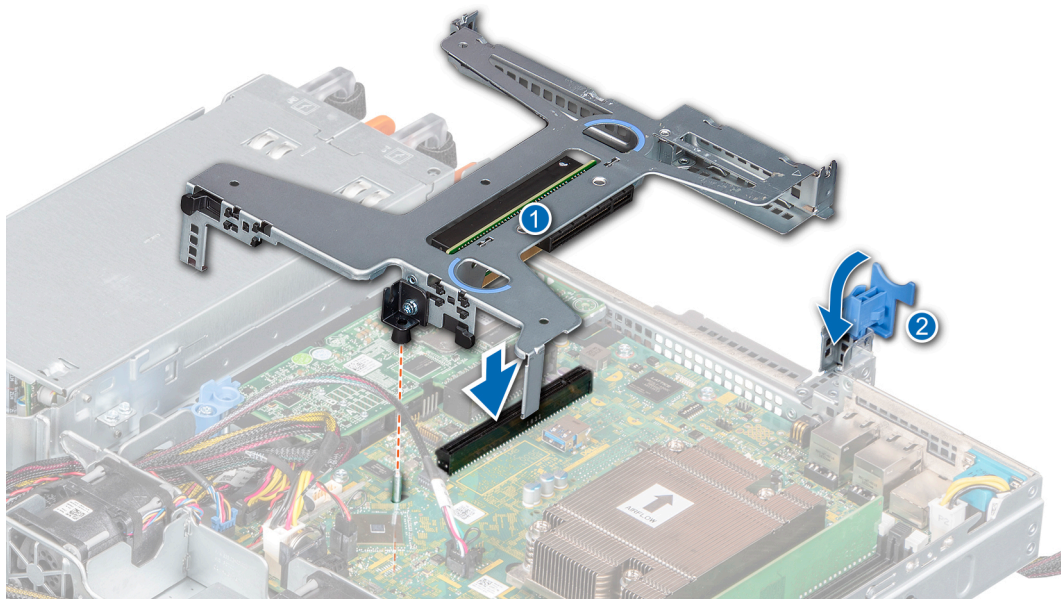

Figure 40. Installing the expansion card riser

Next steps

1. Follow the procedure listed in the [After working inside your system](#).

Removing an expansion card from the expansion card riser

Prerequisites

1. Follow the safety guidelines listed in the [Safety instructions](#).

2. Follow the procedure listed in the [Before working inside your system.](#)
3. Disconnect any cables that are connected to the expansion card or expansion card riser.
4. [Remove the expansion card riser.](#)

Steps

1. Flip the expansion card riser to locate the connectors on the riser.
2. Holding the card by its edges, remove the expansion card from the expansion card riser.

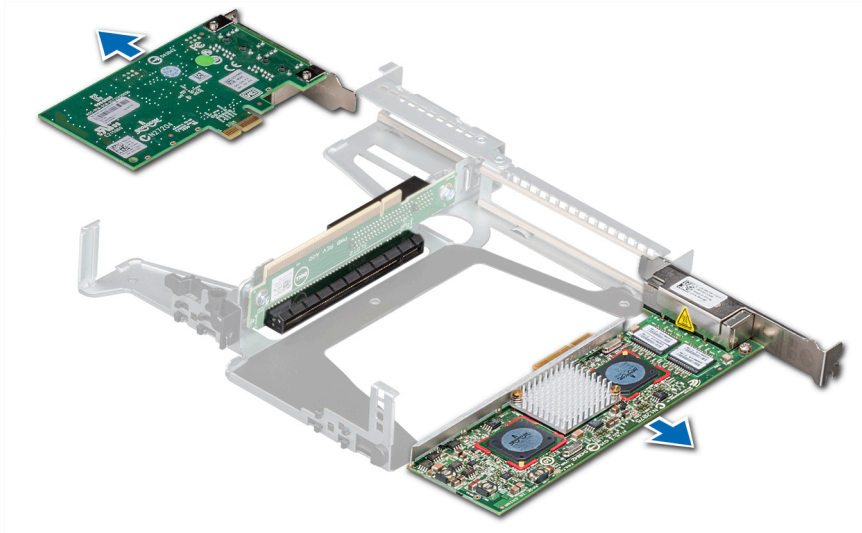

Figure 41. Removing the expansion card from the expansion card riser

3. If applicable, disconnect the cables from the expansion card.
4. If you are removing the card permanently, install a filler bracket in the empty expansion card slot.

i **NOTE:** Install a filler bracket over an empty expansion card slot to maintain Federal Communications Commission (FCC) certification of the system. The brackets also keep dust and dirt out of the system and aid in proper cooling and airflow inside the system.

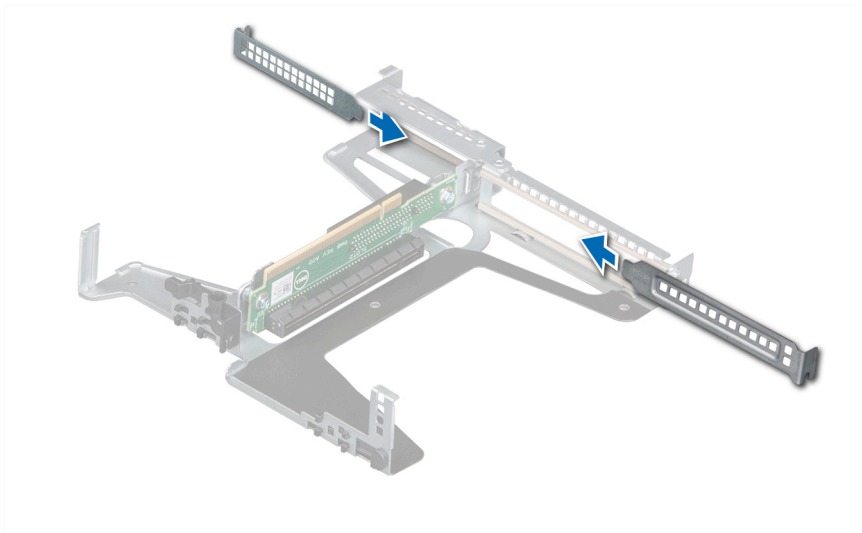

Figure 42. Installing the expansion card filler

Next steps

1. [Install the expansion card into the expansion card riser.](#)

Installing an expansion card into the expansion card riser

Prerequisites

1. Follow the safety guidelines listed in the [Safety instructions](#).
2. Follow the procedure listed in the [Before working inside your system](#).
3. If installing a new expansion card, unpack it and prepare the card for installation.
i **NOTE:** For instructions, see the documentation accompanying the card.
4. [Remove the expansion card riser](#).
5. If installed, remove the filler bracket.

Steps

1. Remove the filler bracket.
i **NOTE:** Store the filler bracket for future use. Filler brackets must be installed in empty expansion card slots to maintain Federal Communications Commission (FCC) certification of the system. The brackets also keep dust and dirt out of the system and aid in proper cooling and airflow inside the system.

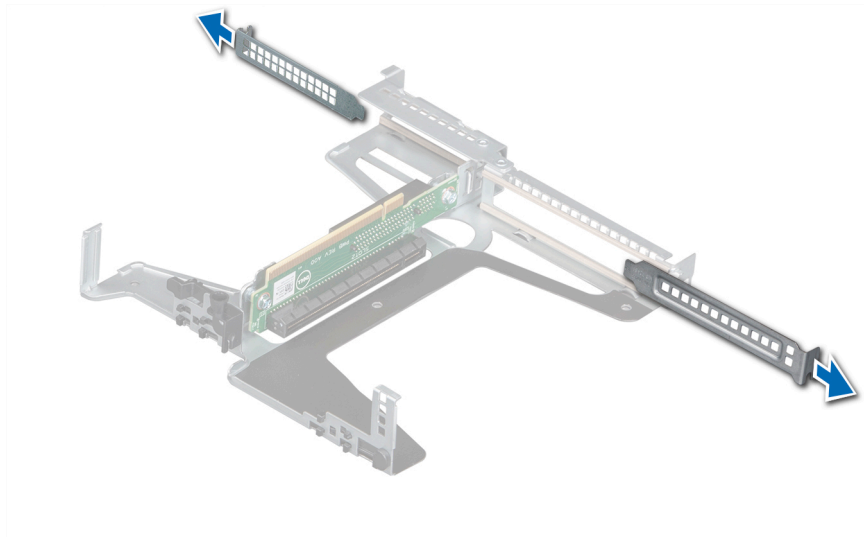

Figure 43. Removing expansion card filler

2. If applicable, connect the cables to the expansion card.
3. Holding the card by its edges, align the card and insert the expansion card in the connector on the expansion card riser.

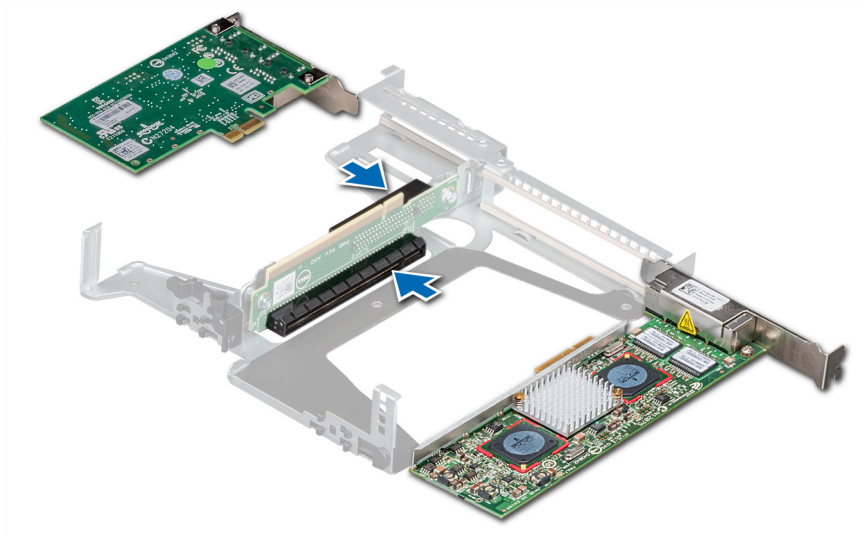

Figure 44. Installing the expansion card in the expansion card riser

Next steps

1. [Install the expansion card riser.](#)
2. Follow the procedure listed in the [After working inside your system.](#)

Storage controller card

Removing the PERC card

Prerequisites

1. Follow the safety guidelines listed in [Safety instructions.](#)
2. Follow the procedure listed in the [Before working inside your system.](#)
3. [Remove the expansion card riser.](#)

Steps

1. Remove the screw securing the blue release latch.
2. Rotate the blue release latch to disengage it from the PERC card.
3. Push the blue release latch until the tab on the latch clicks into the slot on the chassis.
4. Hold the PERC card by the edges and pull it to disconnect it from the connector on the system board.
5. Flip the PERC card and disconnect the cable from the PERC card.

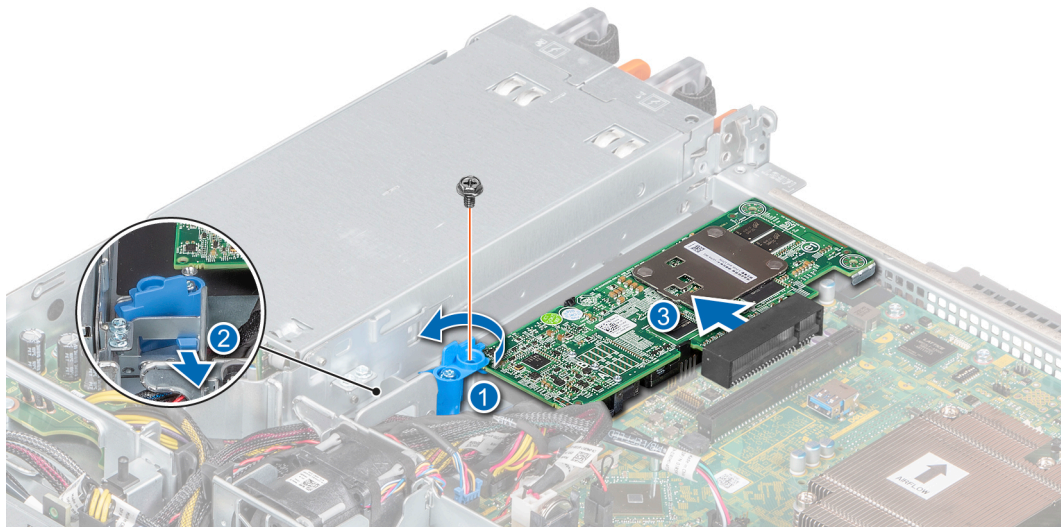

Figure 45. Removing the PERC card

Next steps

1. [Replace the PERC card.](#)

Installing the PERC card

Prerequisites

1. Follow the safety guidelines listed in [Safety instructions](#).
2. Follow the procedure listed in the [Before working inside your system](#).
3. [Remove the expansion card riser.](#)

Steps

1. Connect the PERC cable to the PERC card.
2. Flip and insert the PERC card in the connector on the system board.
3. Press the tab on the blue release latch to disengage it from the slot on the chassis.
4. Rotate the blue release latch until it locks with the PERC card.
5. Secure the blue release latch with a screw.

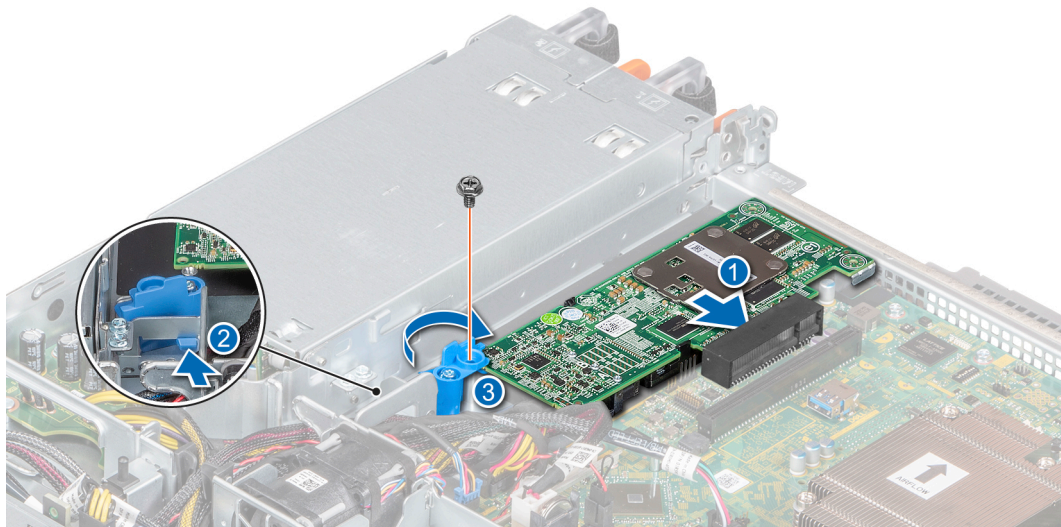

Figure 46. Installing the PERC card

Next steps

1. [Install the expansion card riser.](#)
2. Follow the procedure listed in the [After working inside your system.](#)

System battery

Replacing the system battery

Prerequisites

NOTE: There is a danger of a new battery exploding if it is incorrectly installed. Replace the battery only with the same or equivalent type that is recommended by the manufacturer. Discard used batteries according to the manufacturer's instructions. See the [Safety instructions](#), that came with your system for more information.

1. Follow the safety guidelines listed in [Safety instructions](#).
2. Follow the procedure listed in [Before working inside your system](#).

Steps

1. Push the battery holder clip away from the battery.

CAUTION: To avoid damage to the battery holder clip, ensure that you do not bend the battery holder clip while installing or removing a battery.

2. Pull the battery out of the battery holder.

NOTE: Ensure that the + side of the battery is facing the battery holder clip.

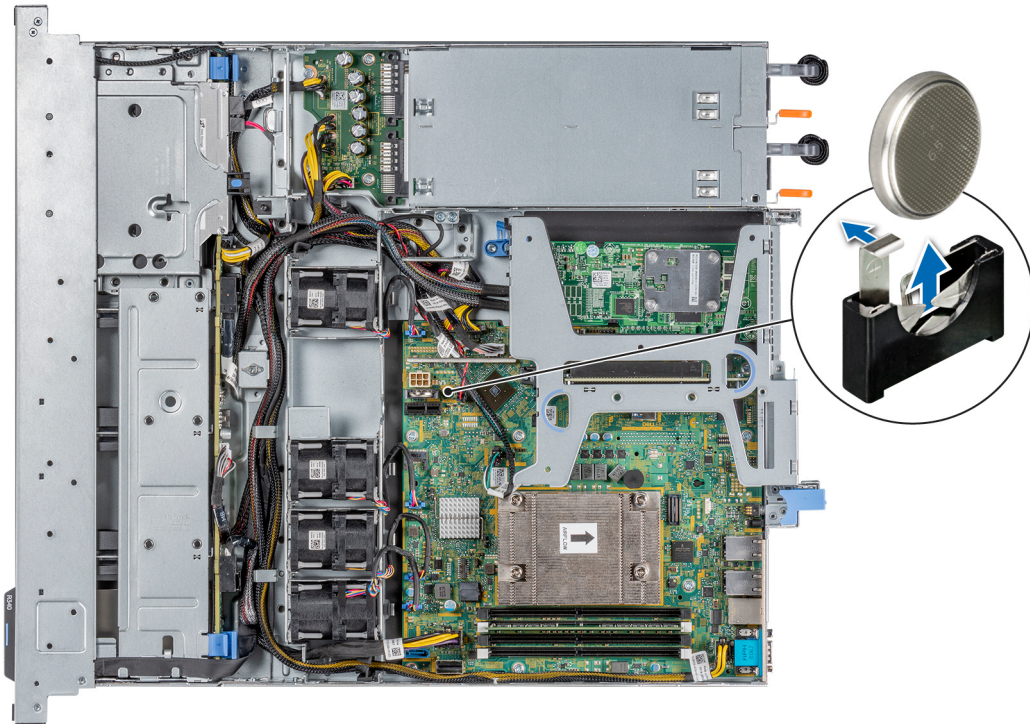

Figure 47. Removing the system battery

3. To install a system battery, push the battery holder clip away.
4. Insert the battery in the battery holder until the battery holder clip snaps into place.

CAUTION: To avoid damage to the battery holder clip, ensure that you do not bend the battery holder clip while installing or removing a battery.

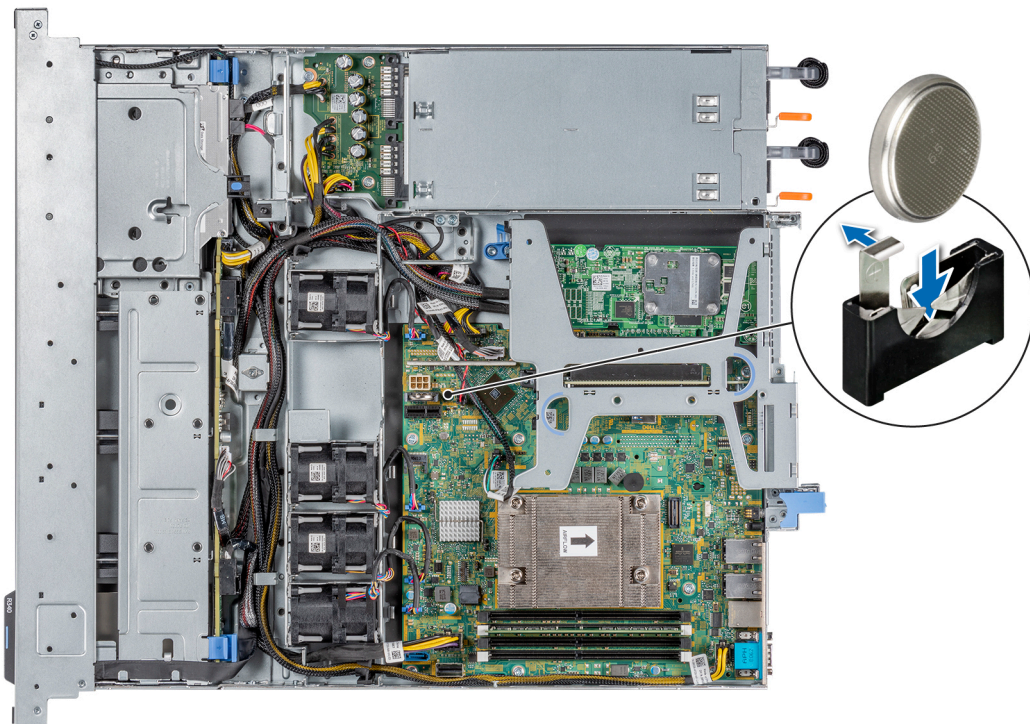



Figure 48. Installing the system battery

Next steps

1. Follow the procedure listed in [After working inside your system](#).
2. Confirm that the battery is operating properly, by performing the following steps:
 - a. Enter the System Setup, while booting, by pressing **F2**.
 - b. Enter the correct time and date in the System Setup **Time** and **Date** fields.
 - c. **Exit** the System Setup.
 - d. To test the newly installed battery, remove the system from the enclosure for at least an hour.
 - e. Reinstall the system into the enclosure after an hour.
 - f. Enter the System Setup and if the time and date are still incorrect, see [Getting help](#) section.

Optional internal USB memory key

 **NOTE:** To locate the internal USB port on the system board, see the [System board jumpers and connectors](#) section.

Replacing the optional internal USB memory key

Prerequisites

 **CAUTION:** To avoid interference with other components in the server, the maximum permissible dimensions of the USB memory key: 15.9 mm width x 57.15 mm length x 7.9 mm height.

1. Follow the safety guidelines listed in the [Safety instructions](#).
2. Follow the procedure listed in the [Before working inside your system](#).
3. [Remove the expansion card riser](#).

Steps

1. Locate the USB port or USB memory key on the system board.
To locate the USB port, see the [System board jumpers and connectors](#) section.
2. If installed, remove the USB memory key from the USB port.
3. Insert the replacement USB memory key into the USB port.

Next steps

1. [Replace the expansion card riser](#).
2. Follow the procedure that is listed in [After working inside your system](#).
3. While booting, press F2 to enter System Setup and verify that the system detects the USB memory key.

Optional optical drive

Removing the optical drive

The procedure for removing an optical drive and optical drive blank is the same.

Prerequisites

1. Follow the safety guidelines listed in the [Safety instructions](#).
2. Follow the procedure listed in the [Before working inside your system](#).

 **NOTE:** Observe the routing of the cable as you remove it from the system.

Steps

1. Disconnect the power and signal cables from the optical drive.
2. To release the optical drive, press the release tab and push the drive towards the front of the system.

3. Slide the optical drive out of the system.

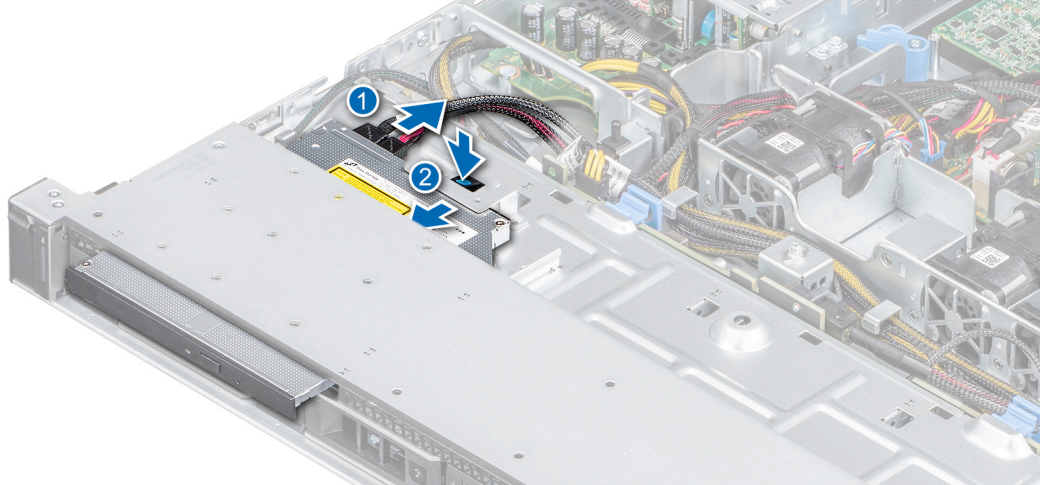

Figure 49. Removing the optical drive

Next steps

1. Replace the optical drive or install an optical drive blank.

NOTE: Blanks must be installed on empty optical drive slot to maintain FCC certification of the system. The blank also keep dust and dirt out of the system and aid in proper cooling and airflow inside the system.

Installing the optional optical drive

The procedure for installing an optical drive and optical drive blank.

Prerequisites

1. Follow the safety guidelines listed in the [Safety instructions](#).
2. Follow the procedure listed in the [Before working inside your system](#).
3. If installed, remove the optical drive blank by pressing the blue release tab at the back of the blank and pushing the blank out of the system.

NOTE: Route the cable properly when you replace it to prevent the cable from being pinched or crimped.

Steps

1. Insert the optical drive until the blue release tab locks in the slot on the chassis.
2. Connect the power and data cable to the appropriate ports on the optical drive.
NOTE: Route the cable properly to prevent the cable from being pinched or crimped.
3. Connect the power and data cables to the connectors on the system board.

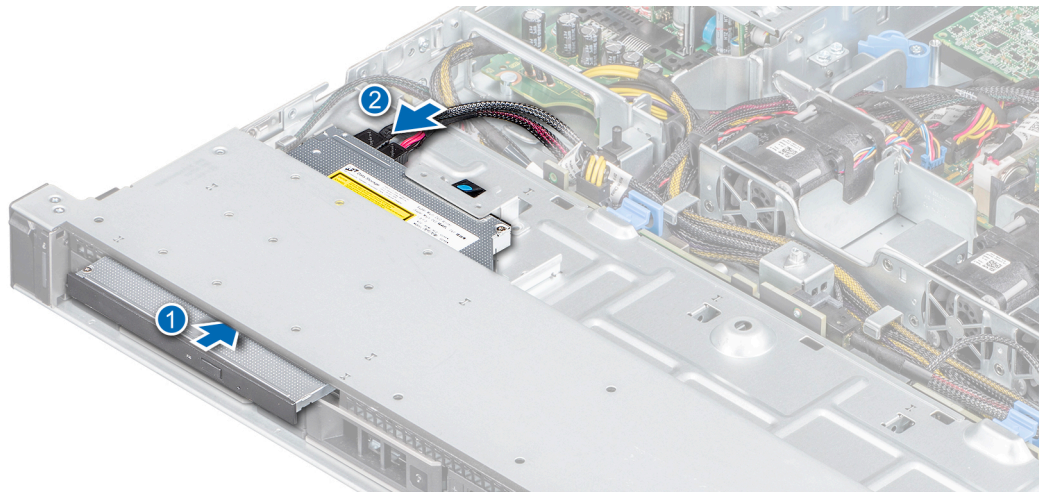

Figure 50. Installing the optical drive

Next steps

1. Follow the procedure listed in the [After working inside your system](#).

Processor and heat sink

Removing the heat sink

Prerequisites

1. Follow the safety guidelines listed in the [Safety instructions](#).
2. Follow the procedure listed in the [Before working inside your system](#).
3. [Remove the air shroud](#).

NOTE: The heat sink and processor are too hot to touch for some time after the system has been powered down. Allow the heat sink and processor to cool down before handling them.

Steps

1. Using a Phillips #2 screwdriver, loosen the screws on the heat sink in the order that is mentioned below:
 - a. Loosen the first screw three turns.
 - b. Loosen the screw diagonally opposite to the screw you loosened.
2. Repeat the procedure for the remaining two screws.
3. Return to the first screw to loosen it.
4. Lift the heat sink from the system.

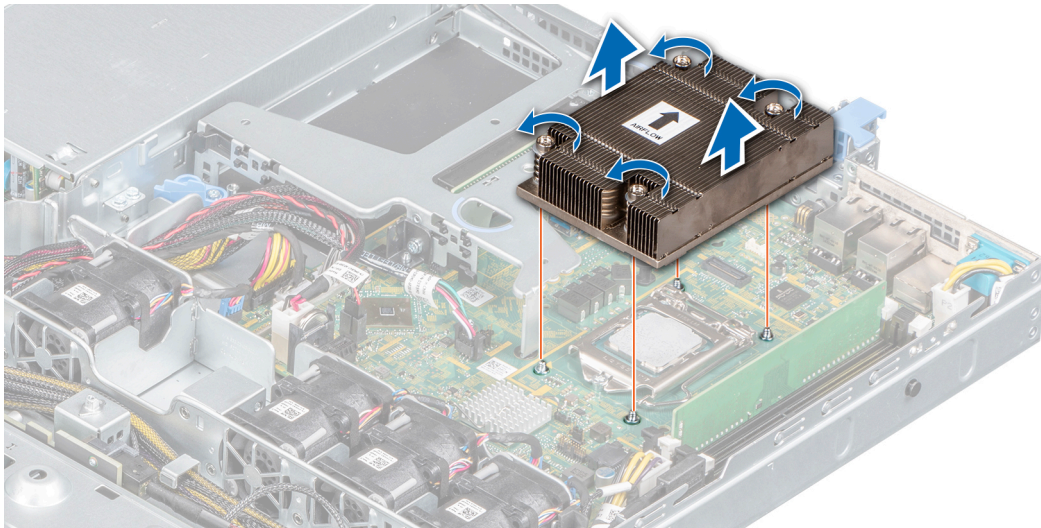

Figure 51. Removing the heat sink

Next steps

1. If you are removing a faulty heat sink, [replace the heat sink](#), if not, [remove the processor](#).

Removing the processor

Prerequisites

CAUTION: The heat sink may be hot to touch for some time after the system has been powered off. Allow the heat sink to cool before removing it.

1. Follow the procedure in [Safety instructions](#).
2. Follow the procedure listed in the [Before working inside your system](#).
3. [Remove the air shroud](#).
4. [Remove the heat sink](#).

Steps

1. Release the socket lever by pushing the lever down and out from under the tab on the processor shield.
2. Lift the lever upward until the processor shield is fully open.

CAUTION: Do not touch the processor socket pins, they are fragile and can be permanently damaged. Be careful not to bend the pins in the processor socket when removing the processor out of the socket.

3. Lift the processor from the socket.



Figure 52. Removing the processor

Next steps

1. Replace the processor.

Installing the processor

Prerequisites

1. Follow the procedure in [Before working inside your system](#).
2. [Remove the air shroud](#).
3. [Remove the heat sink](#).

Steps

1. Align the pin-1 indicator of the processor with the triangle on the system board.

CAUTION: Do not use force to seat the processor. When the processor is positioned correctly, it engages into the socket at ease.

2. Place the processor in the socket.
3. Close the processor shield by sliding it under the retention screw on the system board.
4. Lower the processor shield lever and push it under the tab to lock the processor shield.

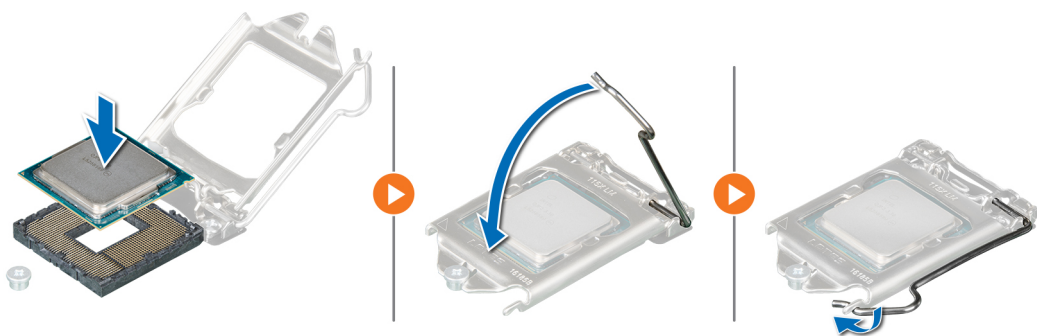

Figure 53. Installing the processor

Next steps

1. [Install the heat sink](#).
2. [Install the air shroud](#).
3. Follow the procedure in [After working inside your system](#).

Installing the heat sink

Prerequisites

1. Follow the safety guidelines listed in the [Safety instructions](#).
2. Follow the procedure listed in the [Before working inside your system](#).
3. [Remove the air shroud](#).

Steps

1. If you are using an existing heat sink, remove the thermal grease from the heat sink using a clean lint-free cloth.
2. Use the thermal grease syringe included with your processor kit to apply the grease in a thin spiral on the top of the processor.

CAUTION: Applying too much thermal grease can result in excess grease coming in contact with and contaminating the processor socket.

NOTE: The thermal grease syringe is intended for one-time use only. Dispose the syringe after you use it.

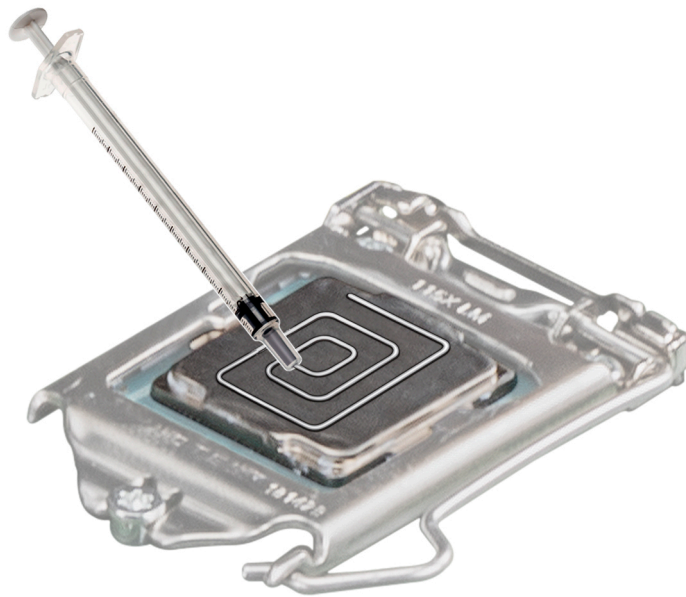

Figure 54. Applying thermal grease on top of the processor

3. Align the screws on the heat sink with the standoff screws on the system board.
4. Using a Phillips #2 screwdriver, tighten the screws in the following order to secure the heat sink to the system board.
 - a. Tighten the first screw three turns.
 - b. Tighten the screw diagonally opposite to the screw you loosened.
5. Repeat the procedure for the remaining two screws.
6. Return to the first screw to tighten it.

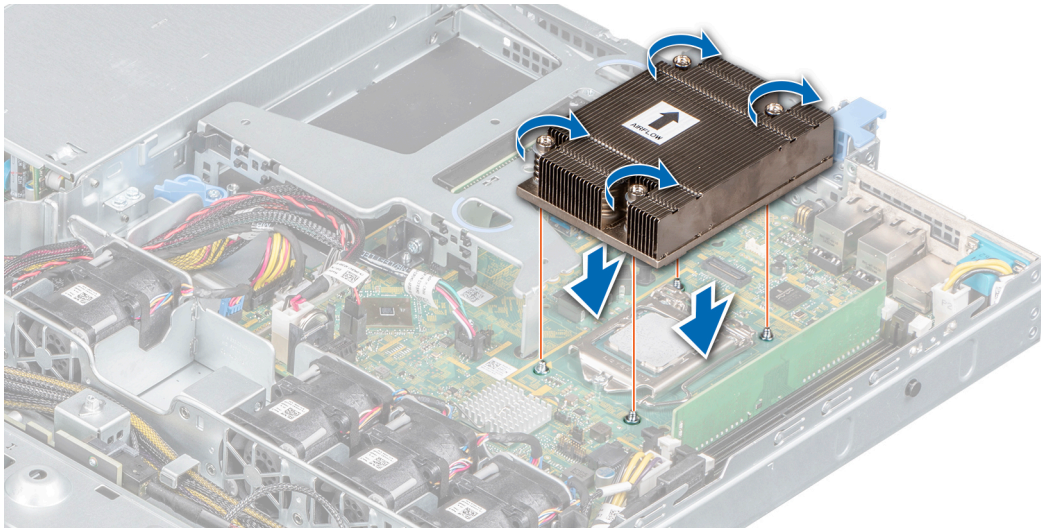

Figure 55. Installing the heat sink

Next steps

1. Install the air shroud.
2. Follow the procedure listed in the [After working inside your system](#).

Optional IDSDM or vFlash module

The IDSDM or vFlash module combines the IDSDM and/or vFlash features into a single module.

NOTE: The write-protect switch is on the IDSDM or vFlash module.

Removing the optional IDSDM or vFlash card

Prerequisites

1. Follow the safety guidelines listed in [Safety instructions](#).
2. Follow the procedure listed in [Before working inside your system](#).
3. [Remove the air shroud](#).
4. If you are replacing the IDSDM/vFlash card, [remove the MicroSD cards](#).

NOTE: Temporarily label each SD card with its corresponding slot number before removal. Reinstall the SD cards into the corresponding slots.

Steps

Holding the pull tab, lift the IDSDM/vFlash card out of the system.

Next steps

NOTE: If you are replacing the IDSDM or vFlash module, remove the MicroSD cards.

1. [Replace the IDSDM/vFlash module](#).

Installing optional IDSDM or vFlash card

Prerequisites

1. Follow the safety guidelines listed in the [Safety instructions](#).

2. Follow the procedure listed in the [Before working inside your system.](#)
3. [Remove the air shroud.](#)

Steps

1. Locate the IDSDM/vFlash connector on the system board. To locate IDSDM/vFlash connector, see [System board jumpers and connectors](#) section.
2. Align the IDSDM/vFlash card with the connector on the system board.
3. Push the IDSDM/vFlash card until it is firmly seated on the system board.

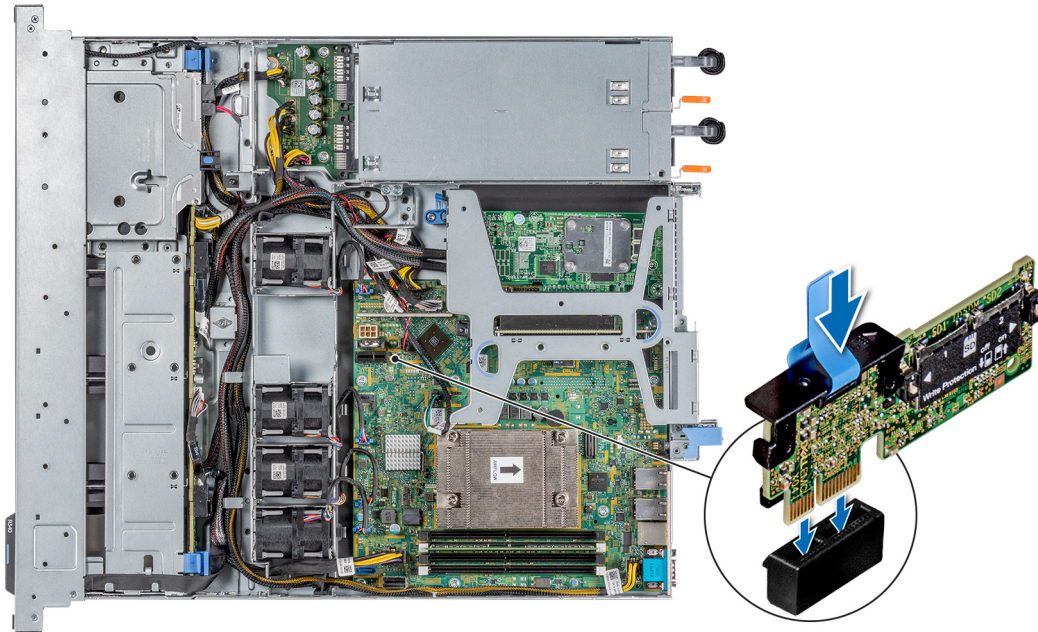

Figure 56. Installing optional IDSDM or vFlash card

Next steps

1. [Install the MicroSD cards.](#)
NOTE: Reinstall the MicroSD cards into the same slots that are based on the labels you had marked on the cards during removal.
2. [Install the air shroud.](#)
3. Follow the procedure that is listed in [After working inside your system.](#)

Removing the MicroSD card

Prerequisites

1. Follow the safety guidelines listed in the [Safety instructions.](#)
2. Follow the procedure listed in the [Before working inside your system.](#)
3. [Remove the air shroud.](#)
4. [Remove the IDSDM or vFlash module.](#)

Steps

1. Locate the MicroSD card slot on the vFlash/IDSDM module, and press the card to partially release it from the slot. To locate IDSDM/vFlash module, see the [System board jumpers and connectors](#) section.
2. Hold the MicroSD card and remove it from the slot.

NOTE: Temporarily label each MicroSD card with its corresponding slot number after removal.

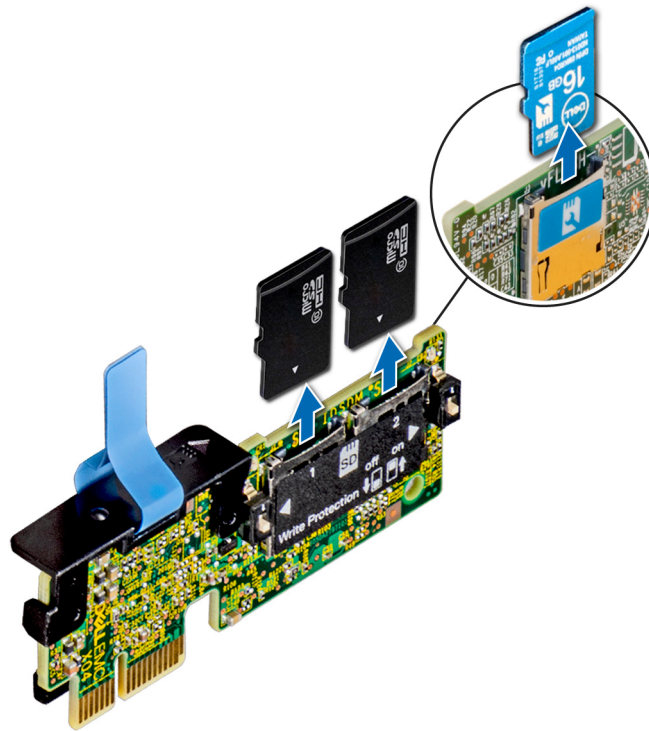

Figure 57. Removing the MicroSD card

Next steps

1. Replace the MicroSD cards.

Installing the MicroSD card

Prerequisites

1. Follow the safety guidelines listed in the [Safety instructions](#).
2. Follow the procedure listed in the [Before working inside your system](#).
3. [Remove the air shroud](#).
4. [Remove the IDSMD or vFlash module](#).

i **NOTE:** To use a MicroSD card with your system, ensure that the **Internal SD Card Port** is enabled in System Setup.

i **NOTE:** If reinstalling, ensure that you install the MicroSD cards into the same slots based on the labels you had marked on the cards during removal.

Steps

1. Locate the MicroSD card connector on the IDSMD/vFlash module. Orient the MicroSD card appropriately and insert the contact-pin end of the card into the slot. To locate IDSMD/vFlash, see the [System board jumpers and connectors](#) section.

i **NOTE:** The slot is keyed to ensure correct insertion of the card.

2. Press the card into the card slot to lock it into place.

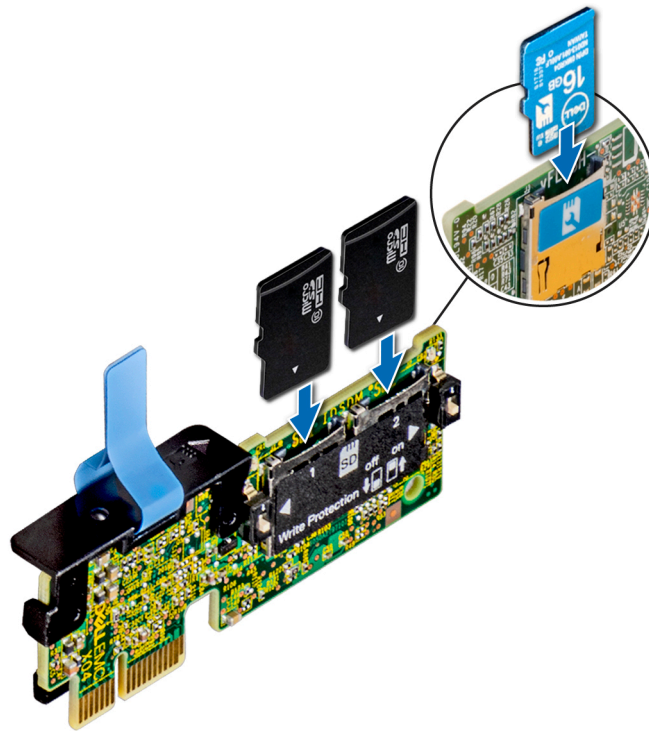

Figure 58. Installing the MicroSD card

Next steps

1. Install the IDSDM or vFlash module.
2. Follow the procedure listed in the [After working inside your system](#).

M.2 SSD module

Removing the M.2 SSD module

Prerequisites

1. Follow the safety guidelines listed in [Safety instructions](#).
2. Follow the procedure listed in [Before working inside your system](#).
3. [Remove the air shroud](#).
4. Remove the BOSS card.
 - NOTE:** The procedure to remove the BOSS card is similar to removing an expansion card.

Steps

1. Using the Phillips #1 screwdriver, remove the screws securing the M.2 SSD module to the BOSS card.
2. Pull the M.2 SSD module to disconnect from the BOSS card connector.

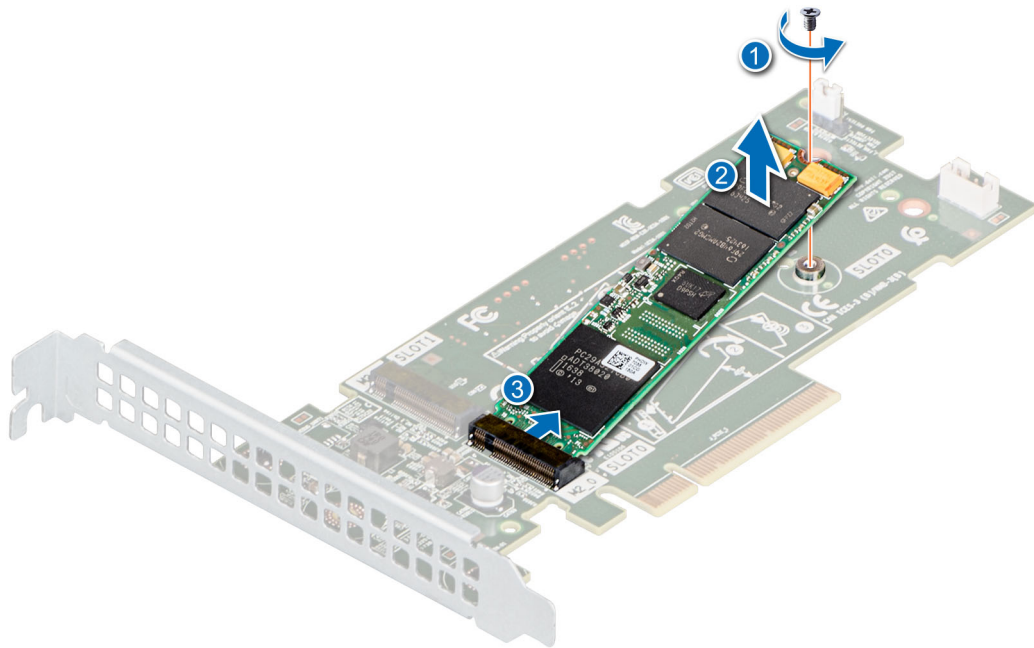

Figure 59. Removing the M.2 SSD module

Next steps

Replace the M.2 SSD module.

Installing the M.2 SSD module

Prerequisites

1. Follow the safety guidelines listed in [Safety instructions](#).
2. Follow the procedure listed in [Before working inside your system](#).
3. [Remove the air shroud](#).
4. Remove the BOSS card.

NOTE: The procedure to remove the BOSS card is similar to the removing an expansion card.

Steps

1. Align the M.2 SSD module at an angle with the BOSS card connector.
2. Insert the M.2 SSD module until it is firmly seated in the BOSS card connector.
3. Using the Phillips #1 screwdriver, secure the M.2 SSD module on the BOSS card with the screw.

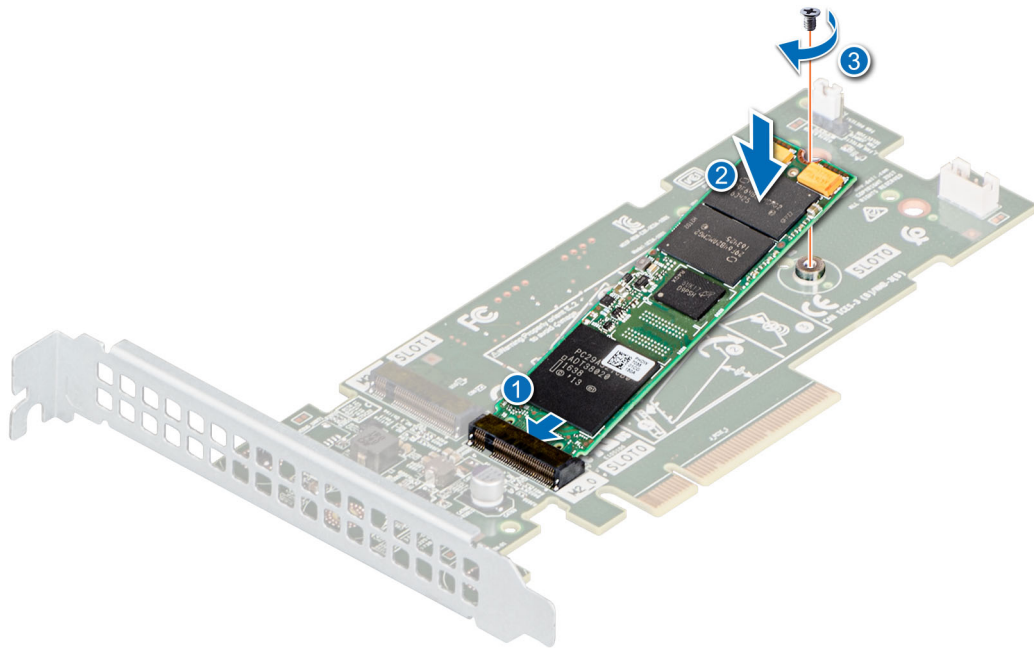

Figure 60. Installing the M.2 SSD module

Next steps

1. Install the BOSS card.
 - NOTE:** The procedure to install the BOSS card is similar to removing an expansion card.
2. [Install the air shroud.](#)
3. Follow the procedure listed in the [After working inside your system.](#)

Drive backplane

Drive backplane

Table 10. Supported backplane options for PowerEdge R340 system.

System	Supported backplane options
PowerEdge R340	2.5-inch (x8) SAS/SATA/SSD backplane
	3.5-inch (x4) SAS/SATA backplane

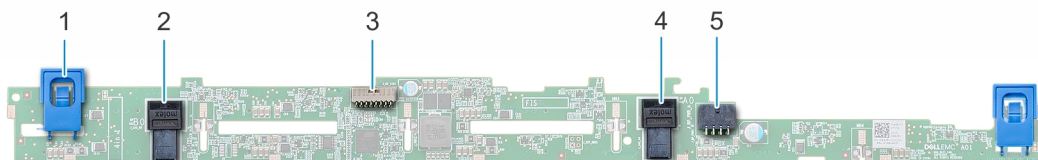

Figure 61. 2.5-inch (x8) SAS/SATA/SSD backplane

- | | |
|--|--|
| <ol style="list-style-type: none"> 1. Release tabs (2) 3. Backplane signal connector 5. Backplane Power A connector | <ol style="list-style-type: none"> 2. Backplane SAS B0 connector 4. Backplane SAS A0 connector |
|--|--|

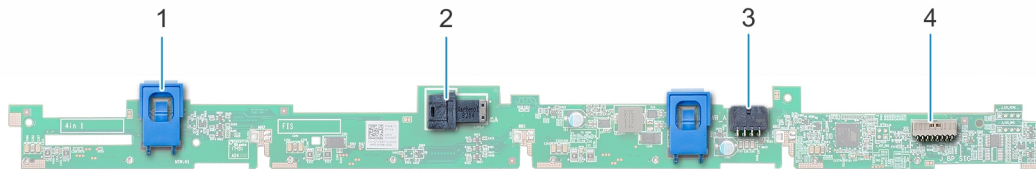

Figure 62. 3.5-inch (x4) SAS/SATA backplane

- 1. Release tab (2)
- 2. Backplane SAS A0 connector
- 3. Backplane Power A connector
- 4. Backplane signal connector

Removing the drive backplane

Prerequisites

CAUTION: To prevent damage to the drives and backplane, you must remove the drives from the system before removing the backplane.

CAUTION: Note the number of each drive and temporarily label them before removal so that you can replace them in the same drive slots.

- 1. Follow the safety guidelines listed in [Safety instructions](#).
- 2. Follow the procedure listed in [Before working inside your system](#).
- 3. [Remove the drives](#).
- 4. Disconnect the following cables from the backplane:
 - a. Backplane signal cable
 - b. Backplane power cable
 - c. PERC cable

NOTE: Observe the routing of the cable as you remove it from the system.

Steps

- 1. Press the blue release tabs to disengage the drive backplane from the hooks on the chassis.
- 2. Lift the drive backplane out of the system.

NOTE: To avoid damaging the backplane, ensure that you move the control panel cables from the cable routing clips before removing the backplane.

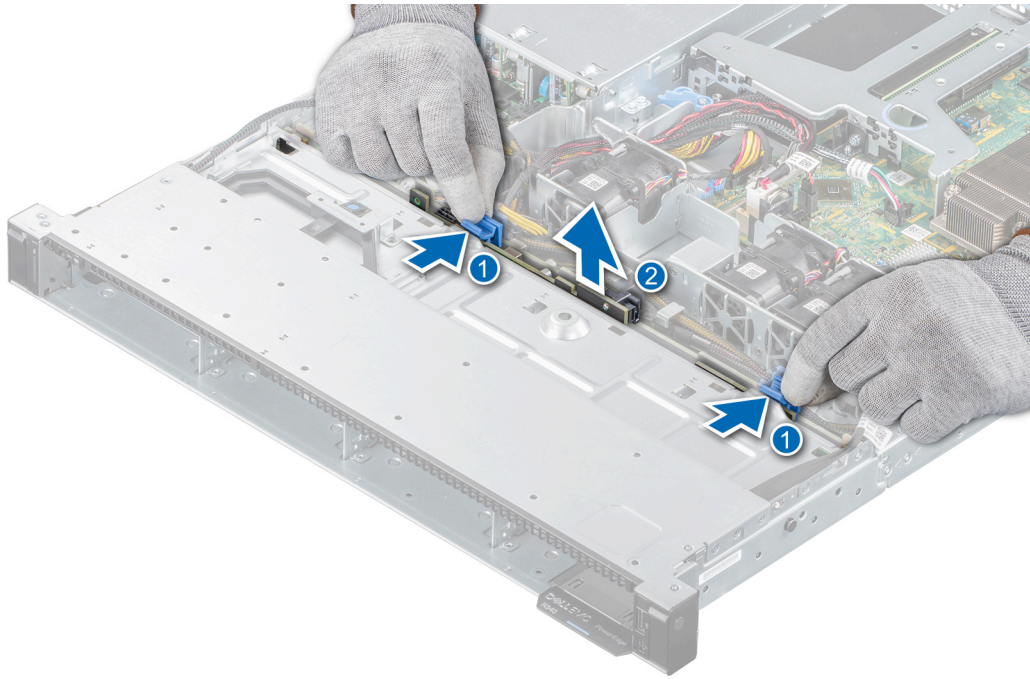

Figure 63. Removing the drive backplane

Next steps

1. [Replace the drive backplane.](#)

Installing the drive backplane

Prerequisites

1. Follow the safety guidelines listed in [Safety instructions](#).
2. Follow the procedure listed in [Before working inside your system](#).
3. [Remove the drives](#).

NOTE: To avoid damaging the backplane, ensure to move the control panel cables from the cable routing clips before removing the backplane.

NOTE: Route the cable properly when you replace it to prevent the cable from being pinched or crimped.

Steps

1. Align the slots on the backplane with the hooks on the chassis.
2. Lower the backplane until the blue release tabs click into place.

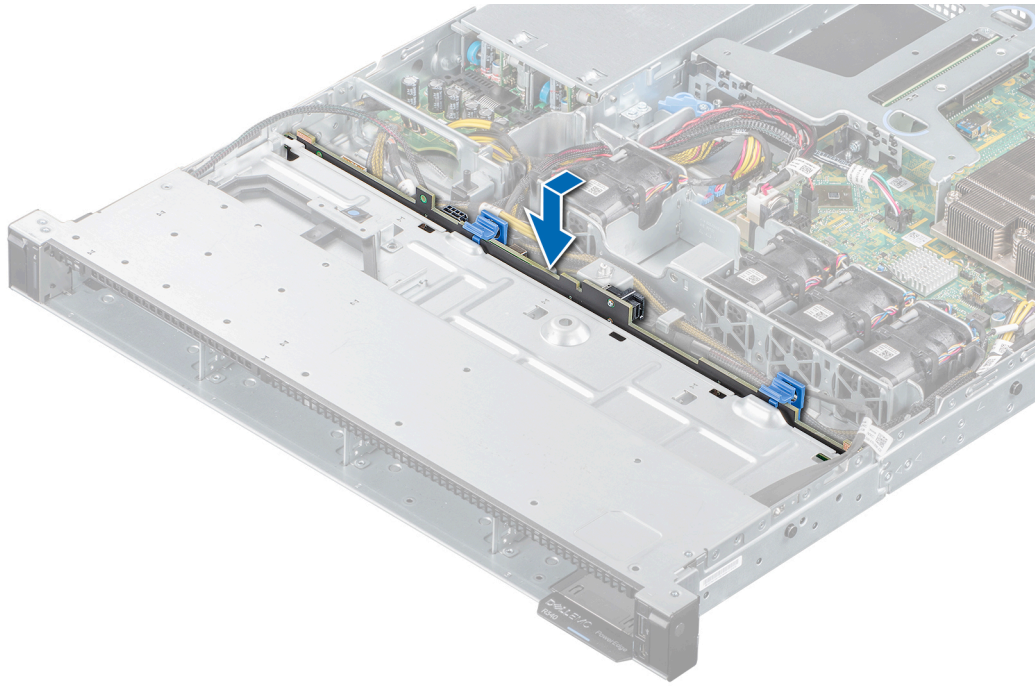

Figure 64. Installing the drive backplane

Next steps

1. Connect the following cables to the backplane:
 - a. Backplane signal cable
 - b. Backplane power cable
 - c. PERC cable
2. [Install the drives](#) in their original locations.
3. Follow the procedure listed in the [After working inside your system](#).

Cable routing

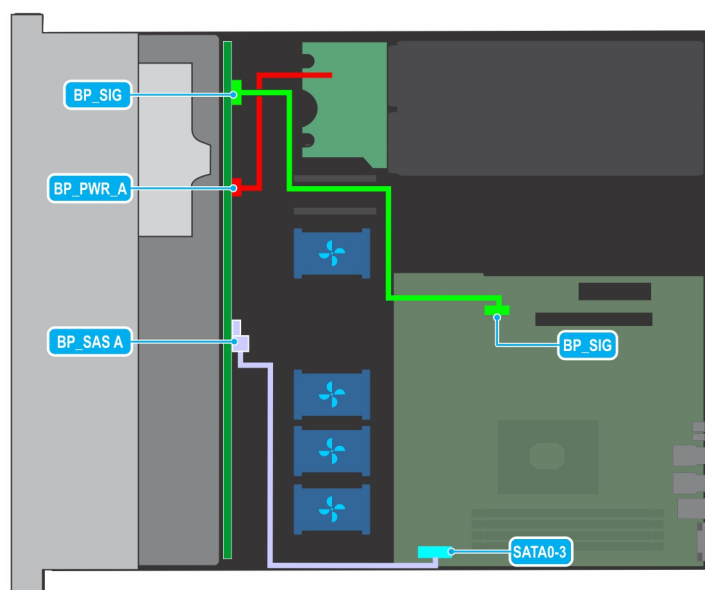

Figure 65. Cable routing - 4 x 3.5-inch SAS backplane

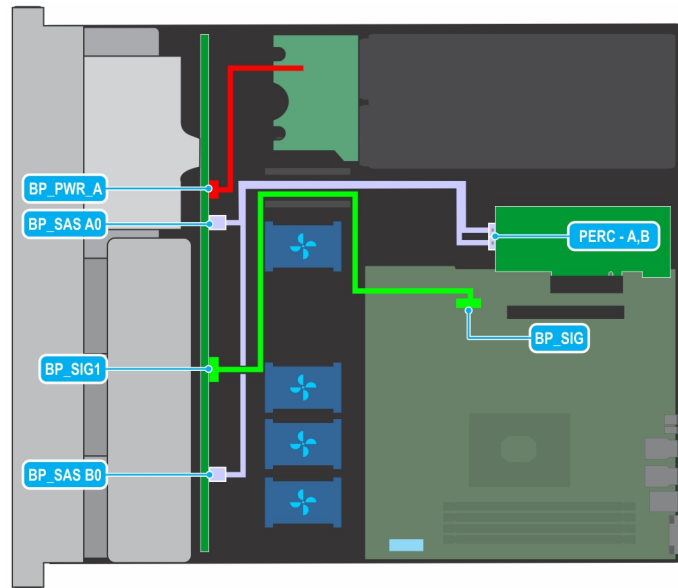

Figure 66. Cable routing - 8 x 2.5-inch SAS backplane with PERC

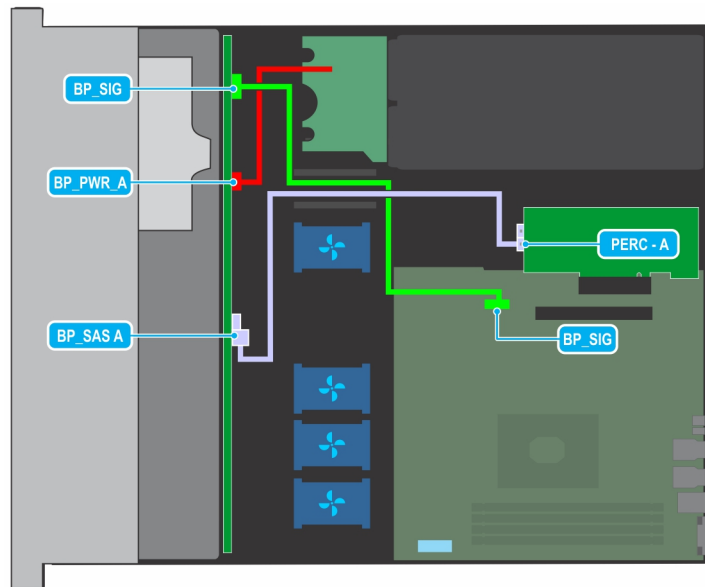

Figure 67. Cable routing - 4 x 3.5-inch SAS backplane with PERC

Power supply unit

NOTE: For more information, see the Dell EMC PowerEdge R240 Technical Specifications.

Hot spare feature

Your system supports the hot spare feature that significantly reduces the power overhead associated with power supply unit (PSU) redundancy.

When the hot spare feature is enabled, one of the redundant PSUs is switched to the sleep state. The active PSU supports 100 percent of the load, thus operating at higher efficiency. The PSU in the sleep state monitors output voltage of the active PSU. If the output voltage of the active PSU drops, the PSU in the sleep state returns to an active output state.

If having both PSUs active is more efficient than having one PSU in the sleep state, the active PSU can also activate the sleeping PSU.

The default PSU settings are as follows:

- If the load on the active PSU is more than 50 percent, then the redundant PSU is switched to the active state.
- If the load on the active PSU falls below 20 percent, then the redundant PSU is switched to the sleep state.

You can configure the hot spare feature by using the iDRAC settings. For more information about iDRAC settings, see the *Integrated Dell Remote Access Controller User's Guide* available at Dell.com/idracmanuals.

Removing a power supply unit blank

Prerequisites

1. Follow the safety guidelines listed in [Safety instructions](#).

Steps

Pull the blank out of the system.

CAUTION: To ensure proper system cooling, the power supply unit blank must be installed in the second power supply unit bay in a non-redundant configuration. Remove the power supply unit blank only if you are installing a second power supply unit.

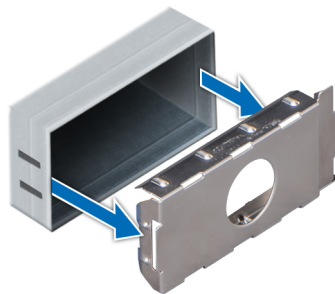

Figure 68. Removing a power supply unit blank

Next steps

1. [Replace the power supply blank](#) or [install the power supply unit](#).

Installing a power supply unit blank

Prerequisites

1. Follow the safety guidelines listed in [Safety instructions](#).
NOTE: Install the power supply unit (PSU) blank only in the second PSU bay.
2. [Remove the PSU](#).

Steps

Align the PSU blank with the PSU bay and push it into the PSU bay until it clicks into place.

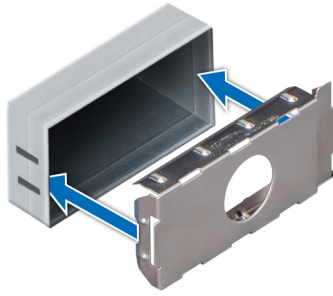

Figure 69. Installing a power supply unit blank

Removing a power supply unit

Prerequisites

CAUTION: The system requires one power supply unit (PSU) for normal operation. On power-redundant systems, remove and replace only one PSU at a time in a system that is powered on.

1. Follow the safety guidelines listed in [Safety instructions](#).
2. Disconnect the power cable from the power outlet and from the PSU you intend to remove.
3. Remove the cable from the strap on the PSU handle.
4. Unlatch and lift the optional cable management arm if it interferes with the PSU removal.

For information about the cable management arm, see the system's rack documentation at www.dell.com/poweredgemanuals.

Steps

Press the release latch, and holding the PSU handle slide the PSU out of the PSU bay.

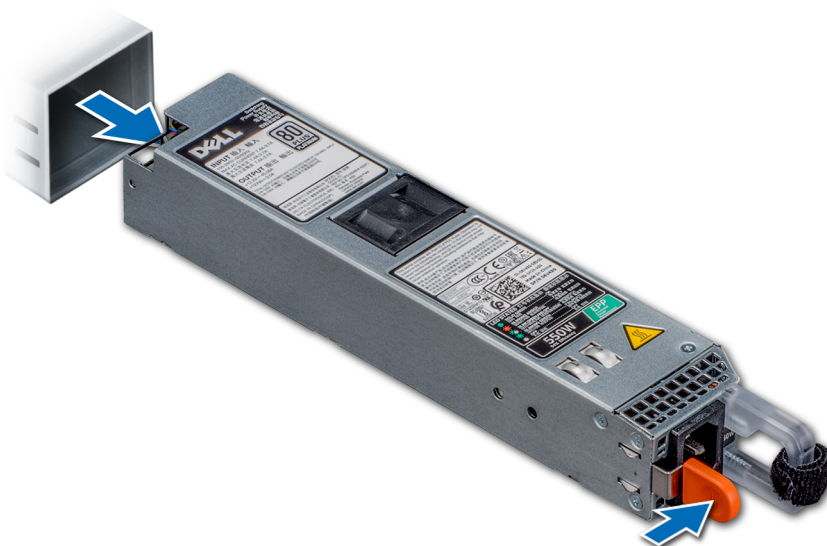

Figure 70. Removing a power supply unit

Next steps

1. [Replace the power supply units](#) or [Install the PSU blank](#).

Installing a power supply unit

Prerequisites

1. Follow the safety guidelines listed in [Safety instructions](#).
2. For systems that support redundant PSU, ensure that both the PSUs are of the same type and have the same maximum output power.

i **NOTE:** The maximum output power (shown in watts) is listed on the PSU label.

3. [Remove the PSU blank](#).

Steps

Slide the PSU into the PSU bay until the release latch snaps into place.

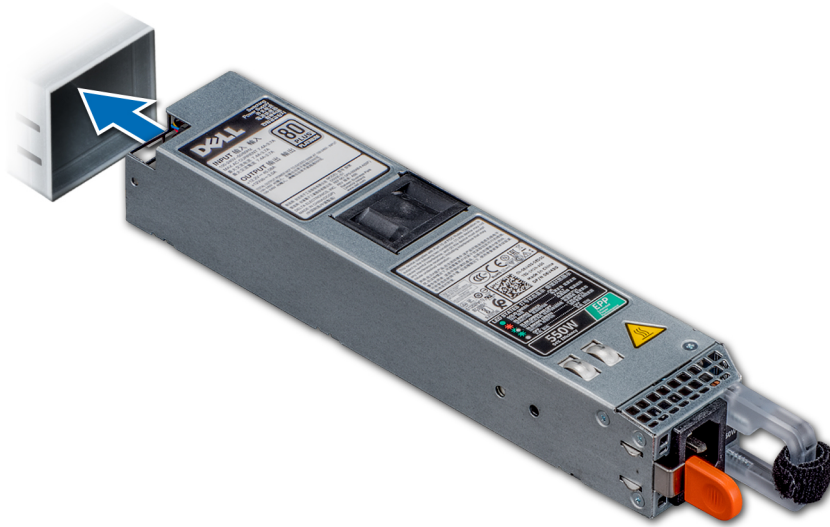

Figure 71. Installing a power supply unit

Next steps

1. If you have unlatched the cable management arm, relatch it. For information about the cable management arm, see the system's rack documentation at www.dell.com/poweredgemanuals.
2. Connect the power cable to the PSU, and plug the cable into a power outlet.
 - i** **NOTE:** When connecting the power cable to the PSU, secure the cable to the PSU with the strap.
 - i** **NOTE:** When installing, hot swapping, or hot adding a new PSU, wait for 15 seconds for the system to recognize the PSU and determine its status. The PSU redundancy may not occur until discovery is complete. The PSU status indicator turns green to indicate that the PSU is functioning properly.

Power distribution board

Removing the power distribution board

Prerequisites

1. Follow the safety guidelines listed in [Safety instructions](#).
2. Follow the procedure listed in the [Before working inside your system](#).
3. [Remove the power supply units](#).

Steps

1. Disconnect all the cables from the system board and the backplane.
i **NOTE:** Observe the routing of the cable as you remove it from the system.
2. Using a Phillips #2 screwdriver, remove the screws securing the power distribution board (PDB) to the system.
3. Slide the PDB toward the rear of the system to disengage it from the standoffs.
4. Lift the PDB from the system.

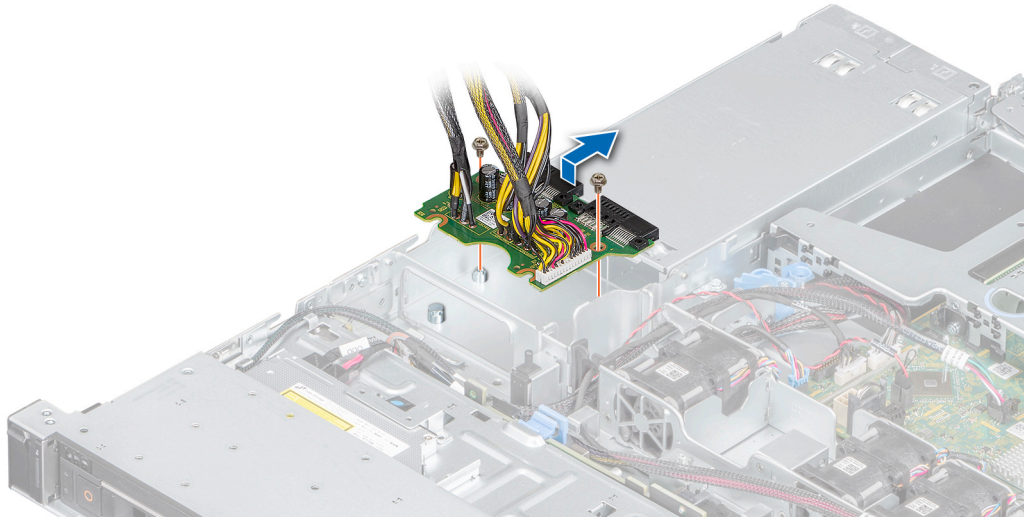

Figure 72. Removing the power distribution board

Next steps

1. [Replace the power distribution board.](#)

Installing the power distribution board

Prerequisites

1. Follow the safety guidelines listed in the [Safety instructions](#).
2. Follow the procedure listed in [Before working inside your system](#).

Steps

1. Align the slots on the power distribution board (PDB) with the standoffs on the chassis.
2. Using a Phillips #2 screwdriver, replace the screws that secure the PDB to the chassis.
3. Connect the cables to the system board and the drive backplane.

i **NOTE:** Route the cables properly when you replace the PDB to prevent the cable from being pinched or crimped.

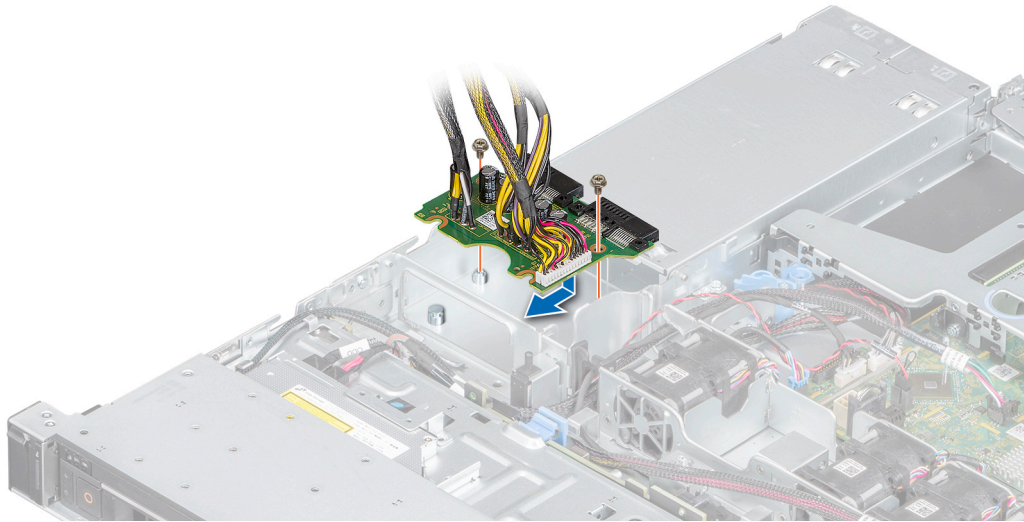

Figure 73. Installing the power distribution board

Next steps

1. [Install the power supply units.](#)
2. Follow the procedure listed in [After working inside your system.](#)

System board

Removing the system board

Prerequisites

CAUTION: If you are using the Trusted Platform Module (TPM) with an encryption key, you may be prompted to create a recovery key during program or System Setup. Be sure to create and safely store this recovery key. If you replace this system board, you must supply the recovery key when you restart your system or program before you can access the encrypted data on your drives.

1. Follow the safety guidelines listed in [Safety instructions.](#)
2. Follow the procedure listed in [Before working inside your system.](#)
3. Remove the following components:
 - a. [Air shroud](#)
 - b. [Memory modules](#)
 - c. Disconnect the fan cables
 - d. [Expansion card riser](#)
 - e. If applicable, [storage controller card](#)
 - f. [Heat sink and processor](#)

CAUTION: To prevent damage to the processor socket when replacing a faulty system board, ensure that you cover the processor socket with the processor dust cover.

- g. [Internal USB](#), if installed
- h. If applicable, [Internal Dual SD module](#)
- i. Disconnect all the cables from the system board.

CAUTION: Take care not to damage the system identification button while removing the system board from the system.

Steps

1. Using a Phillips #2 screwdriver, remove the screws securing the system board to the chassis.

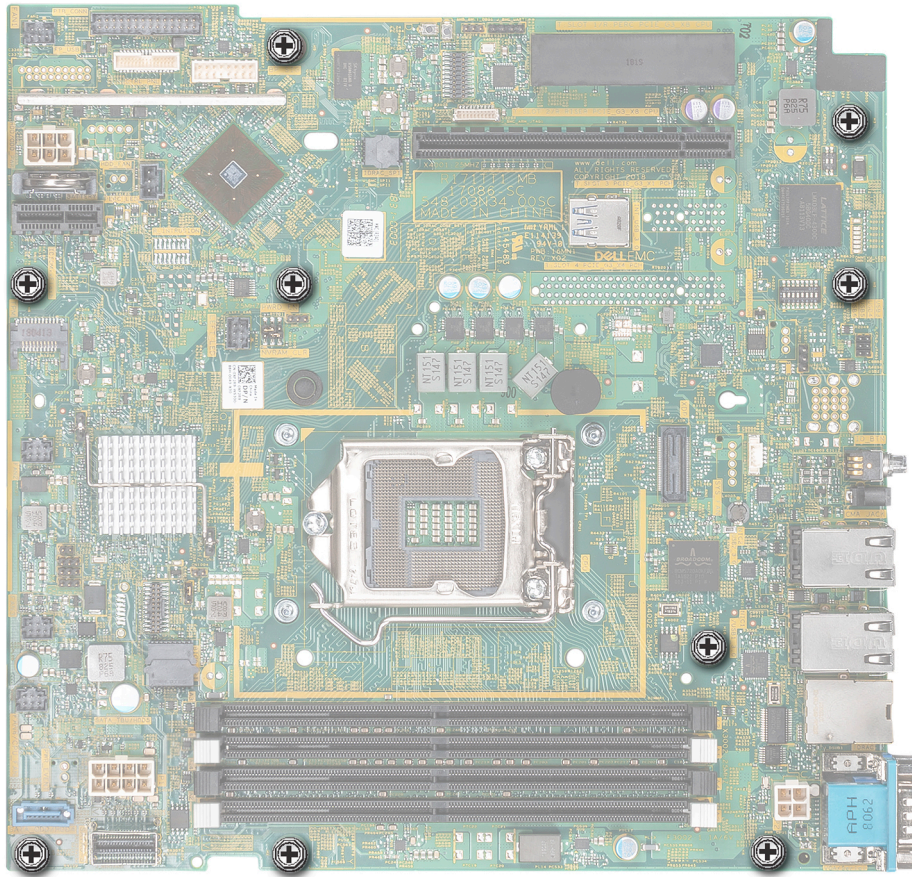

Figure 74. System board screws

2. Using the system board holder, slightly lift the system board, and then slide it toward the front of the chassis.
3. Lift the system board out of the chassis.

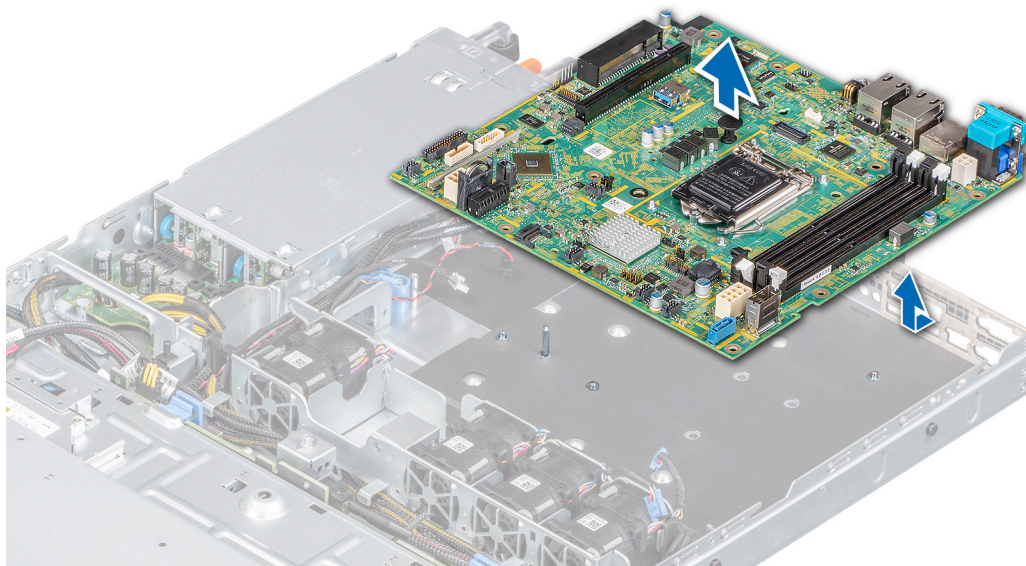

Figure 75. Removing the system board

Next steps

1. [Replace the system board.](#)

Installing the system board

Prerequisites

i **NOTE:** Before replacing the system board, replace the old iDRAC MAC address label in the Information tag with the iDRAC MAC address label of the replacement system board.

1. Follow the safety guidelines listed in [Safety instructions](#).
2. Follow the procedure listed in [Before working inside your system](#).
3. If you are replacing the system board, remove all the components that are listed in the [removing the system board](#) section.

Steps

1. Unpack the new system board assembly.

i **NOTE:** Do not lift the system board by holding a memory module, processor, or other components.

⚠ **CAUTION:** Take care not to damage the system identification button while placing the system board into the chassis.

2. Holding the system board holder, lower the system board it into the system.
3. Incline the system board at an angle and align the connectors with the slots on the rear of the chassis.
4. Slide the system board towards the rear of the chassis until the connectors are firmly seated in the slots.

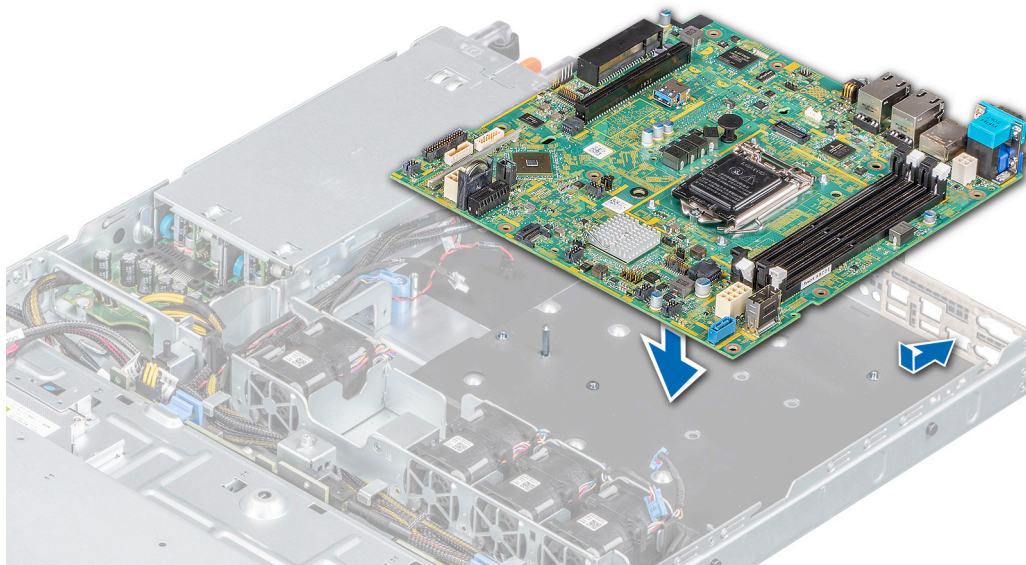

Figure 76. Installing the system board

5. Using a Phillips #2 screwdriver, fasten the screws that secure the system board to the chassis.

Next steps

1. Replace the following:

- a. [Trusted platform module](#)

i **NOTE:** The TPM Module must be replaced only while installing new system board.

- b. [Internal dual SD module](#), if applicable
- c. [Heat sink and processor](#)
- d. If applicable, [Storage controller card](#)



- e. [Internal USB](#)
 - f. [Expansion card riser](#)
 - g. Connect the fan cables
 - h. [Memory modules](#)
 - i. [Air shroud](#)
 - j. Reconnect the cables to the system board.
 -  **NOTE:** Ensure that the cables inside the system are routed along the chassis wall and secured using the cable securing bracket.
2. Power on the system.
 3. Follow the procedure listed in [After working inside your system](#).
 4. Ensure that you perform the following steps:
 - a. Use the Easy Restore feature to restore the service tag. See the [Restoring the system by using the Easy Restore](#) feature section.
 - b. If the service tag is not backed up in the backup flash device, enter the system service tag manually. See the [Manually update the Service Tag](#) by using System Setup section.
 - c. Update the BIOS and iDRAC versions.
 - d. Re-enable the Trusted Platform Module (TPM). See the [Reenabling the TPM for BitLocker users](#) section.
 5. If you are not using Easy restore, import your new or existing iDRAC Enterprise license. For more information, see the *Integrated Dell Remote Access Controller User's Guide*, at www.dell.com/idracmanuals.

Restoring the system using Easy Restore

The easy restore feature enables you to restore your service tag, license, UEFI configuration, and the system configuration data after replacing the system board. All data is backed up in a backup flash device automatically. If BIOS detects a new system board, and the service tag in the backup flash device, BIOS prompts the user to restore the backup information.

About this task

Below is a list of options available:

- Restore the service tag, license, and diagnostics information, press **Y**
- Navigate to the Lifecycle Controller based restore options, press **N**.
- Restore data from a previously created **Hardware Server Profile**, press **F10**
 -  **NOTE:** When the restore process is complete, BIOS prompts to restore the system configuration data.
- To restore the system configuration data, press **Y**
- To use the default configuration settings, press **N**
 -  **NOTE:** After the restore process is complete, system reboots.

Manually update the Service Tag

After replacing a system board, if Easy Restore fails, follow this process to manually enter the Service Tag, using **System Setup**.

About this task

If you know the system service tag, use the **System Setup** menu to enter the service tag.

Steps

1. Power on the system.
2. To enter the **System Setup**, press **F2**.
3. Click **Service Tag Settings**.
4. Enter the service tag.
 -  **NOTE:** You can enter the service tag only when the **Service Tag** field is empty. Ensure that you enter the correct service tag. Once the service tag is entered, it cannot be updated or changed.
5. Click **OK**.

Trusted Platform Module

Upgrading the Trusted Platform Module

Prerequisites

NOTE:

- Ensure that your operating system supports the version of the TPM module being installed.
- Ensure that you download and install the latest BIOS firmware on your system.
- Ensure that the BIOS is configured to enable UEFI boot mode.

About this task

 **CAUTION:** Once the TPM plug-in module is installed, it is cryptographically bound to that specific system board. Any attempt to remove an installed TPM plug-in module breaks the cryptographic binding, the removed TPM cannot be reinstalled or installed on another system board.

Removing the TPM

Steps

1. Locate the TPM connector on the system board.
2. Press to hold the module down and remove the screw using the security Torx 8-bit shipped with the TPM module.
3. Slide the TPM module out from its connector.
4. Push the plastic rivet away from the TPM connector and rotate it 90° counterclockwise to release it from the system board.
5. Pull the plastic rivet out of its slot on the system board.

Installing the TPM

Steps

1. To install the TPM, align the edge connectors on the TPM with the slot on the TPM connector.
2. Insert the TPM into the TPM connector such that the plastic rivet aligns with the slot on the system board.
3. Press the plastic rivet until the rivet snaps into place.
4. Replace the screw that secures the TPM to the system board.

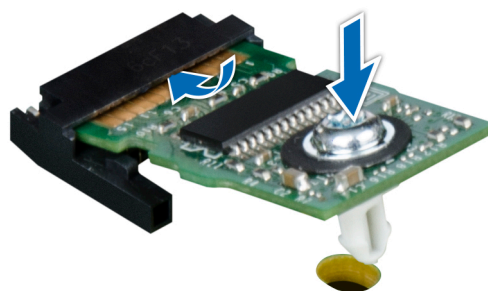

Figure 77. Installing the TPM

Next steps

1. [Replace the system board.](#)

2. Follow the procedure listed in [After working inside your system](#).
3. To verify if the memory module has been installed properly, press F2 and navigate to **System Setup Main Menu > System BIOS > Memory Settings**. In the **Memory Settings** screen, the System Memory Size must reflect the updated capacity of the installed memory.
4. If the value is incorrect, one or more of the memory modules may not be installed properly. Ensure that the memory module is firmly seated in the memory module socket.
5. Run the system memory test in system diagnostics.

Initializing TPM for BitLocker users

Steps

1. Initialize the TPM.
For more information, see [initializing the TPM for Intel TXT users](#).
2. The **TPM Status** changes to **Enabled, Activated**.

Initializing the TPM 1.2 for TXT users

Steps

1. While booting your system, press F2 to enter System Setup.
2. On the **System Setup Main Menu** screen, click **System BIOS > System Security Settings**.
3. From the **TPM Security** option, select **On with Preboot Measurements**.
4. From the **TPM Command** option, select **Activate**.
5. Save the settings.
6. Restart your system.
7. Enter **System Setup** again.
8. On the **System Setup Main Menu** screen, click **System BIOS > System Security Settings**.
9. From the **Intel TXT** option, select **On**.

Initializing the TPM 2.0 for TXT users

Steps

1. While booting your system, press F2 to enter System Setup.
2. On the **System Setup Main Menu** screen, click **System BIOS > System Security Settings**.
3. From the **TPM Security** option, select **On**.
4. Save the settings.
5. Restart your system.
6. Enter **System Setup** again.
7. On the **System Setup Main Menu** screen, click **System BIOS > System Security Settings**.
8. Select the **TPM Advanced Settings** option.
9. From the **TPM2 Algorithm Selection** option, select **SHA256**, then go back to **System Security Settings** screen.
10. On the **System Security Settings** screen, from the **Intel TXT** option, select **On**.
11. Save the settings.
12. Restart your system.

Control panel

Removing the left control panel

Prerequisites

1. Follow the safety guidelines listed in [Safety instructions](#).
2. Follow the procedure listed in [Before working inside your system](#).

Steps

1. Disconnect the control panel cable from the system board connector.
i **NOTE:** Observe the routing of the cable as you remove it from the system.
2. Using the appropriate screwdriver, remove the screws that secure the left control panel assembly to the system.
3. Disengage the left control panel housing clip which is located on the bottom of the left control panel assembly.
4. Hold the left control panel assembly and remove it from the system.

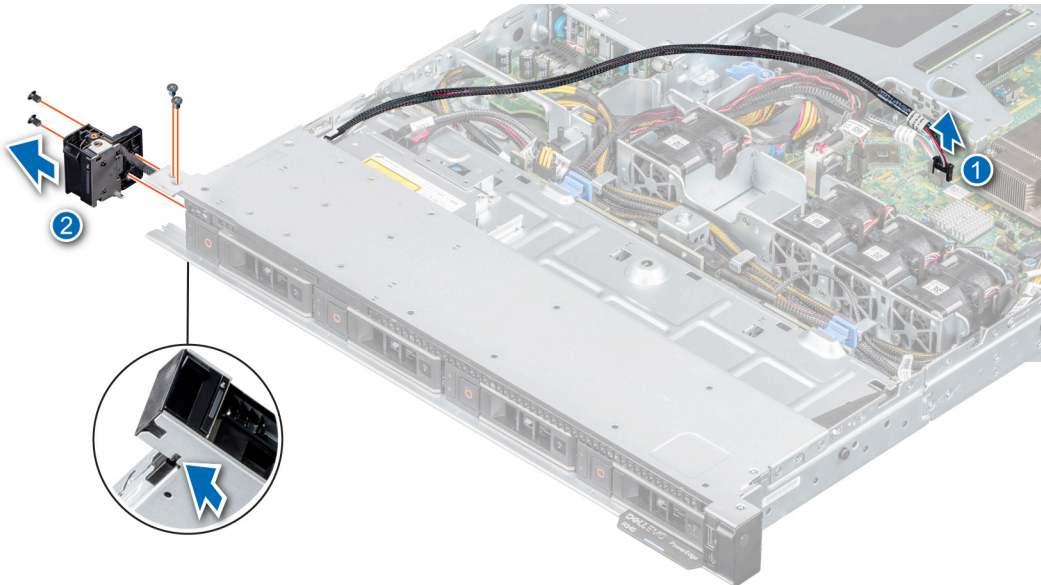

Figure 78. Removing the left control panel

Next steps

1. [Replace the left control panel](#).

Installing the left control panel

Prerequisites

1. Follow the safety guidelines listed in [Safety instructions](#).
2. Follow the procedure listed in [Before working inside your system](#).

Steps

1. Route the control panel cable through the side wall and the guide slots in the system and connect it to the system board.
i **NOTE:** Route the cable properly to prevent the cable from being pinched or crimped.
2. Align and insert the left control panel assembly in the slot on the system.

3. Using the appropriate screwdriver, fasten the screws that secure the left control panel assembly.

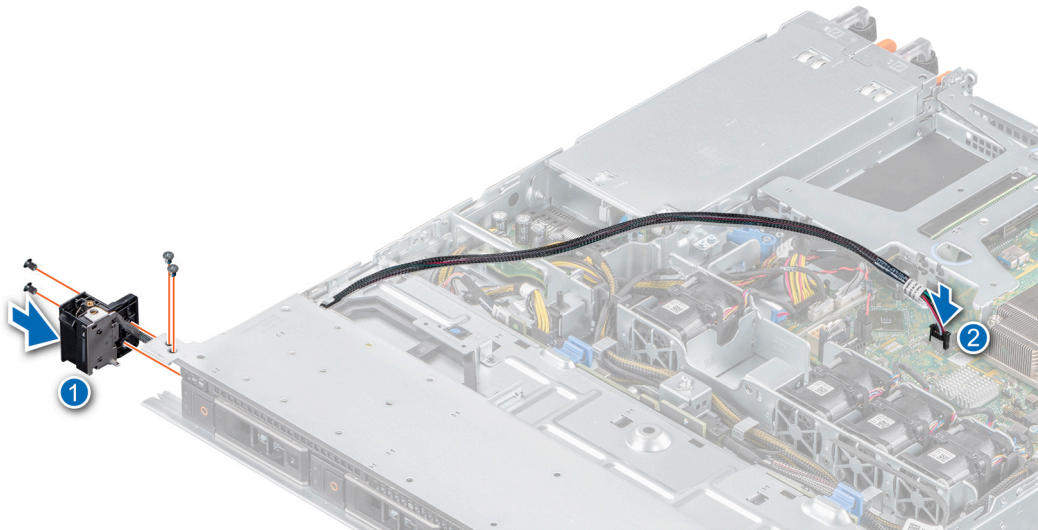

Figure 79. Installing the left control panel

Next steps

1. Follow the procedure listed in [After working inside your system](#).

Removing the right control panel

Prerequisites

1. Follow the safety guidelines listed in [Safety instructions](#).
2. Follow the procedure listed in [Before working inside your system](#).

Steps

1. Disconnect the control panel cable from the connector on the system board.

NOTE: Observe the routing of the cable as you remove it from the system.

2. Using the appropriate screwdriver, remove the screws that secure the right control panel assembly.
3. Hold the right control panel assembly and remove it from the system.

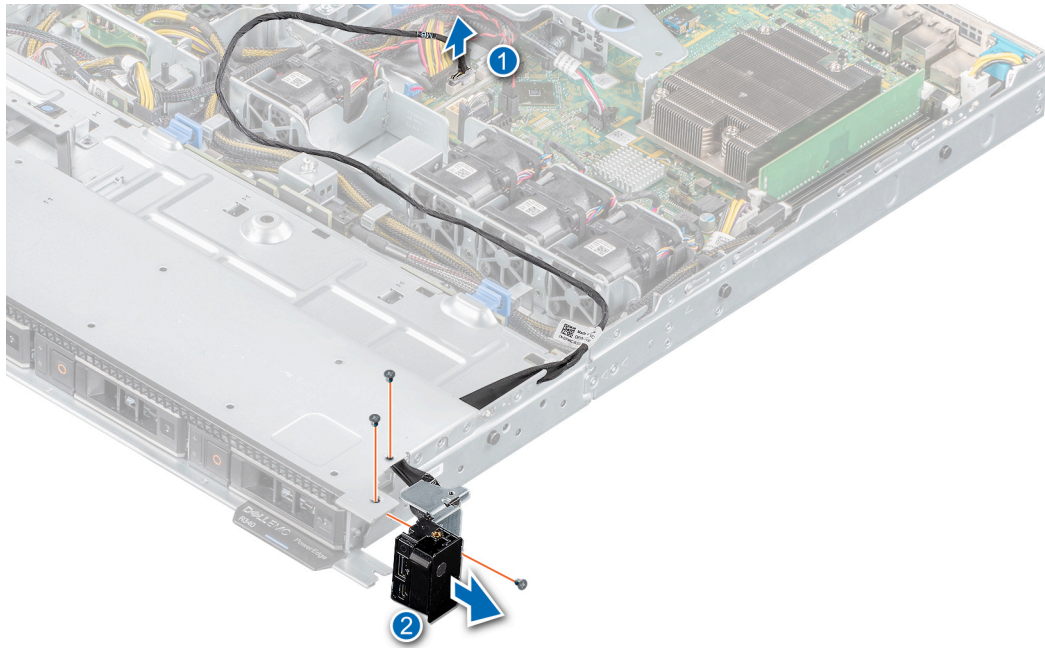

Figure 80. Removing the right control panel

Next steps

1. [Replace the right control panel.](#)

Installing the right control panel

Prerequisites

1. Follow the safety guidelines listed in [Safety instructions](#).

Steps

1. Route the control panel cable through the side wall and the guide slots in the system.

NOTE: Route the cable properly to prevent the cable from being pinched or crimped.

2. Align and insert the right control panel assembly in the slot on the system.
3. Using the appropriate screwdriver, fasten the screws that secure the right control panel assembly.
4. Connect the control panel cable to the connector on the system board.

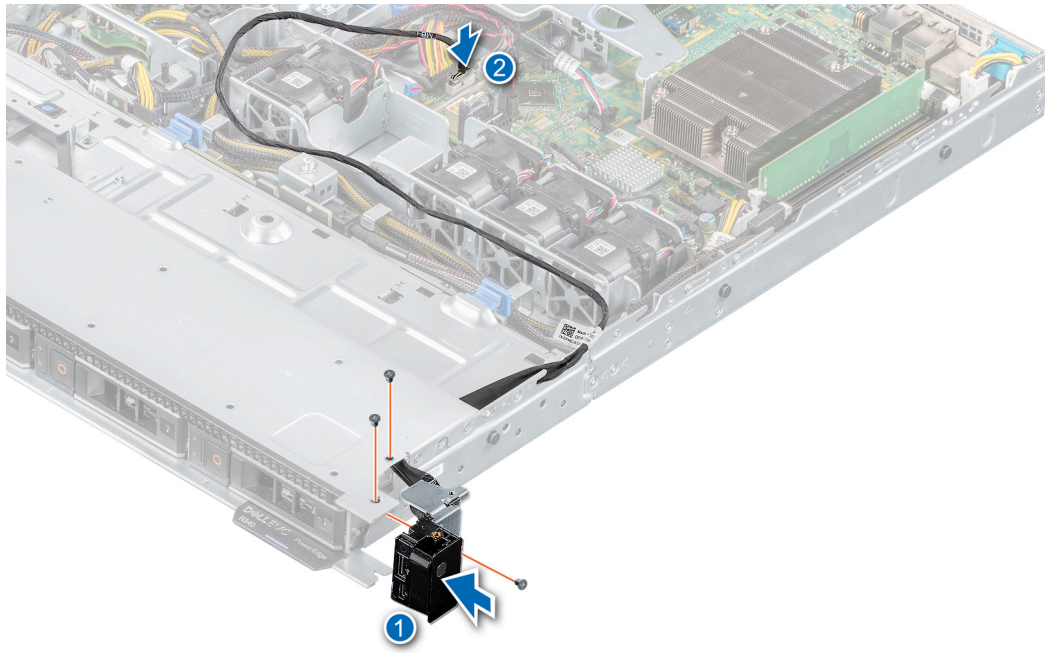

Figure 81. Installing the right control panel

Next steps

1. Follow the procedure listed in [After working inside your system.](#)

Jumpers and connectors

This topic provides specific information about the jumpers. It also provides some basic information about jumpers and switches and describes the connectors on the various boards in the system. Jumpers on the system board help to disable the system and setup passwords. You must know the connectors on the system board to install components and cables correctly.

Topics:

- System board connectors
- System board jumper settings
- Disabling forgotten password

System board connectors

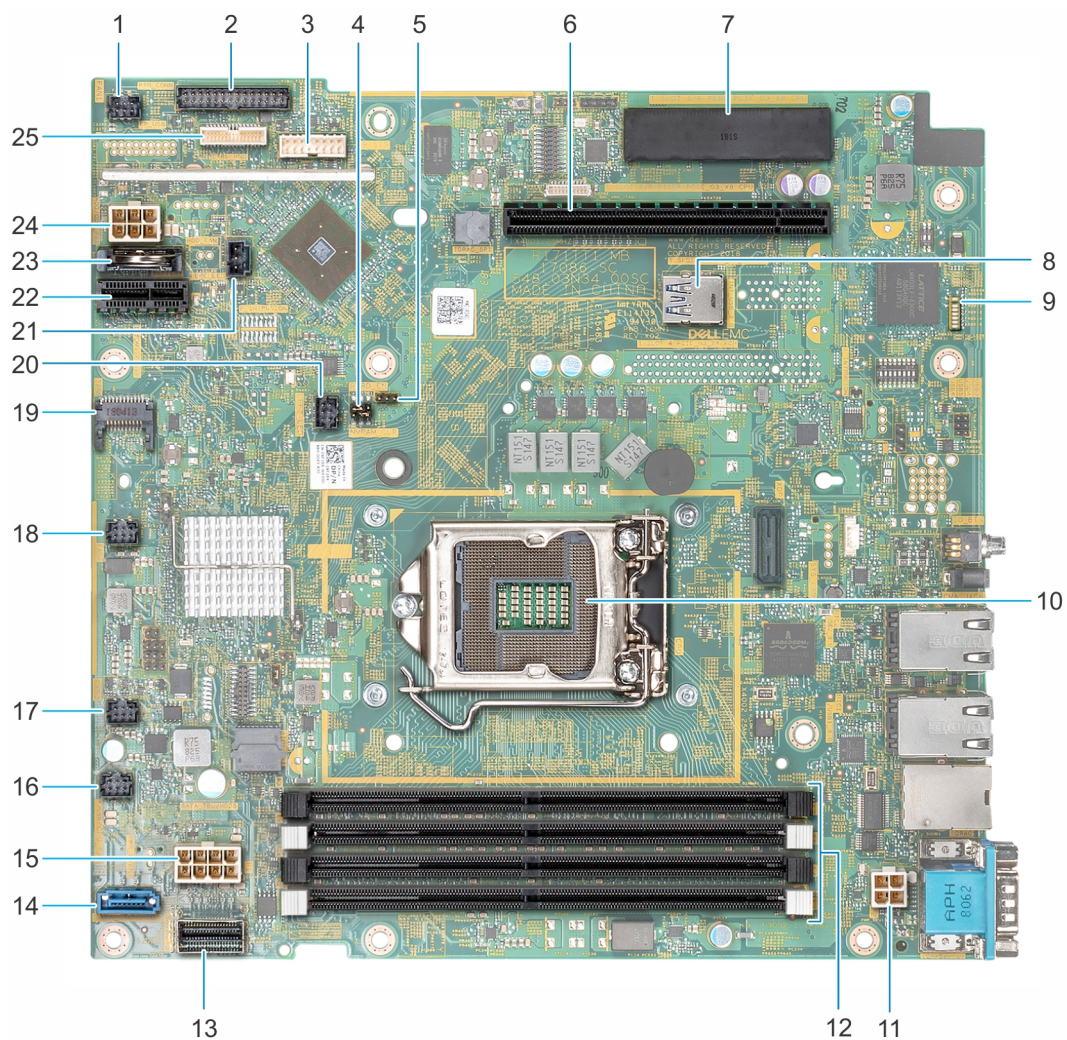

Figure 82. System board connectors

Table 11. System board connectors

Item	Connector	Description
1	FAN1	Fan 1 connector
2	PIB_CONN	Power distribution board signal connector
3	BP_SIG	Backplane signal connector
4	NVRAM_CLR	Clear NVRAM jumper
5	PWRD_EN	Reset BIOS password jumper
6	RISER_PCIE	Expansion riser PCIe x8 socket
7	PERC_PCIE	PERC PCIe x8 socket
8	INT_USB_3.0	Internal USB connector
9	LED's	System board diagnostic LED indicators
10	CPU	Processor socket
11	P2	Power distribution board power connector 2
12	A3, A1, A4, A2	Memory module sockets
13	SATA0-3	SATA signal
14	SATA_ODD-HDD4	SATA connector—Optical drive SATA connector
15	P1	Power distribution board power connector 1
16	FAN4	Fan 4 connector
17	FAN3	Fan 3 connector
18	FAN2	Fan 2 connector
19	TPM	TPM connector
20	LEFT_LED	Left control panel connector
21	R_INTRUSION	Intrusion switch connector
22	IDSDM.vFlash	IDSDM/ vFlash connector
23	BATTERY	CMOS coin cell battery socket
24	HDD/ODD_PWR	Optical drive power connector
25	CTRL_PNL	Right control panel connector

System board jumper settings

For information on resetting the password jumper to disable a password, see the [Disabling a forgotten password](#) section.

Disabling forgotten password

The software security features of the system include a system password and a setup password. The password jumper enables or disables password features and clears any password(s) currently in use.

Prerequisites

 **CAUTION:** Many repairs may only be done by a certified service technician. You should only perform troubleshooting and simple repairs as authorized in your product documentation, or as directed by the online or telephone service and support team. Damage due to servicing that is not authorized by Dell is not covered by your warranty. Read and follow the safety instructions that are shipped with your product.

Steps

1. Power off the system, including any attached peripherals, and disconnect the system from the electrical outlet.
2. Remove the system cover.
3. Move the jumper on the system board jumper from pins 2 and 4 to pins 4 and 6.
4. Install the system cover.

The existing passwords are not disabled (erased) until the system boots with the jumper on pins 4 and 6. However, before you assign a new system and/or setup password, you must move the jumper back to pins 2 and 4.

 **NOTE:** If you assign a new system and/or setup password with the jumper on pins 4 and 6, the system disables the new password(s) the next time it boots.

5. Reconnect the system to its electrical outlet and power on the system, including any attached peripherals.
6. Power off the system, including any attached peripherals, and disconnect the system from the electrical outlet.
7. Remove the system cover.
8. Move the jumper on the system board jumper from pins 4 and 6 to pins 2 and 4.
9. Install the system cover.
10. Reconnect the system to its electrical outlet and power on the system, including any attached peripherals.
11. Assign a new system and/or setup password.

System diagnostics and indicator codes

The diagnostic indicators on the system front panel display system status during system startup.

Topics:

- [System health and system ID indicator codes](#)
- [iDRAC Direct LED indicator codes](#)
- [NIC indicator codes](#)
- [Power supply unit indicator codes](#)
- [Drive indicator codes](#)
- [System diagnostics](#)

System health and system ID indicator codes

The system health and system ID indicator is located on the left control panel of your system.



Figure 83. System health and system ID indicator

Table 12. System health and system ID indicator codes

System health and system ID indicator code	Condition
Solid blue	Indicates that the system is turned on, system is healthy, and system ID mode is not active. Press the system health and system ID button to switch to system ID mode.
Blinking blue	Indicates that the system ID mode is active. Press the system health and system ID button to switch to system health mode.

Table 12. System health and system ID indicator codes (continued)

System health and system ID indicator code	Condition
Solid amber	Indicates that the system is in fail-safe mode. If the problem persists, see the Getting help section.
Blinking amber	Indicates that the system is experiencing a fault. Check the System Event Log for specific error messages. For information about the event and error messages generated by the system firmware and agents that monitor system components, go to qrl.dell.com > Look Up > Error Code , type the error code, and then click Look it up .

iDRAC Direct LED indicator codes

The iDRAC Direct LED indicator lights up to indicate that the port is connected and is being used as a part of the iDRAC subsystem.

You can configure iDRAC Direct by using a USB to micro USB (type AB) cable, which you can connect to your laptop or tablet. The following table describes iDRAC Direct activity when the iDRAC Direct port is active:

Table 13. iDRAC Direct LED indicator codes

iDRAC Direct LED indicator code	Condition
Solid green for two seconds	Indicates that the laptop or tablet is connected.
Flashing green (on for two seconds and off for two seconds)	Indicates that the laptop or tablet connected is recognized.
Powers off	Indicates that the laptop or tablet is unplugged.

NIC indicator codes

Each NIC on the back of the system has indicators that provide information about the activity and link status. The activity LED indicator indicates if data is flowing through the NIC, and the link LED indicator indicates the speed of the connected network.

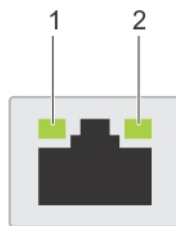

Figure 84. NIC indicator codes

1. Link LED indicator
2. Activity LED indicator

Table 14. NIC indicator codes

Status	Condition
Link and activity indicators are off.	The NIC is not connected to the network.
Link indicator is green, and activity indicator is blinking green.	The NIC is connected to a valid network at its maximum port speed, and data is being sent or received.
Link indicator is amber, and activity indicator is blinking green.	The NIC is connected to a valid network at less than its maximum port speed, and data is being sent or received.

Table 14. NIC indicator codes (continued)

Status	Condition
Link indicator is green, and activity indicator is off.	The NIC is connected to a valid network at its maximum port speed, and data is not being sent or received.
Link indicator is amber, and activity indicator is off.	The NIC is connected to a valid network at less than its maximum port speed, and data is not being sent or received.
Link indicator is blinking green, and activity is off.	NIC identify is enabled through the NIC configuration utility.

Power supply unit indicator codes

AC power supply units (PSUs) have an illuminated translucent handle that serves as an indicator. The indicator shows whether power is present or if a power fault has occurred.



Figure 85. AC PSU status indicator

1. AC PSU status indicator/handle

Table 15. AC PSU status indicator codes

Power indicator codes	Condition
Green	A valid power source is connected to the PSU and the PSU is operational.
Blinking amber	Indicates a problem with the PSU.
Not illuminated	Power is not connected to the PSU.
Blinking green	When the firmware of the PSU is being updated, the PSU handle blinks green. ⚠ CAUTION: Do not disconnect the power cord or unplug the PSU when updating firmware. If firmware update is interrupted, the PSUs do not function.
Blinking green and turns off	When hot-plugging a PSU, the PSU handle blinks green five times at a rate of 4 Hz and turns off. This indicates a PSU mismatch with respect to efficiency, feature set, health status, or supported voltage. ⚠ CAUTION: If two PSUs are installed, both the PSUs must have the same type of label; for example, Extended Power Performance (EPP) label. Mixing PSUs from previous generations of PowerEdge servers is not supported, even if the PSUs have the same power rating. This results in a PSU mismatch condition or failure to power on the system. ⚠ CAUTION: When correcting a PSU mismatch, replace only the PSU with the blinking indicator. Swapping the PSU to make a matched pair can result in an error condition and unexpected system shutdown. To change from a high output configuration to a low output configuration or vice versa, you must power off the system. ⚠ CAUTION: AC PSUs support both 240 V and 120 V input voltages with the exception of Titanium PSUs, which support only 240 V. When two identical PSUs receive different input voltages, they can output different wattages, and trigger a mismatch. ⚠ CAUTION: If two PSUs are used, they must be of the same type and have the same maximum output power.

Drive indicator codes

The LEDs on the drive carrier indicates the state of each drive. Each drive carrier in your system has two LEDs: an activity LED (green) and a status LED (bicolor, green/amber). The activity LED flashes whenever the drive is accessed.



Figure 86. Drive indicators

1. Drive activity LED indicator
2. Drive status LED indicator
3. Drive capacity label

NOTE: If the drive is in the Advanced Host Controller Interface (AHCI) mode, the status LED indicator does not turn on.

Table 16. Drive indicator codes

Drive status indicator code	Condition
Flashes green twice per second	Identifying drive or preparing for removal.
Off	Drive ready for removal. NOTE: The drive status indicator remains off until all drives are initialized after the system is turned on. Drives are not ready for removal during this time.
Flashes green, amber, and then turns off	Predicted drive failure.
Flashes amber four times per second	Drive failed.
Flashes green slowly	Drive rebuilding.
Solid green	Drive online.
Flashes green for three seconds, amber for three seconds, and then turns off after six seconds	Rebuild stopped.

System diagnostics

If you experience a problem with your system, run the system diagnostics before contacting Dell for technical assistance. The purpose of running system diagnostics is to test your system hardware without using additional equipment or risking data loss. If you are unable to fix the problem yourself, service and support personnel can use the diagnostics results to help you solve the problem.

Dell Embedded System Diagnostics

NOTE: The Dell Embedded System Diagnostics is also known as Enhanced Pre-boot System Assessment (ePSA) diagnostics.

The Embedded System Diagnostics provides a set of options for particular device groups or devices allowing you to:

- Run tests automatically or in an interactive mode
- Repeat tests
- Display or save test results
- Run thorough tests to introduce additional test options to provide extra information about the failed device(s)

- View status messages that inform you if tests are completed successfully
- View error messages that inform you of problems encountered during testing

Running the Embedded System Diagnostics from Boot Manager

Run the Embedded System Diagnostics (ePSA) if your system does not boot.

Steps

1. When the system is booting, press F11.
2. Use the up arrow and down arrow keys to select **System Utilities > Launch Diagnostics**.
3. Alternatively, when the system is booting, press F10, select **Hardware Diagnostics > Run Hardware Diagnostics**.
The **ePSA Pre-boot System Assessment** window is displayed, listing all devices detected in the system. The diagnostics starts executing the tests on all the detected devices.

Running the Embedded System Diagnostics from the Dell Lifecycle Controller

Steps

1. As the system boots, press F10.
2. Select **Hardware Diagnostics → Run Hardware Diagnostics**.
The **ePSA Pre-boot System Assessment** window is displayed, listing all devices detected in the system. The diagnostics starts executing the tests on all the detected devices.

System diagnostic controls

Menu	Description
Configuration	Displays the configuration and status information of all detected devices.
Results	Displays the results of all tests that are run.
System health	Provides the current overview of the system performance.
Event log	Displays a time-stamped log of the results of all tests run on the system. This is displayed if at least one event description is recorded.

Getting help

Topics:

- [Contacting Dell](#)
- [Recycling or End-of-Life service information](#)
- [Accessing system information by using QRL](#)
- [Receiving automated support with SupportAssist](#)

Contacting Dell

Dell provides several online and telephone based support and service options. If you do not have an active internet connection, you can find contact information about your purchase invoice, packing slip, bill, or Dell product catalog. Availability varies by country and product, and some services may not be available in your area. To contact Dell for sales, technical assistance, or customer service issues:

Steps

1. Go to www.dell.com/support/home
2. Select your country from the drop-down menu on the lower right corner of the page.
3. For customized support:
 - a. Enter your system Service Tag in the **Enter your Service Tag** field.
 - b. Click **Submit**.
The support page that lists the various support categories is displayed.
4. For general support:
 - a. Select your product category.
 - b. Select your product segment.
 - c. Select your product.
The support page that lists the various support categories is displayed.
5. For contact details of Dell Global Technical Support:
 - a. Click [Contact Technical Support](#)
 - b. The **Contact Technical Support** page is displayed with details to call, chat, or e-mail the Dell Global Technical Support team.

Recycling or End-of-Life service information

Take back and recycling services are offered for this product in certain countries. If you want to dispose of system components, visit www.dell.com/recyclingworldwide and select the relevant country.

Accessing system information by using QRL

You can use the Quick Resource Locator (QRL) located on the information tag in the front of the system, to access the information about the PowerEdge system.

Prerequisites

Ensure that your smartphone or tablet has the QR code scanner installed.

The QRL includes the following information about your system:

- How-to videos

- Reference materials, including the Installation and Service Manual, and mechanical overview
- Your system service tag to quickly access your specific hardware configuration and warranty information
- A direct link to Dell to contact technical assistance and sales teams

Steps

1. Go to www.dell.com/qrl and navigate to your specific product or
2. Use your smartphone or tablet to scan the model-specific Quick Resource (QR) code on your system or in the Quick Resource Locator section.

Quick Resource Locator for Dell EMC PowerEdge R340 system



Figure 87. Quick Resource Locator for Dell EMC PowerEdge R340 system

Receiving automated support with SupportAssist

Dell EMC SupportAssist is an optional Dell EMC Services offering that automates technical support for your Dell EMC server, storage, and networking devices. By installing and setting up a SupportAssist application in your IT environment, you can receive the following benefits:

- **Automated issue detection** — SupportAssist monitors your Dell EMC devices and automatically detects hardware issues, both proactively and predictively.
- **Automated case creation** — When an issue is detected, SupportAssist automatically opens a support case with Dell EMC Technical Support.
- **Automated diagnostic collection** — SupportAssist automatically collects system state information from your devices and uploads it securely to Dell EMC. This information is used by Dell EMC Technical Support to troubleshoot the issue.
- **Proactive contact** — A Dell EMC Technical Support agent contacts you about the support case and helps you resolve the issue.

The available benefits vary depending on the Dell EMC Service entitlement purchased for your device. For more information about SupportAssist, go to www.dell.com/supportassist.

Documentation resources

This section provides information about the documentation resources for your system.

To view the document that is listed in the documentation resources table:

- From the Dell EMC support site:
 1. Click the documentation link that is provided in the Location column in the table.
 2. Click the required product or product version.
-  **NOTE:** To locate the product name and model, see the front of your system.
- 3. On the Product Support page, click **Manuals & documents**.
- Using search engines:
 - Type the name and version of the document in the search box.

Table 17. Documentation resources

Task	Document	Location
Setting up your system	<p>For more information about installing and securing the system into a rack, see the Rail Installation Guide included with your rack solution.</p> <p>For information about setting up your system, see the <i>Getting Started Guide</i> document that is shipped with your system.</p>	https://www.dell.com/poweredgemanuals
Configuring your system	<p>For information about the iDRAC features, configuring and logging in to iDRAC, and managing your system remotely, see the Integrated Dell Remote Access Controller User's Guide.</p> <p>For information about understanding Remote Access Controller Admin (RACADM) subcommands and supported RACADM interfaces, see the RACADM CLI Guide for iDRAC.</p> <p>For information about Redfish and its protocol, supported schema, and Redfish Eventing implemented in iDRAC, see the Redfish API Guide.</p> <p>For information about iDRAC property database group and object descriptions, see the Attribute Registry Guide.</p> <p>For information about Intel QuickAssist Technology, see the Integrated Dell Remote Access Controller User's Guide.</p>	https://www.dell.com/poweredgemanuals
	<p>For information about earlier versions of the iDRAC documents.</p> <p>To identify the version of iDRAC available on your system, on the iDRAC web interface, click ? > About.</p>	https://www.dell.com/idracmanuals
	<p>For information about installing the operating system, see the operating system documentation.</p>	https://www.dell.com/operatingsystemmanuals

Table 17. Documentation resources (continued)

Task	Document	Location
	For information about updating drivers and firmware, see the Methods to download firmware and drivers section in this document.	www.dell.com/support/drivers
Managing your system	For information about system management software offered by Dell, see the Dell OpenManage Systems Management Overview Guide.	https://www.dell.com/poweredgemanuals
	For information about setting up, using, and troubleshooting OpenManage, see the Dell OpenManage Server Administrator User's Guide.	www.dell.com/openmanagemanuals > OpenManage Server Administrator
	For information about installing, using, and troubleshooting Dell OpenManage Enterprise, see the Dell OpenManage Enterprise User's Guide.	https://www.dell.com/openmanagemanuals
	For information about installing and using Dell SupportAssist, see the Dell EMC SupportAssist Enterprise User's Guide.	https://www.dell.com/serviceabilitytools
	For information about partner programs enterprise systems management, see the OpenManage Connections Enterprise Systems Management documents.	https://www.dell.com/openmanagemanuals
Working with the Dell PowerEdge RAID controllers	For information about understanding the features of the Dell PowerEdge RAID controllers (PERC), Software RAID controllers, or BOSS card and deploying the cards, see the Storage controller documentation.	www.dell.com/storagecontrollermanuals
Understanding event and error messages	For information about the event and error messages generated by the system firmware and agents that monitor system components, go to qrl.dell.com > Look Up > Error Code , type the error code, and then click Look it up .	www.dell.com/qrl
Troubleshooting your system	For information about identifying and troubleshooting the PowerEdge server issues, see the Server Troubleshooting Guide.	https://www.dell.com/poweredgemanuals