

Dell EMC PowerEdge T640

Installation and Service Manual

Notes, cautions, and warnings

 **NOTE:** A NOTE indicates important information that helps you make better use of your product.

 **CAUTION:** A CAUTION indicates either potential damage to hardware or loss of data and tells you how to avoid the problem.

 **WARNING:** A WARNING indicates a potential for property damage, personal injury, or death.

Chapter 1: Dell EMC PowerEdge T640 overview.....	7
Supported configurations.....	8
Front view of the system.....	9
Status LED indicators.....	11
iDRAC Direct LED indicator codes.....	12
iDRAC Quick Sync 2 indicator codes.....	13
System health and system ID indicator codes.....	13
Drive indicator codes.....	14
Back view of the system.....	15
NIC indicator codes.....	16
Power supply unit indicator codes.....	17
Locating the Service Tag of your system.....	19
System information label.....	19
Chapter 2: Initial system setup and configuration.....	24
Setting up your system.....	24
iDRAC configuration.....	24
Options to set up iDRAC IP address.....	24
Log in to iDRAC.....	25
Options to install the operating system.....	25
Methods to download firmware and drivers.....	25
Downloading drivers and firmware.....	26
Chapter 3: Installing and removing system components.....	27
Safety instructions.....	27
Before working inside your system.....	28
After working inside your system.....	28
Optional front bezel.....	28
Removing the front bezel.....	28
Installing the front bezel.....	29
System feet.....	30
Removing the system feet.....	30
Installing the system feet.....	31
Caster wheels – optional.....	32
Removing caster wheels.....	32
Installing caster wheels.....	33
Drives.....	34
Removing a drive blank.....	34
Installing a drive blank.....	35
Removing a drive carrier.....	36
Installing a drive carrier.....	37
Removing the drive from the drive carrier.....	38
Installing a drive into the drive carrier.....	38
Removing a 3.5 inch drive adapter from a 3.5 inch drive carrier.....	39

Installing a 3.5 inch drive adapter into the 3.5 inch drive carrier.....	40
Removing a 2.5 inch drive from a 3.5 inch drive adapter.....	41
Installing a 2.5 inch drive into a 3.5 inch drive adapter.....	42
Power supply units.....	43
PSU specifications.....	43
Hot spare feature.....	44
Removing a power supply unit blank.....	44
Installing a power supply unit blank.....	44
Removing a AC power supply unit.....	45
Installing a AC power supply unit.....	46
Removing a DC power supply unit.....	46
Installing DC power supply unit.....	47
Wiring instructions for a DC power supply unit.....	47
System cover.....	48
Removing the system cover.....	48
Installing the system cover.....	49
Inside the system.....	50
Air shroud.....	52
Removing the optional GPU air shrouds.....	52
Installing the optional GPU air shrouds.....	52
Removing the air shroud.....	53
Installing the air shroud.....	54
Cooling fans.....	55
Cooling fan specifications.....	55
Cooling fan matrix.....	56
Removing a middle or rear cooling fan.....	56
Installing a middle or rear cooling fan.....	57
Removing the right external fan.....	58
Installing the right external fan.....	59
Cooling fan (middle fan) assembly.....	60
Removing the middle cooling fan assembly	60
Installing the middle cooling fan assembly.....	60
Flex bays.....	61
Removing a NVMe drive bay or flex bay.....	61
Installing a NVMe drive bay or flex bay.....	62
Optical drives and tape drives.....	63
Optical drives and tape drives specifications.....	63
Removing the optical or tape drive blank.....	63
Installing the optical or tape drive blank.....	64
Removing the optical drive cage or tape drive.....	65
Installing the optical drive cage or tape drive.....	66
Removing the slim optical drive.....	67
Installing the slim optical drive.....	68
NVDIMM-N battery.....	69
Removing the NVDIMM-N battery.....	69
Installing the NVDIMM-N battery.....	70
System memory.....	71
System memory guidelines.....	71
General memory module installation guidelines.....	73
NVDIMM-N memory module installation guidelines	74

Mode-specific guidelines.....	75
Removing a memory module.....	77
Installing a memory module.....	78
Processors and heat sinks.....	79
Removing a processor and heat sink module.....	79
Removing the processor from the processor and heat sink module.....	81
Installing the processor into a processor and heat sink module.....	82
Installing a processor and heat sink module.....	84
Expansion card holder.....	86
Removing the expansion card holder.....	86
Installing the expansion card holder.....	87
GPU card holder (optional).....	87
GPU card restriction.....	87
GPU card installation guidelines.....	88
Removing the optional GPU card holder.....	88
Installing the optional GPU card holder.....	89
Expansion cards.....	90
Expansion card installation guidelines.....	90
Expansion card slot priority.....	91
Removing a expansion card.....	92
Installing an expansion card.....	93
Optional GPU card.....	95
Removing the optional GPU card.....	95
Installing the optional GPU card.....	96
NVLink bridge.....	97
Removing the optional NVLink bridge.....	97
Installing the optional NVLink bridge.....	98
M.2 SSD module.....	99
Removing the M.2 SSD module.....	99
Installing the M.2 SSD module.....	100
Optional MicroSD or vFlash card.....	101
Removing the MicroSD card.....	101
Installing the MicroSD card.....	102
Optional IDSDM or vFlash module.....	103
Removing the optional IDSDM or vFlash module.....	103
Installing optional IDSDM or vFlash module.....	104
Backplane.....	105
Backplane connectors.....	105
Removing a backplane.....	108
Installing a backplane.....	109
Backplane cabling.....	110
Integrated storage controller card.....	116
Removing the integrated storage controller card.....	116
Installing the integrated storage controller card.....	116
System battery.....	117
Replacing the system battery.....	117
Optional internal USB memory key.....	118
Replacing the optional internal USB memory key.....	118
Control panel assembly.....	118
Removing the control panel assembly.....	118

Installing the control panel assembly.....	120
Trusted Platform Module.....	121
Upgrading the Trusted Platform Module.....	121
Initializing TPM for BitLocker users.....	122
Initializing the TPM 1.2 for TXT users.....	122
System board.....	123
Removing the system board.....	123
Installing the system board.....	125
Power interposer boards.....	127
Main and GPU power interposer boards connectors.....	127
Removing the GPU power interposer board.....	128
Installing the GPU power interposer board.....	128
Removing the main power interposer board.....	129
Installing the main power interposer board.....	130
Converting the system from tower mode to rack mode.....	130
Converting the system from tower mode to rack mode	130
Chapter 4: System diagnostics.....	133
Dell Embedded System Diagnostics.....	133
Running the Embedded System Diagnostics from Boot Manager.....	133
Running the Embedded System Diagnostics from the Dell Lifecycle Controller.....	133
System diagnostic controls.....	133
Chapter 5: Getting help.....	135
Contacting Dell EMC.....	135
Documentation feedback.....	135
Accessing system information by using QRL.....	135
Quick Resource Locator for PowerEdge T640.....	136
Receiving automated support with SupportAssist	136
Recycling or End-of-Life service information.....	136

Dell EMC PowerEdge T640 overview

The Dell EMC PowerEdge T640 is a dual-socket, 5U rackable tower server that supports up to:

- Two Intel Xeon Scalable processors
- 24 DIMM slots (support for DDR4 RDIMM, LR-DIMM) or 12 NVDIMM-N (one DIMM per channel) are supported
- Nine PCIe Gen 3 expansion cards, including a dedicated PERC slot
- Four GPUs
- Two hot swappable power supply units
- Drive configurations:
 - 8 x 3.5-inch or 8 x 2.5 inch (in 3.5 inch carrier) SAS/SATA/SSD drives
 - 18 x 3.5-inch SAS/SATA/SSD drives
 - 16 x 2.5-inch SAS/SATA/SSD drives
 - 16 x 2.5-inch SAS/SATA/SSD drives with 8 x NVME drives
 - 32 x 2.5-inch SAS/SATA/SSD drives

For more information, see the Dell EMC PowerEdge T640 Technical Specifications on the product documentation page.

Topics:

- [Supported configurations](#)
- [Front view of the system](#)
- [Back view of the system](#)
- [Locating the Service Tag of your system](#)
- [System information label](#)

Supported configurations

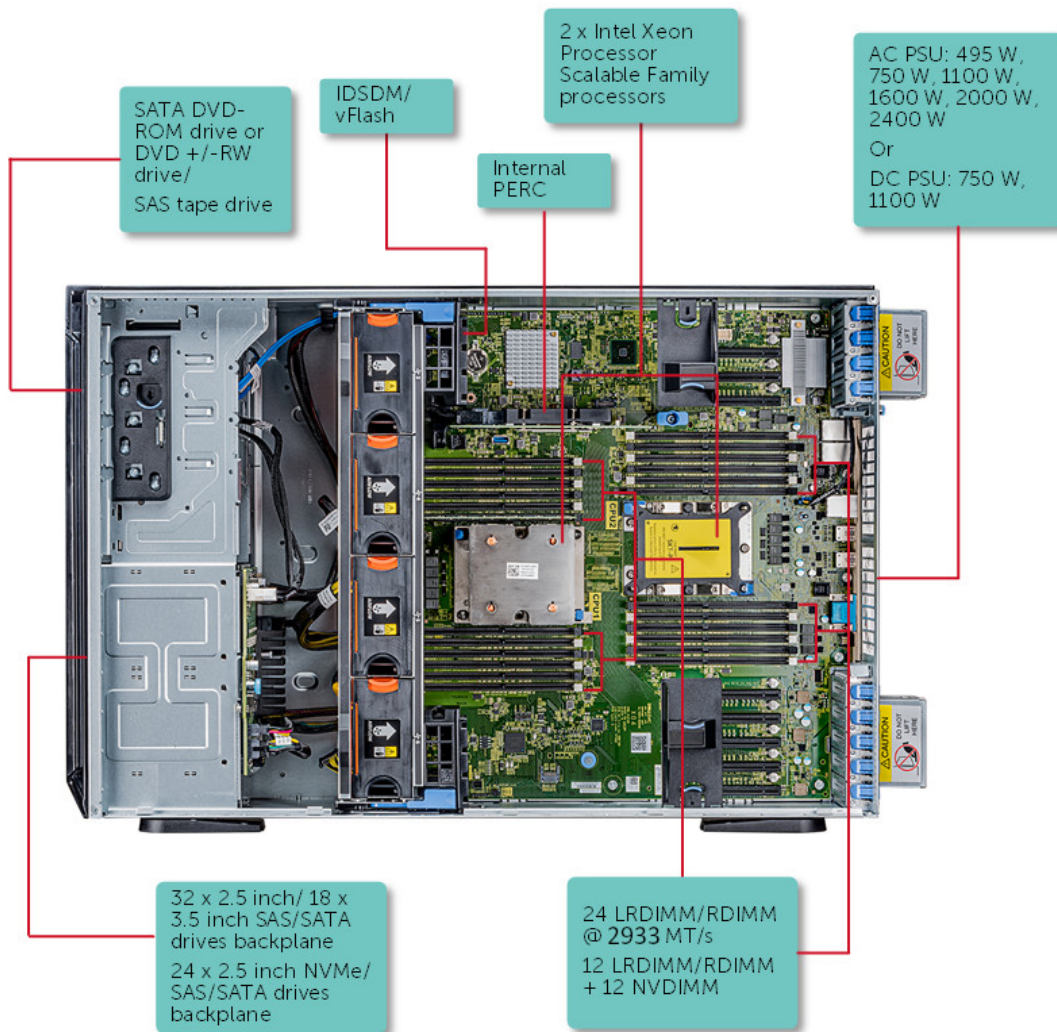

Figure 1. Supported configurations of the PowerEdge T640

Front view of the system

The front view displays the features available on the front of the system.

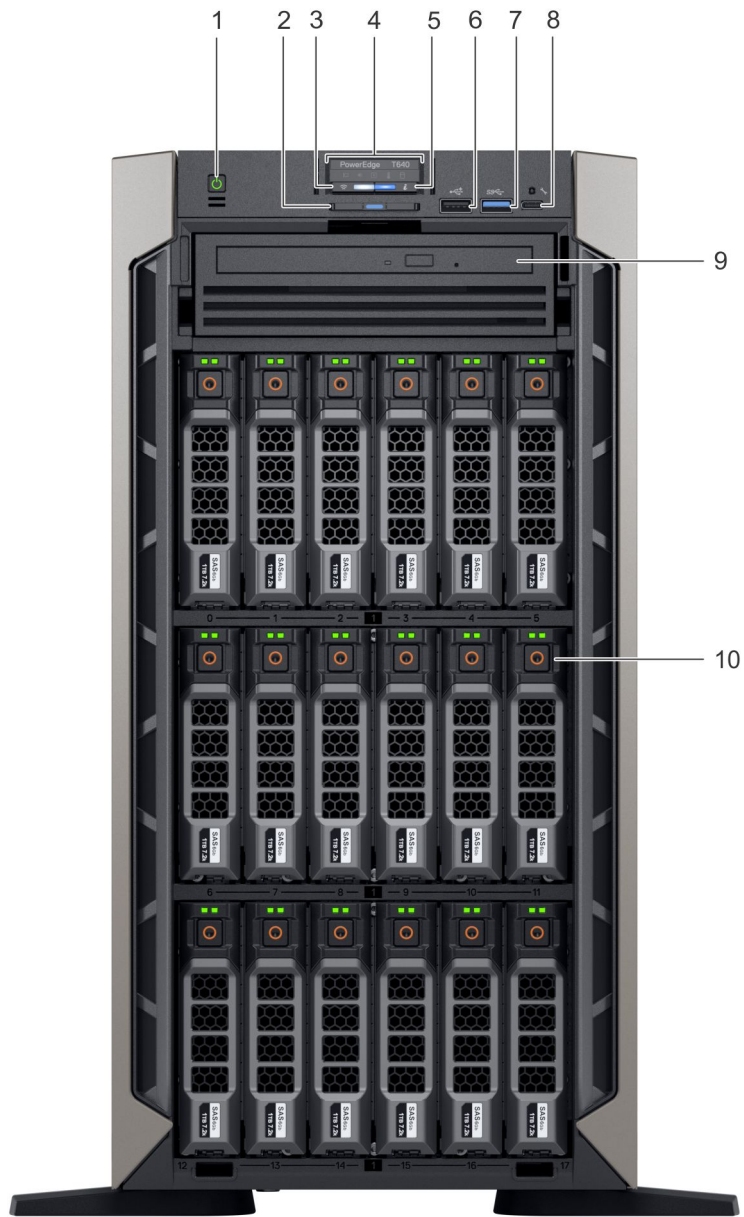

Figure 2. Front view of the 18 x 3.5-inch drive tower system

- | | |
|---|-------------------------------------|
| 1. Power button | 2. Information tag |
| 3. iDRAC Quick Sync 2 wireless indicator (optional) | 4. Status LED indicators |
| 5. System health and system ID indicator | 6. USB port (USB 2.0-compliant) |
| 7. USB port (USB 3.0-compliant) | 8. iDRAC Direct (Micro-AB USB) port |
| 9. Optical drive (optional) | 10. Drive slots |

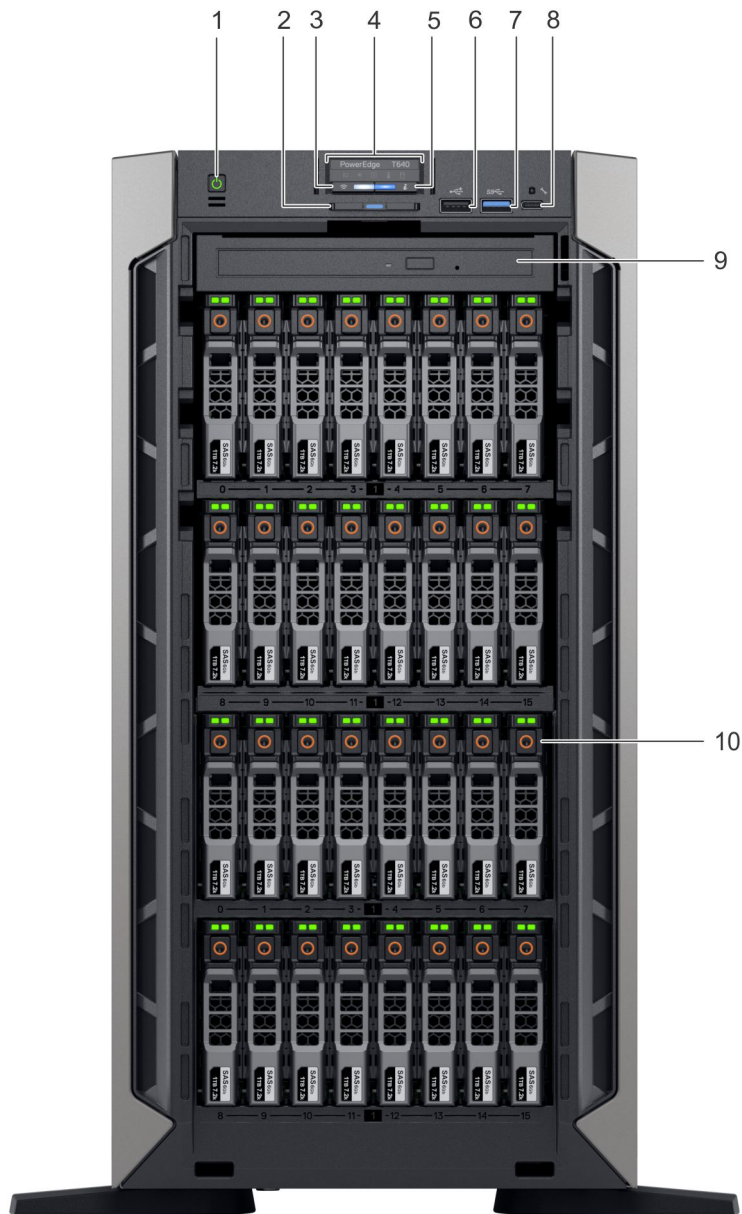

Figure 3. Front view of the 32 x 2.5-inch drive tower system

- | | |
|---|-------------------------------------|
| 1. Power button | 2. Information tag |
| 3. iDRAC Quick Sync 2 wireless indicator (optional) | 4. Status LED indicators |
| 5. System health and system ID indicator | 6. USB port (USB 2.0-compliant) |
| 7. USB port (USB 3.0-compliant) | 8. iDRAC Direct (Micro-AB USB) port |
| 9. Optical drive (optional) | 10. Drive slots |

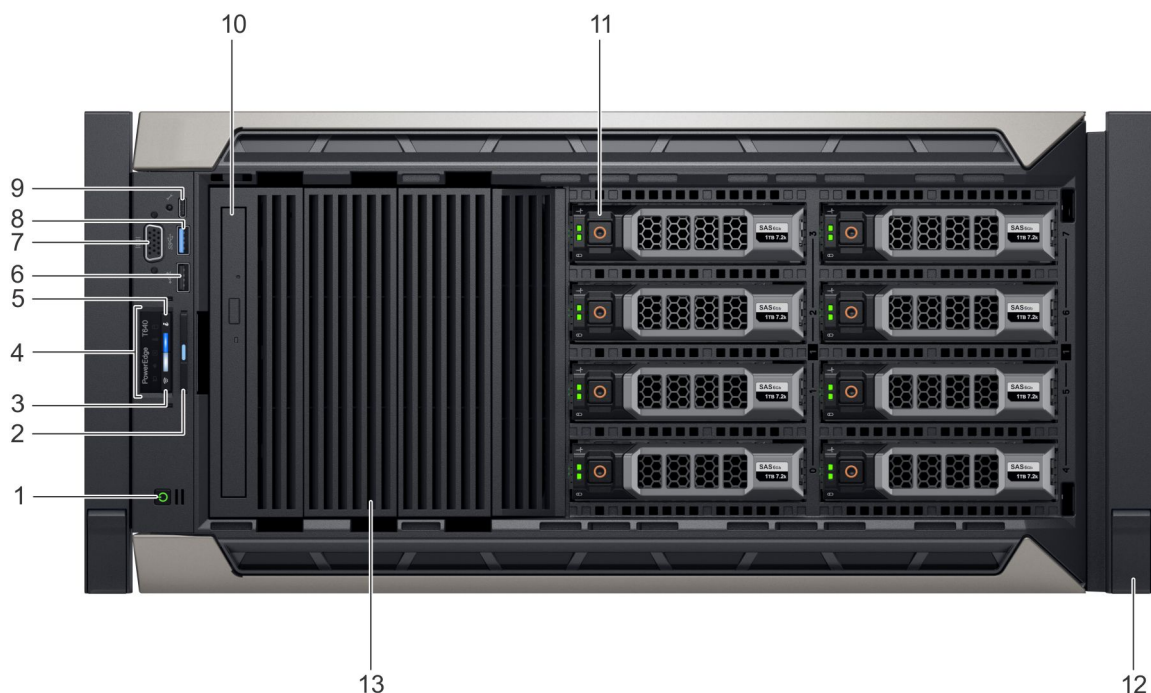

Figure 4. Front view of the 8 x 3.5-inch drive rack system

- | | |
|---|---------------------------------|
| 1. Power button | 2. Information tag |
| 3. iDRAC Quick Sync 2 wireless indicator (optional) | 4. Status LED indicators |
| 5. System health and system ID indicator | 6. USB port (USB 2.0-compliant) |
| 7. VGA port | 8. USB port (USB 3.0-compliant) |
| 9. iDRAC Direct (Micro-AB USB) port | 10. Optical drive (optional) |
| 11. Drive slots | 12. Rack ear latch (2) |
| 13. Drive blank | |

For more information on the ports, see the Technical specifications section.

Status LED indicators

NOTE: The indicators display solid amber if any error occurs.



Figure 5. Status LED indicators

Table 1. Status LED indicators and descriptions





Icon	Description	Condition	Corrective action
	PCIe indicator	The indicator turns solid amber if a PCIe card experiences an error.	Restart the system. Update any required drivers for the PCIe card. Reinstall the card. If the problem persists, see Getting help . NOTE: For more information about the supported PCIe cards, see Expansion card installation guidelines .
	Memory indicator	The indicator turns solid amber if	Check the System Event Log or system messages for the location of the failed memory. Reseat the memory module.

Table 1. Status LED indicators and descriptions (continued)

Icon	Description	Condition	Corrective action
	Electrical indicator	<p>a memory error occurs.</p> <p>The indicator turns solid amber if the system experiences an electrical error (for example, voltage out of range, or a failed power supply unit (PSU) or voltage regulator).</p>	<p>If the problem persists, see Getting help.</p> <p>Check the System Event Log or system messages for the specific issue. If it is due to a problem with the PSU, check the LED on the PSU. Reseat the PSU.</p> <p>If the problem persists, see Getting help.</p>
	Temperature indicator	<p>The indicator turns solid amber if the system experiences a thermal error (for example, the ambient temperature is out of range or there is a fan failure).</p>	<p>Ensure that none of the following conditions exist:</p> <ul style="list-style-type: none"> • A cooling fan has been removed or has failed. • System cover, air shroud, memory module blank, or back filler bracket is removed. • Ambient temperature is too high. • External airflow is obstructed. <p>If the problem persists, see Getting help.</p>
	Drive indicator	<p>The indicator turns solid amber if there is a drive error.</p>	<ul style="list-style-type: none"> • Check the System Event Log to determine if the drive has an error. • Run the appropriate Online Diagnostics test. Restart the system and run embedded diagnostics (ePSA). • If the drives are configured in a RAID array, restart the system, and enter the host adapter configuration utility program.

iDRAC Direct LED indicator codes

The iDRAC Direct LED indicator lights up to indicate that the port is connected and is being used as a part of the iDRAC subsystem.

You can configure iDRAC Direct by using a USB to micro USB (type AB) cable, which you can connect to your laptop or tablet. The following table describes iDRAC Direct activity when the iDRAC Direct port is active:



Table 2. iDRAC Direct LED indicator codes

iDRAC Direct LED indicator code	Condition
Solid green for two seconds	Indicates that the laptop or tablet is connected.
Flashing green (on for two seconds and off for two seconds)	Indicates that the laptop or tablet connected is recognized.
Turns off	Indicates that the laptop or tablet is unplugged.

iDRAC Quick Sync 2 indicator codes

iDRAC Quick Sync 2 module (optional) is located on the front panel of your system.



Figure 6. iDRAC Quick Sync 2 indicator

Table 3. iDRAC Quick Sync 2 indicators and descriptions

iDRAC Quick Sync 2 indicator code	Condition	Corrective action
Off (default state)	Indicates that the iDRAC Quick Sync 2 feature is turned off. Press the iDRAC Quick Sync 2 button to turn on the iDRAC Quick Sync 2 feature.	If the LED fails to turn on, reseal the cable and check. If the problem persists, see the Getting help section.
Solid white	Indicates that iDRAC Quick Sync 2 is ready to communicate. Press the iDRAC Quick Sync 2 button to turn off.	If the LED fails to turn off, restart the system. If the problem persists, see the Getting help section.
Blinks white rapidly	Indicates data transfer activity.	If the indicator continues to blink indefinitely, see the Getting help section.
Blinks white slowly	Indicates that firmware update is in progress.	If the indicator continues to blink indefinitely, see the Getting help section.
Blinks white five times rapidly and then turns off	Indicates that the iDRAC Quick Sync 2 feature is disabled.	Check if iDRAC Quick Sync 2 feature is configured to be disabled by iDRAC. If the problem persists, see the Getting help section. For more information, see www.dell.com/idracmanuals www.dell.com/operatingsystemmanuals .
Solid amber	Indicates that the system is in fail-safe mode.	Restart the system. If the problem persists, see the Getting help section.
Blinking amber	Indicates that the iDRAC Quick Sync 2 hardware is not responding properly.	Restart the system. If the problem persists, see the Getting help section.

System health and system ID indicator codes

The system health and system ID indicator is located on the front panel of your system.



Figure 7. System health and system ID indicators

Table 4. System health and system ID indicator codes

System health and system ID indicator code	Condition
Solid blue	Indicates that the system is turned on, system is healthy, and system ID mode is not active. Press the system health and system ID button to switch to system ID mode.
Blinking blue	Indicates that the system ID mode is active. Press the system health and system ID button to switch to system health mode.
Solid amber	Indicates that the system is in fail-safe mode. If the problem persists, see the Getting help section.
Blinking amber	Indicates that the system is experiencing a fault. Check the System Event Log for specific error messages. For information

Table 4. System health and system ID indicator codes (continued)

System health and system ID indicator code	Condition
	about the event and error messages generated by the system firmware and agents that monitor system components, go to qrl.dell.com > Look Up > Error Code , type the error code, and then click Look it up .

Drive indicator codes

Each drive carrier has an activity LED indicator and a status LED indicator. The indicators provide information about the current status of the drive. The activity LED indicator indicates whether the drive is currently in use or not. The status LED indicator indicates the power condition of the drive.

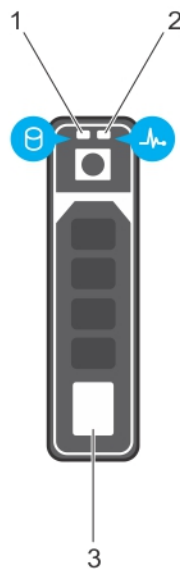

Figure 8. Drive indicators

1. Drive activity LED indicator
2. Drive status LED indicator
3. Drive capacity label

NOTE: If the drive is in the Advanced Host Controller Interface (AHCI) mode, the status LED indicator does not turn on.

Table 5. Drive indicator codes

Drive status indicator code	Condition
Flashes green twice per second	Identifying drive or preparing for removal.
Off	Drive ready for removal. NOTE: The drive status indicator remains off until all drives are initialized after the system is turned on. Drives are not ready for removal during this time.
Flashes green, amber, and then turns off	Predicted drive failure.
Flashes amber four times per second	Drive failed.
Flashes green slowly	Drive rebuilding.
Solid green	Drive online.
Flashes green for three seconds, amber for three seconds, and then turns off after six seconds	Rebuild stopped.

Back view of the system

The back view displays the features available on the back of the system.

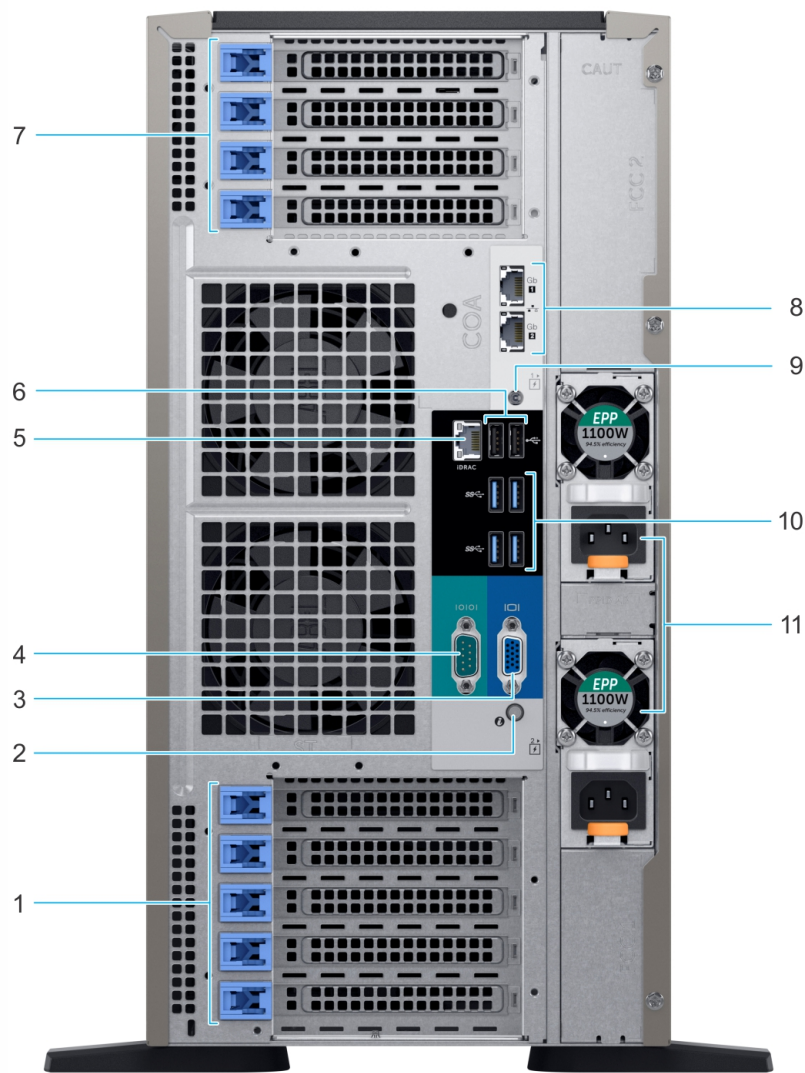

Figure 9. Back view of the tower configuration

- 1. PCIe expansion card slots
- 2. System ID button/indicator
- 3. VGA port
- 4. Serial port
- 5. iDRAC9 dedicated network port
- 6. USB 2.0 port (2)
- 7. PCIe expansion card slots
- 8. NIC port (2)
- 9. System Identification connector
- 10. USB 3.0 port (4)
- 11. Power supply unit (2)

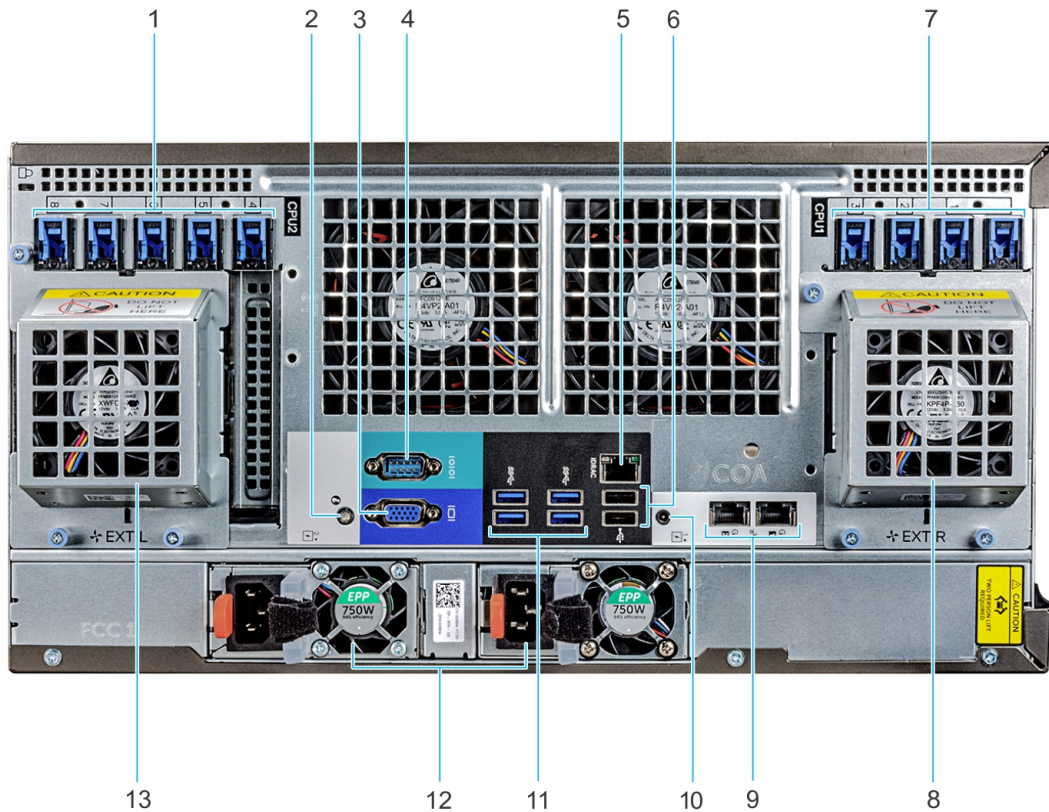

Figure 10. Back view of the rack configuration

- | | |
|---|---|
| 1. PCIe expansion card slots | 2. System ID button/indicator |
| 3. VGA port | 4. Serial port |
| 5. iDRAC9 dedicated network port | 6. USB 2.0 port (2) |
| 7. PCIe expansion card slots | 8. Right external fan (available only with GPGPU configuration) |
| 9. NIC port (2) | 10. System Identification connector |
| 11. USB 3.0 port (4) | 12. Power supply unit (2) |
| 13. Left external fan (available only with GPGPU configuration) | |

For more information, see the Dell EMC PowerEdge T640 Technical Specifications on the product documentation page.

NIC indicator codes

Each NIC on the back of the system has indicators that provide information about the activity and link status. The activity LED indicator indicates if data is flowing through the NIC, and the link LED indicator indicates the speed of the connected network.

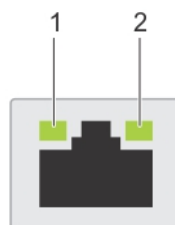

Figure 11. NIC indicator codes

1. link LED indicator
2. activity LED indicator

Table 6. NIC indicator codes

Status	Condition
Link and activity indicators are off	The NIC is not connected to the network.
Link indicator is green and activity indicator is blinking green	The NIC is connected to a valid network at its maximum port speed and data is being sent or received.
Link indicator is amber and activity indicator is blinking green	The NIC is connected to a valid network at less than its maximum port speed and data is being sent or received.
Link indicator is green and activity indicator is off	The NIC is connected to a valid network at its maximum port speed and data is not being sent or received.
Link indicator is amber and activity indicator is off	The NIC is connected to a valid network at less than its maximum port speed and data is not being sent or received.
Link indicator is blinking green and activity is off	NIC identify is enabled through the NIC configuration utility.

NOTE: The LOM (Broadcom 57416) is compatible with 10GBASE-T IEEE 802.3an and 1000 BASE-T IEEE 802.3ab.

Power supply unit indicator codes

AC power supply units (PSUs) have an illuminated translucent handle that serves as an indicator.

The DC PSUs have an LED that serves as an indicator.

The indicator shows whether power is present or if a power fault has occurred.

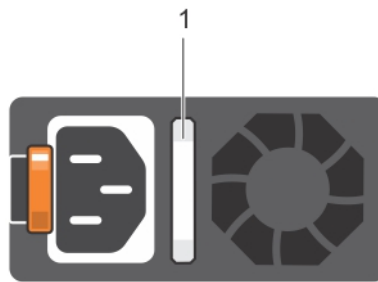

Figure 12. AC PSU status indicator

1. AC PSU status indicator/handle

Table 7. AC PSU status indicator codes

Power indicator codes	Condition
Green	A valid power source is connected to the PSU and the PSU is operational.
Blinking amber	Indicates a problem with the PSU.
Not illuminated	Power is not connected to the PSU.
Blinking green	When the firmware of the PSU is being updated, the PSU handle blinks green. CAUTION: Do not disconnect the power cord or unplug the PSU when updating firmware. If firmware update is interrupted, the PSUs do not function.
Blinking green and turns off	When hot-plugging a PSU, the PSU handle blinks green five times at a rate of 4 Hz and turns off. This indicates a PSU mismatch with respect to efficiency, feature set, health status, or supported voltage. CAUTION: If two PSUs are installed, both the PSUs must have the same type of label; for example, Extended Power Performance (EPP) label. Mixing PSUs from previous generations of PowerEdge servers is not supported, even if the PSUs have the same power rating. This results in a PSU mismatch condition or failure to turn the system on.

Table 7. AC PSU status indicator codes (continued)

Power indicator codes	Condition
	<p>⚠ CAUTION: When correcting a PSU mismatch, replace only the PSU with the blinking indicator. Swapping the PSU to make a matched pair can result in an error condition and unexpected system shutdown. To change from a high output configuration to a low output configuration or vice versa, you must turn off the system.</p> <p>⚠ CAUTION: AC PSUs support both 240 V and 120 V input voltages with the exception of Titanium PSUs, which support only 240 V. When two identical PSUs receive different input voltages, they can output different wattages, and trigger a mismatch.</p> <p>⚠ CAUTION: If two PSUs are used, they must be of the same type and have the same maximum output power.</p> <p>⚠ CAUTION: Combining AC and DC PSUs is not supported and triggers a mismatch.</p>

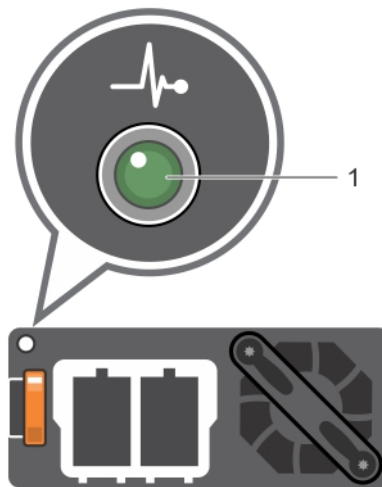

Figure 13. DC PSU status indicator

1. DC PSU status indicator

Table 8. DC PSU status indicator codes

Power indicator codes	Condition
Green	A valid power source is connected to the PSU and the PSU is operational.
Blinking amber	Indicates a problem with the PSU.
Not illuminated	Power is not connected to the PSU.
Blinking green	<p>When hot-plugging a PSU, the PSU indicator blinks green. This indicates that there is a PSU mismatch with respect to efficiency, feature set, health status, or supported voltage.</p> <p>⚠ CAUTION: If two PSUs are installed, both the PSUs must have the same type of label; for example, Extended Power Performance (EPP) label. Mixing PSUs from previous generations of PowerEdge servers is not supported, even if the PSUs have the same power rating. This results in a PSU mismatch condition or failure to turn the system on.</p> <p>⚠ CAUTION: When correcting a PSU mismatch, replace only the PSU with the blinking indicator. Swapping the PSU to make a matched pair can result in an error condition and unexpected system shutdown. To change from a High Output configuration to a Low Output configuration or vice versa, you must turn off the system.</p> <p>⚠ CAUTION: If two PSUs are used, they must be of the same type and have the same maximum output power.</p>

Table 8. DC PSU status indicator codes (continued)

Power indicator codes	Condition
	CAUTION: Combining AC and DC PSUs is not supported and triggers a mismatch.

Locating the Service Tag of your system

You can identify your system using the unique Express Service Code and Service Tag. Pull out the information tag in front of the system to view the Express Service Code and Service Tag. Alternatively, the information may be on a sticker on the chassis of the system. The mini Enterprise Service Tag (EST) is found on the back of the system. This information is used by Dell to route support calls to the appropriate personnel.

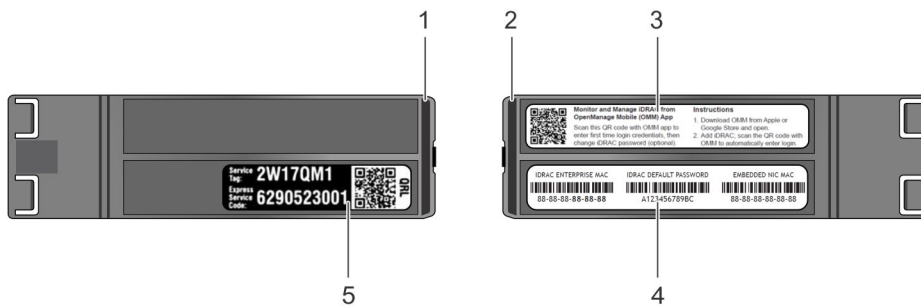

Figure 14. Locating Service Tag of your system

1. information tag (top view)
2. information tag (back view)
3. OpenManage Mobile (OMM) label
4. iDRAC MAC address and iDRAC secure password label
5. Service Tag

System information label

PowerEdge T640 – system information label

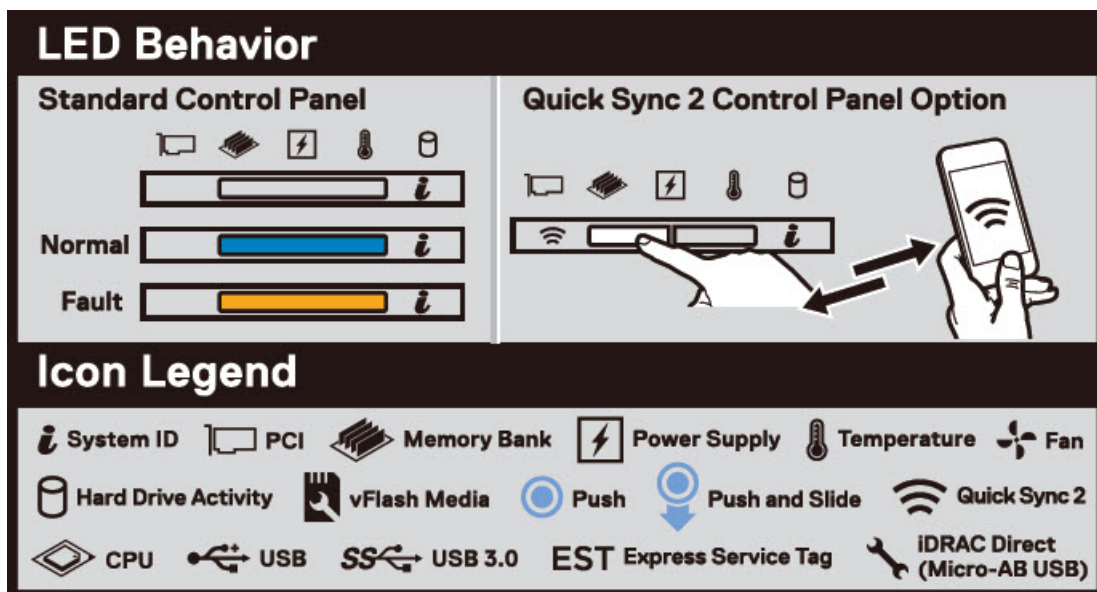

Figure 15. LED behavior

Service Information

System Touch Points

- **Hot swap touchpoints:** Components with terracotta touchpoints can be serviced while the system is running.
- **Cold swap touchpoints:** Components with blue touchpoints require a full system shutdown before servicing.

Mechanical Overviews

Rear View

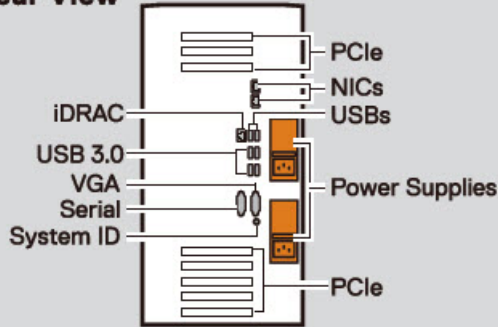

Rack Mode

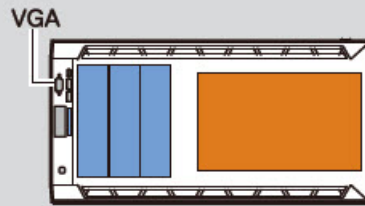

Front View

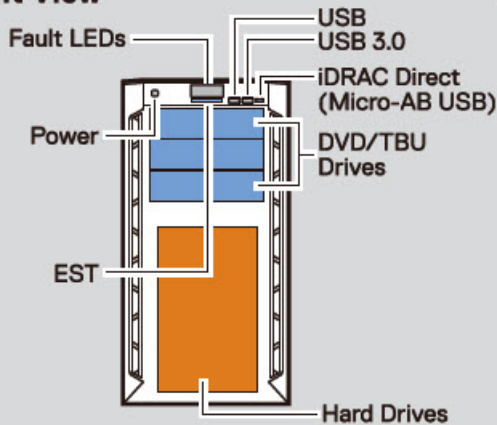

Side View

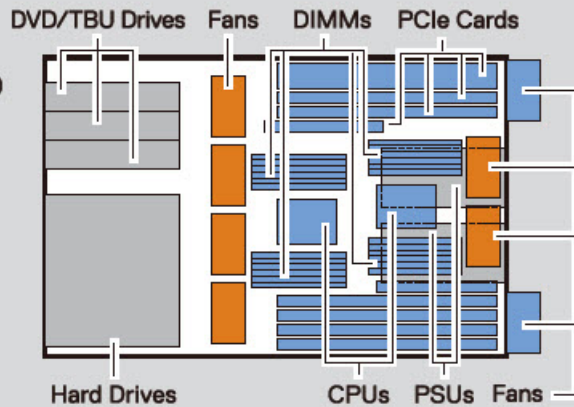

3.5" CONFIG

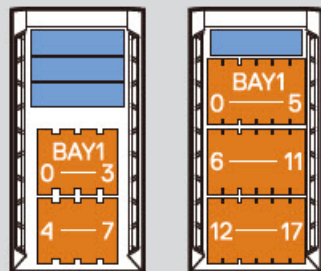

2.5" CONFIG

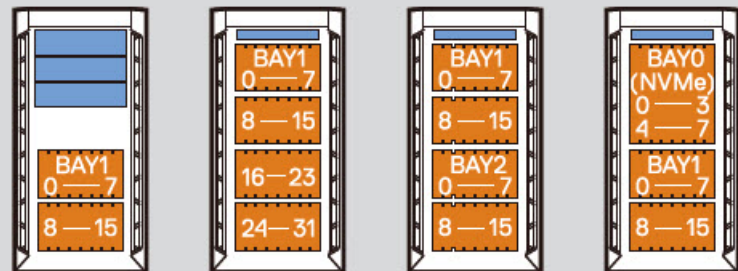

Figure 16. Configuration and layout

Service Information

Electrical Overview

System Board Information

- | | | |
|--------------------------------|---|---------------------------------|
| 1 SATA B | 13 Fan2 | 24 PIB Signals |
| 2 SATA A | 14 PCIe Card Slot (CPU2) | 25 Fan6 |
| 3 IDSDM+vFlash | 15 DIMMs For CPU2 Channels 0&1&2 | 26 PWR_CONN_1 |
| 4 CDROM | 16 CPU2 | 27 BP_SIG2 |
| 5 Battery | 17 DIMMs For CPU2 Channels 3&4&5 | 28 Fan5 |
| 6 TBU | 18 DIMMs For CPU1 Channels 3&4&5 | 29 PWR_CONN_2 |
| 7 Intrusion | 19 CPU1 | 30 BP_SIG1 |
| 8 Internal USB | 20 DIMMs For CPU1 Channels 0&1&2 | 31 Fan4 |
| 9 PCIe Card Slot (CPU1) | 21 TPM Socket | 32 BP_SIG0 |
| 10 PERC | 22 PWRD_EN&NVRAM_CLR | 33 BAT PWR |
| 11 Fan1 | 23 Fan Ext L | 34 Front VGA |
| 12 Fan Ext R | | 35 Front USB |
| | | 36 Control Panel Signals |
| | | 37 Fan3 |
| | | 38 BAT SIG |

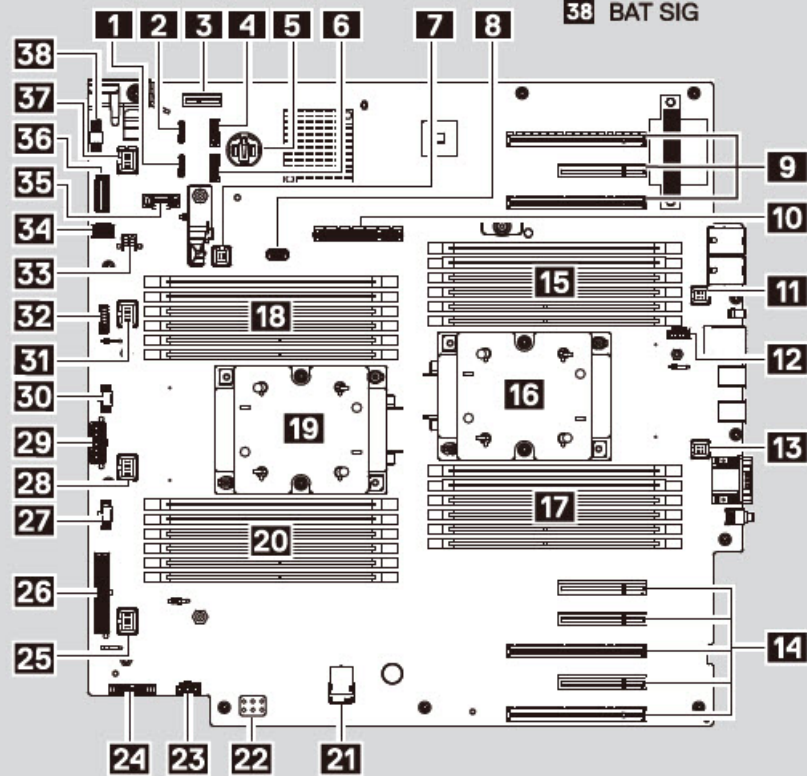

Jumper Settings





Jumper	Setting	Description
 PWRD_EN	 (default)	BIOS configuration settings retained at system boot.
		BIOS configuration settings cleared at system boot.
	 (default)	BIOS password is enabled.
		BIOS password is disabled. iDRAC local access is unlocked at next AC power cycle.

Figure 17. Electrical overview

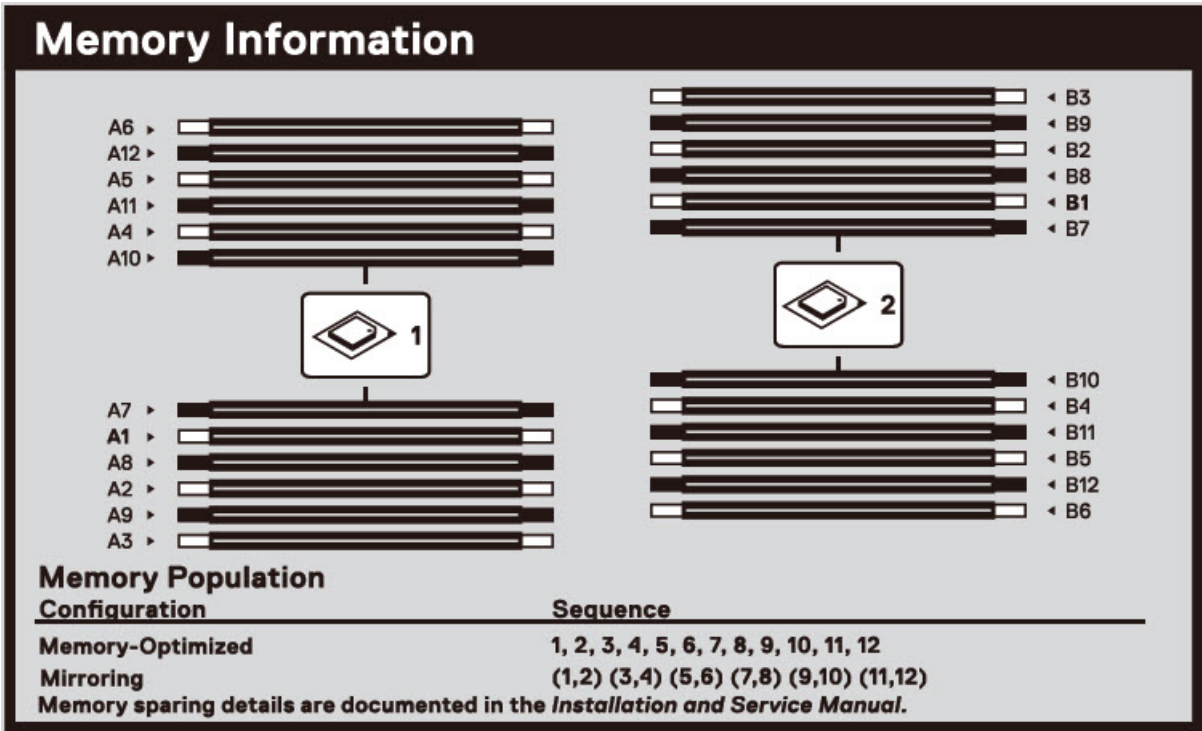

Figure 18. Memory information

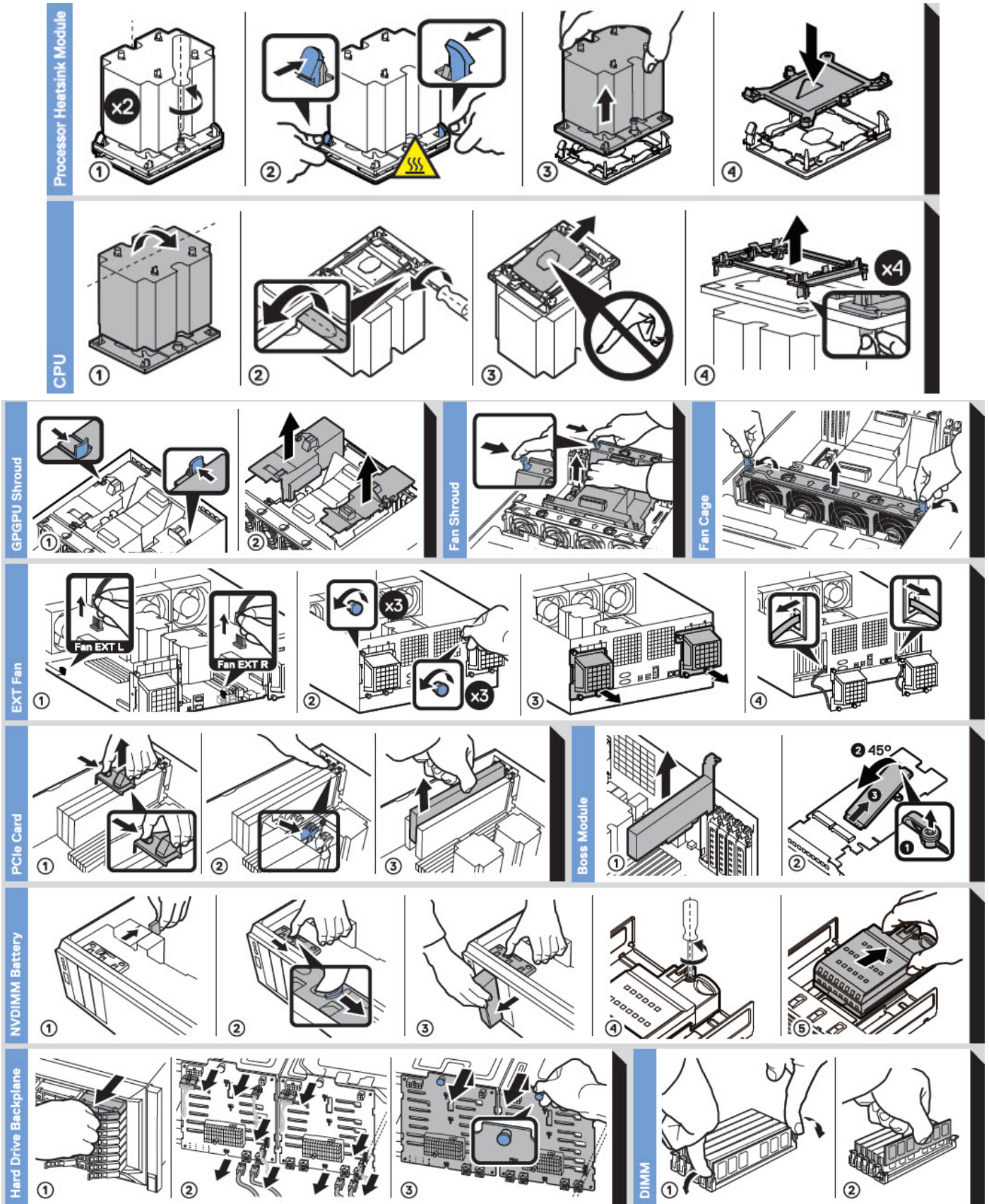

Figure 19. System tasks

Initial system setup and configuration

Topics:

- [Setting up your system](#)
- [iDRAC configuration](#)
- [Options to install the operating system](#)

Setting up your system

Perform the following steps to set up your system:

Steps

1. Unpack the system.
2. Install the system into the rack. For more information about installing the system into the rack, see the *Rail Installation Guide* at www.dell.com/poweredgemanuals.
3. Connect the peripherals to the system.
4. Connect the system to its electrical outlet.
5. Power on the system by pressing the power button or by using iDRAC.
6. Power on the attached peripherals.

For more information about setting up your system, see the *Getting Started Guide* that shipped with your system.

For information on how to manage basic settings and features of the system, see the Dell EMC PowerEdge T640 BIOS and UEFI Reference Guide on the product documentation page.

iDRAC configuration

The Integrated Dell Remote Access Controller (iDRAC) is designed to make system administrators more productive and improve the overall availability of Dell systems. iDRAC alerts administrators about system issues and enables them to perform remote system management. This reduces the need for physical access to the system.

Options to set up iDRAC IP address

To enable communication between your system and iDRAC, you must first configure the network settings based on your network infrastructure.

 **NOTE:** For static IP configuration, you must request for it at the time of purchase.

This option is set to **DHCP** by Default. You can set up the IP address by using one of the following interfaces:

Interfaces	Document/Section
iDRAC Settings utility	<i>Dell Integrated Dell Remote Access Controller User's Guide</i> at www.dell.com/poweredgemanuals
Dell Deployment Toolkit	<i>Dell Deployment Toolkit User's Guide</i> at www.dell.com/openmanagemanuals > OpenManage Deployment Toolkit
Dell Lifecycle Controller	<i>Dell Lifecycle Controller User's Guide</i> at www.dell.com/poweredgemanuals

Interfaces Document/Section

iDRAC Direct and Quick Sync 2 (optional) See *Dell Integrated Dell Remote Access Controller User's Guide* at www.dell.com/poweredge manuals

NOTE: To access iDRAC, ensure that you connect the ethernet cable to the iDRAC9 dedicated network port. You can also access iDRAC through the shared LOM mode, if you have opted for a system that has the shared LOM mode enabled.

Log in to iDRAC

You can log in to iDRAC as:

- iDRAC user
- Microsoft Active Directory user
- Lightweight Directory Access Protocol (LDAP) user

If you have opted for secure default access to iDRAC, you must use the iDRAC secure default password available on the system Information tag. If you have not opted for secure default access to iDRAC, then use the default user name and password `-root` and `calvin`. You can also log in by using your Single Sign-On or Smart Card.

NOTE: You must have the iDRAC credentials to log in to iDRAC.

NOTE: Ensure that you change the default username and password after setting up the iDRAC IP address.

For more information about logging in to the iDRAC and iDRAC licenses, see the latest *Integrated Dell Remote Access Controller User's Guide* at www.dell.com/poweredge manuals.

You can also access iDRAC by using RACADM. For more information, see the *RACADM Command Line Interface Reference Guide* at www.dell.com/poweredge manuals.

Options to install the operating system

If the system is shipped without an operating system, install a supported operating system by using one of the following resources:

Table 9. Resources to install the operating system

Resources	Location
iDRAC	www.dell.com/idrac manuals
Lifecycle Controller	www.dell.com/idrac manuals > Lifecycle Controller
OpenManage Deployment Toolkit	www.dell.com/openmanage manuals > OpenManage Deployment Toolkit
Dell certified VMware ESXi	www.dell.com/virtualizationsolutions
Installation and How-to videos for supported operating systems on PowerEdge systems	Supported Operating Systems for Dell EMC PowerEdge systems

Methods to download firmware and drivers

You can download the firmware and drivers by using any of the following methods:

Table 10. Firmware and drivers

Methods	Location
From the Dell EMC support site	www.dell.com/support/home
Using Dell Remote Access Controller Lifecycle Controller (iDRAC with LC)	www.dell.com/idrac manuals

Table 10. Firmware and drivers (continued)

Methods	Location
Using Dell Repository Manager (DRM)	www.dell.com/openmanagemanuals > Repository Manager
Using Dell OpenManage Essentials	www.dell.com/openmanagemanuals > OpenManage Essentials
Using Dell OpenManage Enterprise	www.dell.com/openmanagemanuals > OpenManage Enterprise
Using Dell Server Update Utility (SUU)	www.dell.com/openmanagemanuals > Server Update Utility
Using Dell OpenManage Deployment Toolkit (DTK)	www.dell.com/openmanagemanuals > OpenManage Deployment Toolkit
Using iDRAC virtual media	www.dell.com/idracmanuals

Downloading drivers and firmware

Dell EMC recommends that you download and install the latest BIOS, drivers, and systems management firmware on your system.

Prerequisites

Ensure that you clear the web browser cache before downloading the drivers and firmware.

Steps

1. Go to www.dell.com/support/home.
2. In the **Drivers & Downloads** section, type the Service Tag of your system in the **Enter a Service Tag or product ID** box, and then click **Submit**.
 **NOTE:** If you do not have the Service Tag, select **Detect Product** to allow the system to automatically detect the Service Tag, or click **View products**, and navigate to your product.
3. Click **Drivers & Downloads**.
The drivers that are applicable to your system are displayed.
4. Download the drivers to a USB drive, CD, or DVD.

Installing and removing system components

The following sections contain the procedures for removing and replacing system components.

Topics:

- Safety instructions
- Before working inside your system
- After working inside your system
- Optional front bezel
- System feet
- Caster wheels – optional
- Drives
- Power supply units
- System cover
- Inside the system
- Air shroud
- Cooling fans
- Cooling fan (middle fan) assembly
- Flex bays
- Optical drives and tape drives
- NVDIMM-N battery
- System memory
- Processors and heat sinks
- Expansion card holder
- GPU card holder (optional)
- Expansion cards
- Optional GPU card
- NVLink bridge
- M.2 SSD module
- Optional MicroSD or vFlash card
- Optional IDSDM or vFlash module
- Backplane
- Backplane cabling
- Integrated storage controller card
- System battery
- Optional internal USB memory key
- Control panel assembly
- Trusted Platform Module
- System board
- Power interposer boards
- Converting the system from tower mode to rack mode

Safety instructions

 **NOTE:** Whenever you need to lift the system, get others to assist you. To avoid injury, do not attempt to lift the system by yourself.

 **WARNING:** Opening or removing the system cover while the system is powered on may expose you to a risk of electric shock.

CAUTION: Do not operate the system without the cover for a duration exceeding five minutes. Operating the system without the system cover can result in component damage.

CAUTION: Many repairs may only be done by a certified service technician. You should only perform troubleshooting and simple repairs as authorized in your product documentation, or as directed by the online or telephone service and support team. Damage due to servicing that is not authorized by Dell is not covered by your warranty. Read and follow the safety instructions that are shipped with your product.

NOTE: It is recommended that you always use an antistatic mat and antistatic strap while working on components inside the system.

CAUTION: To ensure proper operation and cooling, all bays in the system and system fans must be always populated with a component or a blank.

Before working inside your system

Prerequisites

Follow the safety guidelines listed in [Safety instructions](#) on page 27.

Steps

1. Turn off the system, including all attached peripherals.
2. Disconnect the system from the electrical outlet and disconnect the peripherals.
3. Lay the system on its side.
4. Remove the system cover.

After working inside your system

Prerequisites

Follow the safety guidelines listed in [Safety instructions](#) on page 27.

Steps

1. Place the system upright on a flat, stable surface.
2. Reconnect the peripherals and connect the system to the electrical outlet.
3. Turn on the attached peripherals and then turn on the system.

Optional front bezel

Removing the front bezel

Prerequisites

Follow the safety guidelines listed in [Safety instructions](#) on page 27.

Steps

1. Unlock the bezel.
2. Press the blue release latch at the top of the bezel to release the bezel from the system.
3. Pull the top end of the bezel away from the system.
4. Unhook the bezel tabs from the slots at the bottom of the system, and lift the bezel away.

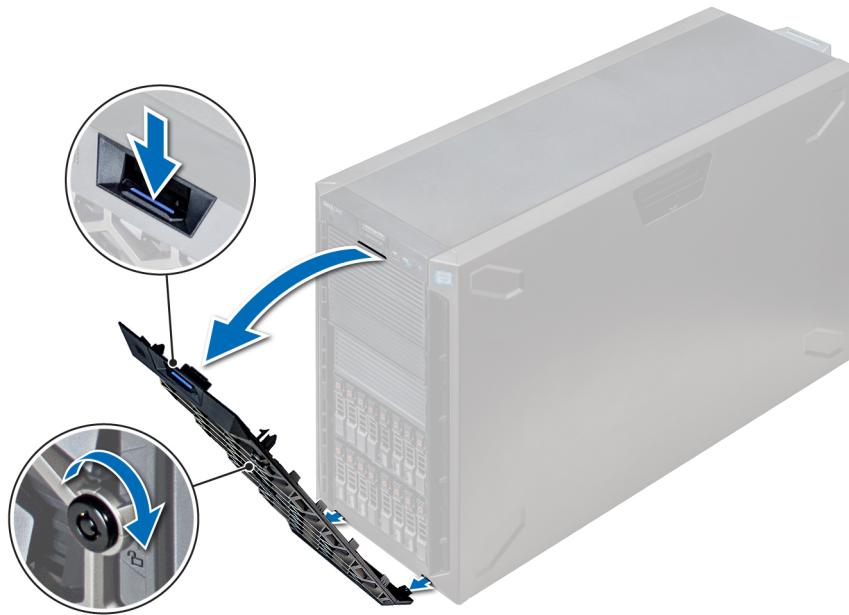

Figure 20. Removing the front bezel

Next steps

1. [Installing the front bezel.](#)

Installing the front bezel

Prerequisites

Follow the safety guidelines listed in [Safety instructions](#) on page 27.

Steps

1. Locate and remove the bezel key.

i **NOTE:** There are two bezel keys attached to the back of the bezel.

2. Insert the bezel tabs into the slots in the chassis.
3. Press the release latch, and push the bezel toward the system until the bezel locks into place.
4. Using the key lock the bezel.

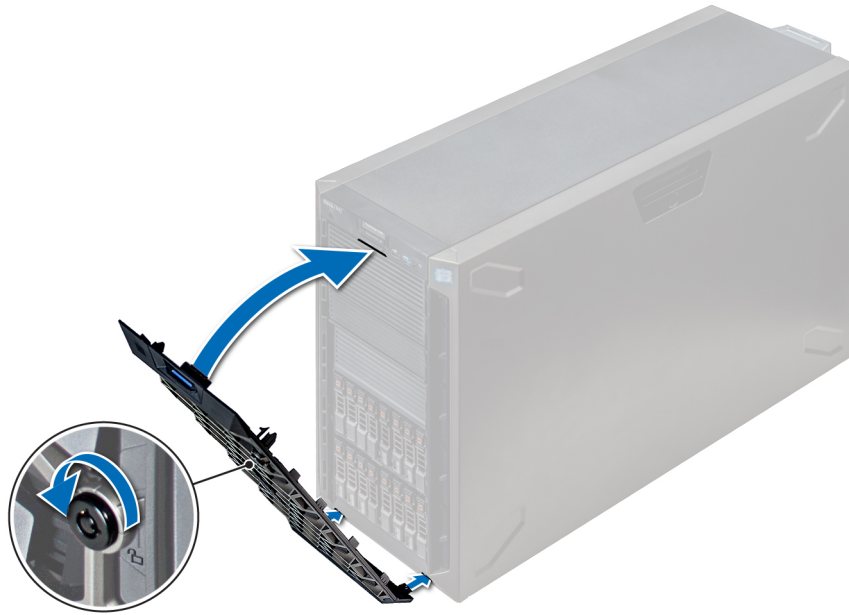

Figure 21. Installing the front bezel

System feet

Removing the system feet

Prerequisites

i **NOTE:** It is recommended that you remove the system feet only when you are converting the system from the tower mode to the rack mode, or when you are replacing the system feet with the wheel assembly.

1. Follow the safety guidelines listed in [Safety instructions](#) on page 27.
2. Place the system on its side on a flat, stable surface.
3. Rotate the system feet inward.

Steps

Using the Phillips #2 screwdriver, remove the screw that secures the foot to the base of the system.

- a. Repeat the above step for the 3 remaining feet.



Figure 22. Removing the system feet

Next steps

1. [Install the system feet](#) or [install the castor wheels](#).

Installing the system feet

Prerequisites

CAUTION: Install the feet on a stand-alone tower system to provide stability to the system. An unstable system might tip over and cause injury to the user or damage to the system.

1. Follow the safety guidelines listed in [Safety instructions](#) on page 27.
2. Place the system on its side, on a flat, stable surface.

Steps

1. Align the three tabs on the system foot with the three slots on the base of the system.
2. Using the Phillips #2 screwdriver, secure the screw that secures the foot to the base of the system.
 - a. Repeat the above steps to install the remaining system feet.



Figure 23. Installing the system feet

Next steps

1. Place the system upright on a flat, stable surface, and rotate the system feet outward.
2. Follow the procedure listed in [After working inside your system](#) on page 28.

Caster wheels – optional

Removing caster wheels

Prerequisites

1. Follow the safety guidelines listed in [Safety instructions](#) on page 27.
2. Place the system on a flat, stable surface.

Steps

1. Using the Phillips #2 screwdriver, loosen the captive screw that secures the front wheel unit to the base of the system.
2. Push the front wheel unit toward the rear of the system to release the retention hooks, and pull out the front wheel unit.
3. Loosen the screw that secures the back wheel unit to the base of the chassis.
4. Push the rear wheel unit toward the front of the system to release the retention hooks, and pull out the rear wheel unit.



Figure 24. Removing caster wheels

Next steps

1. [Install the caster wheels](#) or [the system feet](#), as applicable.

Installing caster wheels

Prerequisites

1. Follow the safety guidelines listed in [Safety instructions](#) on page 27.
2. Place the system on its side on a flat, stable surface.
3. If installed, [remove the system feet](#).

Steps

1. Align the two retention hooks on the rear wheel unit with the two slots on the base of the system, and insert the hooks into the slots.
2. Push the rear wheel unit toward the back of the system and using a Phillips #2 screwdriver secure the unit in place using a single screw.
3. Align the two retention hooks on the front wheel unit with the two slots on the base of the system, and insert the hooks into the slots.
4. Push the front wheel unit toward the front of the system and using a Phillips #2 screwdriver secure the unit in place using a single screw.



Figure 25. Installing caster wheels

Next steps

1. Follow the procedure listed in [Before working inside your system](#) on page 28.

Drives

Removing a drive blank

The procedure for removing 2.5 inch and 3.5 inch drive blanks is identical.

Prerequisites

1. Follow the safety guidelines listed in [Safety instructions](#) on page 27.
2. If installed, [remove the front bezel](#).

⚠ CAUTION: To maintain proper system cooling, drive blanks must be installed in all empty drive slots.

⚠ CAUTION: Mixing drive blanks from previous generations of PowerEdge servers is not supported.

Steps

Press the release button, and slide the drive blank out of the drive slot.

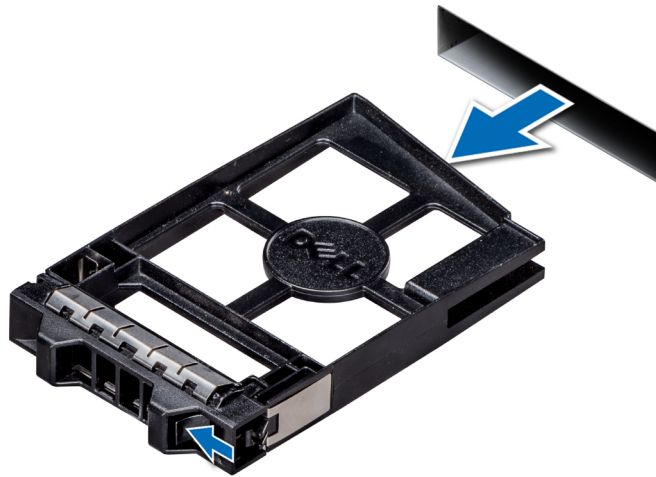

Figure 26. Removing a drive blank

Next steps

1. [Install a drive or drive blank.](#)

Installing a drive blank

The procedure for installing 2.5 inch and 3.5 inch drive blanks is identical.

Prerequisites

1. Follow the safety guidelines listed in [Safety instructions](#) on page 27.
2. If installed, [remove the front bezel.](#)

CAUTION: Mixing drive blanks from previous generations of PowerEdge servers is not supported.

Steps

Insert the drive blank into the drive slot, and push the blank until the release button clicks into place.

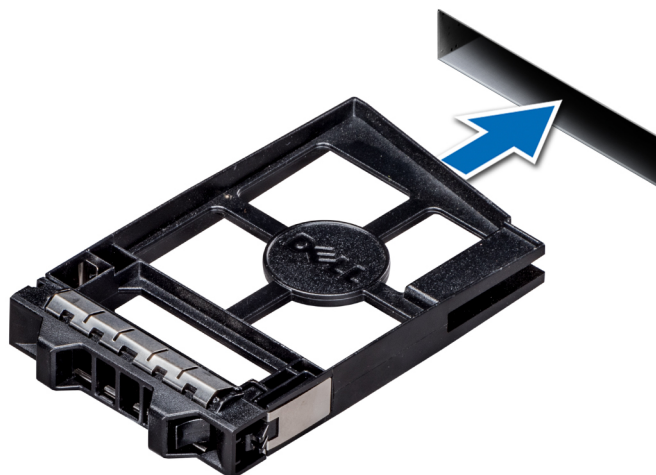

Figure 27. Installing a drive blank

Next steps

If removed, [install the front bezel](#).

Removing a drive carrier

Prerequisites

1. Follow the safety guidelines listed in [Safety instructions](#) on page 27.
2. If applicable, [remove the front bezel](#)
3. Using the management software, prepare the drive for removal.

If the drive is online, the green activity or fault indicator flashes while the drive is turning off. When the drive indicators are off, the drive is ready for removal. For more information, see the documentation for the storage controller.

CAUTION: Before attempting to remove or install a drive while the system is running, see the documentation for the storage controller card to ensure that the host adapter is configured correctly to support drive removal and insertion.

CAUTION: Mixing drives from previous generations of PowerEdge servers is not supported.

CAUTION: To prevent data loss, ensure that your operating system supports drive installation. See the documentation supplied with your operating system.

Steps

1. Press the release button to open the drive carrier release handle.
2. Holding the handle, slide the drive carrier out of the drive slot.

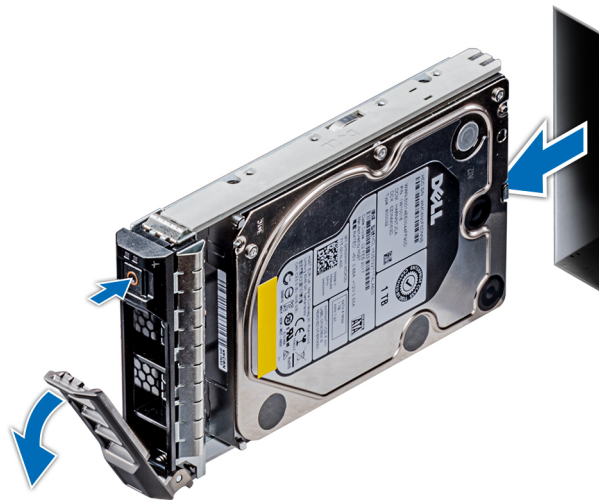

Figure 28. Removing a drive carrier

Next steps

1. [Installing a drive carrier](#).
2. If you are not replacing the drive immediately, insert a drive blank in the empty drive slot to maintain proper system cooling.

Installing a drive carrier

Prerequisites

- ⚠ **CAUTION:** Before attempting to remove or install a drive while the system is running, see the documentation for the storage controller card to ensure that the host adapter is configured correctly to support drive removal and insertion.
- ⚠ **CAUTION:** Mixing drives from previous generations of PowerEdge servers is not supported.
- ⚠ **CAUTION:** Combining SAS and SATA drives in the same RAID volume is not supported.
- ⚠ **CAUTION:** When installing a drive, ensure that the adjacent drives are fully installed. Inserting a drive carrier and attempting to lock its handle next to a partially installed carrier can damage the partially installed carrier's shield spring and make it unusable.
- ⚠ **CAUTION:** To prevent data loss, ensure that your operating system supports hot-swap drive installation. See the documentation supplied with your operating system.
- ⚠ **CAUTION:** When a replacement hot swappable drive is installed and the system is powered on, the drive automatically begins to rebuild. Ensure that the replacement drive is blank or contains data that you wish to overwrite. Any data on the replacement drive is immediately lost after the drive is installed.

1. Follow the safety guidelines listed in [Safety instructions](#) on page 27.
2. If installed, [remove the drive blank](#).

Steps

1. Press the release button on the front of the drive carrier to open the release handle.
2. Insert the drive carrier into the drive slot and slide until the drive connects with the backplane.
3. Close the drive carrier release handle to lock the drive in place.

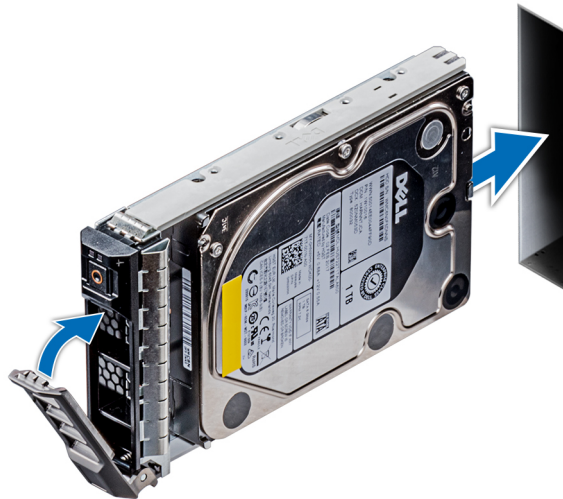

Figure 29. Installing a drive carrier

Next steps

1. If removed, [install the front bezel](#).

Removing the drive from the drive carrier

Prerequisites

Follow the safety guidelines listed in [Safety instructions](#) on page 27.

CAUTION: Mixing drives from previous generations of PowerEdge servers is not supported.

Steps

1. Using a Phillips #1 screwdriver, remove the screws from the slide rails on the drive carrier.
 - NOTE:** If the hard drive or SSD carrier has Torx screw, use Torx 6 (for 2.5-inch drive) or Torx 8 (for 3.5-inch drive) screwdriver to remove the drive. 
2. Lift the drive out of the drive carrier.

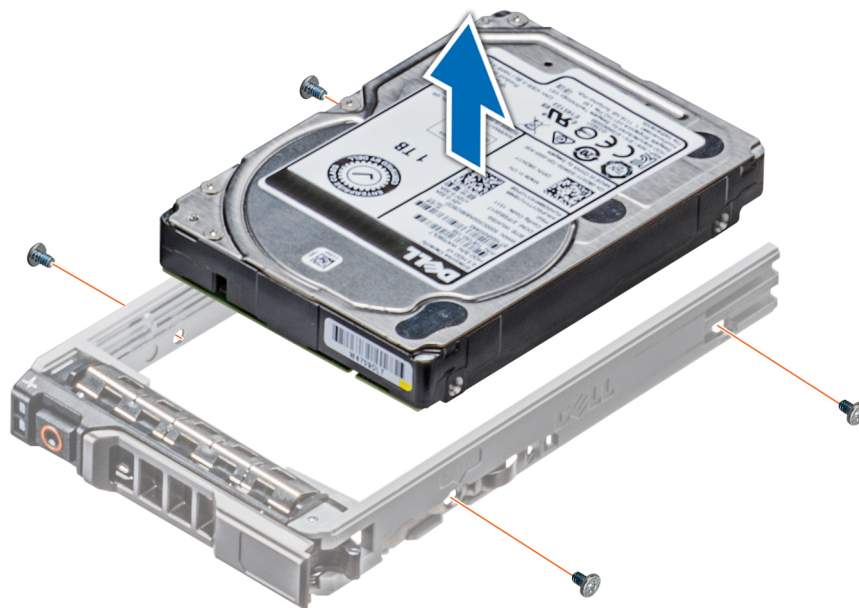

Figure 30. Removing the drive from the drive carrier

Next steps

1. [Installing the drive into the drive carrier.](#)

Installing a drive into the drive carrier

Prerequisites

Follow the safety guidelines listed in [Safety instructions](#) on page 27.

CAUTION: Mixing drive carriers from other generations of PowerEdge servers is not supported.

NOTE: When installing a drive into the drive carrier, ensure that the screws are torqued to 4 in-lbs.

Steps

1. Insert the drive into the drive carrier with the connector end of the drive towards the back of the carrier.
2. Align the screw holes on the drive with the screws holes on the drive carrier.
When aligned correctly, the back of the drive is flush with the back of the drive carrier.

3. Using a Phillips #1 screwdriver, secure the drive to the drive carrier with screws.

NOTE: If the hard drive or SSD carrier has Torx screw, use Torx 6 (for 2.5-inch drive) or Torx 8 (for 3.5-inch drive) screwdriver to install the drive.

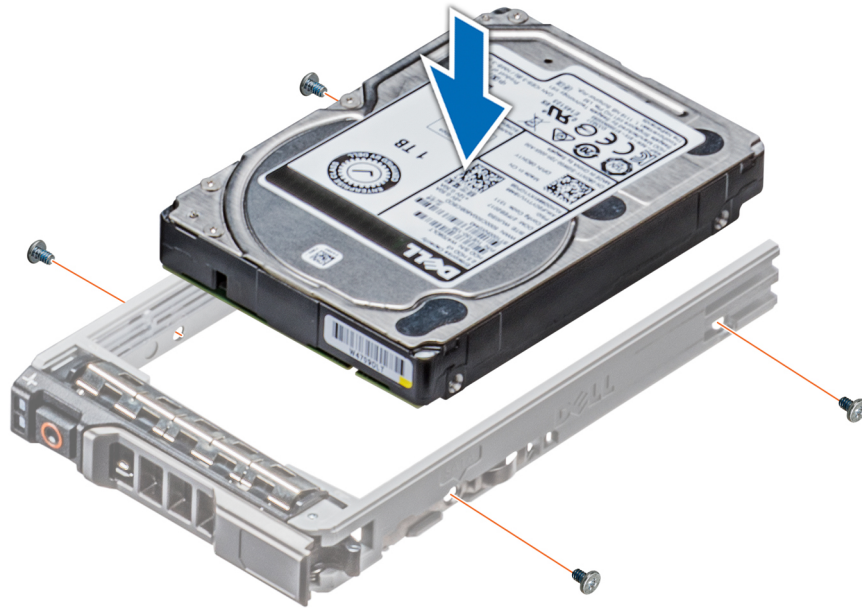

Figure 31. Installing a drive into the drive carrier

Removing a 3.5 inch drive adapter from a 3.5 inch drive carrier

Prerequisites

1. Follow the safety guidelines listed in [Safety instructions](#) on page 27.
2. If installed, [remove the front bezel](#).
3. [Remove the drive carrier](#).

Steps

1. Using a Phillips #1 screwdriver, remove the screws from the rails on the drive carrier.

NOTE: If the hard drive or SSD carrier has Torx screw, use Torx 6 (for 2.5-inch drive) or Torx 8 (for 3.5-inch drive) screwdriver to remove the drive.

2. Lift the 3.5 inch drive adapter out of the 3.5 inch drive carrier.

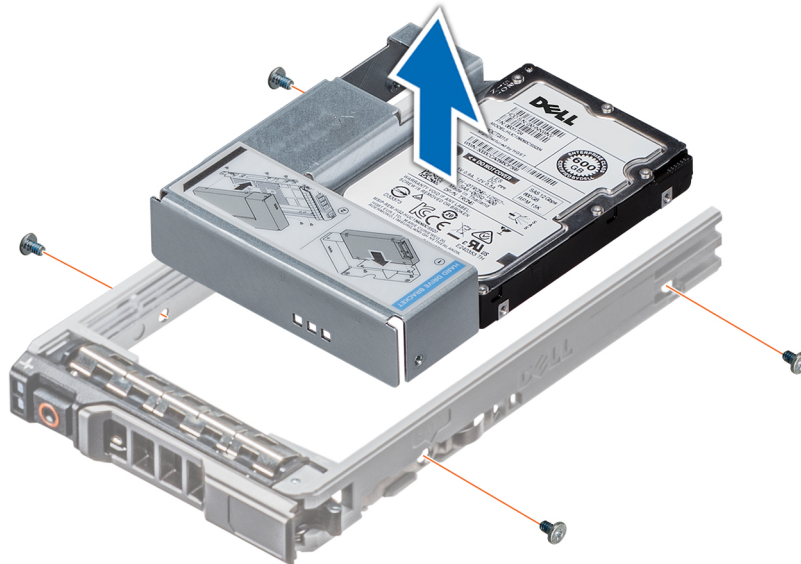

Figure 32. Removing a 3.5 inch drive adapter from a 3.5 inch drive carrier

Next steps

1. [Install the 3.5 inch drive adapter into the 3.5 inch drive carrier](#)

Installing a 3.5 inch drive adapter into the 3.5 inch drive carrier

Prerequisites

1. Follow the safety guidelines listed in [Safety instructions](#) on page 27.
2. [Install the 2.5 inch drive into the 3.5 inch drive adapter.](#)

Steps

1. Insert the 3.5 inch drive adapter into the 3.5 inch drive carrier with the connector end of the drive toward the back of the 3.5 inch drive carrier.
2. Align the screw holes on the 3.5 inch drive adapter with the holes on the 3.5 inch drive carrier.
3. Using a Phillips #1 screwdriver, secure the 3.5 inch drive adapter to the 3.5 inch carrier.

NOTE: If the hard drive or SSD carrier has Torx screw, use Torx 6 (for 2.5-inch drive) or Torx 8 (for 3.5-inch drive) screwdriver to install the drive. 

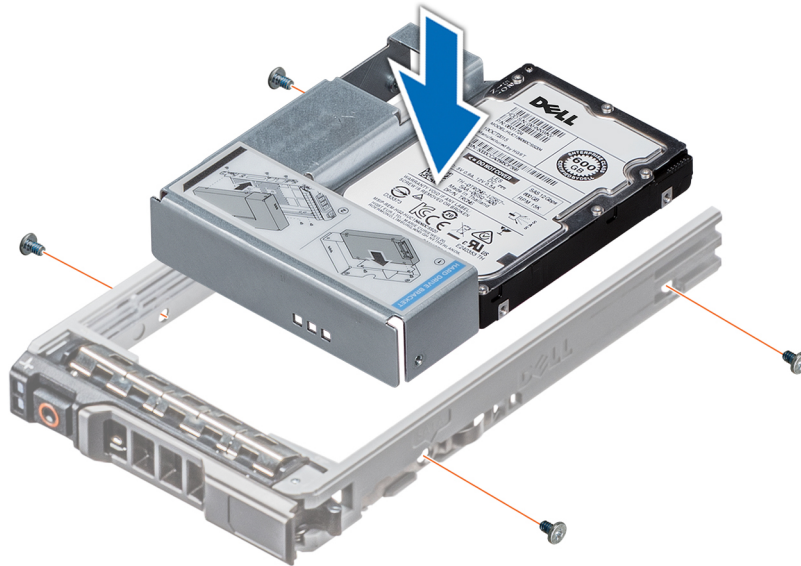

Figure 33. Installing a 3.5 inch drive adapter into the 3.5 inch drive carrier

Next steps

1. [Install the drive carrier.](#)
2. If removed, [install the front bezel.](#)

Removing a 2.5 inch drive from a 3.5 inch drive adapter

Prerequisites

1. Follow the safety guidelines listed in [Safety instructions](#) on page 27.
2. [Remove the 3.5 inch drive adapter from the 3.5 inch drive carrier.](#)

i **NOTE:** A 2.5 inch drive is installed in a 3.5 inch drive adapter, which is then installed in the 3.5 inch drive carrier.

Steps

1. Using a Phillips #2 screwdriver, remove the screws from the side of the 3.5 inch drive adapter.

i **NOTE:** If the hard drive or SSD carrier has Torx screw, use Torx 6 screwdriver to remove the drive. 

2. Remove the 2.5 inch drive from the 3.5 inch drive adapter.

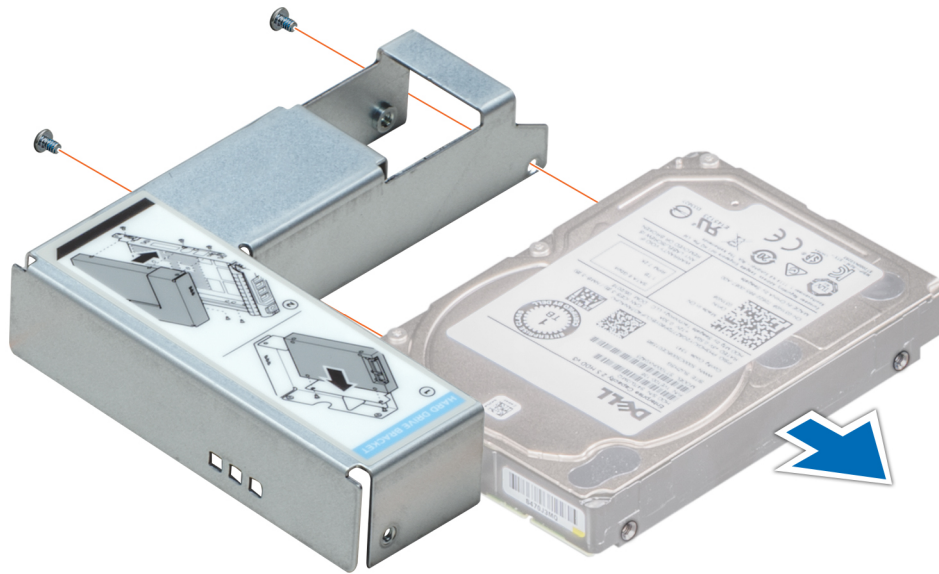

Figure 34. Removing a 2.5 inch drive from a 3.5 inch drive adapter

Next steps

Install a 2.5 inch drive into a 3.5 inch drive adapter.

Installing a 2.5 inch drive into a 3.5 inch drive adapter

Prerequisites

1. Follow the safety guidelines listed in [Safety instructions](#) on page 27.
2. Remove the 3.5 inch drive adapter from the 3.5 inch hot swappable drive carrier.

Steps

1. Align the screw holes on the 2.5 inch drive with the screw holes on the 3.5 inch drive adapter.
2. Using a Phillips #2 screwdriver, secure the 2.5 inch drive to the 3.5 inch drive adapter.

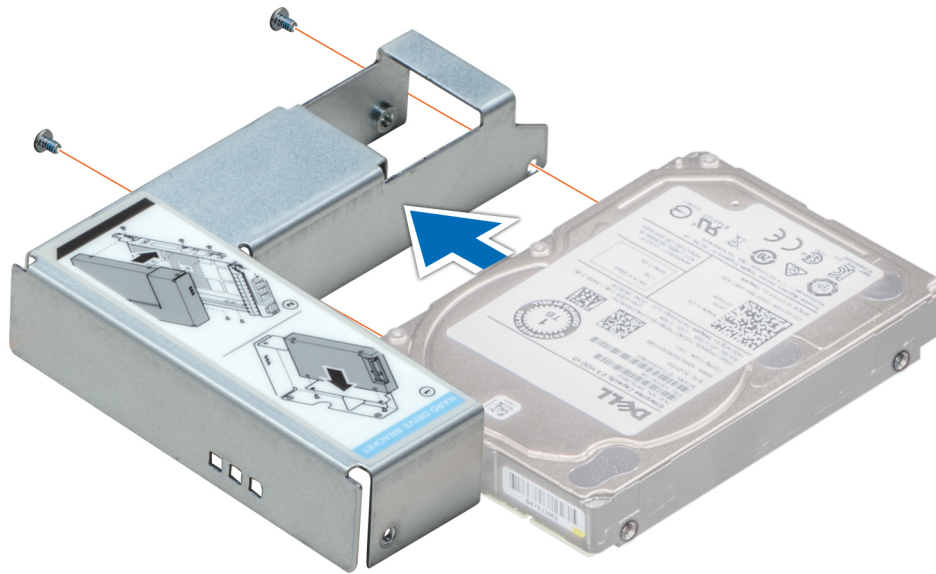

Figure 35. Installing a 2.5 inch drive into a 3.5 inch drive adapter

Next steps

1. Install the 3.5 inch drive adapter into the 3.5 inch hot swappable drive carrier.

Power supply units

PSU specifications

The power supply unit (PSU) is an internal hardware component which supplies power to the components in the system.

Your system supports one of the following:

- Two 2400 W, 2000 W, 1600 W, 1100 W, 750 W, or 495 W AC PSUs
- Two 750 W Mixed Mode HVDC PSUs

i **NOTE:** For more information, see the Technical specifications section.

⚠ CAUTION: If two PSUs are installed, both the PSUs must have the same type of label. For example, Extended Power Performance (EPP) label. Mixing PSUs from previous generations of PowerEdge servers is not supported, even if the PSUs have the same power rating. Mixing PSUs will result in mismatch condition or failure to turn the system on.

i **NOTE:** Titanium PSU is nominally rated for 200 V AC to 240 V AC input only.

i **NOTE:** When two identical PSUs are installed, power supply redundancy (1+1 – with redundancy or 2+0 – without redundancy) is configured in system BIOS. In redundant mode, power is supplied to the system equally from both PSUs when Hot Spare is disabled. When Hot Spare is enabled, one of the PSUs is put into the sleep mode when system utilization is low in order to maximize efficiency.

i **NOTE:** If two PSUs are used, they must be of the same maximum output power.

Hot spare feature

Your system supports the hot spare feature that significantly reduces the power overhead associated with power supply unit (PSU) redundancy.

When the hot spare feature is enabled, one of the redundant PSUs is switched to the sleep state. The active PSU supports 100 percent of the system load, thus operating at higher efficiency. The PSU in the sleep state monitors output voltage of the active PSU. If the output voltage of the active PSU drops, the PSU in the sleep state returns to an active output state.

If having both PSUs active is more efficient than having one PSU in the sleep state, the active PSU can also activate the sleeping PSU.

The default PSU settings are as follows:

- If the load on the active PSU is more than 50 percent of PSU rated power wattage, then the redundant PSU is switched to the active state.
- If the load on the active PSU falls below 20 percent of PSU rated power wattage, then the redundant PSU is switched to the sleep state.

You can configure the hot spare feature by using the iDRAC settings. For more information, see the iDRAC User's Guide available at Dell.com/idracmanuals.

Removing a power supply unit blank

Prerequisites

Follow the safety guidelines listed in [Safety instructions](#) on page 27.

Steps

If you are installing a second power supply unit, remove the power supply unit blank in the bay by pulling the blank outward.

CAUTION: To ensure proper system cooling, the power supply unit blank must be installed in the second power supply unit bay in a non-redundant configuration. Remove the power supply unit blank only if you are installing a second power supply unit.

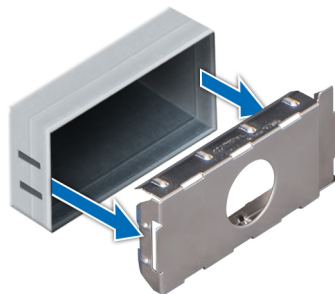

Figure 36. Removing a power supply unit blank

Next steps

1. [Install the power supply unit blank.](#)

Installing a power supply unit blank

Prerequisites

1. Follow the safety guidelines listed in [Safety instructions](#) on page 27.

NOTE: Install the power supply unit (PSU) blank only in the second PSU bay.

Steps

Align the PSU blank with the PSU slot and push it into the PSU slot until it clicks into place.

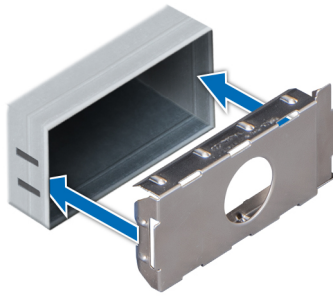

Figure 37. Installing a power supply unit blank

Next steps

1. Follow the procedure listed in [After working inside your system](#) on page 28.

Removing a AC power supply unit

Prerequisites

CAUTION: The system needs one power supply unit (PSU) for normal operation. On power-redundant systems, remove and replace only one PSU at a time in a system that is powered on.

1. Follow the safety guidelines listed in [Safety instructions](#) on page 27.
2. Disconnect the power cable from the power source and from the PSU you intend to remove, and then remove the cable from the strap on the PSU handle.

Steps

Press the orange release latch and slide the PSU out of the system by using the PSU handle.

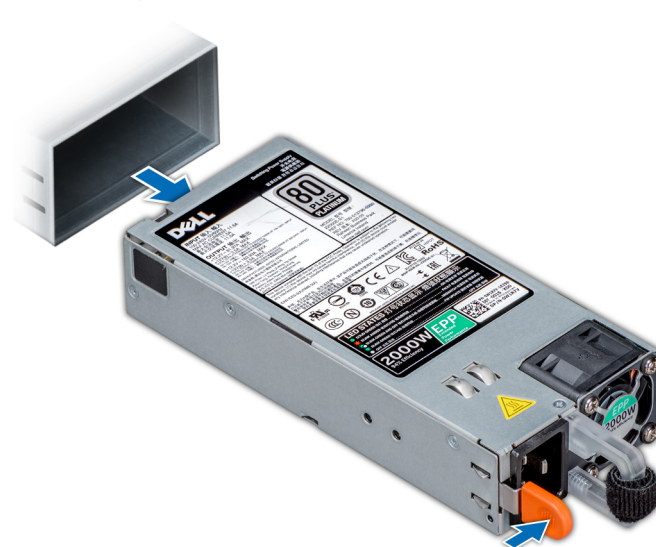

Figure 38. Removing a power supply unit

Next steps

1. [Install the AC PSU.](#)

Installing a AC power supply unit

Prerequisites

1. Follow the safety guidelines listed in [Safety instructions](#) on page 27.
2. For systems that support redundant PSU, ensure that both the PSUs are of the same type and have the same maximum output power.

NOTE: The maximum output power (shown in watts) is listed on the PSU label.

Steps

Slide the PSU into the system until the PSU is fully seated and the release latch snaps into place.

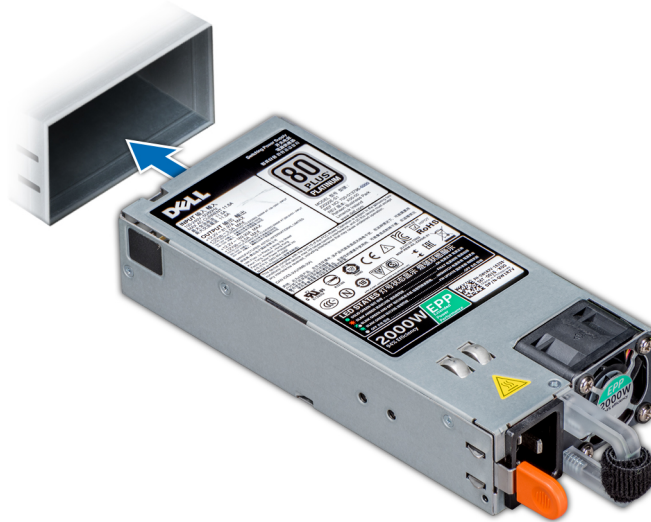

Figure 39. Installing a power supply unit

Next steps

1. Connect the power cable to the PSU, and plug the cable into a power outlet.

CAUTION: When connecting the power cable to the PSU, secure the cable to the PSU with the strap.

NOTE: When installing, hot swapping, or hot adding a new PSU, wait for 15 seconds for the system to recognize the PSU and determine its status. The PSU redundancy may not occur until discovery is complete. Wait until the new PSU is discovered and enabled before you remove the other PSU. The PSU status indicator turns green to signify that the PSU is functioning properly.

Removing a DC power supply unit

Prerequisites

NOTE: For equipment using $-(48-60)$ V DC power supply units (PSUs), a qualified electrician must perform all connections to DC power and to safety grounds. Do not attempt connecting to DC power or installing grounds yourself. All electrical wiring must comply with applicable local or national codes and practices. Damage due to servicing that is not authorized by Dell is not covered by your warranty. Read and follow all safety instructions that came with the product.

CAUTION: The system needs one PSU for normal operation. On power-redundant systems, remove and replace only one PSU at a time in a system that is powered on.

1. Follow the safety guidelines listed in [Safety instructions](#) on page 27.
2. Disconnect the power wires from the power source and the connector from the PSU you intend to remove.

3. Disconnect the safety ground wire.

Steps



Press the release latch and slide the PSU out of the system by using the PSU handle.

Next steps

1. [Install the DC PSU.](#)

Installing DC power supply unit



Prerequisites

-  **NOTE:** For equipment using $-(48-60)$ V DC power supply units (PSUs), a qualified electrician must perform all connections to DC power and to safety grounds. Do not attempt connecting to DC power or installing grounds yourself. All electrical wiring must comply with applicable local or national codes and practices. Damage due to servicing that is not authorized by Dell is not covered by your warranty. Read and follow all safety instructions that came with the product.
- 1. Follow the safety guidelines listed in [Safety instructions](#) on page 27.
- 2. For systems that support redundant power supply units (PSUs), ensure that both the PSUs are of the same type and have the same maximum output power.
 -  **NOTE:** The maximum output power (shown in watts) is listed on the PSU label.

Steps





Slide the PSU into the system until the PSU is fully seated and the release latch snaps into place.

Next steps

1. Connect the safety ground wire.
2. Install the DC power connector in the PSU.
 -  **CAUTION: When connecting the power wires, ensure that you secure the wires with the strap to the PSU handle.**
3. Connect the wires to a DC power source.
 -  **NOTE:** When installing, hot-swapping, or hot-adding a new PSU, wait for 15 seconds for the system to recognize the PSU and determine its status. The PSU status indicator turns green to signify that the PSU is functioning properly.

Wiring instructions for a DC power supply unit

Your system supports up to two $-(48-60)$ V DC power supply units (PSUs).

-  **NOTE:** For equipment using $-(48-60)$ V DC power supply units (PSUs), a qualified electrician must perform all connections to DC power and to safety grounds. Do not attempt connecting to DC power or installing grounds yourself. All electrical wiring must comply with applicable local or national codes and practices. Damage due to servicing that is not authorized by Dell is not covered by your warranty. Read and follow all safety instructions that came with the product.
-  **CAUTION: Wire the unit with copper only, unless otherwise specified, use only 10 American Wire Gauge (AWG) wire rated minimum 90°C for source and return. Protect the $-(48-60)$ V DC (1 wire) with a branch circuit over-current protection rated 50 A for DC with a high interrupt current rating.**
-  **CAUTION: Connect the equipment to a $-(48-60)$ V DC supply source that is electrically isolated from the AC source (reliably grounded $-(48-60)$ V DC SELV source). Ensure that the $-(48-60)$ V DC source is efficiently secured to earth (ground).**
-  **NOTE:** A readily accessible disconnect device that is suitably approved and rated shall be incorporated in the field wiring.

Input requirements

- Supply voltage: $-(48-60)$ V DC
- Current consumption: 32 A (maximum)

Kit contents

- Dell part number 6RYJ9 terminal block or equivalent (1)
- #6-32 nut equipped with lock washer (1)

Required tools

Wire-stripper pliers capable of removing insulation from size 10 AWG solid or stranded, insulated copper wire.

 **NOTE:** Use alpha wire part number 3080 or equivalent (65/30 stranding).

Required wires

- One UL 10 AWG, 2 m maximum (stranded) black wire [$-(48-60)$ V DC].
- One UL 10 AWG, 2 m maximum (stranded) red wire (V DC return).
- One UL 10 AWG, 2 m maximum, green with a yellow stripe, stranded wire (safety ground).

System cover

Removing the system cover

Prerequisites

1. Follow the safety guidelines listed in [Safety instructions](#) on page 27.
2. Turn off the system and all attached peripherals.
3. Disconnect the system from the electrical outlet and peripherals.
4. If installed, [remove the front bezel](#).
5. Place the system on a flat, stable surface.

Steps

1. Turn the latch release lock to the unlocked position.
2. Press the cover release latch and remove the system cover.

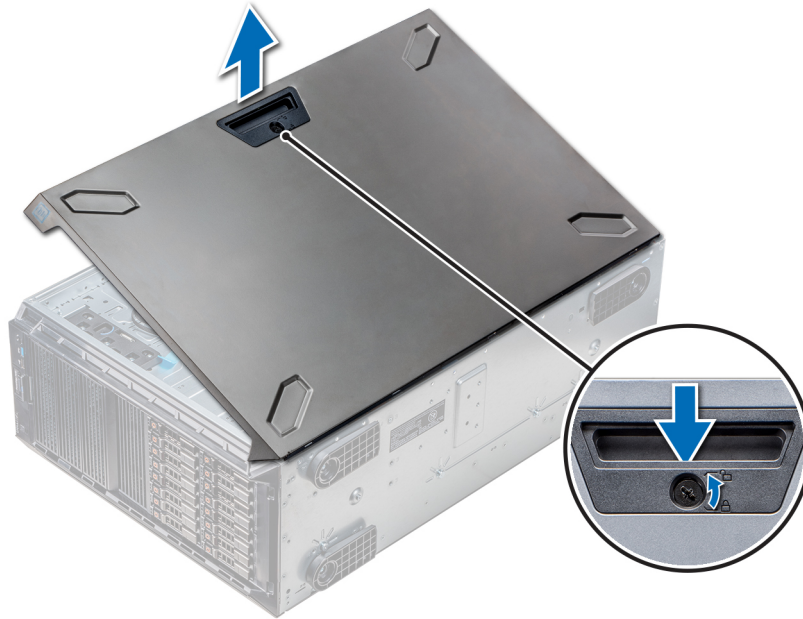

Figure 40. Removing the system cover

Next steps

1. [Install the system cover.](#)

Installing the system cover

Prerequisites

i **NOTE:** Ensure that all internal cables are connected and placed out of the way and no tools or extra parts are left inside the system.

Follow the safety guidelines listed in [Safety instructions](#) on page 27.

Steps

1. Align the tabs on the system cover with the slots on the chassis.
2. Press the cover release latch, and push the cover toward the chassis until the latch locks into place.
3. Rotate the latch release lock clockwise to the locked position.

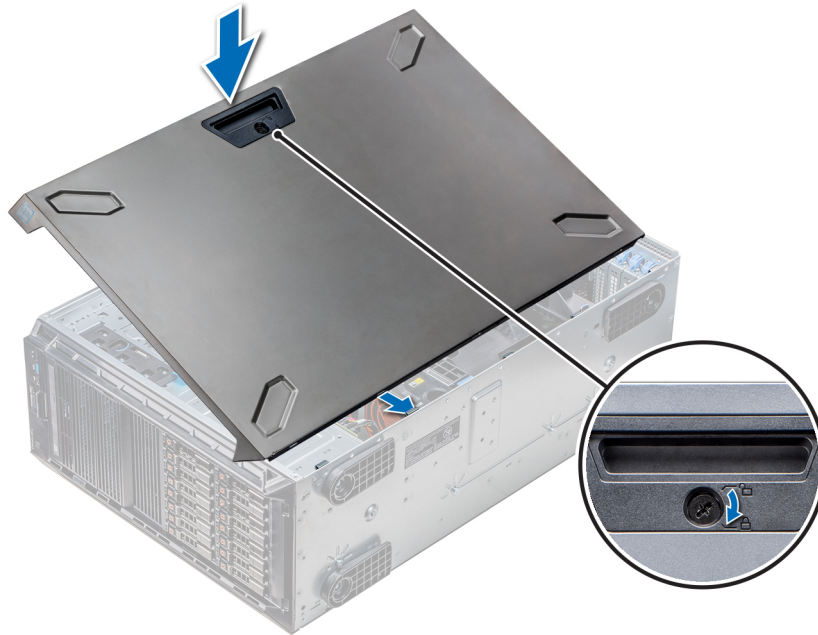

Figure 41. Installing the system cover

Next steps

1. Place the system upright on its feet on a flat and stable surface.
2. If removed, [install the front bezel](#).
3. Reconnect the peripherals and connect the system to the electrical outlet.
4. Turn on the system, including all attached peripherals.

Inside the system

NOTE: Components that are hot swappable are marked orange and touch points on the components are marked blue.

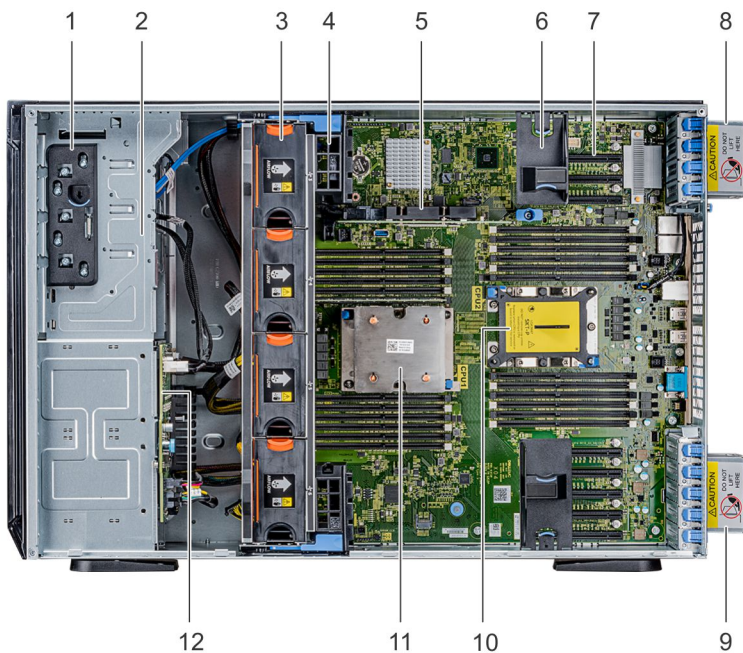

1. Release latch

2. Drive cage

3. Hot-swappable fans (middle fans)
5. Internal PERC
7. PCIe slots
9. Right external fan
11. CPU1
4. GPU card holder
6. PCIe card holder
8. Left external fan
10. CPU2 socket
12. Backplane

Air shroud

Removing the optional GPU air shrouds

Prerequisites

CAUTION: Never operate your system with the air shroud removed. The system may get overheated quickly, resulting in shutdown of the system and loss of data.

1. Follow the safety guidelines listed in [Safety instructions](#) on page 27.
2. Follow the procedure listed in [Before working inside your system](#) on page 28.

Steps

Holding the touch points, press the release latch and lift the shroud out.

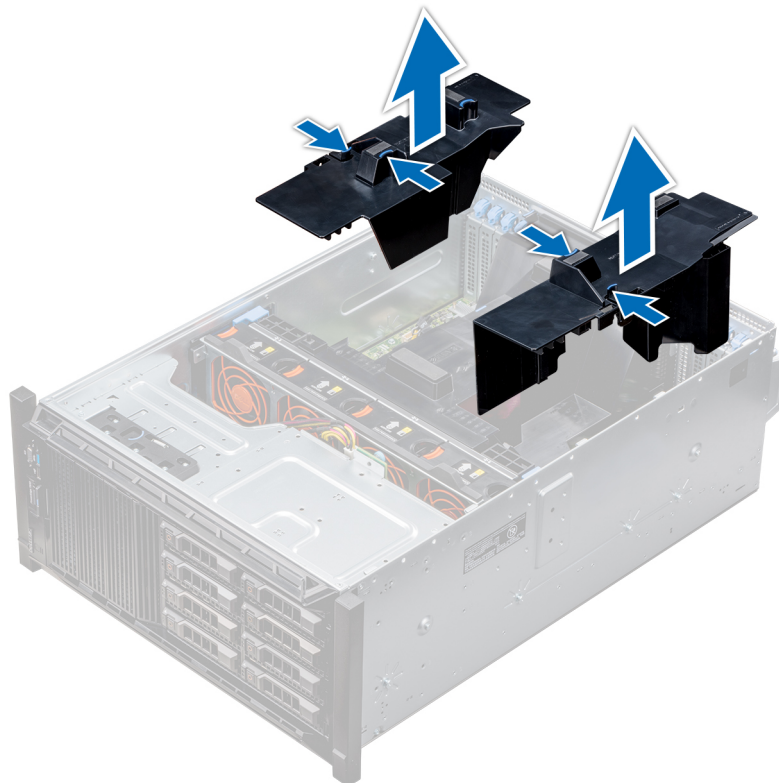

Figure 42. Removing the optional GPU air shrouds

Next steps

1. [Install the optional GPU air shrouds.](#)

Installing the optional GPU air shrouds

Prerequisites

Follow the safety guidelines listed in [Safety instructions](#) on page 27.

Steps

1. Align the tabs on the GPU air shroud with the securing slots on the chassis.
2. Lower the GPU air shroud into the chassis until it is firmly seated.

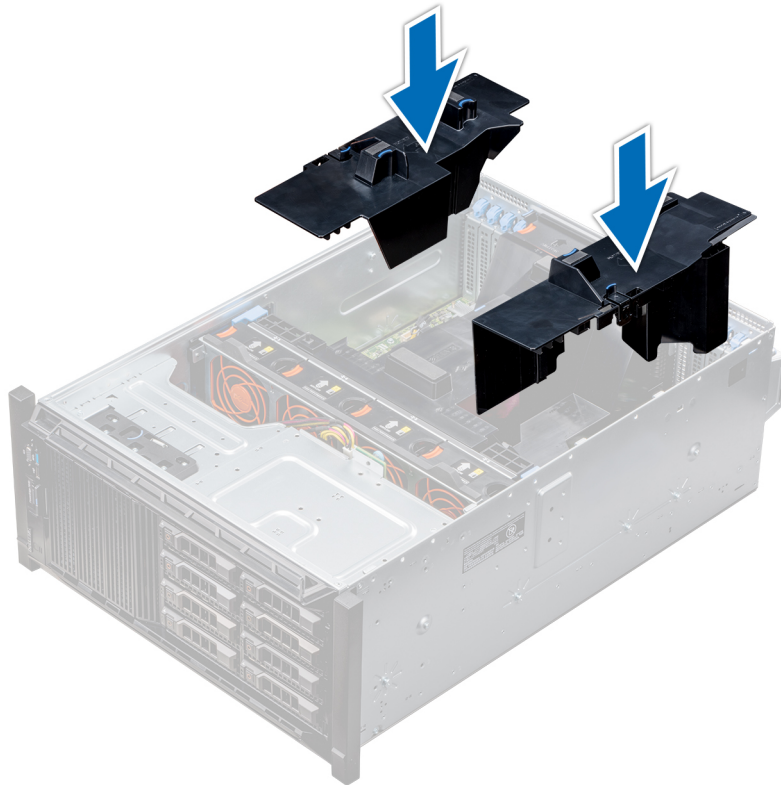

Figure 43. Installing the optional GPU air shrouds

Next steps

Follow the procedure listed in [After working inside your system](#) on page 28.

Removing the air shroud

Prerequisites

CAUTION: Never operate your system with the air shroud removed. The system may get overheated quickly, resulting in shutdown of the system and loss of data.

1. Follow the safety guidelines listed in [Safety instructions](#) on page 27.
2. Follow the procedure listed in [Before working inside your system](#) on page 28.
3. If required, [remove the two fans from the air shroud](#).

NOTE: The procedure to remove the cooling fan from the air shroud is similar to removing a cooling fan.

Steps

Push the air shroud release tab, and holding the touch points at the center of the air shroud, lift the shroud from the system.

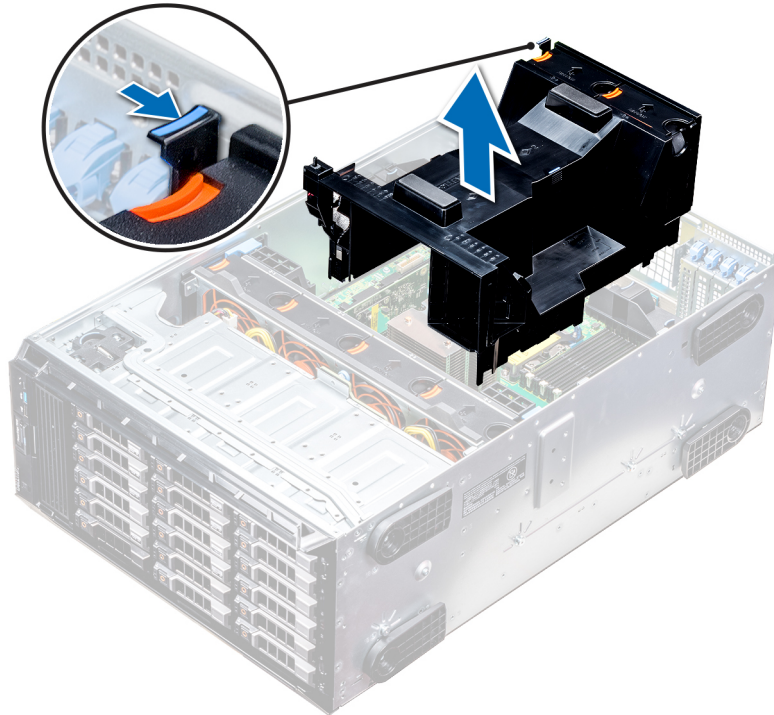

Figure 44. Removing the air shroud

Next steps

1. [Install the air shroud.](#)

Installing the air shroud

Prerequisites

1. Follow the safety guidelines listed in [Safety instructions](#) on page 27.
2. If applicable, route the cables inside the system along the chassis wall and secure the cables by using the cable-securing bracket.

Steps

1. Align the tabs on the air shroud with the securing slots on the chassis.
 - a. Guide on the air shroud with the guide pin on the system board.
 - b. Align the intrusion switch with the intrusion switch connector on the system board.
2. Lower the air shroud into the chassis until it is firmly seated.

When firmly seated, the memory socket numbers marked on the air shroud align with the respective memory sockets.
3.  **NOTE:** The procedure to install the cooling fan into the air shroud is similar to installing a cooling fan.

If removed, [install the fans into the air shroud.](#)

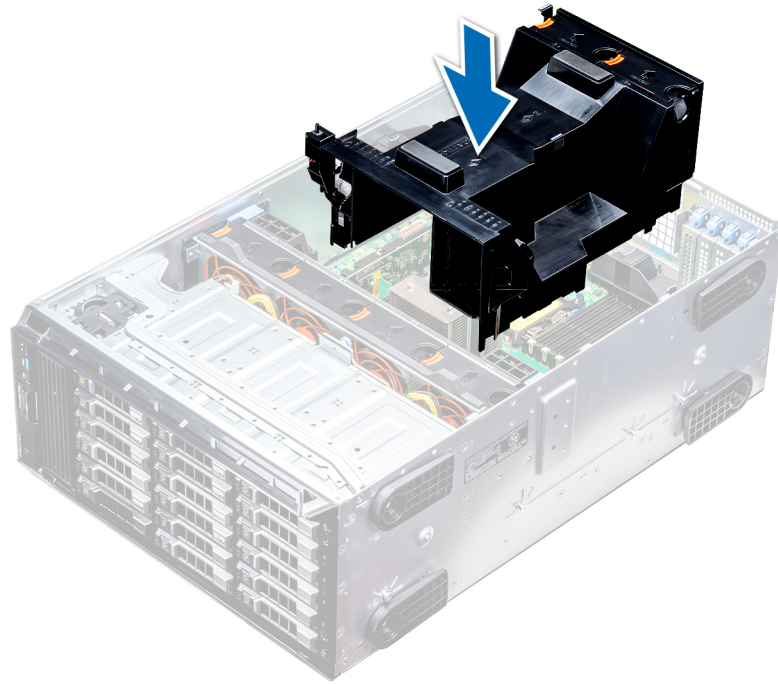

Figure 45. Installing the air shroud

Next steps

1. Follow the procedure listed in [After working inside your system](#) on page 28.

Cooling fans

Cooling fan specifications

The cooling fans are integrated into the system to dissipate the heat generated by the functioning of the system. These fans provide cooling for the processors, expansion cards, and memory modules.

Your system supports a total of eight fans, including six hot-swappable fans and two external fans. Two hot-swappable fans are mounted in rear side of the air shroud. The other four hot-swappable (middle) fans are mounted in the fan assembly that is located in the chassis between the hard drive bay and the processors. The two external fans are mounted on the outside of the chassis for GPU configurations. There are two additional fans integrated in the power supplies to cool the power supplies and provide additional cooling for the whole system.

The below listed configurations, features, and the PCIe expansion cards are supported only with the four hot-swappable (middle) fans installed:

- Fan redundancy
- Fresh air condition
- NVMe/PCIe SSD
- 3.5 inch x 18 hard drives chassis
- Mellanox CX4 DP 100 Gb QSFP NIC (0272F)
- Mellanox CX4 DP 100 Gb NIC (068F2)
- Mellanox CX4 SP 100 Gb NIC (6W1HY)
- Mellanox DP 40 Gb QSFP NIC (C8Y42)
- Intel QP 10 Gb Base-T NIC (K5V44)
- Solarflare Sunspot DP 10Gb NIC (NPHCM)
- Solarflare Nova DP 10Gb NIC (WY7T5)
- Qlogic DP 10Gb V1 NIC (VCXN5)

Listed below are the restrictions for fan redundancy:

- GPGPU configurations are not supported at 35deg. C of ambient or above.
- Mellanox 100G NICs are not supported.

For information on the restriction for fresh air condition, see the PowerEdge T640 Technical Specs at www.dell.com/poweredgemanuals

Cooling fan matrix

Table 11. Cooling fan matrix

Chassis	FAN1, FAN2 (Standard [STD])	FAN3, FAN4, FAN5, FAN6 (Standard [STD]/ High performance [HPR])	FAN_EXT_R, FAN_EXT_L	Fan configuration
3.5 inch x 8	Yes	-	-	Base configuration
3.5 inch x 18	Yes	Yes (STD)	-	Rich configuration
2.5 inch x 16	Yes	-	-	Base configuration
2.5 inch x 32	Yes	-	-	Base configuration
2.5 inch x 16 + NVMe	Yes	Yes (STD)	-	Rich configuration
Fan redundancy, FA and high cooling tier PCIe card	Yes	Yes (STD)	-	Rich configuration
GPGPU card	Yes	Yes (HPR)	Yes	GPU configuration

Removing a middle or rear cooling fan

The procedure for removing a standard and a high performance fans is identical.

Prerequisites

 **NOTE:** Opening or removing the system cover when the system is on may expose you to a risk of electric shock. Exercise utmost care while removing or installing cooling fans.

 **CAUTION:** The cooling fans are hot swappable. To maintain proper cooling while the system is on, replace only one fan at a time.

1. Follow the safety guidelines listed in [Safety instructions](#) on page 27.
2. Follow the procedure listed in [Before working inside your system](#) on page 28.

Steps

Press the release tab and lift the cooling fan out of the cooling fan assembly.



Figure 46. Removing a middle cooling fan

Next steps

1. [Installing a middle or rear cooling fan.](#)

Installing a middle or rear cooling fan

The procedure for installing a standard and a high performance fans is identical.

Prerequisites

i NOTE: Opening or removing the system cover when the system is on may expose you to a risk of electric shock. Exercise utmost care while removing or installing cooling fans.

⚠ CAUTION: The cooling fans are hot swappable. To maintain proper cooling while the system is on, replace only one fan at a time.

1. Follow the safety guidelines listed in [Safety instructions](#) on page 27.
2. Follow the procedure listed in [Before working inside your system](#) on page 28.

Steps

Holding the release tab, align the connector at the base of the cooling fan with the connector on the system board.



Figure 47. Installing a middle cooling fan

Next steps

1. Follow the procedure listed in [After working inside your system](#) on page 28.

Removing the right external fan

Prerequisites

NOTE: Opening or removing the system cover when the system is on may expose you to a risk of electric shock. Exercise utmost care while removing or installing cooling fans.

NOTE: The procedure to remove the left external fan is similar to removing the right rear fan.

1. Follow the safety guidelines listed in [Safety instructions](#) on page 27.
2. [Remove the GPU air shrouds](#).
3. [Remove the air shroud](#).

Steps

1. Disconnect the fan cable from the system board.
2. Using the Phillips #2 screwdriver, loosen the captive screws that secure the fan to the system.
3. Lift the fan away, while guiding the fan cable through the cable vent.

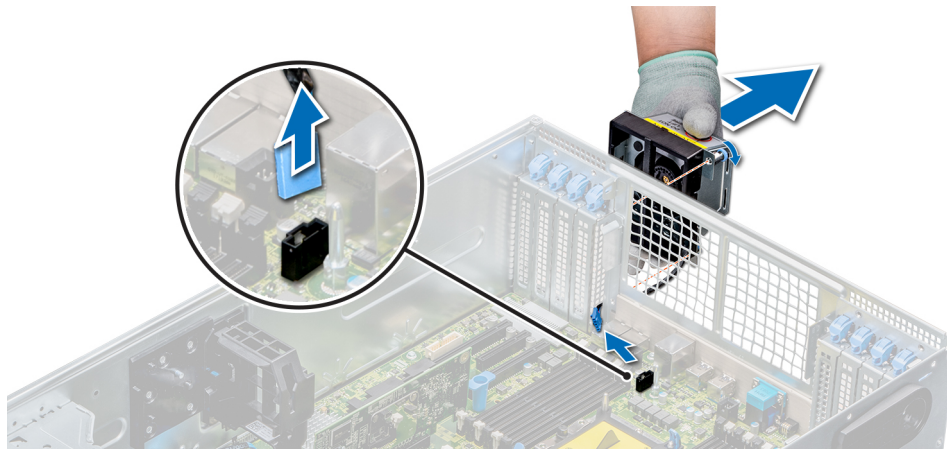

Figure 48. Removing the right external fan

Next steps

1. Installing the right external fan.

Installing the right external fan

Prerequisites

NOTE: The procedure to install the left external fan is similar to installing the right rear fan.

Follow the safety guidelines listed in [Safety instructions](#) on page 27.

Steps

1. Guiding the fan cable through the cable vent, install the external fan over the PCIe slots.
2. Using the Phillips #2 screwdriver, secure the fan in place.
3. Connect the fan cable to the connected on the system board.

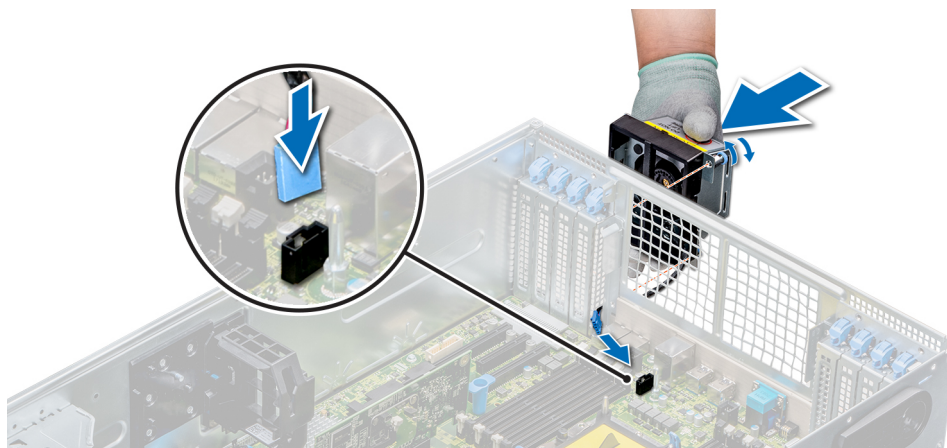

Figure 49. Install the right external fan

Next steps

1. Install the air shroud.
2. Install the GPU air shrouds.
3. Follow the procedure listed in [After working inside your system](#) on page 28.

Cooling fan (middle fan) assembly

Removing the middle cooling fan assembly

Prerequisites

1. Follow the safety guidelines listed in [Safety instructions](#) on page 27.
2. Follow the procedure listed in [Before working inside your system](#) on page 28.

Steps

1. Lift the release levers to unlock the cooling fan assembly from the system.
2. Hold the release levers, and lift the cooling fan assembly away from the system.

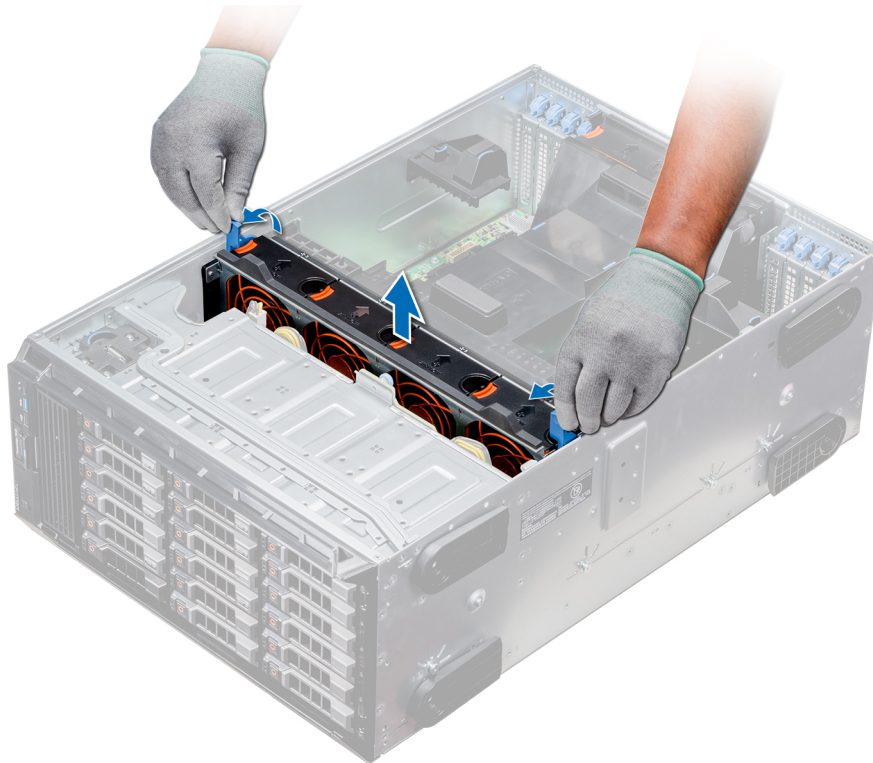

Figure 50. Removing the middle cooling fan assembly

Next steps

1. [Installing the middle cooling fan assembly.](#)

Installing the middle cooling fan assembly

Prerequisites

Follow the safety guidelines listed in [Safety instructions](#) on page 27.

CAUTION: Ensure that the cables inside the system are correctly installed and retained by the cable retention bracket before installing the cooling fan assembly. Incorrectly installed cables may get damaged.

Steps

1. Align the guide rails on the cooling fan assembly with the standoffs on the system.

2. Lower the cooling fan assembly into the system until the cooling fan connectors engage with the connectors on the system board.
3. Press the release levers to lock the cooling fan assembly into the system.

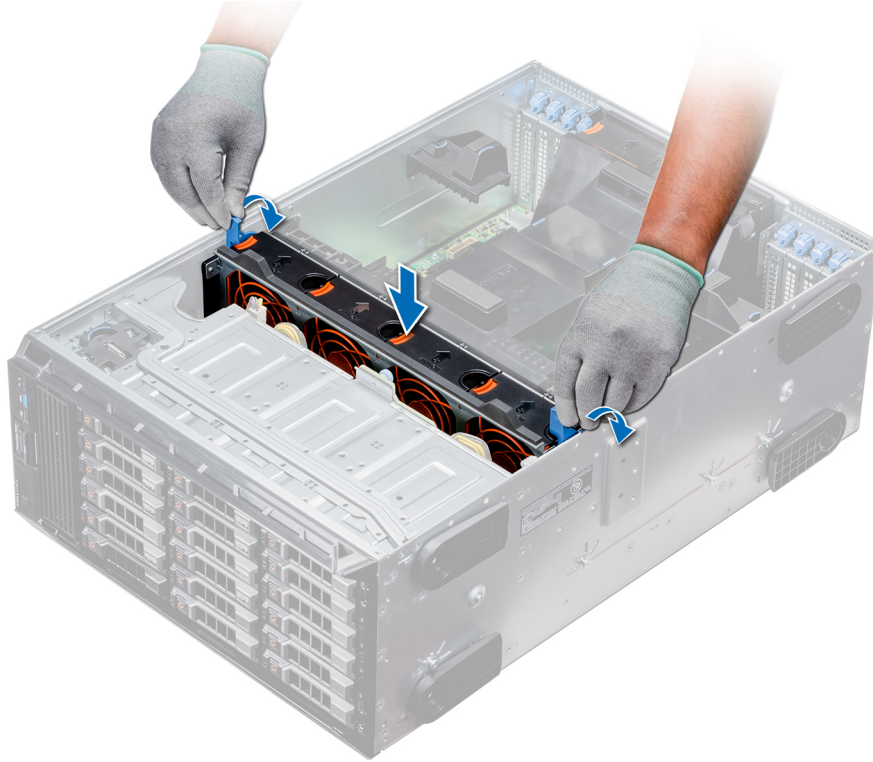

Figure 51. Installing the middle cooling fan assembly

Next steps

1. Follow the procedure listed in [After working inside your system](#) on page 28.

Flex bays

Removing a NVMe drive bay or flex bay

Prerequisites

NOTE: The procedure to remove the flex bay is identical to removing the NVMe drive bay.

1. Follow the safety guidelines listed in [Safety instructions](#) on page 27.
2. Follow the procedure listed in [Before working inside your system](#) on page 28.
3. Disconnect the slim optical-drive and the backplane cables.
4. [Remove the backplane from NVMe drive bay or the flex bay.](#)

Steps

1. Using the Phillips #2 screwdriver, remove the two screws that secure the NVMe drive bay to the system.
2. Push the release latch down and slide the NVMe drive bay out of the system.



Figure 52. Removing a NVMe drive bay or flex bay

Next steps

1. [Installing the NVMe drive bay or flex bay.](#)

Installing a NVMe drive bay or flex bay

Prerequisites

NOTE: The procedure to install the flex bay is identical to installing the NVMe drive bay.

Follow the safety guidelines listed in [Safety instructions](#) on page 27.

Steps

1. Align the tabs on the NVMe drive bay with the slots on the front of the system.
2. Insert the NVMe drive bay into the system until the tabs click into place.
3. Using the Phillips #2 screwdriver secure the NVMe drive bay to the system.



Figure 53. Installing a NVMe drive bay or flex bay

Next steps

1. [Install the backplane to the NVMe drive bay or flex bay.](#)
2. Connect the slim optical drive and the back plane cables.
3. Follow the procedure listed in [After working inside your system](#) on page 28.

Optical drives and tape drives

Optical drives and tape drives specifications

Your system supports one of the following configurations:

Table 12. System configurations

System	Configurations
Eight 3.5 inch drives or sixteen 2.5 inch drives	Up to two SATA slim optical drives and one SAS tape drive
Sixteen 2.5 inch drives and eight NVMe drives	One SATA slim optical drive
Systems with up to eighteen 3.5 inch drives	One SATA slim optical drive or one SAS tape drive
Systems with up to thirty-two 2.5 inch drives	One SATA slim optical drive

Removing the optical or tape drive blank

Prerequisites

1. Follow the safety guidelines listed in [Safety instructions](#) on page 27.
2. Follow the procedure listed in [Before working inside your system](#) on page 28.
3. If installed, [remove the front bezel.](#)

Steps

1. To remove the drive blank, slide the release latch down to release the drive blank.
2. Push the drive blank to slide it out of the drive bay.

i **NOTE:** Blanks must be installed on empty optical drive or tape drive slots to maintain FCC certification of the system. The brackets also keep dust and dirt out of the system and aid in proper cooling and airflow inside the system. Perform the same steps to install blanks.



Figure 54. Removing the optical drive or tape drive

Next steps

1. Install the [optical drive blank](#), [an optical drive](#), or [a tape drive](#).

Installing the optical or tape drive blank

Prerequisites

1. Follow the safety guidelines listed in [Safety instructions](#) on page 27.
2. If installed, [remove the front bezel](#).

Steps

1. Align the guide on the drive blank with the slot on drive bay.
2. Slide the drive into the slot until the latch snaps into place.



Figure 55. Installing the optical or tape drive blank

Next steps

1. If removed, [install the front bezel](#).
2. Follow the procedure listed in [After working inside your system](#) on page 28.

Removing the optical drive cage or tape drive

Prerequisites

i **NOTE:** The procedure to remove the optical drive cage is identical to removing a tape drive.

1. Follow the safety guidelines listed in [Safety instructions](#) on page 27.
2. Follow the procedure listed in [Before working inside your system](#) on page 28.
3. If installed, [remove the front bezel](#).

Steps

1. Disconnect the power and data cable from the back of the drive.

i **NOTE:** Observe the routing of the power and data cable inside the chassis as you remove them from the system board and the drive. You must route these cables properly when you replace them to prevent them from being pinched or crimped.

2. To remove the drive, push the release latch to release the drive.
3. Slide the drive out of the drive bay.
4. If you are not immediately replacing the tape drive, install the blank.

i **NOTE:** Blanks must be installed on empty optical drive or tape drive slots to maintain FCC certification of the system. The brackets also keep dust and dirt out of the system and aid in proper cooling and airflow inside the system. Perform the same steps to install blanks.



Figure 56. Removing the optical drive cage or tape drive

Next steps

1. Install the optical drive cage or tape drive.

Installing the optical drive cage or tape drive

Prerequisites

NOTE: The procedure to install the optical drive cage is the same as installing the tape drive.

Follow the safety guidelines listed in [Safety instructions](#) on page 27.

Steps

1. Unpack and prepare the drive for installation.
For instructions, see the documentation that shipped with the drive.
If you are installing a SAS tape drive, you must have an internal tape adapter installed. For more information on installing a SAS tape drive, see the [Installing an expansion card](#) on page 93 section.
2. If applicable, remove the existing drive or the drive blank.
3. Align the guide on the drive with the slot on drive bay.
4. Slide the drive into the slot until the latch clicks into place.
5. Connect the power and data cable to the drive.
6. Connect the power and data cables to the backplane and the system board.



Figure 57. Installing the optical drive cage or tape drive

Next steps

1. If removed, [install the front bezel](#).
2. Follow the procedure listed in [After working inside your system](#) on page 28.

Removing the slim optical drive

The procedure to remove the slim optical drive blank is similar to removing the slim optical drive.

Prerequisites

1. Follow the safety guidelines listed in [Safety instructions](#) on page 27.
2. Follow the procedure listed in [Before working inside your system](#) on page 28.
3. [Remove the optical drive cage](#).

NOTE: The procedure to remove the optical drive cage is identical to removing the optical or tape drive blank.

Steps

1. Locate the touch point for the slim optical drive lock on the cage.
2. Press the lock and push the slim optical drive out of the cage.

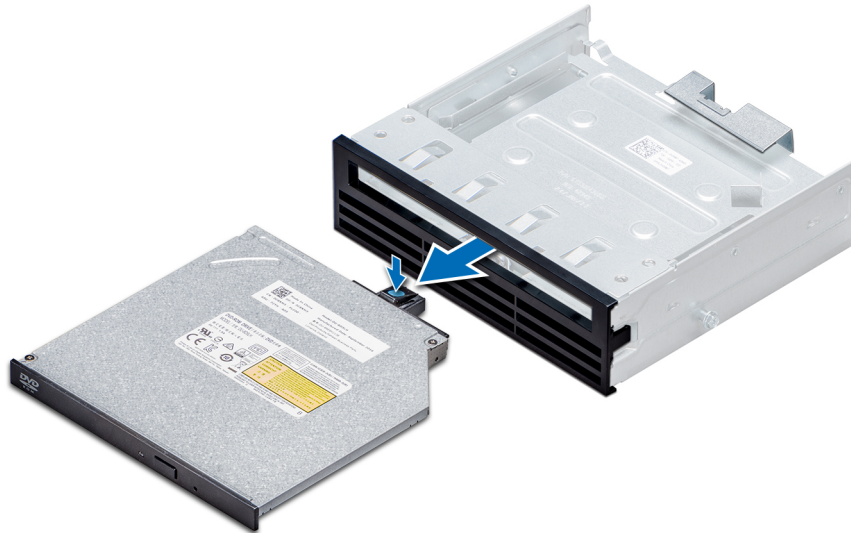

Figure 58. Removing the slim optical drive blank

Next steps

1. [Install the slim optical drive or the optical drive blank.](#)

Installing the slim optical drive

The procedure to install the optical drive blank is similar to installing the slim optical drive.

Prerequisites

Follow the safety guidelines listed in [Safety instructions](#) on page 27.

Steps

1. Align the slim optical drive with the slim optical drive bay on the optical drive cage.
2. Slide the optical drive into the optical drive bay until the lock clicks into place.



Figure 59. Installing the slim optical drive blank

Next steps

1. [Install the optical drive cage.](#)
2. Follow the procedure listed in [After working inside your system](#) on page 28.

NVDIMM-N battery

Removing the NVDIMM-N battery

Prerequisites

1. Follow the safety guidelines listed in [Safety instructions](#) on page 27.
2. Follow the procedure listed in [Before working inside your system](#) on page 28.

CAUTION: To prevent data loss, ensure that your system is turned off and that the indicator LEDs on the battery are Off before removing the NVDIMM-N battery.

CAUTION: To avoid damage to the battery connector, you must firmly support the connector while installing or removing a battery.

3. Remove the NVDIMM-N battery cage.

Steps

1. Disconnect the cables from the NVDIMM-N battery.
2. Using the Phillips #2 screwdriver, loosen the screw securing the NVDIMM-N battery.
3. Holding the edges, lift the battery from the NVDIMM-N battery cage.



Figure 60. Removing the NVDIMM-N battery

Next steps

1. [Install the NVDIMM-N battery.](#)

Installing the NVDIMM-N battery

Prerequisites

CAUTION: To avoid damage to the battery connector, you must firmly support the connector while installing or removing a battery.

Follow the safety guidelines listed in [Safety instructions](#) on page 27.

Steps

1. Install the NVDIMM-N battery into the battery cage
2. Using the Phillips #2 screwdriver, tighten the screw to secure the NVDIMM-N battery.
3. Connect the cables to the NVDIMM-N battery.



Figure 61. Installing the NVDIMM-N battery

Next steps

1. Install the NVDIMM-N battery cage.
2. Follow the procedure listed in [After working inside your system](#) on page 28.

System memory

System memory guidelines

The PowerEdge systems support DDR4 Registered DIMMs (RDIMMs), Load Reduced DIMMs (LRDIMMs), and Non-Volatile DIMMs (NVDIMM-Ns). System memory holds the instructions that are executed by the processor.

Your system contains 24 memory sockets split into two sets of 12 sockets, one set per processor. Each 12-socket set is organized into six channels. Six memory channels are allocated to each processor. In each channel, the release tabs of the first socket are marked white, and the second socket black.

Memory channels are organized as follows:

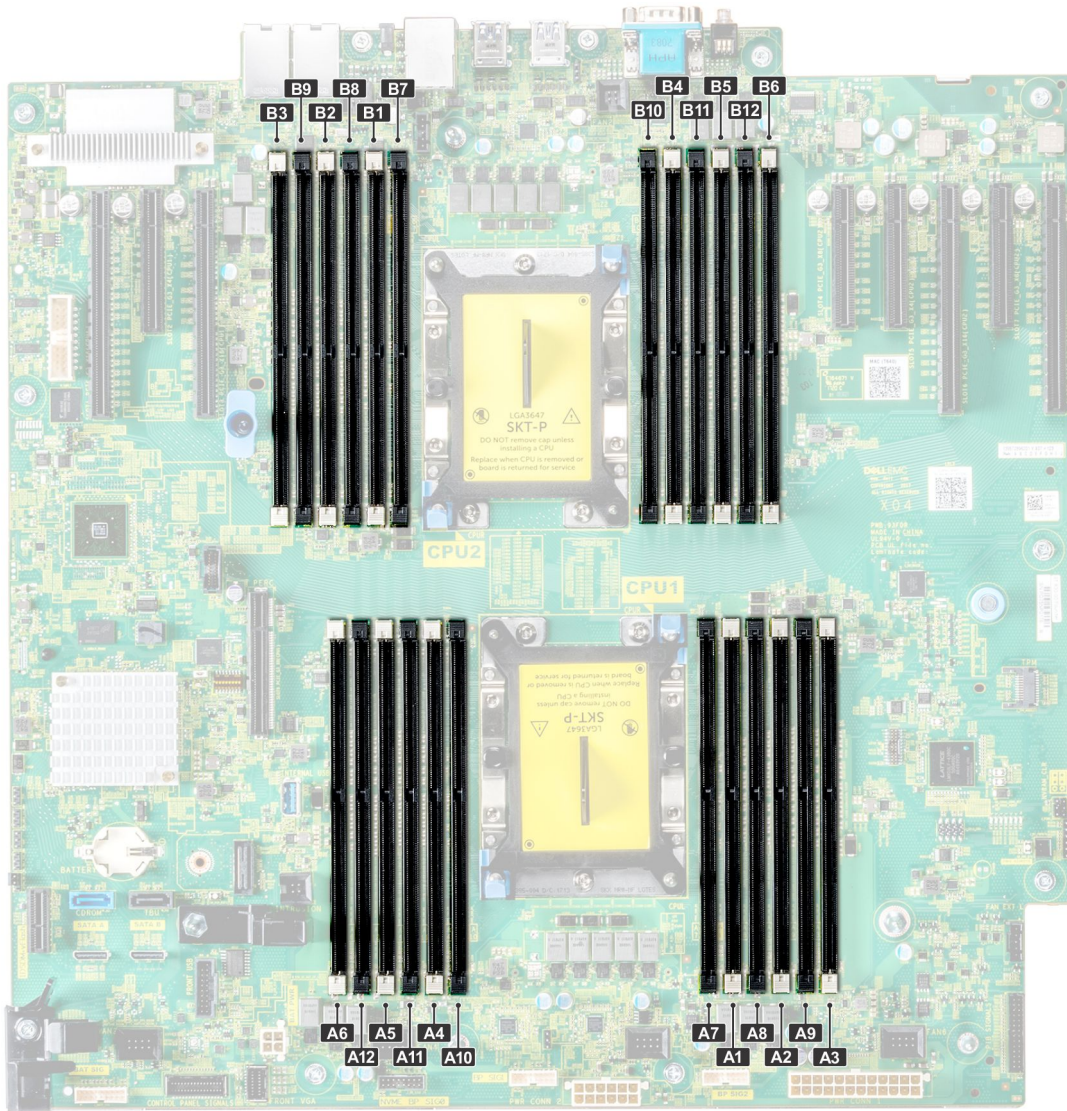

Figure 62. System memory view

Table 13. Memory channels

Processor	Channel 0	Channel 1	Channel 2	Channel 3	Channel 4	Channel 5
Processor 1	Slots A1 and A7	Slots A2 and A8	Slots A3 and A9	Slots A4 and A10	Slots A5 and A11	Slots A6 and A12
Processor 2	Slots B1 and B7	Slots B2 and B8	Slots B3 and B9	Slots B4 and B10	Slots B5 and B11	Slots B6 and B12

The following table shows the memory populations and operating frequencies for the supported configurations:

Table 14. Memory population

DIMM Type	DIMMs Populated/Channel	Voltage	Operating Frequency (in MT/s)	Maximum DIMM Rank/Channel
RDIMM	1	1.2 V	2933, 2666, 2400, 2133	Dual rank or single rank
	2		2933, 2666, 2400, 2133	Dual rank or single rank
LRDIMM	1	1.2 V	2933, 2666, 2400, 2133	Quad rank or Octo rank
	2		2666, 2400, 2133	Quad rank or Octo rank

Table 14. Memory population (continued)

DIMM Type	DIMMs Populated/ Channel	Voltage	Operating Frequency (in MT/s)	Maximum DIMM Rank/ Channel
NVDIMM-N	1	1.2 V	2933, 2666, 2400, 2133	Single rank

NVDIMM population rules

- Maximum of one NVDIMM per channel.
- Maximum of six NVDIMMs per processor
- Maximum capacity per NVDIMM is 16GB

NVDIMMs are not supported on the following configurations:

- 32 x 2.5-inch SAS/SATA/SSD drive configuration
- 16 x 2.5-inch SAS/SATA/SSD drives with 8 x NVME drive configuration

General memory module installation guidelines

To ensure optimal performance of your system, observe the following general guidelines when configuring your system memory. If your system's memory configurations fail to observe these guidelines, your system might not boot, stop responding during memory configuration, or operate with reduced memory.

The memory bus may operate at frequency can be 2933 MT/s, 2666 MT/s, 2400 MT/s, or 2133 MT/s depending on the following factors:

- System profile selected (for example, Performance Optimized, or Custom [can be run at high speed or lower])
- Maximum supported DIMM speed of the processors. For memory frequency of 2933 MT/s, one DIMM per channel is supported.
- Maximum supported DIMM speed of the processors. For memory frequency of 2933 MT/s, two DIMM per channel is supported on RDIMM.
- Maximum supported speed of the DIMMs

i **NOTE:** MT/s indicates DIMM speed in MegaTransfers per second.

The system supports Flexible Memory Configuration, enabling the system to be configured and run in any valid chipset architectural configuration. The following are the recommended guidelines for installing memory modules:

- All DIMMs must be DDR4.
- RDIMMs and LRDIMMs must not be mixed.
- NVDIMMs and LRDIMMs must not be mixed.
- NVDIMMs and RDIMMs can be mixed.
- 64 GB LRDIMMs that are DDP (Dual Die Package) LRDIMMs must not be mixed with 128 GB LRDIMMs that are TSV (Through Silicon Via/3DS) LRDIMMs.
- x4 and x8 DRAM based memory modules can be mixed.
- Up to two RDIMMs can be populated per channel regardless of rank count.
- Up to two LRDIMMs can be populated per channel regardless of rank count.
- A maximum of two different ranked DIMMs can be populated in a channel regardless of rank count.
- If memory modules with different speeds are installed, they will operate at the speed of the slowest installed memory module(s).
- Populate memory module sockets only if a processor is installed.
 - For single-processor systems, sockets A1 to A12 are available.
 - For dual-processor systems, sockets A1 to A12 and sockets B1 to B12 are available.
- Populate all the sockets with white release tabs first, followed by the black release tabs.
- When mixing memory modules with different capacities, populate the sockets with memory modules with the highest capacity first.

i **NOTE:** For example, if you want to mix 8 GB and 16 GB memory modules, populate 16 GB memory modules in the sockets with white release tabs and 8 GB memory modules in the sockets with black release tabs.

- Memory modules of different capacities can be mixed provided other memory population rules are followed.

i **NOTE:** For example, 8 GB and 16 GB memory modules can be mixed.

- In a dual-processor configuration, the memory configuration for each processor must be identical.

NOTE: For example, if you populate socket A1 for processor 1, then populate socket B1 for processor 2, and so on.

- Mixing of more than two memory module capacities in one system is not supported.
 - Unbalanced memory configurations will result in a performance loss so always populate memory channels identically with identical DIMMs for best performance.
 - Populate six identical memory modules per processor (one DIMM per channel) at a time to maximize performance.
- DIMM population update for Performance Optimized mode with quantity of 4 and 8 DIMMs per processor.
- When the DIMM quantity is 4 per processor, the population is slot 1, 2, 4, 5.
 - When the DIMM quantity is 8 per processor, the population is slot 1, 2, 4, 5, 7, 8, 10, 11 (2-2-2 platforms).

NVDIMM-N memory module installation guidelines

The following are the recommended guidelines for installing NVDIMM-N memory modules:

- Each system supports memory configurations with 1, 2, 4, 6, or 12 NVDIMM-Ns.
- Supported configurations have dual processors and a minimum of 12x RDIMMs.
- Maximum of 12 NVDIMM-Ns can be installed in a system.
- NVDIMM-Ns or RDIMMs must not be mixed with LRDIMMs.
- DDR4 NVDIMM-Ns must be populated only on the black release tabs on processor 1 and 2.
- All slots on configurations 3, 6, 9, and 12 can be used, but a maximum of 12 NVDIMM-Ns can be installed in a system.

NOTE: NVDIMM-N memory slots are not hot-pluggable.

For more information about the supported NVDIMM-N configurations, see the *NVDIMM-N User Guide* at www.dell.com/poweredgemanuals.

Table 15. Supported NVDIMM-N for dual processor configurations

Configuration	Description	Memory population rules	
		RDIMMs	NVDIMM-N
Configuration 1	12x 16 GB RDIMMs, 1x NVDIMM-N	Processor1 {A1, 2, 3, 4, 5, 6} Processor2 {B1, 2, 3, 4, 5, 6}	Processor1 {A7}
Configuration 2	12x 32 GB RDIMMs, 1x NVDIMM-N	Same for all 12x RDIMM configurations. See Configuration 1.	Processor1 {A7}
Configuration 3	23x 32 GB RDIMMs, 1x NVDIMM-N	Processor1 {A1, 2, 3, 4, 5, 6, 7, 8, 9, 10, 11, 12} Processor2 {B1, 2, 3, 4, 5, 6, 7, 8, 9, 10, 11}	Processor2 {B12}
Configuration 4	12x 16 GB RDIMMs, 2x NVDIMM-Ns	Same for all 12x RDIMM configurations. See Configuration 1.	Processor1 {A7} Processor2 {B7}
Configuration 5	12x 32 GB RDIMMs, 2x NVDIMM-Ns	Same for all 12x RDIMM configurations. See Configuration 1.	Processor1 {A7} Processor2 {B7}
Configuration 6	22x 32 GB RDIMMs, 2x NVDIMM-Ns	Processor1 {A1, 2, 3, 4, 5, 6, 7, 8, 9, 10, 11} Processor2 {B1, 2, 3, 4, 5, 6, 7, 8, 9, 10, 11}	Processor1 {A12} Processor2 {B12}
Configuration 7	12x 16 GB RDIMMs, 4x NVDIMM-Ns	Same for all 12x RDIMM configurations. See Configuration 1.	Processor1 {A7, A8} Processor2 {B7, B8}

Table 15. Supported NVDIMM-N for dual processor configurations (continued)

Configuration	Description	Memory population rules	
		RDIMMs	NVDIMM-N
Configuration 8	22x 32 GB RDIMMs, 4x NVDIMM-Ns	Same for all 12x RDIMM configurations. See Configuration 1.	Processor1 {A7, A8} Processor2 {B7, B8}
Configuration 9	20x 32 GB RDIMMs, 4x NVDIMM-Ns	Processor1 {A1, 2, 3, 4, 5, 6, 7, 8, 9, 10} Processor2 {B1, 2, 3, 4, 5, 6, 7, 8, 9, 10}	Processor1 {A11, 12} Processor2 {B11, 12}
Configuration 10	12x 16 GB RDIMMs, 6x NVDIMM-Ns	Same for all 12x RDIMM configurations. See Configuration 1.	Processor1 {A7, 8, 9} Processor2 {B7, 8, 9}
Configuration 11	12x 32 GB RDIMMs, 6x NVDIMM-Ns	Same for all 12x RDIMM configurations. See Configuration 1.	Processor1 {A7, 8, 9} Processor2 {B7, 8, 9}
Configuration 12	18x 32 GB RDIMMs, 6x NVDIMM-Ns	Processor1 {1, 2, 3, 4, 5, 6, 7, 8, 9} Processor2 {1, 2, 3, 4, 5, 6, 7, 8, 9}	Processor1 {A10, 11, 12} Processor2 {B10, 11, 12}
Configuration 13	12x 16 GB RDIMMs, 12x NVDIMM-Ns	Same for all 12x RDIMM configurations. See Configuration 1.	Processor1 {A7, 8, 9, 10, 11, 12} Processor2 {B7, 8, 9, 10, 11, 12}
Configuration 14	12x 32 GB RDIMMs, 12x NVDIMM-Ns	Same for all 12x RDIMM configurations. See Configuration 1.	Processor1 {A7, 8, 9, 10, 11, 12} Processor2 {B7, 8, 9, 10, 11, 12}

Mode-specific guidelines

The configurations allowed depend on the memory mode selected in the System BIOS.

Table 16. Memory operating modes

Memory Operating Mode	Description
Optimizer Mode	The Optimizer Mode if enabled, the DRAM controllers operate independently in the 64-bit mode and provide optimized memory performance.
Mirror Mode	The Mirror Mode if enabled, the system maintains two identical copies of data in memory, and the total available system memory is one half of the total installed physical memory. Half of the installed memory is used to mirror the active memory modules. This feature provides maximum reliability and enables the system to continue running even during a catastrophic memory failure by switching over to the mirrored copy. The installation guidelines to enable Mirror Mode require that the memory modules be identical in size, speed, and technology, and they must be populated in sets of 6 per processor.
Single Rank Spare Mode	Single Rank Spare Mode allocates one rank per channel as a spare. If excessive correctable errors occur in a rank or channel, while the operating system is running, they are moved to the spare area to prevent errors from causing an uncorrectable failure. Requires two or more ranks to be populated in each channel.

Table 16. Memory operating modes (continued)

Memory Operating Mode	Description
Multi Rank Spare Mode	<p>Multi Rank Spare Mode allocates two ranks per channel as a spare. If excessive correctable errors occur in a rank or channel, while the operating system is running, they are moved to the spare area to prevent errors from causing an uncorrectable failure. Requires three or more ranks to be populated in each channel.</p> <p>With single rank memory sparing enabled, the system memory available to the operating system is reduced by one rank per channel.</p> <p>For example, in a dual-processor configuration with 24x 16 GB dual-rank memory modules, the available system memory is: $\frac{3}{4}$ (ranks/channel) \times 24 (memory modules) \times 16 GB = 288 GB, and not 24 (memory modules) \times 16 GB = 384 GB. For multi rank sparing, the multiplier changes to $\frac{1}{2}$ (ranks/channel).</p> <p>NOTE: To use memory sparing, this feature must be enabled in the BIOS menu of System Setup.</p> <p>NOTE: Memory sparing does not offer protection against a multi-bit uncorrectable error.</p>
Dell Fault Resilient Mode	<p>The Dell Fault Resilient Mode if enabled, the BIOS creates an area of memory that is fault resilient. This mode can be used by an OS that supports the feature to load critical applications or enables the OS kernel to maximize system availability.</p> <p>NOTE: This feature is only supported in Gold and Platinum Intel processors.</p> <p>NOTE: Memory configuration has to be of same size DIMM, speed, and rank.</p>

Optimizer Mode

This mode supports Single Device Data Correction (SDDC) only for memory modules that use x4 device width. It does not impose any specific slot population requirements.

- Dual processor: Populate the slots in round robin sequence starting with processor 1.

NOTE: Processor 1 and processor 2 population should match.

Table 17. Memory population rules

Processor	Configuration	Memory population	Memory population information
Single processor	Optimizer (Independent channel) population order	1, 2, 3, 4, 5, 6, 7, 8, 9, 10, 11, 12	<ul style="list-style-type: none"> DIMMs must be populated in the order specified. Odd number of DIMM population is allowed NOTE: Odd number of DIMMs will result in unbalanced memory configurations, which in turn will result in performance loss. It is recommended to populate all memory channels identically with identical DIMMs for best performance. Optimizer population order is not traditional for 4 and 8 DIMM installations of single processor. <ul style="list-style-type: none"> For 4 DIMMs: A1, A2, A4, A5 For 8 DIMMs: A1, A2, A4, A5, A7, A8, A10, A11
	Mirror population order	{1, 2, 3, 4, 5, 6} {7, 8, 9, 10, 11, 12}	Mirroring is supported with 6 or 12 DIMMs per processor.

Table 17. Memory population rules (continued)

Processor	Configuration	Memory population	Memory population information
	Single rank sparing population order	1, 2, 3, 4, 5, 6, 7, 8, 9, 10, 11, 12	<ul style="list-style-type: none"> • DIMMs must be populated in the order specified. • Requires two ranks or more per channel.
	Multi rank sparing population order	1, 2, 3, 4, 5, 6, 7, 8, 9, 10, 11, 12	<ul style="list-style-type: none"> • DIMMs must be populated in the order specified. • Requires three ranks or more per channel.
	Fault resilient population order	{1, 2, 3, 4, 5, 6} {7, 8, 9, 10, 11, 12}	Supported with 6 or 12 DIMMs per processor.
Dual processor (Start with processor1. processor1 and processor 2 population should match)	Optimized (Independent channel) population order	A{1}, B{1}, A{2}, B{2}, A{3}, B{3}, A{4}, B{4}, A{5}, B{5}, A{6}, B{6}	<p>Odd number of DIMM population per processor is allowed.</p> <p>i NOTE: Odd number of DIMMs will result in unbalanced memory configurations, which in turn will result in performance loss. It is recommended to populate all memory channels identically with identical DIMMs for best performance.</p> <p>Optimizer population order is not traditional for 8 and 16 DIMMs installations for dual processor.</p> <ul style="list-style-type: none"> • For 8 DIMMs: A1, A2, A4, A5, B1, B2, B4, B5 • For 16 DIMMs: A1, A2, A4, A5, A7, A8, A10, A11 B1, B2, B4, B5, B7, B8, B10, B11
	Mirroring population order	A{1, 2, 3, 4, 5, 6}, B{1, 2, 3, 4, 5, 6}, A{7, 8, 9, 10, 11, 12}, B{7, 8, 9, 10, 11, 12}	Mirroring is supported with 6 or 12 DIMMs per processor.
	Single rank sparing population order	A{1}, B{1}, A{2}, B{2}, A{3}, B{3}, A{4}, B{4}, A{5}, B{5}, A{6}, B{6}	<ul style="list-style-type: none"> • DIMMs must be populated in the order specified. • Requires two ranks or more per channel.
	Multi rank sparing population order	A{1}, B{1}, A{2}, B{2}, A{3}, B{3}, A{4}, B{4}, A{5}, B{5}, A{6}, B{6}	<ul style="list-style-type: none"> • DIMMs must be populated in the order specified. • Requires three ranks or more per channel.
	Fault resilient population order	A{1, 2, 3, 4, 5, 6}, B{1, 2, 3, 4, 5, 6}, A{7, 8, 9, 10, 11, 12}, B{7, 8, 9, 10, 11, 12}	Supported with 6 or 12 DIMMs per processor.

Removing a memory module

The procedure for removing a DIMM module and an NVDIMM-N module is identical.

Prerequisites

1. Follow the safety guidelines listed in [Safety instructions](#) on page 27.

2. Follow the procedure listed in [Before working inside your system](#) on page 28.

CAUTION: To prevent data loss and potential damage to your system, ensure that your system, LEDs on system, LEDs on NVDIMM-N and LEDs on NVDIMM-N battery are turned off before removing the NVDIMM-N battery.

3. Remove the air shroud.

WARNING: Allow the memory modules to cool after you power off the system. Handle the memory modules by the card edges and avoid touching the components or metallic contacts on the memory module.

CAUTION: To ensure proper system cooling, memory module blanks must be installed in any memory socket that is not occupied. Remove memory module blanks only if you intend to install memory modules in those sockets.

Steps

1. Locate the appropriate memory module socket.

CAUTION: Handle each memory module only by the card edges, ensuring not to touch the middle of the memory module or metallic contacts.

2. Push the ejectors outward on both ends of the memory module socket to release the memory module from the socket.

3. Lift and remove the memory module from the system.

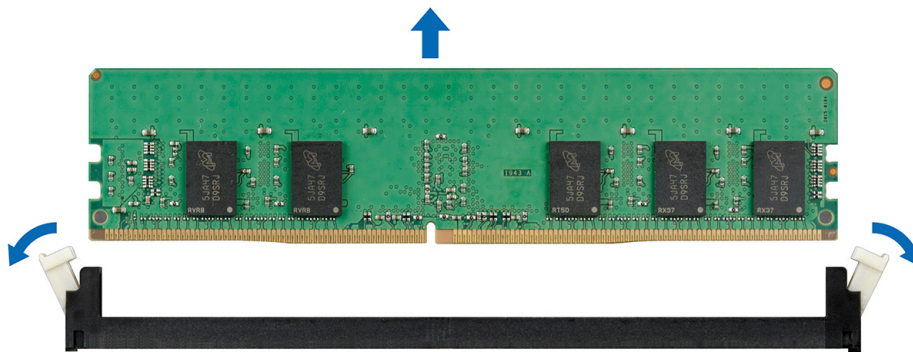

Figure 63. Removing a memory module

Next steps

1. [Install the memory module.](#)

2. If you are removing the memory module permanently, install a memory module blank. The procedure to install a memory module blank is similar to that of the memory module.

Installing a memory module

The procedure for installing a DIMM module and an NVDIMM-N module is identical.

Prerequisites

Follow the safety guidelines listed in [Safety instructions](#) on page 27.

CAUTION: Ensure that you install the NVDIMM-N battery if you are using NVDIMM-N.

CAUTION: To prevent data loss and potential damage to your system, ensure that your system, LEDs on system, LEDs on NVDIMM-N and LEDs on NVDIMM-N battery are turned off before installing the NVDIMM-N battery.

CAUTION: To ensure proper system cooling, memory module blanks must be installed in any memory socket that is not occupied. Remove memory module blanks only if you intend to install memory modules in those sockets.

Steps

1. Locate the appropriate memory module socket.

CAUTION: Handle each memory module only by the card edges, ensuring not to touch the middle of the memory module or metallic contacts.

CAUTION: To prevent damage to the memory module or the memory module socket during installation, do not bend or flex the memory module. You must insert both ends of the memory module simultaneously.

2. Open the ejectors on the memory module socket outward to allow the memory module to be inserted into the socket.
3. Align the edge connector of the memory module with the alignment key of the memory module socket, and insert the memory module in the socket.

CAUTION: Do not apply pressure at the center of the memory module; apply pressure at both ends of the memory module evenly.

NOTE: The memory module socket has an alignment key that enables you to install the memory module in the socket in only one orientation.

4. Press the memory module with your thumbs until the socket levers firmly click into place.

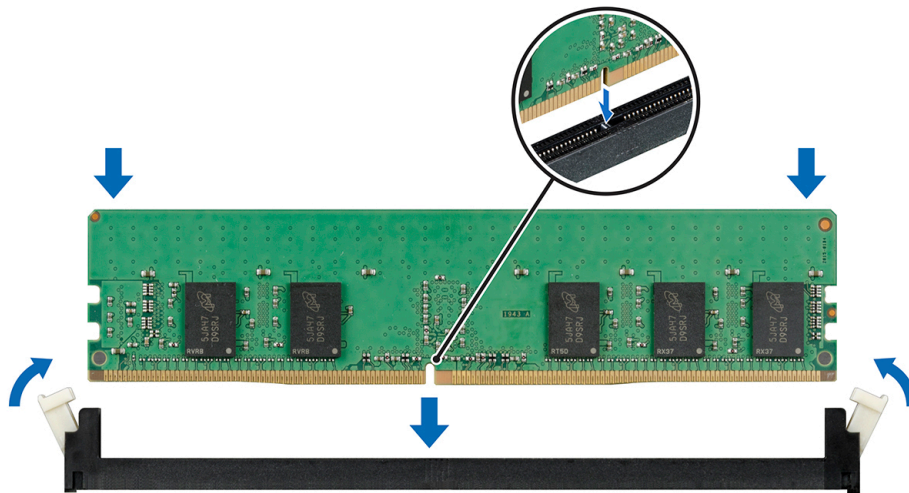

Figure 64. Installing a memory module

For more information on the memory slot locations, see the System memory population topic.

Next steps

1. [Install the air shroud.](#)
2. Follow the procedure listed in [After working inside your system](#) on page 28.
3. To verify if the memory module has been installed properly, press F2 and navigate to **System Setup Main Menu > System BIOS > Memory Settings**. In the **Memory Settings** screen, the System Memory Size must reflect the updated capacity of the installed memory.
4. If the value is incorrect, one or more of the memory modules may not be installed properly. Ensure that the memory module is firmly seated in the memory module socket.
5. Run the system memory test in system diagnostics.

Processors and heat sinks

Removing a processor and heat sink module

Prerequisites

WARNING: The heat sink may be hot to touch for some time after the system is powered down. Allow the heat sink to cool before removing it.

NOTE: For a processor greater than 150 W, you need to use high performance heat sink and processor module.

1. Follow the safety guidelines listed in [Safety instructions](#) on page 27.
2. Follow the procedure listed in [Before working inside your system](#) on page 28.
3. [Remove the air shroud.](#)

Steps

1. Using a Torx #T30 screwdriver, loosen the screws on the heat sink in the order below:
 - a. Loosen the first screw three turns.
 - b. Loosen the second screw completely.
 - c. Return to the first screw and loosen it completely.
2. Pushing both blue retention clips simultaneously, lift the processor and heat sink module (PHM).
3. Set the PHM aside with the processor side facing up.

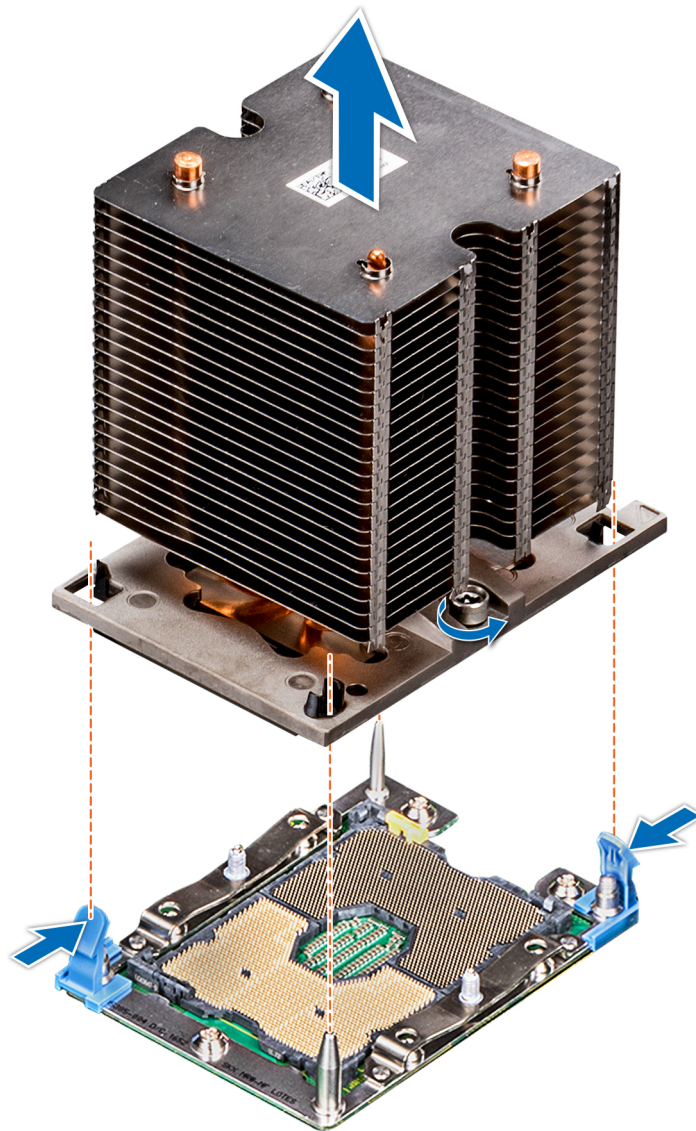

Figure 65. Removing the processor and heat sink module

Next steps

1. [Install the PHM.](#)

Removing the processor from the processor and heat sink module

Prerequisites

i **NOTE:** Only remove the processor from the processor and heat sink module if you are replacing the processor or heat sink. This procedure is not required when replacing a system board.

1. Follow the safety guidelines listed in [Safety instructions](#) on page 27.
2. Follow the procedure listed in [Before working inside your system](#) on page 28.
3. [Remove the air shroud.](#)
4. [Remove the processor and heat sink module.](#)

Steps

1. Place the heat sink with the processor side facing up.
2. Insert a flat blade screwdriver into the release slot marked with a yellow label. Twist (do not pry) the screwdriver to break the thermal paste seal.
3. Push the retaining clips on the processor bracket to unlock the bracket from the heat sink.

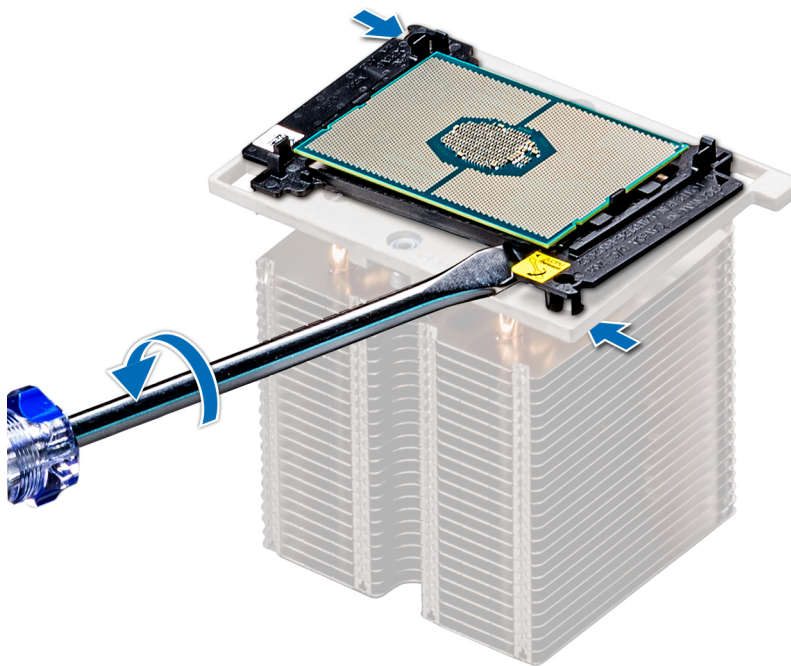

Figure 66. Loosening the processor bracket

4. Lift the bracket and the processor away from the heat sink, and place the processor connector side down on the processor tray.
5. Flex the outer edges of the bracket to release the bracket from the processor.

i **NOTE:** Ensure that the processor and the bracket are placed in the tray after you remove the heat sink.



Figure 67. Removing the processor bracket

Next steps

1. [Install the processor into the processor and heat sink module.](#)

Installing the processor into a processor and heat sink module

Prerequisites

Follow the safety guidelines listed in [Safety instructions](#) on page 27.

Steps

1. Place the processor in the processor tray.

i **NOTE:** Ensure that the pin 1 indicator on the processor tray is aligned with the pin 1 indicator on the processor.

2. Flex the outer edges of the bracket around the processor ensuring that the processor is locked into the clips on the bracket.

i **NOTE:** Ensure that the pin 1 indicator on the bracket is aligned with the pin 1 indicator on the processor before placing the bracket on the processor.

i **NOTE:** Ensure that the processor and the bracket are placed in the tray before you install the heat sink.



Figure 68. Installing the processor bracket

3. If you are using an existing heat sink, remove the thermal grease from the heat sink by using a clean lint-free cloth.
4. Use the thermal grease syringe included with your processor kit to apply the grease in a quadrilateral design on the top of the processor.

CAUTION: Applying too much thermal grease can result in excess grease coming in contact with and contaminating the processor socket.

NOTE: The thermal grease syringe is intended for single use only. Dispose the syringe after you use it.

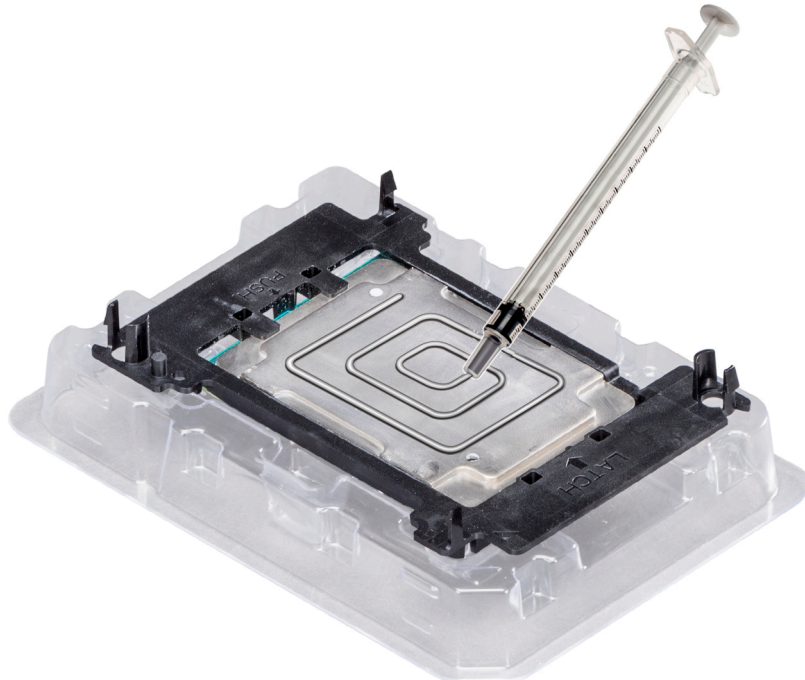

Figure 69. Applying thermal grease on top of the processor

5. Place the heat sink on the processor and push down on the base of the heat sink until the bracket locks onto the heat sink.

NOTE:

- Ensure that the two guide pin holes on the bracket match the guide holes on the heat sink.

- Do not press on the heat sink fins.
- Ensure that the pin 1 indicator on the heat sink is aligned with the pin 1 indicator on the bracket before placing the heat sink onto the processor and bracket.

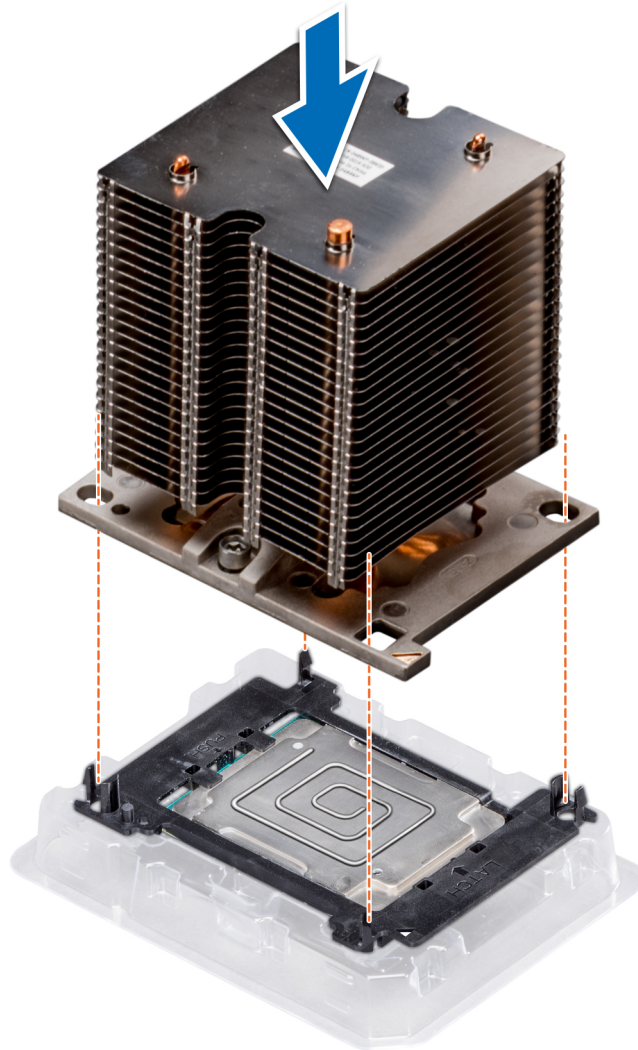

Figure 70. Installing the heat sink onto the processor

Next steps

1. Install the processor and heat sink module.
2. Install the air shroud.
3. Follow the procedure listed in [After working inside your system](#) on page 28.

Installing a processor and heat sink module

Prerequisites

CAUTION: Never remove the heat sink from a processor unless you intend to replace the processor. The heat sink is necessary to maintain proper thermal conditions.

1. Follow the safety guidelines listed in [Safety instructions](#).
2. If installed, remove the processor blank and CPU dust cover.

Steps

1. Align the pin 1 indicator of the heat sink to the system board and then place the processor and heat sink module (PHM) on the processor socket.

 **CAUTION:** To avoid damaging the fins on the heat sink, do not press down on the heat sink fins.

 **NOTE:** Ensure that the PHM is held parallel to the system board to prevent damaging the components.

2. Push the blue retention clips inward to allow the heat sink to drop into place.
3. Using the Torx #T30 screwdriver, tighten the screws on the heat sink in the order below:
 - a. Partially tighten the first screw (approximately 3 turns).
 - b. Tighten the second screw completely.
 - c. Return to the first screw and tighten it completely.

If the PHM slips off the blue retention clips when the screws are partially tightened, follow these steps to secure the PHM:

- a. Loosen both the heat sink screws completely.
- b. Lower the PHM on to the blue retention clips, following the procedure described in step 2.
- c. Secure the PHM to the system board, following the replacement instructions listed in this step above. 4.

 **NOTE:** The processor and heat sink module retention screws should not be tightened to more than 0.13 kgf-m (1.35 N.m or 12 in-lbf).

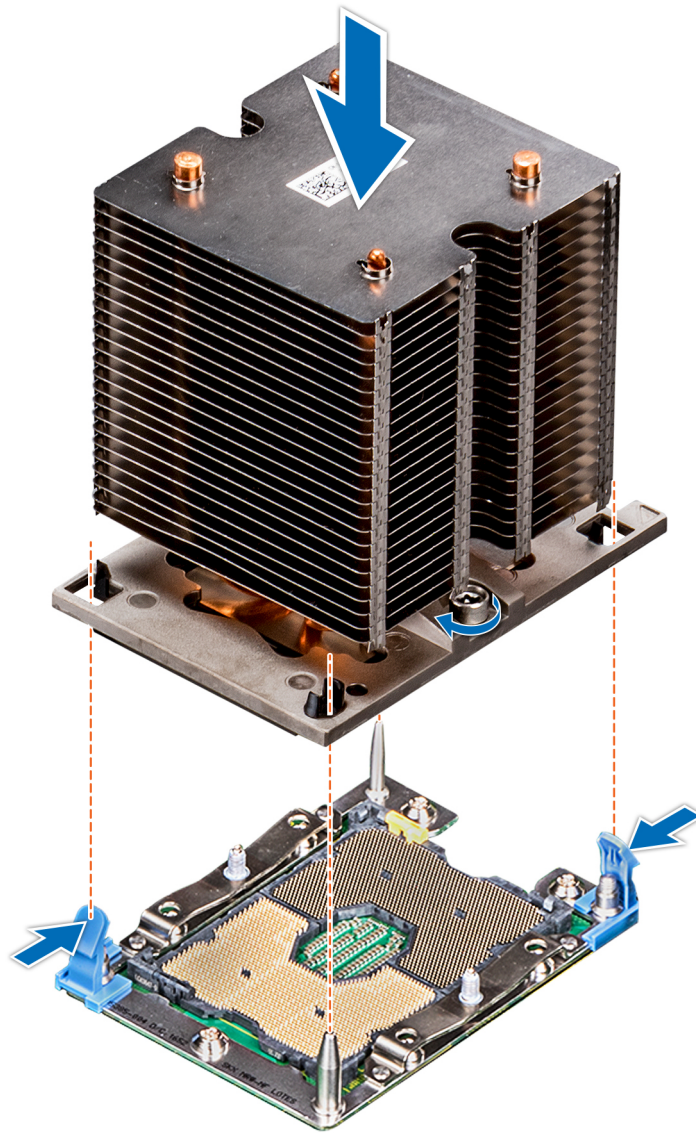

Figure 71. Installing a processor and heat sink module

Next steps

1. Follow the procedure listed in [After working inside your system](#) on page 28.

Expansion card holder

Removing the expansion card holder

Prerequisites

1. Follow the safety guidelines listed in [Safety instructions](#) on page 27.
2. Follow the procedure listed in [Before working inside your system](#) on page 28.

Steps

1. Press the tab and slide the expansion card holder up.
2. Lift the expansion card holder away from the chassis.

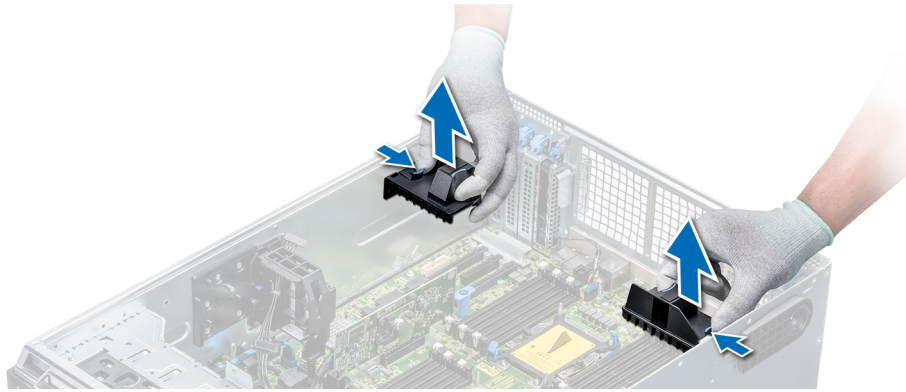

Figure 72. Removing the expansion card holder

Next steps

1. [Install the expansion card holder.](#)

Installing the expansion card holder

Prerequisites

Follow the safety guidelines listed in [Safety instructions](#) on page 27.

Steps

Align the expansion card holder with the guide pins on the system and push it down until it locks in place.

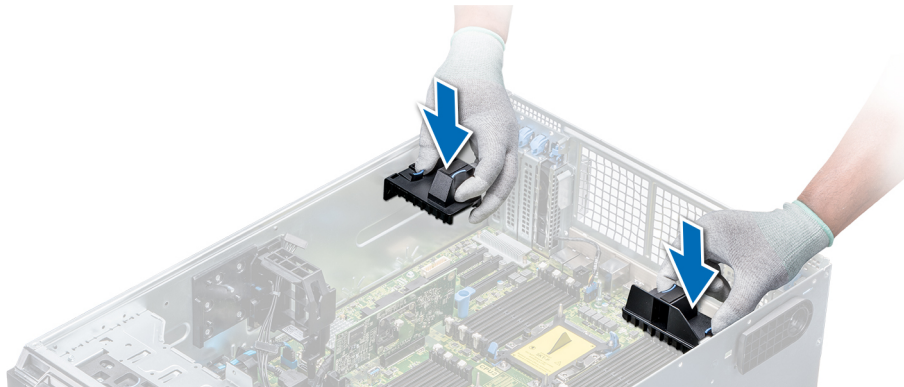

Figure 73. Installing the expansion card holder

Next steps

1. Follow the procedure listed in [After working inside your system](#) on page 28.

GPU card holder (optional)

GPU card restriction

The restrictions for GPU card is listed below:

- Requires cooling fan assembly (middle high-performance fans) and 1 or 2 external fans.

- If a GPU is installed in slot 1, 3, the right external fan is required. If a GPU is installed in slot 6, 8, both external fans are required.
- Two external fans are required for GPU-ready SKUs, there is no SKU with left external fan only.
- If a GPU is installed on slot 1 or 3, only one 5.25 inch RMSD device (ODD/RD1000/half-height tape) is supported.
- Four single width GPUs cannot be supported if the second PERC with battery (H730/H730P/H830).
- 300 W GPUs only support the maximum ambient temperature of 30°C.
- GPU is not supported for 3.5 inch x 18 chassis and fresh air condition.
- GPU is only supported in rack mode.
- The left and right external fans are required when a GPU is installed in slots 6 and 8.

 **NOTE:** This system supports up to 2 x NVIDIA M10 GPUs.

GPU card installation guidelines

Observe the following guidelines while installing a GPU card:

- GPU are supported only in the Rack mode configuration.
- GPU can be installed only on systems that have 1100 W or higher power supply units.
- Each GPU card supports up to 32 GB of dedicated GDDR5 memory.
- Two double-width GPU cards on a single processor configuration and four double width GPU cards on a dual processor configuration do not support any other add-on cards.
- The GPU cards must be installed:
 - On GPU enabled system (two processor and also contains the main air shroud and GPU air shrouds).
 - On systems with eight fan configuration (Fan1, Fan2 are standard (STD) fans. Fan3-Fan6 are high-performance (HPR) fans. Fan7 and Fan8 are external Left and Right fans).
- Specific GPU cards will need the use of the dongle power cable.

Removing the optional GPU card holder

Prerequisites

1. Follow the safety guidelines listed in [Safety instructions](#) on page 27.
2. Follow the procedure listed in [Before working inside your system](#) on page 28.
3. [Remove the air shroud](#).

Steps

Press the release tab and slide the graphical processing unit (GPU) card holder out of the chassis.

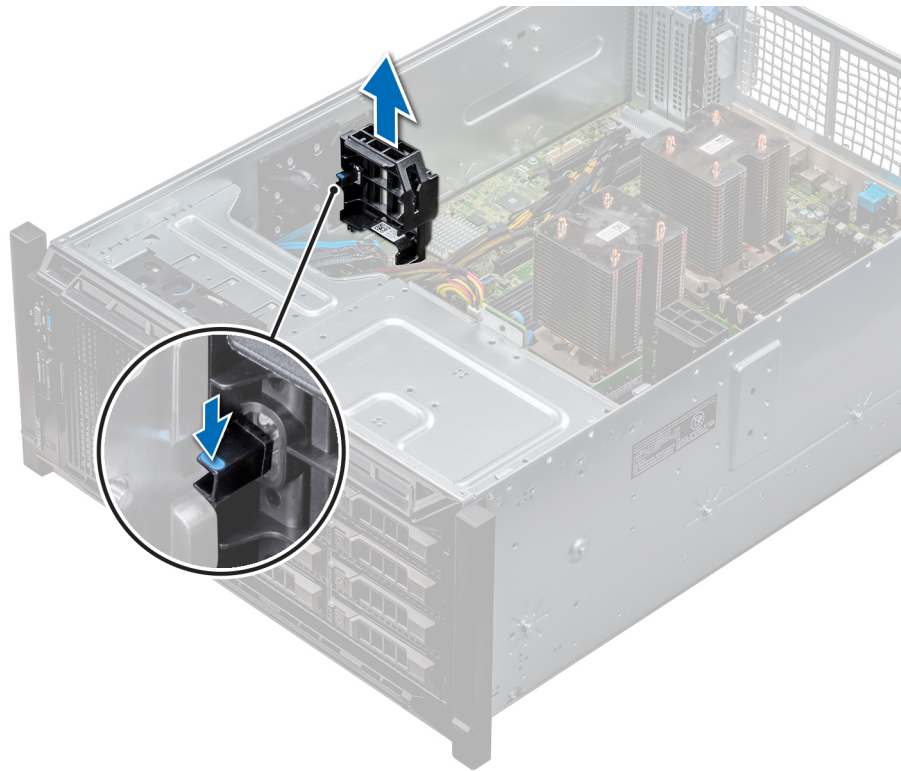

Figure 74. Removing the GPU card holder

Next steps

1. [Install the optional GPU card holder.](#)

Installing the optional GPU card holder

Prerequisites

Follow the safety guidelines listed in [Safety instructions](#) on page 27.

Steps

Align the GPU card holder with the slots and the guide pin on the system, and push the GPU card holder down until it locks in place.



Figure 75. Installing the optional GPU card holder

Next steps

1. [Install the air shroud.](#)
2. Follow the procedure listed in [After working inside your system](#) on page 28.

Expansion cards

Expansion card installation guidelines

The following table describes the supported expansion cards:

Table 18. Supported PCI express generation 3 expansion cards

PCIe Slot	Processor Connection	Height	Length	Link Width	Slot Width
0 (Gen3) (dedicated for PERC or HBA)	Processor 1	-	Half Length	x8	x8
1 (Gen3)	Processor 1	Standard Height	Full Length	x16	x16
2 (Gen3)	Processor 1	Standard Height	Full Length	x4	x8
3 (Gen3)	Processor 1	Standard Height	Full Length	x16	x16
4 (Gen3)	Processor 2	Standard Height	Half Length	x8	x8
5 (Gen3)	Processor 2	Standard Height	Full Length	x4	x8
6 (Gen3)	Processor 2	Standard Height	Full Length	x16	x16
7 (Gen3)	Processor 2	Standard Height	Full Length	x8	x8
8 (Gen3)	Processor 2	Standard Height	Full Length	x16	x16

NOTE: To use PCIe slots 4-8, both the processors must be installed.

NOTE: The expansion-card slots are not hot-swappable.

Expansion card slot priority

The following table describes the installation order for installing expansion cards to ensure proper cooling and mechanical fit. The expansion cards with the highest priority must be installed first by using the slot priority indicated.

NOTE: To use PCIe slots 4, 5, 6, 7, and 8, both the processors must be installed.

NOTE: The expansion card slots are not hot-swappable.

NOTE: To use PCIe cards with external I/O in slots 1, 2, 3, right external fan must not be installed, and to use PCIe cards with external I/O in slots 5, 6, 7, 8, left external fan must not be installed.

Table 19. Expansion card installation order

System Configuration	Card Priority	Card Type	Slot Priority	Maximum Allowed
1 or 2 CPU, no GPU (no external fan)	1	Dell PowerEdge Express Flash (PCIe SSD) Bridge	1, 3	2
	2	RAID (H330), RAID (H730P)	0	1
		RAID (H740P)	0, 1	2
		RAID (H840), BOSS	4, 7, 1, 6, 8	5
	3	Intel OPA NIC	1, 6	3
		Mellanox CX4 DP 100 Gb NICs*	8, 1, 6, 3	4
		Mellanox CX4 SP 100 Gb NIC*	8	1
	4	Intel 40 Gb NIC	4, 7, 1, 6, 8, 3	6
		Mellanox DP 40 Gb NIC*	8, 4, 7, 1, 6	5
		Mellanox SP 25 Gb NIC	4, 7, 1, 6, 8	5
		Intel DP 25 Gb NIC, Qlogic DP 25 Gb NIC	4, 7, 1, 6	4
		Broadcom DP 25 Gb NIC	4, 7, 1, 6, 8, 3	6
	5	FC32 HBAs, FC16 HBAs	4, 7, 1, 6, 8	5
	6	Intel QP 10 Gb Base-T NIC*	8	1
	7	Intel DP 10 Gb Base-T NIC, Intel 4x 10 Gb SFP+ NIC, Broadcom DP 10 Gb 57416 NIC, Qlogic DP 10 Gb SFP V2 NIC, Mellanox DP 10 Gb SFP+ NIC	4, 7, 1, 6, 8	5
		Intel DP 10 Gb SFP+ NICs, Broadcom DP 10 Gb 57412 NIC, Qlogic QLGX 10 Gb NICs	4, 7, 1, 6, 8, 3	6
		Solarflare DP 10 Gb NICs*, Qlogic DP 10 Gb V1 NIC*	8, 4, 1, 7, 6	5
		Qlogic DP 10 Gb SFP V1 NIC, Qlogic DP 10 Gb V2 NIC	4, 7, 1, 6	4
	8	FC8 HBAs	4, 7, 1, 6, 8, 5, 3, 2	8
	9	12G SAS HBA	4, 7, 1, 6, 8, 3	6
		HBA330	0, 1, 3	2

Table 19. Expansion card installation order (continued)

System Configuration	Card Priority	Card Type	Slot Priority	Maximum Allowed	
	10	PCIe SSD	8, 4, 7, 1, 6	5	
2 CPU, 1 External fan (Right)	1	GPUs	3, 1	2	
		RAID (H330), RAID (H730)	0	1	
		RAID (H740)	0, 1, 3	2	
		RAID (H840)	7, 8, 6, 4	4	
		BOSS	1, 3, 7, 8, 6, 4	6	
		100 Gb NICs	8, 6	4	
	3	40 Gb NICs, 25 Gb NICs	7, 8, 6, 4	4	
	4	FC32 HBAs, FC16 HBAs	7, 8, 6, 4	4	
	5	10 Gb NICs	7, 8, 6, 4	4	
	6	FC8 HBAs	7, 8, 6, 4	4	
	7	1 Gb NICs	7, 8, 6, 4	4	
	8	12Gb SAS HBA	7, 8, 6, 4	4	
	9	HBA330	0, 1, 3	2	
	10	PCIe SSD	1, 3, 7, 8, 6, 4	6	
2 CPU, 2 External fans	1	Dell PowerEdge Express Flash (PCIe SSD) Bridge	1, 3	2	
		GPUs	3, 6, 8, 1	4	
		RAID (H330), RAID (H730)	0	1	
		RAID (H740)	0, 1, 3	2	
		RAID (H840)	4	1	
		BOSS	1, 3, 7, 8, 6, 4	6	
		3	NICs	4	1
		4	12Gb SAS HBA	4	1
			HBA330	0, 1, 3	2
		5	PCIe SSD	1, 3, 7, 8, 6, 4	6

NOTE: The PCIe cards with * require the cooling fan assembly (middle fans) to support.

NOTE: Without external fans, Mellanox CX4 SP 100 Gb NIC and Intel QP 10 Gb Base-T NIC are only allowed on slot 8 and 2 CPU configuration.

Removing a expansion card

Prerequisites

1. Follow the safety guidelines listed in [Safety instructions](#) on page 27.
2. Follow the procedure listed in [Before working inside your system](#) on page 28.
3. [Remove the air shroud.](#)
4. [Remove the expansion card holder.](#)

Steps

1. If installed, disconnect the data cables from the PERC card and/or the power cables from the GPU card.
2. Press the expansion card latch and push down the latch to open it.
3. Hold the expansion card by its edge, and pull the card up to remove it from the expansion card connector and the system.
4. Install the filler brackets by performing the following steps:
 - a. Align the slot on the filler bracket with the tab on the expansion card slot.
 - b. Press the expansion card latch till the filler bracket locks into place.

NOTE: Filler brackets must be installed in empty expansion-card slots to maintain FCC certification of the system. The brackets also keep dust and dirt out of the system and aid in proper cooling and airflow inside the system.

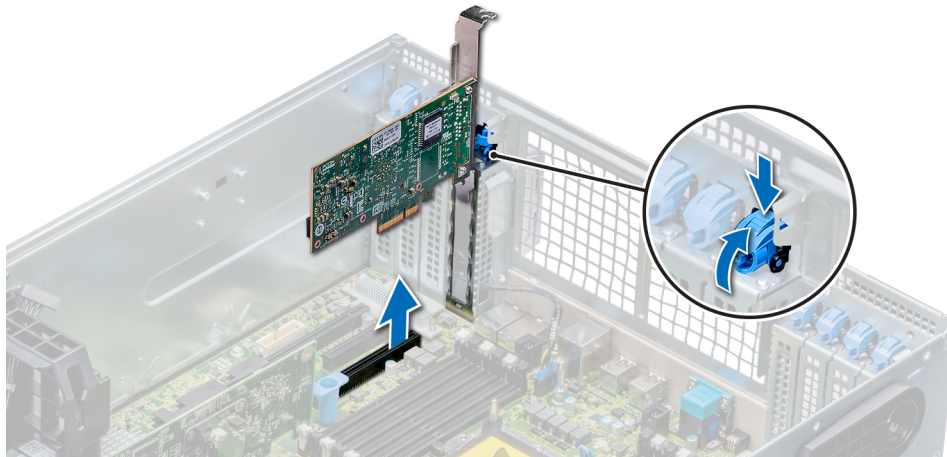

Figure 76. Removing an expansion card

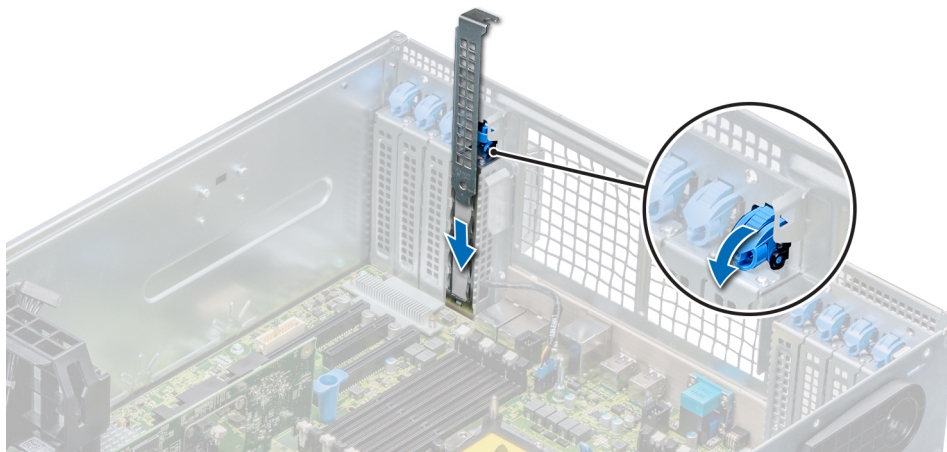

Figure 77. Installing the filler bracket

Next steps

1. [Install an expansion card.](#)

Installing an expansion card

Prerequisites

1. Follow the safety guidelines listed in [Safety instructions](#) on page 27.
2. [Remove the air shroud.](#)

3. Remove the expansion card holder.

Steps

1. Unpack the expansion card and prepare it for installation.
For instructions, see the documentation accompanying the card.
2. Open the expansion card latch adjacent to the slot you want to install the expansion card.
3. Remove the existing expansion card or filler bracket from the expansion card holder.

NOTE: Store this bracket for future use. Filler brackets must be installed in empty expansion-card slots to maintain FCC certification of the system. The brackets also keep dust and dirt out of the system and aid in proper cooling and airflow inside the system.

4. Holding the card by its edges, position the card so that the card aligns with the expansion card connector.
5. Insert the card firmly into the expansion card connector until the card is fully seated.
6. Close the expansion card latch by pushing the latch up until the latch snaps into place.
7. Connect the data cables to the expansion card and/or the power cables to the GPU card.

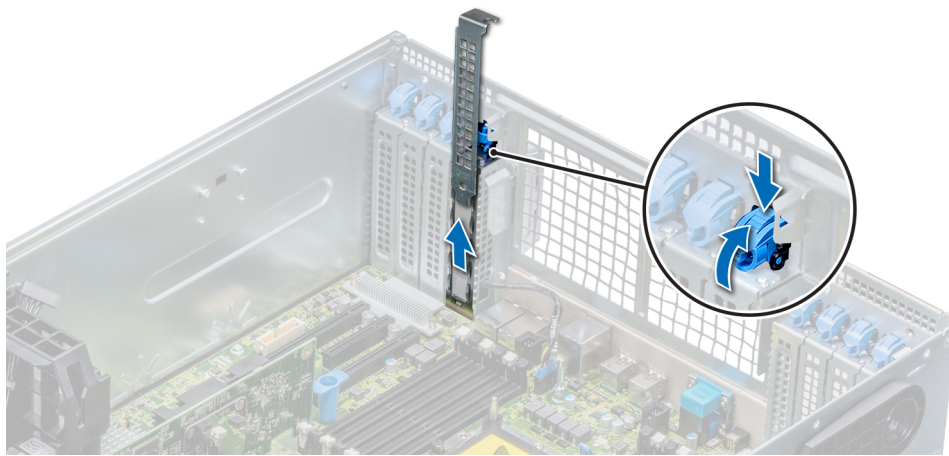

Figure 78. Removing the filler bracket

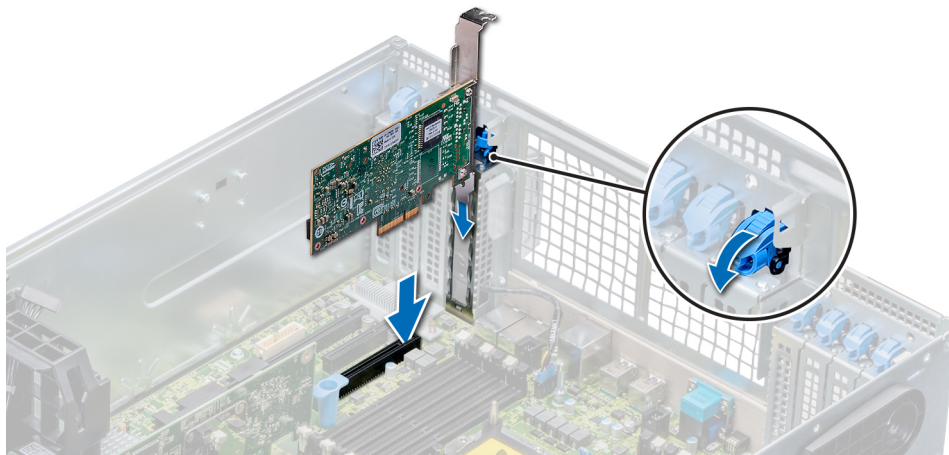

Figure 79. Installing an expansion card

Next steps

1. Install the expansion card holder.
2. Follow the procedure listed in [After working inside your system](#) on page 28.

Optional GPU card

Removing the optional GPU card

Prerequisites

1. Follow the safety guidelines listed in [safety instructions](#).
2. Follow the procedure listed in [before working inside your system](#).
3. If installed, [remove the GPU air shroud](#).
4. If installed, [remove the air shroud](#).
5. If installed, [remove the expansion card holder](#).

i **NOTE:** The optional GPU card images below are representative and may not match the actual optional GPU card to remove.

Steps

1. Press the expansion card latch and push down the latch to open it. Hold the GPU card by the edges, and pull the card until the card edge connector disengages from the connector on the expansion card slot.

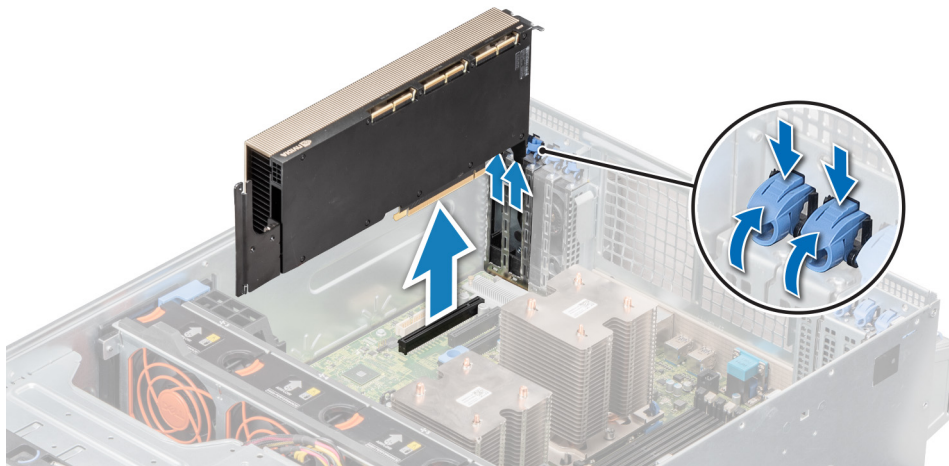

Figure 80. Removing optional GPU card

2. If you are removing the GPU card permanently, install a metal filler bracket over the empty slot opening, and close the expansion card latch.

i **NOTE:** You must install a filler bracket over an empty expansion card slot to maintain Federal Communications Commission (FCC) certification of the system. The brackets also keep dust and dirt out of the system and aid in proper cooling and airflow inside the system. The filler bracket is necessary to maintain proper thermal conditions.

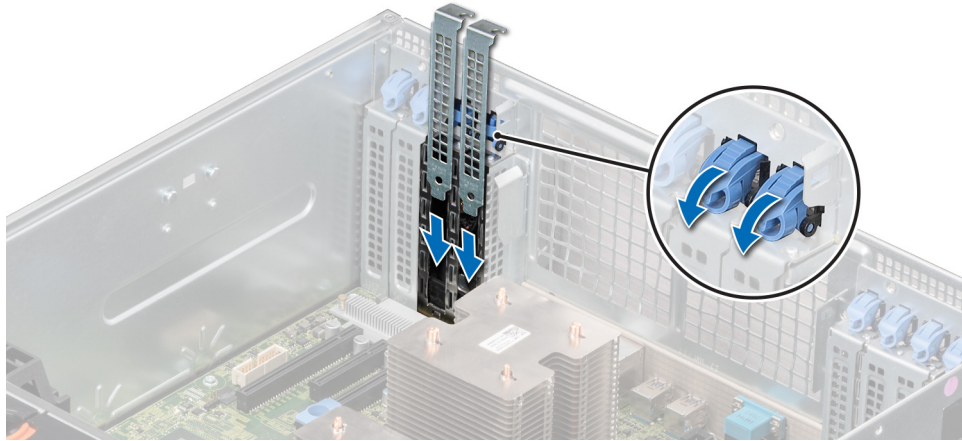

Figure 81. Installing a filler bracket

Next steps

Replace the GPU card.

Installing the optional GPU card

Prerequisites

1. Follow the safety guidelines listed in [safety instructions](#).
2. Follow the procedure listed in [before working inside your system](#).
3. If installing a new GPU card, unpack it and prepare the card for installation.
i **NOTE:** For instructions, see the documentation accompanying the card.
4. If installed, [remove the GPU air shroud](#).
5. If installed, [remove the air shroud](#).
6. If installed, [remove the expansion card holder](#).

i **NOTE:** The optional GPU card images below are representative and may not match the actual optional GPU card to install.

Steps

1. If installed, remove the metal filler bracket.
i **NOTE:** Store the metal filler bracket for future use. Filler brackets must be installed in empty expansion card slots to maintain Federal Communications Commission (FCC) certification of the system. The brackets also keep dust and dirt out of the system and aid in proper cooling and airflow inside the system.
2. Open the expansion card latch and remove the metal filler bracket from the system.

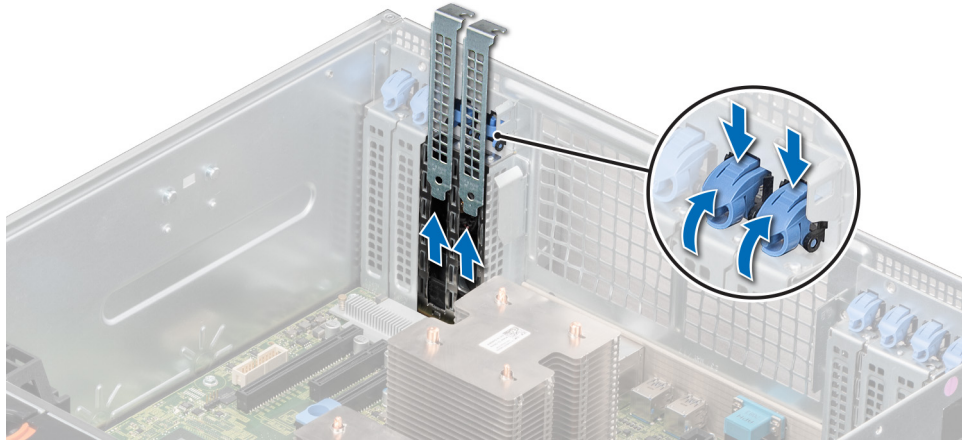

Figure 82. Removing the metal filler bracket

3. Hold the GPU card by the edges, and align the card edge connector with the expansion card connector on the system board.
4. Insert the GPU card into the expansion card slot on the system board, until it is firmly seated.

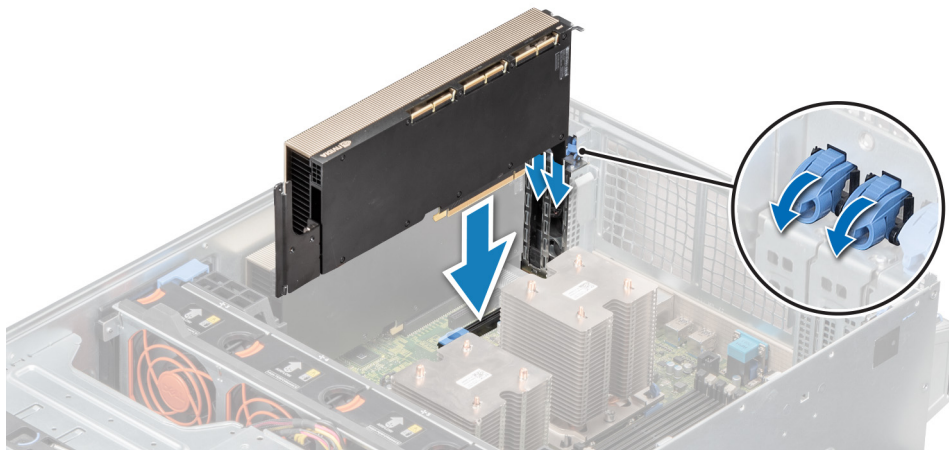

Figure 83. Installing the optional GPU card

Next steps

1. If removed, [install the GPU air shroud](#).
2. If removed, [install the air shroud](#).
3. Follow the procedure listed in [after working inside your system](#).

NVLink bridge

Removing the optional NVLink bridge

Prerequisites

1. Follow the safety guidelines listed in [safety instructions](#).
2. Follow the procedure listed in [before working inside your system](#).
3. If installed, [remove the expansion card holder](#).
4. If installed, [remove the air shroud](#).

NOTE: The optional GPU card images below are representative and may not match the actual optional GPU card to remove the NVLink Bridge.

Steps

1. Locate the NVLink bridge on the GPU cards.
2. By using a plastic scribe, lift the NVLink bridge.
3. Hold the NVLink bridge by the edges to remove it from the GPU cards.

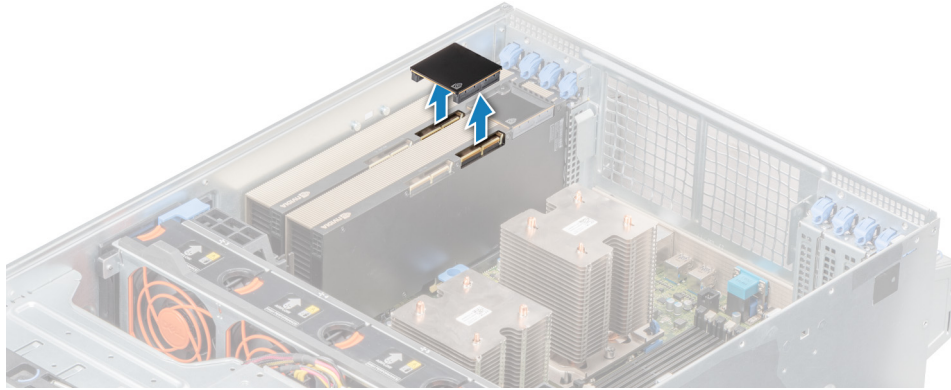

Figure 84. Removing the optional NVLink bridge

Next steps

1. Install the NVLink bridge cover on the GPU cards.
2. [Replace the optional NVLink bridge.](#)

Installing the optional NVLink bridge

Prerequisites

1. Follow the safety guidelines listed in [safety instructions](#).
2. Follow the procedure listed in [before working inside your system](#).
3. If installing a new NVLink bridge, unpack it and prepare the NVLink bridge for installation.
NOTE: For instructions, see the documentation accompanying the card.
4. If installed, [remove the GPU air shroud](#).
5. If installed, [remove the air shroud](#).
6. If installed, [remove the expansion card holder](#).

NOTE: The optional GPU card images below are representative and may not match the actual optional GPU card to install the NVLink Bridge.

Steps

1. If applicable, locate and remove the NVLink bridge cover on the GPU cards by using a plastic scribe.

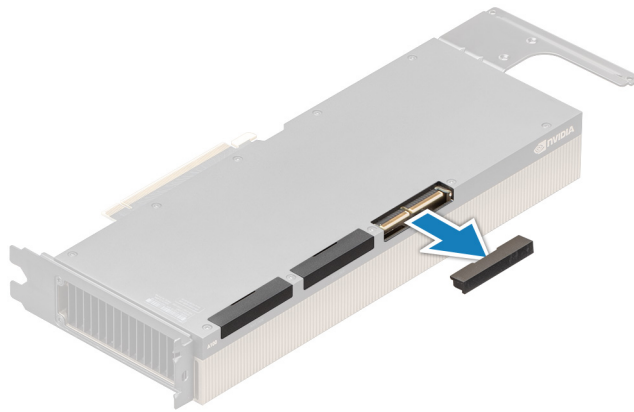

Figure 85. Removing the optional NVLink bridge cover

2. Install the NVLink bridge by placing the bridge between the cards and gently pressing downwards until firmly seated with no gap.

NOTE: The NVLink bridge can only be installed in one orientation. If it does not fit easily, turn the NVLink bridge around to install it on the GPU cards.



Figure 86. Installing the optional NVLink Bridge

Next steps

1. Replace the left and right air shrouds and [install the expansion card holders](#) from the NVLink bridge kit.
2. If removed, [install the air shroud](#).
3. Follow the procedure listed in [after working inside your system](#).

M.2 SSD module

Removing the M.2 SSD module

Prerequisites

1. Follow the safety guidelines listed in [Safety instructions](#) on page 27.
2. Follow the procedure listed in [Before working inside your system](#) on page 28.
3. [Remove the air shroud](#).
4. Remove the BOSS card.

NOTE: Removing the BOSS card is similar to the procedure for removing an expansion card riser.

Steps

1. Loosen the screws and lift the retention straps that secure the M.2 SSD module on the BOSS card.
2. Pull the M.2 SSD module away from the BOSS card.

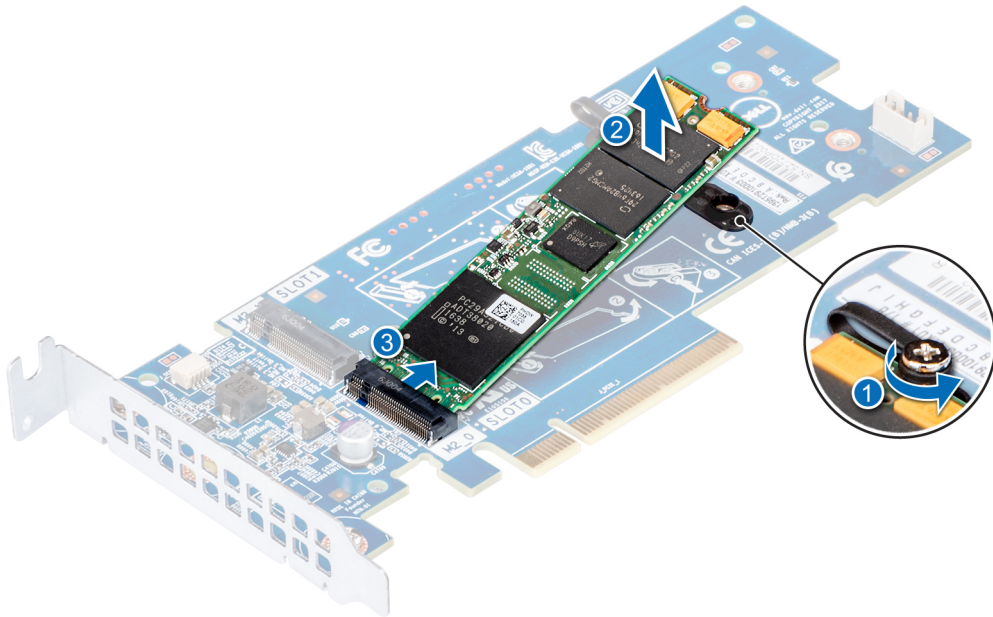

Figure 87. Removing the M.2 SSD module

Next steps

1. Install the M.2 SSD module.

Installing the M.2 SSD module

Prerequisites

1. Follow the safety guidelines listed in [Safety instructions](#) on page 27.

Steps

1. Align the M.2 SSD module connectors with the connectors on the BOSS card.
2. Push the M.2 SSD module until the module is seated firmly on the BOSS card.
3. Secure the M.2 SSD module on the BOSS card with the retention straps and screws.

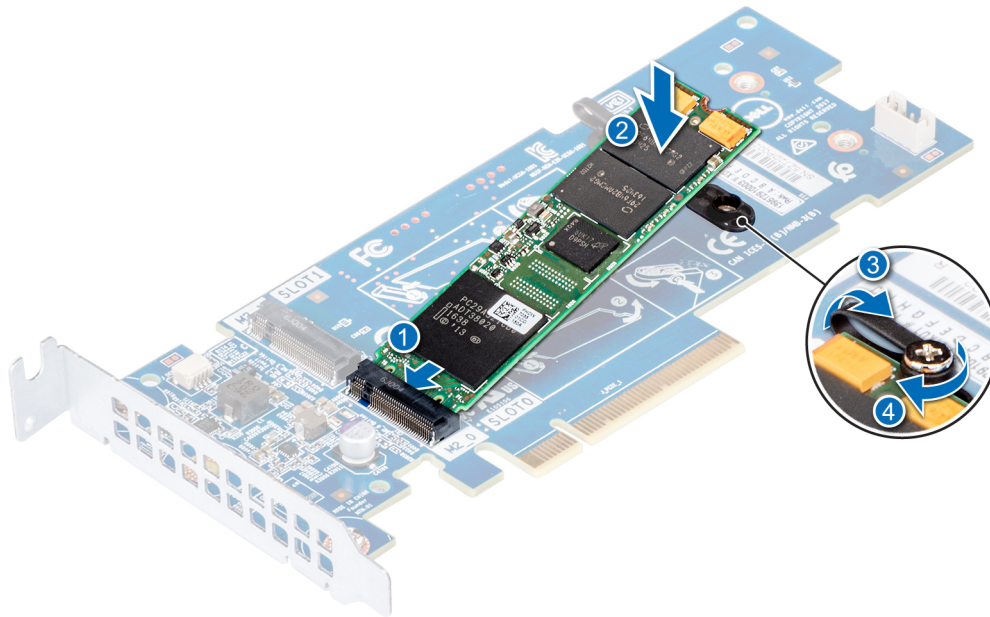

Figure 88. Installing the M.2 SSD module

Next steps

1. Install the BOSS card.
i **NOTE:** Installing the BOSS card is similar to installing the expansion card riser.
2. [Install the air shroud.](#)
3. Follow the procedure listed in [After working inside your system](#) on page 28.

Optional MicroSD or vFlash card

Removing the MicroSD card

Prerequisites

1. Follow the safety guidelines listed in [Safety instructions](#) on page 27.
2. Follow the procedure listed in [Before working inside your system](#) on page 28.

Steps

1. Locate the MicroSD card slot on the vFlash/IDSDM module, and press the card to partially release it from the slot. To locate IDSDM/vFlash module, see the [System board jumpers and connectors](#) section.
2. Hold the MicroSD card and remove it from the slot.

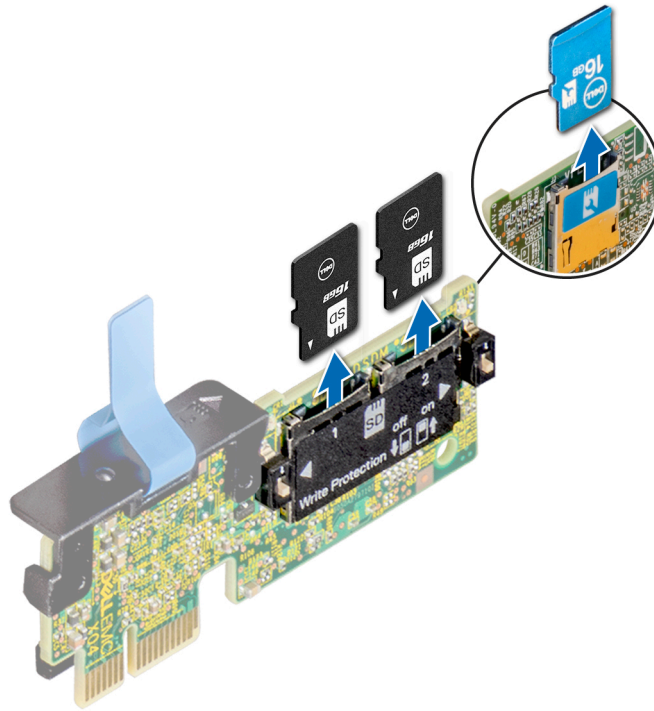

Figure 89. Removing the MicroSD card from the slot

NOTE: Temporarily label each MicroSD card with its corresponding slot number after removal.

Next steps

1. Install a MicroSD card.

Installing the MicroSD card

Prerequisites

Follow the safety guidelines listed in [Safety instructions](#) on page 27.

NOTE: To use an MicroSD card with your system, ensure that the **Internal SD Card Port** is enabled in System Setup.

NOTE: If reinstalling, ensure that you install the MicroSD cards into the same slots based on the labels you had marked on the cards during removal.

Steps

1. Locate the MicroSD card connector on the IDSDM/vFlash module. Orient the MicroSD card appropriately and insert the contact-pin end of the card into the slot. To locate IDSDM/vFlash, see the [System board jumpers and connectors](#) section.

NOTE: The slot is keyed to ensure correct insertion of the card.

2. Press the card into the card slot to lock it into place.

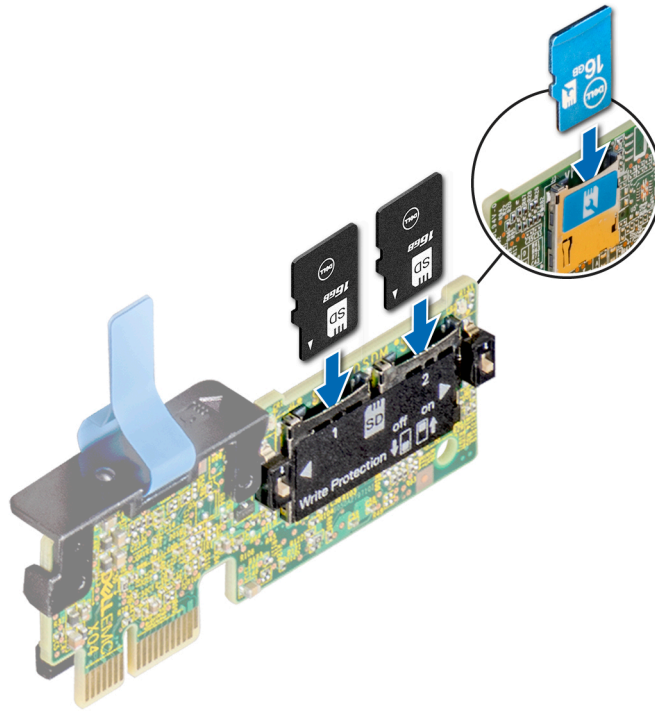

Figure 90. Installing the MicroSD card

Next steps

1. Follow the procedure listed in [After working inside your system](#) on page 28.

Optional IDSDM or vFlash module

Removing the optional IDSDM or vFlash module

Prerequisites

1. Follow the safety guidelines listed in [Safety instructions](#) on page 27.
2. Follow the procedure listed in [Before working inside your system](#) on page 28.
3. If you are replacing the IDSDM/vFlash module, remove the MicroSD cards.
 - NOTE:** Temporarily label each MicroSD card with its corresponding slot number after removal.

Steps

1. Locate the IDSDM/vFlash connector on the system board.
To locate IDSDM/vFlash connector, see the [System board jumpers and connectors](#) section.
2. Holding the pull tab, lift the IDSDM/vFlash module out of the system.

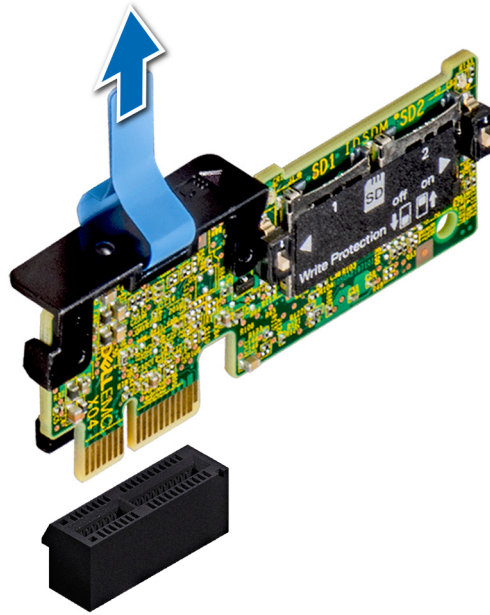

Figure 91. Removing the optional IDSDM/vFlash module

NOTE: There are two dip switches on the IDSDM/vFlash module for write-protection.

Next steps

1. Install the optional IDSDM/vFlash card.

Installing optional IDSDM or vFlash module

Prerequisites

Follow the safety guidelines listed in [Safety instructions](#) on page 27.

Steps

1. Locate the IDSDM/vFlash connector on the system board.
To locate IDSDM/vFlash connector, see the [System board jumpers and connectors](#) section.
2. Align the IDSDM/vFlash card with the connector on the system board.
3. Push the IDSDM/vFlash module until it is firmly seated on the system board.

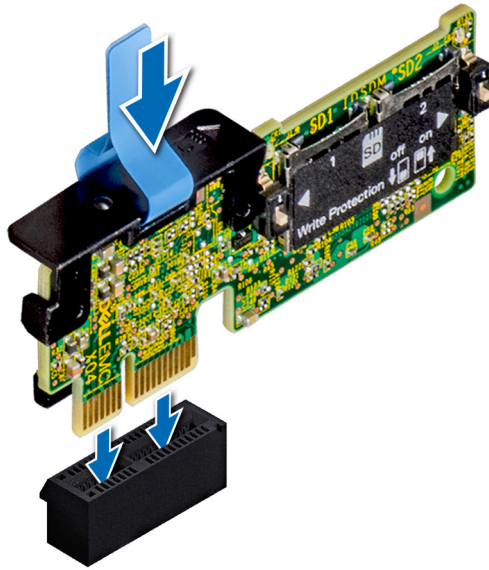

Figure 92. Installing optional IDSDM/vFlash module

Next steps

1. [Install the MicroSD cards.](#)

NOTE: Reinstall the MicroSD cards into the same slots based on the labels you had marked on the cards during removal.

2. Follow the procedure listed in [After working inside your system](#) on page 28.

Backplane

Backplane connectors

Depending on the configuration, your system supports one of the following:

- 8 x 3.5 inch SAS/SATA backplane
- 18 x 3.5 inch SAS/SATA backplane
- 8 x 2.5 inch Dell PowerEdge Express Flash (NVMe) backplane
- 16 x 2.5 inch SAS/SATA backplane with the optional additional backplanes below:
 - 8 x 2.5 inch NVMe backplane
 - 16 x 2.5 inch SAS/SATA backplane (FlexBay)
- 32 x 2.5 inch SAS/SATA backplane

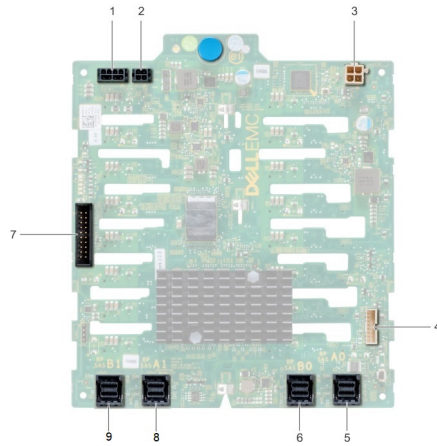

Figure 93. 16 x 2.5 inch SAS/SATA backplane for FlexBay (upper)

- | | |
|--|---|
| 1. backplane power connector A [J_BP_PWR_A] | 2. backplane power connector B [J_BP_PWR_B] |
| 3. optical drive power connector [J_ODD_PWR] | 4. backplane signal connector [J_BP_SIG] |
| 5. SAS A0 connector [J_SAS_A0] | 6. SAS B0 connector [J_SAS_B0] |
| 7. I2C connector | 8. SAS A1 connector [J_EXP_A1] |
| 9. SAS B1 connector [J_EXP_B1] | |

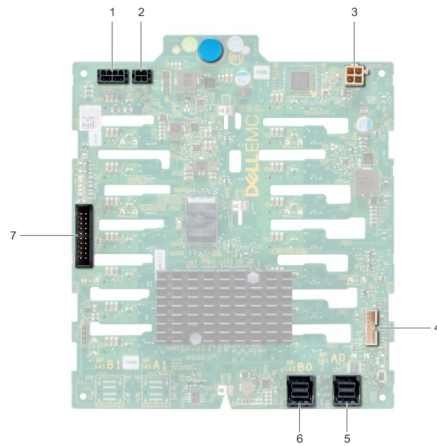

Figure 94. 16 x 2.5 inch SAS/SATA backplane (lower)

- | | |
|--|---|
| 1. backplane power connector A [J_BP_PWR_A] | 2. backplane power connector B [J_BP_PWR_B] |
| 3. optical drive power connector [J_ODD_PWR] | 4. backplane signal connector [J_BP_SIG] |
| 5. SAS A0 connector [J_SAS_A0] | 6. SAS B0 connector [J_SAS_B0] |
| 7. I2C connector | |

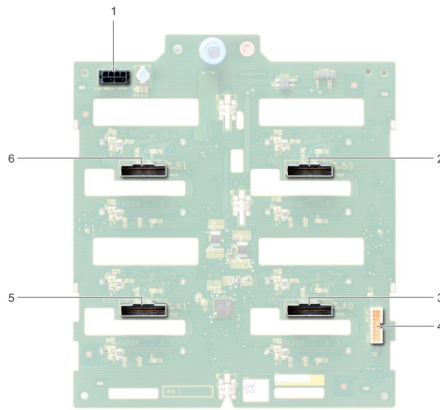

Figure 95. 8 x 2.5 inch NVMe backplane

- | | |
|--|---|
| 1. backplane power connector [J_BP_PWR1] | 2. PCIe B0 connector [J_PCIE_B0] |
| 3. PCIe A0 connector [J_PCIE_A0] | 4. backplane signal connector [J_BP_SIG1] |
| 5. PCIe A1 connector [J_PCIE_A1] | 6. PCIe B1 connector [J_PCIE_B1] |

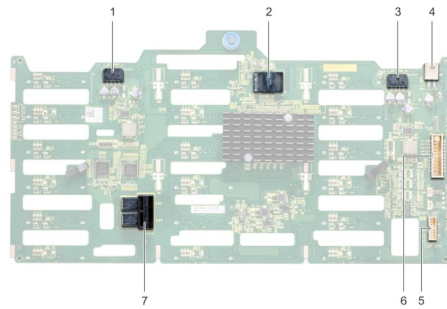

Figure 96. 18 x 3.5 inch SAS/SATA backplane

- | | |
|--|---|
| 1. backplane power connector A [J_BP_PWR_A1] | 2. controller |
| 3. backplane power connector B [J_BP_PWR_B1] | 4. optical drive power connector [J_ODD1] |
| 5. I2C connector | 6. backplane signal connector [J_BP_SIG1] |
| 7. SAS A0_B0 connector [J_SAS_A0_B0] | |

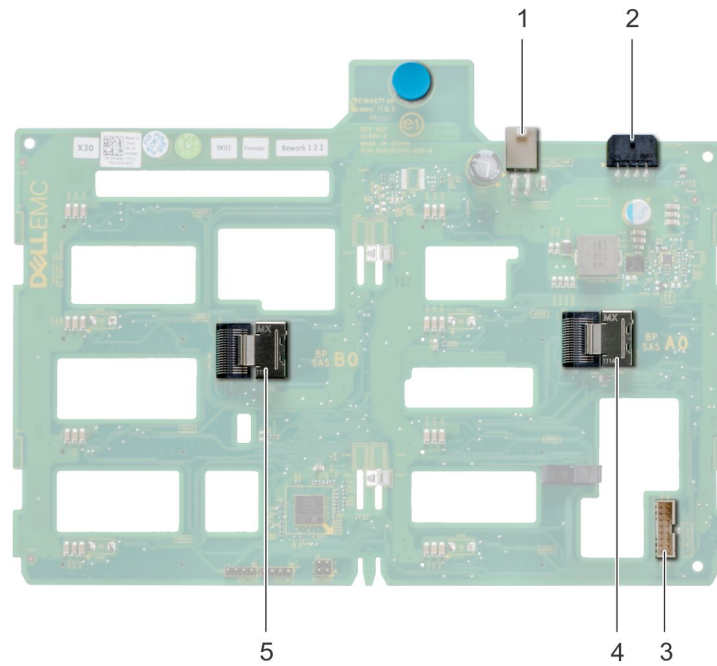

Figure 97. 8 x 3.5 inch SAS/SATA backplane

- | | |
|---|---|
| 1. optical drive power connector [J_ODD1] | 2. backplane power connector [J_BP_PWR_A] |
| 3. SAS A0 connector [J_BP_SIG] | 4. backplane signal connector [J_SAS_A0] |
| 5. SAS B0 connector [J_SAS_B0] | |

Removing a backplane

Prerequisites

CAUTION: To prevent damage to the drives and backplane, you must remove the hard drives from the system before removing the backplane.

CAUTION: You must note the number of each hard drive and temporarily label them before removal so that you can replace them in the same locations.

1. Follow the safety guidelines listed in [Safety instructions](#) on page 27.
2. Follow the procedure listed in [Before working inside your system](#) on page 28.
3. [Remove all the drives.](#)
4. If installed, [remove the middle cooling fan assembly.](#)

Steps

1. Disconnect the data, signal, and power cables from the backplane.
2. Pull the release pin and holding the pin, lift the backplane out of the system.

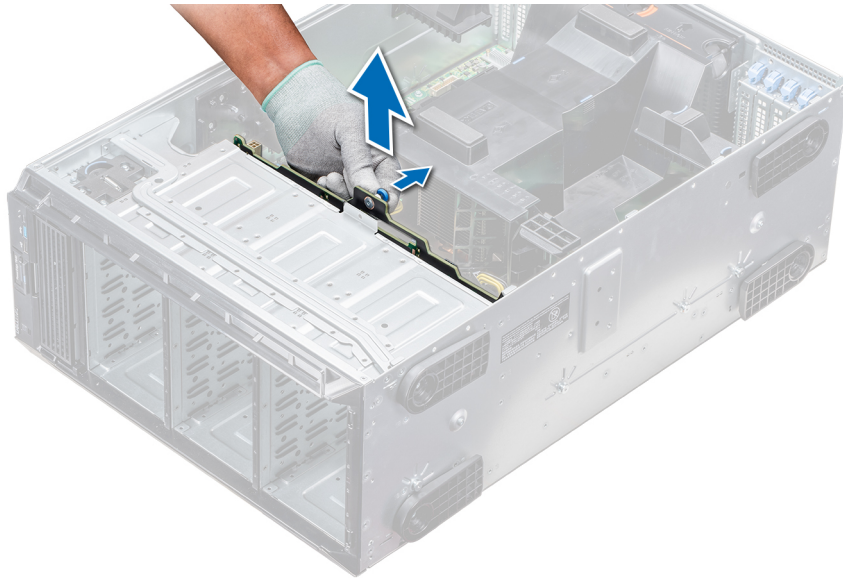

Figure 98. Removing a backplane

Next steps

1. [Install a backplane.](#)

Installing a backplane

Prerequisites

1. Follow the safety guidelines listed in [Safety instructions](#) on page 27.
2. Follow the procedure listed in [Before working inside your system](#) on page 28.

Steps

1. Use the hooks at the base of the system as guides to align the hard drive backplane.
2. Lower the hard-drive backplane into the system till the release pin locks in place, securing the hard drive backplane to the system.
3. Connect the data, signal, and power cables to the backplane.

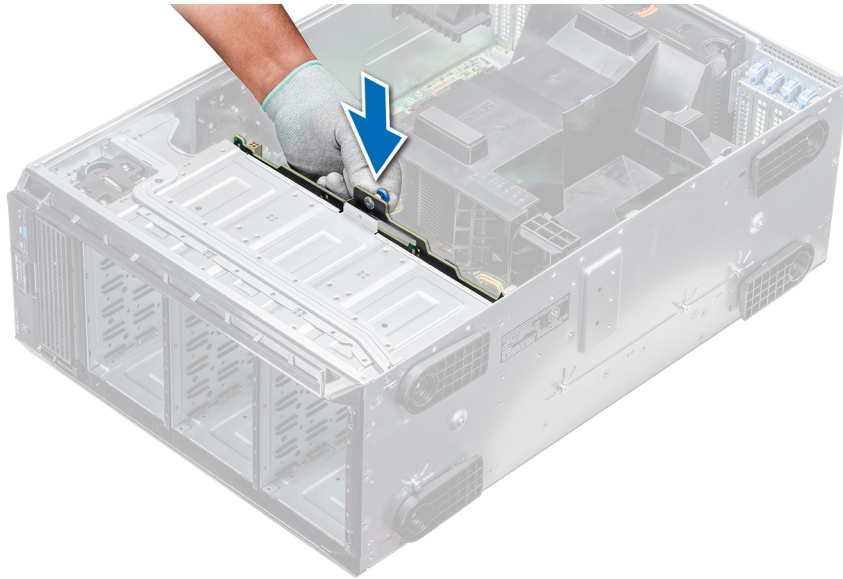

Figure 99. Installing a backplane

Next steps

1. If removed, [install the middle cooling fan assembly](#).
2. [Install the drives into their original slots](#).
3. Follow the procedure listed in [After working inside your system](#) on page 28.

Backplane cabling

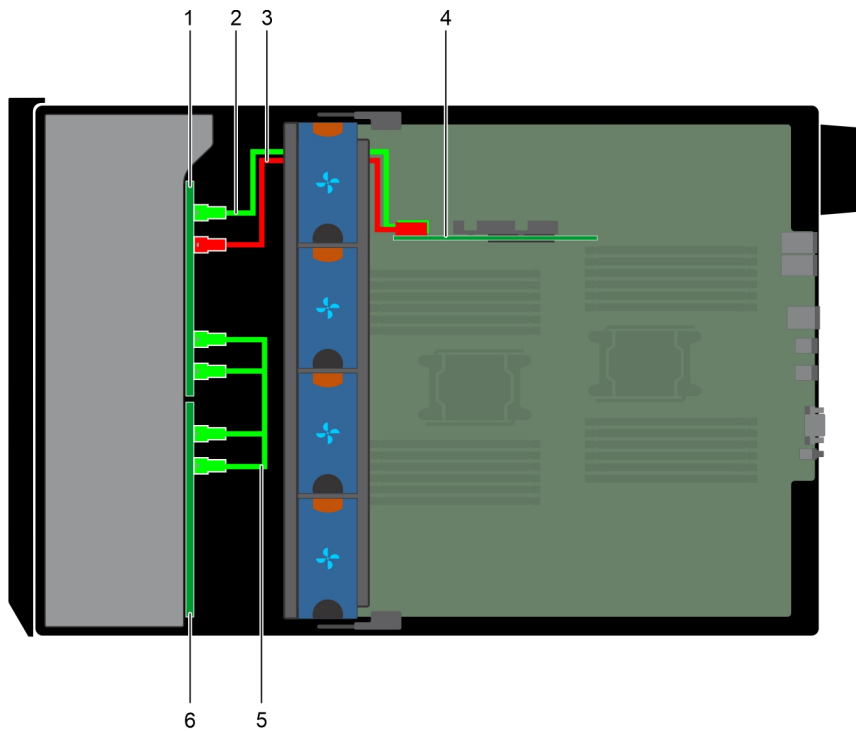

Figure 100. 2.5 inch x32 SAS/SATA to internal PERC

- | | |
|--|--|
| 1. 2.5 inch x 16 backplane (flex bay) | 2. SAS cable (BP flex bay: J_SAS_A0 to internal PERC card) |
| 3. SAS cable (BP flex bay: J_SAS_B0 to internal PERC card) | 4. internal PERC card |

- 5. SAS cable (BP flex bay J_EXP_A1 to BP J_SAS_A0; BP flex 6. 2.5 inch x 16 backplane bay J_EXP_B1 to BP J_SAS_B0)

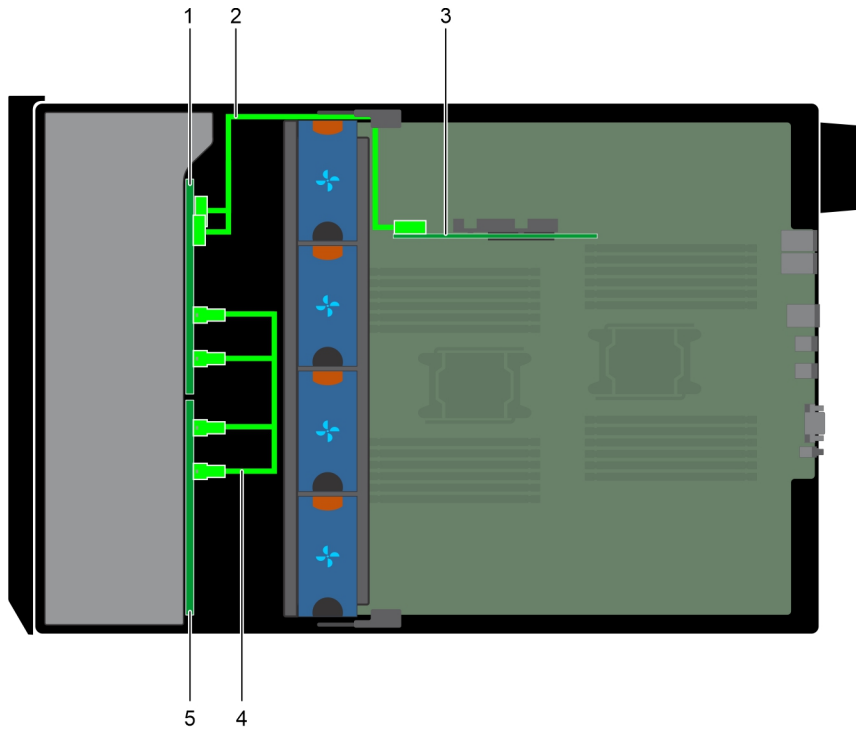

Figure 101. 2.5 inch x32 SAS/SATA to internal PERC

- 1. 2.5 inch x 16 backplane (flex bay)
- 2. SAS cable (BP flex bay: J_SAS_A0 and B0 to PERC 11 adapter: CTRL_SRC_SA1)
- 3. internal PERC card
- 4. SAS cable (BP flex bay J_EXP_A1 to BP J_SAS_A0; BP flex bay J_EXP_B1 to BP J_SAS_B0)
- 5. 2.5 inch x 16 backplane

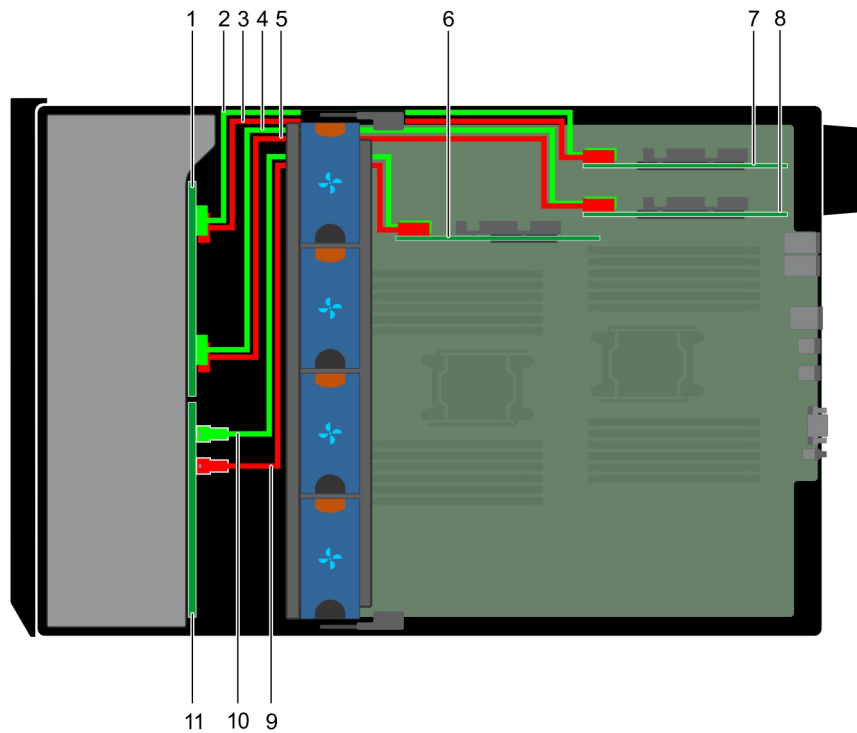

Figure 102. 2.5 inch x16 SAS/SATA to internal PERC with 2.5 inch x8 NVMe to PCIe bridge

- | | |
|--|---|
| 1. 2.5 inch x8 NVMe backplane | 2. NVMe cable (BP: J_PCIE_B0 to PCIe bridge: J6) |
| 3. NVMe cable (BP: J_PCIE_A0 to PCIe bridge: J5) | 4. NVMe cable (BP: J_PCIE_B1 to PCIe bridge: J6) |
| 5. NVMe cable (BP: J_PCIE_A1 to PCIe bridge: J5) | 6. internal PERC card |
| 7. PCIe bridge on Slot 1 | 8. PCIe bridge on Slot 3 |
| 9. SAS cable (BP: SAS_B0 to internal PERC card: SAS_B) | 10. SAS cable (BP: SAS_A0 to internal PERC card: SAS_A) |
| 11. 2.5 inch x16 SAS/SATA backplane | |

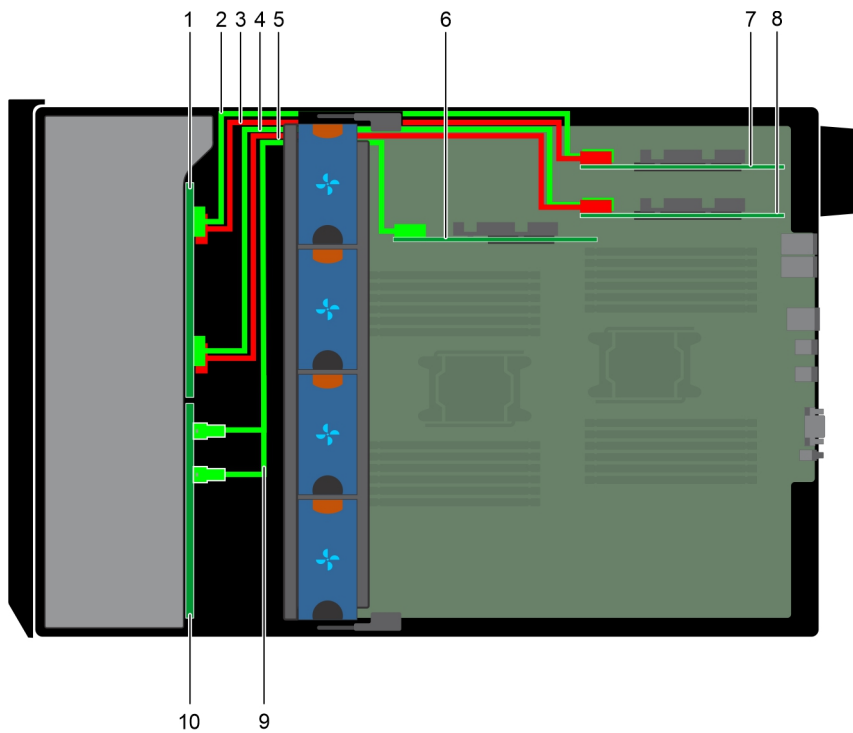

Figure 103. 2.5 inch x16 SAS/SATA to internal PERC with 2.5 inch x8 NVMe to PCIe bridge

- | | |
|-------------------------------|--|
| 1. 2.5 inch x8 NVMe backplane | 2. NVMe cable (BP: J_PCIE_B0 to PCIe bridge: J6) |
|-------------------------------|--|

- 3. NVMe cable (BP: J_PCIE_A0 to PCIe bridge: J5)
- 5. NVMe cable (BP: J_PCIE_A1 to PCIe bridge: J5)
- 7. PCIe bridge on Slot 1
- 9. SAS cable (BP: SAS_A0 and B0 to internal PERC 11 card: CTRL_SRC_SA1)
- 4. NVMe cable (BP: J_PCIE_B1 to PCIe bridge: J6)
- 6. internal PERC 11 card
- 8. PCIe bridge on Slot 3
- 10. 2.5 inch x16 SAS/SATA backplane

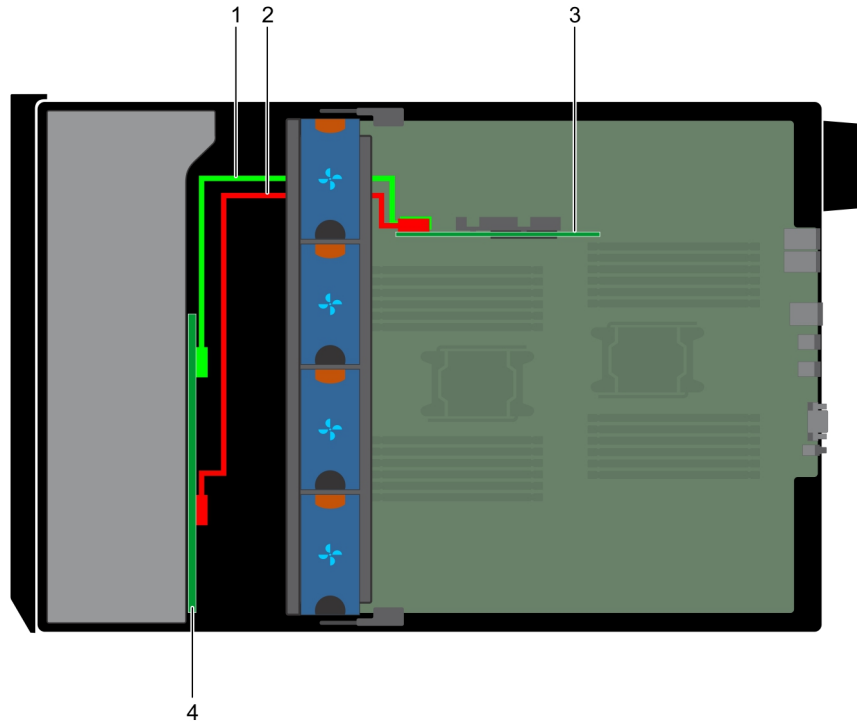

Figure 104. 3.5 inch x8 SAS/SATA to internal PERC

- 1. SAS cable (BP: SAS_A0 to internal PERC card: SAS_A)
- 2. SAS cable (BP: SAS_B0 to internal PERC card: SAS_B)
- 3. internal PERC
- 4. 3.5 inch x8 SAS/SATA backplane

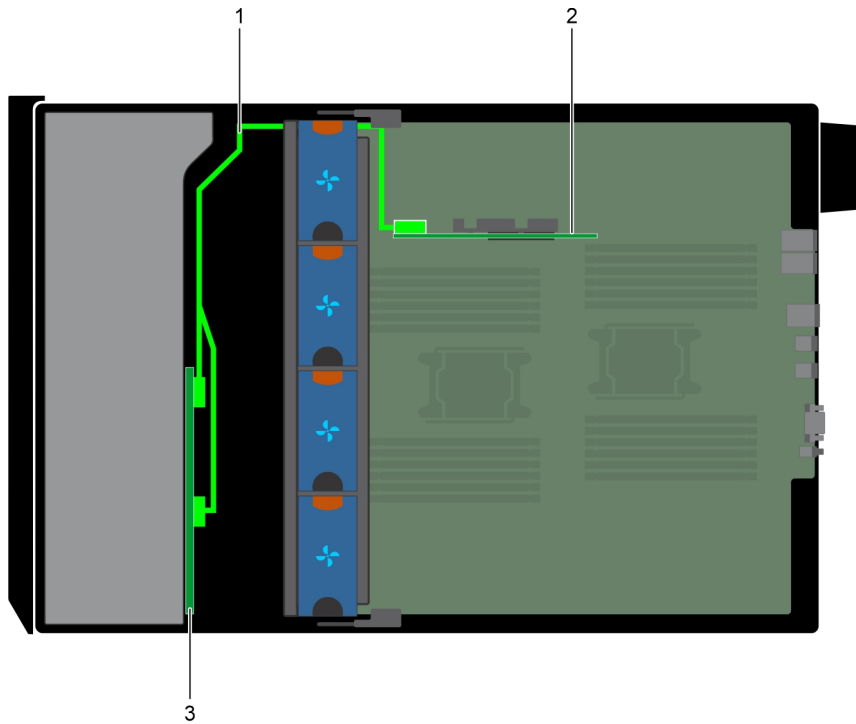

Figure 105. 3.5 inch x8 SAS/SATA to internal PERC

1. SAS cable (BP: SAS_A0 and SAS_B0 to internal PERC 11 card: CTRL_SRC_SA1)
2. internal PERC 11
3. 3.5 inch x8 SAS/SATA backplane

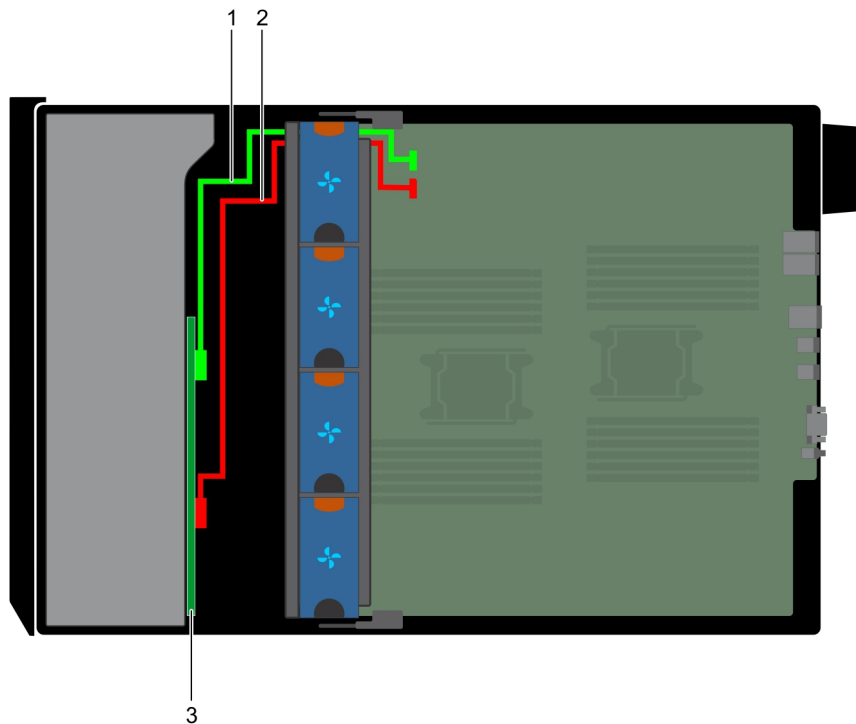

Figure 106. 3.5 inch x8 onboard SAS controller

1. SAS cable (BP: SAS_A0 to MB: SAS_A)
2. SAS cable (BP: SAS_B0 to MB: SAS_B)
3. 3.5 inch x8 SAS/SATA backplane

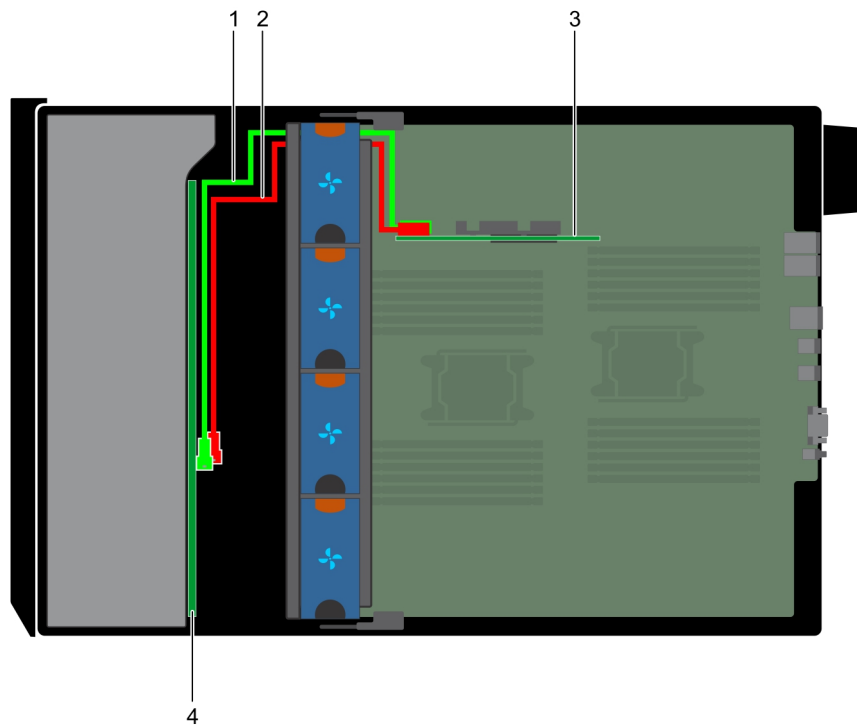

Figure 107. 3.5 inch x18 internal PERC

- 1. SAS cable (BP: SAS_A0 to internal PERC card: SAS_A)
- 2. SAS cable (BP: SAS_B0 to internal PERC card: SAS_B)
- 3. internal PERC card
- 4. 3.5 inch x18 SAS/SATA backplane

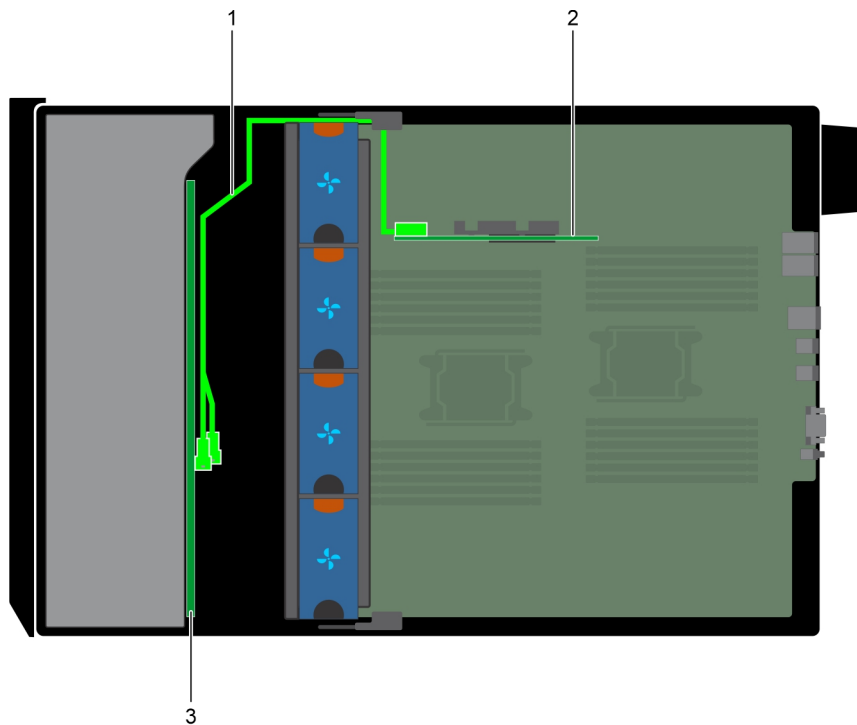

Figure 108. 3.5 inch x18 internal PERC

- 1. SAS cable (BP: SAS_A0 and SAS_B0 to internal PERC 11 card: CTRL_SRC_SA1)
- 2. internal PERC 11 card
- 3. 3.5 inch x18 SAS/SATA backplane

Integrated storage controller card

Removing the integrated storage controller card

Prerequisites

1. Follow the safety guidelines listed in [Safety instructions](#) on page 27.
2. Follow the procedure listed in [Before working inside your system](#) on page 28.
3. [Remove the air shroud](#).
4. [Remove the GPU card holder](#).

Steps

1. Holding the integrated storage controller card firmly, lift the card out of the server.
2. Disconnect the data cables from the integrated storage controller.

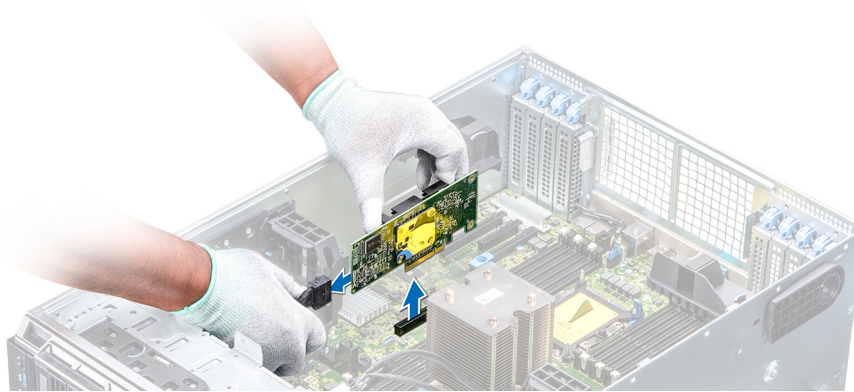

Figure 109. Removing the integrated storage controller card

Next steps

1. [Install the integrated storage controller card](#).

Installing the integrated storage controller card

Prerequisites

Follow the safety guidelines listed in [Safety instructions](#) on page 27.

Steps

1. Connect the data cables from the integrated storage controller.
2. Holding the storage controller card firmly, insert the card into the dedicated slot on the system board.

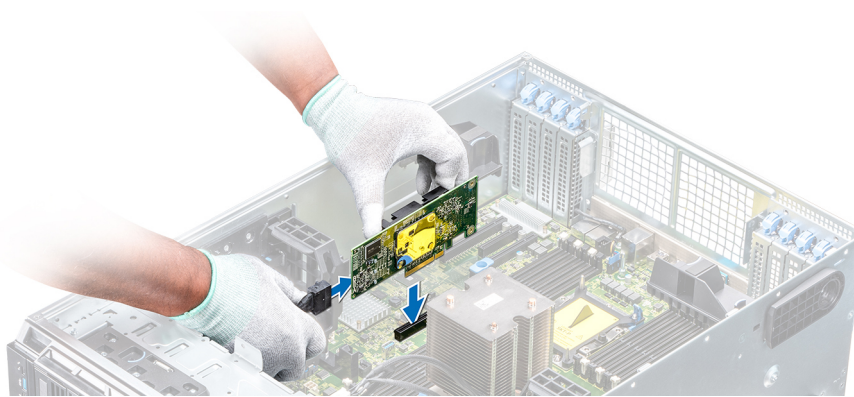

Figure 110. Installing the integrated storage controller card

Next steps

1. Install the GPU card holder.
2. Install the air shroud.
3. Follow the procedure listed in [After working inside your system](#) on page 28.

System battery

Replacing the system battery

Prerequisites

⚠ WARNING: There is a danger of a new battery exploding if it is incorrectly installed. Replace the battery only with the same or equivalent type recommended by the manufacturer. For more information, see the safety information that shipped with your system.

1. Follow the safety guidelines listed in [Safety instructions](#) on page 27.
2. Follow the procedure listed in [Before working inside your system](#) on page 28.
3. If installed, disconnect the power or data cables from expansion card(s).

Steps

1. Locate the battery socket. For more information, see the [System board jumpers and connectors](#) section.

⚠ CAUTION: To avoid damage to the battery connector, you must firmly support the connector while installing or removing a battery.

2. Use a plastic scribe to pry out the system battery.

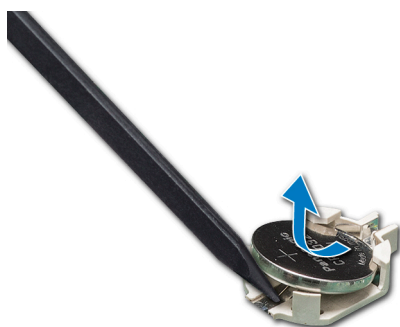

Figure 111. Removing the system battery

3. To install a new system battery, hold the battery with the positive side facing up and slide it under the securing tabs.
4. Press the battery into the connector until it snaps into place.

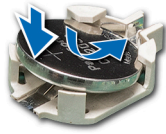

Figure 112. Installing the system battery

Next steps

1. If removed, connect the cables to the expansion card(s).
2. Follow the procedure listed in [After working inside your system](#) on page 28.
3. While booting, press F2 to enter the System Setup and ensure that the battery is operating properly.
4. Enter the correct time and date in the System Setup **Time** and **Date** fields.
5. Exit the System Setup.

Optional internal USB memory key

Replacing the optional internal USB memory key

Prerequisites

CAUTION: To avoid interference with other components in the server, the maximum permissible dimensions of the USB memory key are 15.9 mm wide x 57.15 mm long x 7.9 mm high.

1. Follow the safety guidelines listed in [Safety instructions](#) on page 27.
2. Follow the procedure listed in [Before working inside your system](#) on page 28.

Steps

1. Locate the USB port or USB memory key on the system board.
To locate the USB port, see the [System board jumpers and connectors](#).
2. If installed, remove the USB memory key from the USB port.
3. Insert the replacement USB memory key into the USB port.

Next steps

1. Follow the procedure listed in [After working inside your system](#) on page 28.
2. While booting, press F2 to enter **System Setup** and verify that the system detects the USB memory key.

Control panel assembly

Removing the control panel assembly

Prerequisites

1. Follow the safety guidelines listed in [Safety instructions](#) on page 27.
2. Follow the procedure listed in [Before working inside your system](#) on page 28.
3. [Remove the cooling fan assembly](#).

Steps

1. Using the Phillips #2 screwdriver, remove the screw that secures control panel to the chassis.
2. Disconnect the control panel cable and the control panel USB cable from the system board.

 **CAUTION:** Do not use excessive force when removing the control panel cables as it can damage the connectors.

3. Slide the control panel out of the chassis.



 **NOTE:** Follow the same steps to remove the control panel in the rack-mode configuration.



Figure 113. Removing the control panel assembly

4. To remove the information tag, perform the following steps:
 - a. Locate and press the tabs on the information tag.
 - b. Push the information tag out of the slot to remove it from the control panel.

 **NOTE:** Retain the information tag to replace it in the new control panel.

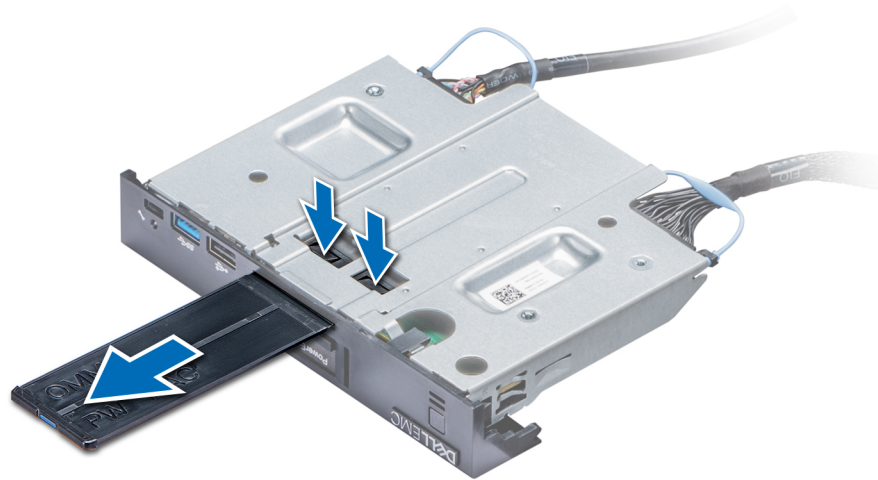

Figure 114. Removing the information tag

Next steps

1. Install the control panel assembly.

Installing the control panel assembly

Prerequisites

Follow the safety guidelines listed in [Safety instructions](#) on page 27.

Steps

1. Replace the blank information tag in the new control panel with the information tag retained from the old control panel.

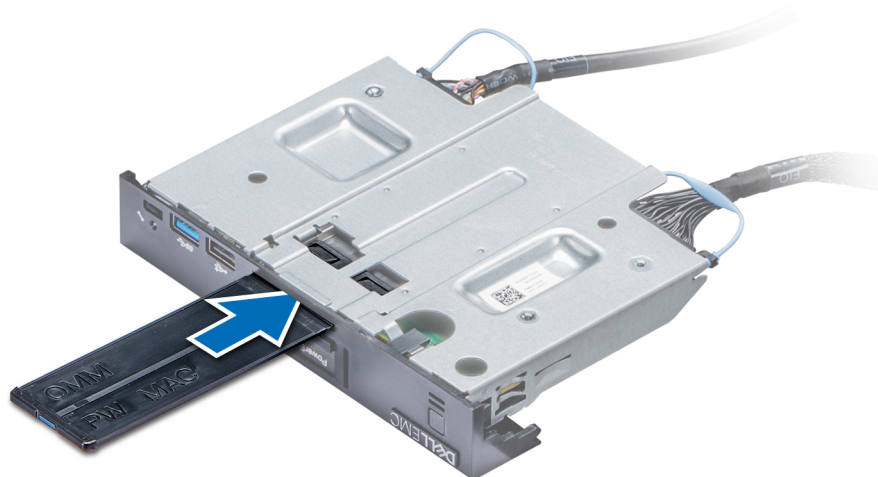

Figure 115. Installing the information tag

2. To install the information tag, push the information tag into the control-panel slot.
3. Connect the control panel cable and the control panel USB cable to the control panel assembly.
4. Align and insert the control panel into the control panel slot in the chassis.
5. Secure the control panel to the chassis by using the screw.
6. Connect the control panel cable and the control panel USB cable to the system board.



Figure 116. Installing the control panel assembly

Next steps

1. [Install the cooling fan assembly.](#)
2. Follow the procedure listed in [After working inside your system](#) on page 28.

Trusted Platform Module

Upgrading the Trusted Platform Module

Prerequisites

1. Follow the safety guidelines listed in [Safety instructions](#) on page 27.
2. Follow the procedure listed in [Before working inside your system](#) on page 28.

NOTE:

- Ensure that your operating system supports the version of the TPM module being installed.
- Ensure that you download and install the latest BIOS firmware on your system.
- Ensure that the BIOS is configured to enable UEFI boot mode.

About this task

CAUTION: If you are using the Trusted Platform Module (TPM) with an encryption key, you may be prompted to create a recovery key during program or System Setup. Work with the customer to create and safely store this recovery key. When replacing this system board, you must supply the recovery key when you restart your system or program before you can access the encrypted data on your hard drives.

CAUTION: Once the TPM plug-in module is installed, it is cryptographically bound to that specific system board. Any attempt to remove an installed TPM plug-in module breaks the cryptographic binding, the removed TPM cannot be reinstalled or installed on another system board.

Removing the TPM

Steps

1. Locate the TPM connector on the system board.
2. Press to hold the module down and remove the screw using the security Torx 8-bit shipped with the TPM module.
3. Slide the TPM module out from its connector.
4. Push the plastic rivet away from the TPM connector and rotate it 90° counterclockwise to release it from the system board.
5. Pull the plastic rivet out of its slot on the system board.

Installing the TPM

Steps

1. To install the TPM, align the edge connectors on the TPM with the slot on the TPM connector.
2. Insert the TPM into the TPM connector such that the plastic rivet aligns with the slot on the system board.
3. Press the plastic rivet until the rivet snaps into place.

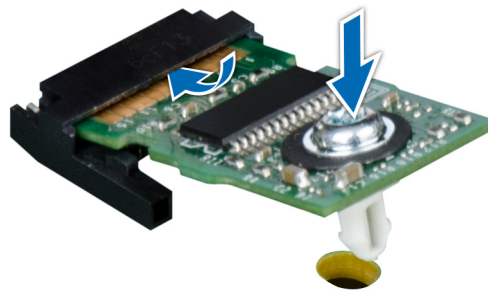

Figure 117. Installing the TPM

Next steps

1. [Install the system board.](#)
2. Follow the procedure listed in [After working inside your system](#) on page 28.

Initializing TPM for BitLocker users

Steps

Initialize the TPM.

For more information, see .

The **TPM Status** changes to **Enabled, Activated**.

Initializing the TPM 1.2 for TXT users

Steps

1. While booting your system, press F2 to enter System Setup.
2. On the **System Setup Main Menu** screen, click **System BIOS > System Security Settings**.
3. From the **TPM Security** option, select **On with Pre-boot Measurements**.
4. From the **TPM Command** option, select **Activate**.
5. Save the settings.

- Restart your system.
- Enter **System Setup** again.
- On the **System Setup Main Menu** screen, click **System BIOS > System Security Settings**.
- From the **Intel TXT** option, select **On**.

System board

Removing the system board

Prerequisites

 **CAUTION:** If you are using the Trusted Platform Module (TPM) with an encryption key, you may be prompted to create a recovery key during program or System Setup. Be sure to create and safely store this recovery key. If you replace this system board, you must supply the recovery key when you restart your system or program before you can access the encrypted data on your hard drives.

 **CAUTION:** Do not attempt to remove the TPM plug-in module from the system board. Once the TPM plug-in module is installed, it is cryptographically bound to that specific system board. Any attempt to remove an installed TPM plug-in module breaks the cryptographic binding, and it cannot be reinstalled or installed on another system board.

- Follow the safety guidelines listed in [Safety instructions](#) on page 27.
- Follow the procedure listed in [Before working inside your system](#) on page 28.
- Remove the following:
 - [Air shroud](#)
 - [GPU card holder](#), if installed
 - [Expansion card holder](#)
 - [Cooling fan assembly](#), if installed
 - [Expansion cards](#), if installed
 - [Integrated storage controller card](#)
 - [vFlash/IDSDM module](#)
 - [Internal USB key](#), if installed
 - [Processors and heat sink modules](#)

 **CAUTION:** To prevent damage to the processor pins when replacing a faulty system board, ensure that you cover the processor socket with the processor protective cap.

- [Memory modules](#)

Steps

- Disconnect all cables from the system board.

 **CAUTION:** Take care not to damage the system identification button while removing the system board from the chassis.

 **CAUTION:** Do not lift the system board by holding a memory module, processor, or other components.

- Holding the post, lift the blue release pin, and slide the system board toward the front of the system. Sliding the system board toward the front of the chassis to disengage the connectors from the slots on the chassis.
- Holding the post, incline the system board at an angle, and lift the system board out of the chassis.

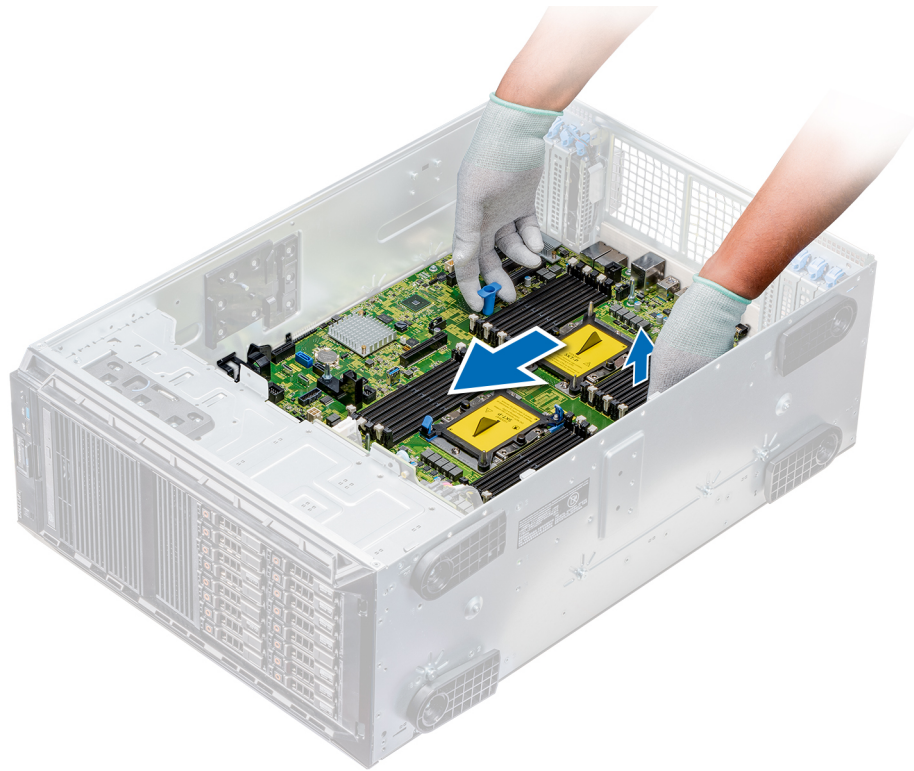

Figure 118. Disengaging the system board

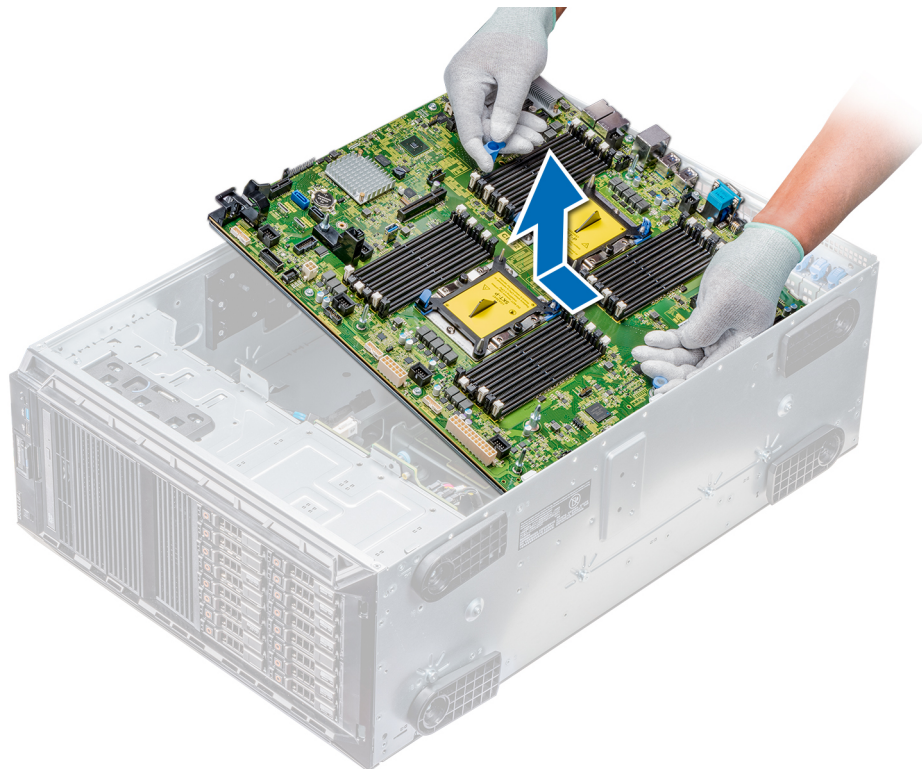

Figure 119. Removing the system board

Next steps

1. Install the system board.

Installing the system board

Prerequisites

Follow the safety guidelines listed in [Safety instructions](#) on page 27.

Steps

1. Unpack the new system board assembly.

CAUTION: Do not lift the system board by holding a memory module, processor, or other components.

CAUTION: Take care not to damage the system identification button while placing the system board into the chassis.

2. Holding the post, incline the system board, and lower the system board into the chassis.
3. Holding the system board holder, push the system board toward the back of the system until the release pin clicks into place.

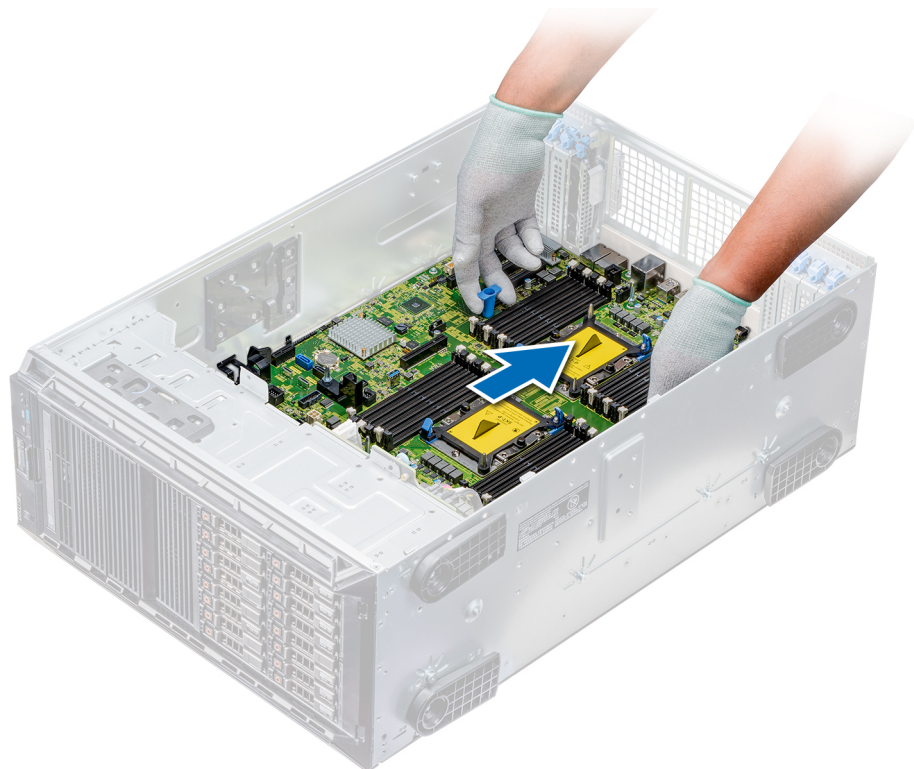



Figure 120. Installing the system board

4. Using the Phillips #2 screwdriver secure the system board to the chassis with screws.

Next steps

1. Replace the following:
 - a. [Trusted Platform Module \(TPM\)](#)
 - b. [Memory modules](#)
 - c. [Processors and heat sink modules](#)
 - d. [Internal USB key](#)
 - e. [vFlash/IDSDM module](#)
 - f. [Integrated storage controller card](#)
 - g. [Expansion cards](#), if installed
 - h. [Cooling fan assembly](#), if applicable
 - i. [Expansion card holder](#)
 - j. [GPU card holder](#)

- k. [Air shroud](#)
2. Reconnect all cables to the system board.
 -  **NOTE:** Ensure that the cables inside the system are routed along the chassis wall and secured by using the cable securing bracket.
3. Follow the procedure listed in [After working inside your system](#) on page 28.
4. Ensure that you:
 - a. Use the Easy Restore feature to restore the Service Tag. For more information, see the [Restoring the Service Tag using Easy Restore](#) section.
 - b. If the Service Tag is not backed up in the backup flash device, enter the Service Tag manually. For more information, see the [Restoring the Service Tag using Easy Restore](#) section.
 - c. Update the BIOS and iDRAC versions.
 - d. Re-enable the Trusted Platform Module (TPM). For more information, see the [Upgrading the Trusted Platform Module](#) section.
5. Import your new or existing iDRAC Enterprise license.



For more information, see *Integrated Dell Remote Access Controller User's Guide*, at www.dell.com/poweredge/manuals.

Restoring the Service Tag using Easy Restore

The easy restore feature allows you to restore your service tag, license, UEFI configuration, and the system configuration data after replacing the system board. All data is backed up in a backup flash device automatically. If BIOS detects a new system board, and the service tag in the backup flash device, BIOS prompts the user to restore the backup information.

About this task

Below is a list of options available:

- Restore the service tag, license, and diagnostics information, press **Y**
- Navigate to the Lifecycle Controller based restore options, press **N**.
- Restore data from a previously created **Hardware Server Profile**, press **F10**
 -  **NOTE:** When the restore process is complete, BIOS prompts to restore the system configuration data.
- To restore the system configuration data, press **Y**
- To use the default configuration settings, press **N**
 -  **NOTE:** After the restore process is complete, system reboots.

Manually update the Service Tag

After replacing a system board, if Easy Restore fails, follow this process to manually enter the Service Tag, using **System Setup**.

About this task

If you know the system service tag, use the **System Setup** menu to enter the service tag.

Steps

1. Turn on the system.
2. To enter the **System Setup**, press **F2**.
3. Click **Service Tag Settings**.
4. Enter the service tag.
 -  **NOTE:** You can enter the service tag only when the **Service Tag** field is empty. Ensure that you enter the correct service tag. Once the service tag is entered, it cannot be updated or changed.
5. Click **OK**.

Power interposer boards

Main and GPU power interposer boards connectors

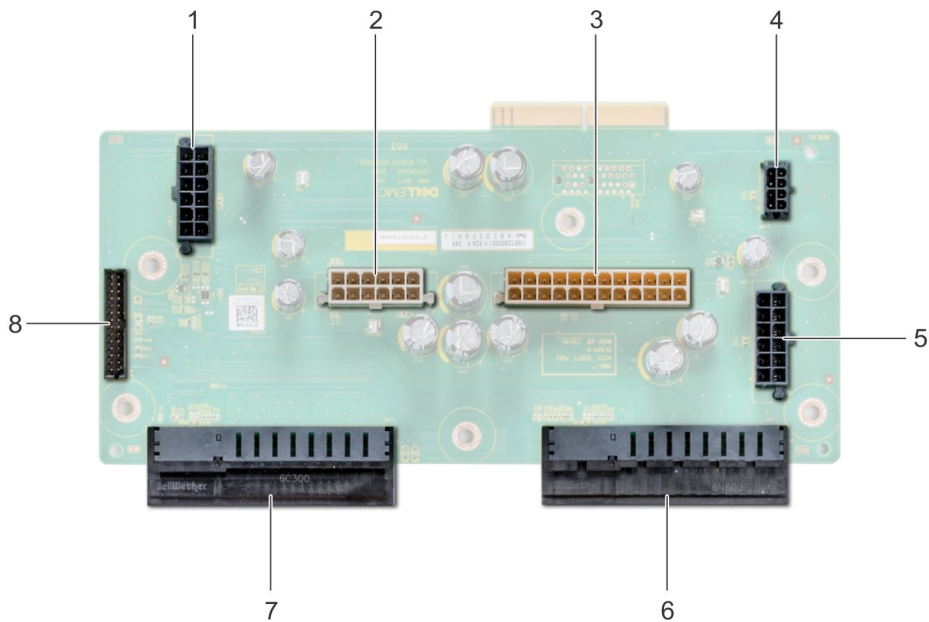

Figure 121. Main power interposer board

- 1. backplane 1 power connector [J_BP1]
- 2. backplane 0 power connector [J5]
- 3. P2 power connector [J3]
- 4. P1 power connector [J_BP0]
- 5. backplane 2 power connector [J_BP2]
- 6. PSU 1 connector
- 7. PSU 2 connector
- 8. signal cable connector [J4]

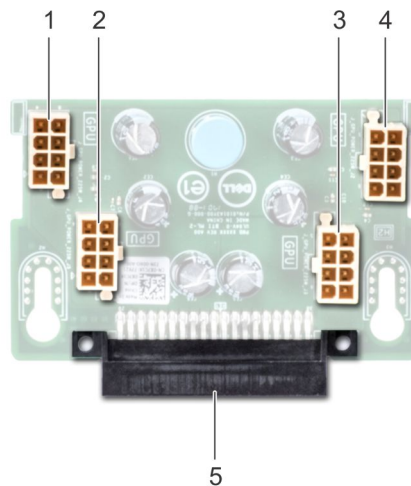

Figure 122. GPU power interposer board

- 1. GPU power connector [J_GPU_POWER_225W_J4]
- 2. GPU power connector [J_GPU_POWER_225W_J5]
- 3. GPU power connector [J_GPU_POWER_225W_J3]
- 4. GPU power connector [J_GPU_POWER_225W_J2]
- 5. main power interposer board link connector

Removing the GPU power interposer board

Prerequisites

1. Follow the safety guidelines listed in [Safety instructions](#) on page 27.
2. Follow the procedure listed in [Before working inside your system](#) on page 28.
3. [Remove the power supply units \(PSUs\)](#).
4. [Remove the system board](#).

Steps

1. Lift the release pin, and slide the power interposer board (PIB) to release the board from the guide pin.
2. Disengage the GPU PIB from the guide pins and lift the PIB out of the system.

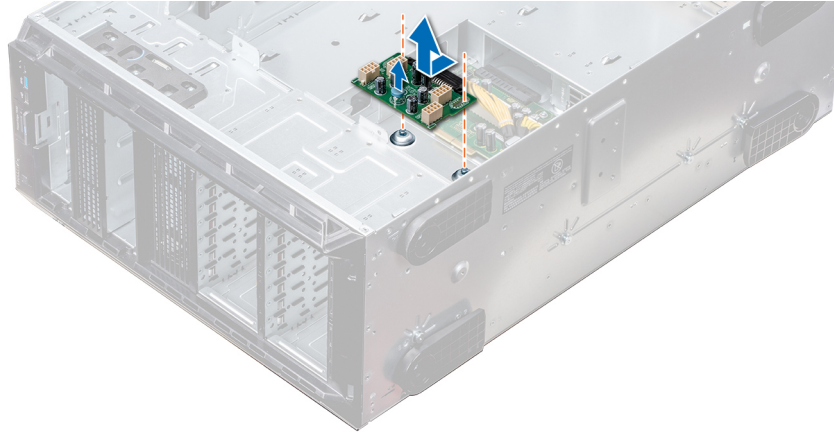

Figure 123. Removing the GPU power interposer board

Next steps

1. [Install the GPU power interposer board](#).

Installing the GPU power interposer board

Prerequisites

Follow the safety guidelines listed in [Safety instructions](#) on page 27.

Steps

1. Align the guide slots on the GPU power interposer board (PIB) with the guide pins on the chassis.
2. Slide the GPU PIB until the release pin locks into place and secures the PIB.

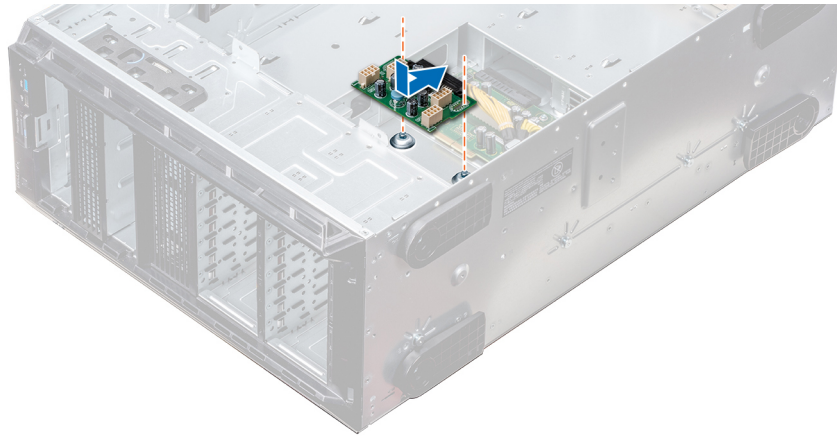

Figure 124. Installing the GPU power interposer board

Next steps

1. [Install the system board.](#)
2. [Install the PSUs.](#)
3. Follow the procedure listed in [After working inside your system](#) on page 28.

Removing the main power interposer board

Prerequisites

CAUTION: To prevent damage to the main power interposer board (PIB), you must remove the power supply units (PSUs) from the system before removing the PIBs.

1. Follow the safety guidelines listed in [Safety instructions](#) on page 27.
2. Follow the procedure listed in [Before working inside your system](#) on page 28.
3. [Remove the PSUs.](#)
4. [Remove the system board.](#)
5. If installed, [remove the GPU PIB.](#)

Steps

1. Disconnect all the power cables from the main PIB.
2. Using the Phillips #2 screwdriver, remove the screws that secure the main PIB to the system.
3. Lift the main PIB out of the system.

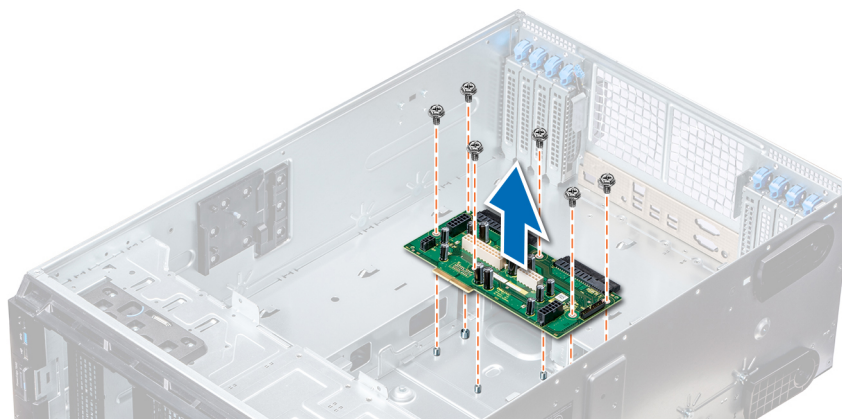

Figure 125. Removing the main PIB

Next steps

1. [Install the main power interposer board.](#)

Installing the main power interposer board

Prerequisites

Follow the safety guidelines listed in [Safety instructions](#) on page 27.

Steps

1. Align the screw holes on the main power interposer board (PIB) with the holes on the system chassis.
2. Using the Phillips #2 screwdriver, secure the main PIB to the system using the screws.
3. Connect all the disconnected power cables to the main PIB.

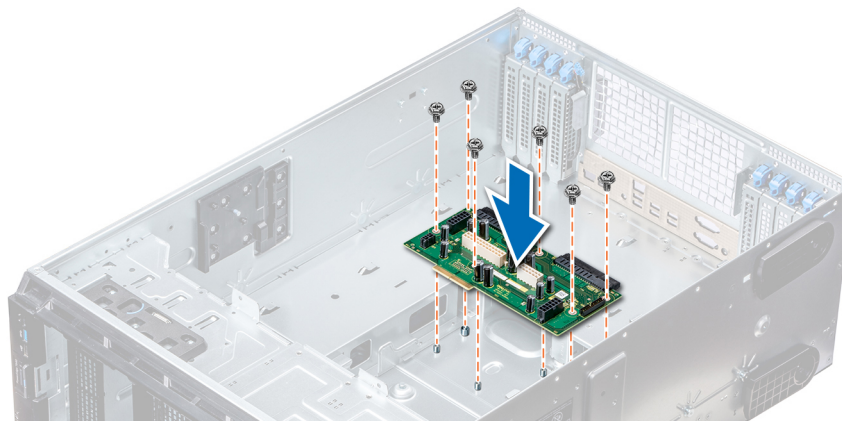

Figure 126. Installing the main power interposer board

Next steps

1. If removed, [install the GPU PIB.](#)
2. [Install the system board.](#)
3. [Install the power supply units.](#)
4. Follow the procedure listed in [After working inside your system](#) on page 28.

Converting the system from tower mode to rack mode

Your system can be converted from the tower mode to the rack mode.

To convert your system from the tower mode to the rack mode, you require the tower to rack conversion kit, which contains the following:

- Rack ears (left and right) with three screws each
- VGA module
- VGA cable
- Rack slide cover
- Mylar cover

Converting the system from tower mode to rack mode

Prerequisites

1. Follow the safety guidelines listed in [Safety instructions](#) on page 27.
2. Follow the procedure listed in [Before working inside your system](#) on page 28.

3. Lay the system on a flat, stable surface.
4. [Remove the system cover.](#)
5. If installed, [remove the system feet](#) or [caster wheels](#).

Steps

1. Remove the system top cover.
2. Remove the control-panel assembly.
3. Install the rack slide cover by performing the following steps:
 - a. Slide the rack slide cover between the system's side cover and the chassis.
 - b. Slide the rack slide cover toward the back of the system until the tabs on rack slide cover locks with the tabs extending from the chassis.

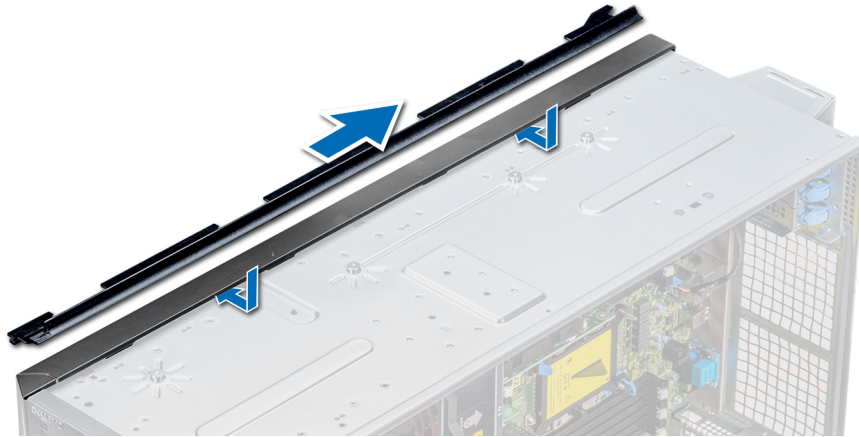

Figure 127. Installing the rack slide cover

4. Install the control panel assembly.
5. Attach the mylar to cover the screw hole on the chassis where one of the system rear feet was installed while in the tower mode.



Figure 128. Attaching the mylar cover

6. Install the rack ears by performing the following steps:
 - a. Align the three screw holes on the rack ears with the screw holes on the top and the bottom of system.
 - b. Using a Phillips #2 screwdriver, secure the rack ears to the system.



Figure 129. Installing the system ears

Next steps

1. [Install the system cover.](#)
2. Install the system in the rack. For more information, see the Rack Installation Guide that is shipped with your system.
3. Follow the procedure listed in [After working inside your system](#) on page 28.

System diagnostics

If you experience a problem with your system, run the system diagnostics before contacting Dell for technical assistance. The purpose of running system diagnostics is to test your system hardware without using additional equipment or risking data loss. If you are unable to fix the problem yourself, service and support personnel can use the diagnostics results to help you solve the problem.

Topics:

- [Dell Embedded System Diagnostics](#)

Dell Embedded System Diagnostics

NOTE: The Dell Embedded System Diagnostics is also known as Enhanced Pre-boot System Assessment (ePSA) diagnostics.

The Embedded System Diagnostics provides a set of options for particular device groups or devices allowing you to:

- Run tests automatically or in an interactive mode
- Repeat tests
- Display or save test results
- Run thorough tests to introduce additional test options to provide extra information about the failed device(s)
- View status messages that inform you if tests are completed successfully
- View error messages that inform you of problems encountered during testing

Running the Embedded System Diagnostics from Boot Manager

Run the Embedded System Diagnostics (ePSA) if your system does not boot.

Steps

1. When the system is booting, press F11.
2. Use the up arrow and down arrow keys to select **System Utilities > Launch Diagnostics**.
3. Alternatively, when the system is booting, press F10, select **Hardware Diagnostics > Run Hardware Diagnostics**. The **ePSA Pre-boot System Assessment** window is displayed, listing all devices detected in the system. The diagnostics starts executing the tests on all the detected devices.

Running the Embedded System Diagnostics from the Dell Lifecycle Controller

Steps

1. As the system boots, press F10.
2. Select **Hardware Diagnostics → Run Hardware Diagnostics**. The **ePSA Pre-boot System Assessment** window is displayed, listing all devices detected in the system. The diagnostics starts executing the tests on all the detected devices.

System diagnostic controls

Menu	Description
Configuration	Displays the configuration and status information of all detected devices.

Menu	Description
Results	Displays the results of all tests that are run.
System health	Provides the current overview of the system performance.
Event log	Displays a time-stamped log of the results of all tests run on the system. This is displayed if at least one event description is recorded.

Getting help

Topics:

- [Contacting Dell EMC](#)
- [Documentation feedback](#)
- [Accessing system information by using QRL](#)
- [Receiving automated support with SupportAssist](#)
- [Recycling or End-of-Life service information](#)

Contacting Dell EMC

Dell EMC provides several online and telephone based support and service options. If you do not have an active internet connection, you can find contact information about your purchase invoice, packing slip, bill, or Dell EMC product catalog. Availability varies by country and product, and some services may not be available in your area. To contact Dell EMC for sales, technical assistance, or customer service issues:

Steps

1. Go to www.dell.com/support/home.
2. Select your country from the drop-down menu on the lower right corner of the page.
3. For customized support:
 - a. Enter your system Service Tag in the **Enter your Service Tag** field.
 - b. Click **Submit**.
The support page that lists the various support categories is displayed.
4. For general support:
 - a. Select your product category.
 - b. Select your product segment.
 - c. Select your product.
The support page that lists the various support categories is displayed.
5. For contact details of Dell EMC Global Technical Support:
 - a. Click [Global Technical Support](#).
 - b. Enter your system Service Tag in the **Enter your Service Tag** field on the Contact Us webpage.

Documentation feedback

You can rate the documentation or write your feedback on any of our Dell EMC documentation pages and click **Send Feedback** to send your feedback.

Accessing system information by using QRL

You can use the Quick Resource Locator (QRL) located on the information tag in the front of the system, to access the information about the PowerEdge system.

Prerequisites

Ensure that your smartphone or tablet has the QR code scanner installed.

The QRL includes the following information about your system:

- How-to videos

- Reference materials, including the Installation and Service Manual, and mechanical overview
- Your system service tag to quickly access your specific hardware configuration and warranty information
- A direct link to Dell to contact technical assistance and sales teams

Steps

1. Go to www.dell.com/qrl and navigate to your specific product or
2. Use your smartphone or tablet to scan the model-specific Quick Resource (QR) code on your system or in the Quick Resource Locator section.

Quick Resource Locator for PowerEdge T640



Figure 130. Quick Resource Locator for PowerEdge T640

Receiving automated support with SupportAssist

Dell EMC SupportAssist is an optional Dell EMC Services offering that automates technical support for your Dell EMC server, storage, and networking devices. By installing and setting up a SupportAssist application in your IT environment, you can receive the following benefits:

- **Automated issue detection** — SupportAssist monitors your Dell EMC devices and automatically detects hardware issues, both proactively and predictively.
- **Automated case creation** — When an issue is detected, SupportAssist automatically opens a support case with Dell EMC Technical Support.
- **Automated diagnostic collection** — SupportAssist automatically collects system state information from your devices and uploads it securely to Dell EMC. This information is used by Dell EMC Technical Support to troubleshoot the issue.
- **Proactive contact** — A Dell EMC Technical Support agent contacts you about the support case and helps you resolve the issue.

The available benefits vary depending on the Dell EMC Service entitlement purchased for your device. For more information about SupportAssist, go to www.dell.com/supportassist.

Recycling or End-of-Life service information

Take back and recycling services are offered for this product in certain countries. If you want to dispose of system components, visit www.dell.com/recyclingworldwide and select the relevant country.