



Dell PowerEdge FC830 Owner's Manual

Regulatory Model: E03B
Regulatory Type: E03B001



Notes, cautions, and warnings

-  **NOTE:** A NOTE indicates important information that helps you make better use of your computer.
-  **CAUTION:** A CAUTION indicates either potential damage to hardware or loss of data and tells you how to avoid the problem.
-  **WARNING:** A WARNING indicates a potential for property damage, personal injury, or death.

© 2016 Dell Inc. All rights reserved. This product is protected by U.S. and international copyright and intellectual property laws. Dell and the Dell logo are trademarks of Dell Inc. in the United States and/or other jurisdictions. All other marks and names mentioned herein may be trademarks of their respective companies.

2016 - 06

Rev. A01

Contents

1 Dell PowerEdge FC830 system overview.....	8
Supported configurations for the PowerEdge FC830 system.....	8
Front panel.....	9
Front panel view—2.5-inch hard drive or SSD system.....	10
Front panel view—1.8-inch SSD system.....	11
Using USB diskette or USB DVD or CD drives.....	11
Diagnostic indicators on the front panel.....	12
Hard drive or SSD indicator patterns.....	12
iDRAC Direct LED indicator codes.....	13
Locating Service Tag of your system.....	14
2 Documentation resources.....	15
3 Technical specifications.....	18
Chassis dimensions.....	18
Chassis weight.....	18
Processor specification.....	18
System battery specification.....	18
Memory specifications.....	18
RAID controller specifications.....	19
Drive specifications.....	19
Hard drives.....	19
Optical drives.....	19
Flash drive.....	19
Ports and connectors specifications.....	19
USB ports.....	19
SD cards.....	19
PCIe mezzanine card specification.....	19
Video specifications.....	20
Environmental specifications.....	20
Particulate and gaseous contamination specifications	21
Expanded operating temperature.....	22
4 Initial system setup and configuration.....	23
Setting up your system.....	23
iDRAC configuration.....	23
Options to set up iDRAC IP address.....	23
Options to install the operating system.....	24

Methods to download firmware and drivers.....	25
5 Pre-operating system management applications.....	26
Options to manage the pre-operating system applications.....	26
System Setup.....	26
Viewing System Setup.....	27
System Setup details.....	27
System BIOS.....	28
iDRAC Settings utility.....	50
Device Settings.....	51
Dell Lifecycle Controller.....	51
Embedded systems management.....	51
Boot Manager.....	52
Viewing Boot Manager.....	52
Boot Manager main menu.....	52
PXE boot.....	53
6 Installing and removing sled components.....	54
Safety instructions.....	54
Before working inside your system.....	54
After working inside your system.....	54
Recommended tools.....	54
Sled.....	55
Removing the sled.....	55
Installing the sled.....	56
Inside the sled.....	58
Cooling shroud.....	59
Removing the cooling shroud.....	59
Installing the cooling shroud.....	60
Cooling shroud retention bar.....	62
Removing the cooling shroud retention bar.....	62
Installing the cooling shroud retention bar.....	63
System memory.....	65
General memory module installation guidelines.....	67
Mode-specific guidelines.....	68
Sample memory configurations.....	69
Removing memory modules.....	73
Installing memory modules.....	74
Processor blank and DIMM blank.....	76
Removing a processor blank and DIMM blank.....	77
Installing a processor blank and DIMM blank.....	78
Processors.....	79

Removing a heat sink.....	80
Removing a processor.....	81
Installing a processor.....	85
Installing a heat sink.....	86
PCIe mezzanine card.....	88
Removing a PCIe mezzanine card.....	88
Installing a PCIe mezzanine card.....	90
PCIe mezzanine card support bracket.....	91
Removing the PCIe mezzanine card support bracket.....	91
Installing the PCIe mezzanine card support bracket.....	92
Internal dual SD module (optional).....	94
Replacing an SD card.....	94
Internal USB key.....	95
Removing the IDSDM card.....	97
Installing the IDSDM card.....	98
rSPI card (optional).....	99
Removing the optional rSPI card.....	100
Installing the optional rSPI card.....	101
SD vFlash card.....	102
Replacing the SD vFlash card.....	102
Network daughter card.....	104
Removing the NDC.....	104
Installing the NDC.....	106
Hard drives or SSDs.....	107
Hard-drive or SSD bay numbering.....	108
Hard drive or SSD installation guidelines.....	109
Removing a hard drive or SSD.....	109
Installing a hard drive or SSD.....	110
Removing a hard drive or SSD blank.....	112
Installing a hard drive or SSD blank.....	113
Shutdown procedure for servicing a hard drive or SSD.....	115
Configuring the boot drive.....	115
Removing a 2.5-inch hard drive or SSD from a 2.5-inch hard drive or SSD carrier.....	115
Installing a 2.5-inch hard drive or SSD in a 2.5-inch hard-drive or SSD carrier.....	116
Removing a 1.8-inch SSD from a 1.8-inch SSD carrier	117
Installing a 1.8-inch SSD in a 1.8-inch SSD carrier.....	118
Hard-drive or SSD cage.....	119
Removing the hard-drive or SSD cage.....	119
Installing the hard-drive or SSD cage.....	120
Hard drive or SSD backplane.....	122
Removing a 2.5 inch (x8) SATA hard-drive or SSD backplane.....	123
Installing a 2.5-inch (x8) SATA hard-drive or SSD backplane.....	125

Removing a 2.5-inch (x8) SAS hard-drive or SSD backplane.....	127
Installing a 2.5-inch (x8) SAS hard-drive or SSD backplane.....	129
Removing a 2.5-inch (x6) SATA hard drive or SSD and 2.5-inch (x2) PCIe SSD backplane.....	131
Installing a 2.5-inch (x6) SATA hard drive or SSD and 2.5-inch (x2) PCIe SSD backplane.....	133
Removing a 1.8-inch (x16) SAS SSD backplane.....	136
Installing a 1.8-inch (x16) SAS SSD backplane.....	139
Storage controller card.....	140
Removing the storage controller card.....	141
Installing the storage controller card.....	142
Expander card.....	144
Removing an expander card.....	144
Installing an expander card.....	146
System battery.....	148
Replacing the NVRAM backup battery.....	148
System board.....	150
Removing the system board.....	150
Installing the system board.....	154
Restoring the Service Tag by using the Easy Restore feature.....	156
Entering the system Service Tag by using System Setup.....	157
Trusted Platform Module.....	157
Installing the Trusted Platform Module.....	157
Initializing the TPM for BitLocker users.....	158
Initializing the TPM for TXT users.....	158
7 Using system diagnostics.....	160
Dell Embedded System Diagnostics.....	160
When to use the Embedded System Diagnostics.....	160
Running the Embedded System Diagnostics.....	160
Running embedded system diagnostics from an external media.....	161
System diagnostics controls.....	161
8 Jumpers and connectors	162
System board jumper settings.....	162
System board connectors.....	163
Disabling a forgotten password.....	164
9 Troubleshooting your system.....	166
Safety first — for you and your system.....	166
Troubleshooting system memory.....	166
Troubleshooting hard drives.....	167
Troubleshooting Solid State Drives.....	168
Troubleshooting USB devices.....	168

Troubleshooting an internal SD card.....	169
Troubleshooting processors.....	169
Troubleshooting the system board.....	170
Troubleshooting the NVRAM backup battery.....	170
10 Getting help.....	172
Contacting Dell.....	172
Accessing system information by using QRL.....	172
Quick Resource Locator.....	173

Dell PowerEdge FC830 system overview

The Dell PowerEdge FC830 system is a full-height sled that is configured for the PowerEdge FX2/FX2s enclosure. The Dell PowerEdge FC830 system supports up to:

- Four Intel Xeon E5-4600 v4 or v3 processors
- 48 DIMMs
- Eight 2.5-inch hot-swappable hard drives or SSDs
- Sixteen 1.8-inch hot-swappable SSDs

Supported configurations for the PowerEdge FC830 system

The Dell PowerEdge FC830 system supports the following configurations:

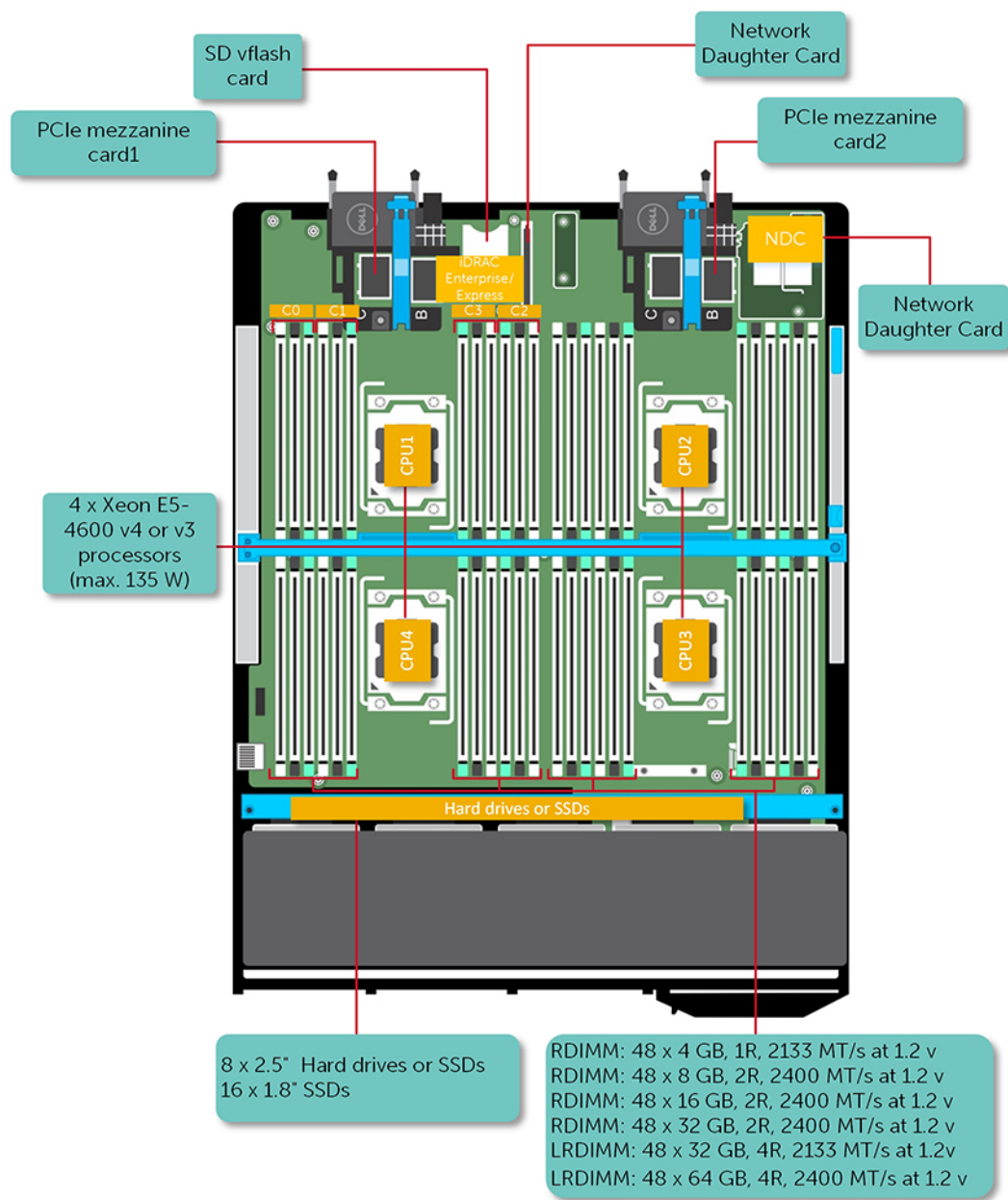

Figure 1. Supported configurations for the Dell PowerEdge FC830 system

Front panel

The front panel provides access to the features available on the front of the server, such as the power button, status indicator, management indicator, and USB ports. The diagnostic LEDs or the LCD panel is

prominently located on the front panel. The hot-swappable hard drives are accessible from the front panel.

Front panel view—2.5-inch hard drive or SSD system

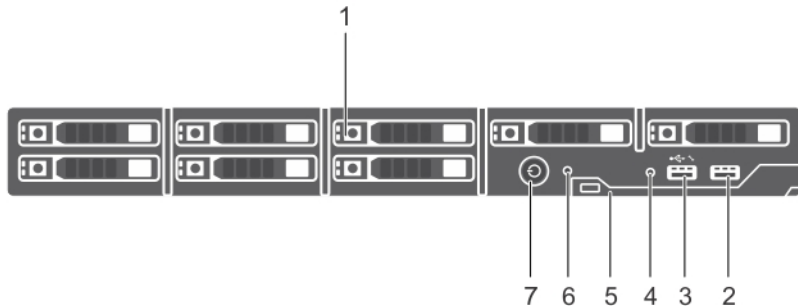





Figure 2. Front panel view—2.5 inch hard drive or SSD system

Table 1. Front panel features and indicators—2.5-inch hard drive or SSD system

Item	Indicator, Button, or Connector	Icon	Description
1	Hard drives or SSDs		Eight 2.5-inch hot-swappable SAS/SATA/PCIe SSDs or SAS/SATA hard drives.
2	USB port		Enables you to connect USB devices to the sled.
3	USB management port or iDRAC Direct port		Enables you to connect USB devices to the sled or provides access to the iDRAC Direct features. For more information about iDRAC, see the iDRAC Guide at Dell.com/idracmanuals .
4	Management indicator		The management indicator glows when the iDRAC controls the USB connector for management functions.
5	Sled handle		Used to slide the sled out of the enclosure.
6	Status indicator		Indicates the status of the system.
7	Sled power-on indicator, power button		The power-on indicator glows when the sled is turned on. The power button controls the power supply output to the system.

Front panel view—1.8-inch SSD system

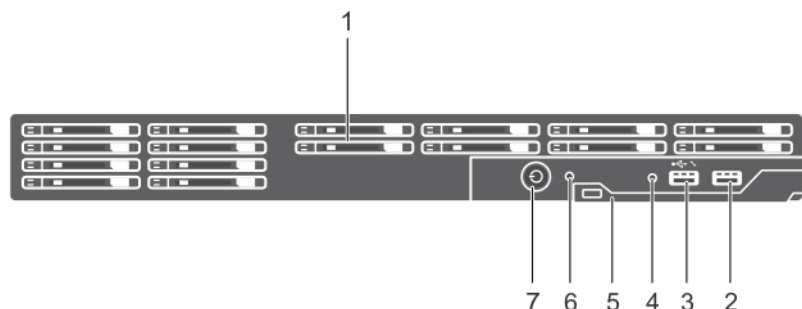





Figure 3. Front panel view—1.8-inch SSD system

Table 2. Front panel features and indicators—1.8-inch SSD system

Item	Indicator, Button, or Connector	Icon	Description
1	SSDs		Sixteen 1.8-inch hot-swappable SAS SSDs.
2	USB management port		Enables you to connect USB devices to the sled.
3	USB management port or iDRAC Direct port		Enables you to connect USB devices to the sled or provides access to the iDRAC Direct features. For more information about iDRAC, see the iDRAC Guide at Dell.com/idracmanuals .
4	Management indicator		The management indicator glows when the iDRAC controls the USB connector for management functions.
5	Sled handle		Used to slide the sled out of the enclosure.
6	Status indicator		Indicates the status of the system.
7	Sled power-on indicator, power button		The power-on indicator glows when the sled is turned on. The power button controls the power supply output to the system.

Using USB diskette or USB DVD or CD drives

The sled has USB ports on the front which allows you to connect a USB diskette drive, USB flash drive, USB DVD or CD drive, keyboard, or mouse device. The USB drives can be used to configure the sled.

To designate the USB diskette drive as the boot drive:

1. Connect the USB drive

2. Restart the system
3. Enter System Setup
4. Set the drive as first in the boot sequence

The USB device is displayed in the Boot Order Setup screen only if it is attached to the system before you run the System Setup. You can also select the boot device by pressing F11 during system start-up and selecting a boot device for the current boot sequence.

Diagnostic indicators on the front panel

Hard drive or SSD indicator patterns

The hard drive or SSD (Solid-State Drives) indicators display different patterns as drive events occur in the system.

 **NOTE:** The sled must have a hard drive or SSD or a hard drive blank installed in each drive bay.

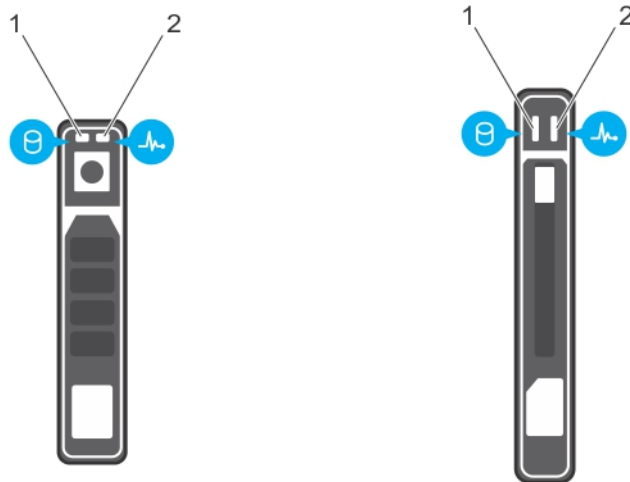

Figure 4. Hard drive or SSD indicators

1. drive activity indicator (green)
2. drive status indicator (green and amber)



 **NOTE:** If the drive is in Advanced Host Controller Interface (AHCI) mode, the status LED (on the right side) does not function and remains off.

Table 3. Drive status indicator codes

Drive-status indicator pattern	Condition
Flashes green twice per second	Identifying drive or preparing for removal.
Off	Drive ready for insertion or removal.

Drive-status indicator pattern	Condition
	 NOTE: The drive status indicator remains off until all hard drives are initialized after the system is turned on. Drives are not ready for insertion or removal during this time.
Flashes green, amber, and turns off	Predicted drive failure
Flashes amber four times per second	Drive failed
Steady green	Drive online
Flashes green for three seconds, amber for three seconds, and turns off after six seconds	Rebuild aborted

iDRAC Direct LED indicator codes

 **NOTE:** The iDRAC Direct LED indicator does not turn on when the USB port is used in the USB mode.

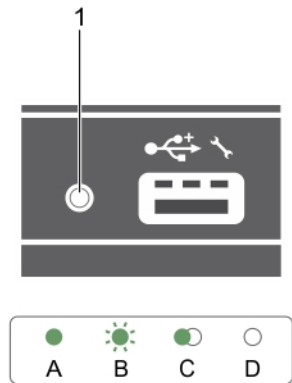

Figure 5. iDRAC Direct LED indicator

1. iDRAC Direct status indicator

The iDRAC Direct LED indicator table describes iDRAC Direct activity when configuring iDRAC Direct by using the management port (USB XML Import).

Table 4. iDRAC Direct LED indicator

Convention	iDRAC Direct LED indicator	Condition
A	Green	Turns green for a minimum of two seconds to indicate the start and end of a file transfer.
B	Flashing green	Indicates file transfer or any operation tasks.
C	Green and turns off	Indicates that the file transfer is complete.

Convention	iDRAC Direct LED indicator	Condition
D	Not lit	Indicates that the USB is ready to be removed or that a task is complete.

The iDRAC Direct LED indicator table describes iDRAC Direct activity when configuring iDRAC Direct by using your laptop and cable (Laptop Connect):

Table 5. iDRAC Direct LED indicator

iDRAC Direct LED indicator	Condition
Solid green for two seconds	Indicates that the laptop is connected.
Flashing green (on for two seconds and off for two seconds)	Indicates that the laptop connected is recognized.
Turns off	Indicates that the laptop is unplugged.

Locating Service Tag of your system

Your system is identified by a unique Express Service Code and Service Tag number. The Express Service Code and Service Tag are found on the front of the system by pulling out the information tag. Alternatively, the information may be on a sticker on the chassis of the system. This information is used by Dell to route support calls to the appropriate personnel.

Documentation resources

This section provides information about the documentation resources for your system.

Table 6. Additional documentation resources for your system

Task	Document	Location
Setting up your system	For information about installing the system into a rack, see the Rack documentation included with your rack solution.	Dell.com/poweredgemanuals
	For information about turning on the system and the technical specifications of your system, see the <i>Getting Started With Your System</i> document that is shipped with your system.	Dell.com/poweredgemanuals
Configuring your system	For information about iDRAC features, configuring and logging in to iDRAC, and managing your system remotely, see the Integrated Dell Remote Access Controller User's Guide.	Dell.com/idracmanuals
	For information about installing the operating system, see the operating system documentation.	Dell.com/operatingsystemmanuals
	For information about understanding Remote Access Controller Admin (RACADM) subcommands and supported RACADM interfaces, see the RACADM Command Line Reference Guide for iDRAC.	Dell.com/idracmanuals
	For information about updating drivers and firmware, see the Methods to download firmware and drivers section in this document.	Dell.com/support/drivers
Managing your system	For information about systems management software offered by Dell, see the Dell OpenManage Systems Management Overview Guide.	Dell.com/openmanagemanuals
	For information about setting up, using, and troubleshooting	Dell.com/openmanagemanuals

Task	Document	Location
	OpenManage, see the Dell OpenManage Server Administrator User's Guide.	
	For information about installing, using, and troubleshooting Dell OpenManage Essentials, see the Dell OpenManage Essentials User's Guide.	Dell.com/openmanagemanuals
	For information about installing and using Dell System E-Support Tool (DSET), see the Dell System E-Support Tool (DSET) User's Guide.	Dell.com/DSET
	For information about installing and using Active System Manager (ASM), see the Active System Manager User's Guide.	Dell.com/asmdocs
	For understanding the features of Dell Lifecycle Controller (LCC), see the Dell Lifecycle Controller User's Guide.	Dell.com/idracmanuals
	For information about partner programs enterprise systems management, see the OpenManage Connections Enterprise Systems Management documents.	Dell.com/omconnectionsenterprisesystemsmanagement
	For information about connections and client systems management, see the OpenManage Connections Client Systems Management documentation.	Dell.com/dellclientcommandsuite manuals
	For information about viewing inventory, performing configuration and monitoring tasks, remotely turning on or off servers, and enabling alerts for events on servers and components using the Dell Chassis Management Controller (CMC), see the CMC User's Guide.	Dell.com/esmmanuals
Working with Dell PowerEdge RAID controllers	For information about understanding the features of the Dell PowerEdge RAID controllers (PERC) and deploying the PERC cards, see the Storage controller documentation.	Dell.com/storagecontrollermanuals
Understanding event and error messages	For information about checking the event and error messages generated by the system firmware and agents that monitor system components, see	Dell.com/openmanagemanuals > OpenManage software

Task	Document	Location
	the Dell Event and Error Messages Reference Guide.	

Technical specifications

The technical and environmental specifications of your system are outlined in this section.

Chassis dimensions

Table 7. Dimensions of the Dell PowerEdge FC830 system

System	Dimension in mm		
	X	Y	Z
FC830	427.6	40.3	538.1

Chassis weight

Maximum chassis weight of the PowerEdge FC830 system is 13.0 kg (28.66 lb).

Processor specification

The PowerEdge FC830 system supports up to four Intel Xeon E5-4600 v3 or v4 product family processors.

System battery specification

The PowerEdge FC830 system supports CR 2032 3.0-V lithium coin cell system battery.

Memory specifications

The PowerEdge FC830 system supports DDR4 registered DIMMs and LV-DDR4 DIMMs at 2400 MT/s, 2133 MT/s, and 1866 MT/s.

Table 8. Memory specifications

Memory module socket	Memory capacity	Minimum RAM	Maximum RAM
Forty-eight 240-pin	<ul style="list-style-type: none"> 4 GB single rank (RDIMMs) 8 GB, 16 GB or 32 GB dual rank (RDIMMs) 32 GB or 64 GB quad rank (LRDIMMs) 	4 GB with dual processor	1.5 TB with four processor

RAID controller specifications

The PowerEdge FC830 system supports PERC H330, PERC H730, and PERC H730P controllers.

Drive specifications

Hard drives

The PowerEdge FC830 system supports:

- Up to eight 2.5-inch SAS/SATA/PCIe SSDs or SAS/SATA hard drives
- Up to sixteen 1.8-inch SAS SSDs

Optical drives

The PowerEdge FC830 system supports external optional USB DVD optical drive.

 **NOTE:** DVD devices support only data.

Flash drive

The PowerEdge FC830 system supports:

- Internal optional USB
- Internal optional SD card
- Optional vFlash card (with integrated iDRAC Enterprise)

Ports and connectors specifications

USB ports

The PowerEdge FC830 system supports:

- One 4-pin, USB 2.0-compliant and one 9-pin, USB 3.0-compliant on the front panel
- Internal two 4-pin, USB 2.0-compliant

SD cards

The PowerEdge FC830 system supports two internal SD cards dedicated for the hypervisor.

 **NOTE:** One SD card is dedicated for future vFlash support.

PCIe mezzanine card specification

The PowerEdge FC830 system supports two PCIe x16 Gen 3 slots mezzanine cards.

Video specifications

The PowerEdge FC830 system supports Matrox G200 VGA controller integrated with iDRAC and 2 GB video memory is shared with iDRAC application memory.

Environmental specifications

 **NOTE:** For additional information about environmental measurements for specific system configurations, see Dell.com/environmental_datasheets.

Table 9. Temperature specifications

Temperature	Specifications
Storage	–40°C to 65°C (–40°F to 149°F)
Continuous operation (for altitude less than 950 m or 3117 ft)	10°C to 35°C (50°F to 95°F) with no direct sunlight on the equipment
Fresh air	For information about fresh air, see the Expanded Operating Temperature section.
Maximum temperature gradient (operating and storage)	20°C/h (36°F/h)

Table 10. Relative humidity specifications

Relative humidity	Specifications
Storage	5% to 95% RH with 33°C (91°F) maximum dew point. Atmosphere must be non-condensing at all times.
Operating	10% to 80% RH with 29°C (84.2°F) maximum dew point.

Table 11. Maximum vibration specifications

Maximum vibration	Specifications
Operating	0.26 G _{rms} at 5 Hz to 350 Hz (all operation orientations)
Storage	1.88 G _{rms} at 10 Hz to 500 Hz for 15 minutes (all six sides tested)

Table 12. Maximum shock pulse specifications

Maximum shock pulse	Specifications
Operating	Six consecutively executed shock pulses in the positive and negative x, y, and z axes of 40 G for up to 2.3 ms.
Storage	Six consecutively executed shock pulses in the positive and negative x, y, and z axes (one pulse on each side of the system) of 71 G for up to 2 ms.

Table 13. Maximum altitude specifications

Maximum altitude	Specifications
Operating	3048 m (10,000 ft)
Storage	12,000 m (39,370 ft)

Table 14. Operating temperature de-rating specification

Operating temperature de-rating	Specifications
Up to 35°C (95°F)	Maximum temperature is reduced by 1°C/300 m (1°F/547 ft), above 950 m (3,117 ft).
35 °C to 40 °C (95 °F to 104 °F)	Maximum temperature is reduced by 1°C/175 m (1°F/319 ft), above 950 m (3,117 ft).
40 °C to 45 °C (104 °F to 113 °F)	Maximum temperature is reduced by 1°C/125 m (1°F/228 ft), above 950 m (3,117 ft).

Particulate and gaseous contamination specifications

The following table defines the limitations that will help avoid any damages to the IT equipment and/or failure from particulates and gaseous contamination. If the levels of particulates or gaseous pollution exceed the specified limitations and result in equipment damage or failure, you may need to rectify the environmental conditions. Re-mediation of environmental conditions is the responsibility of the customer.

Table 15. Particulate contamination specifications





Particulate contamination	Specifications
Air Filtration	<p>Data center air filtration as defined by ISO Class 8 per ISO 14644-1 with a 95% upper confidence limit.</p> <p> NOTE: This condition applies to data center environments only. Air filtration requirements do not apply to IT equipment designed to be used outside a data center, in environments such as an office or factory floor.</p> <p> NOTE: Air entering the data center must have MERV11 or MERV13 filtration.</p>
Conductive dust	<p>Air must be free of conductive dust, zinc whiskers, or other conductive particles.</p> <p> NOTE: This condition applies to data center and nondata center environments.</p>
Corrosive dust	<ul style="list-style-type: none">• Air must be free of corrosive dust.• Residual dust present in the air must have a deliquescent point less than 60% relative humidity. <p> NOTE: This condition applies to data center and nondata center environments.</p>



Table 16. Gaseous contamination specifications

Gaseous contamination	Specifications
Copper Coupon Corrosion	<300 Å/month per Class G1 as defined by ANSI/ISA71.04-1985.
Silver Coupon Corrosion	<200 Å/month as defined by AHSRAE TC9.9.

 **NOTE:** Maximum corrosive contaminant levels measured at ≤50% relative humidity.

Expanded operating temperature

Table 17. Expanded operating temperature specifications

Expanded operating temperature	Specifications
Continuous operation	<p>5°C to 40°C at 5% to 85% RH with 29°C dew point.</p> <p> NOTE: Outside the standard operating temperature (10°C to 35°C), the system can operate continuously in temperatures as low as 5°C and as high as 40°C.</p> <p>For temperatures between 35°C and 40°C, de-rate maximum allowable temperature by 1°C per 175 m (1°F per 319 ft.) above 950 m (3,117 ft.).</p>
≤ 1% of annual operating hours	<p>–5°C to 45°C at 5% to 90% RH with 29°C dew point.</p> <p> NOTE: Outside the standard operating temperature (10°C to 35°C), the system can operate down to –5°C or up to 45°C for a maximum of 1% of its annual operating hours.</p> <p>For temperatures between 40°C and 45°C, de-rate maximum allowable temperature by 1°C per 125 m (1°F per 228 ft.) above 950 m (3,117 ft.).</p>

 **NOTE:** When operating in the expanded temperature range, the performance of the system may be impacted.

 **NOTE:** When operating in the expanded temperature range, ambient temperature warnings may be reported on the LCD panel and in the System Event Log.

Initial system setup and configuration

Setting up your system

Complete the following steps to set up your system:

1. Unpack the sled.
2. Remove the I/O connector cover from the sled connectors.

 **CAUTION:** While installing the sled, ensure that it is properly aligned with the slot on the enclosure to prevent damage to the sled connectors.

3. Install the sled in the enclosure.
4. Turn on the enclosure.

 **NOTE:** Wait for the chassis to initialize before you press the power button.

5. Turn on the sled by pressing the power button on the sled.

Alternatively, you can also turn on the sled by using:

- The sled iDRAC. For more information, see the Log in to iDRAC section.
- The enclosure Chassis Management Controller (CMC), after the sled iDRAC is configured on the CMC. For more information, see the *CMC User's Guide* at Dell.com/idracmanuals.

Related Links

[Log in to iDRAC](#)

iDRAC configuration

The Integrated Dell Remote Access Controller (iDRAC) is designed to make system administrators more productive and improve the overall availability of Dell systems. iDRAC alerts administrators to system issues, helps them perform remote system management, and reduces the need for physical access to the system.

Options to set up iDRAC IP address

You must configure the initial network settings based on your network infrastructure to enable the communication to and from iDRAC. You can set up the IP address by using one of the following interfaces:

Interfaces	Document/Section
iDRAC Settings utility	See <i>Dell Integrated Dell Remote Access Controller User's Guide</i> at Dell.com/idracmanuals
Dell Deployment Toolkit	See <i>Dell Deployment Toolkit User's Guide</i> at Dell.com/openmanagemanuals

Interfaces	Document/Section
Dell Lifecycle Controller	See <i>Dell Lifecycle Controller User's Guide</i> at Dell.com/idracmanuals
CMC Web interface	See <i>Dell Chassis Management Controller Firmware User's Guide</i> at Dell.com/esmanuals

You must use the default iDRAC IP address 192.168.0.120 to configure the initial network settings, including setting up DHCP or a static IP for iDRAC.

 **NOTE:** To access iDRAC, ensure that you install the iDRAC port card or connect the network cable to the Ethernet connector 1 on the system board.

 **NOTE:** Ensure that you change the default user name and password after setting up the iDRAC IP address.

Log in to iDRAC

You can log in to iDRAC as:

- iDRAC user
- Microsoft Active Directory user
- Lightweight Directory Access Protocol (LDAP) user

The default user name and password are `root` and `calvin`. You can also log in by using Single Sign-On or Smart Card.

 **NOTE:** You must have iDRAC credentials to log in to iDRAC.

For more information about logging in to iDRAC and iDRAC licenses, see the *Integrated Dell Remote Access Controller User's Guide* at Dell.com/idracmanuals.

Options to install the operating system

If the system is shipped without an operating system, install the supported operating system by using one of the following resources:

Table 18. Resources to install the operating system

Resources	Location
Dell Systems Management Tools and Documentation media	Dell.com/operatingsystemmanuals
Dell Lifecycle Controller	Dell.com/idracmanuals
Dell OpenManage Deployment Toolkit	Dell.com/openmanagemanuals
Dell certified VMware ESXi	Dell.com/virtualizationsolutions
Supported operating systems on Dell PowerEdge systems	Dell.com/ossupport
Installation and How-to videos for supported operating systems on Dell PowerEdge systems	Supported Operating Systems for Dell PowerEdge Systems

Methods to download firmware and drivers

You can download the firmware and drivers by using any of the following methods:

Table 19. Firmware and drivers

Methods	Location
From the Dell Support site	Dell.com/support/home
Using Dell Remote Access Controller Lifecycle Controller (iDRAC with LC)	Dell.com/idracmanuals
Using Dell Repository Manager (DRM)	Dell.com/openmanagemanuals
Using Dell OpenManage Essentials (OME)	Dell.com/openmanagemanuals
Using Dell Server Update Utility (SUU)	Dell.com/openmanagemanuals
Using Dell OpenManage Deployment Toolkit (DTK)	Dell.com/openmanagemanuals

Downloading the drivers and firmware

Dell recommends that you download and install the latest BIOS, drivers, and systems management firmware on your system.

Prerequisites

Ensure that you clear the web browser cache before downloading the drivers and firmware.

Steps

1. Go to **Dell.com/support/drivers**.
2. Under the **Drivers & Downloads** section, type the Service Tag of your system in the **Service Tag or Express Service Code** box, and then click **Submit**.



NOTE: If you do not have the Service Tag, select **Detect My Product** to allow the system to automatically detect your Service Tag, or under General support, navigate to your product.

3. Click **Drivers & Downloads**.
The drivers that are applicable to your selection are displayed.
4. Download the drivers to a USB drive, CD, or DVD.

Pre-operating system management applications

You can manage basic settings and features of a system without booting to the operating system by using the system firmware.

Options to manage the pre-operating system applications

Your system has the following options to manage the pre-operating system applications:

- System Setup
- Boot Manager
- Dell Lifecycle Controller
- Preboot Execution Environment (PXE)

Related Links

[System Setup](#)

[Boot Manager](#)

[Dell Lifecycle Controller](#)

[PXE boot](#)

System Setup

By using the **System Setup** screen, you can configure the BIOS settings, iDRAC settings, and device settings of your system.

 **NOTE:** Help text for the selected field is displayed in the graphical browser by default. To view the help text in the text browser, press F1.

You can access system setup by using two methods:

- Standard graphical browser — The browser is enabled by default.
- Text browser — The browser is enabled by using Console Redirection.

Related Links

[System Setup details](#)

[Viewing System Setup](#)

Viewing System Setup

To view the **System Setup** screen, perform the following steps:

1. Turn on, or restart your system.
2. Press F2 immediately after you see the following message:
F2 = System Setup

 **NOTE:** If your operating system begins to load before you press F2, wait for the system to finish booting, and then restart your system and try again.

Related Links

[System Setup](#)

[System Setup details](#)

System Setup details

The **System Setup Main Menu** screen details are explained as follows:

Option	Description
System BIOS	Enables you to configure BIOS settings.
iDRAC Settings	Enables you to configure iDRAC settings. The iDRAC settings utility is an interface to set up and configure the iDRAC parameters by using UEFI (Unified Extensible Firmware Interface). You can enable or disable various iDRAC parameters by using the iDRAC settings utility. For more information about this utility, see <i>Integrated Dell Remote Access Controller User's Guide</i> at Dell.com/idracmanuals .
Device Settings	Enables you to configure device settings.

Related Links

[System Setup](#)

[Viewing System Setup](#)

[System BIOS](#)

[iDRAC Settings utility](#)

[Device Settings](#)

System BIOS

You can use the **System BIOS** screen to edit specific functions such as boot order, system password, setup password, set the RAID mode, and enable or disable USB ports.

Related Links

- [System BIOS Settings details](#)
- [Boot Settings](#)
- [Network Settings](#)
- [System Security](#)
- [System Information](#)
- [Memory Settings](#)
- [Processor Settings](#)
- [SATA Settings](#)
- [Integrated Devices](#)
- [Serial Communication](#)
- [System Profile Settings](#)
- [Miscellaneous Settings](#)
- [iDRAC Settings utility](#)
- [Device Settings](#)
- [Viewing System BIOS](#)

Viewing System BIOS

To view the **System BIOS** screen, perform the following steps:

1. Turn on, or restart your system.
2. Press F2 immediately after you see the following message:
F2 = System Setup



NOTE: If your operating system begins to load before you press F2, wait for the system to finish booting, and then restart your system and try again.

3. On the **System Setup Main Menu** screen, click **System BIOS**.

Related Links

- [System BIOS](#)
- [System BIOS Settings details](#)

System BIOS Settings details

The **System BIOS Settings** screen details are explained as follows:

Option	Description
System Information	Specifies information about the system such as the system model name, BIOS version, and Service Tag.
Memory Settings	Specifies information and options related to the installed memory.
Processor Settings	Specifies information and options related to the processor such as speed and cache size.
SATA Settings	Specifies options to enable or disable the integrated SATA controller and ports.

Option	Description
Boot Settings	Specifies options to specify the boot mode (BIOS or UEFI). Enables you to modify UEFI and BIOS boot settings.
Network Settings	Specifies options to change the network settings.
Integrated Devices	Specifies options to manage integrated device controllers and ports and specify related features and options.
Serial Communication	Specifies options to manage the serial ports and specify related features and options.
System Profile Settings	Specifies options to change the processor power management settings, memory frequency, and so on.
System Security	Specifies options to configure the system security settings, such as system password, setup password, Trusted Platform Module (TPM) security. It also manages the power and NMI buttons on the system.
Miscellaneous Settings	Specifies options to change the system date, time, and so on.

Related Links

[System BIOS](#)

[Viewing System BIOS](#)

Boot Settings

You can use the **Boot Settings** screen to set the boot mode to either **BIOS** or **UEFI**. It also enables you to specify the boot order.

Related Links

[Boot Settings details](#)

[System BIOS](#)

[Viewing Boot Settings](#)

[Choosing the system boot mode](#)

[Changing the boot order](#)

Viewing Boot Settings

To view the **Boot Settings** screen, perform the following steps:

1. Turn on, or restart your system.
2. Press F2 immediately after you see the following message:
F2 = System Setup



NOTE: If your operating system begins to load before you press F2, wait for the system to finish booting, and then restart your system and try again.

3. On the **System Setup Main Menu** screen, click **System BIOS**.
4. On the **System BIOS** screen, click **Boot Settings**.

Related Links

[Boot Settings](#)



[Boot Settings details](#)

[Choosing the system boot mode](#)

[Changing the boot order](#)

Boot Settings details

The **Boot Settings** screen details are explained as follows:

Option	Description
Boot Mode	<p>Enables you to set the boot mode of the system.</p> <p> CAUTION: Switching the boot mode may prevent the system from booting if the operating system is not installed in the same boot mode.</p> <p>If the operating system supports UEFI, you can set this option to UEFI. Setting this field to BIOS allows compatibility with non-UEFI operating systems. This option is set to BIOS by default.</p> <p> NOTE: Setting this field to UEFI disables the BIOS Boot Settings menu. Setting this field to BIOS disables the UEFI Boot Settings menu.</p>
Boot Sequence Retry	<p>Enables or disables the Boot Sequence Retry feature. If this option is set to Enabled and the system fails to boot, the system reattempts the boot sequence after 30 seconds. This option is set to Enabled by default.</p>
Hard-Disk Failover	<p>Specifies the hard drive that is booted in the event of a hard drive failure. The devices are selected in the Hard-Disk Drive Sequence on the Boot Option Setting menu. When this option is set to Disabled, only the first hard drive in the list is attempted to boot. When this option is set to Enabled, all hard drives are attempted to boot in the order selected in the Hard-Disk Drive Sequence. This option is not enabled for UEFI Boot Mode.</p>
Boot Option Settings	<p>Configures the boot sequence and the boot devices.</p>

Related Links

- [Boot Settings](#)
- [Viewing Boot Settings](#)
- [Choosing the system boot mode](#)
- [Changing the boot order](#)

Choosing the system boot mode

System Setup enables you to specify one of the following boot modes for installing your operating system:

- BIOS boot mode (the default) is the standard BIOS-level boot interface.
 - Unified Extensible Firmware Interface (UEFI) boot mode is an enhanced 64-bit boot interface. If you have configured your system to boot to UEFI mode, it replaces the system BIOS.
1. From the **System Setup Main Menu**, click **Boot Settings**, and select **Boot Mode**.
 2. Select the boot mode you want the system to boot into.

 **CAUTION: Switching the boot mode may prevent the system from booting if the operating system is not installed in the same boot mode.**

3. After the system boots in the specified boot mode, proceed to install your operating system from that mode.

 **NOTE:** Operating systems must be UEFI-compatible to be installed from the UEFI boot mode. DOS and 32-bit operating systems do not support UEFI and can only be installed from the BIOS boot mode.

 **NOTE:** For the latest information about supported operating systems, go to Dell.com/ossupport.

Related Links

[Boot Settings](#)

[Boot Settings details](#)

[Viewing Boot Settings](#)

Changing the boot order

You may have to change the boot order if you want to boot from a USB key or an optical drive. The following instructions may vary if you have selected **BIOS** for **Boot Mode**.

1. On the **System Setup Main Menu** screen, click **System BIOS** → **Boot Settings**.
2. Click **Boot Option Settings** → **Boot Sequence**.
3. Use the arrow keys to select a boot device, and use the plus (+) and minus (-) sign keys to move the device down or up in the order.
4. Click **Exit**, and then click **Yes** to save the settings on exit.

Related Links

[Boot Settings](#)

[Boot Settings details](#)

[Viewing Boot Settings](#)

Network Settings

You can use the **Network Settings** screen to modify PXE device settings. The network settings option is available only in the UEFI mode.

 **NOTE:** The BIOS does not control network settings in the BIOS mode. For the BIOS boot mode, the optional Boot ROM of the network controllers handles the network settings.

Related Links

[UEFI iSCSI Settings](#)

[Network Settings screen details](#)

[UEFI iSCSI Settings details](#)

[System BIOS](#)

[Viewing Network Settings](#)

[Viewing UEFI iSCSI Settings](#)

Viewing Network Settings

To view the **Network Settings** screen, perform the following steps:

1. Turn on, or restart your system.
2. Press F2 immediately after you see the following message:
F2 = System Setup

 **NOTE:** If your operating system begins to load before you press F2, wait for the system to finish booting, and then restart your system and try again.

3. On the **System Setup Main Menu** screen, click **System BIOS**.
4. On the **System BIOS** screen, click **Network Settings**.

Related Links

[Network Settings](#)

[Network Settings screen details](#)

Network Settings screen details

The **Network Settings** screen details are explained as follows:

Option	Description
PXE Device n (n = 1 to 4)	Enables or disables the device. When enabled, a UEFI boot option is created for the device.
PXE Device n Settings(n = 1 to 4)	Enables you to control the configuration of the PXE device.

Related Links

[Network Settings](#)

[Viewing Network Settings](#)

UEFI iSCSI Settings

You can use the iSCSI Settings screen to modify iSCSI device settings. The iSCSI Settings option is available only in the UEFI boot mode. BIOS does not control network settings in the BIOS boot mode. For the BIOS boot mode, the option ROM of the network controller handles the network settings.

Related Links

[UEFI iSCSI Settings details](#)

[Viewing UEFI iSCSI Settings](#)

Viewing UEFI iSCSI Settings

To view the **UEFI iSCSI Settings** screen, perform the following steps:

1. Turn on, or restart your system.
2. Press F2 immediately after you see the following message:
F2 = System Setup
 **NOTE:** If your operating system begins to load before you press F2, wait for the system to finish booting, and then restart your system and try again.
3. On the **System Setup Main Menu** screen, click **System BIOS**.
4. On the **System BIOS** screen, click **Network Settings**.
5. On the **Network Settings** screen, click **UEFI iSCSI Settings**.

Related Links

[UEFI iSCSI Settings](#)

[UEFI iSCSI Settings details](#)

UEFI iSCSI Settings details

The **UEFI iSCSI Settings** screen details are explained as follows:

Option	Description
iSCSI Initiator Name	Specifies the name of the iSCSI initiator (iqn format).
iSCSI Device n (n = 1 to 4)	Enables or disables the iSCSI device. When disabled, a UEFI boot option is created for the iSCSI device automatically.

Related Links

- [UEFI iSCSI Settings](#)
- [Viewing UEFI iSCSI Settings](#)

System Security

You can use the **System Security** screen to perform specific functions such as setting the system password, setup password and disabling the power button.

Related Links

- [System Security Settings details](#)
- [Operating with a setup password enabled](#)
- [System BIOS](#)
- [Viewing System Security](#)
- [Creating a system and setup password](#)
- [Using your system password to secure your system](#)
- [Deleting or changing system and setup password](#)

Viewing System Security

To view the **System Security** screen, perform the following steps:

1. Turn on, or restart your system.
2. Press F2 immediately after you see the following message:
F2 = System Setup



NOTE: If your operating system begins to load before you press F2, wait for the system to finish booting, and then restart your system and try again.

3. On the **System Setup Main Menu** screen, click **System BIOS**.
4. On the **System BIOS** screen, click **System Security**.

Related Links

- [System Security](#)
- [System Security Settings details](#)

System Security Settings details

The **System Security Settings** screen details are explained as follows:

Option	Description
Intel AES-NI	Improves the speed of applications by performing encryption and decryption by using the Advanced Encryption Standard Instruction Set (AES-NI). This option is set to Enabled by default.
System Password	Sets the system password. This option is set to Enabled by default and is read-only if the password jumper is not installed in the system.
Setup Password	Sets the setup password. This option is read-only if the password jumper is not installed in the system.
Password Status	Locks the system password. This option is set to Unlocked by default.
TPM Security	 NOTE: The TPM menu is available only when the TPM module is installed. Enables you to control the reporting mode of the TPM. The TPM Security option is set to Off by default. You can only modify the TPM Status, TPM Activation, and Intel

Option	Description
	TXT fields if the TPM Status field is set to either On with Pre-boot Measurements or On without Pre-boot Measurements .
TPM Information	Changes the operational state of the TPM. This option is set to No Change by default.
TPM Status	Specifies the TPM status.
TPM Command	 CAUTION: Clearing the TPM results in the loss of all keys in the TPM. The loss of TPM keys may affect booting to the operating system. Clears all the contents of the TPM. The TPM Clear option is set to No by default.
Intel TXT	Enables or disables the Intel Trusted Execution Technology (TXT) option. To enable the Intel TXT option, virtualization technology and TPM Security must be enabled with Pre-boot measurements. This option is set to Off by default.
Power Button	Enables or disables the power button on the front of the system. This option is set to Enabled by default.
AC Power Recovery	Sets how the system behaves after AC power is restored to the system. This option is set to Last by default.
UEFI Variable Access	Provides varying degrees of securing UEFI variables. When set to Standard (the default), UEFI variables are accessible in the operating system per the UEFI specification. When set to Controlled , selected UEFI variables are protected in the environment and new UEFI boot entries are forced to be at the end of the current boot order.
Secure Boot	Enables Secure Boot, where the BIOS authenticates each pre-boot image by using the certificates in the Secure Boot Policy. Secure Boot is disabled by default.
Secure Boot Policy	When Secure Boot policy is set to Standard , the BIOS uses the system manufacturer's key and certificates to authenticate pre-boot images. When Secure Boot policy is set to Custom , the BIOS uses the user-defined key and certificates. Secure Boot policy is set to Standard by default.
Secure Boot Policy Summary	Specifies the list of certificates and hashes that secure boot uses to authenticate images.

Related Links

[System Security](#)

[Viewing System Security](#)

Creating a system and setup password

Prerequisites

Ensure that the password jumper is enabled. The password jumper enables or disables the system password and setup password features. For more information, see the System board jumper settings section.

 **NOTE:** If the password jumper setting is disabled, the existing system password and setup password are deleted and you need not provide the system password to boot the system.

Steps

1. To enter System Setup, press F2 immediately after turning on or rebooting your system.
2. On the **System Setup Main Menu** screen, click **System BIOS** → **System Security**.
3. On the **System Security** screen, verify that **Password Status** is set to **Unlocked**.

4. In the **System Password** field, type your system password, and press Enter or Tab.

Use the following guidelines to assign the system password:

- A password can have up to 32 characters.
- The password can contain the numbers 0 through 9.
- Only the following special characters are allowed: space, ("), (+), (.), (-), (.), (/), (:), (|), (\), (|), (').

A message prompts you to reenter the system password.

5. Reenter the system password, and click **OK**.
6. In the **Setup Password** field, type your setup password and press Enter or Tab.

A message prompts you to reenter the setup password.

7. Reenter the setup password, and click **OK**.
8. Press Esc to return to the System BIOS screen. Press Esc again.

A message prompts you to save the changes.



NOTE: Password protection does not take effect until the system reboots.

Related Links

[System Security](#)

Using your system password to secure your system

If you have assigned a setup password, the system accepts your setup password as an alternate system password.

Steps

1. Turn on or reboot your system.
2. Type the system password and press Enter.

Next steps

When **Password Status** is set to **Locked**, type the system password and press Enter when prompted at reboot.



NOTE: If an incorrect system password is typed, the system displays a message and prompts you to reenter your password. You have three attempts to type the correct password. After the third unsuccessful attempt, the system displays an error message that the system has stopped functioning and must be turned off. Even after you turn off and restart the system, the error message is displayed until the correct password is entered.

Related Links

[System Security](#)

Deleting or changing system and setup password

Prerequisites



NOTE: You cannot delete or change an existing system or setup password if the **Password Status** is set to **Locked**.

Steps

1. To enter System Setup, press F2 immediately after turning on or restarting your system.
2. On the **System Setup Main Menu** screen, click **System BIOS** → **System Security**.
3. On the **System Security** screen, ensure that **Password Status** is set to **Unlocked**.
4. In the **System Password** field, alter or delete the existing system password, and then press Enter or Tab.

5. In the **Setup Password** field, alter or delete the existing setup password, and then press Enter or Tab. If you change the system and setup password, a message prompts you to reenter the new password. If you delete the system and setup password, a message prompts you to confirm the deletion.
6. Press Esc to return to the **System BIOS** screen. Press Esc again, and a message prompts you to save the changes.

Related Links

[System Security](#)

Operating with a setup password enabled

If **Setup Password** is set to **Enabled**, type the correct setup password before modifying the system setup options.

If you do not type the correct password in three attempts, the system displays the following message:

```
Invalid Password! Number of unsuccessful password attempts: <x> System Halted!
Must power down.
```

Even after you turn off and restart the system, the error message is displayed until the correct password is typed. The following options are exceptions:

- If **System Password** is not set to **Enabled** and is not locked through the **Password Status** option, you can assign a system password. For more information, see the System Security Settings screen section.
- You cannot disable or change an existing system password.



NOTE: You can use the password status option with the setup password option to protect the system password from unauthorized changes.

Related Links

[System Security](#)

Secure Boot Custom Policy Settings

Secure Boot Custom Policy Settings is displayed only when **Secure Boot Policy** is set to **Custom**.

Viewing Secure Boot Custom Policy Settings

To view the **Secure Boot Custom Policy Settings** screen, perform the following steps:

1. Turn on, or restart your system.
2. Press F2 immediately after you see the following message:
F2 = System Setup
 -  **NOTE:** If your operating system begins to load before you press F2, wait for the system to finish booting, and then restart your system and try again.
3. On the **System Setup Main Menu** screen, click **System BIOS**.
4. On the **System BIOS** screen, click **System Security**.
5. On the **System Security** screen, click **Secure Boot Custom Policy Settings**.

Secure Boot Custom Policy Settings details

The **Secure Boot Custom Policy Settings** screen details are explained as follows:

Option	Description
Platform Key	Imports, exports, deletes, or restores the platform key (PK).

Option	Description
Key Exchange Key Database	Enables you to import, export, delete, or restore entries in the Key Exchange Key (KEK) Database.
Authorized Signature Database	Imports, exports, deletes, or restores entries in the Authorized Signature Database (db).
Forbidden Signature Database	Imports, exports, deletes, or restores entries in the Forbidden Signature Database (dbx).

System Information

You can use the **System Information** screen to view system properties such as Service Tag, system model name, and the BIOS version.

Related Links

- [System Information details](#)
- [System BIOS](#)
- [Viewing System Information](#)

Viewing System Information

To view the **System Information** screen, perform the following steps:

1. Turn on, or restart your system.
2. Press F2 immediately after you see the following message:
F2 = System Setup



NOTE: If your operating system begins to load before you press F2, wait for the system to finish booting, and then restart your system and try again.

3. On the **System Setup Main Menu** screen, click **System BIOS**.
4. On the **System BIOS** screen, click **System Information**.

Related Links

- [System Information](#)

System Information details

The **System Information** screen details are explained as follows:

Option	Description
System Model Name	Specifies the system model name.
System BIOS Version	Specifies the BIOS version installed on the system.
System Management Engine Version	Specifies the current version of the Management Engine firmware.
System Service Tag	Specifies the system Service Tag.

Option	Description
System Manufacturer	Specifies the name of the system manufacturer.
System Manufacturer Contact Information	Specifies the contact information of the system manufacturer.
System CPLD Version	Specifies the current version of the system complex programmable logic device (CPLD) firmware.
UEFI Compliance Version	Specifies the UEFI compliance level of the system firmware.

Related Links

- [System Information](#)
- [System Information details](#)
- [Viewing System Information](#)

Memory Settings

You can use the **Memory Settings** screen to view all the memory settings and enable or disable specific memory functions, such as system memory testing and node interleaving.

Related Links

- [Memory Settings details](#)
- [System BIOS](#)
- [Viewing Memory Settings](#)

Viewing Memory Settings

To view the **Memory Settings** screen, perform the following steps:

1. Turn on, or restart your system.
2. Press F2 immediately after you see the following message:
F2 = System Setup



NOTE: If your operating system begins to load before you press F2, wait for the system to finish booting, and then restart your system and try again.

3. On the **System Setup Main Menu** screen, click **System BIOS**.
4. On the **System BIOS** screen, click **Memory Settings**.



Related Links

- [Memory Settings](#)
- [Memory Settings details](#)

Memory Settings details

The **Memory Settings** screen details are explained as follows:

Option	Description
System Memory Size	Specifies the memory size in the system.
System Memory Type	Specifies the type of memory installed in the system.

Option	Description
System Memory Speed	Specifies the system memory speed.
System Memory Voltage	Specifies the system memory voltage.
Video Memory	Specifies the amount of video memory.
System Memory Testing	Specifies whether the system memory tests are run during system boot. Options are Enabled and Disabled . This option is set to Disabled by default.
Memory Operating Mode	Specifies the memory operating mode. The options available are Optimizer Mode , Advanced ECC Mode , Mirror Mode , Spare Mode , Spare with Advanced ECC Mode , Dell Fault Resilient Mode and Dell NUMA Fault Resilient Mode . This option is set to Optimizer Mode by default. <ul style="list-style-type: none">  NOTE: The Memory Operating Mode option can have different default and available options based on the memory configuration of your system.  NOTE: The Dell Fault Resilient Mode option establishes an area of memory that is fault resilient. This mode can be used by an operating system that supports the feature to load critical applications or enables the operating system kernel to maximize system availability.
Node Interleaving	Specifies if Non-Uniform Memory architecture (NUMA) is supported. If this field is set to Enabled , memory interleaving is supported if a symmetric memory configuration is installed. If the field is set to Disabled , the system supports NUMA (asymmetric) memory configurations. This option is set to Disabled by default.
Snoop Mode	Specifies the Snoop Mode options. The Snoop Mode options available are Home Snoop , Early Snoop , and Cluster on Die . This option is set to Early Snoop by default. This field is available only when the Node Interleaving is set to Disabled .

Related Links

- [Memory Settings](#)
- [Viewing Memory Settings](#)

Processor Settings

You can use the **Processor Settings** screen to view the processor settings, and perform specific functions such as enabling virtualization technology, hardware prefetcher, and logical processor idling.

Related Links

- [Processor Settings details](#)
- [System BIOS](#)
- [Viewing Processor Settings](#)

Viewing Processor Settings

To view the **Processor Settings** screen, perform the following steps:

1. Turn on, or restart your system.
2. Press F2 immediately after you see the following message:
F2 = System Setup

 **NOTE:** If your operating system begins to load before you press F2, wait for the system to finish booting, and then restart your system and try again.

3. On the **System Setup Main Menu** screen, click **System BIOS**.

- On the **System BIOS** screen, click **Processor Settings**.



Related Links



[Processor Settings](#)

[Processor Settings details](#)

Processor Settings details

The **Processor Settings** screen details are explained as follows:

Option	Description
Logical Processor	Enables or disables the logical processors and displays the number of logical processors. If this option is set to Enabled , the BIOS displays all the logical processors. If this option is set to Disabled , the BIOS displays only one logical processor per core. This option is set to Enabled by default.
Alternate RTID (Requestor Transaction ID) Setting	Modifies Requestor Transaction IDs, which are QPI resources. This option is set to Disabled by default.  NOTE: Enabling this option may negatively impact the overall system performance.
Virtualization Technology	Enables or disables the additional hardware capabilities provided for virtualization. This option is set to Enabled by default.
Address Translation Service (ATS)	Defines the Address Translation Cache (ATC) for devices to cache the DMA transactions. This option provides an interface between CPU and DMA Memory Management to a chipset's Address Translation and Protection Table to translate DMA addresses to host addresses. This option is set to Enabled by default.
Adjacent Cache Line Prefetch	Optimizes the system for applications that need high utilization of sequential memory access. This option is set to Enabled by default. You can disable this option for applications that need high utilization of random memory access.
Hardware Prefetcher	Enables or disables the hardware prefetcher. This option is set to Enabled by default.
DCU Streamer Prefetcher	Enables or disables the Data Cache Unit (DCU) streamer prefetcher. This option is set to Enabled by default.
DCU IP Prefetcher	Enables or disables the Data Cache Unit (DCU) IP prefetcher. This option is set to Enabled by default.
Execute Disable	Enables you to run the disable memory protection technology. This option is set to Enabled by default.
Logical Processor Idling	Enables you to improve the energy efficiency of a system. It uses the operating system core parking algorithm and parks some of the logical processors in the system which in turn allows the corresponding processor cores to transition into a lower power idle state. This option can only be enabled if the operating system supports it. It is set to Disabled by default.
Configurable TDP	Enables you to reconfigure the processor Thermal Design Power (TDP) levels during POST based on the power and thermal delivery capabilities of the system. TDP verifies the maximum heat the cooling system is needed to dissipate. This option is set to Nominal by default.  NOTE: This option is only available on certain stock keeping units (SKUs) of the processors.
X2Apic Mode	Enables or disables the X2Apic mode.

Option	Description
Dell Controlled Turbo	Controls the turbo engagement. Enable this option only when System Profile is set to Performance .  NOTE: Depending on the number of installed CPUs, there may be up to four processor listings.
Number of Cores per Processor	Controls the number of enabled cores in each processor. This option is set to All by default.
Processor 64-bit Support	Specifies if the processor(s) support 64-bit extensions.
Processor Core Speed	Specifies the maximum core frequency of the processor.
Processor 1	 NOTE: Depending on the number of CPUs, there may be up to four processors listed.

The following settings are displayed for each processor installed in the system:

Option	Description
Family-Model-Stepping	Specifies the family, model, and stepping of the processor as defined by Intel.
Brand	Specifies the brand name.
Level 2 Cache	Specifies the total L2 cache.
Level 3 Cache	Specifies the total L3 cache.
Number of Cores	Specifies the number of cores per processor.

Related Links

- [Processor Settings](#)
- [Viewing Processor Settings](#)

SATA Settings

You can use the **SATA Settings** screen to view the SATA settings of SATA devices and enable RAID on your system.

Related Links

- [SATA Settings details](#)
- [System BIOS](#)
- [Viewing SATA Settings](#)

Viewing SATA Settings

To view the **SATA Settings** screen, perform the following steps:

1. Turn on, or restart your system.
2. Press F2 immediately after you see the following message:
F2 = System Setup

 **NOTE:** If your operating system begins to load before you press F2, wait for the system to finish booting, and then restart your system and try again.

3. On the **System Setup Main Menu** screen, click **System BIOS**.
4. On the **System BIOS** screen, click **SATA Settings**.

Related Links

- [SATA Settings](#)
- [SATA Settings details](#)

SATA Settings details

The **SATA Settings** screen details are explained as follows:

Option	Description
Embedded SATA	Enables the embedded SATA option to be set to Off , ATA , AHCI , or RAID modes. This option is set to AHCI by default.
Security Freeze Lock	Sends Security Freeze Lock command to the Embedded SATA drives during POST. This option is applicable only for ATA and AHCI modes.
Write Cache	Enables or disables the command for Embedded SATA drives during POST.
Port A	Sets the drive type of the selected device. For Embedded SATA settings in ATA mode, set this field to Auto to enable BIOS support. Set it to OFF to turn off BIOS support. For AHCI or RAID mode, BIOS support is always enabled.

Option	Description
Model	Specifies the drive model of the selected device.
Drive Type	Specifies the type of drive attached to the SATA port.
Capacity	Specifies the total capacity of the hard drive. This field is undefined for removable media devices such as optical drives.

Port B	Sets the drive type of the selected device. For Embedded SATA settings in ATA mode, set this field to Auto to enable BIOS support. Set it to OFF to turn off BIOS support. For AHCI or RAID mode, BIOS support is always enabled.
---------------	--

Option	Description
Model	Specifies the drive model of the selected device.
Drive Type	Specifies the type of drive attached to the SATA port.
Capacity	Specifies the total capacity of the hard drive. This field is undefined for removable media devices such as optical drives.

Port C	Sets the drive type of the selected device. For Embedded SATA settings in ATA mode, set this field to Auto to enable BIOS support. Set it to OFF to turn off BIOS support. For AHCI or RAID mode, BIOS support is always enabled.
---------------	--

Option	<table border="0"> <tr> <td colspan="2">Description</td> </tr> <tr> <td style="padding-right: 20px;">Option</td> <td>Description</td> </tr> <tr> <td>Model</td> <td>Specifies the drive model of the selected device.</td> </tr> <tr> <td>Drive Type</td> <td>Specifies the type of drive attached to the SATA port.</td> </tr> <tr> <td>Capacity</td> <td>Specifies the total capacity of the hard drive. This field is undefined for removable media devices such as optical drives.</td> </tr> </table>	Description		Option	Description	Model	Specifies the drive model of the selected device.	Drive Type	Specifies the type of drive attached to the SATA port.	Capacity	Specifies the total capacity of the hard drive. This field is undefined for removable media devices such as optical drives.
Description											
Option	Description										
Model	Specifies the drive model of the selected device.										
Drive Type	Specifies the type of drive attached to the SATA port.										
Capacity	Specifies the total capacity of the hard drive. This field is undefined for removable media devices such as optical drives.										
Port D	<p>Sets the drive type of the selected device. For Embedded SATA settings in ATA mode, set this field to Auto to enable BIOS support. Set it to OFF to turn off BIOS support.</p> <p>For AHCI or RAID mode, BIOS support is always enabled.</p> <table border="0"> <tr> <td colspan="2">Description</td> </tr> <tr> <td style="padding-right: 20px;">Option</td> <td>Description</td> </tr> <tr> <td>Model</td> <td>Specifies the drive model of the selected device.</td> </tr> <tr> <td>Drive Type</td> <td>Specifies the type of drive attached to the SATA port.</td> </tr> <tr> <td>Capacity</td> <td>Specifies the total capacity of the hard drive. This field is undefined for removable media devices such as optical drives.</td> </tr> </table>	Description		Option	Description	Model	Specifies the drive model of the selected device.	Drive Type	Specifies the type of drive attached to the SATA port.	Capacity	Specifies the total capacity of the hard drive. This field is undefined for removable media devices such as optical drives.
Description											
Option	Description										
Model	Specifies the drive model of the selected device.										
Drive Type	Specifies the type of drive attached to the SATA port.										
Capacity	Specifies the total capacity of the hard drive. This field is undefined for removable media devices such as optical drives.										
Port E	<p>Sets the drive type of the selected device. For Embedded SATA settings in ATA mode, set this field to Auto to enable BIOS support. Set it to OFF to turn off BIOS support.</p> <p>For AHCI or RAID mode, BIOS support is always enabled.</p> <table border="0"> <tr> <td colspan="2">Description</td> </tr> <tr> <td style="padding-right: 20px;">Option</td> <td>Description</td> </tr> <tr> <td>Model</td> <td>Specifies the drive model of the selected device.</td> </tr> <tr> <td>Drive Type</td> <td>Specifies the type of drive attached to the SATA port.</td> </tr> <tr> <td>Capacity</td> <td>Specifies the total capacity of the hard drive. This field is undefined for removable media devices such as optical drives.</td> </tr> </table>	Description		Option	Description	Model	Specifies the drive model of the selected device.	Drive Type	Specifies the type of drive attached to the SATA port.	Capacity	Specifies the total capacity of the hard drive. This field is undefined for removable media devices such as optical drives.
Description											
Option	Description										
Model	Specifies the drive model of the selected device.										
Drive Type	Specifies the type of drive attached to the SATA port.										
Capacity	Specifies the total capacity of the hard drive. This field is undefined for removable media devices such as optical drives.										
Port F	<p>Sets the drive type of the selected device. For Embedded SATA settings in ATA mode, set this field to Auto to enable BIOS support. Set it to OFF to turn off BIOS support.</p> <p>For AHCI or RAID mode, BIOS support is always enabled.</p> <table border="0"> <tr> <td colspan="2">Description</td> </tr> <tr> <td style="padding-right: 20px;">Option</td> <td>Description</td> </tr> <tr> <td>Model</td> <td>Specifies the drive model of the selected device.</td> </tr> <tr> <td>Drive Type</td> <td>Specifies the type of drive attached to the SATA port.</td> </tr> <tr> <td>Capacity</td> <td>Specifies the total capacity of the hard drive. This field is undefined for removable media devices such as optical drives.</td> </tr> </table>	Description		Option	Description	Model	Specifies the drive model of the selected device.	Drive Type	Specifies the type of drive attached to the SATA port.	Capacity	Specifies the total capacity of the hard drive. This field is undefined for removable media devices such as optical drives.
Description											
Option	Description										
Model	Specifies the drive model of the selected device.										
Drive Type	Specifies the type of drive attached to the SATA port.										
Capacity	Specifies the total capacity of the hard drive. This field is undefined for removable media devices such as optical drives.										

Option

Description

Port G

Sets the drive type of the selected device. For **Embedded SATA settings** in **ATA** mode, set this field to **Auto** to enable BIOS support. Set it to **OFF** to turn off BIOS support.

For **AHCI** or **RAID** mode, BIOS support is always enabled.

Option

Description

Model

Specifies the drive model of the selected device.

Drive Type

Specifies the type of drive attached to the SATA port.

Capacity

Specifies the total capacity of the hard drive. This field is undefined for removable media devices such as optical drives.

Port H

Sets the drive type of the selected device. For **Embedded SATA settings** in **ATA** mode, set this field to **Auto** to enable BIOS support. Set it to **OFF** to turn off BIOS support.

For **AHCI** or **RAID** mode, BIOS support is always enabled.

Option

Description

Model

Specifies the drive model of the selected device.

Drive Type

Specifies the type of drive attached to the SATA port.

Capacity

Specifies the total capacity of the hard drive. This field is undefined for removable media devices such as optical drives.

Port I

Sets the drive type of the selected device. For **Embedded SATA settings** in **ATA** mode, set this field to **Auto** to enable BIOS support. Set it to **OFF** to turn off BIOS support.

For **AHCI** or **RAID** mode, BIOS support is always enabled.

Option

Description

Model

Specifies the drive model of the selected device.

Drive Type

Specifies the type of drive attached to the SATA port.

Capacity

Specifies the total capacity of the hard drive. This field is undefined for removable media devices such as optical drives.

Port J

Sets the drive type of the selected device. For **Embedded SATA settings** in **ATA** mode, set this field to **Auto** to enable BIOS support. Set it to **OFF** to turn off BIOS support.

For **AHCI** or **RAID** mode, BIOS support is always enabled.

Option

Description

Model

Specifies the drive model of the selected device.

Drive Type

Specifies the type of drive attached to the SATA port.

Option	Description
Option	Description
Capacity	Specifies the total capacity of the hard drive. This field is undefined for removable media devices such as optical drives.

Related Links

[SATA Settings](#)

[Viewing SATA Settings](#)

Integrated Devices

You can use the **Integrated Devices** screen to view and configure the settings of all integrated devices including the video controller, integrated RAID controller, and the USB ports.

Related Links

[Integrated Devices details](#)

[System BIOS](#)

[Viewing Integrated Devices](#)

Viewing Integrated Devices

To view the **Integrated Devices** screen, perform the following steps:

1. Turn on, or restart your system.
2. Press F2 immediately after you see the following message:
F2 = System Setup



NOTE: If your operating system begins to load before you press F2, wait for the system to finish booting, and then restart your system and try again.

3. On the **System Setup Main Menu** screen, click **System BIOS**.
4. On the **System BIOS** screen, click **Integrated Devices**.

Related Links

[Integrated Devices](#)

[Integrated Devices details](#)

Integrated Devices details

The **Integrated Devices** screen details are explained as follows:

Option	Description
USB 3.0 Setting	Enables or disables the USB 3.0 support. Enable this option only if your operating system supports USB 3.0. If you disable this option, devices operate at USB 2.0 speed. USB 3.0 is enabled by default.
User Accessible USB Ports	Enables or disables the USB ports. Selecting Only Back Ports On disables the front USB ports, selecting All Ports Off disables all USB ports. The USB keyboard and mouse operate during boot process in certain operating systems. After the boot process is complete, the USB keyboard and mouse do not work if the ports are disabled.



NOTE: Selecting **Only Back Ports On** and **All Ports Off** disables the USB management port and also restricts access to iDRAC features.

Option	Description
Internal USB Port	Enables or disables the internal USB port. This option is set to Enabled by default.
Integrated RAID Controller	Enables or disables the integrated RAID controller. This option is set to Enabled by default.
Integrated Network Card 1	Enables or disables the integrated network card.
I/OAT DMA Engine	Enables or disables the I/OAT option. Enable only if the hardware and software support the feature.
Embedded Video Controller	Enables or disables the Embedded Video Controller option. This option is set to Enabled by default.
Current State of Embedded Video Controller	Displays the current state of the embedded video controller. The Current State of Embedded Video Controller option is a read-only field. If the Embedded Video Controller is the only display capability in the system (that is, no add-in graphics card is installed), then the Embedded Video Controller is automatically used as the primary display even if the Embedded Video Controller setting is set to Disabled .
SR-IOV Global Enable	Enables or disables the BIOS configuration of Single Root I/O Virtualization (SR-IOV) devices. This option is set to Disabled by default.
OS Watchdog Timer	If your system stops responding, this watchdog timer aids in the recovery of your operating system. When this option is set to Enabled , the operating system initializes the timer. When this option is set to Disabled (the default), the timer does not have any effect on the system.
Memory Mapped I/O above 4 GB	Enables or disables the support for PCIe devices that need large amounts of memory. This option is set to Enabled by default.
Mezzanine Slot Disablement	The Slot Disablement feature controls the configuration of mezzanine cards installed in the specified slots. Only mezzanine card slots that are present on your system are available for control.

Related Links

- [Integrated Devices](#)
- [Viewing Integrated Devices](#)

Serial Communication

You can use the **Serial Communication** screen to view the properties of the serial communication port.

Related Links

- [Serial Communication details](#)
- [System BIOS](#)
- [Viewing Serial Communication](#)

Viewing Serial Communication

To view the **Serial Communication** screen, perform the following steps:

1. Turn on, or restart your system.
2. Press F2 immediately after you see the following message:
F2 = System Setup



NOTE: If your operating system begins to load before you press F2, wait for the system to finish booting, and then restart your system and try again.

3. On the **System Setup Main Menu** screen, click **System BIOS**.

4. On the **System BIOS** screen, click **Serial Communication**.

Related Links

[Serial Communication](#)
[Serial Communication details](#)

Serial Communication details

The **Serial Communication** screen details are explained as follows:

Option	Description
Serial Communication	Enables the COM port or Console Redirection options. This option is set to Off by default.
Serial Port Address	Enables you to set the port address for serial devices. This option is set to Serial Device 1=COM2, Serial Device 2=COM1 by default.  NOTE: You can use only Serial Device 2 for the Serial Over LAN (SOL) feature. To use console redirection by SOL, configure the same port address for console redirection and the serial device.
External Serial Connector	Enables you to associate the External Serial Connector to Serial Device 1.
Failsafe Baud Rate	Specifies the failsafe baud rate for console redirection. The BIOS attempts to determine the baud rate automatically. This failsafe baud rate is used only if the attempt fails, and the value must not be changed. This option is set to 115200 by default.
Remote Terminal Type	Sets the remote console terminal type. This option is set to VT 100/VT 220 by default.
Redirection After Boot	Enables or disables the BIOS console redirection when the operating system is loaded. This option is set to Enabled by default.

Related Links

[Serial Communication](#)
[Viewing Serial Communication](#)

System Profile Settings

You can use the **System Profile Settings** screen to enable specific system performance settings such as power management.

Related Links

[System Profile Settings details](#)
[System BIOS](#)
[Viewing System Profile Settings](#)

Viewing System Profile Settings

To view the **System Profile Settings** screen, perform the following steps:

1. Turn on, or restart your system.
2. Press F2 immediately after you see the following message:
F2 = System Setup



NOTE: If your operating system begins to load before you press F2, wait for the system to finish booting, and then restart your system and try again.

3. On the **System Setup Main Menu** screen, click **System BIOS**.
4. On the **System BIOS** screen, click **System Profile Settings**.

Related Links



[System Profile Settings](#)

[System Profile Settings details](#)

System Profile Settings details

The **System Profile Settings** screen details are explained as follows:

Option	Description
System Profile	Sets the system profile. If you set the System Profile option to a mode other than Custom , the BIOS automatically sets the rest of the options. You can only change the rest of the options if the mode is set to Custom . This option is set to Performance Per Watt Optimized (DAPC) by default. DAPC is Dell Active Power Controller.  NOTE: All the parameters on the system profile setting screen are available only when the System Profile option is set to Custom .
CPU Power Management	Sets the CPU power management. This option is set to System DBPM (DAPC) by default. DBPM is Demand-Based Power Management.
Memory Frequency	Sets the speed of the system memory. You can select Maximum Performance , Maximum Reliability , or a specific speed.
Turbo Boost	Enables or disables the processor to operate in the turbo boost mode. This option is set to Enabled by default.
Energy Efficient Turbo	Enables or disables the Energy Efficient Turbo option. Energy Efficient Turbo (EET) is a mode of operation where a processor's core frequency is adjusted to be within the turbo range based on workload.
C1E	Enables or disables the processor to switch to a minimum performance state when it is idle. This option is set to Enabled by default.
C States	Enables or disables the processor to operate in all available power states. This option is set to Enabled by default.
Collaborative CPU Performance Control	Enables or disables the CPU power management option. When set to Enabled , the CPU power management is controlled by the OS DBPM and the System DBPM (DAPC). This option is set to Disabled by default.
Memory Patrol Scrub	Sets the memory patrol scrub frequency. This option is set to Standard by default.
Memory Refresh Rate	Sets the memory refresh rate to either 1x or 2x. This option is set to 1x by default.
Uncore Frequency	Enables you to select the Processor Uncore Frequency option. Dynamic mode enables the processor to optimize power resources across the cores and uncore during runtime. The optimization of the uncore frequency to

Option	Description
Energy Efficient Policy	either save power or optimize performance is influenced by the setting of the Energy Efficiency Policy option. Enables you to select the Energy Efficient Policy option. The CPU uses the setting to manipulate the internal behavior of the processor and determines whether to target higher performance or better power savings.
Number of Turbo Boost Enabled Cores for Processor 1	 NOTE: If there are two processors installed in the system, you see an entry for Number of Turbo Boost Enabled Cores for Processor 2 . Controls the number of turbo boost enabled cores for processor 1. The maximum number of cores is enabled by default.
Monitor/Mwait	Enables the Monitor/Mwait instructions in the processor. This option is set to Enabled for all system profiles, except Custom by default.  NOTE: This option can be disabled only if the C States option in the Custom mode is set to disabled .  NOTE: When C States is set to Enabled in the Custom mode, changing the Monitor/Mwait setting does not impact the system power or performance.

Related Links

- [System Profile Settings](#)
- [Viewing System Profile Settings](#)

Miscellaneous Settings

You can use the **Miscellaneous Settings** screen to perform specific functions such as updating the asset tag and changing the system date and time.

Related Links

- [Miscellaneous Settings details](#)
- [System BIOS](#)
- [Viewing Miscellaneous Settings](#)

Viewing Miscellaneous Settings

To view the **Miscellaneous Settings** screen, perform the following steps:

1. Turn on, or restart your system.
2. Press F2 immediately after you see the following message:
F2 = System Setup



 **NOTE:** If your operating system begins to load before you press F2, wait for the system to finish booting, and then restart your system and try again.
3. On the **System Setup Main Menu** screen, click **System BIOS**.
4. On the **System BIOS** screen, click **Miscellaneous Settings**.

Related Links

- [Miscellaneous Settings](#)
- [Miscellaneous Settings details](#)

Miscellaneous Settings details

The **Miscellaneous Settings** screen details are explained as follows:

Option	Description
System Time	Enables you to set the time on the system.
System Date	Enables you to set the date on the system.
Asset Tag	Specifies the asset tag and enables you to modify it for security and tracking purposes.
Keyboard NumLock	Enables you to set whether the system boots with the NumLock enabled or disabled. This option is set to On by default.  NOTE: This option does not apply to 84-key keyboards.
F1/F2 Prompt on Error	Enables or disables the F1/F2 prompt on error. This option is set to Enabled by default. The F1/F2 prompt also includes keyboard errors.
Load Legacy Video Option ROM	Enables you to determine whether the system BIOS loads the legacy video (INT 10H) option ROM from the video controller. Selecting Enabled in the operating system does not support UEFI video output standards. This field is available only for UEFI boot mode. You cannot set the option to Enabled if UEFI Secure Boot mode is enabled.
In-System Characterization	Enables or disables In-System Characterization . This option is set to Disabled by default. The two other options are Enabled and Enabled - No Reboot .  NOTE: The default setting for In-System Characterization is subject to change in future BIOS releases. When enabled, In-System Characterization (ISC) executes during POST upon detecting relevant change(s) in system configuration to optimize system power and performance. ISC takes about 20 seconds to execute, and system reset is needed for ISC results to be applied. The Enabled - No Reboot option executes ISC and continues without applying ISC results until the next time system reset occurs. The Enabled option executes ISC and forces an immediate system reset so that ISC results can be applied. It takes the system longer to be ready due to the forced system reset. When disabled, ISC does not execute.

Related Links

- [Miscellaneous Settings](#)
- [Viewing Miscellaneous Settings](#)

iDRAC Settings utility

The iDRAC settings utility is an interface to set up and configure the iDRAC parameters by using UEFI. You can enable or disable various iDRAC parameters by using the iDRAC settings utility.

 **NOTE:** Accessing some of the features on the iDRAC settings utility needs the iDRAC Enterprise License upgrade.

For more information about using iDRAC, see *Dell Integrated Dell Remote Access Controller User's Guide* at Dell.com/idracmanuals.

Related Links

- [Device Settings](#)
- [System BIOS](#)
- [Entering the iDRAC Settings utility](#)
- [Changing the thermal settings](#)

Entering the iDRAC Settings utility

1. Turn on or restart the managed system.
2. Press F2 during Power-on Self-test (POST).
3. On the **System Setup Main Menu** page, click **iDRAC Settings**.
The **iDRAC Settings** screen is displayed.

Related Links

[iDRAC Settings utility](#)

Changing the thermal settings

The iDRAC settings utility enables you to select and customize the thermal control settings for your system.

1. Click **iDRAC Settings** → **Thermal**.
2. Under **SYSTEM THERMAL PROFILE** → **Thermal Profile**, select one of the following options:
 - Default Thermal Profile Settings
 - Maximum Performance (Performance Optimized)
 - Minimum Power (Performance per Watt Optimized)
3. Under **USER COOLING OPTIONS**, set the **Fan Speed Offset**, **Minimum Fan Speed**, and **Custom Minimum Fan Speed**.
4. Click **Back** → **Finish** → **Yes**.

Related Links

[iDRAC Settings utility](#)

Device Settings

Device Settings enables you to configure device parameters.

Related Links

[System BIOS](#)

Dell Lifecycle Controller

Dell Lifecycle Controller (LC) provides advanced embedded systems management capabilities including system deployment, configuration, update, maintenance, and diagnosis. LC is delivered as part of the iDRAC out-of-band solution and Dell system embedded Unified Extensible Firmware Interface (UEFI) applications.

Related Links

[Embedded systems management](#)

Embedded systems management

The Dell Lifecycle Controller provides advanced embedded systems management throughout the system's lifecycle. The Dell Lifecycle Controller can be started during the boot sequence and can function independently of the operating system.



NOTE: Certain platform configurations may not support the full set of features provided by the Dell Lifecycle Controller.

For more information about setting up the Dell Lifecycle Controller, configuring hardware and firmware, and deploying the operating system, see the Dell Lifecycle Controller documentation at [Dell.com/idracmanuals](https://www.dell.com/support/manuals).

Related Links

[Dell Lifecycle Controller](#)

Boot Manager

The **Boot Manager** screen enables you to select boot options and diagnostic utilities.

Related Links

[Boot Manager main menu](#)

[System BIOS](#)

[Viewing Boot Manager](#)

Viewing Boot Manager

To enter **Boot Manager**:

1. Turn on, or restart your system.
2. Press F11 when you see the following message:

F11 = Boot Manager

If your operating system begins to load before you press F11, allow the system to complete the booting, and then restart your system and try again.

Related Links

[Boot Manager](#)

[Boot Manager main menu](#)

Boot Manager main menu

Menu item	Description
Continue Normal Boot	The system attempts to boot to devices starting with the first item in the boot order. If the boot attempt fails, the system continues with the next item in the boot order until the boot is successful or no more boot options are found.
One-shot Boot Menu	Enables you to access boot menu, where you can select a one-time boot device to boot from.
Launch System Setup	Enables you to access System Setup.
Launch Lifecycle Controller	Exits the Boot Manager and invokes the Dell Lifecycle Controller program.
System Utilities	Enables you to launch System Utilities menu such as System Diagnostics and UEFI shell.

Related Links

[Boot Manager](#)

[Viewing Boot Manager](#)

One-shot BIOS boot menu

One-shot BIOS boot menu enables you to select a boot device to boot from.

Related Links

[Boot Manager](#)

System Utilities

System Utilities contains the following utilities that can be launched:

- Launch Diagnostics
- BIOS Update File Explorer
- Reboot System

Related Links

[Boot Manager](#)

PXE boot

The Preboot Execution Environment (PXE) is an industry standard client or interface that allows networked computers that are not yet loaded with an operating system to be configured and booted remotely by an administrator.

Installing and removing sled components

This section provides information about installing and removing the sled components. For information about installing and removing the enclosure components, see the enclosure Owner's Manual at Dell.com/poweredge manuals.

Safety instructions

 **CAUTION:** Many repairs may only be done by a certified service technician. You should only perform troubleshooting and simple repairs as authorized in your product documentation, or as directed by the online or telephone service and support team. Damage due to servicing that is not authorized by Dell is not covered by your warranty. Read and follow the safety instructions that are shipped with your product.

 **NOTE:** Dell recommends that you always use an antistatic mat and antistatic wrist strap while working on components inside the system.

 **CAUTION:** Operating the system without the system cover can result in component damage

 **NOTE:** To ensure proper operation and cooling, all bays in the system must be populated always with either a system component or with a blank.

Before working inside your system

1. Turn off the sled using the CMC.
2. Remove the sled from the enclosure.
3. Install the I/O connector cover.

After working inside your system

Prerequisites

Follow the safety guidelines listed in safety instructions section.

Steps

1. Install the sled in the enclosure.
2. Turn on the sled.

Recommended tools

You need the following tools to perform the removal and installation procedures:

- Key to the bezel lock.
The key is needed only if your system includes a bezel.
- Phillips #1 screwdriver

- Phillips #2 screwdriver
- Torx #T8 and #T10 screwdrivers
- 5 mm and 6 mm Hex nut drivers
- Wrist grounding strap

Sled

Removing the sled

Prerequisites

 **CAUTION: Many repairs may only be done by a certified service technician. You should only perform troubleshooting and simple repairs as authorized in your product documentation, or as directed by the online or telephone service and support team. Damage due to servicing that is not authorized by Dell is not covered by your warranty. Read and follow the safety instructions that came with the product.**

1. Follow the safety guidelines listed in the Safety instructions section.
2. Follow the procedure listed in the Before working inside your system section.
3. Turn off the sled using the operating system commands or the CMC, and ensure that the front panel indicator of the sled is not lit.

Steps

1. Press the release button on the sled handle to unlock the sled handle.
2. Rotate the sled handle away from the sled to disengage the sled from the midplane connectors.
3. Slide the sled out of the enclosure.

 **CAUTION: To protect the I/O connector pins, install the I/O connector cover every time a sled is removed from the enclosure.**

4. Install the I/O connector cover over the I/O connector.

 **CAUTION: If you are permanently removing the sled, install a sled blank. Operating the system for extended periods of time without a sled blank installed can cause the enclosure to overheat.**

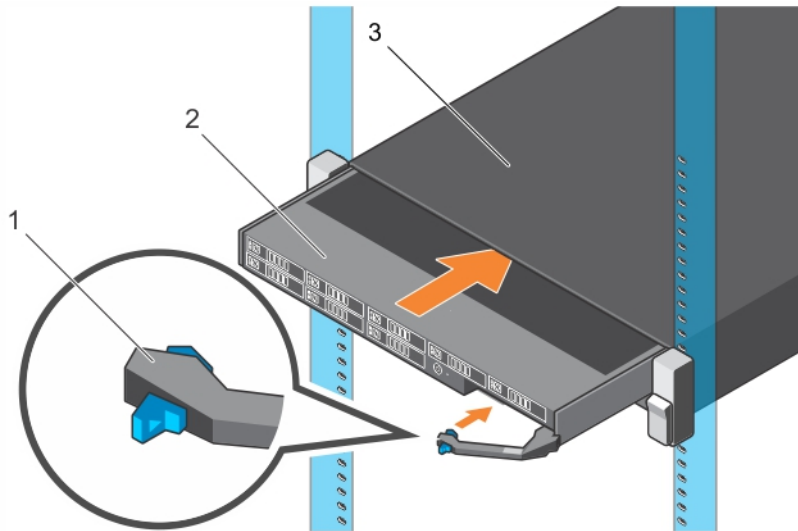

Figure 6. Removing the sled

- | | |
|--|---|
| <ol style="list-style-type: none"> 1. sled handle 2. sled 3. FX2/FX2s enclosure | <ol style="list-style-type: none"> 2. sled |
|--|---|

Related Links

- [Safety instructions](#)
- [Installing the sled](#)
- [Before working inside your system](#)
- [After working inside your system](#)

Installing the sled

Prerequisites

⚠ CAUTION: Many repairs may only be done by a certified service technician. You should only perform troubleshooting and simple repairs as authorized in your product documentation, or as directed by the online or telephone service and support team. Damage due to servicing that is not authorized by Dell is not covered by your warranty. Read and follow the safety instructions that came with the product.

⚠ CAUTION: To prevent damage to the I/O connectors, do not touch connectors or the connector pins.

✍ NOTE: Before installing the sleds, place the chassis in the location that you want.

1. Follow the safety guidelines listed in the Safety instructions section.
2. Follow the procedure listed in the Before working inside your system section.

Steps

1. If you are installing a new sled, remove the plastic cover from the I/O connector(s) and save for future use.
2. Press the release button on the sled handle to the open position.
3. Align the sled with the bay on the enclosure.
4. Slide the sled into the enclosure until the sled connectors are firmly engaged with the midplane connectors.

The sled handle rotates toward the enclosure as the sled slides into the enclosure.

5. Press the sled handle to closed position until the release button clicks into place.

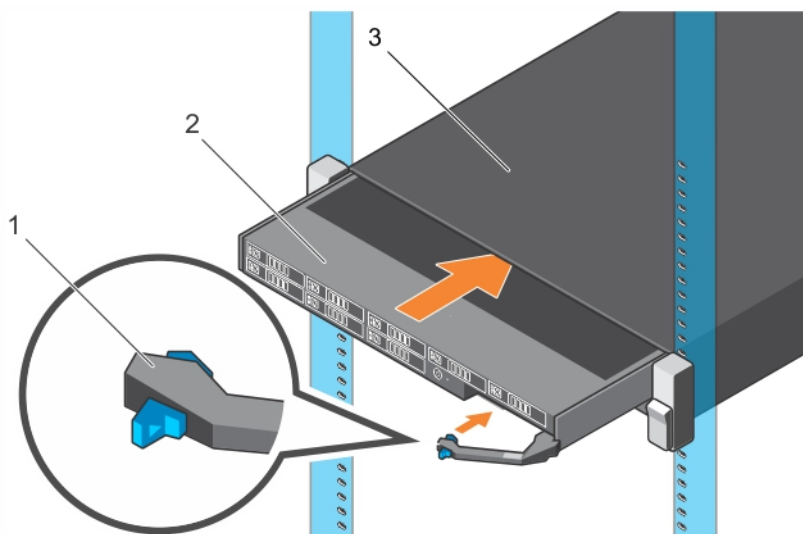

Figure 7. Installing the sled

1. sled handle
2. sled
3. FX2/FX2s enclosure

Next steps

1. Follow the procedure listed in the After working inside your system section.
2. Turn on the sled.

Related Links

- [Safety instructions](#)
- [Before working inside your system](#)
- [After working inside your system](#)

Inside the sled

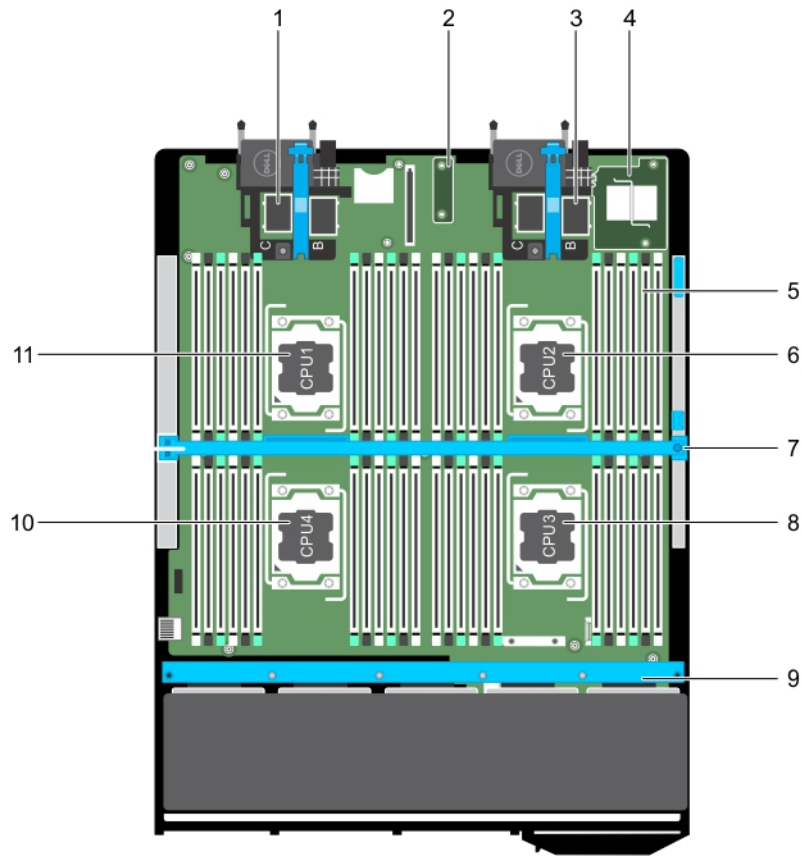

Figure 8. Inside the sled

- | | | | |
|-----|-------------------------------------|-----|---|
| 1. | connector for PCIe mezzanine card 1 | 2. | restore Serial Peripheral Interface (rSPI) card |
| 3. | connector for PCIe mezzanine card 2 | 4. | Network Daughter Card (NDC) |
| 5. | memory module (42) | 6. | processor 2 |
| 7. | cooling shroud | 8. | processor 3 |
| 9. | hard drive/SSD backplane | 10. | processor 4 |
| 11. | processor 1 | | |

Cooling shroud

The cooling shroud has aerodynamically placed openings that directs the airflow across the entire system. The airflow passes through all the critical parts of the system, where the vacuum that pulls air across the entire surface area of the processor and heat sink allowing increased cooling.

Removing the cooling shroud

Prerequisites

 **CAUTION:** Many repairs may only be done by a certified service technician. You should only perform troubleshooting and simple repairs as authorized in your product documentation, or as directed by the online or telephone service and support team. Damage due to servicing that is not authorized by Dell is not covered by your warranty. Read and follow the safety instructions that are shipped with your product.

 **CAUTION:** Never operate your system with the cooling shroud removed. The system may get overheated quickly, resulting in shutdown and loss of data.

 **NOTE:** You must remove the cooling shroud to replace a faulty cooling shroud or service other components inside the system.

1. Follow the safety guidelines listed in the Safety instructions section.
2. Follow the procedure listed in the Before working inside your system section.

Steps

1. Loosen the retention screw securing the cooling shroud on the cooling shroud retention bar.
2. Slide the cooling shroud to the unlock position.
3. Lift the cooling shroud away from the system.

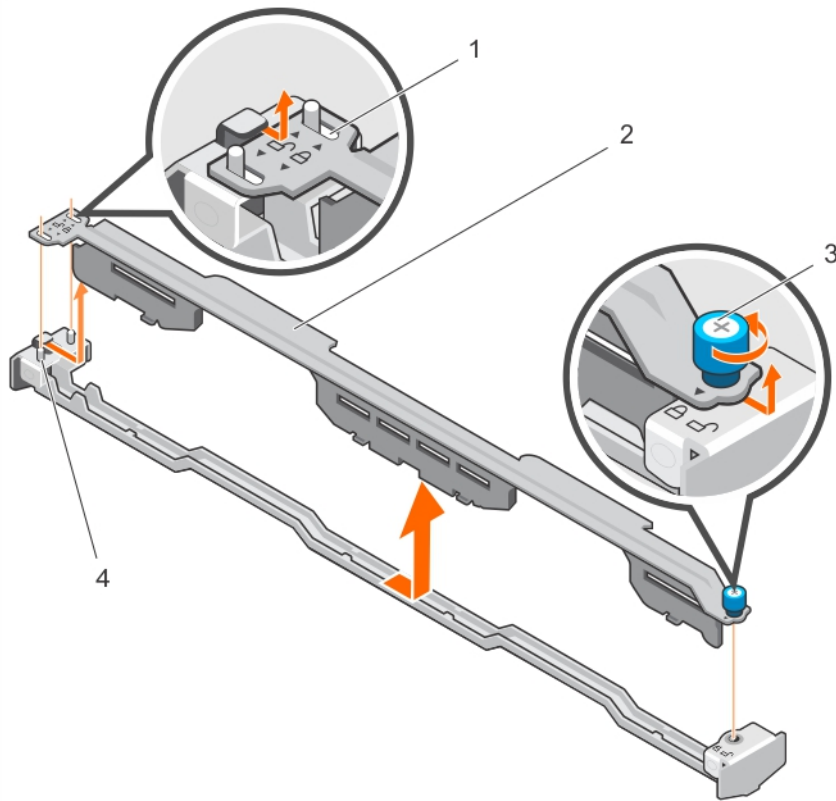

Figure 9. Removing the cooling shroud

- | | |
|--------------------|---|
| 1. slot (2) | 2. cooling shroud |
| 3. retention screw | 4. standoff on the cooling shroud retention bar (2) |

Next steps

1. Install the cooling shroud
2. Follow the procedure listed in the After working inside your system section.

Related Links

- [Safety instructions](#)
- [Before working inside your system](#)
- [Removing the sled](#)
- [Installing the cooling shroud](#)
- [After working inside your system](#)

Installing the cooling shroud

Prerequisites

⚠ CAUTION: Many repairs may only be done by a certified service technician. You should only perform troubleshooting and simple repairs as authorized in your product documentation, or as directed by the online or telephone service and support team. Damage due to servicing that is not authorized by Dell is not covered by your warranty. Read and follow the safety instructions that came with the product.

1. Follow the safety guidelines listed in the Safety instructions section.
2. Follow the procedure listed in the Before working inside your system section.
3. Remove the cooling shroud.

 **NOTE:** You must remove the cooling shroud to replace a faulty cooling shroud or service other components inside the system.

Steps

1. Align the slots on the side of the cooling shroud with the standoffs on the cooling shroud retention bar.
2. Lower the cooling shroud into the system until the slots on the cooling shroud engage with the standoffs on the cooling shroud retention bar.
3. Slide the cooling shroud to the lock position.
4. Tighten the retention screw to secure the cooling shroud on the cooling shroud retention bar.

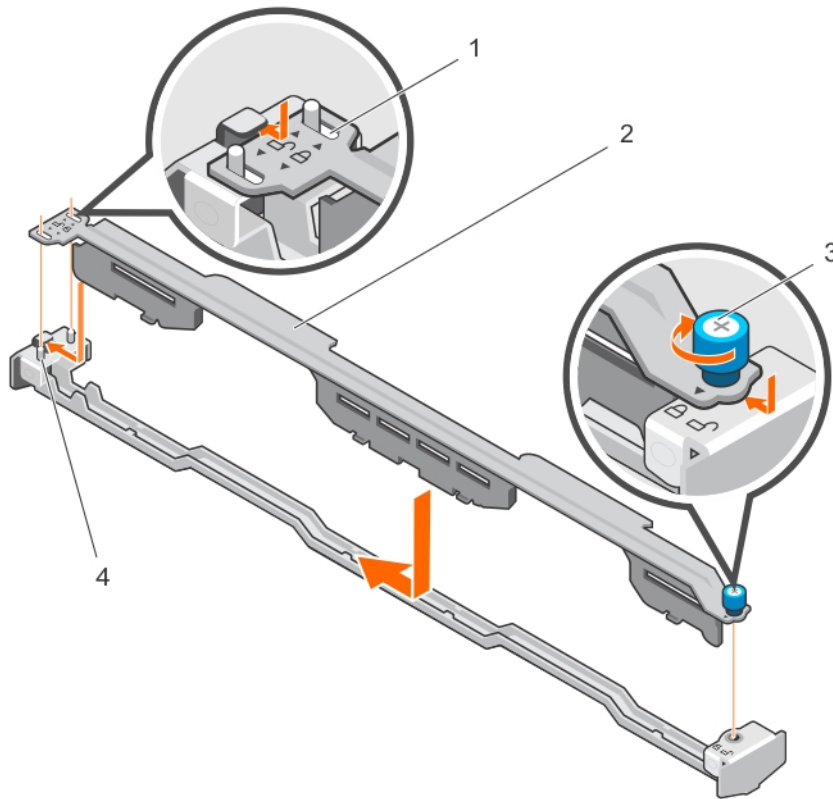

Figure 10. Installing the cooling shroud

- | | |
|--------------------|---|
| 1. slot (2) | 2. cooling shroud |
| 3. retention screw | 4. standoff on the cooling shroud retention bar (2) |

Next steps

Follow the procedure listed in the After working inside your system section.

Related Links

- [Safety instructions](#)
- [Before working inside your system](#)
- [Removing the cooling shroud](#)
- [Installing the sled](#)
- [After working inside your system](#)

Cooling shroud retention bar

Removing the cooling shroud retention bar

Prerequisites



CAUTION: Many repairs may only be done by a certified service technician. You should only perform troubleshooting and simple repairs as authorized in your product documentation, or as directed by the online or telephone service and support team. Damage due to servicing that is not authorized by Dell is not covered by your warranty. Read and follow the safety instructions that came with the product.



NOTE: You must remove the cooling shroud retention bar to replace a faulty retention bar or service other components inside the system.

1. Follow the safety guidelines listed in the Safety instructions section.
2. Follow the procedure listed in the Before working inside your system section.
3. Keep the #1 and #2 Phillips screwdrivers ready.
4. Remove the cooling shroud.

Steps

1. Remove the screws securing the cooling shroud retention bar to the system.
2. Hold the cooling shroud retention bar on the side of the chassis and lift it away from the system.

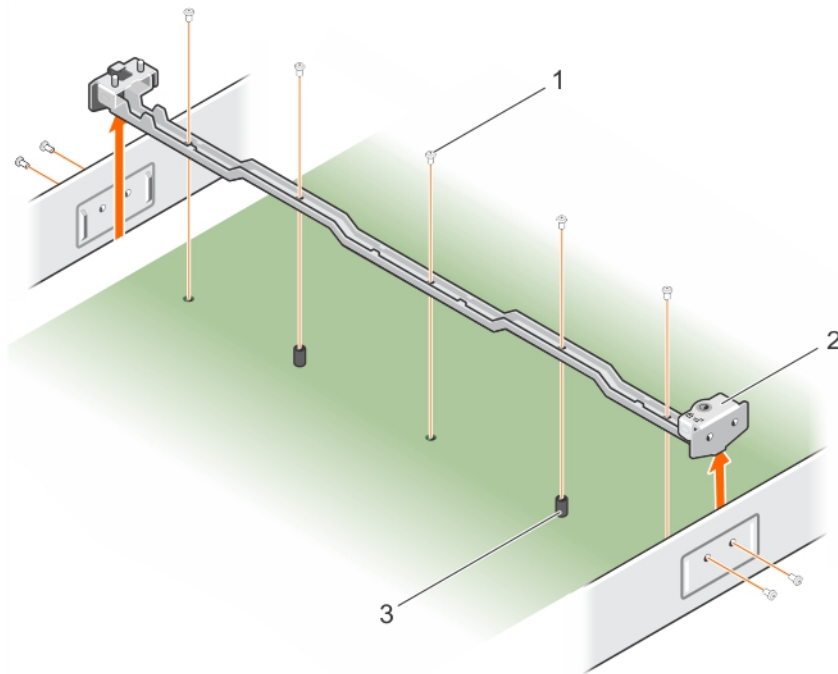

Figure 11. Removing the cooling shroud retention bar

1. screw (9)
2. cooling shroud retention bar
3. standoff (2)

Next steps

1. Install the cooling shroud retention bar.
2. Follow the procedure listed in the After working inside your system section.

Related Links

- [Safety instructions](#)
- [Before working inside your system](#)
- [Removing the sled](#)
- [Installing the cooling shroud retention bar](#)
- [After working inside your system](#)

Installing the cooling shroud retention bar

Prerequisites

⚠ CAUTION: Many repairs may only be done by a certified service technician. You should only perform troubleshooting and simple repairs as authorized in your product documentation, or as directed by the online or telephone service and support team. Damage due to servicing that is not authorized by Dell is not covered by your warranty. Read and follow the safety instructions that came with the product.

1. Follow the safety guidelines listed in the Safety instructions section.
2. Follow the procedure listed in the Before working inside your system section.
3. Keep the #1 and #2 Phillips screwdrivers ready.

4. Remove the cooling shroud retention bar.

 **NOTE:** You must remove the cooling shroud retention bar to replace a faulty retention bar or service other components inside the system.

5. Ensure that the memory module socket ejectors are in the locked position.

Steps

1. Lower the cooling shroud retention bar into the system until the screw holes on the cooling shroud retention bar align with the screw holes on the chassis.
2. Install the screws to secure the cooling shroud retention bar to the system.

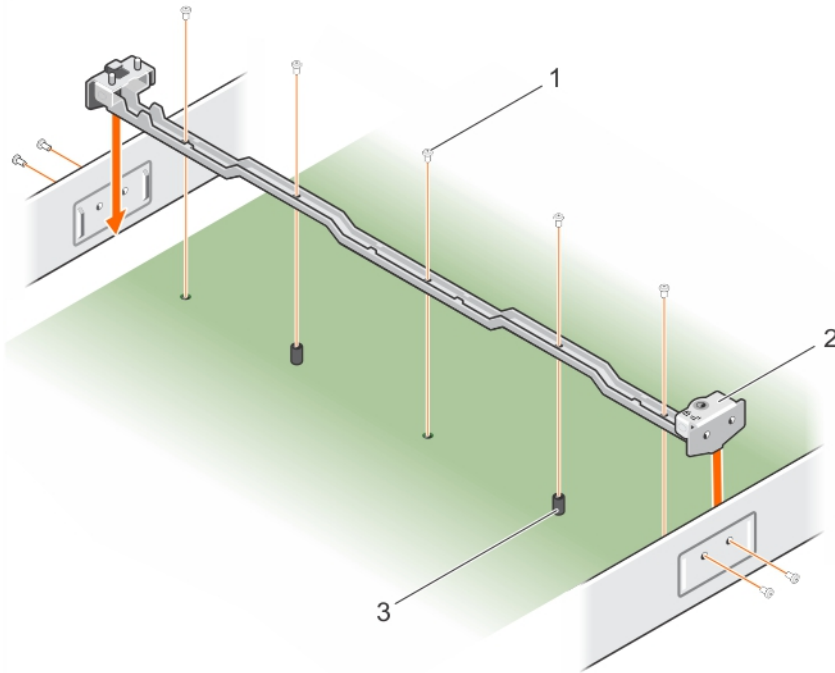

Figure 12. Installing the cooling shroud retention bar

- | | |
|-----------------|---------------------------------|
| 1. screw (9) | 2. cooling shroud retention bar |
| 3. standoff (2) | |

Next steps

1. Install the cooling shroud.
2. Follow the procedure listed in the After working inside your system section.

Related Links

- [Safety instructions](#)
- [Before working inside your system](#)
- [Installing the sled](#)
- [Removing the cooling shroud retention bar](#)
- [After working inside your system](#)

System memory

Your system supports DDR4 registered DIMMs (RDIMMs) and load reduced DIMMs (LRDIMMs). It supports DDR4 voltage specifications.

 **NOTE:** MT/s indicates DIMM speed in MegaTransfers per second.

Memory bus operating frequency can be either 2400 MT/s, 2133 MT/s, and 1866 MT/s depending on the:

- DIMM type (RDIMM or LRDIMM)
- DIMM configuration (number of ranks)
- Maximum frequency of the DIMMs
- Number of DIMMs populated per channel
- System profile selected (for example, Performance Optimized, Custom, or Dense Configuration Optimized)
- Maximum supported DIMM frequency of the processors

Your system contains 48 memory sockets split into four sets of 12 sockets, one set per processor. Each 12-socket set is organized into four channels. In each channel, the release levers of the first socket are marked white, the second socket black, and the third socket green.

 **NOTE:** DIMMs in sockets A1 to A12 are assigned to processor 1, B1 to B12 to processor 2, C1 to C12 to processor 3, and D1 to D12 to processor 4.

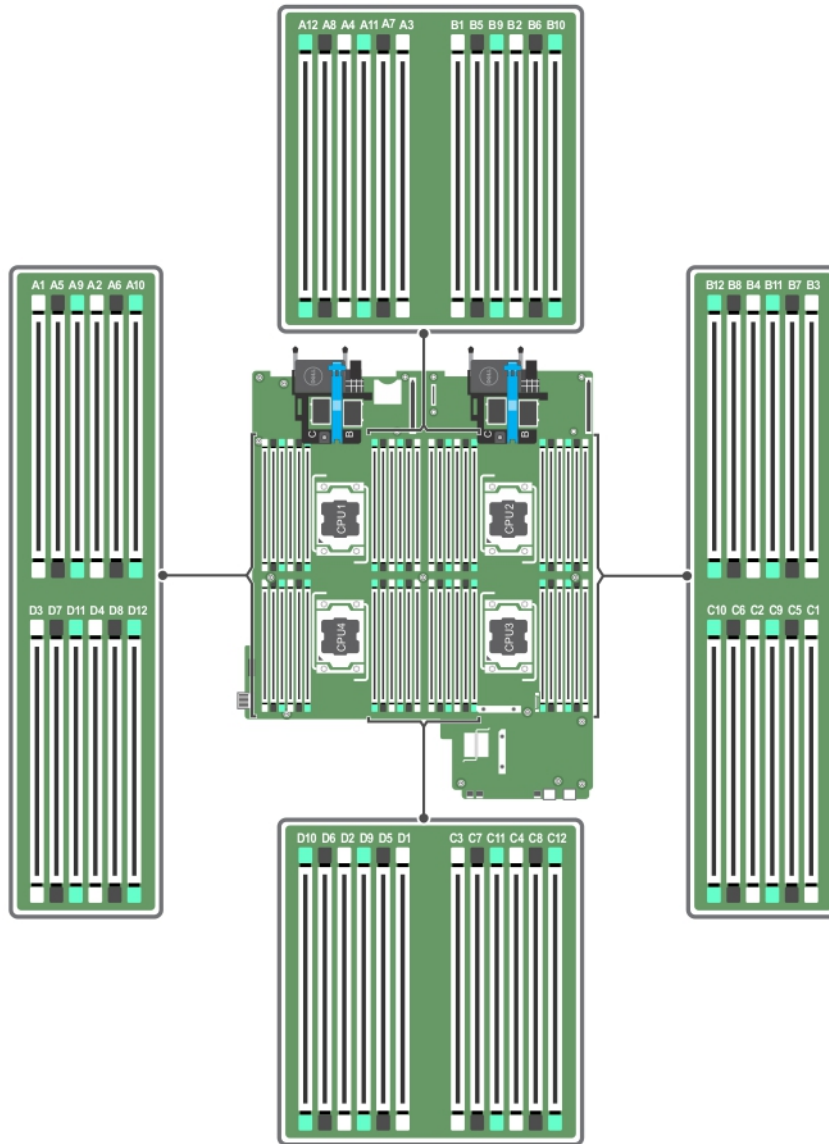

Figure 13. Memory socket locations

Memory channels are organized as follows:

- | | |
|--------------------|---|
| Processor 1 | channel 0: memory sockets A1, A5, and A9
channel 1: memory sockets A2, A6, and A10
channel 2: memory sockets A3, A7, and A11
channel 3: memory sockets A4, A8, and A12 |
| Processor 2 | channel 0: memory sockets B1, B5, and B9
channel 1: memory sockets B2, B6, and B10
channel 2: memory sockets B3, B7, and B11 |

	channel 3: memory sockets B4, B8, and B12
Processor 3	channel 0: memory sockets C1, C5, and C9
	channel 1: memory sockets C2, C6, and C10
	channel 2: memory sockets C3, C7, and C11
	channel 3: memory sockets C4, C8, and C12
Processor 4	channel 0: memory sockets D1, D5, and D9
	channel 1: memory sockets D2, D6, and D10
	channel 2: memory sockets D3, D7, and D11
	channel 3: memory sockets D4, D8, and D12

The following table shows the memory populations and operating frequencies for the supported configurations.

Table 20. Supported configurations

DIMM type	DIMMs populated/channel	Voltage	Operating frequency (in MT/s)	Maximum DIMM rank/channel
RDIMM	1	1.2 V	2400, 2133, and 1866	single and dual rank
	2		2400, 2133, and 1866	single and dual rank
	3		1866	single and dual rank
LRDIMM	1	1.2 V	2400, 2133, and 1866	quad rank
	2		2400, 2133, and 1866	quad rank
	3		2133	quad rank

General memory module installation guidelines

Your system supports Flexible Memory Configuration, enabling the system to be configured and run in any valid chipset architectural configuration. The following are the recommended guidelines for best performance:

- LRDIMMs, and RDIMMs must not be mixed.
- x4 and x8 DRAM based DIMMs can be mixed. For more information, see the Mode-specific guidelines section.
- A maximum of three single- or dual-rank RDIMMs can be populated in a channel.
- Up to three LRDIMMs can be populated regardless of rank count.
- Populate four DIMMs per processor (one DIMM per channel) at a time to maximize performance.
- If memory modules with different speeds are installed, they operate at the speed of the slowest installed memory module(s) or slower depending on system DIMM configuration.
- Populate DIMMs based on the following processor-heat sink configurations.
- Populate DIMM sockets only if a processor is installed. For single-processor systems, sockets A1 to A12 are available. For dual-processor systems, sockets A1 to A12 and sockets B1 to B12 are available.
- Populate all sockets with white release tabs first, black, and then green.

- Populate the sockets by highest capacity DIMM in the following order - first in sockets with white release levers and then black. For example, if you want to mix 16 GB and 8 GB DIMMs, populate 16 GB DIMMs in the sockets with white release tabs and 8 GB DIMMs in the sockets with black release tabs.
- In a dual-processor configuration, the memory configuration for each processor must be identical. For example, if you populate socket A1 for processor 1, then populate socket B1 for processor 2, and so on.
- Memory modules of different sizes can be mixed provided that other memory population rules are followed (for example, 4 GB and 8 GB memory modules can be mixed).
- Depending on mode-specific guidelines, populate four DIMMs per processor (one DIMM per channel) at a time to maximize performance. For more information, see the Mode-specific guidelines section.

Table 21. Heat sink — processor configurations

Processor Configuration	Processor Type (in Watts)	Heat Sink Width	Number of DIMMs	
			Maximum System Capacity	Reliability, Availability, and Serviceability (RAS) Features
Dual processor	Up to 105 W, 120 W, or 135 W	74 mm	24	24
Quad processor	Up to 105 W, 120 W, or 135 W	74 mm	48	48

 **NOTE:** If you are using a 1.8-inch hard drive/SSD system with four processors, ensure that you use only 74 mm wide heat sinks for processors up to 105 W, 120 W, or 135 W.

Up to 120 W or 135 W 94 mm 40 (Three DIMMs in channel 0 and channel 2 and two DIMMs in channel 1 and channel 3) 32 (Two DIMMs per channel)

 **NOTE:** If you are using a 2.5-inch hard drive/SSD system with four processors, ensure that you use only 94 mm wide heat sinks for processors up to 120 W or 135 W.

 **NOTE:** When using a 94 mm wide heat sink for quad processors, the memory module sockets A10, A12, B10, B12, C10, C12, D10, and D12 are not available for population.

Related Links

[Mode-specific guidelines](#)

Mode-specific guidelines

Four memory channels are allocated to each processor. The allowable configurations depend on the memory mode selected.

Advanced Error Correction Code (lockstep)

Advanced Error Correction Code (ECC) mode extends SDDC from x4 DRAM based DIMMs to both x4 and x8 DRAMs. This protects against single DRAM chip failures during normal operation.

The installation guidelines for memory modules are as follows:

- Memory modules must be identical in size, speed, and technology.
- DIMMs installed in memory sockets with white release levers must be identical and the same rule applies for sockets with black release levers. This ensures that identical DIMMs are installed in matched pair—for example, A1 with A2, A3 with A4, A5 with A6, and so on.

Memory optimized (independent channel) mode

This mode supports Single Device Data Correction (SDDC) only for memory modules that use x4 device width. It does not impose any specific slot population requirements.

Memory sparing

 **NOTE:** To use memory sparing, this feature must be enabled in System Setup.

In this mode, one rank per channel is reserved as a spare. If persistent correctable errors are detected on a rank, the data from this rank is copied to the spare rank, and the failed rank is disabled.

With memory sparing enabled, the system memory available to the operating system is reduced by one rank per channel. For example, in a dual-processor configuration with sixteen 4 GB single-rank memory modules, the available system memory is: 3/4 (ranks/channel) × 16 (memory modules) × 4 GB = 48 GB, and not 16 (memory modules) × 4 GB = 64 GB.

 **NOTE:** Memory sparing does not offer protection against a multi-bit uncorrectable error.

 **NOTE:** Both Advanced ECC/Lockstep and Optimizer modes support memory sparing.

Related Links

[System Setup](#)

Memory mirroring

Memory mirroring offers the strongest memory module reliability mode compared to all other modes, providing improved uncorrectable multi-bit failure protection. In a mirrored configuration, the total available system memory is one half of the total installed physical memory. Half of the installed memory is used to mirror the active memory modules. In the event of an uncorrectable error, the system switches over to the mirrored copy. This ensures SDDC and multi-bit protection.

The installation guidelines for memory modules are as follows:

- Memory modules must be identical in size, speed, and technology.
- Memory modules installed in memory module sockets with white release levers must be identical and the same rule applies for sockets with black and green release tabs. This ensures that identical memory modules are installed in matched pairs—for example, A1 with A2, A3 with A4, A5 with A6, and so on.

Table 22. Processor configuration

Processor	Configuration	Memory population rules	Memory population information
Single CPU	Memory population order	{1,2}, {3,4}	See Memory mirroring note

Sample memory configurations

The following tables show sample memory configurations that follow the appropriate memory guidelines stated in this section.

 **NOTE:** 1R, 2R, and 4R in the following tables indicate single-, dual-, and quad-rank DIMMs.

Table 23. Memory configurations – two processors

System capacity (in GB)	DIMM size (in GB)	Number of DIMMs	Organization and speed	DIMM slot population
32	4	8	1R x8, 2133 MT/s	A1, A2, A3, A4, B1, B2, B3, B4
64	4	16	1R x8, 2133 MT/s	A1, A2, A3, A4, A5, A6, A7, A8, B1, B2, B3, B4, B5, B6, B7, B8
64	8	8	1R x8, 2400 MT/s	A1, A2, A3, A4, B1, B2, B3, B4
64	8	8	2R x8, 2133 MT/s	A1, A2, A3, A4, B1, B2, B3, B4
96	4	24	1R x8, 2133 MT/s	A1, A2, A3, A4, A5, A6, A7, A8, A9, A10, A11, A12, B1, B2, B3, B4, B5, B6, B7, B8, B9, B10, B11, B12
96	8	12	2R x8, 2133 MT/s	A1, A2, A3, A4, A5, A6, B1, B2, B3, B4, B5, B6
128	8	16	1R x8, 2133 MT/s	A1, A2, A3, A4, A5, A6, A7, A8, B1, B2, B3, B4, B5, B6, B7, B8
128	16	8	2R x4, 2133 MT/s	A1, A2, A3, A4, B1, B2, B3, B4
128	16	8	2R x8, 2400 MT/s	A1, A2, A3, A4, B1, B2, B3, B4
160	8	20	2R x8, 2133 MT/s	A1, A2, A3, A4, A5, A6, A7, A8, A9, A10, B1, B2, B3, B4, B5, B6, B7, B8, B9, B10
160	16 and 8	12	2R x4, 2133 MT/s 2R x8, 2133 MT/s	A1, A2, A3, A4, A5, A6, B1, B2, B3, B4, B5, B6
				 NOTE: 16 GB DIMMs must be installed in the slots numbered A1, A2, A3, A4, B1, B2, B3, and B4 and 8 GB DIMMs must be installed in slots A5, A6, B5 and B6.
192	8	24	1R x8, 2133 MT/s	A1, A2, A3, A4, A5, A6, A7, A8, A9, A10, A11, A12, B1, B2, B3, B4, B5, B6, B7, B8, B9, B10, B11, B12

System capacity (in GB)	DIMM size (in GB)	Number of DIMMs	Organization and speed	DIMM slot population
192	16	12	2R x4, 2133 MT/s	A1, A2, A3, A4, A5, A6, B1, B2, B3, B4, B5, B6
256	16	16	2R x4, 2133 MT/s	A1, A2, A3, A4, A5, A6, A7, A8, B1, B2, B3, B4, B5, B6, B7, B8
384	16	24	2R x4, 2133 MT/s	A1, A2, A3, A4, A5, A6, A7, A8, A9, A10, A11, A12, B1, B2, B3, B4, B5, B6, B7, B8, B9, B10, B11, B12
512	32	16	2R, x4, 2400 MT/s	A1, A2, A3, A4, A5, A6, A7, A8, B1, B2, B3, B4, B5, B6, B7, B8
512	32	16	4R, x4, 2133 MT/s 2R, x4, 2133 MT/s	A1, A2, A3, A4, A5, A6, A7, A8, B1, B2, B3, B4, B5, B6, B7, B8
768	32	24	4R, x4, 2133 MT/s 2R, x4, 2133 MT/s	A1, A2, A3, A4, A5, A6, A7, A8, A9, A10, A11, A12, B1, B2, B3, B4, B5, B6, B7, B8, B9, B10, B11, B12
1536	64	24	4R, x4, 2400 MT/s	A1, A2, A3, A4, A5, A6, A7, A8, A9, A10, A11, A12, B1, B2, B3, B4, B5, B6, B7, B8, B9, B10, B11, B12

Table 24. Memory configurations – four processors

System capacity (in GB)	DIMM size (in GB)	Number of DIMMs	Organization and speed	DIMM slot population
64	4	16	1R x8, 2133 MT/s	A1, A2, A3, A4, B1, B2, B3, B4, C1, C2, C3, C4, D1, D2, D3, D4
96	8	24	1R x8, 2400 MT/s	A1, A2, A3, A4, A5, A6, B1, B2, B3, B4, B5, B6, C1, C2, C3, C4, C5, C6, D1, D2, D3, D4, D5, D6
96	8	24	2R x8, 2133 MT/s	A1, A2, A3, A4, A5, A6, B1, B2, B3, B4, B5, B6, C1, C2, C3, C4, C5, C6, D1, D2, D3, D4, D5, D6
128	4	32	1R x8, 2133 MT/s	A1, A2, A3, A4, A5, A6, A7, A8, B1, B2, B3, B4, B5, B6, B7, B8, C1, C2, C3, C4, C5,

System capacity (in GB)	DIMM size (in GB)	Number of DIMMs	Organization and speed	DIMM slot population
				C6, C7, C8, D1, D2, D3, D4, D5, D6, D7, D8
128	8	16	2R x8, 2400 MT/s	A1, A2, A3, A4, B1, B2, B3, B4, C1, C2, C3, C4, D1, D2, D3, D4
192	4	48	1R x8, 2133 MT/s	A1, A2, A3, A4, A5, A6, A7, A8, A9, A10, A11, A12, B1, B2, B3, B4, B5, B6, B7, B8, B9, B10, B11, B12, C1, C2, C3, C4, C5, C6, C7, C8, C9, C10, C11, C12, D1, D2, D3, D4, D5, D6, D7, D8, D9, D10, D11, D12
192	8	24	2R x8, 2400 MT/s	A1, A2, A3, A4, A5, A6, B1, B2, B3, B4, B5, B6, C1, C2, C3, C4, C5, C6, D1, D2, D3, D4, D5, D6
256	16	16	2R x4, 2133 MT/s	A1, A2, A3, A4, B1, B2, B3, B4, C1, C2, C3, C4, D1, D2, D3, D4
256	16	16	2R x8, 2400 MT/s	A1, A2, A3, A4, A5, A6, B1, B2, B3, B4, B5, B6, C1, C2, C3, C4, C5, C6, D1, D2, D3, D4, D5, D6
384	16	24	2R x4, 2133 MT/s	A1, A2, A3, A4, A5, A6, B1, B2, B3, B4, B5, B6, C1, C2, C3, C4, C5, C6, D1, D2, D3, D4, D5, D6
512	32	16	4R, x4, 2133 MT/s 2R, x4, 2400 MT/s	A1, A2, A3, A4, B1, B2, B3, B4, C1, C2, C3, C4, D1, D2, D3, D4
768	32	24	4R, x4, 2133 MT/s 2R, x4, 2400 MT/s	A1, A2, A3, A4, A5, A6, B1, B2, B3, B4, B5, B6, C1, C2, C3, C4, C5, C6, D1, D2, D3, D4, D5, D6
1024	32	32	4R, x4, 2133 MT/s 2R, x4, 2400 MT/s	A1, A2, A3, A4, A5, A6, A7, A8, B1, B2, B3, B4, B5, B6, B7, B8, C1, C2, C3, C4, C5, C6, C7, C8, D1, D2, D3, D4, D5, D6, D7, D8
1024	64	16	4R, x4, 2400 MT/s	A1, A2, A3, A4, A5, A6, A7, A8, B1, B2, B3, B4, B5, B6, B7, B8, C1, C2, C3, C4, C5,

System capacity (in GB)	DIMM size (in GB)	Number of DIMMs	Organization and speed	DIMM slot population
1536	32	48	4R, x4, 2133 MT/s 2R, x4, 2400 MT/s	C6, C7, C8, D1, D2, D3, D4, D5, D6, D7, D8 A1, A2, A3, A4, A5, A6, A7, A8, A9, A10, A11, A12, B1, B2, B3, B4, B5, B6, B7, B8, B9, B10, B11, B12, C1, C2, C3, C4, C5, C6, C7, C8, C9, C10, C11, C12, D1, D2, D3, D4, D5, D6, D7, D8, D9, D10, D11, D12
3072	64	48	4R, x4, 2133 MT/s 2R, x4, 2400 MT/s	A1, A2, A3, A4, A5, A6, A7, A8, A9, A10, A11, A12, B1, B2, B3, B4, B5, B6, B7, B8, B9, B10, B11, B12, C1, C2, C3, C4, C5, C6, C7, C8, C9, C10, C11, C12, D1, D2, D3, D4, D5, D6, D7, D8, D9, D10, D11, D12

Removing memory modules

Prerequisites

 **CAUTION:** Many repairs may only be done by a certified service technician. You should only perform troubleshooting and simple repairs as authorized in your product documentation, or as directed by the online or telephone service and support team. Damage due to servicing that is not authorized by Dell is not covered by your warranty. Read and follow the safety instructions that are shipped with your product.

1. Follow the safety guidelines listed in the Safety instructions section.
2. Follow the procedure listed in the Before working inside your system section.
3. Remove the cooling shroud.

 **WARNING:** The memory modules are hot to touch for some time after the system has been powered down. Allow the memory modules to cool before handling them. Handle the memory modules by the card edges and avoid touching the components or metallic contacts on the memory module.

 **CAUTION:** To ensure proper system cooling, memory module blanks must be installed in any memory socket that is not occupied. Remove memory module blanks only if you intend to install memory modules in those sockets.

Steps

1. Locate the appropriate memory module socket.

 **CAUTION:** Handle each memory module only by the card edges, ensuring not to touch the middle of the memory module or metallic contacts.

2. To release the memory module from the socket, simultaneously press the ejectors on both ends of the memory module socket.
3. Lift and remove the memory module from the system.

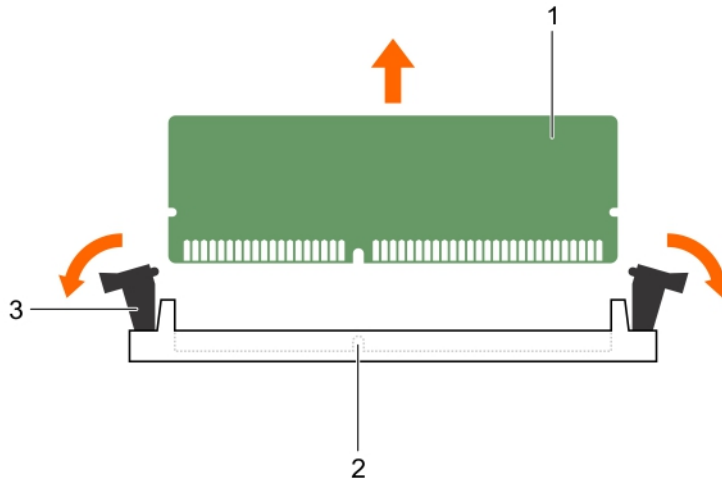



Figure 14. Removing the memory module

1. memory module
2. memory module socket
3. memory module socket ejector (2)

Next steps

1. Install the memory module.
 **NOTE:** If you are removing the memory module permanently, install a memory module blank.
2. Install the cooling shroud.
3. Follow the procedure listed in the After working inside your system section.

Related Links

- [Safety instructions](#)
- [Before working inside your system](#)
- [Removing the cooling shroud](#)
- [Installing memory modules](#)
- [After working inside your system](#)

Installing memory modules

Prerequisites

-  **WARNING:** The memory modules are hot to touch for some time after the system has been powered down. Allow the memory modules to cool before handling them. Handle the memory modules by the card edges and avoid touching the components or metallic contacts on the memory module.

 **CAUTION:** Many repairs may only be done by a certified service technician. You should only perform troubleshooting and simple repairs as authorized in your product documentation, or as directed by the online or telephone service and support team. Damage due to servicing that is not authorized by Dell is not covered by your warranty. Read and follow the safety instructions that are shipped with your product.

1. Follow the safety guidelines listed in the Safety instructions section.
2. Follow the procedure listed in the Before working inside your system section.
3. If installed, remove the memory module or the memory-module blank.

Steps

1. Locate the appropriate memory module socket.

 **CAUTION:** Handle each memory module only by the card edges, ensuring not to touch the middle of the memory module or metallic contacts.

2. If a memory module or a memory module blank is installed in the socket, remove it.

 **NOTE:** Retain the removed memory module blank(s) for future use.

 **CAUTION:** To prevent damage to the memory module or the memory module socket during installation, do not bend or flex the memory module; insert both ends of the memory module simultaneously.

3. Open the ejectors on the memory module socket outward to allow the memory module to be inserted into the socket.
4. Align the edge connector of the memory module with the alignment key of the memory module socket, and insert the memory module in the socket.

 **CAUTION:** Do not apply pressure at the center of the memory module; apply pressure at both ends of the memory module evenly.

 **NOTE:** The memory module socket has an alignment key that enables you to install the memory module in the socket in only one orientation.

5. Press the memory module with your thumbs until the socket levers firmly click into place. When the memory module is properly seated in the socket, the levers on the memory module socket align with the levers on the other sockets that have memory modules installed.

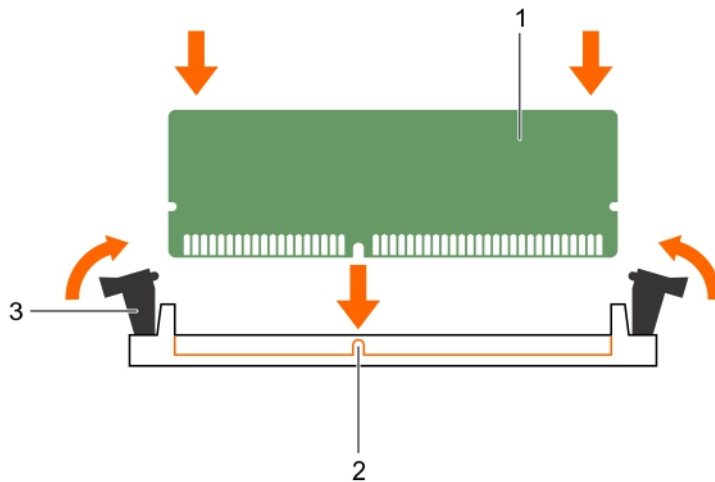

Figure 15. Installing the memory module

1. memory module
2. alignment key
3. memory module socket ejector (2)

Next steps

1. Follow the procedure listed in the After working inside your system section.
2. Press F2 to enter System Setup, and check the **System Memory** setting.
The system should have already changed the value to reflect the installed memory.
3. If the value is incorrect, one or more of the memory modules may not be installed properly. Ensure that the memory module is firmly seated in the memory module socket.
4. Run the system memory test in system diagnostics.

Related Links

- [Safety instructions](#)
- [Before working inside your system](#)
- [Installing the cooling shroud](#)
- [Removing memory modules](#)
- [Removing a processor blank and DIMM blank](#)
- [After working inside your system](#)

Processor blank and DIMM blank

The processor blank and DIMM blank supplied with your system aids in directing airflow over the unused processor sockets and DIMM slots.

⚠ CAUTION: If you are permanently removing a processor, you must install a socket protective cap and a processor blank and DIMM blank in the vacant socket to ensure proper system cooling. The processor blank and DIMM blank covers the vacant sockets for the DIMMs and the processor.

Removing a processor blank and DIMM blank

Prerequisites

CAUTION: Many repairs may only be done by a certified service technician. You should only perform troubleshooting and simple repairs as authorized in your product documentation, or as directed by the online or telephone service and support team. Damage due to servicing that is not authorized by Dell is not covered by your warranty. Read and follow the safety instructions that came with the product.

NOTE: You must remove processor blank and DIMM blank when installing four processors or service other components inside the system.

1. Follow the safety guidelines listed in the Safety instructions section.
2. Follow the procedure listed in the Before working inside your system section.

Steps

1. Press the ejectors on both ends of the memory module sockets to open processor blank and DIMM blank.
2. Hold the processor blank and DIMM blank by its edges and lift it away from the system.

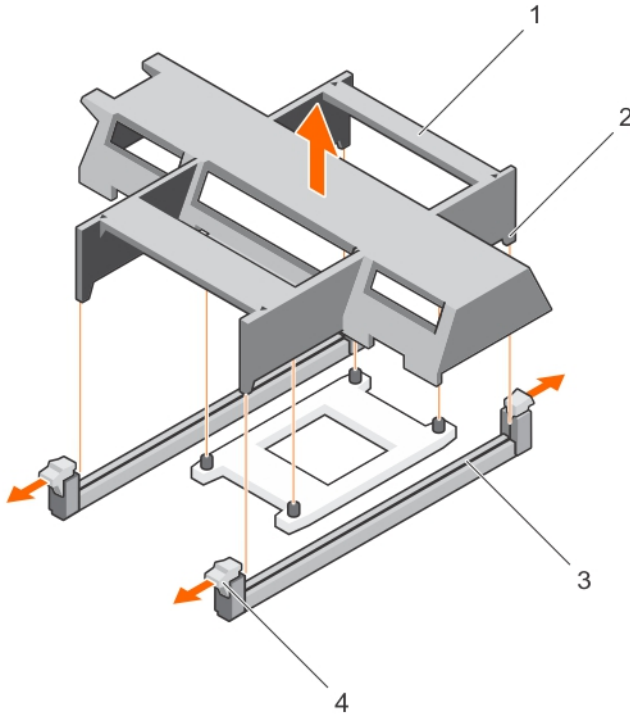

Figure 16. Removing a processor blank and DIMM blank

- | | |
|-----------------------------------|--|
| 1. processor blank and DIMM blank | 2. tab on the processor blank and DIMM blank (4) |
| 3. memory module socket (2) | 4. memory module socket ejector (2) |

Next steps

1. Install the processor and the heat sink.

2. If you are removing a processor permanently, install the processor blank.
3. Follow the procedure listed in the After working inside your system section.

Related Links

- [Safety instructions](#)
- [Before working inside your system](#)
- [Installing a processor](#)
- [Installing a heat sink](#)
- [Installing a processor blank and DIMM blank](#)
- [After working inside your system](#)

Installing a processor blank and DIMM blank

Prerequisites

 **CAUTION:** Many repairs may only be done by a certified service technician. You should only perform troubleshooting and simple repairs as authorized in your product documentation, or as directed by the online or telephone service and support team. Damage due to servicing that is not authorized by Dell is not covered by your warranty. Read and follow the safety instructions that came with the product.

 **NOTE:** You must remove processor blank and DIMM blank when installing four processors or service other components inside the system.

1. Follow the safety guidelines listed in the Safety instructions section.
2. Follow the procedure listed in the Before working inside your system section.
3. If installed, remove the heat sink and the processor.
4. Ensure that the memory module socket ejectors are in the open position.

Steps

1. Align the processor blank and DIMM blank with the memory module sockets on the system board.
2. Lower the processor blank and DIMM blank onto the memory module sockets such that the bottom edges of the blank is firmly inserted into the memory module sockets.
3. Press the blank firmly until the memory module socket ejectors click into place.

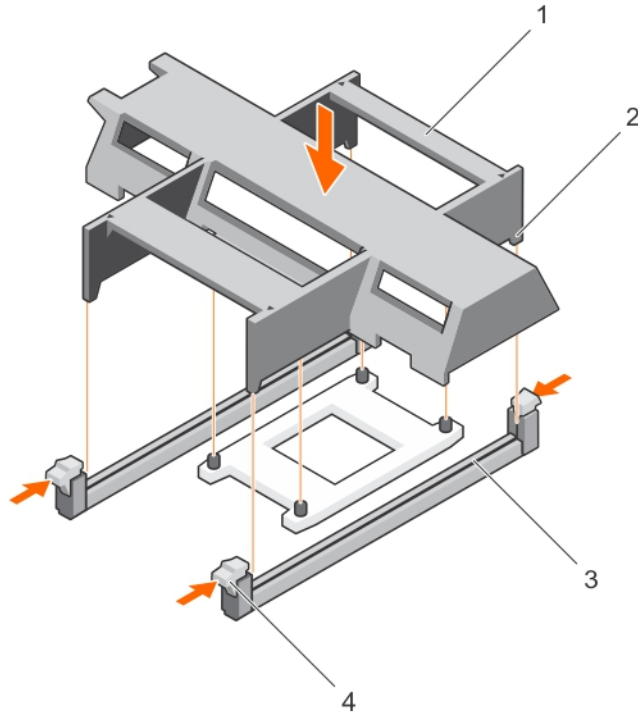

Figure 17. Installing a processor blank and DIMM blank

- | | |
|-----------------------------------|--|
| 1. processor blank and DIMM blank | 2. tab on the processor blank and DIMM blank (4) |
| 3. memory module socket (2) | 4. memory module socket ejector (2) |

Next steps

1. Follow the procedure listed in the After working inside your system section.

Related Links

- [Safety instructions](#)
- [Before working inside your system](#)
- [Removing a heat sink](#)
- [Removing a processor](#)
- [After working inside your system](#)

Processors

Your system supports up to four Intel Xeon E5-4600 v4 or v3 product family processors.

- △ **CAUTION:** If you are using a system with two processors, ensure that you use 74 mm wide heat sinks for processors up to 105 W, 120 W or 135 W.
- △ **CAUTION:** If you are using a 2.5-inch hard drive/SSD system with four processors, ensure that you use 94 mm wide heat sinks for processors up to 105 W, 120 W or 135 W.
- △ **CAUTION:** If you are using a 1.8-inch hard drive/SSD system with four processors, ensure that you use only 74 mm wide heat sinks for processors up to 105 W, 120 W, or 135 W.

 **NOTE:** Mixing of processors of different wattages is not supported.

Use the following procedure when:

- Installing an additional processor
- Replacing a processor

Removing a heat sink

Prerequisites

 **CAUTION:** Many repairs may only be done by a certified service technician. You should only perform troubleshooting and simple repairs as authorized in your product documentation, or as directed by the online or telephone service and support team. Damage due to servicing that is not authorized by Dell is not covered by your warranty. Read and follow the safety instructions that came with the product.

 **NOTE:** This is a Field Replaceable Unit (FRU). Removal and installation procedures should be performed only by Dell certified service technicians.

 **CAUTION:** Never remove the heat sink from a processor unless you intend to remove the processor. The heat sink is necessary to maintain proper thermal conditions.

 **NOTE:** To ensure proper system cooling, you must install a processor blank and heat sink blank in any empty processor socket.

1. Follow the safety guidelines listed in the Safety instructions section.
2. Follow the procedure listed in the Before working inside your system.
3. Keep the Phillips #2 screwdriver ready.
4. Remove the cooling shroud.

 **WARNING:** The heat sink is hot to touch for some time after the system has been powered down. Allow the heat sink to cool before removing it.

Steps

1. Loosen one of the screws that secure the heat sink to the system board.
Allow some time (approximately 30 seconds) for the heat sink to loosen from the processor.
2. Remove the screw diagonally opposite the screw you first removed.
3. Repeat the procedure for the remaining two screws.

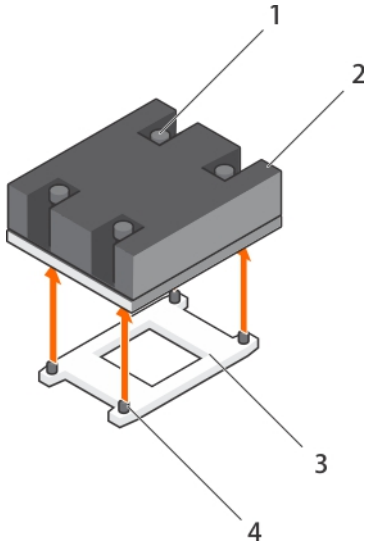

Figure 18. Removing the heat sink

- | | |
|------------------------|-----------------------------------|
| 1. retention screw (4) | 2. heat sink |
| 3. processor socket | 4. heat sink retention socket (4) |

Next steps



1. Remove the processor.
2. Install the heat sink.
3. Follow the procedure listed in the After working inside your system section.

Related Links

- [Safety instructions](#)
- [Before working inside your system](#)
- [Removing the cooling shroud](#)
- [Removing a processor](#)
- [Installing a heat sink](#)
- [After working inside your system](#)

Removing a processor

Prerequisites

-  **WARNING:** The processor is hot to touch for some time after the system has been powered down. Allow the processor to cool before removing it.
-  **CAUTION:** Many repairs may only be done by a certified service technician. You should only perform troubleshooting and simple repairs as authorized in your product documentation, or as directed by the online or telephone service and support team. Damage due to servicing that is not authorized by Dell is not covered by your warranty. Read and follow the safety instructions that are shipped with your product.
-  **CAUTION:** The processor is held in its socket under strong pressure. Be aware that the release lever can spring up suddenly if not firmly grasped.

 **CAUTION:** If you are permanently removing a processor, you must install a socket protective cap and a processor/DIMM blank in the vacant socket to ensure proper system cooling. The processor/DIMM blank covers the vacant sockets for the DIMMs and the processor.

 **NOTE:** This is a Field Replaceable Unit (FRU). Removal and installation procedures should be performed only by Dell certified service technicians.

 **NOTE:** To ensure proper system cooling, you must install a processor blank in any empty processor socket.

1. Follow the safety guidelines listed in the Safety instructions section.
2. Follow the procedure listed in the Before working inside your system section.
3. If you are upgrading your system (from a single processor system to a dual processor system or a processor with a higher processor bin), download the latest system BIOS version from **Dell.com/support** and follow the instructions included in the compressed download file to install the update on your system.
4. Remove the cooling shroud.

 **NOTE:** If applicable, close the expansion card latch on the cooling shroud to release the full length card.

5. Remove the heat sink.
6. If installed, remove the processor/DIMM blank.
7. Keep the Phillips #2 screwdriver ready.

Steps

1. Using a clean, lint-free cloth remove any thermal grease from the surface of the processor shield.

 **CAUTION:** The processor is held in its socket under strong pressure. Be aware that the release lever can spring up suddenly if not firmly grasped.

2. Position your thumb firmly over the socket-release lever 1 and lever 2 of the processor and release both the levers simultaneously from the locked position by pushing down and out from under the tab.

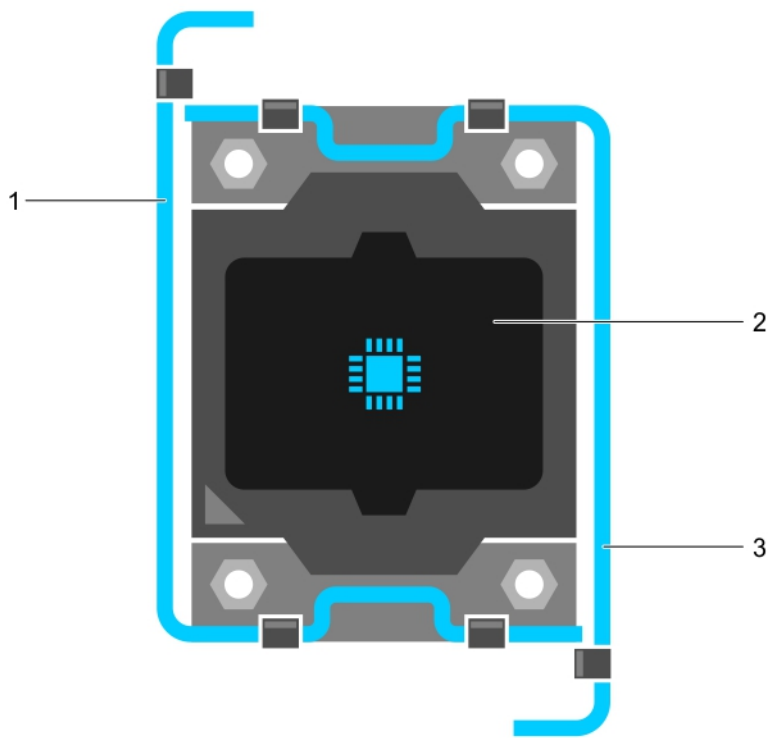

Figure 19. Processor shield opening and closing lever sequence

1. socket-release lever 1
 2. processor
 3. socket-release lever 2
3. Hold the tab on the processor shield and rotate the shield upward and out of the way.
 4. Lift the processor out of the socket and leave the release lever up so that the socket is ready for the new processor.

Related Links

- [Safety instructions](#)
- [Before working inside your system](#)
- [Removing the cooling shroud](#)
- [Removing a heat sink](#)
- [Installing a processor](#)
- [Installing a heat sink](#)
- [Installing the cooling shroud](#)
- [After working inside your system](#)

Installing a processor

Prerequisites

 **CAUTION:** Many repairs may only be done by a certified service technician. You should only perform troubleshooting and simple repairs as authorized in your product documentation, or as directed by the online or telephone service and support team. Damage due to servicing that is not authorized by Dell is not covered by your warranty. Read and follow the safety instructions that are shipped with your product.

 **NOTE:** This is a Field Replaceable Unit (FRU). Removal and installation procedures should be performed only by Dell certified service technicians.

1. Follow the safety guidelines listed in the Safety instructions section.
2. Follow the procedure listed in the Before working inside your system section.
3. Remove the processor.

 **NOTE:** You must remove a processor to upgrade a processor or replace a faulty processor.

 **WARNING:** The heat sink and processor are too hot to the touch for some time after the system has been powered down. Allow the heat sink and processor to cool down before handling them.

 **CAUTION:** Never remove the heat sink from a processor unless you intend to remove the processor. The heat sink is necessary to maintain proper thermal conditions.

Steps

1. Unlatch and rotate the socket-release levers 90 degrees upward and ensure that the socket-release lever is fully open.
2. Hold the tab on the processor shield and rotate the shield upward and out of the way.

 **NOTE:** Dell recommends that you install or remove the socket protective cap from the processor shield with the processor shield in the open position.

3. If installed, remove the socket protective cap from the processor shield. To remove the socket protective cap, push the cap from the inside of the processor shield and move it away from the socket pins.

 **CAUTION:** Positioning the processor incorrectly can permanently damage the system board or the processor. Be careful not to bend the pins in the socket.

 **CAUTION:** Do not use force to seat the processor. When the processor is positioned correctly, it engages easily into the socket.

4. Install the processor in the socket:
 - a. Identify the pin-1 corner of the processor by locating the tiny gold triangle on one corner of the processor. Place this corner in the same corner of the ZIF (Zero Insertion Force) socket identified by a corresponding triangle on the system board.

- b. Align the pin-1 corner of the processor with the pin-1 corner of the system board.
- c. Set the processor lightly in the socket.
Because the system uses a ZIF processor socket, do not use force. When the processor is positioned correctly, it drops down into the socket with minimal pressure.
- d. Close the processor shield.
- e. Rotate the socket-release lever 1 and lever 2 simultaneously until it is locked in position.

Next steps

 **NOTE:** Ensure that you install the heat sink after you install the processor. The heat sink is necessary to maintain proper thermal conditions.

1. Install the heat sink.
2. If you are permanently removing the processor and the heat sink, ensure that you install a processor/DIMM blank.
3. Follow the procedure listed in the After working inside your system section.

Related Links

- [Safety instructions](#)
- [Before working inside your system](#)
- [Removing a heat sink](#)
- [Removing a processor](#)
- [Installing a heat sink](#)
- [Installing a processor blank and DIMM blank](#)
- [After working inside your system](#)

Installing a heat sink

Prerequisites

 **CAUTION:** Many repairs may only be done by a certified service technician. You should only perform troubleshooting and simple repairs as authorized in your product documentation, or as directed by the online or telephone service and support team. Damage due to servicing that is not authorized by Dell is not covered by your warranty. Read and follow the safety instructions that are shipped with your product.

1. Follow the safety guidelines listed in the Safety instructions section.
2. Follow the procedure listed in the Before working inside your system section.
3. Keep the Phillips #2 screwdriver ready.
4. Install the processor.

 **NOTE:** If you are installing a single processor, it must be installed in socket CPU1.

Steps

1. If you are using an existing heat sink, remove the thermal grease from the heat sink by using a clean lint-free cloth.
2. Use the thermal grease syringe included with your processor kit to apply the grease in a thin spiral on the top of the processor.

 **CAUTION:** Applying too much thermal grease can result in excess grease coming in contact with and contaminating the processor socket.

 **NOTE:** The thermal grease syringe is intended for one-time use only. Dispose of the syringe after you use it.

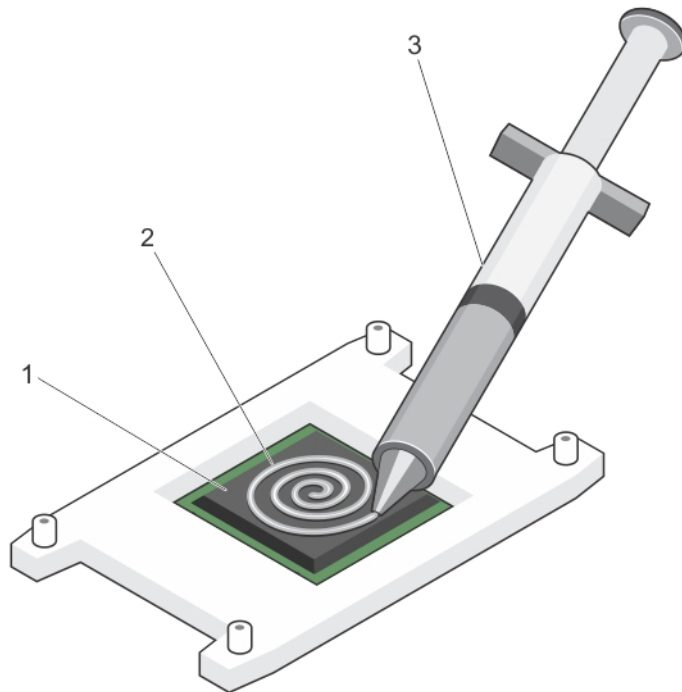



Figure 21. Applying thermal grease on the top of the processor

1. processor
 2. thermal grease
 3. thermal grease syringe
3. Place the heat sink onto the processor.
 4. Tighten one of the four screws to secure the heat sink to the system board.
 5. Tighten the screw diagonally opposite to the first screw you have tightened.
-  **NOTE:** Do not over-tighten the heat sink retention screws when installing the heat sink. To prevent over-tightening, tighten the retention screw until resistance is felt, and stop after the screw is seated. The screw tension should not be more than 6 in-lb (6.9 kg-cm).
6. Repeat the procedure for the remaining two screws.

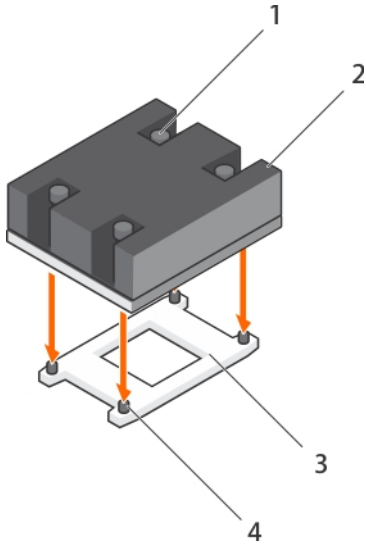

Figure 22. Installing the heat sink

- | | |
|------------------------|-----------------------------|
| 1. retention screw (4) | 2. heat sink |
| 3. processor socket | 4. retention screw slot (4) |

Next steps

1. Follow the procedure listed in the After working inside your system section.
2. While booting, press F2 to enter System Setup and verify that the processor information matches the new system configuration.
3. Run the system diagnostics to verify that the new processor operates correctly.

Related Links

- [Safety instructions](#)
- [Before working inside your system](#)
- [Installing a processor](#)
- [After working inside your system](#)

PCIe mezzanine card

Your system supports x16 Gen 3 PCIe mezzanine card, which provides an interface between the sled and the PCIe switches on the FX2s enclosure.

 **NOTE:** Ensure that the PCIe mezzanine card is set to **Enabled** in System Setup.

Removing a PCIe mezzanine card

Prerequisites

 **CAUTION:** Many repairs may only be done by a certified service technician. You should only perform troubleshooting and simple repairs as authorized in your product documentation, or as directed by the online or telephone service and support team. Damage due to servicing that is not authorized by Dell is not covered by your warranty. Read and follow the safety instructions that are shipped with your product.

 **NOTE:** You must remove the PCIe mezzanine card to replace a faulty PCIe mezzanine card or service other components inside the system.

1. Follow the safety guidelines listed in the Safety instructions section.
2. Follow the procedure listed in the Before working inside your system section.

Steps

1. Open the PCIe mezzanine card retention latch by pressing the release tab on the retention latch.
2. Pull back and hold the retention bracket away from the PCIe mezzanine card.
3. Lift the end of the retention latch until the two connectors on the PCIe mezzanine card disengage from connectors on the system board.

 **CAUTION:** To prevent damage to the PCIe mezzanine card, hold the card only by its edges.

4. Lift the PCIe mezzanine card away from the system.
5. Close the retention latch.

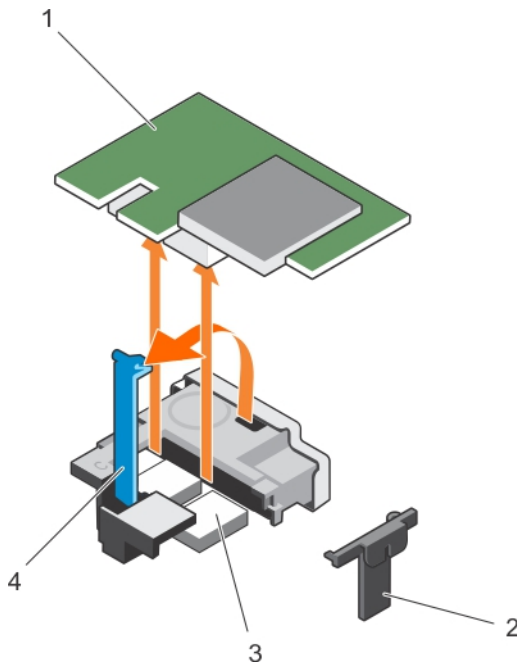

Figure 23. Removing a PCIe mezzanine card

- | | |
|--------------------------------------|--|
| 1. PCIe mezzanine card | 2. PCIe mezzanine card retention bracket |
| 3. PCIe mezzanine card connector (2) | 4. PCIe mezzanine card retention latch |

Next steps

1. Install the PCIe mezzanine card.
2. Follow the procedure listed in the After working inside your system section.

Related Links

- [Safety instructions](#)
- [Before working inside your system](#)
- [Installing a PCIe mezzanine card](#)
- [After working inside your system](#)

Installing a PCIe mezzanine card

Prerequisites

⚠ CAUTION: Many repairs may only be done by a certified service technician. You should only perform troubleshooting and simple repairs as authorized in your product documentation, or as directed by the online or telephone service and support team. Damage due to servicing that is not authorized by Dell is not covered by your warranty. Read and follow the safety instructions that are shipped with your product.

1. Follow the safety guidelines listed in the Safety instructions section.
2. Follow the procedure listed in the Before working inside your system section.
3. Remove the PCIe mezzanine card.

✎ NOTE: You must remove the PCIe mezzanine card to replace a faulty PCIe mezzanine card or service other components inside the system.

Steps

1. Open the PCIe mezzanine card retention latch by pressing the release tab on the retention latch and lifting the end of the latch.
2. If present, remove the connector cover from the PCIe mezzanine card bay.

⚠ CAUTION: To prevent damage to the PCIe mezzanine card, hold the card only by its edges.

3. Align the two connectors on the PCIe mezzanine card with the connectors on the system board.
4. Press down the PCIe mezzanine card until the connectors on the card completely engage with the corresponding connectors.

The retention bracket on the side of the chassis latches onto the PCIe mezzanine card.

5. Close the retention latch.

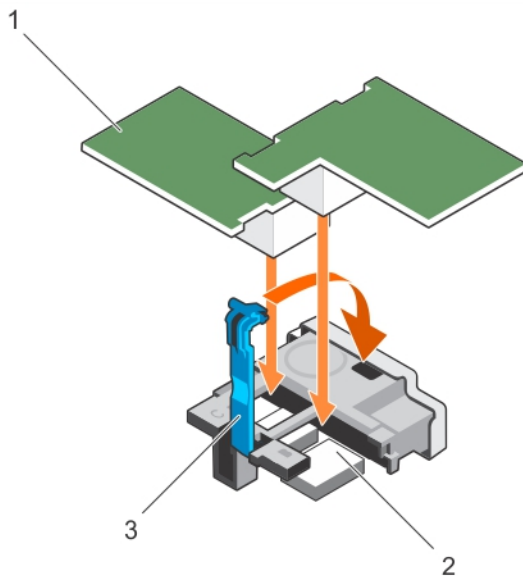

Figure 24. Installing a PCIe mezzanine card

1. PCIe mezzanine card

2. PCIe mezzanine card connector (2)

3. PCIe mezzanine card retention latch

Next steps

Follow the procedure listed in the After working inside your system section.

Related Links

[Safety instructions](#)

[Before working inside your system](#)

[Removing a PCIe mezzanine card](#)

[After working inside your system](#)

PCIe mezzanine card support bracket

Removing the PCIe mezzanine card support bracket

Prerequisites

 **CAUTION:** Many repairs may only be done by a certified service technician. You should only perform troubleshooting and simple repairs as authorized in your product documentation, or as directed by the online or telephone service and support team. Damage due to servicing that is not authorized by Dell is not covered by your warranty. Read and follow the safety instructions that came with the product.

 **NOTE:** You must remove the PCIe mezzanine card support bracket to replace a faulty system board.

1. Follow the safety guidelines listed in the Safety instructions section.
2. Follow the procedure listed in the Before working inside your system section.
3. Keep the #2 Phillips screwdriver ready.
4. Remove the PCIe mezzanine card.

Steps

1. Remove the screw that secures the PCIe mezzanine card support bracket to the system board.
2. Orient the PCIe mezzanine card support bracket upward and slide it until the tabs on the PCIe mezzanine card support bracket disengage from the slots on the system.
3. Lift the PCIe mezzanine card support bracket away from the system.

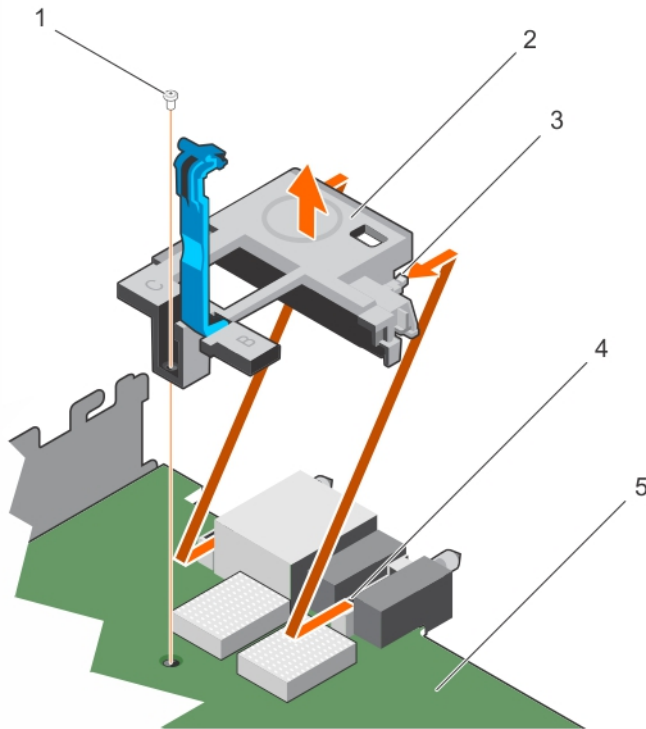

Figure 25. Removing the PCIe mezzanine card support bracket

- | | |
|---------------------------|--|
| 1. screw | 2. PCIe mezzanine card support bracket |
| 3. tab on the bracket (2) | 4. slot on the system (2) |
| 5. system board | |

Next steps

1. Follow the procedure listed in the After working inside your system section.

Related Links

- [Safety instructions](#)
- [Before working inside your system](#)
- [Removing a PCIe mezzanine card](#)
- [Installing the PCIe mezzanine card support bracket](#)
- [After working inside your system](#)

Installing the PCIe mezzanine card support bracket

Prerequisites

⚠ CAUTION: Many repairs may only be done by a certified service technician. You should only perform troubleshooting and simple repairs as authorized in your product documentation, or as directed by the online or telephone service and support team. Damage due to servicing that is not authorized by Dell is not covered by your warranty. Read and follow the safety instructions that came with the product.

1. Follow the safety guidelines listed in the Safety instructions section.
2. Follow the procedure listed in the Before working inside your system section.

3. Keep the #2 Phillips screwdriver ready.
4. Remove the PCIe mezzanine card support bracket.

 **NOTE:** You must remove the PCIe mezzanine card support bracket to replace a faulty system board.

Steps

1. Orient the PCIe mezzanine card support bracket toward the back of the system.
2. Align the tabs on the PCIe mezzanine card support bracket with the slots on the system and slide it until the tabs on the support bracket engage with the slots on the system.
3. Install the screw to secure the PCIe mezzanine card support bracket on the system board.

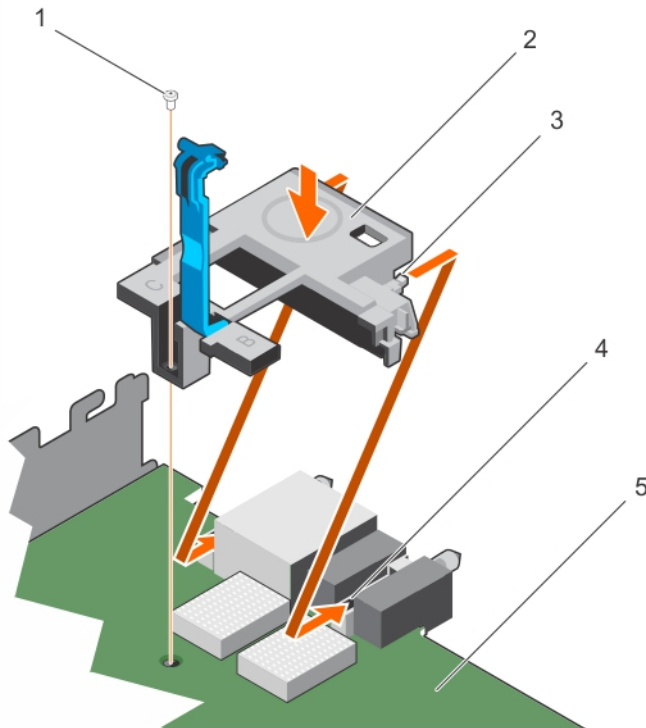

Figure 26. Installing the PCIe mezzanine card support bracket

- | | |
|---------------------------|--|
| 1. screw | 2. PCIe mezzanine card support bracket |
| 3. tab on the bracket (2) | 4. slot on the system (2) |
| 5. system board | |

Next steps

1. Install the PCIe mezzanine card.
2. Follow the procedure listed in the After working inside your system section.

Related Links

- [Safety instructions](#)
- [Before working inside your system](#)
- [Removing the PCIe mezzanine card support bracket](#)
- [Installing a PCIe mezzanine card](#)
- [After working inside your system](#)

Internal dual SD module (optional)

The Internal Dual SD module (IDSDM) provides you with a redundant SD card solution. You can configure the IDSDM for storage or as the OS boot partition. In modular servers, you can choose either a redundant SD module mode or share one slot with the iDRAC module and the remaining slot can be used for storage or as the OS partition.

The Internal Dual SD Module (IDSDM) card provides two SD card slots and a USB interface dedicated for the embedded hypervisor. This card offers the following features:

- Dual card operation—maintains a mirrored configuration by using SD cards in both slots and provides redundancy.
- Single card operation—single card operation is supported, but without redundancy.

Replacing an SD card

Prerequisites

 **CAUTION:** Many repairs may only be done by a certified service technician. You should only perform troubleshooting and simple repairs as authorized in your product documentation, or as directed by the online or telephone service and support team. Damage due to servicing that is not authorized by Dell is not covered by your warranty. Read and follow the safety instructions that are shipped with your product.

1. Follow the safety guidelines listed in the Safety instructions section.
2. Follow the procedure listed in the Before working inside your system section.
3. Enter the System Setup and ensure that the **Internal SD Card Port** is enabled.

 **CAUTION:** When an SD card failure occurs, and the **Internal SD Card Redundancy** option in the **Integrated Devices** screen of the **System Setup** is set to **Mirror Mode**, there may be loss of data. To avoid data loss, follow step 4 through step 6 of the **Troubleshooting an Internal SD Card** section.

 **NOTE:** The SD card in the lower card slot is the primary card (SD1) and the SD card in the upper card slot is the secondary card (SD2).

 **NOTE:** When an SD card failure occurs, the **Internal SD Card Redundancy** option in the System Setup is set to **Disabled** and the internal dual SD module controller notifies the system. On the next reboot, the system displays a message indicating the failure.

 **NOTE:** If the **Internal SD Card Redundancy** option is set to **Disabled**, replace the failed SD card with a new SD card.

Steps

1. Locate the SD card slot on the internal dual SD module (IDSDM) card.
2. Press inward on the card to release it from the slot, and remove the card.

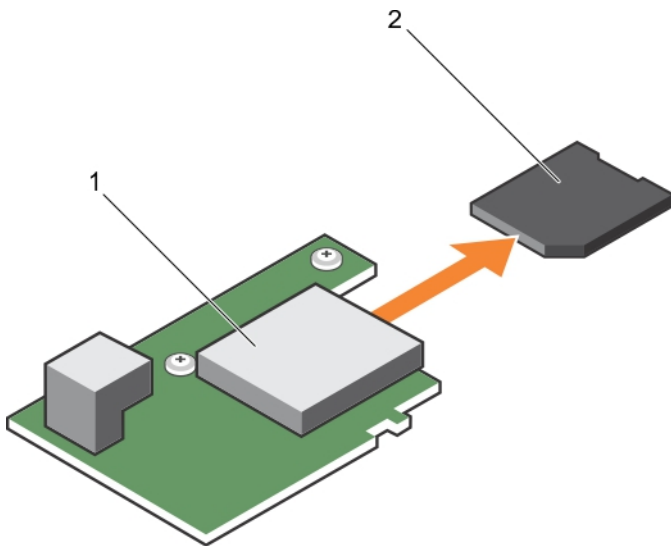

Figure 27. Replacing an SD card

- | | |
|---------------------------|---------------------------|
| 1. IDSDM card | 2. SD card |
| 3. upper card slot (SD 2) | 4. lower card slot (SD 1) |

Next steps

1. Follow the procedure listed in the After working inside your system section.
2. Enter the System Setup and ensure that the **Internal SD Card Port** and **Internal SD Card Redundancy** modes are enabled.
3. Check if the new SD card is functioning properly. If the problem persists, see the Getting Help section.

Internal USB key

The sled provides an internal USB connector for a USB flash memory key. The USB memory key can be used as a boot device, security key, or mass storage device. To use the internal USB connector, the **Internal USB Port** option must be enabled in the **Integrated Devices** screen of the System Setup.

To boot from the USB memory key, you must configure the USB memory key with a boot image, and then specify the USB memory key in the boot sequence in the System Setup. For information about creating a bootable file on the USB memory key, see the user documentation that shipped with the USB memory key.

Replacing the optional internal USB memory key

Prerequisites

- △ **CAUTION:** Many repairs may only be done by a certified service technician. You should only perform troubleshooting and simple repairs as authorized in your product documentation, or as directed by the online or telephone service and support team. Damage due to servicing that is not authorized by Dell is not covered by your warranty. Read and follow the safety instructions that are shipped with your product.
- △ **CAUTION:** To avoid interference with other components in the server module, the maximum permissible dimensions of the USB memory key are 15.9 mm wide x 57.15 mm long x 7.9 mm high.

1. Follow the safety guidelines listed in the Safety instructions section.
2. Follow the procedure listed in the Before working inside your system section.

Steps

1. Locate the USB port or USB memory key on the system board.
To locate the USB port, see the System board jumpers and connectors section.
2. If installed, remove the USB memory key from the USB port.

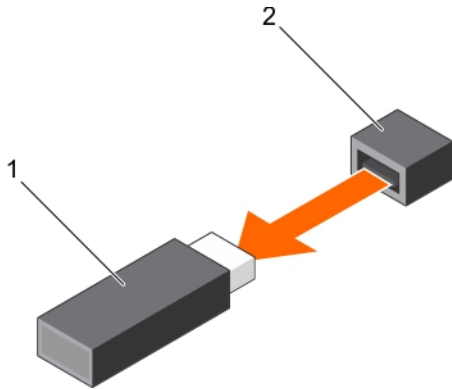

Figure 28. Removing the internal USB memory key

1. USB memory key
2. USB port

3. Insert the replacement USB memory key into the USB port.

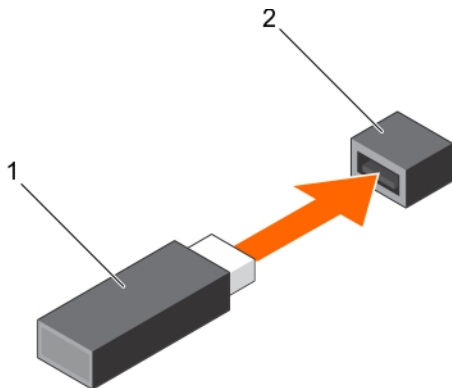

Figure 29. Installing the internal USB memory key

1. USB memory key
2. USB port

Next steps

1. Follow the procedure listed in the After working inside your system section.
2. While booting, press F2 to enter System Setup and verify that the system detects the USB memory key.

Removing the IDSDM card

Prerequisites

CAUTION: Many repairs may only be done by a certified service technician. You should only perform troubleshooting and simple repairs as authorized in your product documentation, or as directed by the online or telephone service and support team. Damage due to servicing that is not authorized by Dell is not covered by your warranty. Read and follow the safety instructions that came with the product.

NOTE: You must remove the IDSDM card to replace a faulty IDSDM card or service other components inside the system.

1. Follow the safety guidelines listed in the Safety instructions section.
2. Follow the procedure listed in the Before working inside your system section.
3. Keep the #2 Phillips screwdriver ready.
4. If installed, remove the internal USB key.
5. If installed, remove the SD card(s).

Steps

1. Remove the two screws securing the IDSDM card to the system board.
2. Remove the SD card slot bracket.

CAUTION: To prevent damage to the IDSDM card, hold the card only by its edges.

3. Lift the card away from the system.

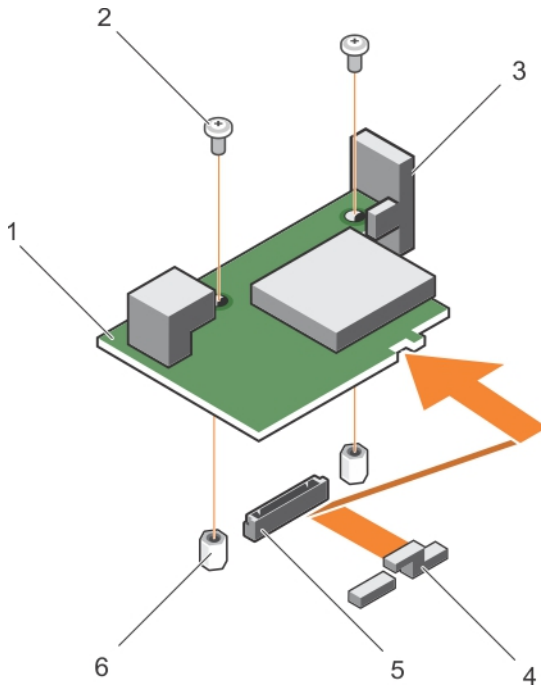

Figure 30. Removing the IDSDM card

- | | |
|-------------------------|--|
| 1. IDSDM card | 2. screw (2) |
| 3. SD card slot bracket | 4. PCIe mezzanine card support bracket |

5. connector

6. standoff (2)

Next steps

1. Install the IDSDM card.
2. Follow the procedure listed in the After working inside your system section.

Related Links

- [Safety instructions](#)
- [Before working inside your system](#)
- [Replacing an SD card](#)
- [Replacing the optional internal USB memory key](#)
- [Installing the IDSDM card](#)
- [After working inside your system](#)

Installing the IDSDM card

Prerequisites



CAUTION: Many repairs may only be done by a certified service technician. You should only perform troubleshooting and simple repairs as authorized in your product documentation, or as directed by the online or telephone service and support team. Damage due to servicing that is not authorized by Dell is not covered by your warranty. Read and follow the safety instructions that came with the product.

1. Follow the safety guidelines listed in the Safety instructions section.
2. Follow the procedure listed in the Before working inside your system section.
3. Keep the #2 Phillips screwdriver ready.
4. Remove the IDSDM card.



CAUTION: To prevent damage to the IDSDM card, hold the card only by its edges.



NOTE: You must remove the IDSDM card to replace a faulty IDSDM card or service other components inside the system.

Steps

1. Align the following:
 - The slot on the card edge with the projection tabs on the PCIe mezzanine card support.
 - The two screw holes on the IDSDM card with the standoffs on the system board.
 - The hole on the SD card slot bracket with the screw hole on the IDSDM card.
2. Install the two screws to secure the SD card slot bracket and IDSDM card to the system board.

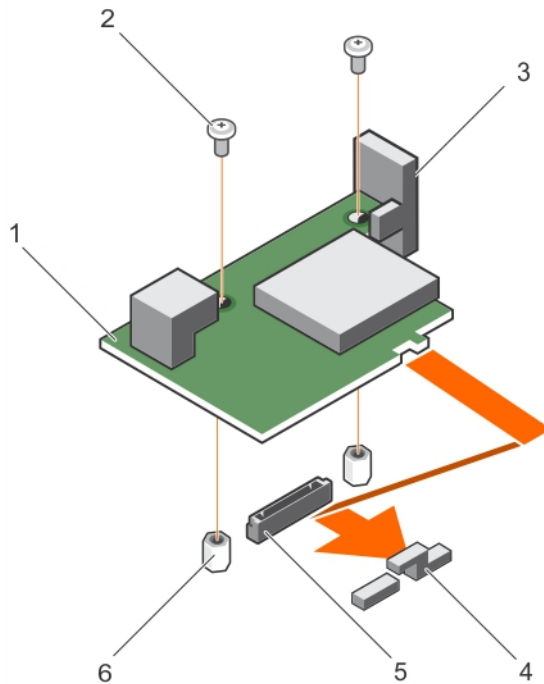

Figure 31. Installing the IDSDM card

- | | |
|-------------------------|--|
| 1. IDSDM card | 2. screw (2) |
| 3. SD card slot bracket | 4. PCIe mezzanine card support bracket |
| 5. connector | 6. standoff (2) |

Next steps

1. If applicable, install the SD card(s) and the internal USB key.
2. Follow the procedure listed in the After working inside your system section.

Related Links

- [Safety instructions](#)
- [Before working inside your system](#)
- [Replacing the optional internal USB memory key](#)
- [Replacing an SD card](#)
- [After working inside your system](#)

rSPI card (optional)

rSPI (restore Serial Peripheral Interface) is a SPI flash device to store information about the system Service Tag, system configuration, or iDRAC license.

Removing the optional rSPI card

Prerequisites

CAUTION: Many repairs may only be done by a certified service technician. You should only perform troubleshooting and simple repairs as authorized in your product documentation, or as directed by the online or telephone service and support team. Damage due to servicing that is not authorized by Dell is not covered by your warranty. Read and follow the safety instructions that came with the product.

NOTE: You must remove the rSPI card to replace a faulty rSPI card or service other components inside the system.

1. Follow the safety guidelines listed in the Safety instructions section.
2. Follow the procedure listed in the Before working inside your system section.
3. Keep the #2 Phillips screwdriver ready.

Steps

1. Remove the two screws securing the rSPI card to the system board.

CAUTION: To prevent damage to the rSPI card, hold the card only by its edges.

2. Lift the card away from the system.

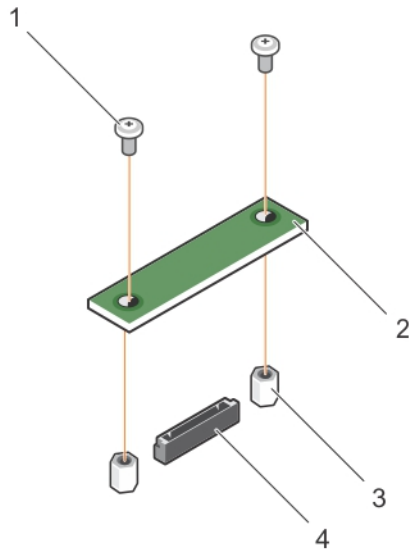

Figure 32. Removing the rSPI card

- | | |
|-----------------|--------------|
| 1. screw (2) | 2. rSPI card |
| 3. standoff (2) | 4. connector |

Next steps

1. Install the rSPI card.

Related Links

- [Safety instructions](#)
- [Before working inside your system](#)
- [Installing the optional rSPI card](#)
- [After working inside your system](#)

Installing the optional rSPI card

Prerequisites

⚠ CAUTION: Many repairs may only be done by a certified service technician. You should only perform troubleshooting and simple repairs as authorized in your product documentation, or as directed by the online or telephone service and support team. Damage due to servicing that is not authorized by Dell is not covered by your warranty. Read and follow the safety instructions that came with the product.

1. Follow the safety guidelines listed in the Safety instructions section.
2. Follow the procedure listed in the Before working inside your system section.
3. Keep the #2 Phillips screwdriver ready.
4. Remove the rSPI card.

⚠ CAUTION: To prevent damage to the rSPI card, hold the card only by its edges.

🔧 NOTE: You must remove the rSPI card to replace a faulty rSPI card or service other components inside the system.

Steps

1. Align the two screw holes on the rSPI card with the standoffs on the system board.
2. Install the two screws to secure the rSPI card to the system board.

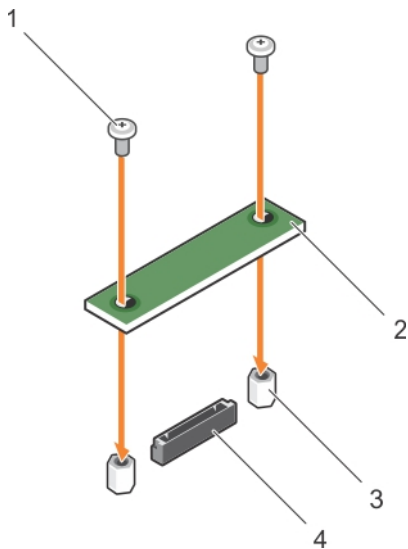

Figure 33. Installing the rSPI card

- | | |
|-----------------|--------------|
| 1. screw (2) | 2. rSPI card |
| 3. standoff (2) | 4. connector |

Next steps

Follow the procedure listed in the After working inside your system section.

Related Links

[Safety instructions](#)

[Before working inside your system](#)

[Removing the optional rSPI card](#)

[After working inside your system](#)

SD vFlash card

A vFlash SD card is a Secure Digital (SD) card that plugs into the vFlash SD card slot in the system. It provides persistent on-demand local storage and a custom deployment environment that allows automation of server configuration, scripts, and imaging. It emulates USB devices. For more information, see the *Integrated Dell Remote Access Controller User's Guide* at Dell.com/idracmanuals.

You can use an SD vFlash card with your system. The card slot is on the IDSDM card. You can remove and install the SD vFlash card.

Replacing the SD vFlash card

Prerequisites



CAUTION: Many repairs may only be done by a certified service technician. You should only perform troubleshooting and simple repairs as authorized in your product documentation, or as directed by the online or telephone service and support team. Damage due to servicing that is not authorized by Dell is not covered by your warranty. Read and follow the safety instructions that came with the product.

1. Follow the safety guidelines listed in the Safety instructions section.
2. Follow the procedure listed in the Before working inside your system section.

Steps

1. If installed, remove the SD vFlash card from the card slot.



NOTE: The SD vFlash card slot is below the NDC.

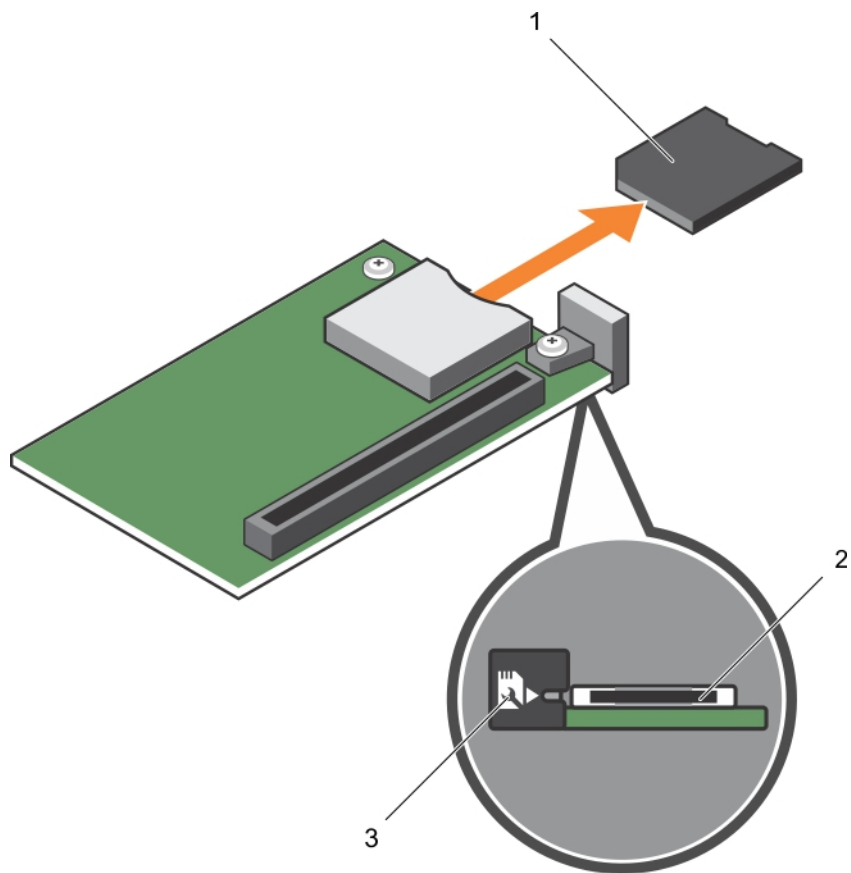

Figure 34. Removing the SD vFlash card

1. SD vFlash card
 2. SD vFlash card slot
 3. SD vFlash card slot identification label
2. Insert the contact-pin end of the SD card into the card slot on the vFlash media unit.
NOTE: The slot is keyed to ensure correct insertion of the card.
 3. Press inward on the card to lock it into the slot.

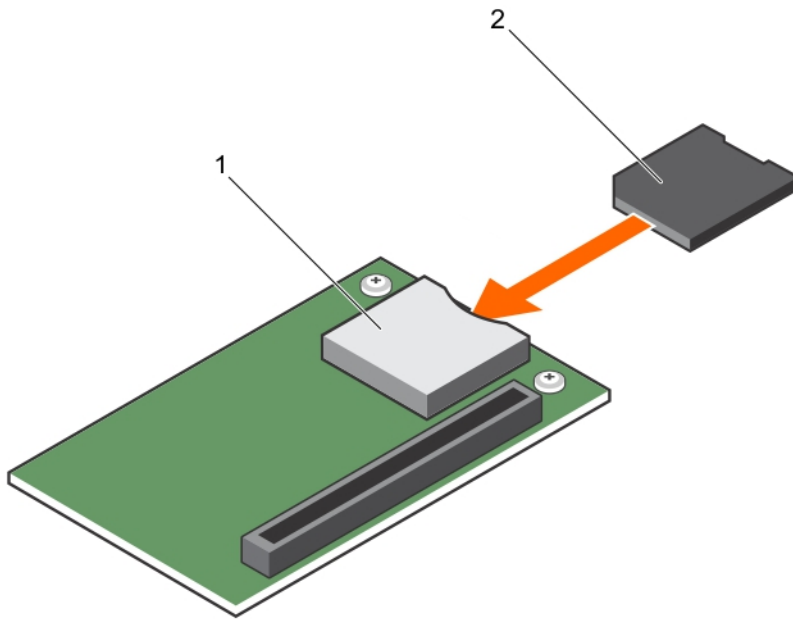

Figure 35. Installing the SD vFlash card

1. SD vFlash card

2. SD vFlash card slot

Next steps

Follow the procedure listed in the After working inside your system section.

Related Links

[Safety instructions](#)

[Before working inside your system](#)

[After working inside your system](#)

Network daughter card

The Network daughter card (NDC) is a small, removable mezzanine card. The NDC provides you with the flexibility of choosing different network connectivity options, for example—4 x 1GbE, 2 x 10GbE and 2 x Converged Network Adapter.

Removing the NDC

Prerequisites

⚠ CAUTION: Many repairs may only be done by a certified service technician. You should only perform troubleshooting and simple repairs as authorized in your product documentation, or as directed by the online or telephone service and support team. Damage due to servicing that is not authorized by Dell is not covered by your warranty. Read and follow the safety instructions that came with the product.

✍ NOTE: You must remove the NDC to replace a faulty NDC or service other components inside the system.

1. Follow the safety guidelines listed in the Safety instructions section.
2. Follow the procedure listed in the Before working inside your system section.

3. Keep the #2 Phillips screwdriver ready.
4. Remove the PCIe mezzanine card.

Steps

1. Remove the two screws that secure the Network Daughter Card (NDC) to the system board.

⚠ CAUTION: To prevent damage to the NDC, hold the card only by its edges.

2. Lift the card away from the system.

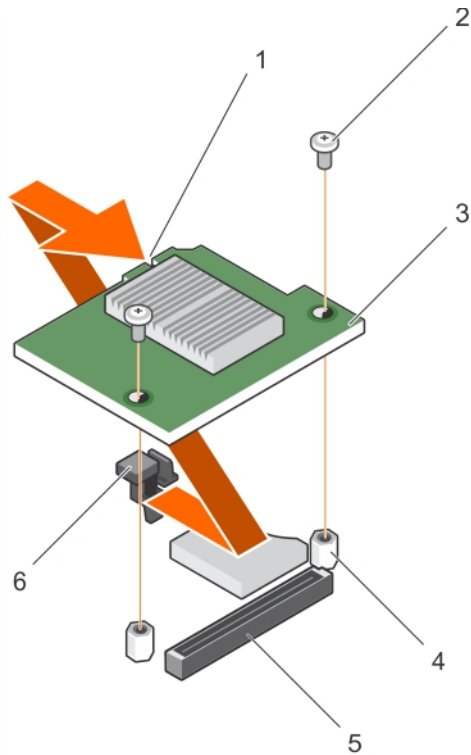

Figure 36. Removing the NDC

- | | |
|--------------------|--------------------|
| 1. slot on the NDC | 2. screw (2) |
| 3. NDC | 4. standoff (2) |
| 5. connector | 6. tab projections |

Next steps

1. Install the NDC.
2. Follow the procedure listed in the After working inside your system section.

Related Links

- [Safety instructions](#)
- [Before working inside your system](#)
- [Removing a PCIe mezzanine card](#)
- [Installing the NDC](#)
- [After working inside your system](#)

Installing the NDC

Prerequisites

 **CAUTION:** Many repairs may only be done by a certified service technician. You should only perform troubleshooting and simple repairs as authorized in your product documentation, or as directed by the online or telephone service and support team. Damage due to servicing that is not authorized by Dell is not covered by your warranty. Read and follow the safety instructions that came with the product.

1. Follow the safety guidelines listed in the Safety instructions section.
2. Follow the procedure listed in the Before working inside your system section.
3. Keep the #2 Phillips screwdriver ready.
4. Remove the NDC.

 **CAUTION:** To prevent damage to the NDC, hold the card only by its edges.

 **NOTE:** You must remove the NDC to replace a faulty NDC or service other components inside the system.

Steps

1. Align the following:
 - a. The slots on the card edge with the projection tabs on the plastic bracket covering the PCIe mezzanine card slots.
 - b. Screw holes on the card with the standoffs on the system board.
2. Lower the card into place until the card connector fits into the corresponding connector on the system board.
3. Secure the card with the two screws.

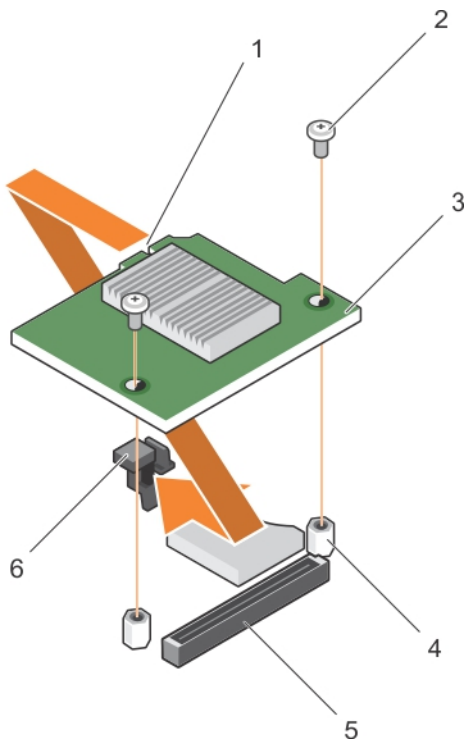

Figure 37. Installing the NDC

- | | |
|--------------------|--------------------|
| 1. slot on the NDC | 2. screw (2) |
| 3. NDC | 4. standoff (2) |
| 5. connector | 6. tab projections |

Next steps

1. Install the PCIe mezzanine card.
2. Follow the procedure listed in the After working inside your system section.

Related Links

- [Safety instructions](#)
- [Before working inside your system](#)
- [Removing the NDC](#)
- [After working inside your system](#)

Hard drives or SSDs

Your system supports up to eight 2.5-inch SAS/SATA/PCIe SSDs or SAS/SATA hard drives and sixteen 1.8-inch SAS SSDs. The hard drives or SSDs are supplied in special hot-swappable drive carriers that fit in the drive bays and these drives connect to the system board through the hard-drive or SSD backplane board.

 **NOTE:** Mixing of SSD/SAS/SATA hard drives is not supported.

Hard-drive or SSD bay numbering

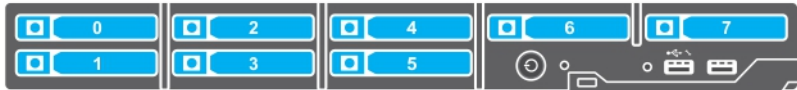

Figure 38. Hard-drive or SSD bay numbering—2.5-inch hard drive or SSD system

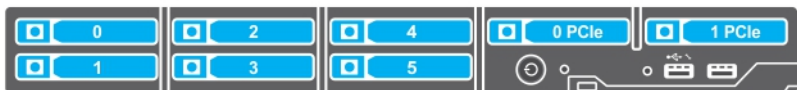

Figure 39. Hard drive or SSD and PCIe SSD bay numbering—2.5-inch hard drive or SSD and PCIe SSD system



Figure 40. SSD bay numbering—1.8-inch SSD system

Related Links

[Safety instructions](#)

[Before working inside your system](#)

[After working inside your system](#)

Hard drive or SSD installation guidelines

For single hard drive configuration, a hard-drive blank must be installed in the other drive bay to maintain proper cooling airflow.

Removing a hard drive or SSD

Prerequisites

⚠ CAUTION: Many repairs may only be done by a certified service technician. You should only perform troubleshooting and simple repairs as authorized in your product documentation, or as directed by the online or telephone service and support team. Damage due to servicing that is not authorized by Dell is not covered by your warranty. Read and follow the safety instructions that came with the product.

1. Follow the safety guidelines listed in the Safety instructions section.
2. Follow the procedure listed in the Before working inside your system section. Follow the procedure listed in the Before working inside your system section.
3. Take the hard drive or SSD offline and wait until the hard drive or SSD indicator codes on the drive carrier stop blinking.

When all indicators stop blinking, the drive is ready for removal. See your operating system documentation for more information about taking the hard drive or SSD offline.

🔧 NOTE: All operating systems do not support hot-swappable drive installation. See the documentation supplied with your operating system.

Steps

1. Press the release button to open the hard drive or SSD carrier handle.
2. Slide the hard drive or SSD carrier out until it is free of the hard drive or SSD slot.
3. Slide the hard drive or SSD out until it is free of the hard drive or SSD bay.

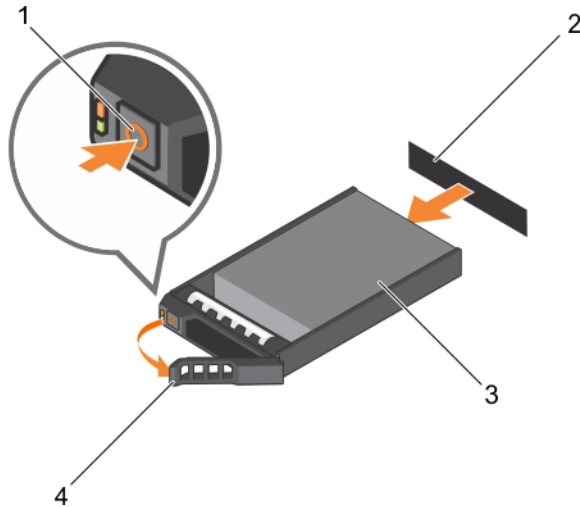

Figure 41. Removing a hard drive

- | | |
|----------------------|---|
| 1. release button | 2. hard drive or SSD connector (on backplane) |
| 3. hard drive or SSD | 4. hard drive or SSD carrier handle |

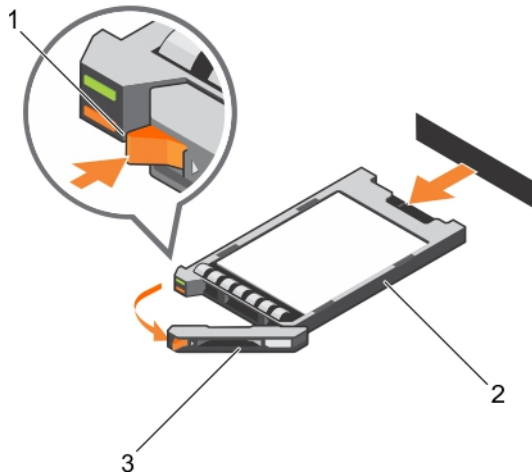

Figure 42. Removing a SSD

- | | | | |
|----|--------------------|----|-----|
| 1. | release button | 2. | SSD |
| 3. | SSD carrier handle | | |

Next steps



1. If you are removing a hard drive or SSD permanently, install the hard drive or SSD blank. If you are installing a new hard drive or SSD, see the Installing the hard drive or SSD section.
2. Follow the procedure listed in the After working inside your system section.

Related Links

- [Safety instructions](#)
- [Before working inside your system](#)
- [Installing a hard drive or SSD](#)
- [After working inside your system](#)

Installing a hard drive or SSD

Prerequisites

-  **CAUTION:** When a replacement hot-swappable hard drive or SSD is installed and the sled is turned on, the hard drive or SSD automatically begins to rebuild. Make absolutely sure that the replacement hard drive or SSD is blank or contains data that you wish to have over-written. Any data on the replacement hard drive or SSD is immediately lost after the hard drive or SSD is installed.
 -  **NOTE:** You must remove a hard drive or SSD to upgrade a hard drive or SSD or replace a faulty hard drive or SSD.
1. Follow the safety guidelines listed in the Safety instructions section.
 2. Follow the procedure listed in the Before working inside your system section.
 3. Remove the hard drive or SSD or hard drive or SSD blank.
-  **NOTE:** All operating systems do not support hot-swappable drive installation. See the documentation supplied with your operating system.

Steps

1. Press the release button to open the hard drive or SSD carrier handle.
2. Slide the hard drive or SSD carrier into the drive bay. Carefully align the channel on the hard drive or SSD carrier with the appropriate drive slot on the sled.
3. Push the drive carrier into the slot until the handle makes contact with the sled.
4. Rotate the carrier handle to the closed position while pushing the carrier into the slot until it locks into place.

The status LED indicator displays a steady green light if the drive is installed correctly. The drive carrier LED green indicator flashes as the drive rebuilds.

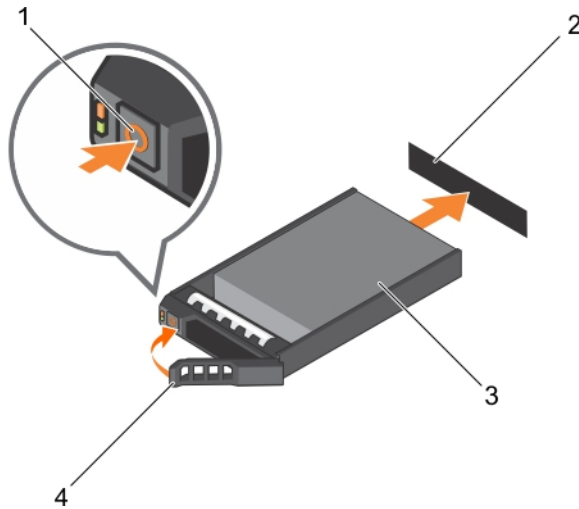

Figure 43. Installing a hard drive

- | | |
|-------------------|------------------------------|
| 1. release button | 2. hard drive(on backplane) |
| 3. hard drive | 4. hard drive carrier handle |

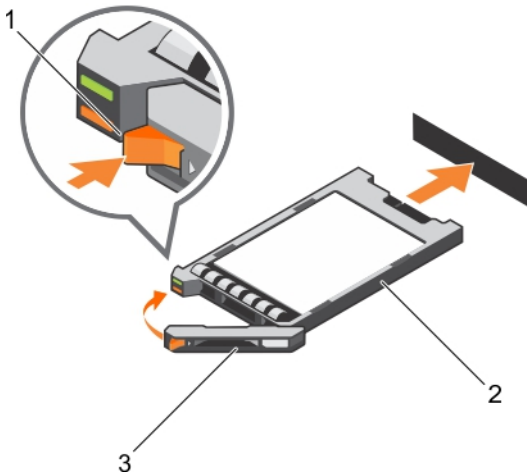

Figure 44. Installing an SSD

- | | |
|-----------------------|--------|
| 1. release button | 2. SSD |
| 3. SSD carrier handle | |

Next steps

Follow the procedure listed in the After working inside your system section.

Related Links

[Safety instructions](#)

[Before working inside your system](#)

[Removing a hard drive or SSD](#)

[After working inside your system](#)

Removing a hard drive or SSD blank

Prerequisites

△ **CAUTION:** Many repairs may only be done by a certified service technician. You should only perform troubleshooting and simple repairs as authorized in your product documentation, or as directed by the online or telephone service and support team. Damage due to servicing that is not authorized by Dell is not covered by your warranty. Read and follow the safety instructions that came with the product.

△ **CAUTION:** To maintain proper system cooling, all empty hard drive or SSD slots must have hard drive or SSD blanks installed.

1. Follow the safety guidelines listed in the Safety instructions section.
2. Follow the procedure listed in the Before working inside your system section.

Steps

Press the release latch and slide the hard-drive or SSD blank out of the hard drive or SSD slot.

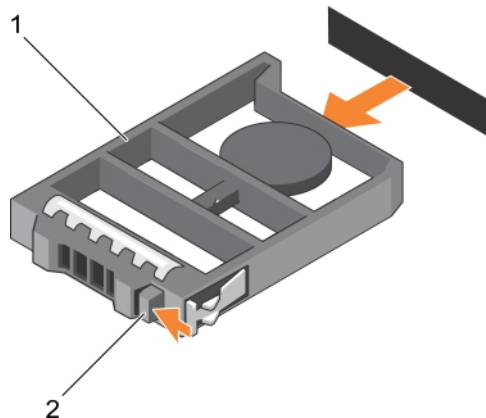

Figure 45. Removing a 2.5-inch hard-drive blank

1. hard drive or SSD blank
2. release latch

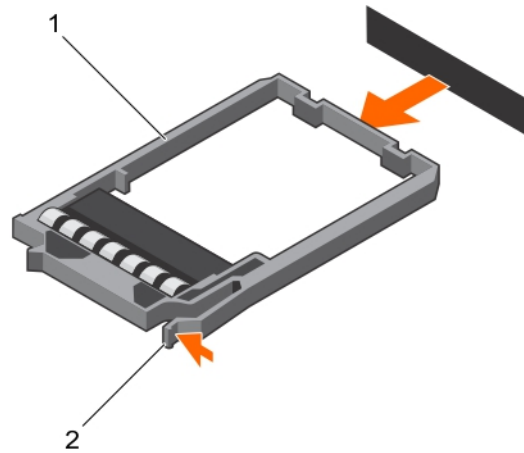

Figure 46. Removing a 1.8-inch SSD blank

1. SSD blank
2. release latch

Next steps

1. Install the hard drive or SSD.
2. Follow the procedure listed in the After working inside your system section.

Related Links

- [Safety instructions](#)
- [Before working inside your system](#)
- [Installing a hard drive or SSD blank](#)
- [After working inside your system](#)

Installing a hard drive or SSD blank

Prerequisites

1. Follow the safety guidelines listed in the Safety instructions section.
2. Follow the procedure listed in the Before working inside your system section.
3. Remove a hard drive or SSD.

Steps

Insert the hard-drive or SSD blank into the hard drive or SSD slot until the release latch clicks into place.

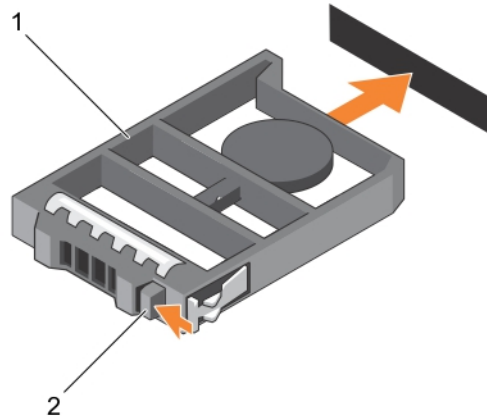

Figure 47. Installing a 2.5-inch hard-drive blank

1. hard drive or SSD blank
2. release latch

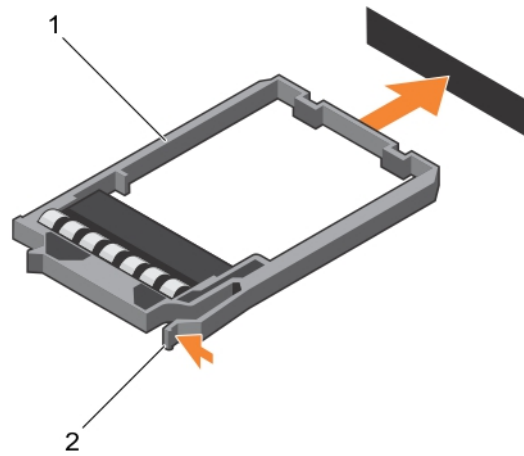

Figure 48. Installing a 1.8-inch SSD blank

1. SSD blank
2. release latch

Next steps

Follow the procedure listed in the After working inside your system section.

Related Links

[Safety instructions](#)

[Before working inside your system](#)

[Removing a hard drive or SSD blank](#)

[After working inside your system](#)

Shutdown procedure for servicing a hard drive or SSD

 **NOTE:** This section applies only to situations where the sled must be powered down to service a hard drive or SSD.

If you need to service a hard drive or SSD, turn off the sled and before removing the hard drive or SSD wait for 30 seconds after the sled indicator turns off. Otherwise, the hard drive or SSD may not be recognized after it is reinstalled and the sled is turned on again.

Configuring the boot drive

The drive or device from which the system boots is determined by the boot order specified in the System Setup.

Removing a 2.5-inch hard drive or SSD from a 2.5-inch hard drive or SSD carrier

Prerequisites

 **CAUTION:** Many repairs may only be done by a certified service technician. You should only perform troubleshooting and simple repairs as authorized in your product documentation, or as directed by the online or telephone service and support team. Damage due to servicing that is not authorized by Dell is not covered by your warranty. Read and follow the safety instructions that came with the product.

1. Follow the safety guidelines listed in the Safety instructions section.
2. Follow the procedure listed in the Before working inside your system section.
3. Keep the Phillips #1 screwdriver ready.

Steps

1. Remove the four screws from the slide rails on the hard drive or SSD carrier.
2. Slide the hard drive or SSD out of the hard drive or SSD carrier.

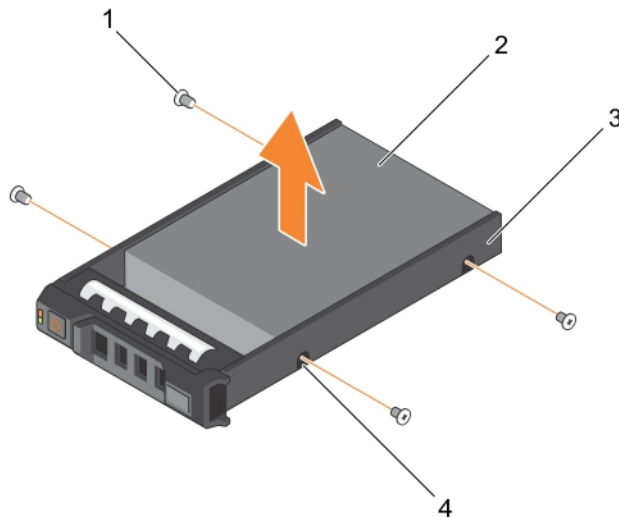

Figure 49. Removing a 2.5-inch hard drive or SSD in a 2.5-inch hard-drive or SSD carrier

- | | |
|------------------------------|----------------------|
| 1. screw (4) | 2. hard drive or SSD |
| 3. hard-drive or SSD carrier | 4. screw hole (4) |

Next steps

- Install a new 2.5-inch hard drive or SSD in a 2.5-inch hard-drive or SSD carrier.
- Follow the procedure listed in the After working inside your system section.

Related Links

[Safety instructions](#)

[Before working inside your system](#)

[Installing a 2.5-inch hard drive or SSD in a 2.5-inch hard-drive or SSD carrier](#)

[After working inside your system](#)

Installing a 2.5-inch hard drive or SSD in a 2.5-inch hard-drive or SSD carrier

Prerequisites

⚠ CAUTION: Many repairs may only be done by a certified service technician. You should only perform troubleshooting and simple repairs as authorized in your product documentation, or as directed by the online or telephone service and support team. Damage due to servicing that is not authorized by Dell is not covered by your warranty. Read and follow the safety instructions that came with the product.

🔧 NOTE: You must remove the hard drive or SSD from a hard-drive or SSD carrier to replace a faulty hard drive or SSD from a hard-drive or SSD carrier.

1. Follow the safety guidelines listed in safety instructions section.
2. Keep the Phillips #1 screwdriver ready.
3. Remove the 2.5-inch hard drive or SSD from the 2.5-inch hard drive or SSD carrier.

Steps

1. Slide the hard drive or SSD into the hard drive or SSD carrier.
2. Align the screw holes on the hard drive or SSD with the holes on the hard drive or SSD carrier.

⚠ CAUTION: To avoid damaging the drive or the carrier, do not overtighten the screws.

3. Fasten the four screws to secure the hard drive or SSD to the hard-drive or SSD carrier.

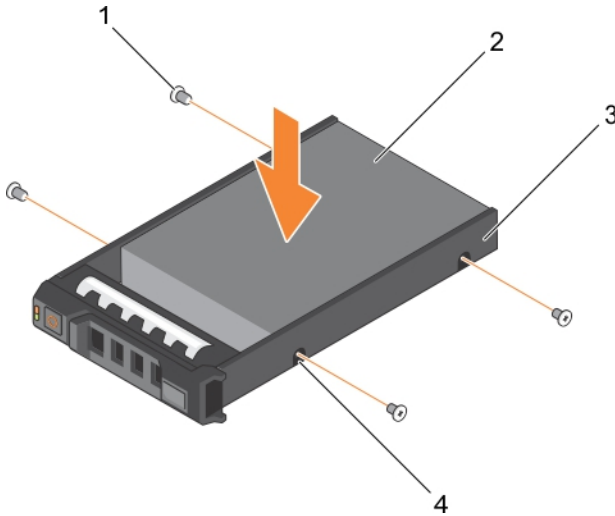

Figure 50. Installing a 2.5-inch hard drive or SSD in a 2.5-inch hard-drive or SSD carrier

- | | |
|------------------------------|----------------------|
| 1. screw (4) | 2. hard drive or SSD |
| 3. hard drive or SSD carrier | 4. screw hole (4) |

Next steps

Follow the procedure listed in the After working inside your system section.

Related Links

[Safety instructions](#)

[Before working inside your system](#)

[Removing a 2.5-inch hard drive or SSD from a 2.5-inch hard drive or SSD carrier](#)

[After working inside your system](#)

Removing a 1.8-inch SSD from a 1.8-inch SSD carrier

Prerequisites

⚠ CAUTION: Many repairs may only be done by a certified service technician. You should only perform troubleshooting and simple repairs as authorized in your product documentation, or as directed by the online or telephone service and support team. Damage due to servicing that is not authorized by Dell is not covered by your warranty. Read and follow the safety instructions that came with the product.

1. Follow the safety guidelines listed in the Safety instructions section.
2. Follow the procedure listed in the Before working inside your system section.

Steps

Pull the rails on the side of the carrier and lift the SSD out of the carrier.

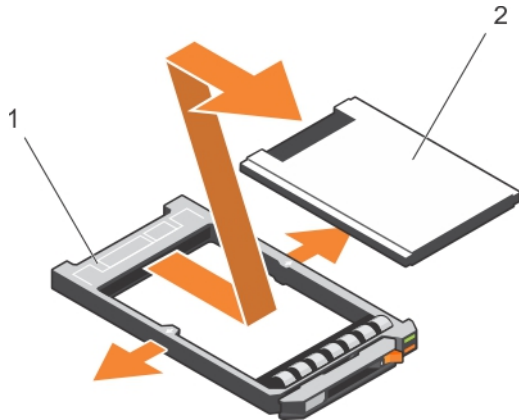

Figure 51. Removing a 1.8-inch SSD in a 1.8-inch SSD carrier

1. SSD carrier
2. SSD

Next steps

1. Install a 1.8-inch SSD in a 1.8-inch SSD carrier.
2. Follow the procedure listed in the After working inside your system section.

Related Links

- [Safety instructions](#)
- [Before working inside your system](#)
- [Installing a 1.8-inch SSD in a 1.8-inch SSD carrier](#)
- [After working inside your system](#)

Installing a 1.8-inch SSD in a 1.8-inch SSD carrier

Prerequisites



CAUTION: Many repairs may only be done by a certified service technician. You should only perform troubleshooting and simple repairs as authorized in your product documentation, or as directed by the online or telephone service and support team. Damage due to servicing that is not authorized by Dell is not covered by your warranty. Read and follow the safety instructions that came with the product.



NOTE: You must remove the SSD from a SSD carrier to replace a faulty SSD from a SSD carrier.

1. Follow the safety guidelines listed in the Safety instructions section.
2. Follow the procedure listed in the Before working inside your system section.
3. Remove a 1.8-inch SSD from a 1.8-inch SSD carrier.

Steps

Insert the SSD into the SSD carrier with the connector end of the SSD toward the back. When aligned correctly, the back of the SSD is flush with the back of the SSD carrier.

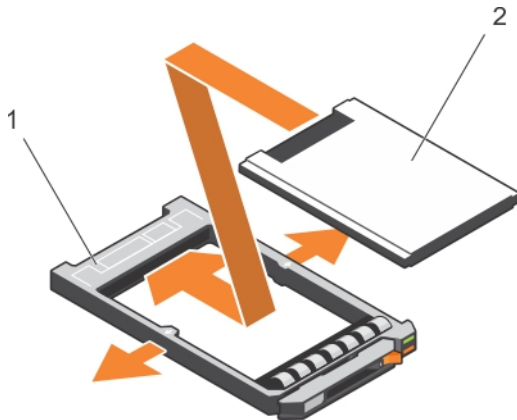

Figure 52. Installing a 1.8-inch SSD in a 1.8-inch SSD carrier

1. SSD carrier

2. SSD

Next steps

Follow the procedure listed in the After working inside your system section.

Related Links

[Safety instructions](#)

[Before working inside your system](#)

[Removing a 1.8-inch SSD from a 1.8-inch SSD carrier](#)

[After working inside your system](#)

Hard-drive or SSD cage

Removing the hard-drive or SSD cage

Prerequisites

CAUTION: Many repairs may only be done by a certified service technician. You should only perform troubleshooting and simple repairs as authorized in your product documentation, or as directed by the online or telephone service and support team. Damage due to servicing that is not authorized by Dell is not covered by your warranty. Read and follow the safety instructions that came with the product.

NOTE: You must remove the hard-drive or SSD cage to replace a faulty hard-drive or SSD cage or service other components inside the system.

1. Follow the safety guidelines listed in the Safety instructions section.
2. Follow the procedure listed in the Before working inside your system section.
3. Keep the #1 Phillips screwdriver ready.
4. Remove the hard drives or SSDs.
5. Remove the hard-drive or SSD backplane.

Steps

1. Remove the two screws securing the hard-drive or SSD cage to the chassis.
2. Holding the hard-drive or SSD cage by its edges, slide it toward the front of the system and lift it away from the system.

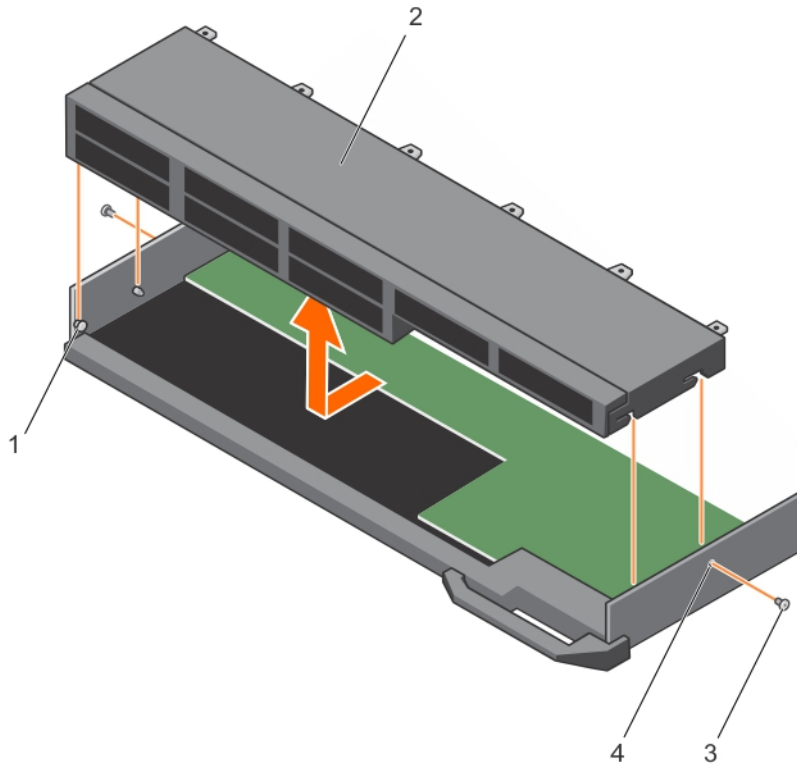

Figure 53. Removing the hard-drive or SSD cage

- | | |
|-----------------|------------------------|
| 1. standoff (4) | 2. hard drive/SSD cage |
| 3. screw (2) | 4. screw hole (2) |

Next steps

1. Install the hard-drive or SSD cage.
2. Follow the procedure listed in the After working inside your system section.

Related Links

- [Safety instructions](#)
- [Before working inside your system](#)
- [Installing the hard-drive or SSD cage](#)
- [After working inside your system](#)

Installing the hard-drive or SSD cage

Prerequisites

⚠ CAUTION: Many repairs may only be done by a certified service technician. You should only perform troubleshooting and simple repairs as authorized in your product documentation, or as directed by the online or telephone service and support team. Damage due to servicing that is not authorized by Dell is not covered by your warranty. Read and follow the safety instructions that came with the product.

1. Follow the safety guidelines listed in the Safety instructions section.

2. Follow the procedure listed in the Before working inside your system section.
3. Keep the #1 Phillips screwdriver ready.
4. Remove the hard-drive or SSD cage.

 **NOTE:** You must remove the hard-drive or SSD cage to replace a faulty hard-drive or SSD cage or service other components inside the system.

Steps

1. Align the slots on the sides of the hard-drive or SSD cage with the standoffs on the chassis.
2. Lower the hard-drive or SSD cage into the chassis until the slots on the hard-drive or SSD cage engage with the standoffs on the chassis.
3. Slide the hard-drive or SSD cage into the chassis until it clicks into position.
4. Install the two screws to secure the hard-drive or SSD cage to the chassis.

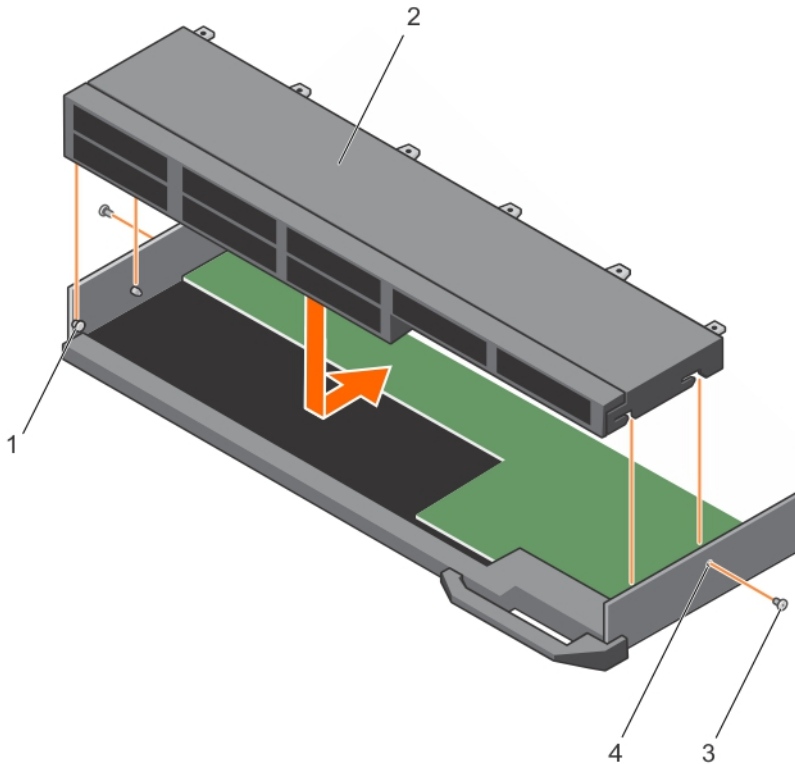

Figure 54. Installing the hard-drive or SSD cage

- | | |
|-----------------|---------------------------|
| 1. standoff (4) | 2. hard-drive or SSD cage |
| 3. screw (2) | 4. screw hole (2) |

Next steps

1. Install the hard-drive or SSD backplane.
2. Install the harddrive or SSD.
3. Follow the procedure listed in the After working inside your system section. Follow the procedure listed in the After working inside your system section.

Related Links

- [Safety instructions](#)
- [Before working inside your system](#)
- [Removing the hard-drive or SSD cage](#)
- [After working inside your system](#)

Hard drive or SSD backplane

 **NOTE:** All drives connect to the system board through the hard-drive or SSD backplane cable connector.

The following table provides information about connecting different backplane configurations to the respective connectors on the system board and expander card.

Table 25. Hard drive or SSD backplane configuration

Drive backplane configurations	Connectors	
	SATA_BP connector on the system board	J_PERC connector on the system board
2.5-inch (x8) SAS backplane	-	SAS backplane cable connector that connects eight hard drives or SSDs to the system board.
2.5-inch (x8) SATA backplane	SATA backplane cable connector that connects eight hard drives or SSDs to the system board.	-
2.5-inch (x6) SATA plus 2.5-inch (x2) PCIe backplane	SATA drive backplane cable connector that connects six hard drives or SSDs to the system board.	PCIe drive backplane cable connector that connects two PCIe SSDs to the system board.
1.8-inch (x16) SAS SSD backplane	SAS drive backplane cable connector that connects SSDs populated in bays 8–15 to the system board.	SAS backplane cable connector that connects SSDs populated in bays 0-7 to the system board through an expander card. For more information about installing an expander card, see the Expander card section.

 **NOTE:** Ensure that you install an expander card on the system board if you are using 1.8 inch (x16) SSD system. For information about the installation procedure, see the Expander card section.

 **NOTE:** For more information about hard-drive or SSD bay numbering, see the Hard-drive or SSD bay numbering.

 **NOTE:** To locate SATA_BP and J_PERC connectors on the system board, see the System board connectors section.

Removing a 2.5 inch (x8) SATA hard-drive or SSD backplane

Prerequisites

 **CAUTION:** Many repairs may only be done by a certified service technician. You should only perform troubleshooting and simple repairs as authorized in your product documentation, or as directed by the online or telephone service and support team. Damage due to servicing that is not authorized by Dell is not covered by your warranty. Read and follow the safety instructions that came with the product.

 **NOTE:** You must remove the hard-drive or SSD backplane to replace a faulty hard-drive or SSD backplane or service other components inside the system.

1. Follow the safety guidelines listed in the Safety instructions section.
2. Follow the procedure listed in the Before working inside your system section.
3. Keep the #2 Phillips screwdriver ready.

 **CAUTION:** To prevent damage to the hard drives or SSDs and the hard-drive or SSD backplane, you must remove the hard drives or SSDs from the sled before removing the hard-drive or SSD backplane.

 **CAUTION:** You must note the number of each hard drive or SSD and temporarily label them before removal so that you can replace them in the same locations.

4. Remove the hard drives or SSDs.

Steps

1. Disconnect the power cable from the hard-drive or SSD backplane.
2. Loosen the retention screws securing the hard-drive or SSD backplane to the hard-drive or SSD cage.
3. Lift the hard-drive or SSD backplane by its edges until the retention screws disengage from the screw holes on the hard-drive or SSD cage.
4. Remove the hard-drive or SSD cage.
5. Loosen the retention screws securing the hard-drive or SSD backplane cable connector to the system board connector.
6. Lift the backplane away from the system.

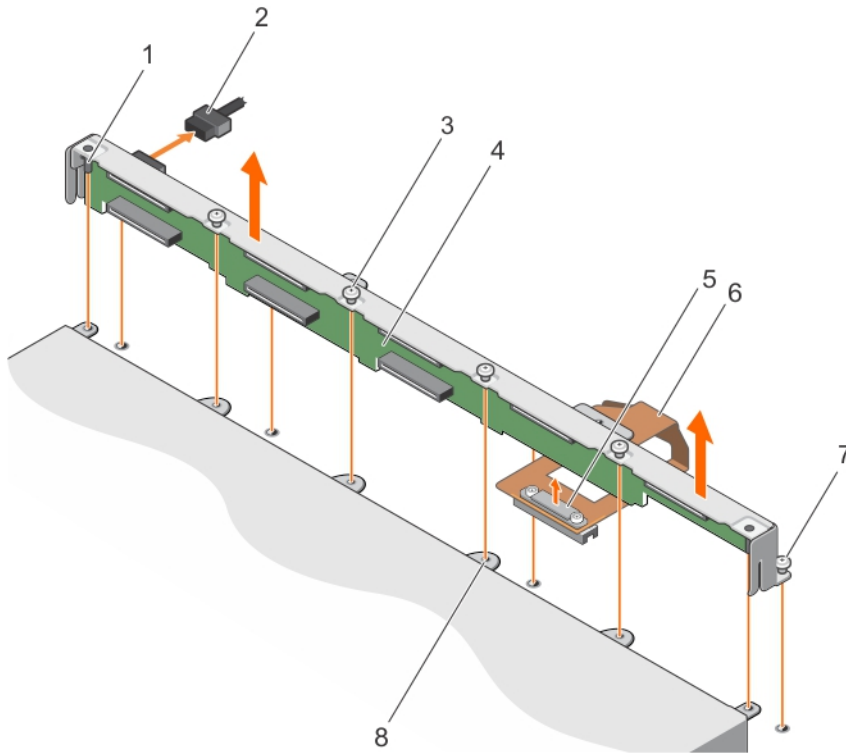

Figure 55. Removing a 2.5-inch (x8) SATA hard-drive or SSD backplane

- | | |
|---|--|
| 1. alignment pin (2) | 2. power cable |
| 3. retention screw on the top of the hard-drive or SSD backplane (4) | 4. hard-drive or SSD backplane |
| 5. hard-drive or SSD backplane cable connector | 6. hard-drive or SSD backplane cable |
| 7. retention screw on the bottom of the hard-drive or SSD backplane (4) | 8. screw holes on the hard-drive or SSD cage (6) |

Next steps

1. Install the hard-drive or SSD backplane.
2. Follow the procedure listed in the After working inside your system section.

Related Links

- [Safety instructions](#)
- [Before working inside your system](#)
- [Installing a 2.5-inch \(x8\) SATA hard-drive or SSD backplane](#)
- [After working inside your system](#)

Installing a 2.5-inch (x8) SATA hard-drive or SSD backplane

Prerequisites

 **CAUTION:** Many repairs may only be done by a certified service technician. You should only perform troubleshooting and simple repairs as authorized in your product documentation, or as directed by the online or telephone service and support team. Damage due to servicing that is not authorized by Dell is not covered by your warranty. Read and follow the safety instructions that came with the product.

1. Follow the safety guidelines listed in the Safety instructions section.
2. Follow the procedure listed in the Before working inside your system section.
3. Keep the #2 Phillips screwdriver ready.
4. Remove the hard-drive or SSD backplane.

 **NOTE:** You must remove the hard-drive or SSD backplane to replace a faulty hard-drive or SSD backplane or service other components inside the system.

Steps

1. Align the retention screws on the hard-drive or SSD backplane cable connector with the screw holes on the system board connector.
2. Tighten the two retention screws to secure the backplane cable connector on the system board.
3. Install the hard-drive or SSD cage.
4. Align the retention screws on the hard-drive or SSD backplane with the screw holes on the hard-drive or SSD cage.
5. Lower the hard-drive or SSD backplane into place until the retention screws on the hard-drive or SSD backplane engage with the screw holes on the hard-drive or SSD cage.
6. Tighten the retention screws to secure the hard-drive or SSD backplane on the system board.
7. Connect the power cable to the backplane.

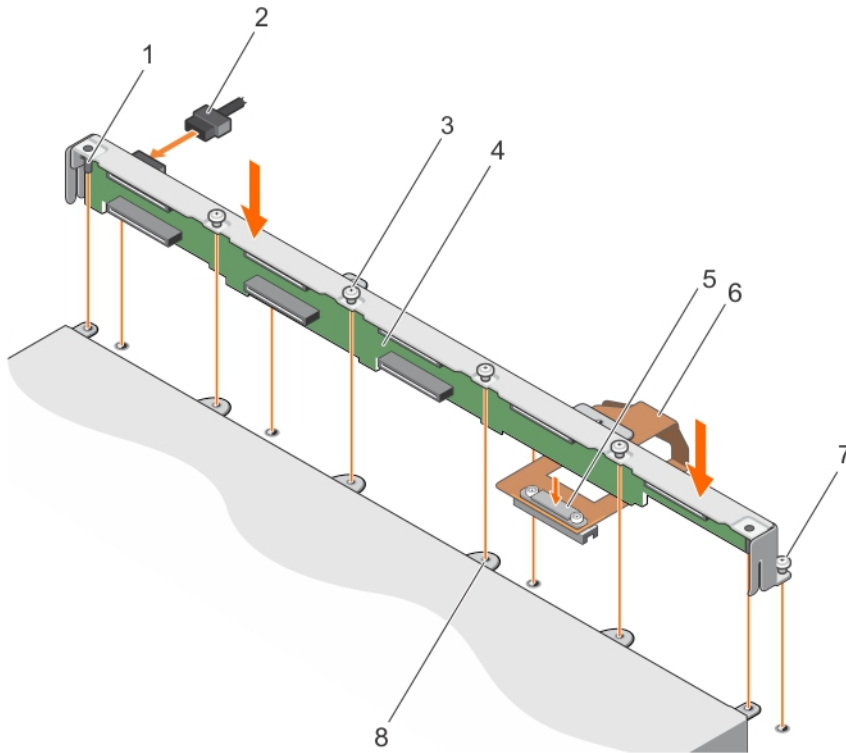

Figure 56. Installing a 2.5-inch (x8) SATA hard-drive or SSD backplane

- | | |
|---|--------------------------------------|
| 1. alignment pin (2) | 2. power cable |
| 3. retention screw on the top of the hard-drive or SSD backplane (4) | 4. hard-drive or SSD backplane |
| 5. hard-drive or SSD backplane cable connector | 6. hard-drive or SSD backplane cable |
| 7. retention screw on the bottom of the hard-drive or SSD backplane (4) | 8. screw holes |

Next steps

1. Install the hard drives or SSDs in their original locations.
2. Follow the procedure listed in the After working inside your system section.

Related Links

- [Safety instructions](#)
- [Before working inside your system](#)
- [Removing a 2.5 inch \(x8\) SATA hard-drive or SSD backplane](#)
- [After working inside your system](#)

Removing a 2.5-inch (x8) SAS hard-drive or SSD backplane

Prerequisites

 **CAUTION:** Many repairs may only be done by a certified service technician. You should only perform troubleshooting and simple repairs as authorized in your product documentation, or as directed by the online or telephone service and support team. Damage due to servicing that is not authorized by Dell is not covered by your warranty. Read and follow the safety instructions that came with the product.

 **NOTE:** You must remove the hard-drive or SSD backplane to replace a faulty hard-drive or SSD backplane or service other components inside the system.

1. Follow the safety guidelines listed in the Safety instructions section.
2. Follow the procedure listed in the Before working inside your system section.
3. Keep the #2 Phillips screwdriver ready.

 **CAUTION:** To prevent damage to the hard drives or SSDs and the hard-drive or SSD backplane, you must remove the hard drives or SSDs from the sled before removing the hard-drive or SSD backplane.

 **CAUTION:** You must note the number of each hard drive or SSD and temporarily label them before removal so that you can replace them in the same locations.

4. Remove the hard drives or SSDs.

Steps

1. Disconnect the power cable from the hard-drive or SSD backplane.
2. Loosen the retention screws securing hard-drive or SSD backplane to the hard-drive or SSD cage.
3. Lift the hard-drive or SSD backplane by its edges until the retention screws disengage from the screw holes on the hard-drive or SSD cage.
4. Remove the hard-drive or SSD cage.
5. Loosen the retention screws securing the hard-drive or SSD backplane cable connector to the system board connector.
6. Lift the hard-drive or SSD backplane away from the system.

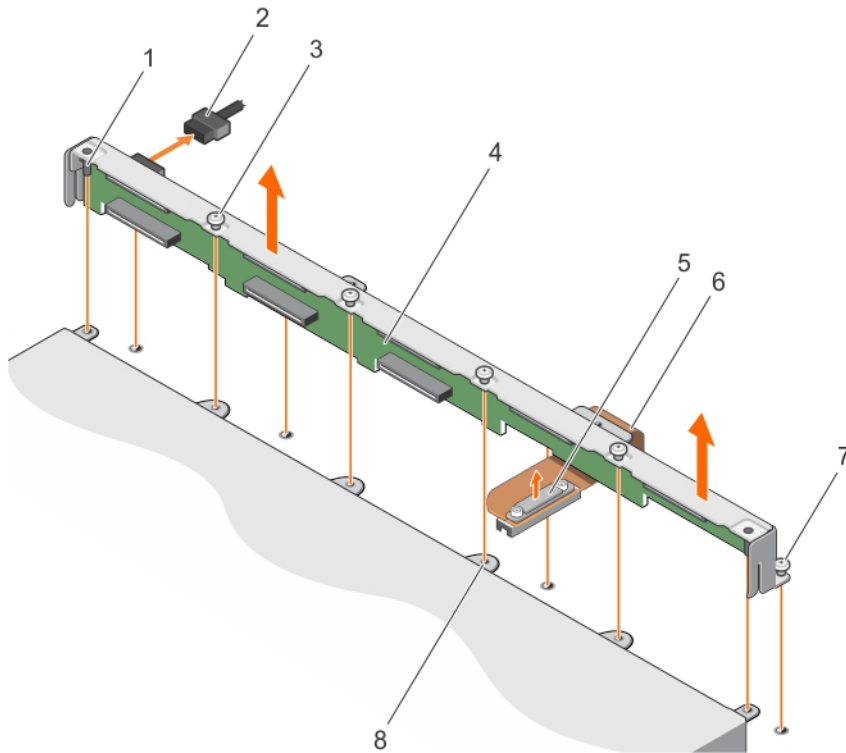

Figure 57. Removing a 2.5-inch (x8) SAS hard-drive or SSD backplane

- | | |
|---|--|
| 1. alignment pin (2) | 2. power cable |
| 3. retention screw on the top of the hard-drive or SSD backplane (4) | 4. hard-drive or SSD backplane |
| 5. hard-drive or SSD backplane cable connector | 6. hard-drive or SSD backplane cable |
| 7. retention screw on the bottom of the hard-drive or SSD backplane (4) | 8. screw holes on the hard-drive or SSD cage (6) |

Next steps

1. Install the hard-drive or SSD backplane.

Related Links

- [Safety instructions](#)
- [Before working inside your system](#)
- [Installing a 2.5-inch \(x8\) SAS hard-drive or SSD backplane](#)
- [After working inside your system](#)

Installing a 2.5-inch (x8) SAS hard-drive or SSD backplane

Prerequisites

 **CAUTION:** Many repairs may only be done by a certified service technician. You should only perform troubleshooting and simple repairs as authorized in your product documentation, or as directed by the online or telephone service and support team. Damage due to servicing that is not authorized by Dell is not covered by your warranty. Read and follow the safety instructions that came with the product.

1. Follow the safety guidelines listed in the Safety instructions section.
2. Follow the procedure listed in the Before working inside your system section.
3. Keep the #2 Phillips screwdriver ready.
4. Remove the hard-drive or SSD backplane.

 **NOTE:** You must remove the hard-drive or SSD backplane to replace a faulty hard-drive or SSD backplane or service other components inside the system.

Steps

1. Align the retention screws on the hard-drive or SSD backplane cable connector with the screw holes on the system board connector.
2. Tighten the two retention screws to secure the backplane cable connector on the system board.
3. Install the hard-drive or SSD cage.
4. Align the retention screws on the hard-drive or SSD backplane with the screw holes on the hard-drive or SSD cage.
5. Lower the hard-drive or SSD backplane into place until the retention screws on the hard-drive or SSD backplane engage with the screw holes on the hard-drive or SSD cage.
6. Tighten the retention screws to secure the hard-drive or SSD backplane on the system board.
7. Connect the power cable to the backplane.

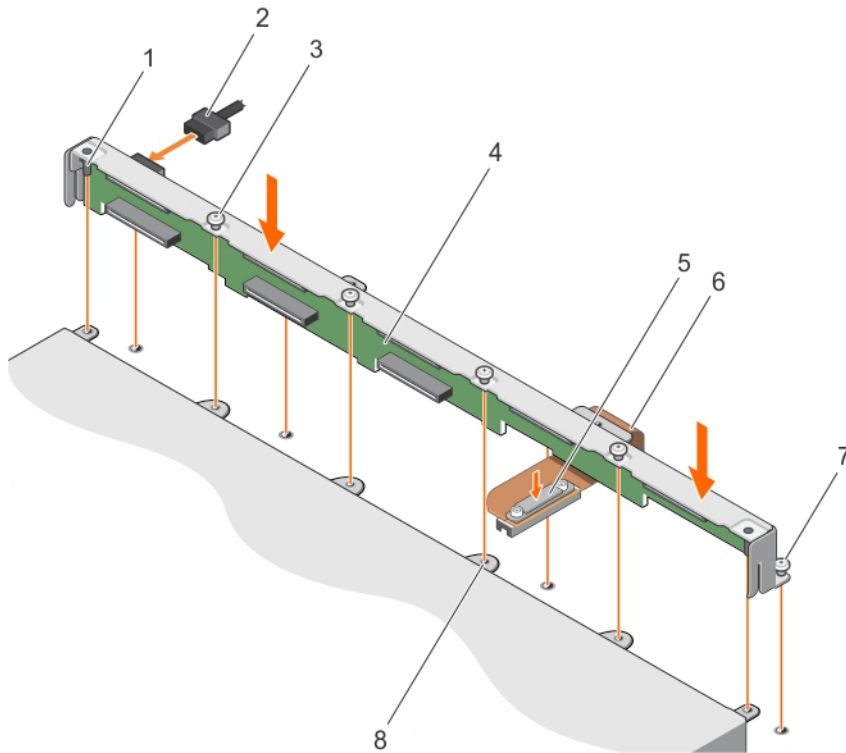

Figure 58. Installing a 2.5-inch (x8) SAS hard-drive or SSD backplane

- | | |
|---|--|
| 1. alignment pin (2) | 2. power cable |
| 3. retention screw on the top of the hard-drive or SSD backplane (4) | 4. hard-drive or SSD backplane |
| 5. hard-drive or SSD backplane cable connector | 6. hard-drive or SSD backplane cable |
| 7. retention screw on the bottom of the hard-drive or SSD backplane (4) | 8. screw holes on the hard-drive or SSD cage (6) |

Next steps

1. Install the hard drives or SSDs in their original locations.
2. Follow the procedure listed in the After working inside your system section.

Related Links

- [Safety instructions](#)
- [Before working inside your system](#)
- [Removing a 2.5-inch \(x8\) SAS hard-drive or SSD backplane](#)
- [After working inside your system](#)

Removing a 2.5-inch (x6) SATA hard drive or SSD and 2.5-inch (x2) PCIe SSD backplane

Prerequisites

 **CAUTION:** Many repairs may only be done by a certified service technician. You should only perform troubleshooting and simple repairs as authorized in your product documentation, or as directed by the online or telephone service and support team. Damage due to servicing that is not authorized by Dell is not covered by your warranty. Read and follow the safety instructions that came with the product.

 **NOTE:** You must remove the hard-drive or SSD backplane to replace a faulty hard-drive or SSD backplane or service other components inside the system.

1. Follow the safety guidelines listed in the Safety instructions section.
2. Follow the procedure listed in the Before working inside your system section.
3. Keep the #2 Phillips screwdriver ready.

 **CAUTION:** To prevent damage to the hard drives or SSDs and the hard-drive or SSD backplane, you must remove the hard drives or SSDs from the sled before removing the hard-drive or SSD backplane.

 **CAUTION:** You must note the number of each hard drive or SSD and temporarily label them before removal so that you can replace them in the same locations.

4. Remove the hard drives or SSDs.

Steps

1. Disconnect the power cable from the hard-drive or SSD backplane.
2. Loosen the retention screws securing hard-drive or SSD backplane to the hard-drive or SSD cage.
3. Lift the hard-drive or SSD backplane by its edges until the retention screws disengage from the screw holes on the hard-drive or SSD cage.
4. Remove the hard-drive or SSD cage.
5. Perform the following steps:
 - a. Loosen the two retention screws securing the PCIe SSD backplane cable connector to the system board connector (J_PERC).
 - b. Loosen the two retention screws securing the SATA hard-drive or SSD backplane cable connector to the system board connector (SATA_BP).
6. Open the retention clip securing the SATA hard-drive or SSD backplane cable.
7. Lift the SATA hard-drive or SSD backplane cable until the slot on the SATA hard-drive or SSD backplane cable disengages from the standoff on the chassis.
8. Lift the backplane away from the system.

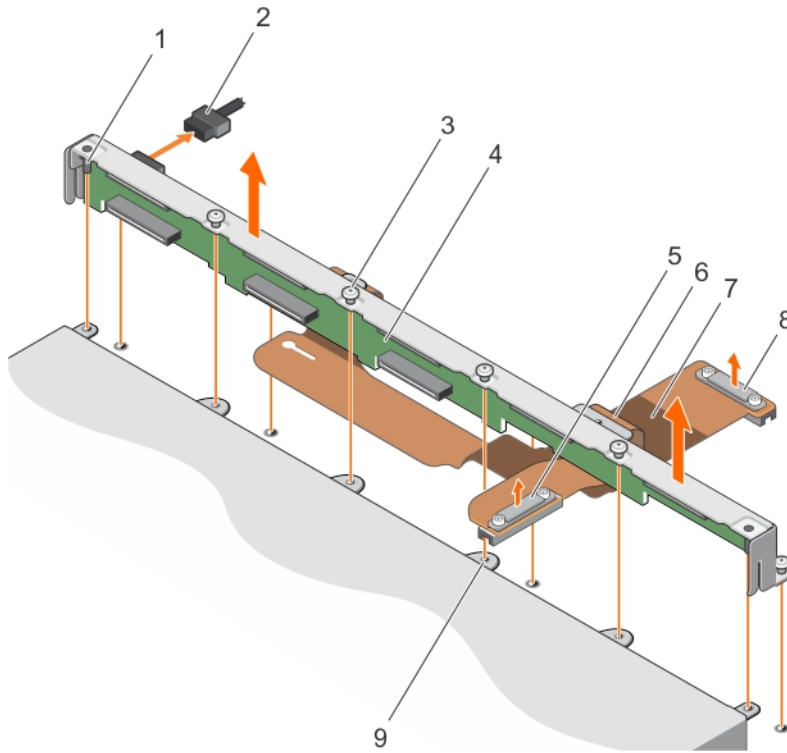

Figure 59. Removing a 2.5-inch (x6) SATA hard drive or SSD and 2.5-inch (x2) PCIe SSD backplane

- | | |
|---|---|
| 1. alignment pin (2) | 2. power cable |
| 3. retention screw (8) | 4. hard-drive or SSD backplane |
| 5. PCIe SSD backplane cable connector | 6. PCIe SSD backplane cable |
| 7. SATA hard-drive or SSD backplane cable | 8. SATA hard-drive or SSD backplane cable connector |
| 9. hard-drive or SSD cage | |

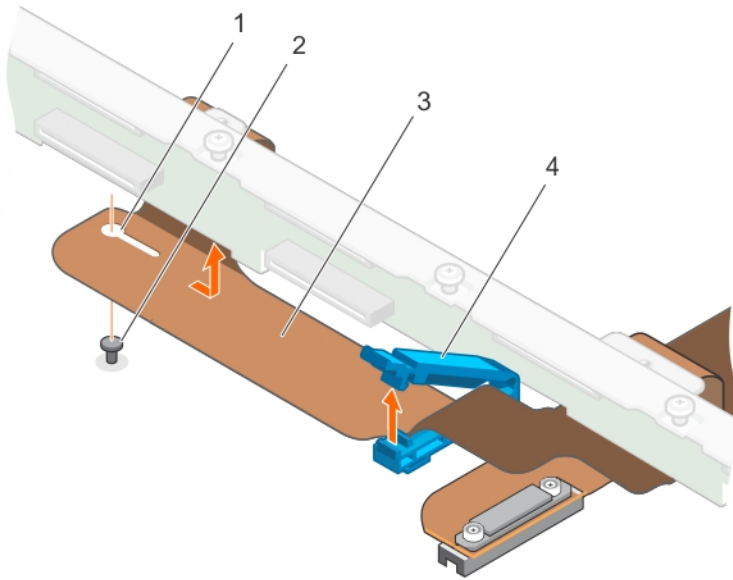

Figure 60. Removing a 2.5-inch (x6) SATA hard drive or SSD and 2.5-inch (x2) PCIe SSD backplane

- | | |
|---|----------------------------|
| 1. slot on the SATA hard-drive or SSD backplane cable | 2. standoff on the chassis |
| 3. SATA hard-drive or SSD backplane cable | 4. retention clip |

Next steps

1. Install the hard-drive or SSD backplane.
2. Follow the procedure listed in the After working inside your system section.

Related Links

[Safety instructions](#)

[Before working inside your system](#)

[Installing a 2.5-inch \(x6\) SATA hard drive or SSD and 2.5-inch \(x2\) PCIe SSD backplane](#)

[After working inside your system](#)

Installing a 2.5-inch (x6) SATA hard drive or SSD and 2.5-inch (x2) PCIe SSD backplane

Prerequisites

⚠ CAUTION: Many repairs may only be done by a certified service technician. You should only perform troubleshooting and simple repairs as authorized in your product documentation, or as directed by the online or telephone service and support team. Damage due to servicing that is not authorized by Dell is not covered by your warranty. Read and follow the safety instructions that came with the product.

1. Follow the safety guidelines listed in the Safety instructions section.
2. Follow the procedure listed in the Before working inside your system section.
3. Keep the #2 Phillips screwdriver ready.
4. Remove the hard-drive or SSD backplane.



NOTE: You must remove the hard-drive or SSD backplane to replace a faulty hard-drive or SSD backplane or service other components inside the system.

Steps

1. Align the retention screws on the SATA hard-drive or SSD backplane cable connector with the screw holes on the system board connector (SATA_BP).
2. Tighten the two retention screws to secure the hard-drive or SSD backplane cable connector on the system board.
3. Perform the following steps:
 - a. Route the SATA hard-drive or SSD backplane cable through the retention clip on the chassis and close the retention clip.
 - b. Lower the SATA hard-drive or SSD backplane cable into the chassis until the slot on the cable engages with the standoff on the chassis.
4. Align the retention screws on the PCIe SSD backplane cable connector with the screw holes on the system board connector (J_PERC).
5. Tighten the two retention screws to secure the PCIe SSD backplane cable connector on the system board.
6. Install the hard drive or SSD cage.
7. Align the retention screws on the hard-drive or SSD backplane with the screw holes on the hard drive or SSD cage.
8. Lower the hard-drive or SSD backplane into place until the retention screws on the hard-drive or SSD backplane engage with the screw holes on the hard-drive or SSD cage.
9. Tighten the retention screws to secure the hard-drive or SSD backplane on the system board.
10. Connect the power cable to the backplane.

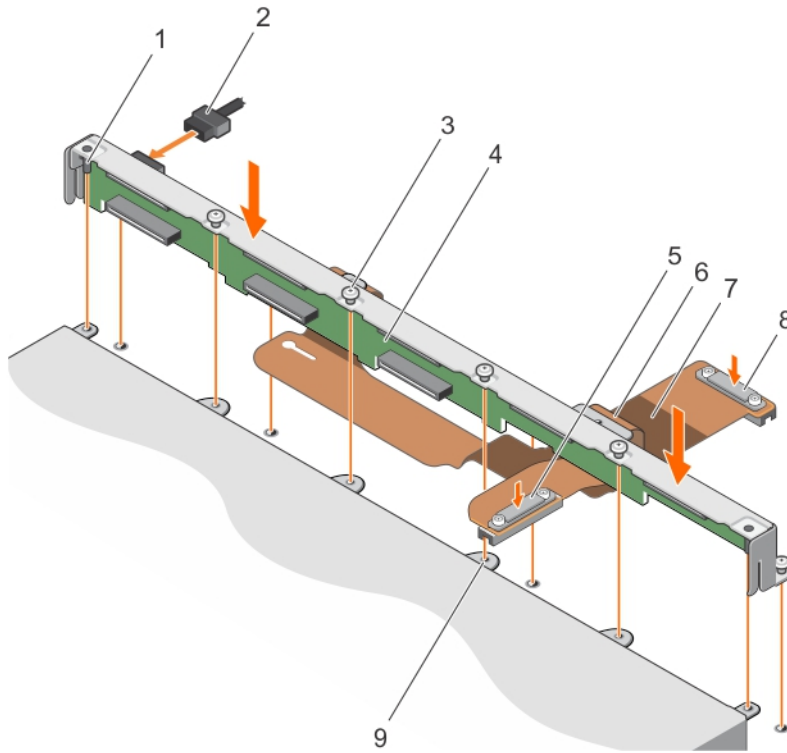

Figure 61. Installing a 2.5-inch (x6) SATA hard drive or SSD and 2.5-inch (x2) PCIe SSD backplane

- | | |
|---|---|
| 1. alignment pin (2) | 2. power cable |
| 3. retention screw (8) | 4. hard drive or SSD backplane |
| 5. PCIe SSD backplane cable connector | 6. PCIe SSD backplane cable |
| 7. SATA hard-drive or SSD backplane cable | 8. SATA hard-drive or SSD backplane cable connector |
| 9. hard-drive or SSD cage | |

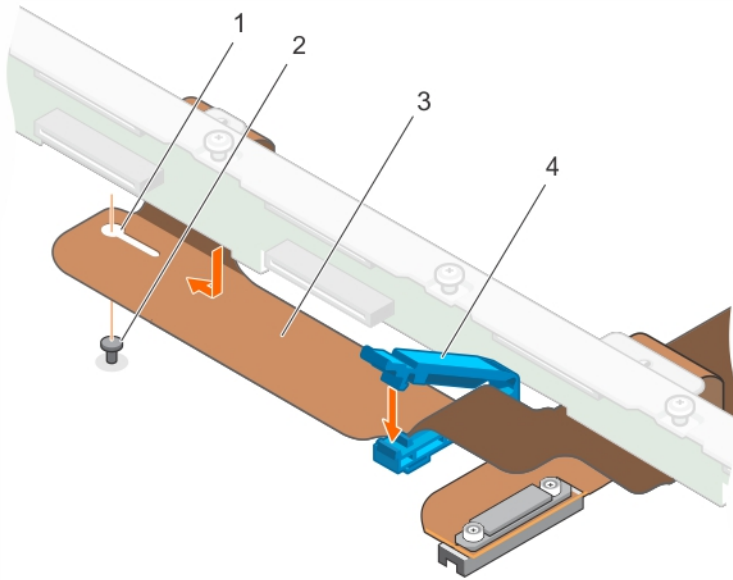

Figure 62. Installing a 2.5-inch (x6) SATA hard drive or SSD plus 2.5-inch (x2) PCIe SSD backplane

- | | |
|---|----------------------------|
| 1. slot on the SATA hard-drive or SSD backplane cable | 2. standoff on the chassis |
| 3. SATA hard-drive or SSD backplane cable | 4. retention clip |

Next steps

1. Install the hard drives or SSDs in their original locations.
2. Follow the procedure listed in the After working inside your system section.

Related Links

[Safety instructions](#)

[Before working inside your system](#)

[Removing a 2.5-inch \(x6\) SATA hard drive or SSD and 2.5-inch \(x2\) PCIe SSD backplane](#)

[After working inside your system](#)

Removing a 1.8-inch (x16) SAS SSD backplane

Prerequisites

⚠ CAUTION: Many repairs may only be done by a certified service technician. You should only perform troubleshooting and simple repairs as authorized in your product documentation, or as directed by the online or telephone service and support team. Damage due to servicing that is not authorized by Dell is not covered by your warranty. Read and follow the safety instructions that came with the product.

🔧 NOTE: You must remove the SSD backplane to replace a faulty SSD backplane or service other components inside the system.

1. Follow the safety guidelines listed in the Safety instructions section.
2. Follow the procedure listed in the Before working inside your system section.
3. Keep the #2 Phillips screwdriver ready.

 **CAUTION:** To prevent damage to the SSDs and the SSD backplane, you must remove the SSDs from the sled before removing the SSD backplane.

 **CAUTION:** You must note the number of each SSD and temporarily label them before removal so that you can replace them in the same locations.

4. Remove the SSDs.

Steps

1. Disconnect the power cable from the SSD backplane.
2. Loosen the retention screws securing SSD backplane to the SSD cage.
3. Lift the SSD backplane by its edges until the retention screws disengage from the screw holes on the SSD cage.
4. Remove the SSD cage.
5. Perform the following steps:
 -  **NOTE:** The 1.8 inch (x16) SSD backplane is a full-length backplane with two backplane cables. The connector on one of the backplane cables connects the SSDs populated in bays 0-7, to the connector on the system board (J_PERC) through the expander card. For more information about installing the expander card, see the Expander card section. The connector on the other backplane cable connects the SSDs populated in bays 8-15, to the connector on the system board (SATA_BP).
 - a. Loosen the retention screw securing the backplane cable connector to the connector on the expander card (EXP).
 - b. Loosen the two retention screws securing the backplane cable connector to the system board connector (SATA_BP).
6. Lift the backplane away from the system.

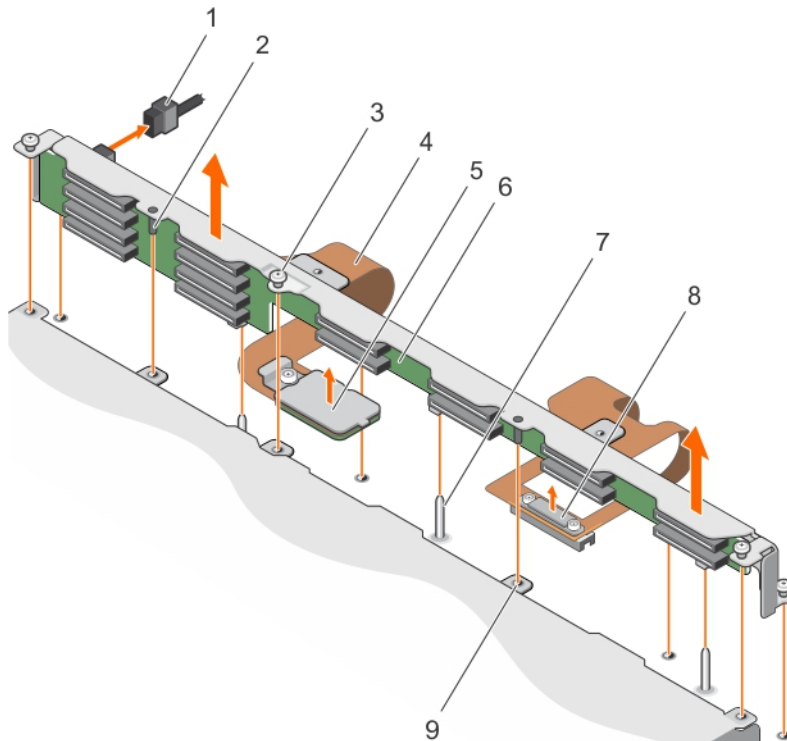

Figure 63. Removing a 1.8-inch (x16) SAS SSD backplane

- | | |
|--|---|
| 1. power cable | 2. alignment pin |
| 3. retention screw on the top of the backplane (3) | 4. backplane cable (2) |
| 5. backplane cable connector that connects to the connector on the expander card | 6. backplane |
| 7. guide pin (3) | 8. backplane cable connector that connects to the connector on the system board |
| 9. SSD cage | |

Next steps

1. Install the SSD backplane.
2. Follow the procedure listed in the After working inside your system section.

Related Links

[Safety instructions](#)

[Before working inside your system](#)

[Installing a 1.8-inch \(x16\) SAS SSD backplane](#)

[After working inside your system](#)

Installing a 1.8-inch (x16) SAS SSD backplane

Prerequisites

 **CAUTION:** Many repairs may only be done by a certified service technician. You should only perform troubleshooting and simple repairs as authorized in your product documentation, or as directed by the online or telephone service and support team. Damage due to servicing that is not authorized by Dell is not covered by your warranty. Read and follow the safety instructions that came with the product.

 **NOTE:** The 1.8-inch (x16) SSD backplane is a full-length backplane with two backplane cables. The connector on one of the backplane cables connects the SSDs populated in bays 0–7, to the connector on the system board (J_PERC) through the expander card. For more information about installing the expander card, see the Expander card section. The connector on the other backplane cable connects the SSDs populated in bays 8–15, to the connector on the system board (SATA_BP).

1. Follow the safety guidelines listed in the Safety instructions section.
2. Follow the procedure listed in the Before working inside your system section.
3. Keep the #2 Phillips screwdriver ready.
4. Remove the SSD backplane.

 **NOTE:** You must remove the SSD backplane to replace a faulty SSD backplane or service other components inside the system.

Steps

1. Align the two retention screws on the backplane cable connector with the two screw holes on the system board connector (SATA_BP).
2. Tighten the two retention screws to secure the backplane cable connector on the system board.
3. Align the retention screw on the backplane cable connector with the screw hole on the expander card connector (EXP).
4. Tighten the retention screw to secure the backplane cable connector on the expander card.
5. Install the SSD cage.
6. Align the guides on the SSD backplane with the guide pins on the SSD cage.
7. Lower the SSD backplane into place until the guide pins on the SSD backplane engage with the guides on the SSD cage.
8. Tighten the retention screws to secure the SSD backplane on the system board.
9. Connect the power cable to the backplane.

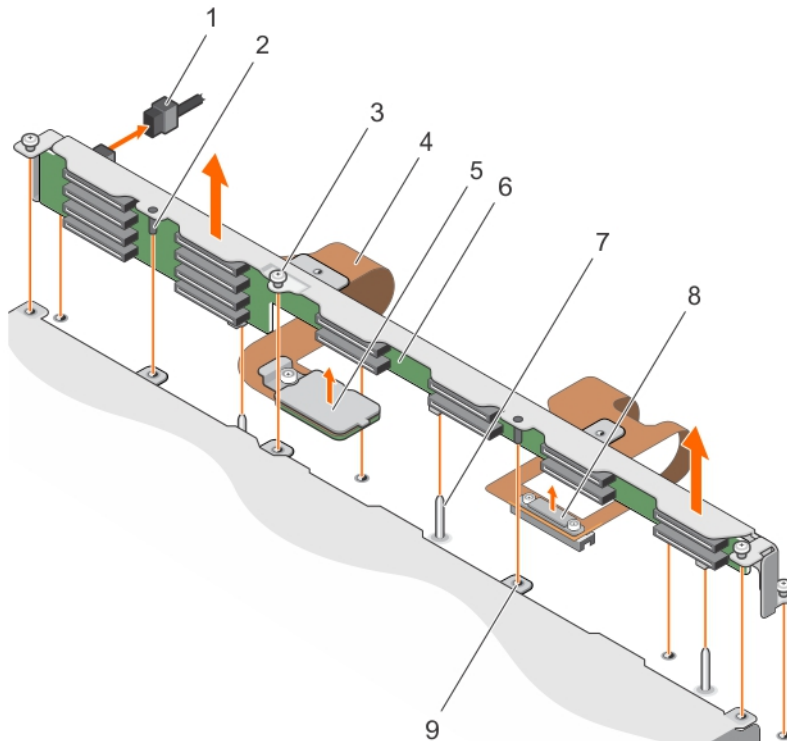

Figure 64. Installing a 1.8-inch (x16) SAS SSD backplane

- | | |
|--|---|
| 1. power cable | 2. alignment pin |
| 3. retention screw on the top of the backplane (3) | 4. backplane cable (2) |
| 5. backplane cable connector that connects to the connector on the expander card | 6. backplane |
| 7. guide pin (3) | 8. backplane cable connector that connects to the connector on the system board |
| 9. SSD cage | |

Next steps

1. Install the SSDs in their original locations.
2. Follow the procedure listed in the After working inside your system section.

Related Links

- [Safety instructions](#)
- [Before working inside your system](#)
- [Removing a 1.8-inch \(x16\) SAS SSD backplane](#)
- [After working inside your system](#)

Storage controller card

Your system includes dedicated expansion-card slots on the system board for a storage controller card that provides the integrated storage subsystem for your system hard drives/PCIe SSDs. The storage controller card supports SAS hard drives.

 **NOTE:** The storage controller card is located underneath the drive bays.

 **NOTE:** The storage controller card is installed on the system board connector labeled as MiniPERC CARD.

Removing the storage controller card

Prerequisites

 **CAUTION:** Many repairs may only be done by a certified service technician. You should only perform troubleshooting and simple repairs as authorized in your product documentation, or as directed by the online or telephone service and support team. Damage due to servicing that is not authorized by Dell is not covered by your warranty. Read and follow the safety instructions that are shipped with your product.

 **NOTE:** This is a Field Replaceable Unit (FRU). Removal and installation procedures should be performed only by Dell certified service technicians.

 **NOTE:** You must remove the storage controller card to replace a faulty storage controller card or service other components inside the system.

1. Follow the safety guidelines listed in the Safety instructions section.
2. Follow the procedure listed in the Before working inside your system section.
3. Keep the #2 Phillips screwdriver ready.
4. Remove the following:
 - a. hard drives or SSDs
 - b. hard drive backplane or SSD backplane
 - c. hard drive cage or SSD cage

Steps

1. Loosen the two retention screws on the hard-drive backplane or SSD backplane cable connector and lift it away from the storage controller card.

 **CAUTION:** To prevent damage to the storage controller card, hold the card only by its edges.

2. Lift the storage controller card away from the system.

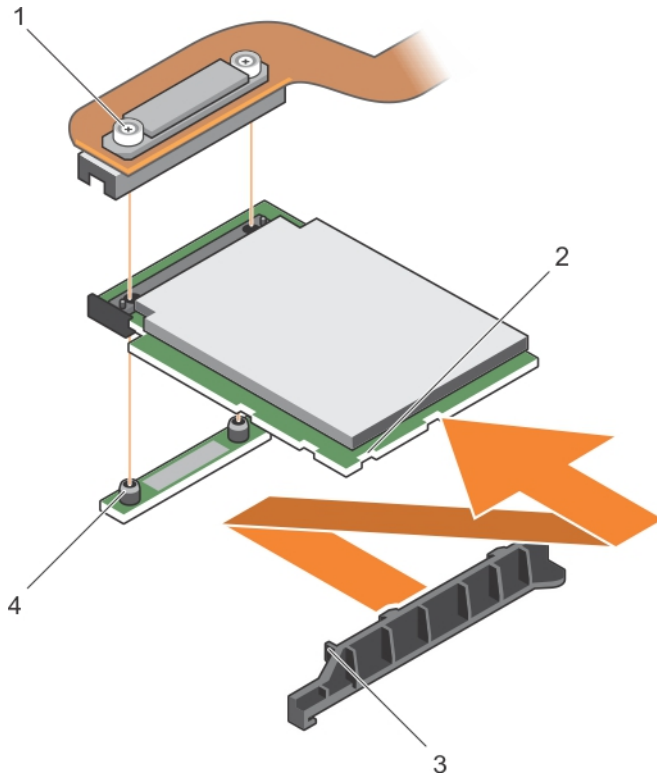

Figure 65. Removing the storage controller card

- | | |
|---|--|
| 1. retention screw (2) | 2. slot on the storage controller card |
| 3. tab on the storage controller card support bracket | 4. standoff (2) |

Next steps

1. Install the storage controller card.
2. Follow the procedure listed in the After working inside your system section.

Related Links

- [Safety instructions](#)
- [Before working inside your system](#)
- [Hard drives or SSDs](#)
- [Hard-drive or SSD cage](#)
- [Hard drive or SSD backplane](#)
- [After working inside your system](#)

Installing the storage controller card

Prerequisites

- ⚠ CAUTION:** Many repairs may only be done by a certified service technician. You should only perform troubleshooting and simple repairs as authorized in your product documentation, or as directed by the online or telephone service and support team. Damage due to servicing that is not authorized by Dell is not covered by your warranty. Read and follow the safety instructions that came with the product.

NOTE: This is a Field Replaceable Unit (FRU). Removal and installation procedures should be performed only by Dell certified service technicians.

1. Follow the safety guidelines listed in the Safety instructions section.
2. Follow the procedure listed in the Before working inside your system section.
3. Keep the #2 Phillips screwdriver ready.
4. Remove the storage controller card.

NOTE: You must remove the storage controller card to replace a faulty storage controller card or service other components inside the system.

Steps

1. Align the slots on the storage controller card edge with the tabs on the support bracket.

CAUTION: To prevent damage to the storage controller card, hold the card only by its edges.

2. Lower the storage controller card on to the connector on the system board.
3. Tighten the two retention screws on the hard-drive backplane or SSD backplane cable connector to secure the card on to the system board.

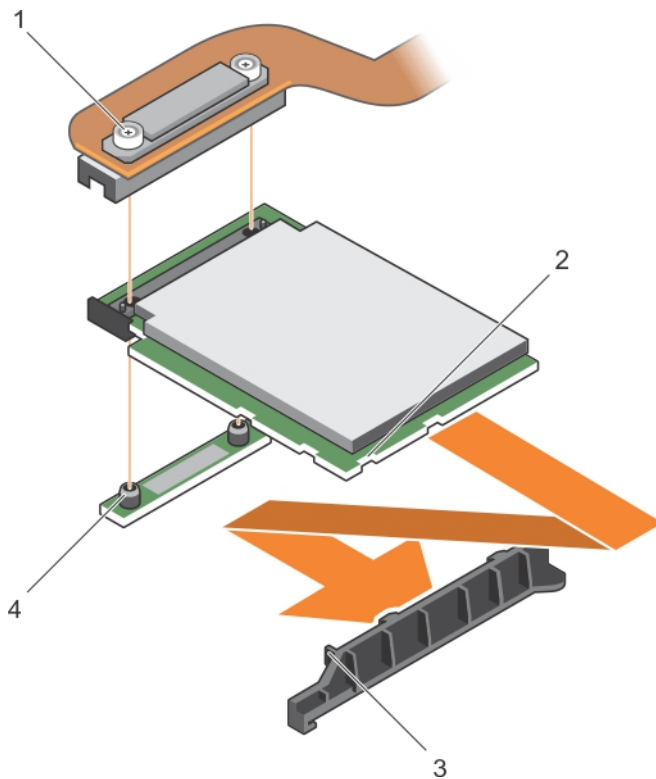

Figure 66. Installing the storage controller card

- | | |
|--|---|
| 1. retention screw (2) | 2. slot on the PCIe extender or storage controller card |
| 3. tab on the PCIe extender or storage controller card support bracket | 4. standoff (2) |

Next steps

1. Install the following:
 - a. hard drives or SSDs
 - b. hard-drive backplane or SSD backplane
 - c. hard-drive cage or SSD cage
2. Follow the procedure listed in the After working inside your system section.

Related Links

[Safety instructions](#)

[Before working inside your system](#)

[After working inside your system](#)

Expander card

Removing an expander card

Prerequisites

 **CAUTION:** Many repairs may only be done by a certified service technician. You should only perform troubleshooting and simple repairs as authorized in your product documentation, or as directed by the online or telephone service and support team. Damage due to servicing that is not authorized by Dell is not covered by your warranty. Read and follow the safety instructions that are shipped with your product.

 **NOTE:** This is a Field Replaceable Unit (FRU). Removal and installation procedures should be performed only by Dell certified service technicians.

 **NOTE:** You must remove the expander card to replace a faulty expander card.

 **NOTE:** Ensure that you install an expander card if you are using a 1.8-inch (x16) SSD system.

1. Follow the safety guidelines listed in the Safety instructions section.
2. Follow the procedure listed in the Before working inside your system section.
3. Keep the #1 and #2 Phillips screwdrivers ready.
4. Remove the following:
 - a. hard drives or SSDs
 - b. hard-drive backplane or SSD backplane
 - c. hard-drive cage or SSD cage

Steps

1. Loosen the retention screws on the expander-card cable connector that connects to the connector on the system board (J_PERC) and lift the cable up.

 **CAUTION:** To prevent damage to an expander card, hold the card only by its edges.

2. Remove the screw that secures the expander card to the chassis.
3. Lift the card away from the system.

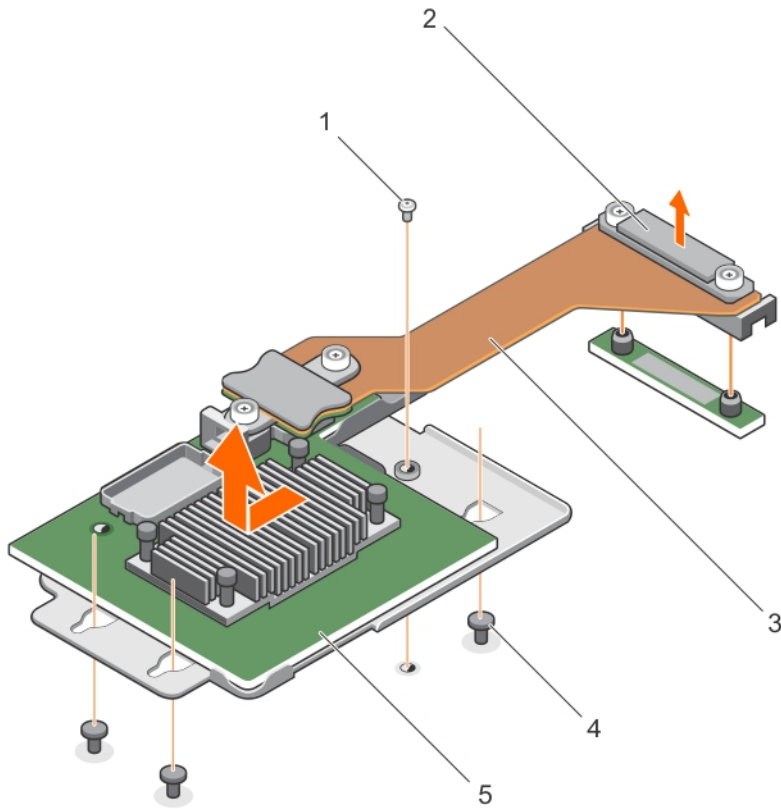

Figure 67. Removing an expander card

- | | |
|------------------------|----------------------------------|
| 1. screw | 2. expander-card cable connector |
| 3. expander-card cable | 4. standoff (3) |
| 5. expander card | |

Next steps

1. Install the expander card.
2. Follow the procedure listed in the After working inside your system section.

Related Links

- [Safety instructions](#)
- [Before working inside your system](#)
- [Installing an expander card](#)
- [Removing the hard-drive or SSD cage](#)
- [Removing a 2.5 inch \(x8\) SATA hard-drive or SSD backplane](#)
- [Removing a 2.5-inch \(x8\) SAS hard-drive or SSD backplane](#)
- [Removing a 2.5-inch \(x6\) SATA hard drive or SSD and 2.5-inch \(x2\) PCIe SSD backplane](#)
- [Removing a 1.8-inch \(x16\) SAS SSD backplane](#)
- [After working inside your system](#)

Installing an expander card

Prerequisites

 **CAUTION:** Many repairs may only be done by a certified service technician. You should only perform troubleshooting and simple repairs as authorized in your product documentation, or as directed by the online or telephone service and support team. Damage due to servicing that is not authorized by Dell is not covered by your warranty. Read and follow the safety instructions that came with the product.

 **NOTE:** This is a Field Replaceable Unit (FRU). Removal and installation procedures should be performed only by Dell certified service technicians.

1. Follow the safety guidelines listed in the Safety instructions section.
2. Follow the procedure listed in the Before working inside your system section.
3. Keep the #1 and #2 Phillips screwdrivers ready.
4. Remove the expander card.

 **NOTE:** You must remove the expander card to replace a faulty expander card.

Steps

1. Align the slots on the expander card with the standoffs on the chassis.

 **CAUTION:** To prevent damage to the expander card, hold the card only by its edges.

2. Lower the expander card in to the chassis until the slots on the expander card engage with the standoffs on the chassis.
3. Tighten the screw to secure the expander card to the chassis.
4. Align the expander-card cable connector with the connector on the system board (J_PERC).
5. Tighten the retention screws on the expander-card cable connector until the connector is seated firmly.

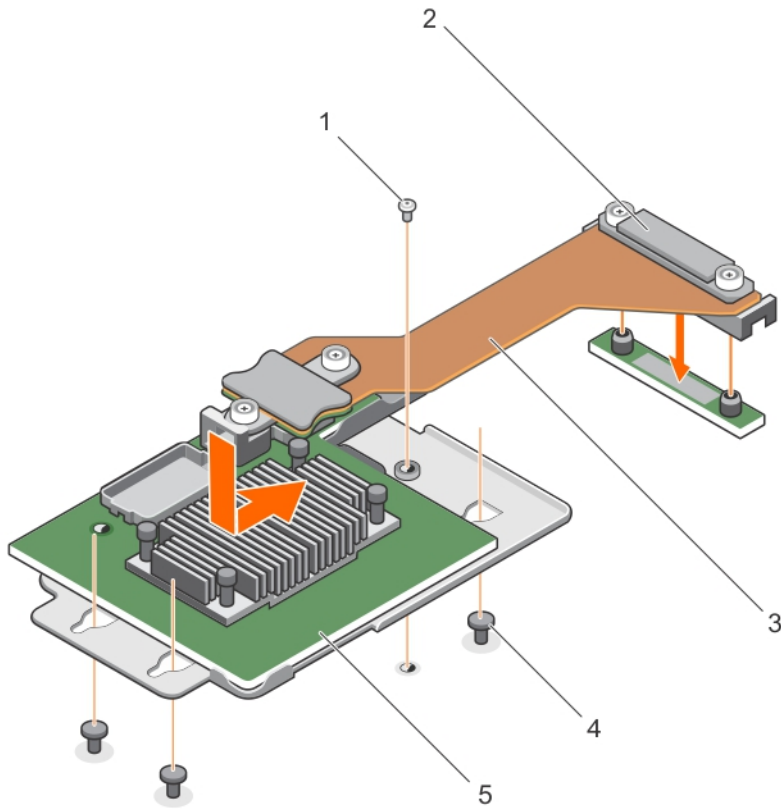

Figure 68. Installing an expander card

- | | |
|------------------------|----------------------------------|
| 1. screw | 2. expander-card cable connector |
| 3. expander-card cable | 4. standoff (3) |
| 5. expander card | |

Next steps

1. Install the following:
 - a. hard drives or SSDs
 - b. hard-drive backplane or SSD backplane
 - c. hard-drive cage or SSD cage
2. Follow the procedure listed in the After working inside your system section.

Related Links

[Safety instructions](#)

[Before working inside your system](#)

[Removing an expander card](#)

[Installing the hard-drive or SSD cage](#)

[Installing a 2.5-inch \(x8\) SATA hard-drive or SSD backplane](#)

[Installing a 2.5-inch \(x8\) SAS hard-drive or SSD backplane](#)

[Installing a 2.5-inch \(x6\) SATA hard drive or SSD and 2.5-inch \(x2\) PCIe SSD backplane](#)

[Installing a 1.8-inch \(x16\) SAS SSD backplane](#)

[After working inside your system](#)

System battery

The NVRAM backup battery installed in your system helps to retain the BIOS settings and configurations even if the power is switched off.

Replacing the NVRAM backup battery

Prerequisites



WARNING: There is a danger of a new battery exploding if it is incorrectly installed. Replace the battery only with the same or equivalent type recommended by the manufacturer. Discard used batteries according to the manufacturer's instructions. See the safety instructions that came with your system for additional information.



CAUTION: Many repairs may only be done by a certified service technician. You should only perform troubleshooting and simple repairs as authorized in your product documentation, or as directed by the online or telephone service and support team. Damage due to servicing that is not authorized by Dell is not covered by your warranty. Read and follow the safety instructions that are shipped with your product.

1. Follow the safety guidelines listed in the Safety instructions section.
2. Follow the procedure listed in the Before working inside your system section.
3. Remove the following:
 - a. system cover
 - b. hard drives or SSDs
 - c. hard-drive backplane or SSD backplane
 - d. hard-drive cage or SSD cage
4. If installed, remove the memory module.

Steps

1. Locate the system battery on the system.
2. Hold the battery and pull it toward the positive side of the battery until the battery disengages from the connector.
3. Lift the battery away from the system.

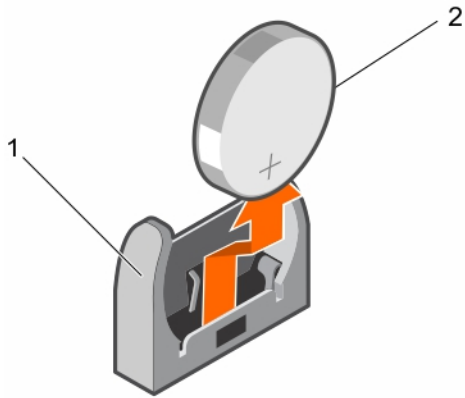

Figure 69. Removing the NVRAM backup battery

1. negative side of battery connector
 2. positive side of battery
4. To install a new system battery, hold the battery with the negative side of battery facing the negative side of the battery connector.

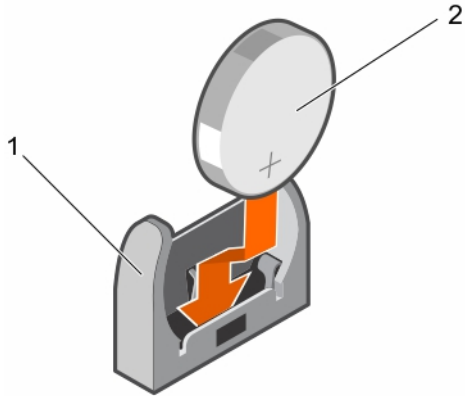

Figure 70. Installing the NVRAM backup battery

1. negative side of battery connector
 2. positive side of battery
5. Place the battery into the connector and push the positive side of the battery until the battery snaps into place.

Next steps

1. If applicable, install the memory module.
2. Install the following:
 - a. hard drives or SSDs
 - b. hard-drive backplane or SSD backplane
 - c. hard-drive cage or SSD cage
3. Follow the procedure listed in the After working inside your system section.
4. Enter System Setup to confirm that the battery is operating properly.
5. Enter the correct time and date in the System Setup **Time** and **Date** fields.
6. Exit System Setup.

7. To test the newly installed battery, remove the sled for at least an hour.
8. Reinstall the sled after an hour.
9. Follow the procedure listed in the After working inside your system section.
10. Enter System Setup and if the time and date are still incorrect, see Getting help section.

Related Links

- [Safety instructions](#)
- [Before working inside your system](#)
- [Hard drives or SSDs](#)
- [Hard-drive or SSD cage](#)
- [Hard drive or SSD backplane](#)
- [Removing memory modules](#)
- [After working inside your system](#)

System board

A system board (also known as the motherboard) is the main printed circuit board found in computers. The system board allows communication between many of the crucial electronic components of the computer, such as the central processing unit (CPU) and memory, and also provides connectors for other peripherals. Unlike a backplane, a system board contains significant number subsystems such as the processor expansion cards, and other components.

Removing the system board

Prerequisites



CAUTION: Many repairs may only be done by a certified service technician. You should only perform troubleshooting and simple repairs as authorized in your product documentation, or as directed by the online or telephone service and support team. Damage due to servicing that is not authorized by Dell is not covered by your warranty. Read and follow the safety instructions that came with the product.



NOTE: This is a Field Replaceable Unit (FRU). Removal and installation procedures should be performed only by Dell certified service technicians.



NOTE: You must remove the system board to replace a faulty system board.

1. Follow the safety guidelines listed in the Safety instructions section.
2. Follow the procedure listed in the Before working inside your system section.
3. Keep the 5 mm and 6 mm Hex nut drivers, #2 Phillips screwdriver, and #2 Phillips round screwdriver ready.
4. Remove the following:
 - a. processor(s) and heat sink(s)
 - b. memory modules
 - c. cooling shroud
 - d. hard drives or SSDs
 - e. hard-drive backplane or SSD backplane
 - f. hard-drive cage or SSD cage
 - g. storage controller card

- h. expander card
 - i. PCIe mezzanine cards
 - j. IDSDM card or rSPI card
 - k. NDC
 - l. SD vFlash card
 - m. internal USB key
5. Install an I/O connector cover on the I/O connector(s) at the back of the board.

 **CAUTION: Do not lift the system board by holding a memory module, processor, or other components.**

 **CAUTION: Temporarily label the hard drive/SSD before removal so that you can replace them in their original locations.**

 **WARNING: The processor and heat sink can become extremely hot. Be sure the processor has had sufficient time to cool before handling.**

 **WARNING: The memory modules are hot to touch for some time after the system has been powered down. Allow time for the memory modules to cool before handling them. Handle the memory modules by the card edges and avoid touching the components.**

Steps

1. Remove the screws on the system board that secure the system board to the chassis.
2. Lift the system board by its edges and orient it upward.
3. Remove the system board from the chassis by disengaging the USB connectors from the slots on the front wall of the chassis.
4. Ensure that the I/O connector cover is still in place on the I/O connector at the back of the system board.

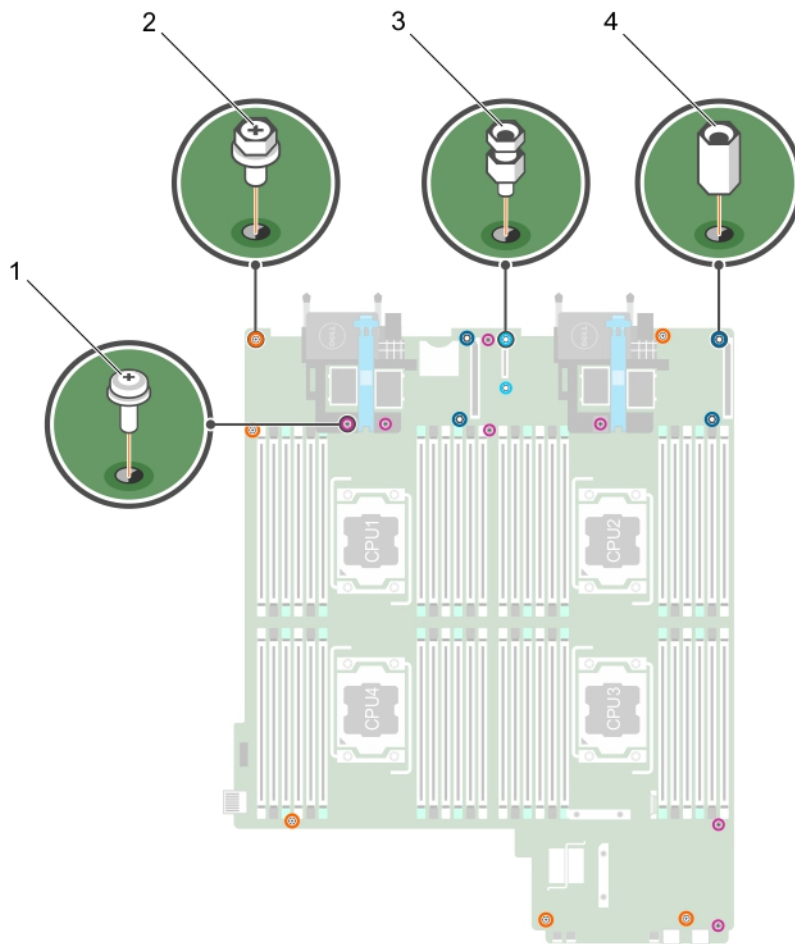





Figure 71. Different type of screws on the system board

Table 26. Different type of screws

Item	Icon	Description
1.		#2 Phillips round screw (7)
2.		#2 Phillips hex screw (6)
3.		Hex bolt screw—5 mm (2)
4.		Hex nut screw—6 mm (4)

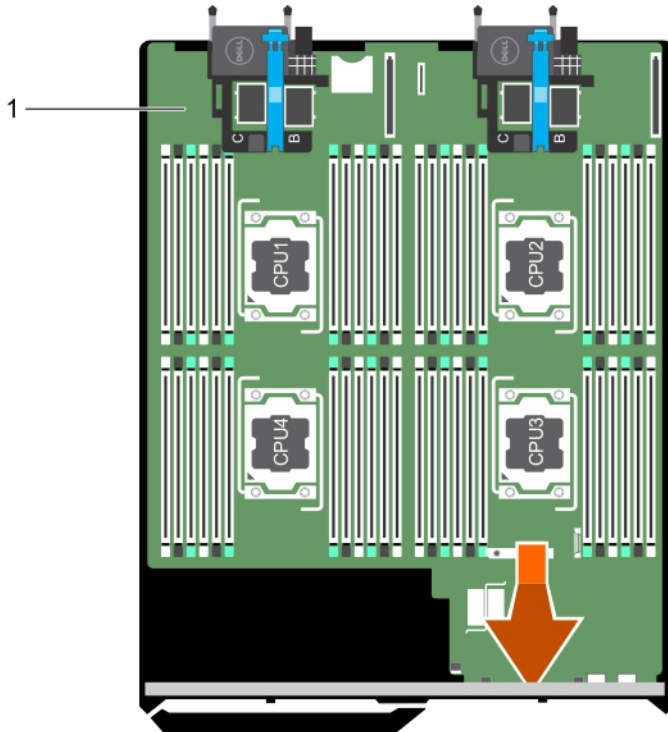

Figure 72. Removing the system board

1. system board

Next steps

1. Install the system board.
2. Follow the procedure listed in the After working inside your system section.

Related Links

- [Safety instructions](#)
- [Before working inside your system](#)
- [Cooling shroud](#)
- [Processors](#)
- [System memory](#)
- [PCIe mezzanine card](#)
- [Internal USB key](#)
- [Internal dual SD module \(optional\)](#)
- [SD vFlash card](#)
- [Network daughter card](#)
- [Storage controller card](#)
- [Expander card](#)
- [Hard drives or SSDs](#)
- [Hard-drive or SSD cage](#)
- [Hard drive or SSD backplane](#)
- [Installing the system board](#)
- [After working inside your system](#)

Installing the system board

Prerequisites

 **CAUTION:** Many repairs may only be done by a certified service technician. You should only perform troubleshooting and simple repairs as authorized in your product documentation, or as directed by the online or telephone service and support team. Damage due to servicing that is not authorized by Dell is not covered by your warranty. Read and follow the safety instructions that came with the product.

 **NOTE:** This is a Field Replaceable Unit (FRU). Removal and installation procedures should be performed only by Dell certified service technicians.

1. Follow the safety guidelines listed in the Safety instructions section.
2. Follow the procedure listed in the Before working inside your system section.
3. Keep the 5 mm and 6 mm Hex nut drivers, #2 Phillips screwdriver, and #2 Phillips round screwdriver ready.
4. Remove the system board.

 **CAUTION:** Do not lift the system board by holding a memory module, processor, or other components.

 **CAUTION:** Take care not to damage the system identification button while placing the system board into the chassis.

 **NOTE:** You must remove the system board to replace a faulty system board.

Steps

1. Hold the system board by its edges and orient it toward the front of the chassis.
2. Align the USB connectors with the slots on the front wall of the chassis.
3. Lower the system board and install the screws to secure the system board to the chassis.

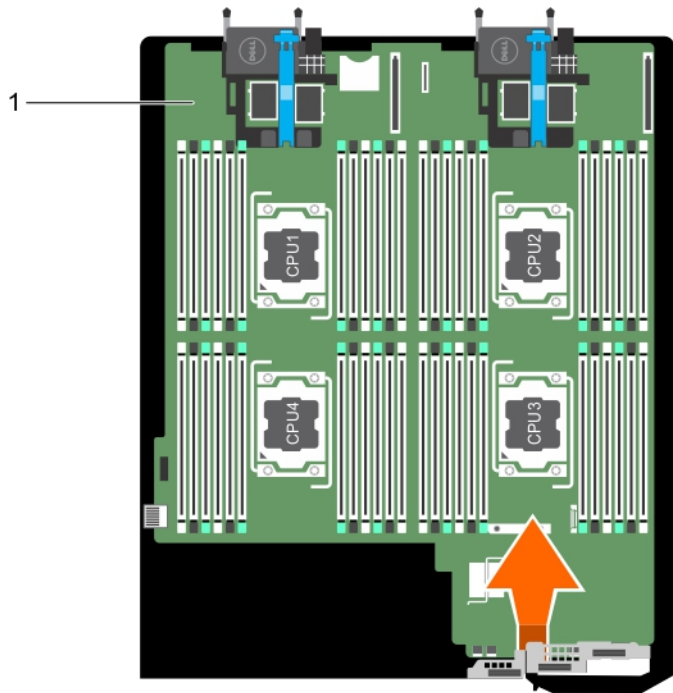



Figure 73. Installing the system board

1. system board

Next steps

1. Install the following:
 - a. internal USB key
 - b. SD vFlash card
 - c. IDSDM card or SPI card
 - d. NDC
 - e. PCIe mezzanine cards
 - f. expander card
 - g. storage controller card
 - h. hard-drive cage or SSD cage
 - i. hard-drive backplane or SSD backplane
 - j. hard drives or SSDs

 **NOTE:** Ensure that you reinstall the hard drives or SSDs in their original locations.

- k. cooling shroud
 - l. memory modules
 - m. processor(s) and heat sink(s)
2. Remove the plastic I/O connector covers from the back of the system.
3. Follow the procedure listed in the After working inside your system section.
4. Import your new or existing iDRAC Enterprise license. For more information, see the *iDRAC8 User's Guide* at **Dell.com/idracmanuals**.
5. Ensure that you:
 - a. Use the Easy Restore feature to restore the Service Tag. For more information, see the Restoring the Service Tag by using Easy Restore section.
 - b. If the Service Tag is not backed up in the backup flash device, enter the system Service Tag manually. For more information, see the Entering the system Service Tag section.
 - c. Update the BIOS and iDRAC versions.
 - d. Re-enable the Trusted Platform Module (TPM). For more information, see the Re-enabling the TPM for BitLocker users or Re-enabling the TPM for Intel TXT users section.

Related Links

- [Safety instructions](#)
- [Before working inside your system](#)
- [Cooling shroud](#)
- [Processors](#)
- [System memory](#)
- [PCIe mezzanine card](#)
- [Internal USB key](#)
- [Internal dual SD module \(optional\)](#)
- [SD vFlash card](#)
- [Network daughter card](#)
- [Storage controller card](#)
- [Expander card](#)
- [Hard drives or SSDs](#)
- [Hard-drive or SSD cage](#)
- [Hard drive or SSD backplane](#)
- [Removing the system board](#)
- [Restoring the Service Tag by using the Easy Restore feature](#)
- [Entering the system Service Tag by using System Setup](#)
- [Initializing the TPM for BitLocker users](#)
- [Initializing the TPM for TXT users](#)
- [After working inside your system](#)

Restoring the Service Tag by using the Easy Restore feature

The Easy Restore feature enables you to restore your system's Service Tag, license, UEFI configuration, and the system configuration data after replacing the system board. All data is automatically backed up in a backup flash device. If BIOS detects a new system board and the Service Tag in the backup flash device, BIOS prompts the user to restore the backup information.

1. Turn on the system.

If BIOS detects a new system board, and if the Service Tag is present in the backup flash device, BIOS displays the Service Tag, the status of the license, and the **UEFI Diagnostics** version.

2. Perform one of the following steps:

After the restore process is complete, BIOS prompts to restore the system configuration data.

3. Perform one of the following steps:

- Press **Y** to restore the system configuration data.
- Press **N** to use the default configuration settings.

After the restore process is complete, the system restarts.

Entering the system Service Tag by using System Setup

If Easy Restore fails to restore the Service Tag, use System Setup to enter the Service Tag.

1. Turn on the system.
2. Press F2 to enter System Setup.
3. Click **Service Tag Settings**.
4. Enter the Service Tag.

 **NOTE:** You can enter the Service Tag only when the **Service Tag** field is empty. Ensure that you enter the correct Service Tag. After the Service Tag is entered, it cannot be updated or changed.

5. Click **Ok**.
6. Import your new or existing iDRAC Enterprise license.

For more information, see the *Integrated Dell Remote Access Controller User's Guide* at Dell.com/idracmanuals.

Trusted Platform Module

Trusted Platform Module (TPM) is a dedicated microprocessor designed to secure hardware by integrating cryptographic keys into devices. A software can use a Trusted Platform Module to authenticate hardware devices. As each TPM chip has a unique and secret RSA key burned in as it is produced, it can perform the platform authentication.

 **CAUTION:** Do not attempt to remove the Trusted Platform Module (TPM) from the system board. After the TPM is installed, it is cryptographically bound to that specific system board. Any attempt to remove an installed TPM breaks the cryptographic binding, and it cannot be re-installed or installed on another system board.

 **NOTE:** This is a Field Replaceable Unit (FRU). Removal and installation procedures must be performed only by Dell certified service technicians.

Installing the Trusted Platform Module

Prerequisites

 **CAUTION:** Many repairs may only be done by a certified service technician. You should only perform troubleshooting and simple repairs as authorized in your product documentation, or as directed by the online or telephone service and support team. Damage due to servicing that is not authorized by Dell is not covered by your warranty. Read and follow the safety instructions that are shipped with your product.

1. Follow the safety guidelines listed in the Safety instructions section.
2. Follow the procedure listed in the Before working inside your system section.

Steps

1. Locate the TPM connector on the system board.
 -  **NOTE:** To locate the TPM connector on the system board, see the System board connectors section.
2. Align the edge connectors on the TPM with the slot on the TPM connector.
3. Insert the TPM into the TPM connector such that the plastic rivet aligns with the slot on the system board.
4. Press the plastic rivet until the rivet snaps into place.

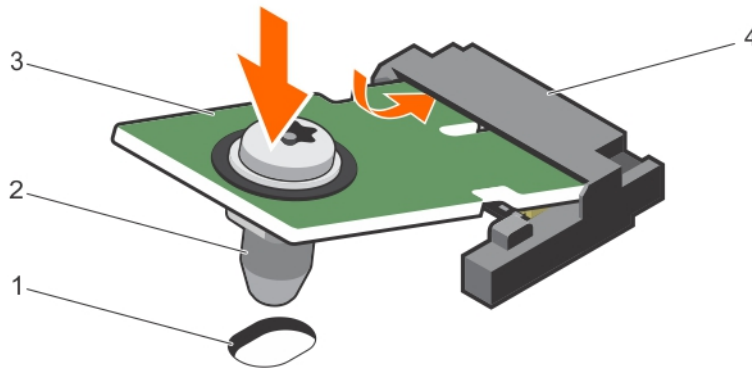

Figure 74. Installing the TPM

- | | |
|-----------------------------------|------------------|
| 1. rivet slot on the system board | 2. plastic rivet |
| 3. TPM | 4. TPM connector |

Next steps

1. Install the system board.
2. Follow the procedure listed in the After working inside your system section.

Related Links

- [Safety instructions](#)
- [Before working inside your system](#)
- [Installing the system board](#)
- [After working inside your system](#)

Initializing the TPM for BitLocker users

Initialize the TPM.

For more information about initializing the TPM, see <http://technet.microsoft.com/en-us/library/cc753140.aspx>.

The **TPM Status** changes to **Enabled, Activated**.

Initializing the TPM for TXT users

1. While booting your system, press F2 to enter System Setup.
2. On the **System Setup Main Menu** screen, click **System BIOS** → **System Security Settings**.
3. From the **TPM Security** option, select **On with Pre-boot Measurements**.

4. From the **TPM Command** option, select **Activate**.
5. Save the settings.
6. Restart your system.
7. Enter **System Setup** again.
8. On the **System Setup Main Menu** screen, click **System BIOS** → **System Security Settings**.
9. From the **Intel TXT** option, select **On**.

Using system diagnostics

If you experience a problem with your system, run the system diagnostics before contacting Dell for technical assistance. The purpose of running system diagnostics is to test your system hardware without requiring additional equipment or risking data loss. If you are unable to fix the problem yourself, service and support personnel can use the diagnostics results to help you solve the problem.

Dell Embedded System Diagnostics

 **NOTE:** The Dell Embedded System Diagnostics is also known as Enhanced Pre-boot System Assessment (ePSA) diagnostics.

The Embedded System Diagnostics provides a set of options for particular device groups or devices allowing you to:

- Run tests automatically or in an interactive mode
- Repeat tests
- Display or save test results
- Run thorough tests to introduce additional test options to provide extra information about the failed device(s)
- View status messages that inform you if tests are completed successfully
- View error messages that inform you of problems encountered during testing

When to use the Embedded System Diagnostics

Run the Embedded System Diagnostics (ePSA) if your system does not boot.

Running the Embedded System Diagnostics

Run the Embedded System Diagnostics (ePSA) if your system does not boot. The embedded system diagnostics program is run from the Dell Lifecycle Controller.

Prerequisites

If a major component or device in the system does not operate properly, running the embedded system diagnostics may indicate component failure.

 **CAUTION:** Use the embedded system diagnostics to test only your system. Using this program with other systems may cause invalid results or error messages.

Steps

1. As the system boots, press F11.
2. Use the up and down arrow keys to select **System Utilities** → **Launch Dell Diagnostics**.
The **ePSA Pre-boot System Assessment** window is displayed, listing all devices detected in the system. The diagnostics starts running the tests on all the detected devices.

Running embedded system diagnostics from an external media

1. Format the external resource media (USB flash drive or CDROM) to emulate a hard drive.
See the documentation that came with the resource media for instructions.
2. Configure the resource media to be a bootable device.
3. Create a directory for the system diagnostics on the resource media.
4. Copy the system diagnostics files into the directory.
To download the Dell diagnostics utility, go to **Dell.com/support/home**.
5. Connect the resource media on your system.
6. As the system boots, press F11.
7. When prompted, select the media to perform a one-time boot.
If diagnostics does not start automatically after the diagnostic media is booted, enter **psa** at the command prompt.

System diagnostics controls

Menu	Description
Configuration	Displays the configuration and status information of all detected devices.
Results	Displays the results of all tests that are run.
System Health	Provides the current overview of the system performance.
Event Log	Displays a time-stamped log of the results of all tests run on the system. This is displayed if at least one event description is recorded.

For information about embedded system diagnostics, see the *Dell Enhanced Pre-boot System Assessment User Guide* at **Dell.com/support/home**.

Jumpers and connectors





This topic provides specific information about the system jumpers. It also provides some basic information about jumpers and switches and describes the connectors on the various boards in the system. Jumpers on the system board help to disable system and setup passwords. You must know the connectors on the system board to install components and cables correctly.

System board jumper settings

⚠ CAUTION: Many repairs may only be done by a certified service technician. You should only perform troubleshooting and simple repairs as authorized in your product documentation, or as directed by the online or telephone service and support team. Damage due to servicing that is not authorized by Dell is not covered by your warranty. Read and follow the safety instructions that came with the product.

For information on resetting the password jumper to disable a password, see the Disabling A Forgotten Password section.

Table 27. System board jumper settings

Jumper	Setting	Description
PWRD_EN	 1 2 3 (default)	The password feature is enabled (pins 1–2).
	 1 2 3	The password feature is disabled (pins 2–3).
NVRAM_CLR	 1 2 3 (default)	The configuration settings are retained at system boot (pins 2–3).
	 1 2 3	The configuration settings are cleared at the next system boot. (pins 1–2).

Related Links

- [Safety instructions](#)
- [Before working inside your system](#)
- [Disabling a forgotten password](#)
- [After working inside your system](#)

System board connectors

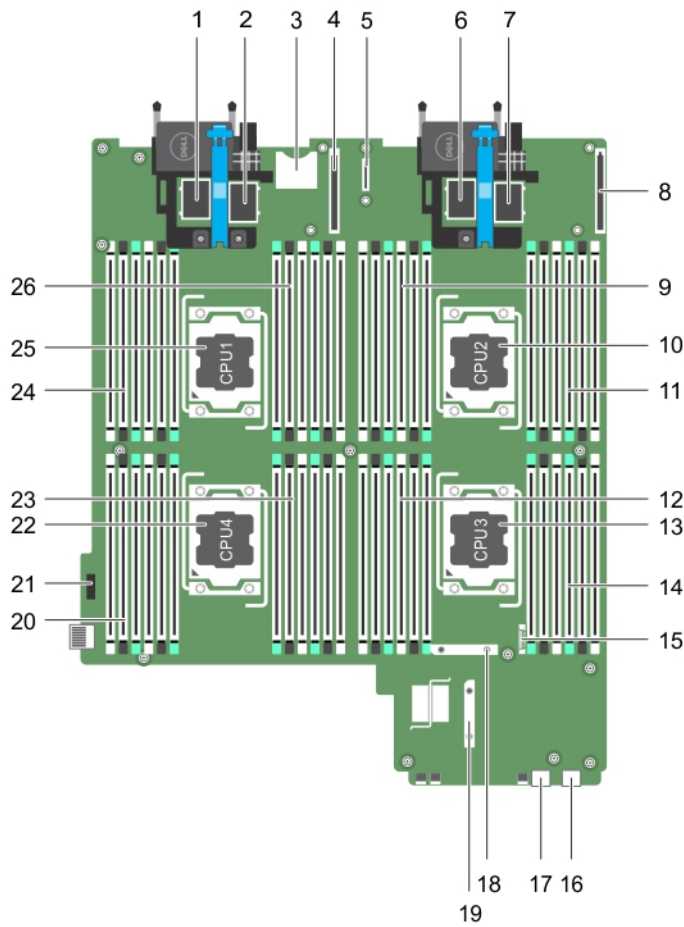

Figure 75. System board connectors

Table 28. System board connectors

Item	Connector	Description
1	MEZZ1_FAB_C1	PCIe mezzanine card connector for the expansion bus
2	MEZZ2_FAB_B1	PCIe mezzanine card connector for the expansion bus
3	VFLASH	SD vFlash card connector
4	bNDC	Network daughter card connector
5	IDSDM/rSPI	IDSDM or rSPI card connector
6	MEZZ3_FAB_C2	PCIe mezzanine card connector for the expansion bus
7	MEZZ4_FAB_B2	PCIe mezzanine card connector for the expansion bus
8	bNDC	Network daughter card connector

Item	Connector	Description
9	B1, B2, B5, B6, B9, B10	Memory module sockets (processor 2)
10	CPU2	Processor socket 2
11	B3, B4, B7, B8, B11, B12	Memory module sockets (processor 2)
12	C3, C4, C7, C8, C11, C12	Memory module sockets (processor 3)
13	CPU3	Processor socket 3
14	C1, C2, C5, C6, C9, C10	Memory module sockets (processor 3)
15	BATTERY	Connector for the 3.0 V coin cell battery
16	USB2	USB connector
17	USB1	USB connector
18	SATA_BP	Hard-drive or SSD backplane connector
19	J_PERC	Storage controller card connector
20	D3, D4, D7, D8, D11, D12	Memory module sockets (processor 4)
21	J_BP_PWR	Backplane power connector
22	CPU4	Processor socket 4
23	D1, D2, D5, D6, D9, D10	Memory module sockets (processor 4)
24	A1, A2, A5, A6, A9, A10	Memory module sockets (processor 1)
25	CPU1	Processor socket 1
26	A3, A4, A7, A8, A11, A12	Memory module sockets (processor 1)

Disabling a forgotten password

The software security features of sled include a system password and a setup password. The password jumper enables these password features or disables them, and clears any password(s) currently in use.

Prerequisites

 **CAUTION: Many repairs may only be done by a certified service technician. You should only perform troubleshooting and simple repairs as authorized in your product documentation, or as directed by the online or telephone service and support team. Damage due to servicing that is not authorized by Dell is not covered by your warranty. Read and follow the safety instructions that came with the product.**

Steps

1. Turn off the sled using the operating system commands or the CMC.
2. Remove the sled from the enclosure to access the jumpers.
3. Move the jumper on the system-board jumper from pins 1 and 2 to pins 2 and 3.
4. Install the sled in the enclosure.
5. Turn on the sled.

When the sled is on, the power-on indicator is solid green. Allow the sled to finish booting.

The existing passwords are not disabled (erased) until the system boots with the password jumper on pins 2 and 3. However, before you assign a new system and/or setup password, you must reinstall the password jumper back to pins 1 and 2.





NOTE: If you assign a new system and/or setup password with the jumper on pins 2 and 3, the system disables the new password(s) the next time it boots.

6. Turn off the sled using the operating system commands or the CMC.
7. Remove the sled from the enclosure to access the jumpers.
8. Move the jumper on the system-board jumper from pins 2 and 3 to pins 1 and 2.
9. Install the sled in the enclosure.
10. Turn on the sled.
11. Assign a new system and/or setup password.

Troubleshooting your system

Safety first — for you and your system

 **CAUTION:** Many repairs may only be done by a certified service technician. You should only perform troubleshooting and simple repairs as authorized in your product documentation, or as directed by the online or telephone service and support team. Damage due to servicing that is not authorized by Dell is not covered by your warranty. Read and follow the safety instructions that are shipped with your product.

 **NOTE:** Solution validation was performed by using the factory shipped hardware configuration.

 **NOTE:** This chapter provides troubleshooting information for the PowerEdge FX2 and FX2s enclosures only. For troubleshooting information on the sleds, see the sled documentation at Dell.com/poweredgemanuals.

 **NOTE:** For troubleshooting information about the PowerEdge FX2 enclosure components, see the *Dell PowerEdge FX2 and FX2s Enclosure Owner's Manual* at Dell.com/poweredgemanuals.

Troubleshooting system memory

Prerequisites

 **CAUTION:** Many repairs may only be done by a certified service technician. You should only perform troubleshooting and simple repairs as authorized in your product documentation, or as directed by the online or telephone service and support team. Damage due to servicing that is not authorized by Dell is not covered by your warranty. Read and follow the safety instructions that are shipped with your product.

 **NOTE:** Before performing the following procedure, ensure that you have installed the memory modules according to the memory installation guidelines for the sled.

Steps

1. Restart the sled:
 - a. Press the power button once to turn off the sled.
 - b. Press the power button again to turn on the sled.
If no error messages appear, go to step 7.
2. Enter System Setup and check the system memory setting.
If the amount of memory installed matches the system memory setting, go to step 7.
3. Turn off the sled using the operating system commands or the CMC.
4. Remove the sled from the enclosure.

 **CAUTION:** The memory modules are hot to touch for some time after the sled has been powered down. Allow time for the memory modules to cool before handling them. Handle the memory modules by the card edges and avoid touching the components.

5. Reseat the memory modules in their sockets.
6. Install the sled in the enclosure.
7. Turn on the sled.
8. Run the appropriate diagnostic test. For more information, see the Using system diagnostics section. If the test fails, see the Getting help section.

Related Links

[Using system diagnostics](#)

[Getting help](#)

Troubleshooting hard drives

Prerequisites

 **CAUTION:** Many repairs may only be done by a certified service technician. You should only perform troubleshooting and simple repairs as authorized in your product documentation, or as directed by the online or telephone service and support team. Damage due to servicing that is not authorized by Dell is not covered by your warranty. Read and follow the safety instructions that are shipped with your product.

 **CAUTION:** This troubleshooting procedure can destroy data stored on the hard drive. Before you proceed, back up all the files on the hard drive, if possible.

Steps

1. Run the appropriate controllers test and the hard drive tests in system diagnostics. If the tests fail, go to step 3.
2. Take the hard drive offline and wait until the hard drive indicator codes on the drive carrier signal that the drive may be removed safely, then remove and reseat the drive carrier in the .
3. Restart the , enter the System Setup and confirm that the drive controller is enabled.
4. Ensure that any required device drivers are installed and are configured correctly.
 -  **NOTE:** Installing a hard drive into another bay may break the mirror if the mirror state is optimal.
5. Remove the hard drive and install it in the other drive bay.
6. If the problem is resolved, reinstall the hard drive in the original bay. If the hard drive functions properly in the original bay, the drive carrier could have intermittent problems. Replace the drive carrier.
7. If the hard drive is the boot drive, ensure that the drive is configured and connected properly.
8. Partition and logically format the hard drive.
9. If possible, restore the files to the drive. If the problem persists, see the Getting help section.

Related Links

[Getting help](#)

Troubleshooting Solid State Drives

Prerequisites

 **CAUTION:** Many repairs may only be done by a certified service technician. You should only perform troubleshooting and simple repairs as authorized in your product documentation, or as directed by the online or telephone service and support team. Damage due to servicing that is not authorized by Dell is not covered by your warranty. Read and follow the safety instructions that are shipped with your product.

 **CAUTION:** This troubleshooting procedure can destroy data stored on the SSD. Before you proceed, back up all the files on the SSD, if possible.

Steps

1. Run the appropriate tests in system diagnostics.
If the tests fail, go to step 3.
2. Take the SSD offline and wait until the indicator codes on the SSD carrier signal that the SSD may be removed safely, then remove and reseat the SSD carrier in the sled.
3. Restart the sled, enter the System Setup and confirm that the drive controller is enabled.
4. Ensure that any required device drivers are installed and are configured correctly.
 **NOTE:** Installing a SSD into another bay may break the mirror if the mirror state is optimal.
5. Remove the SSD and install it in the other SSD slot.
6. If the problem is resolved, reinstall the SSD in the original slot.
If the SSD functions properly in the original slot, the SSD carrier could have intermittent problems. Replace the SSD carrier.
7. If the SSD is the boot drive, ensure that the SSD is configured and connected properly.
8. Partition and logically format the SSD.
9. If possible, restore the files to the SSD.
If the problem persists, see the Getting help section.

Related Links

[Getting help](#)

Troubleshooting USB devices

Prerequisites

 **CAUTION:** Many repairs may only be done by a certified service technician. You should only perform troubleshooting and simple repairs as authorized in your product documentation, or as directed by the online or telephone service and support team. Damage due to servicing that is not authorized by Dell is not covered by your warranty. Read and follow the safety instructions that are shipped with your product.

Steps

1. Ensure that the is turned on.
2. Check the USB device connection to the .
3. Swap the USB device with a working USB device.
4. Connect the USB devices to the by using a powered USB hub.

5. If another is installed, connect the USB device to that . If the USB device works with a different , the first USB ports may be faulty. See the Getting help section.

Related Links

[Getting help](#)

Troubleshooting an internal SD card

Prerequisites

 **CAUTION:** Many repairs may only be done by a certified service technician. You should only perform troubleshooting and simple repairs as authorized in your product documentation, or as directed by the online or telephone service and support team. Damage due to servicing that is not authorized by Dell is not covered by your warranty. Read and follow the safety instructions that are shipped with your product.

 **NOTE:** SD card slot 2 referred in this procedure is the vFlash SD card slot. You can install an SD card in SD card slot 2 to enable the **Internal SD Card Redundancy** option in the **Integrated Devices** screen of the System Setup.

Steps

1. Enter System Setup and ensure that the **Internal SD Card Port** is enabled.
2. Note the **Internal SD Card Redundancy** option enabled in the **Integrated Devices** screen of the System Setup (Mirror or Disabled).
 **NOTE:** If you retain the original settings of the SD card in the System Setup, the replaced SD card is enabled when you reinstall the sled in the enclosure.
3. Remove the sled from the enclosure.
4. If the **Internal SD Card Redundancy** option in the **Integrated Devices** screen of the System Setup is set to Mirror mode and SD card 1 has failed:
 - a. Remove the SD card from SD card slot 1.
 - b. Remove the SD card present in SD card slot 2 and insert it into SD card slot 1.
 - c. Install a new SD card in slot 2.
5. If the **Internal SD Card Redundancy** option in the **Integrated Devices** screen of the System Setup is set to Mirror mode and SD card 2 has failed, insert the new SD card into SD card slot 2.
6. If the **Internal SD Card Redundancy** option in **Integrated Devices** screen of the System Setup is set to Disabled, replace the failed SD card with a new SD card.
7. Install the sled in the enclosure.
8. Enter System Setup and ensure that the **Internal SD Card Port** option is enabled and **Internal SD Card Redundancy** option is set to Mirror mode.
9. Check if the SD card is functioning properly.
If the problem persists, see the Getting help section.

Related Links

[Getting help](#)

Troubleshooting processors

1. Turn off the sled using the operating system commands or the CMC.
2. Remove the sled from the enclosure.
3. Ensure that the processor(s) and heat sink(s) are properly installed.

4. If your system has only one processor installed, ensure that it is installed in the primary processor socket (CPU1).
5. Install the sled in the enclosure.
6. Turn on the sled.
7. Run the appropriate diagnostic test. For more information, see the Using system diagnostics section. If the problem persists, see the Getting help section.

Related Links

[Using system diagnostics](#)

[Getting help](#)

Troubleshooting the system board

Prerequisites

 **CAUTION: Many repairs may only be done by a certified service technician. You should only perform troubleshooting and simple repairs as authorized in your product documentation, or as directed by the online or telephone service and support team. Damage due to servicing that is not authorized by Dell is not covered by your warranty. Read and follow the safety instructions that are shipped with your product.**

Steps

1. Turn off the sled using the operating system commands or the CMC.
2. Remove the sled from the enclosure.
3. Clear the sled NVRAM.
4. If the problem persists, remove and reinstall the sled in the enclosure.
5. Turn on the sled.
6. Run the appropriate diagnostic test. For more information, see the Using System Diagnostics section. If the tests fail, see the Getting help section.

Related Links

[Using system diagnostics](#)

[Getting help](#)

Troubleshooting the NVRAM backup battery

Prerequisites

 **CAUTION: Many repairs may only be done by a certified service technician. You should only perform troubleshooting and simple repairs as authorized in your product documentation, or as directed by the online or telephone service and support team. Damage due to servicing that is not authorized by Dell is not covered by your warranty. Read and follow the safety instructions that are shipped with your product.**

The battery maintains the sled configuration, date, and time information in the NVRAM when the sled is turned off. You may need to replace the battery if an incorrect time or date is displayed during the boot routine.

You can operate the sled without a battery; however, the sled configuration information maintained by the battery in NVRAM is erased each time you remove power supply unit from the sled. Therefore, you

must reenter the system configuration information and reset the options each time the sled boots until you replace the battery.

Steps

1. Reenter the time and date through the System Setup.
2. Turn off the sled using the operating system commands or the CMC.
3. Remove the sled from the enclosure for at least one hour.
4. Install the sled in the enclosure.
5. Turn on the sled.
6. Enter the System Setup.

If the date and time are not correct in the System Setup, replace the battery. If the problem is not resolved by replacing the battery, see the Getting help section.

 **NOTE:** If the sled is turned off for long periods of time (for weeks or months), the NVRAM may lose its system configuration information. This situation is caused by a defective battery.

 **NOTE:** Some software may cause the sled's time to speed up or slow down. If the sled operates normally except for the time maintained by the System Setup, the problem may be caused by a software rather than by a defective battery.

Related Links

[Getting help](#)

Getting help

Contacting Dell

Dell provides several online and telephone-based support and service options. If you do not have an active internet connection, you can find contact information about your purchase invoice, packing slip, bill, or Dell product catalog. Availability varies by country and product, and some services may not be available in your area. To contact Dell for sales, technical assistance, or customer-service issues:

1. Go to **Dell.com/support**.
2. Select your country from the drop-down menu on the lower right corner of the page.
3. For customized support:
 - a. Enter your system Service Tag in the **Enter your Service Tag** field.
 - b. Click **Submit**.
The support page that lists the various support categories is displayed.
4. For general support:
 - a. Select your product category.
 - b. Select your product segment.
 - c. Select your product.
The support page that lists the various support categories is displayed.
5. For contact details of Dell Global Technical Support:
 - a. Click [Global Technical Support](#).
 - b. The **Contact Technical Support** page is displayed with details to call, chat, or e-mail the Dell Global Technical Support team.

Accessing system information by using QRL

You can use the Quick Resource Locator (QRL) to get immediate access to the information about your system.

Prerequisites

Ensure that your smartphone or tablet has the QR code scanner installed.

The QRL includes the following information about your system:

About this task

- How-to videos
- Reference materials, including the Owner's Manual, LCD diagnostics, and mechanical overview
- Your system service tag to quickly access your specific hardware configuration and warranty information
- A direct link to Dell to contact technical assistance and sales teams

Steps

1. Go to **Dell.com/QRL** and navigate to your specific product or
2. Use your smartphone or tablet to scan the model-specific Quick Resource (QR) code on your Dell PowerEdge system or in the Quick Resource Locator section.

Quick Resource Locator

Use the Quick Resource Locator (QRL) to get immediate access to system information and how-to videos. This can be done by visiting **dell.com/QRL** or by using your smartphone and a model specific Quick Resource (QR) code located on your Dell PowerEdge system. To try out the QR code, scan the following image.



Figure 76. QRL code