

How to Install Your New Light

Please check that you received all of the components pictured in this guide. Reach out to us if anything is missing. It's very rare, but it happens. Don't forget to turn off the electrical power source.

You won't need any additional tools.

CAUTION

As a safety feature, this lamp has a polarized plug to reduce the risk of electric shock. This means it has two flat prongs and a third circular prong underneath, and it will fit in an outlet one way only. If the plug does not fit fully and easily into the outlet, do not force it; contact a qualified electrician.

ATTENTION

Par mesure de sécurité, cette lampe a une fiche polarisée pour réduire le risque de choc électrique. Cela signifie qu'il a deux broches plates et une troisième broche circulaire en dessous, et qu'il ne s'insère dans une prise que dans un seul sens. Si la fiche ne s'insère pas complètement et facilement dans la prise, ne la forcez pas; contactez un électricien qualifié.

Contents

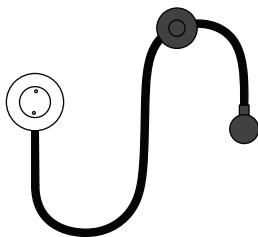

Part A
Lamp Stem

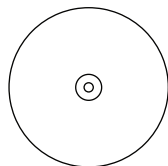

Part B
Lamp Base

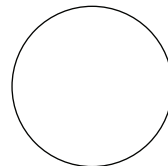

Part C
Puck A Diffuser

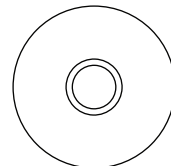

Part D
Puck B Diffuser



Part E
GU24 LED Bulb

Step 1: Attach the floor stem (A) to the floor base (B). Use your fingers to gently rotate the stem clockwise until it's fixed in place.

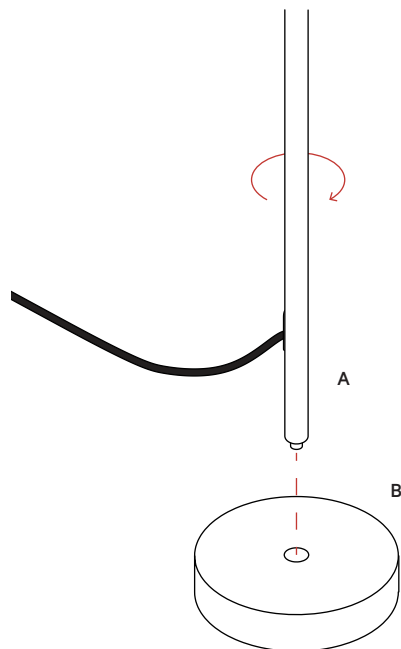

Step 2: Twist the included lightbulb (E) into the fixture socket of the lamp base (A).

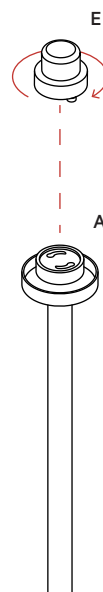

Step 3: Assemble the shade separately from the lamp base. Align puck B diffuser (D) with puck A diffuser (C) and gently screw together.

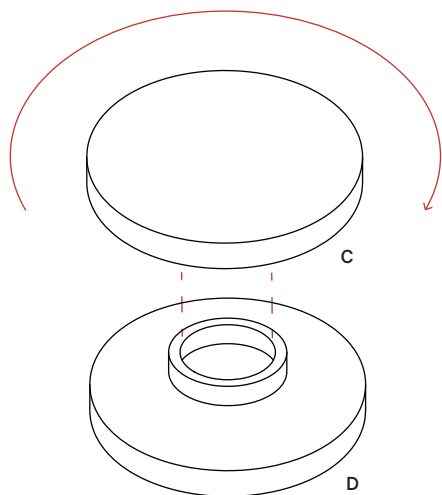

Step 4: Attach the shade assembly to lamp base by rotating clockwise until fixed in place. Plug-in and turn on the light.

