

# Ethnicraft

U-SHELF

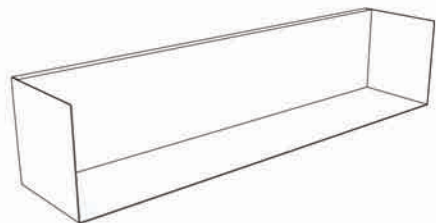

21kg  
MAXIMUM LOAD

ASSEMBLY INSTRUCTIONS

## HARDWARE (included in package)

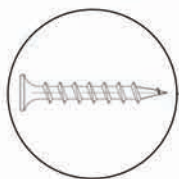

Wall screw f5x50 - 2pcs

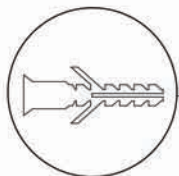

Wall plug 08x40 - 2pcs

## Tools (NOT included in package)



Screwdriver

Drill machine



Pencil



Leveler

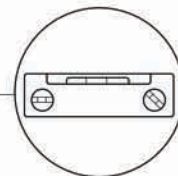

1.

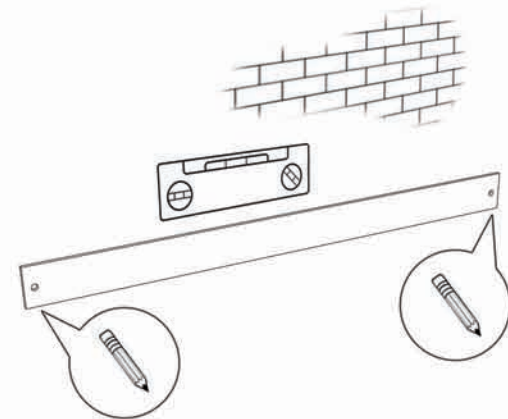

- Place the stencil on the wall and mark the position of the holes
- Use leveler to find horizontal

2.

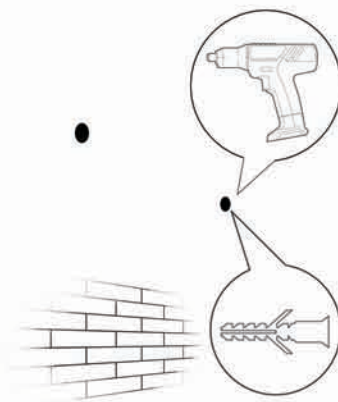

- Drill the marked holes
- Insert wall plugs

3.

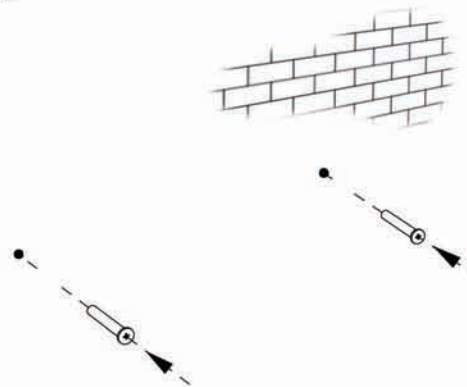

- Insert the wall screws into the wall plugs

4.

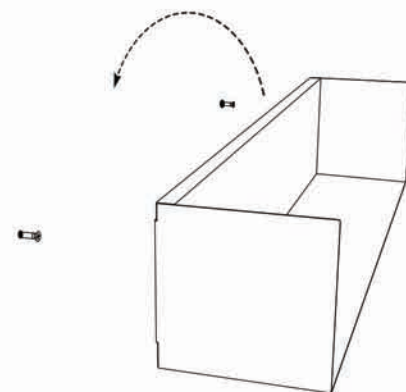

- Hang assembly on the wall screws

# Ethnicraft

U-SHELF

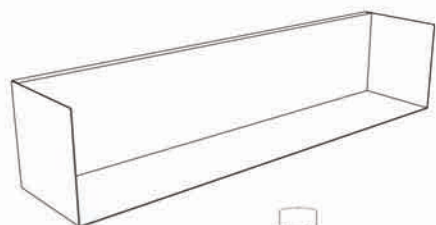

21kg  
MAXIMUM LOAD

ASSEMBLY INSTRUCTIONS