

# Service and Troubleshooting

## GMES9\*/GCES9\*/AMES9\*/ACES9\*/VMES9\*/VCES9\* SINGLE STAGE GAS FURNACES AND ACCESSORIES

This manual is to be used by qualified, professionally trained HVAC technicians only. Goodman does not assume any responsibility for property damage or personal injury due to improper service procedures or services performed by an unqualified person.

Pride and workmanship go into every product to provide our customers with quality products. It is possible, however, that during its lifetime a product may require service. Products should be serviced only by a qualified service technician who is familiar with the safety procedures required in the repair and who is equipped with the proper tools, parts, testing instruments and the appropriate service manual. **REVIEW ALL SERVICE INFORMATION IN THE APPROPRIATE SERVICE MANUAL BEFORE BEGINNING REPAIRS.**

### TABLE OF CONTENTS

IMPORTANT INFORMATION.....	2
PRODUCT IDENTIFICATION .....	4
SYSTEM OPERATION.....	7
SCHEDULED MAINTENANCE .....	28
SERVICING.....	31
ACCESSORIES .....	47
TROUBLESHOOTING CHART .....	51
WIRING DIAGRAMS.....	54



### WARNING

ONLY PERSONNEL THAT HAVE BEEN TRAINED TO INSTALL, ADJUST, SERVICE OR REPAIR (HEREINAFTER, "SERVICE") THE EQUIPMENTS SPECIFIED IN THIS MANUAL SHOULD SERVICE THE EQUIPMENT. THE MANUFACTURER WILL NOT BE RESPONSIBLE FOR ANY INJURY OR PROPERTY DAMAGE ARISING FROM IMPROPER SERVICE OR SERVICE PROCEDURES. IF YOU SERVICE THIS UNIT, YOU ASSUME RESPONSIBILITY FOR ANY INJURY OR PROPERTY DAMAGE WHICH MAY RESULT. IN ADDITION, IN JURISDICTIONS THAT REQUIRE ONE OR MORE LICENSES TO SERVICE THE EQUIPMENTS SPECIFIED IN THIS MANUAL, ONLY LICENSED PERSONNEL SHOULD SERVICE THE EQUIPMENT.

IMPROPER INSTALLATION, ADJUSTMENT, SERVICING OR REPAIR OF THE EQUIPMENT SPECIFIED IN THIS MANUAL, OR ATTEMPTING TO INSTALL, ADJUST, SERVICE OR REPAIR THE EQUIPMENTS SPECIFIED IN THIS MANUAL WITHOUT PROPER TRAINING MAY RESULT IN PRODUCT DAMAGE, PROPERTY DAMAGE, PERSONAL INJURY OR DEATH.

### PROP 65 WARNING FOR CALIFORNIA CONSUMERS



### WARNING

Cancer and Reproductive Harm -  
[www.P65Warnings.ca.gov](http://www.P65Warnings.ca.gov)

0140M00517-A

RS6612016r3  
April 2020



Copyright © 2019-2020 Goodman Manufacturing Company, L.P.

is a registered trademark of Maytag Corporation or its related companies and is used under license.  
All rights reserved.

# IMPORTANT INFORMATION

## IMPORTANT NOTICES FOR CONSUMERS AND SERVICERS RECOGNIZE SAFETY SYMBOLS, WORDS AND LABELS

Pride and workmanship go into every product to provide our customers with quality products. It is possible, however, that during its lifetime a product may require service. Products should be serviced only by a qualified service technician who is familiar with the safety procedures required in the repair and who is equipped with the proper tools, parts, testing instruments and the appropriate service manual. **REVIEW ALL SERVICE INFORMATION IN THE APPROPRIATE SERVICE MANUAL BEFORE BEGINNING REPAIRS.**

### **WARNING**

THIS UNIT SHOULD NOT BE CONNECTED TO, OR USED IN CONJUNCTION WITH, ANY DEVICES THAT ARE NOT DESIGN CERTIFIED FOR USE WITH THIS UNIT OR HAVE NOT BEEN TESTED AND APPROVED BY THE MANUFACTURER. SERIOUS PROPERTY DAMAGE OR PERSONAL INJURY, REDUCED UNIT PERFORMANCE AND/OR HAZARDOUS CONDITIONS MAY RESULT FROM THE USE OF DEVICES THAT HAVE NOT BEEN APPROVED OR CERTIFIED BY THE MANUFACTURER.

### **WARNING**

TO PREVENT THE RISK OF PROPERTY DAMAGE, PERSONAL INJURY, OR DEATH, DO NOT STORE COMBUSTIBLE MATERIALS OR USE GASOLINE OR OTHER FLAMMABLE LIQUIDS OR VAPORS IN THE VICINITY OF THIS APPLIANCE.

### **WARNING**

**HIGH VOLTAGE**  
DISCONNECT ALL POWER BEFORE SERVICING OR INSTALLING THIS UNIT. MULTIPLE POWER SOURCES MAY BE PRESENT. FAILURE TO DO SO MAY CAUSE PROPERTY DAMAGE, PERSONAL INJURY OR DEATH.

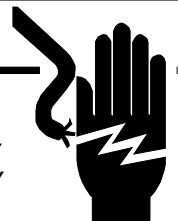

OUTSIDE THE U.S., call 1-713-861-2500.  
(Not a technical assistance line for dealers.) Your telephone company will bill you for the call.

# IMPORTANT INFORMATION



## WARNING

IF THE INFORMATION IN THESE INSTRUCTIONS IS NOT FOLLOWED EXACTLY, A FIRE OR EXPLOSION MAY RESULT CAUSING PROPERTY DAMAGE, PERSONAL INJURY OR LOSS OF LIFE.

- DO NOT STORE OR USE GASOLINE OR OTHER FLAMMABLE VAPORS AND LIQUIDS IN THE VICINITY OF THIS OR ANY OTHER APPLIANCE.
- **WHAT TO DO IF YOU SMELL GAS:**
  - DO NOT TRY TO LIGHT ANY APPLIANCE.
  - DO NOT TOUCH ANY ELECTRICAL SWITCH; DO NOT USE ANY PHONE IN YOUR BUILDING.
  - IMMEDIATELY CALL YOUR GAS SUPPLIER FROM A NEIGHBOR'S PHONE. FOLLOW THE GAS SUPPLIER'S INSTRUCTIONS.
  - IF YOU CANNOT REACH YOUR GAS SUPPLIER, CALL THE FIRE DEPARTMENT.
- INSTALLATION AND SERVICE MUST BE PERFORMED BY A QUALIFIED INSTALLER, SERVICE AGENCY OR THE GAS SUPPLIER.



## WARNING

SHOULD OVERHEATING OCCUR OR THE GAS SUPPLY FAIL TO SHUT OFF, TURN OFF THE MANUAL GAS SHUTOFF VALVE EXTERNAL TO THE FURNACE BEFORE TURNING OFF THE ELECTRICAL SUPPLY.



## DANGER PELIGRO



### CARBON MONOXIDE POISONING HAZARD

Special Warning for Installation of Furnace or Air Handling Units in Enclosed Areas such as Garages, Utility Rooms or Parking Areas

Carbon monoxide producing devices (such as an automobile, space heater, gas water heater, etc.) should not be operated in enclosed areas such as unventilated garages, utility rooms or parking areas because of the danger of carbon monoxide (CO) poisoning resulting from the exhaust emissions. If a furnace or air handler is installed in an enclosed area such as a garage, utility room or parking area and a carbon monoxide producing device is operated therein, there must be adequate, direct outside ventilation.

This ventilation is necessary to avoid the danger of CO poisoning which can occur if a carbon monoxide producing device continues to operate in the enclosed area. Carbon monoxide emissions can be (re)circulated throughout the structure if the furnace or air handler is operating in any mode.

CO can cause serious illness including permanent brain damage or death.

B10259-216

### RIESGO DE INTOXICACIÓN POR MONÓXIDO DE CARBONO

Advertencia especial para la instalación de calentadores ó manejadoras de aire en áreas cerradas como estacionamientos ó cuartos de servicio.

Los equipos ó aparatos que producen monóxido de carbono (tal como automóvil, calentador de gas, calentador de agua por medio de gas, etc) no deben ser operados en áreas cerradas debido al riesgo de envenenamiento por monóxido de carbono (CO) que resulta de las emisiones de gases de combustión. Si el equipo ó aparato se opera en dichas áreas, debe existir una adecuada ventilación directa al exterior. Esta ventilación es necesaria para evitar el peligro de envenenamiento por CO, que puede ocurrir si un dispositivo que produce monóxido de carbono sigue operando en el lugar cerrado.

Las emisiones de monóxido de carbono pueden circular a través del aparato cuando se opera en cualquier modo.

El monóxido de carbono puede causar enfermedades severas como daño cerebral permanente ó muerte.

B10259-216

### RISQUE D'EMPOISONNEMENT AU MONOXYDE DE CARBONE

Avertissement special au sujet de l'installation d'appareils de chauffage ou de traitement d'air dans des endroits clos, tels les garages, les locaux d'entretien et les stationnements.

Evitez de mettre en marche les appareils produisant du monoxyde de carbone (tels que les automobile, les appareils de chauffage autonome, etc.) dans des endroits non ventilés tels que les d'empoisonnement au monoxyde de carbone. Si vous devez faire fonctionner ces appareils dans un endroit clos, assurez-vous qu'il y ait une ventilation directe provenant de l'exterieur.

Cette ventilation est nécessaire pour éviter le danger d'intoxication au CO pouvant survenir si un appareil produisant du monoxyde de carbone continue de fonctionner au sein de la zone confinée.

Les émissions de monoxyde de carbone peuvent être recirculés dans les endroits clos, si l'appareil de chauffage ou de traitement d'air sont en marche.

Le monoxyde de carbone peut causer des maladies graves telles que des dommages permanents au cerveau et même la mort.

B10259-216

# PRODUCT IDENTIFICATION

# NOMENCLATURE

The model and manufacturing number are used for positive identification of component parts used in manufacturing. Please use these numbers when requesting service or parts information.

Furnace Nomenclature															
	*	M	E	S	9	6	0	6	0	3	B	N	A	A	
	1	2	3	4	5	6	7	8	9	10	11	12	13	14	
<b>Brand</b>															<b>Minor Revision</b>
A- Amana® G- Goodman®															A - Initial Release
V- GMC®															B - 1st Revision
<b>Configuration</b>															<b>Major Revision</b>
M - Upflow/Horizontal															A - Initial Release
C - Downflow/Horizontal															B - 1st Revision
<b>Airflow</b>															<b>Nox</b>
C - Variable Speed/ComfortNet															N - Natural Gas
E - High Efficiency Multi Speed															X - Low Nox
S - Single Speed															
<b>Gas Valve Stages</b>															<b>Cabinet Width</b>
M - Modulating															A - 14"
V - 2 Stage															B - 17.5"
S - Single Stage															C - 21"
															D - 24.5"
<b>AFUE</b>															<b>Maximum CFM</b>
97 - 97% AFUE															3 - 1200 CFM
80 - 80% AFUE															4 - 1600 CFM
92 - 92% AFUE															5 - 2000 CFM
80 - 80% AFUE															
<b>MBTU/h</b>															
040 - 40,000															
060 - 60,000															
080 - 80,000															

# PRODUCT IDENTIFICATION

MODEL #	MFG#	DESCRIPTION
GMES92	GMES920403ANAA	<p><b><u>Goodman® Brand 92% Single Stage Gas Furnace.</u></b> 34.5" tall, Upflow/Horizontal Installation, 1-stage gas valve induced draft. Multispeed ECM motor. 120-volt silicon carbide 17-second hot surface ignition. Left or right gas pipe entry. The furnace also features an aluminized steel tubular heat exchanger. Available cabinet widths are 14", 17.5", 21", and 24.5" wide.</p>
	GMES920603BNAA	
	GMES920803BNAA	
	GMES920804CNAA	
	GMES920805CNAA	
	GMES921004CNAA	
	GMES921005CNAA	
GMES921205DNAA		
GMES96	GMES960403ANAA	<p><b><u>Goodman® Brand 96% Single Stage Gas Furnace.</u></b> 34.5" tall, Upflow/Horizontal Installation, 1-stage gas valve induced draft. Multispeed ECM motor. 120 volt silicon carbide 17-second hot surface ignition. Left or right gas pipe entry. The furnace also features an aluminized steel tubular heat exchanger. Available cabinet widths are 14", 17.5" ,21" and 24.5" wide.</p>
	GMES960603BNAA	
	GMES960803BNAA	
	GMES960804CNAA	
	GMES960805CNAA	
	GMES961005CNAA	
	GMES961205DNAA	
GCES96	GCES960403BNAA	<p><b><u>Goodman® Brand 96% Single Stage Gas Furnace.</u></b> 34.5" tall, Downflow/Horizontal Installation, 1-stage gas valve induced draft. Multispeed motor. 120-volt silicon carbide 17-second hot surface ignition. Left or right gas pipe entry. The furnace also features an aluminized steel tubular heat exchanger. Available cabinet widths are 17.5", 21" and 24.5 " wide.</p>
	GCES960603BNAA	
	GCES960804CNAA	
	GCES961005CNAA	
	GCES961205DNAA	
VMES96	VMES960403ANAA	<p><b><u>GMC® Brand 96% Single Stage Gas Furnace.</u></b> 34.5" tall, Upflow/Horizontal Installation, 1-stage gas valve induced draft. Multispeed motor. 120-volt silicon carbide 17-second hot surface ignition. Left or right gas pipe entry. The furnace also features an aluminized steel tubular heat exchanger. Available cabinet widths are 17.5", and 21" wide.</p>
	VMES960603BNAA	
	VMES960803BNAA	
	VMES960804CNAA	
	VMES961005CNAA	
VCES96	VCES960403BNAA	<p><b><u>GMC® Brand 96% Single Stage Gas Furnace.</u></b> 34.5" tall, Downflow/Horizontal Installation, 1-stage gas valve induced draft. Multispeed ECM motor. 120-volt silicon carbide 17-second hot surface ignition. Left or right gas pipe entry. The furnace also features an aluminized steel tubular heat exchanger. Available cabinet widths are 17.5", and 21" wide.</p>
	VCES960603BNAA	
	VCES960804CNAA	
	VCES961005CNAA	

# PRODUCT IDENTIFICATION

MODEL #	MFG#	DESCRIPTION
<b>AMES92</b>	AMES920403ANAA	<p><b><u>Amana® Brand 92% Single Stage Gas Furnace.</u></b> Upflow/Horizontal Installation, 34.5" tall, 1-stage gas valve induced draft. Multispeed ECM motor. 120-volt silicon carbide 17-second hot surface ignition. Left or right gas pipe entry. The furnace also features a stainless steel tubular heat exchanger. Available cabinet widths are 14", 17.5", 21", and 24.5" wide.</p>
	AMES920603BNAA	
	AMES920803BNAA	
	AMES920804CNAA	
	AMES920805CNAA	
	AMES921004CNAA	
	AMES921005CNAA	
AMES921205DNAA		
<b>AMES96</b>	AMES960403ANAA	<p><b><u>Amana® Brand 96% Single Stage Gas Furnace.</u></b> Upflow/Horizontal Installation, 34.5" tall, 1-stage gas valve induced draft. Multispeed ECM motor. 120-volt silicon carbide 17-second hot surface ignition. Left or right gas pipe entry. The furnace also features a stainless steel tubular heat exchanger. Available cabinet widths are 14", 17.5", 21" &amp; 24.5" wide.</p>
	AMES960603BNAA	
	AMES960803BNAA	
	AMES960804CNAA	
	AMES960805CNAA	
	AMES961005CNAA	
	AMES961205DNAA	
<b>ACES96</b>	ACES960403BNAA	<p><b><u>Amana® Brand 96% Single Stage Gas Furnace.</u></b> Downflow/Horizontal Installation, 34.5" tall, 1-stage gas valve induced draft. Multispeed ECM motor. 120- volt silicon carbide 17-second hot surface ignition. Left or right gas pipe entry. The furnace also features a stainless steel tubular heat exchanger. Available cabinet widths are 17.5", 21", and 24.5" wide.</p>
	ACES960603BNAA	
	ACES960804CNAA	
	ACES961005CNAA	
	ACES961205DNAA	

# SYSTEM OPERATION

## Safety

Please adhere to the following warnings and cautions when installing, adjusting, altering, servicing, or operating the furnace.

 <b>WARNING</b>
<b>TO PREVENT PERSONAL INJURY OR DEATH DUE TO IMPROPER INSTALLATION, ADJUSTMENT, ALTERATION, SERVICE OR MAINTENANCE, REFER TO THIS MANUAL. FOR ADDITIONAL ASSISTANCE OR INFORMATION, CONSULT A QUALIFIED INSTALLER, SERVICE AGENCY OR THE GAS SUPPLIER.</b>

 <b>WARNING</b>
<b>THIS PRODUCT CONTAINS OR PRODUCES A CHEMICAL OR CHEMICALS WHICH MAY CAUSE SERIOUS ILLNESS OR DEATH AND WHICH ARE KNOWN TO THE STATE OF CALIFORNIA TO CAUSE CANCER, BIRTH DEFECTS OR OTHER REPRODUCTIVE HARM.</b>

 <b>WARNING</b>
<b>TO PREVENT POSSIBLE PROPERTY DAMAGE, PERSONAL INJURY OR DEATH DUE TO ELECTRICAL SHOCK, THE FURNACE MUST BE LOCATED TO PROTECT THE ELECTRICAL COMPONENTS FROM WATER.</b>

## Charge (ESD) Precautions

**NOTE:** Discharge body's static electricity before touching unit. An electrostatic discharge can adversely affect electrical components.

Use the following precautions during furnace installation and servicing to protect the integrated control module from damage. By putting the furnace, the control, and the person at the same electrostatic potential, these steps will help avoid exposing the integrated control module to electrostatic discharge. This procedure is applicable to both installed and uninstalled (ungrounded) furnaces.

1. Disconnect all power to the furnace. Do not touch the integrated control module or any wire connected to the control prior to discharging your body's electrostatic charge to ground.
2. Firmly touch a clean, unpainted, metal surface of the furnace near the control. Any tools held in a person's hand during grounding will be discharged.
3. Service integrated control module or connecting wiring following the discharge process in Step 2. Use caution not to recharge your body with static electricity; (i.e., do not move or shuffle your feet, do not touch ungrounded objects, etc.). If you come in contact with an ungrounded object, repeat Step 2 before touching control or wires.
4. Discharge any static electricity from your body to ground before removing a new control from its container. Follow Steps 1 through 3 if installing the control on a furnace. Return any old or new controls to their containers before touching any ungrounded object.

## Product Application

This product is designed for use as a residential home gas furnace. It is **not** designed or certified for use in mobile home, trailer, or recreational vehicle applications.

In the U.S.A., this furnace can be used in the following non-industrial commercial applications: Schools, Office buildings, Churches, Retail stores, Nursing homes, Hotels/motels, Common or office areas. In all applications, the furnace must be installed per the installation instructions.

Goodman® brand G\*ES9\* and Amana® brand A\*ES9\* furnaces are ETL certified. All furnaces are built for use with Natural gas but can be converted for use with LP gas.

**(NOTE:** If using propane gas, a propane conversion kit is required).

Goodman® brand G\*ES9\* and Amana® brand A\*ES9\* high efficiency furnaces are dual certified. Dual certification means that the combustion air inlet pipe is optional and the furnace can be vented as a:

- Non-direct vent (single pipe) central forced air furnace in which combustion air is taken from the installation area or from air ducted from the outside or,
- Direct vent (dual pipe) central forced air furnace in which all combustion air supplied directly to the furnace burners through a special air intake system outlined in this manual and the installation instructions.

To ensure proper installation, operation and servicing, thoroughly read the installation and service manuals for specifics pertaining to the installation, servicing and application of this product.

 <b>WARNING</b>
<b>POSSIBLE PROPERTY DAMAGE, PERSONAL INJURY OR DEATH DUE TO FIRE, EXPLOSION, SMOKE, SOOT, CONDENSTAIION, ELECTRICAL SHOCK OR CARBON MONOXIDE MAY RESULT FROM IMPROPER INSTALLATION, REPAIR, OPERATION, OR MAINTENANCE OF THIS PRODUCT.</b>

 <b>WARNING</b>
<b>TO PREVENT PROPERTY DAMAGE, PERSONAL INJURY OR DEATH DUE TO FIRE, DO NOT INSTALL THIS FURNACE IN A MOBILE HOME, TRAILER, OR RECREATIONAL VEHICLE.</b>

To ensure proper furnace operation, install, operate, maintain and service the furnace in accordance with the installation, operation and service instructions, all local building codes and ordinances. In their absence, follow the latest edition of the National Fuel Gas Code (NFPA 54/ANSI Z223.1), and/or CAN/CGA B149 Installation Codes, local plumbing or waste water codes, and other applicable codes.

A copy of the National Fuel Gas Code (NFPA 54/ANSI Z223.1) can be obtained from any of the following:

# SYSTEM OPERATION

American National Standards Institute  
25 West 43<sup>rd</sup> Street, 4<sup>th</sup> Floor  
New York, NY 10036

National Fire Protection Association  
1 Batterymarch Park  
Quincy, MA 02169-7471

CSA International  
8501 East Pleasant Valley  
Cleveland, OH 44131

A copy of the CAN/CGA B149 Installation Codes can be obtained from:

CSA International  
178 Rexdale Boulevard  
Etobicoke, Ontario, Canada M9W, 1R3

The rated heating capacity of the furnace should be greater than or equal to the total heat loss of the area to be heated. The total heat loss should be calculated by an approved method or in accordance with “ASHRAE Guide” or “Manual J-Load Calculations” published by the Air Conditioning Contractors of America.

## Location Requirements and Considerations



### WARNING

**TO PREVENT POSSIBLE EQUIPMENT DAMAGE, PROPERTY DAMAGE, PERSONAL INJURY OR DEATH, THE FOLLOWING BULLET POINTS MUST BE OBSERVED WHEN INSTALLING THE UNIT.**

Follow the instructions listed below when selecting a furnace location. Refer also to the guidelines provided in the *Combustion and Ventilation Air Requirements* section in this manual or the installation instructions for details.

- Centrally locate the furnace with respect to the proposed or existing air distribution system.
- Ensure the temperature of the return air entering the furnace is between 55°F and 100°F when the furnace is heating.
- If the furnace is installed in an application where the typical operating sound level of a furnace is deemed objectionable, an optional sound reduction kit is available. Consult your local distributor for more details.
- Provide provisions for venting combustion products outdoors through a proper venting system. Special consideration should be given to vent/flue pipe routing and combustion air intake pipe when applicable.
- **90% Furnaces:** Refer to the *Vent/Flue Pipe and Combustion Air Pipe -Termination Locations* section in this manual or the installation instructions for appropriate termination locations. Also for 90% furnaces, refer to the *Vent/Flue Pipe and Combustion Air Pipe -Termination Locations* section in this manual or the installation

instructions to determine if the piping system from furnace to termination can be accomplished within the guidelines given. **NOTE:** The length of flue and/or combustion air piping can be a limiting factor in the location of the furnace.

- Locate the 90% furnace so that the condensate can be piped at a downward slope away from the furnace to the drain. Do not locate the furnace or its condensate drainage system in any area subject to below freezing temperatures without proper freeze protection. Refer to the *Condensate Drain Lines and Trap* section in this manual or the installation instructions for further details.
- Set the 90% furnace on a level floor to enable proper condensate drainage. If the floor becomes wet or damp at times, place the furnace above the floor on a concrete base sized approximately 1-1/2” larger than the base of the furnace. Refer to the *Horizontal Applications and Considerations* section in this manual or the installation instructions for leveling of horizontal furnaces.
- Ensure upflow or horizontal furnaces are not installed directly on carpeting, or any other combustible material. The only combustible material allowed is wood.
- A special accessory subbase must be used for upright counterflow unit installations over any combustible material (including wood). Refer to subbase instructions for installation details. (**NOTE:** A subbase will not be required if an air conditioning coil is located beneath the furnace between the supply air opening and the combustible floor.
- Exposure to contaminated combustion air will result in safety and performance-related problems. Do not install the furnace where the combustion air is exposed to the following substances:
  - chlorinated waxes or cleaners
  - chlorine-based swimming pool chemicals
  - water softening chemicals
  - deicing salts or chemicals
  - carbon tetrachloride
  - halogen type refrigerants
  - cleaning solutions (such as perchloroethylene)
  - printing inks
  - paint removers
  - varnishes
  - hydrochloric acid
  - cements and glues
  - antistatic fabric softeners for clothes dryers
  - and masonry acid washing materials
- Isolate a nondirect furnace from an area contaminated by any of the above substances. This protects the *non-direct vent* furnace from airborne contaminants. To ensure that the enclosed *non-direct vent* furnace has an adequate supply of combustion air, vent from a nearby uncontaminated room or from outdoors. Refer to the



# SYSTEM OPERATION

*Combustion and Ventilation Air Requirements* section in this manual or the installation instructions for details.

- If the furnace is used in connection with a cooling unit, install the furnace upstream or in parallel with the cooling unit coil. Premature heat exchanger failure will result if the cooling unit coil is placed ahead of the furnace.
- If the furnace is installed in a residential garage, position the furnace so that the burners and ignition source are located not less than 18 inches (457 mm) above the floor. Protect the furnace from physical damage by vehicles.
- If the furnace is installed horizontally, the furnace access doors must be vertical so that the burners fire horizontally into the heat exchanger. Do not install the unit with the access doors on the “up/top” or “down/bottom” side of the furnace.

## Clearances and Accessibility

Installations must adhere to the clearances to combustible materials to which this furnace has been design certified. The minimum clearance information for this furnace is provided on the unit's clearance label. These clearances must be permanently maintained. Refer to Specification Sheet for minimum clearances to combustible materials. Clearances must also accommodate an installation's gas, electrical, and drain trap and drain line connections. If the alternate combustion air intake or vent/flue connections are used on a 90% furnace, additional clearances must be provided to accommodate these connections. Refer to *Vent Flue Pipe and Combustion Air Pipe* section in this manual or the installation instructions for details. **NOTE:** In addition to the required clearances to combustible materials, a minimum of 24 inches service clearance must be available in front of the unit.

A furnace installed in a confined space (i.e., a closet or utility room) must have two ventilation openings with a total minimum free area of 0.25 square inches per 1,000 BTU/hr of furnace input rating. One of the ventilation openings must be within 12 inches of the top; the other opening must be within 12 inches of the bottom of the confined space. In a typical construction, the clearance between the door and door frame is usually adequate to satisfy this ventilation requirement.

## Furnace Suspension

If suspending the furnace from rafters or joist, use 3/8" threaded rod and 2"x2"x1/8" angle iron as shown in the following figure. If the furnace is installed in a crawl space it must also be suspended from the floor joist or supported by a concrete pad. Never install the furnace on the ground or allow it to be exposed to water. The length of rod will depend on the application and the clearances necessary.

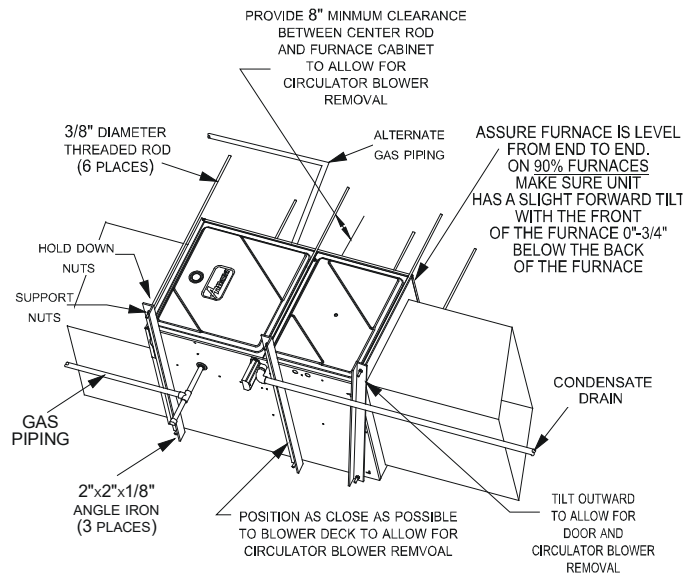

90% Suspended Furnace Shown

## **EXISTING FURNACE REMOVAL**

**NOTE:** When an existing furnace is removed from a venting system serving other appliances, the venting system may be too large to properly vent the remaining attached appliances.

The following vent testing procedure is reproduced from the **American National Standard/National Standard of Canada for Gas-Fired Central Furnaces ANSI Z21.47, latest edition, CSA-2.3b, latest edition Section 1.23.1.**

The following steps shall be followed with each appliance connected to the venting system placed in operation, while any other appliances connected to the venting system are not in operation:

- a. Seal any unused openings in the venting system;
- b. Inspect the venting system for proper size and horizontal pitch, as required by the National Fuel Gas Code, ANSI Z223.1 or the CSA B149 Installation Codes and these instructions. Determine that there is no blockage or restriction, leakage, corrosion and other deficiencies which could cause an unsafe condition;
- c. In so far as practical, close all building doors and windows and all doors between the space in which the appliance(s) connected to the venting system are located and other spaces of the building. Turn on clothes dryers and any appliance not connected to the venting system. Turn on any exhaust fans, such as range hoods and bathroom exhausts, so they shall operate at maximum speed. Do not operate a summer exhaust fan. Close fireplace dampers;
- d. Follow the lighting instructions. Place the appliance being inspected in operation. Adjust thermostat so appliance shall operate continuously;
- e. Test for draft hood equipped spillage at the draft hood relief opening after 5 minutes of main burner operation. Use the flame of a match or candle;
- f. After it has been determined that each appliance connected to the venting system properly vents when tested as outlined above, return doors, windows, exhaust fans, fireplace dampers and any other gas burning appliance to their previous conditions of use;
- g. If improper venting is observed during any of the above tests, the common venting system must be corrected.

# SYSTEM OPERATION

Corrections must be in accordance with the latest edition of the National Fuel Gas Code NFPA 54/ANSI Z223.1 and/or CSA B149 Installation Codes.

If resizing is required on any portion of the venting system, use the appropriate table in Appendix G in the latest edition of the National Fuel Gas Code ANSI Z223.1 and/or CSA B149 *Installation Codes*.

## Thermostat Requirements

A high quality single stage thermostat with a “C” terminal is recommended to control the G\*ES9\* and A\*ES9\* furnace.

## Thermostat Location

In an area having good air circulation, locate the thermostat about five feet high on a vibration-free inside wall. Do not install the thermostat where it may be influenced by any of the following:

- Drafts, or dead spots behind doors, in corners, or under cabinets.
- Hot or cold air from registers.
- Radiant heat from the sun.
- Light fixtures or other appliances.
- Radiant heat from a fireplace.
- Concealed hot or cold water pipes, or chimneys.
- Unconditioned areas behind the thermostat and dehumidistat, such as an outside wall.

## COMBUSTION AND VENTILATION AIR REQUIREMENTS



### WARNING

POSSIBLE PROPERTY DAMAGE, PERSONAL INJURY OR DEATH MAY OCCUR IF THE FURNACE IS NOT PROVIDED WITH ENOUGH FRESH AIR FOR PROPER COMBUSTION AND VENTILATION OF FLUE GASES. MOST HOMES REQUIRE OUTSIDE AIR BE SUPPLIED TO THE FURNACE AREA.

Improved construction and additional insulation in buildings have reduced heat loss by reducing air infiltration and escape around doors and windows. These changes have helped in reducing heating/cooling costs but have created a problem supplying combustion and ventilation air for gas fired and other fuel burning appliances. Appliances that pull air out of the house (clothes dryers, exhaust fans, fireplaces, etc.) increase the problem by starving appliances for air.

When the furnace is installed as a direct vent (2-pipe) furnace, no special provisions for air for combustion are required. However, if this furnace is to be installed in the same space with other gas appliances, such as a water heater, ensure there is an adequate supply of combustion and ventilation air for the other appliances. Refer to the latest edition of the National Fuel Gas Code NFPA 54/ANSI Z223.1 (Section 9.3), or CAN/CGA B149 Installation Codes (Sections 7.2, 7.3, or 7.4), or applicable provisions of the local building codes for determining the combustion air requirements for the appliances.

Most homes will require outside air be supplied to the furnace area by means of ventilation grilles or ducts connecting directly to the outdoors or spaces open to the outdoors such as attics or crawl spaces.

The following information on air for combustion and ventilation is reproduced from the **National Fuel Gas Code NFPA 54/ANSI Z223.1 Section 9.3.**

### 9.3\* Air for Combustion and Ventilation.

#### 9.3.1 General.

**9.3.1.1** Air for combustion, ventilation, and dilution of flue gases for appliances installed in buildings shall be obtained by application of one of the methods covered in 9.3.2 through 9.3.6. Where the requirements of 9.3.2 are not met, outdoor air shall be introduced in accordance with methods covered in 9.3.3 through 9.3.6.

*Exception No. 1: This provision shall not apply to direct vent appliances.*

**9.3.1.2** Appliances of other than natural draft design and other than Category 1 vented appliances shall be provided with combustion, ventilation, and dilution air in accordance with the appliance manufacturer's instructions.

**9.3.1.3** Appliances shall be located so as not to interfere with proper circulation of combustion, ventilation, and dilution air.

**9.3.1.4** Where used, a draft hood or a barometric draft regulator shall be installed in the same room or enclosure as the appliance served so as to prevent any difference in pressure between the hood or regulator and the combustion air supply.

**9.3.1.5** Makeup air requirements for the operation of exhaust fans, kitchen ventilation systems, clothes dryers, and fireplaces shall be considered in determining the adequacy of a space to provide combustion air requirements.

**9.3.2 Indoor Combustion Air.** The required volume of indoor air shall be determined in accordance with the method in 9.3.2.1 or 9.3.2.2 except that where the air infiltration rate is known to be less than 0.40 ACH, the method in 9.3.2.2 shall be used. The total required volume shall be the sum of the required volume calculated for all appliances located within the space. Rooms communicating directly with the space in which the appliances are installed through openings not furnished with doors, and through combustion air openings sized and located in accordance with 9.3.2.3, are considered a part of the required volume.

**9.3.2.1\* Standard Method.** The minimum required volume shall be 50 ft<sup>3</sup> per 1,000/Btu/hour (4.8m<sup>3</sup>/kW).

# SYSTEM OPERATION

**9.3.2.2\* Known Air Infiltration Rate Method.** Where the air infiltration rate of a structure is known, the minimum required volume shall be determined as follows:

- (1) For appliances other than fan-assisted, calculate using the following equation:

$$\text{Required Volume}_{\text{other}} \geq \frac{21 \text{ ft}^3}{ACH} \frac{I_{\text{other}}}{1000 \text{ Btu/hr}}$$

- (2) For fan-assisted appliances, calculate using the following equation:

$$\text{Required Volume}_{\text{fan}} \geq \frac{15 \text{ ft}^3}{ACH} \frac{I_{\text{fan}}}{1000 \text{ Btu/hr}}$$

where:

$I_{\text{other}}$  = all appliances other than fan-assisted input in Btu per hour

$I_{\text{fan}}$  = fan-assisted appliances input in Btu per hour

$ACH$  = air change per hour (percent of volume of space exchanged per hour, expressed as a decimal)

- (3) For purposes of this calculation, an infiltration rate greater than 0.60  $ACH$  shall not be used in the equations in 9.3.2.2(1) and 9.3.2.2(2).

**9.3.2.3 Indoor Opening Size and Location.** Openings used to connect indoor spaces shall be sized and located in accordance with the following:

- (1)\* *Combining spaces on the same story.* Each opening shall have a minimum free area of 1 in.<sup>2</sup>/1000Btu/hr (2200 mm<sup>2</sup>/kW) of the total input rating of all appliances in the space but not less than 100 in.<sup>2</sup> (0.60m<sup>2</sup>). One opening shall commence within 12 in. (300 mm) of the top, and one opening shall commence within 12 in. (300 mm) of the bottom, of the enclosure [see Figure A.9.3.2.3(1)]. The minimum dimension of air openings shall be not less than 3 in. (80 mm).

**NOTE:** Each opening must have a free area of not less than one square inch per 1000 BTU of the total input rating of all equipment in the enclosure, but not less than 100 square inches.

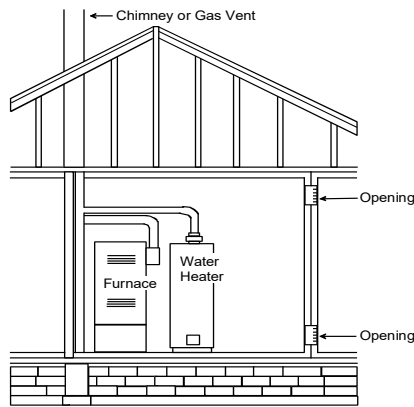

**Figure A.9.2.3.3(1) All Combustion Air from Adjacent Indoor Spaces through Indoor Combustion Air Openings.**

- (2) *Combining spaces in different stories.* The volumes of spaces in different stories shall be considered as communicating spaces where such spaces are connected by one or more openings in doors or floors having a total minimum free area of 2 in.<sup>2</sup>/1000 Btu/hr (4400 mm<sup>2</sup>/kW) of total input rating of all appliances.

**9.3.3 Outdoor Combustion Air.** Outdoor combustion air shall be provided through opening(s) to the outdoors in accordance with the methods in 9.3.3.1 or 9.3.3.2. The minimum dimension of air openings shall not be less than 3 in. (80 mm).

**9.3.3.1 Two Permanent Openings Method.** Two permanent openings, one commencing within 12 in. (300 mm) of the top and one commencing within 12 in. (300 mm) of the bottom, of the enclosure shall be provided. The openings shall communicate directly, or by ducts, with the outdoors or spaces that freely communicate with the outdoors, as follows:

- (1)\* Where directly communicating with the outdoors or where communicating to the outdoors through vertical ducts, each opening shall have a minimum free area of 1 in.<sup>2</sup>/4000 Btu/hr (550 min<sup>2</sup>/kW) of total input rating of all appliances in the enclosure. [See Figure A.9.3.3.1(1)(a) and Figure A.9.3.3.1(1)(b).]

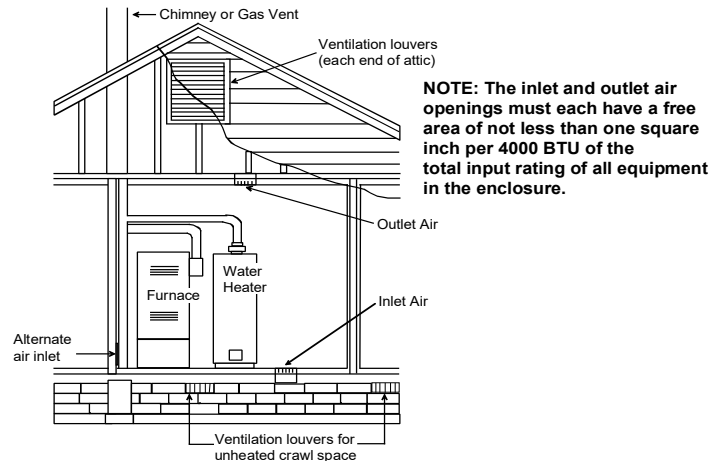

**Figure A.9.3.3.1(1)(a) All Combustion Air From Outdoors - Inlet Air from Ventilated Crawl Space and Outlet Air to Ventilated Attic.**

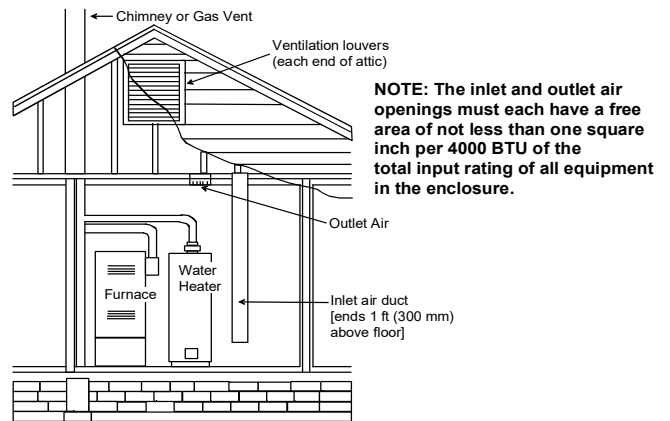

**Figure A.9.3.3.1(1)(b) All Combustion Air From Outdoors through Ventilated Attic.**

- (2)\* Where communicating with the outdoors through horizontal ducts, each opening shall have a minimum free area of 1 in.<sup>2</sup>/2000 Btu/hr (1100 min<sup>2</sup>/kW) of total input rating of all appliances in the enclosure. [See Figure A.9.3.3.1(2).]

# SYSTEM OPERATION

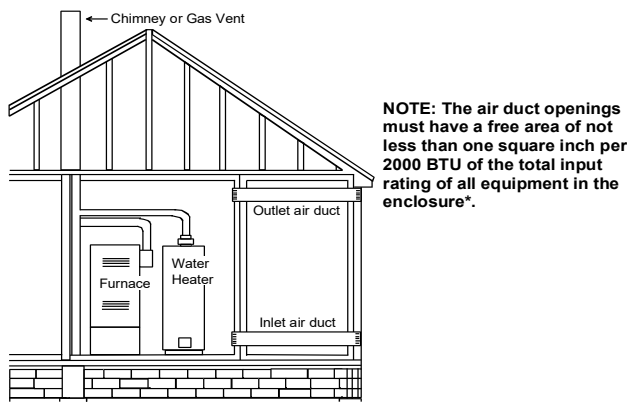
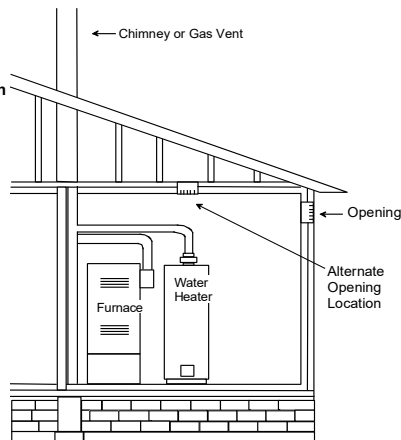

**Figure A.9.3.3.1(2) All Combustion Air From Outdoors**  
through Horizontal Ducts.

**9.3.3.2\* One Permanent Opening Method.** One permanent openings, commencing within 12 in. (300 mm) of the top of the enclosure, shall be provided. The appliance shall have clearances of at least 1 in. (25 mm) from the sides and back and 6 in. (150 mm) from the front of the appliance. The opening shall directly communicate with the outdoors or shall communicate through a vertical or horizontal duct to the outdoors or spaces that freely communicate with the outdoors (see Figure A.9.3.3.2) and shall have a minimum free area of the following:

- (1) 1 in.<sup>2</sup>/3000 Btu/hr (700 mm<sup>2</sup> per kW) of the total input rating of all appliances located in the enclosure, and
- (2) Not less than the sum of the areas of all vent connectors in the space.

**NOTE: The single opening must have a free area of not less than one square inch per 3000 BTU of the total input rating of all equipment in the enclosure, but not less than the sum of the areas of all vent connectors in the confined space.**



**Figure A.9.3.3.2 All Combustion Air**  
From Outdoors through Single Combustion Air Opening.

**9.3.4 Combination Indoor and Outdoor Combustion Air.** The use of a combination of indoor and outdoor combustion air shall be in accordance with (1) through (3) (see example calculation in Annex JJ):

- (1) **Indoor Openings:** Where used, openings connecting the interior spaces shall comply with 9.3.2.3.
- (2) **Outdoor Opening(s) Location.** Outdoor opening(s) shall be located in accordance with 9.3.3.
- (3) **Outdoor Opening(s) Size.** The outdoor opening(s) size shall be calculated in accordance with the following:
  - (a) The ratio of the interior spaces shall be the available volume of all communicating spaces divided by the required volume.
  - (b) The outdoor size reduction factor shall be 1 minus the ratio of interior spaces.

- (c) The minimum size of outdoor opening(s) shall be the full size of outdoor opening(s) calculated in accordance with 9.3.3, multiplied by the reduction factor. The minimum dimension of air openings shall not be less than 3 in. (80 mm).

**9.3.5 Engineered Installations.** Engineered combustion air installations shall provide an adequate supply of combustion, ventilation, and dilution air and shall be approved by the authority having jurisdiction.

**9.3.6 Mechanical Combustion Air Supply.** Where all combustion air is provided by a mechanical air supply system, the combustion air shall be supplied from outdoors at the minimum rate of 0.35 ft<sup>3</sup>/min per 1000 Btu/hr (0.034 m<sup>3</sup>/min per kW) for all appliances located within the space.

**9.3.6.1** Where exhaust fans are installed, additional air shall be provided to replace the exhausted air.

**9.3.6.2** Each of the appliances served shall be interlocked to the mechanical air supply system to prevent main burner operation where the mechanical air supply system is not in operation.

**9.3.6.3** Where combustion air is provided by the building's mechanical ventilation system, the system shall provide the specified combustion air rate in addition to the required ventilation air.

**9.3.7 Louvers, Grilles, and Screens.**

**9.3.7.1 Louvers and Grilles.** The required size of openings for combustion, ventilation, and dilution air shall be based on the net free area of each opening. Where the free area through a design of louver or grille or screen is known, it shall be used in calculating the size opening required to provide the free area specified. Where the louver and grille design and free area are not known, it shall be assumed that wood louvers will have 25 percent free area, and metal louvers and grilles will have 75 percent free area. Nonmotorized louvers and grilles shall be fixed in the open position.

**9.3.7.2 Minimum Scree Mesh Size.** Screens shall not be smaller than 1/4 in. mesh.

**9.3.7.3 Motorized Louvers.** Motorized louvers shall be interlocked with the appliance so they are proven in the full open position prior to main burner ignition and during main burner operation. Means shall be provided to prevent the main burner from igniting should the louver fail to open during burner startup and to shut down the main burner if the louvers close during burner operation.

**9.3.8 Combustion Air Ducts.** Combustion air ducts shall comply with 9.3.8.1 through 9.3.8.8.

**9.3.8.1** Ducts shall be constructed of galvanized steel or a material having equivalent corrosion resistance, strength, and rigidity.

*Exception: Within dwellings units, unobstructed stud and joist spaces shall not be prohibited from conveying combustion air, provided that not more than one fireblock is removed.*

**9.3.8.2** Ducts shall terminate in an unobstructed space, allowing free movement of combustion air to the appliances.

**9.3.8.3** Ducts shall serve a single space.

**9.3.8.4** Ducts shall not serve both upper and lower combustion air openings where both such openings are used. The separation between ducts servicing upper and lower combustion air openings shall be maintained to the source of combustion air.

# SYSTEM OPERATION

9.3.8.5 Ducts shall not be screened where terminating in an attic space.

9.3.8.6 Horizontal upper combustion air ducts shall not slope downward toward the source of combustion air.

9.3.8.7 The remaining space surrounding a chimney liner, gas vent, special gas vent, or plastic piping installed within a masonry, metal, or factory built chimney shall not be used to supply combustion air.

*Exception: Direct vent appliances designed for installation in a solid fuel-burning fireplace where installed in accordance with the manufacture's installation instructions.*

9.3.8.8 Combustion air intake openings located on the exterior of the building shall have the lowest side of the combustion air intake openings located at least 12 in. (300 mm) vertically from the adjoining grade level.

## Horizontal Applications and Considerations

Horizontal applications, in particular, may dictate many of the installation's specifics such as airflow direction, ductwork connections, flue and/or combustion air pipe connections, etc. The basic application of this furnace as a horizontal furnace differs only slightly from an upright installation. When installing a furnace horizontally, additional consideration must be given to the following:

### Drain Trap and Lines

In horizontal applications the condensate drain trap is secured to the furnace side panel, suspending it below the furnace. A minimum clearance of 5.5" below the furnace must be provided for the drain trap. Additionally, the appropriate downward piping slope must be maintained from the drain trap to the drain location. Refer to *Condensate Drain Trap and Lines* section in this manual or the installation instructions for further details. If the drain trap and drain line will be exposed to temperatures near or below freezing, adequate measures must be taken to prevent condensate from freezing. **NOTE:** The use of insulation and/or heat tape is recommended. Failure to provide proper condensate drainage can result in property damage.

### Leveling

Leveling ensures proper condensate drainage from the heat exchanger and induced draft blower. For proper flue pipe drainage, the furnace must be level lengthwise from end to end. The furnace should also be level from back to front or have a slight tilt with the access doors downhill (approximately 3/4") from the back panel. The slight tilt allows the heat exchanger condensate, generated in the recuperator coil, to flow forward to the recuperator coil front cover.

In horizontal installations with the furnace laying on the left hand side, the alternate vent connection may be used. In this configuration the internal elbow is removed. The standard piping connections may also be used in these positions. Refer to *Vent/Flue Pipe and Combustion Air Pipe* section in the installation instructions for details concerning the conversion to the alternate vent/flue and combustion air connections on the 90% furnace.

The 34.5" single stage furnace is one of the products in our newly redesigned line of shorter chassis furnaces. It is available in 92% / 96% AFUE up flow / horizontal model and a down flow / horizontal model.

The up flow / horizontal 34.5" single stage furnace is available in the following models:

\*MES920403ANAA  
\*MES920603BNAA  
\*MES9S0803BNAA  
\*MES920804CNAA  
\*MES920805CNAA  
\*MES921004CNAA  
\*MES921005CNAA  
\*MES921205DNAA

\*MES960403ANAA  
\*MES960603BNAA  
\*MES960803BNAA  
\*MES960804CNAA  
\*MES960805CNAA  
\*MES961005CNAA  
\*MES961205DNAA

The down flow / horizontal 34.5" single stage furnace is available in the following models.

\*CES960403BNAA  
\*CES960603BNAA  
\*CES960804CNAA  
\*CES961005CNAA  
\*CES961205CNAA

# SYSTEM OPERATION

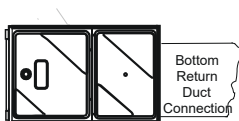
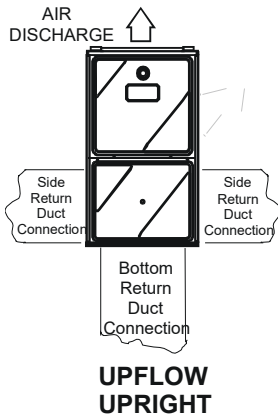

UPFLOW HORIZONTAL  
LEFT AIR DISCHARGE

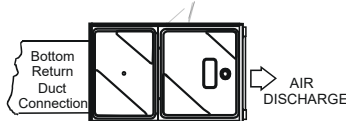

COUNTERFLOW HORIZONTAL  
RIGHT AIR DISCHARGE

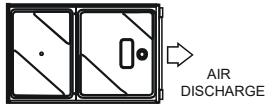

UPFLOW HORIZONTAL  
RIGHT AIR DISCHARGE

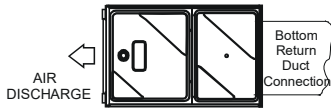

COUNTERFLOW HORIZONTAL  
LEFT AIR DISCHARGE

## 90% Furnace Recommended Installation Positions

**NOTE:** Alternate “vertical” piping connections can not be used when an upflow 90% furnace is installed with supply air discharging to the right or when a counterflow furnace is installed with supply discharging to the left. In this case, use the standard flue and combustion air piping connections

### Alternate Electrical and Gas Line Connections

Furnaces have provisions allowing for electrical and gas line connections through either side panel. In horizontal applications the connections can be made either through the “top” or “bottom” of the furnace.

### Drain Pan

A drain pan must be provided if the furnace is installed above a conditioned area. The drain pan must cover the entire area under the furnace (and air conditioning coil if applicable).

### Freeze Protection

If the drain trap and drain line will be exposed to temperatures near or below freezing, adequate measures must be taken to prevent condensate from freezing. **NOTE:** The use of insulation and/or heat tape is recommended. Failure to provide proper condensate drainage can result in property damage.

## Propane Gas and/or High Altitude Installations

### **WARNING**

**POSSIBLE PROPERTY DAMAGE, PERSONAL INJURY OR DEATH MAY OCCUR IF THE CORRECT CONVERSION KITS ARE NOT INSTALLED. THE APPROPRIATE KITS MUST BE APPLIED TO INSURE SAFE AND PROPER FURNACE OPERATION. ALL CONVERSIONS MUST BE PERFORMED BY A QUALIFIED INSTALLER OR SERVICE AGENCY.**

This furnace is shipped from the factory configured for natural gas at standard altitude. Propane gas installations require an orifice change to compensate for the energy content difference between natural and propane gas.

High altitude installations may require both a pressure switch and an orifice change. These changes are necessary to compensate for the natural reduction in the density of both the gas fuel and the combustion air at higher altitude.

Refer to the *Accessories Charts* in this manual or product Specification Sheet for a tabular listing of appropriate manufacturer’s kits for propane gas and/or high altitude installations. The indicated kits must be used to insure safe and proper furnace operation. All conversions must be performed by a qualified installer, or service agency.

## VENT/FLUE PIPE AND COMBUSTION AIR PIPE

### **WARNING**

**FAILURE TO FOLLOW THESE INSTRUCTIONS CAN RESULT IN BODILY INJURY OR DEATH. CAREFULLY READ AND FOLLOW ALL INSTRUCTIONS GIVEN IN THIS SECTION.**

### **WARNING**

**UPON COMPLETION OF THE FURNACE INSTALLATION, CAREFULLY INSPECT THE ENTIRE FLUE SYSTEM BOTH INSIDE AND OUTSIDE THE FURNACE TO ASSURE IT IS PROPERLY SEALED. LEAKS IN THE FLUE SYSTEM CAN RESULT IN SERIOUS PERSONAL INJURY OR DEATH DUE TO EXPOSURE TO FLUE PRODUCTS, INCLUDING CARBON MONOXIDE.**

This manual will refer to the pipe that discharges products of combustion to the outdoors as the “vent” pipe or “flue” pipe. The pipe that supplies air for combustion to the furnace will be referred to as the “intake” pipe or “combustion air” pipe.

A condensing gas furnace achieves its high level of efficiency by extracting almost all of the heat from the products of combustion and cooling them to the point where condensation takes place. Because of the relatively low flue gas temperature and water condensation requirements, PVC pipe is used as venting material.

This furnace must not be connected to Type B, BW, or L vent or vent connector, and must not be vented into any portion of a factory built or masonry chimney except when used as a pathway for PVC as described later in this section. **Never** common vent this appliance with another appliance or use a vent which is used by a solid fuel appliance.

It is the responsibility of the installer to follow the manufacturers’

# SYSTEM OPERATION

recommendations and to verify that all vent/flue piping and connectors are compatible with furnace flue products. Additionally, it is the responsibility of the installer to ensure that all piping and connections possess adequate structural integrity and support to prevent flue pipe separation, shifting, or sagging during furnace operation.

## Dual Certification: Non-Direct/Direct Vent (90% Furnaces Only)

The 90% furnace is dual certified and may be installed as a non-direct vent (single pipe) or direct vent (dual pipe) appliance. A **non-direct vent** installation requires only a vent/flue pipe. A **direct vent** installation requires both a vent/flue pipe and a combustion air intake pipe. Refer to the appropriate section for details concerning piping size, length, number of elbows, furnace connections, and terminations.

 <b>WARNING</b>
<b>TO AVOID BODILY INJURY, FIRE OR EXPLOSION, SOLVENT CEMENTS MUST BE KEPT AWAY FROM ALL IGNITION SOURCES (I.E., SPARKS, OPEN FLAMES, AND EXCESSIVE HEAT) AS THEY ARE COMBUSTIBLE LIQUIDS. AVOID BREATHING CEMENT VAPORS OR CONTACT WITH SKIN AND/OR EYES.</b>

Precautions should be taken to prevent condensate from freezing inside the vent/flue pipe and/or at the vent/flue pipe termination. It is our recommendation that all vent/flue piping exposed to temperatures below 35°F for extended periods of time should be insulated with 1/2" thick closed cell foam. Also all vent/flue piping exposed outdoors in excess of the terminations shown in this manual (or in unheated areas) should be insulated with 1/2" thick closed cell foam. Inspect piping for leaks prior to installing insulation.

The following bullets and diagram describe the restrictions concerning the appropriate location of vent/flue pipe and combustion air intake pipe (when applicable) terminations. Refer to the installation instructions for specific details on termination construction.

- All terminations must be located at least 12 inches above ground level or the anticipated snow level.
- Vent terminations must terminate at least 3 feet above any forced air inlet located within 10 feet.
- **NOTE:** This provision does not apply to the combustion air intake termination of a direct vent application.
- The vent termination of a *non-direct vent* application must terminate at least 4 feet below, 4 feet horizontally from, or 1 foot above any door, window, or gravity air inlet into any building.
- The vent termination of a *direct vent* application must terminate at least 12 inches from any opening through which flue gases may enter a building (door, window, or gravity air inlet).
- The vent termination of vent pipe run vertically through a roof must terminate at least 12 inches above the roof line (or the anticipated snow level) and be at least 12 inches from any vertical wall (including any anticipated snow build up).

- A vent termination shall not terminate over public walkways or over an area where condensate or vapor could create a nuisance or hazard or could be detrimental to the operation of regulators, relief valves, or other equipment.
- The combustion air intake termination of a direct vent application should not terminate in an area which is frequently dusty or dirty.

**NOTE:** In Canada, the B149 Fuel Gas Code takes precedence over the preceding termination restrictions.

## Direct Vent Installations

On *upflow* units secure the combustion air intake pipe directly to the air intake coupling. On *counterflow* units secure the combustion air intake pipe to the air intake coupling using the rubber coupling and worm gear hose clamps provided with the unit. The counterflow rubber coupling allows service removal of air intake piping internal to the furnace blower compartment. The combustion air intake pipe can also be secured directly to the counterflow unit air intake pipe coupling.

## Non-Direct Vent Installations

A minimum of one 90° elbow must be installed on the combustion air intake "coupling" to guard against inadvertent blockage.

 <b>CAUTION</b>
<b>EDGES OF SHEET METAL HOLES MAY BE SHARP. USE GLOVES AS PRECAUTION WHEN REMOVING HOLE PLUGS.</b>

 <b>WARNING</b>
<b>THE RUBBER ELBOW IS NOT DESIGNED TO SUPPORT A LOAD. WHEN THE RUBBER ELBOW IS MOUNTED EXTERNALLY TO THE FURNACE CABINET, EXTREME CARE MUST BE TAKEN TO ADEQUATELY SUPPORT FIELD-SUPPLIED VENT/FLUE PIPING, AS DAMAGE CAN RESULT IN LEAKS CAUSING BODILY INJURY OR DEATH DUE TO EXPOSURE TO FLUE GASES, INCLUDING CARBON MONOXIDE.</b>

 <b>CAUTION</b>
<b>BE SURE NOT TO DAMAGE INTERNAL WIRING OR OTHER COMPONENTS WHEN REINSTALLING COUPLING AND SCREWS.</b>

## Vent/Flue Pipe Lengths and Diameters

Refer to the following tables for applicable length, elbows, and pipe diameter for construction of the vent/flue pipe system of a non-direct vent installation. In addition to the vent/flue pipe, a single 90° elbow must be secured to the combustion air intake to prevent inadvertent blockage. The tee or elbows used in the vent/flue termination must be included when determining the number of elbows in the piping system.

# SYSTEM OPERATION

\*MES9\* / \*CES9 Direct Vent (2-Pipe) & Non-Direct Vent (1-Pipe) <sup>(6)</sup>  
Maximum Allowable Length of Vent/Flue Pipe

MODEL	PIPE SIZE	Number of Elbows <sup>(3)</sup> <sup>(5)</sup>							
		1	2	3	4	5	6	7	8
*MES920403AN	2"	108	105	101	97	93	90	86	82
	3	126	120	115	110	105	99	94	89
*MES920603BN	2	55	50	45	40	35	30	25	20
	3	127	120	113	106	99	92	85	78
*MES920803BN	2	30	25	20	15	10	5	N/A	N/A
	3	72	65	58	51	44	37	30	23
*MES920804CN	2	30	25	20	15	10	5	N/A	N/A
	3	72	65	58	51	44	37	30	23
*MES920805CN	2	40	35	30	25	20	15	10	5
	3	72	65	58	51	44	37	30	23
*MES921004CN	2	60	55	50	45	40	35	30	25
	3	168	161	154	147	140	133	126	119
*MES921005CN	2	30	25	20	15	10	5	N/A	N/A
	3	113	106	99	92	85	78	71	64
*MES921205DN	2	N/A	N/A	N/A	N/A	N/A	N/A	N/A	N/A
	3	65	58	51	44	37	30	23	16

MODEL	PIPE	1	2	3	4	5	6	7	8
*MES960403AN	2"	75	71	67	63	60	56	52	48
	3	126	120	115	110	105	99	94	89
*MES960603BN	2	45	40	35	30	25	20	15	10
	3	168	161	154	147	140	133	126	119
*MES960803BN	2	35	30	25	20	15	10	5	N/A
	3	168	161	154	147	140	133	126	119
*MES960804BN	2	60	55	50	45	40	35	30	25
	3	113	106	99	92	85	78	71	64
*MES960805CN	2	45	40	35	30	25	20	15	10
	3	120	113	106	99	92	85	78	71
*MES961005CN	2	40	35	30	25	20	15	10	5
	3	151	144	137	130	123	116	109	102
*MES961205DN	2	N/A	N/A	N/A	N/A	N/A	N/A	N/A	N/A
	3	158	151	144	137	130	123	116	109
*CES960403BN	2	100	95	90	85	80	75	70	65
	3	137	130	123	116	109	102	95	88
*CES960603BN	2	45	40	35	30	25	20	15	10
	3	168	161	154	147	140	133	126	119
*CES960804CN	2	40	35	30	25	20	15	10	5
	3	120	113	106	99	92	85	78	71
*CES961005CN	2	N/A	N/A	N/A	N/A	N/A	N/A	N/A	N/A
	3	113	106	99	92	85	78	71	64
*CES961205DN	2	N/A	N/A	N/A	N/A	N/A	N/A	N/A	N/A
	3	110	103	96	89	82	75	68	61

- 1) Maximum allowable limits listed on individual lengths for inlet and flue and NOT a combination.
- 2) Minimum requirement for each vent pipe is five (5) feet in length and one elbow/tee.
- 3) Tee used in the vent/flue termination must be included when determining the number of elbows in the piping system.
- 4) 2 1/2" or 3" diameter pipe can be used in place of 2" diameter pipe.
- 5) Increased Clearance Configurations using (2) 45 deg. Long Sweep elbows should be considered equivalent to one 90 deg. elbow.
- 6) One 90° elbow should be secured to the combustion air intake connection.

## Vent/Flue and Combustion Air Pipe Lengths and Diameters

Refer to the preceding table for applicable length, elbows, and pipe diameter for construction of the vent/flue and combustion air intake pipe systems of a non-direct vent (single pipe) installation. The number of elbows tabulated represents the number of elbows and/or tees in each (Vent/Flue & Combustion Air Intake) pipe. Elbows and/or tees used in the terminations must be included when determining the number of elbows in the piping systems.

If the combustion air intake pipe is to be installed above a finished ceiling or other area where dripping of condensate will be objectionable, insulation of the combustion air pipe may be required. Use 1/2" thick closed cell foam insulation such as Armaflex or Insultube where required.

## Vent/Flue Pipe Terminations

The vent/flue pipe may terminate vertically, as through a roof, or horizontally, as through an outside wall.

Vertical vent/flue pipe termination should be as shown in the following figures. Refer to *Vent/Flue Pipe and Combustion Air Pipe - Termination Locations* section in this manual or the installation instructions for details concerning location restrictions. The penetration of the vent through the roof must be sealed tight with proper flashing such as is used with a plastic plumbing vent.

**NOTE: Terminate both pipes in the same pressure zone (same side of roof, no major obstacles between pipes, etc.).**

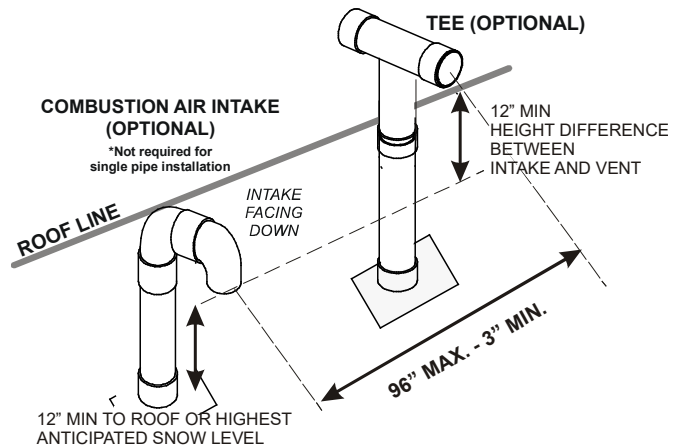



# SYSTEM OPERATION

## VENT PIPE TERMINATION OPTIONS

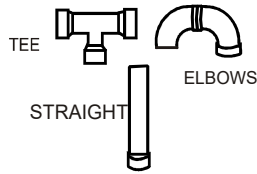

Horizontal vent/flue pipe terminations should be as shown in the following figure. Refer to *Vent/Flue Pipe and Combustion Air Pipe - Termination Locations* section in this manual or the installation instructions for details concerning location restrictions. A 2 3/8" diameter wall penetration is required for 2" diameter pipe while a 3 1/2" diameter hole is required for 3" diameter pipe. To secure the pipe passing through the wall and prohibit damage to piping connections, a coupling should be installed on either side of the wall and solvent cemented to a length of pipe connecting the two couplings. The length of pipe should be the wall thickness plus the depth of the socket fittings to be installed on the inside and outside of the wall. The wall penetration should be sealed with silicone caulking material.

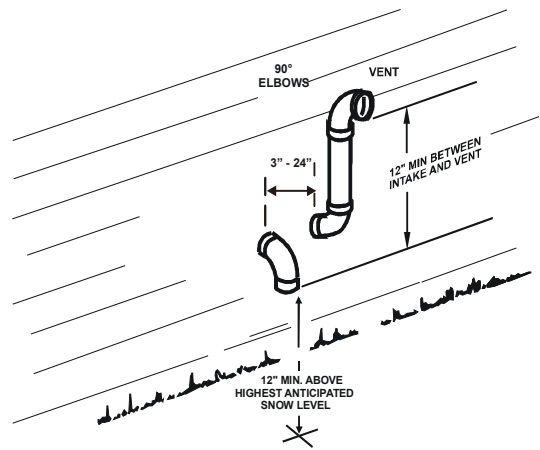

Alternate Horizontal Vent Termination (Dual Pipe)

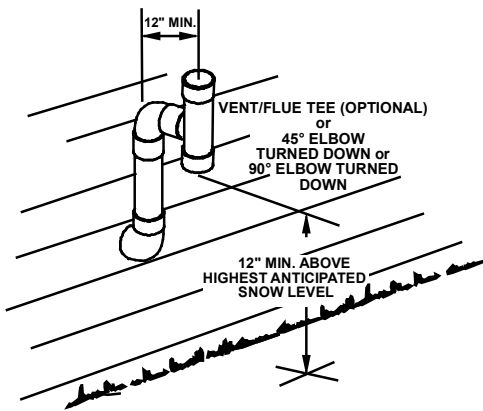

Horizontal Termination (Single Pipe)  
Above Highest Anticipated Snow Level

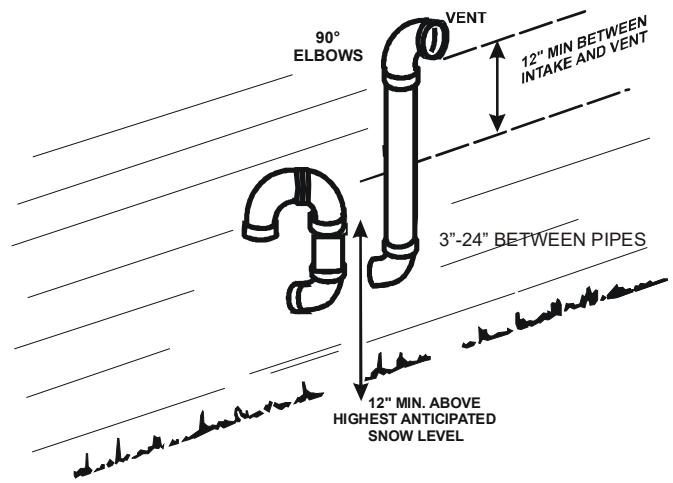

Combustion Air Intake may also be snorkeled to obtain 12" min ground clearance.

Alternate Vent Termination Above Anticipated Snow Level  
(Dual Pipe)

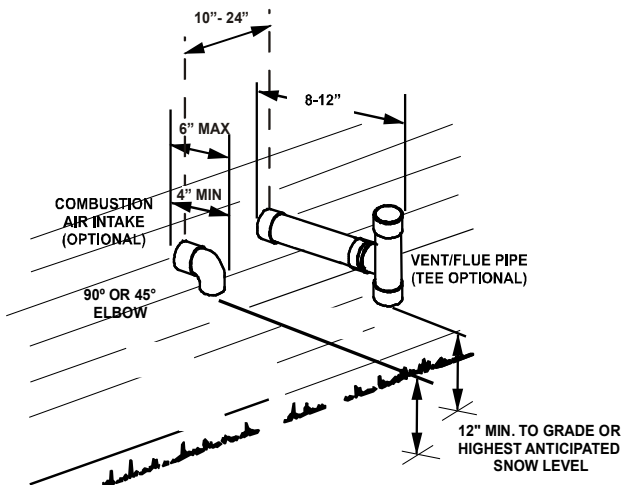

Standard Horizontal Terminations (Dual Pipe)

# SYSTEM OPERATION

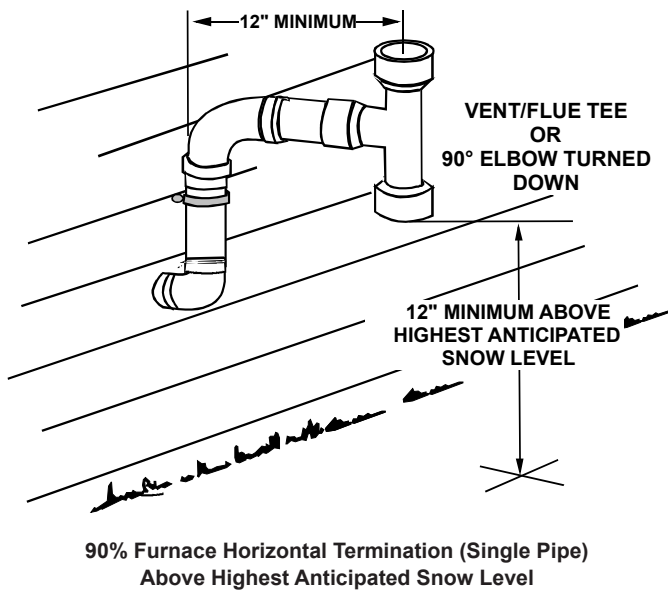

In a basement installation, the vent/flue pipe can be run between joist spaces. If the vent pipe must go below a joist and then up into the last joist space to penetrate the header, two 45° elbows should be used to reach the header rather than two 90° elbows.

## Direct Vent (Dual Pipe) Piping

*Direct vent* installations require both a combustion air intake and a vent/flue pipe. The pipes may be run horizontally and exit through the side of the building or run vertically and exit through the roof of the building. The pipes may be run through an existing *unused* chimney; however, they must extend a minimum of 12 inches above the top of the chimney. The space between the pipes and the chimney must be closed with a weather tight, corrosion resistant flashing. Both the combustion air intake and a vent/flue pipe terminations must be in the same atmospheric pressure zone. Refer to *Vent/Flue and Combustion Air Pipe - Termination Locations or Concentric Vent Termination* section in this manual or the installation instructions for specific details on termination construction.

## Concentric Vent Kits (DCVK) Application

The DCVK-20 and DCVK-30 kit is designed to allow the terminations of a direct vent furnace to be “concentrically” vented through a wall or roof. This kit allows a single penetration to support terminations for both the vent/flue pipe and the combustion air intake pipe.

## (DCVK) Vent Termination Clearances

1. Determine termination locations based on clearances specified in furnace installation instructions, and following steps as shown in Figures 1,3,6,7,8 and 9.

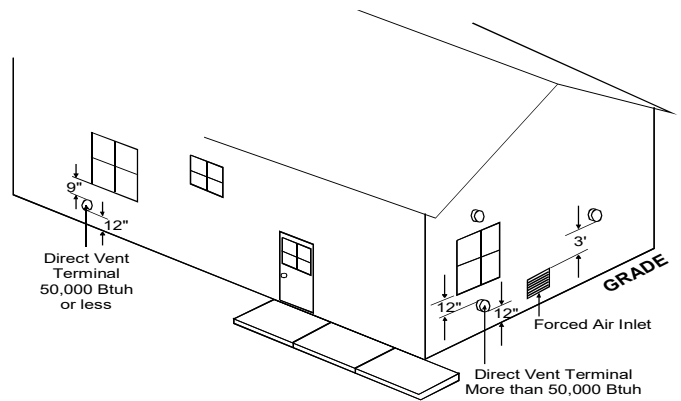

**FIGURE 1**

2. The vent termination must be located at least 12” above ground or normally expected snow accumulation levels.
3. Do NOT terminate over public walkways. Avoid areas where condensate may cause problems such as above planters, patios, or adjacent to windows where steam may cause fogging.
4. The vent termination shall be located at least 4’ horizontally from any electric meter, gas meter, regulator and any relief equipment. These distances apply ONLY to U.S. Installations.
5. The vent termination shall be located at least 3’ above any forced air inlet located within 10’; and at least 10’ from a combustion air intake of another appliance, except another direct vent furnace intake.
6. In Canada, the Canadian Fuel Gas Code takes precedence over the preceding termination instructions.

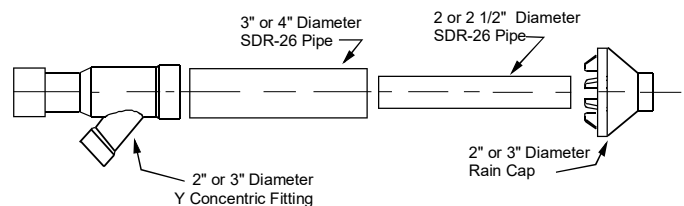

**FIGURE 2**

These kits are for vertical or horizontal termination of the combustion air inlet and the exhaust vent pipes on Category IV gas-fired condensing furnaces. The DCVK-30 kit can be used for 3” diameter pipe systems. The DCVK-20 kit can be used for the 2” diameter pipe system. For the correct pipe size for the furnace. Both the combustion air inlet and the exhaust vent pipes must attach to the termination kit. The termination kit must terminate outside the structure and must be installed per the instructions outlined below for vertical or horizontal termination. Vertical termination is preferred. Field supplied pipe and fittings are required to complete the installation.

# SYSTEM OPERATION

1. Determine the best location for the termination kit. Roof termination is preferred since it is less susceptible to damage, has reduced intake contaminants and less visible vent vapors. For side termination, consideration should be given to:
  - a. Possible damage from the vapors to plants/shrubs, other equipment and building materials
  - b. Possible damage to the terminal from foreign objects
  - c. Wind effects that may cause recirculation of flue products, debris or light snow
  - d. Visible vent vapors.

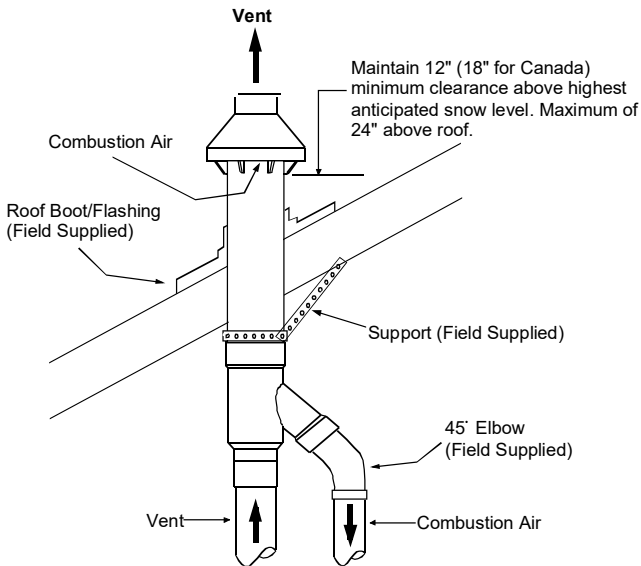
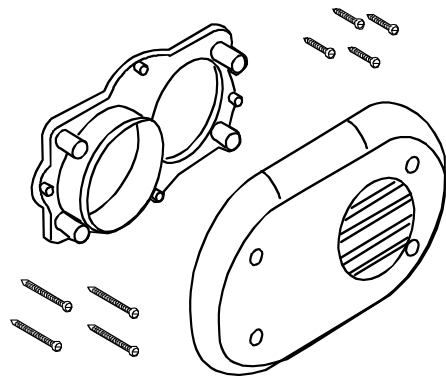

FIGURE 3

<b>WARNING</b>
<p><b>DO NOT OPERATE THE FURNACE WITH THE RAIN CAP REMOVED AS RECIRCUCLATION OF THE FLUE GASES MAY OCCUR. WATER MAY ALSO COLLECT INSIDE THE LARGER COMBUSTIN AIR PIPE AND FLOW TO THE BURNER ENCLOSURE. FAILURE TO FOLLOW THIS WARNING CAN RESULT IN PROPERTY DAMAGE, EQUIPMENT DAMAGE, PERSONAL INJURY OR DEATH.</b></p>

## Concentric Sidewall Vent Kit (0170K0000S)

This (sidewall only) vent kit is to be used with 2" - 3" vent systems. The vent kit must terminate outside the structure and may be installed with the intake and exhaust pipes located side-by-side or with one pipe above the other. This kit is NOT intended for use with single pipe (non-direct vent) installations.

## Condensate Drain Lines and Drain Trap

A condensing gas furnace achieves its high level of efficiency by extracting almost all of the heat from the products of combustion and cooling them to the point where condensation takes place. The condensate which is generated must be piped to an appropriate drain location.

<b>WARNING</b>
<p><b>IN UPRIGHT UPFLOW INSTALLATIONS, THE DRAIN TRAP MUST BE MOUNTED ON THE OPPOSITE SIDE OF THE UNIT FROM THE JUNCTION BOX. THIS WILL REDUCE THE RISK OF WATER REACHING THE JUNCTION BOX IN THE EVENT OF A BLOCKED DRAIN CONDITION. FAILURE TO FOLLOW THESE INSTRUCTIONS CAN RESULT IN POSSIBLE PROPERTY DAMAGE, PERSONAL INJURY, OR DEATH DUE TO ELECTRICAL SHOCK.</b></p>

- If the drain line is routed through an area which may see temperatures near or below freezing, precautions must be taken to prevent condensate from freezing within the drain line.
- If an air conditioning coil is installed with the furnace, a common drain may be used. An open tee must be installed in the drain line, near the cooling coil, to relieve positive air pressure from the coil's plenum. This is necessary to prohibit any interference with the function of the furnace's drain trap.

## Drain Information for Horizontal Installations

**NOTE:** Horizontal installations require 5.5" under the furnace to accommodate the drain trap. The horizontal furnace must be installed with 3/4" slope from back to front to permit condensate flow towards the front of the furnace.

When installing a \*MES9\* horizontally with the left side down, there are two options for connecting the vent pipe to the furnace.

### Option 1

Venting may be connected to the furnace vent pipe fitting on the original top (now the end) of the furnace.

### Option 2

The internal vent pipe and elbow may be removed from the furnace to permit the vent to exit the top (original side) of the furnace. If this option is used, an RF000142 Vent-Drain coupling must be used to keep condensate from collecting in the inducer assembly.

# SYSTEM OPERATION

To install the drain, refer to the following instructions and illustration.

## COMBUSTION AIR INTAKE PIPE OPTIONS:

The RF000142 coupling can be secured directly to the furnace intake coupling if condensation is occurring in the combustion air inlet pipe. If the RF000142 is used on the combustion air inlet, it must be installed with the arrow pointing up. It should be noted, the combustion air will actually be moving in a direction opposite of the arrow on the RF000142 coupling.

Alternatively a tee may be used in the combustion air intake pipe for the same purpose. If either option is used, a field supplied trapped drain tube, free-draining to proper condensate disposal location must be present. A loop in the drain tube can serve as a trap. The unused RF000142 drain fitting should be capped.

1. Remove screws from vent flange.
2. Remove internal elbow and vent pipe.
3. Cut pipe 2 1/2" from flange.
4. Remove cabinet plug adjacent to inducer outlet and install an original cabinet vent hole.
5. Install RF000142 coupling on inducer outlet.
6. Install flanged vent section removed in step 2 and secure with clamps.
7. Secure flange to cabinet using screws removed in step 1.

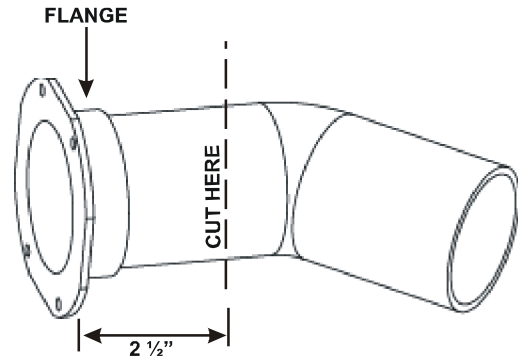
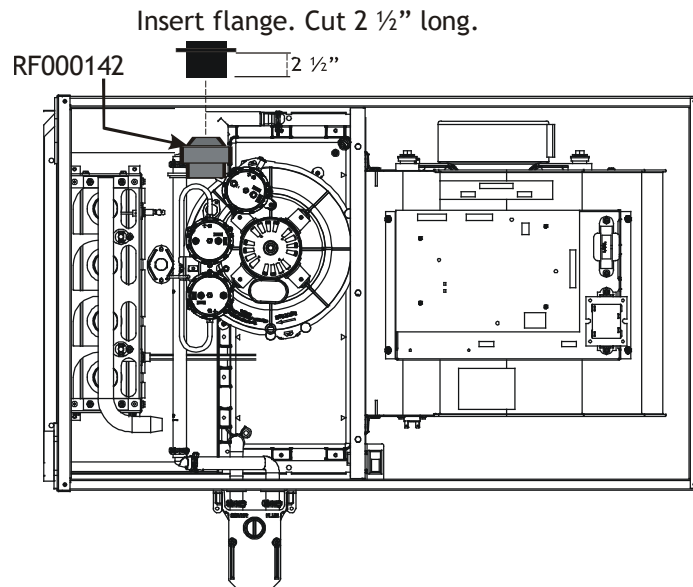

## GAS SUPPLY AND PIPING

The furnace rating plate includes the approved furnace gas input rating and gas types. The furnace must be equipped to operate on the type of gas applied. This includes any conversion kits required for alternate fuels and/or high altitude.

**CAUTION**

**TO PREVENT UNRELIABLE OPERATION OR EQUIPMENT DAMAGE, THE INLET GAS SUPPLY PRESSURE MUST BE AS SPECIFIED ON THE UNIT RATING PLATE WITH ALL OTHER HOUSEHOLD GAS FIRED APPLIANCES OPERATING.**

Inlet gas supply pressures must be maintained within the ranges specified below. The supply pressure must be constant and available with all other household gas fired appliances operating. The minimum gas supply pressure must be maintained to prevent unreliable ignition. The maximum must not be exceeded to prevent unit overfiring.

INLET GAS SUPPLY PRESSURE		
Natural Gas	Minimum: 4.5" w.c.	Maximum: 10.0" w.c.
Propane Gas	Minimum: 11.0" w.c.	Maximum: 13.0" w.c.

## HIGH ALTITUDE DERATE

When this furnace is installed at high altitude, the appropriate High Altitude orifice kit must be applied. This is required due to the natural reduction in the density of both the gas fuel and combustion air as altitude increases. The kit will provide the proper design certified input rate within the specified altitude range.

High altitude kits are purchased according to the installation altitude and usage of either natural or propane gas. Refer to the product Specification Sheet or the Accessory Matrix in this Manual for a tabular listing of appropriate altitude ranges and corresponding manufacturer's high altitude (Natural, Propane gas, and/or Pressure Switch) kits.

Do **not** derate the furnace by adjusting the manifold pressure to a lower pressure than specified on the furnace rating plate. The combination of the lower air density and a lower manifold pressure will prohibit the burner orifice from drawing the proper amount of air into the burner. This may cause incomplete combustion, flashback, and possible yellow tipping.

In some areas the gas supplier may artificially derate the gas in an effort to compensate for the effects of altitude. If the gas is artificially derated, the appropriate orifice size must be

# SYSTEM OPERATION

determined based upon the BTU/ft<sup>3</sup> content of the derated gas and the altitude. Refer to the National Fuel Gas Code, NFPA 54/ANSI Z223.1, and information provided by the gas supplier to determine the proper orifice size.

A different pressure switch may be required at high altitude regardless of the BTU/ft<sup>3</sup> content of the fuel used. Refer to the product Specification Sheet or Technical Manual for a tabular listing of appropriate altitude ranges and corresponding manufacturer's pressure switch kits.

## PROPANE GAS CONVERSION



### WARNING

**POSSIBLE PROPERTY DAMAGE, PERSONAL INJURY OR DEATH MAY OCCUR IF THE CORRECT CONVERSION KITS ARE NOT INSTALLED. THE APPROPRIATE KITS MUST BE APPLIED TO INSURE SAFE AND PROPER FURNACE OPERATION. ALL CONVERSIONS MUST BE PERFORMED BY A QUALIFIED INSTALLER OR SERVICE AGENCY.**

This unit is configured for natural gas. The appropriate manufacturer's propane gas conversion kit, must be applied for propane gas installations.

\*\*ES9\* models using a White-Rodgers 36J22 single stage valve use LPM-07 LP Conversion Kit.

## GAS VALVE

This unit is equipped with a 24 volt gas valve controlled during furnace operation by the integrated control module. As shipped, the valve is configured for natural gas. The valve is field convertible for use with propane gas by using the appropriate propane gas conversion kit. Taps for measuring the gas supply pressure and manifold pressure are provided on the valve.

**NOTE: The gas supply pressure on White-Rodgers "J" model gas valve, used on single stage furnaces, can be checked with a gas pressure test kit (Part #0151K0000S) available through our authorized distributors.**

The gas valve has a manual ON/OFF control located on the valve itself. This control may be set only to the "ON" or "OFF" position. Refer to the *Lighting Instructions Label* or the *"Putting the Furnace Into Operation"* section of this manual or the installation instructions for use of this control during start up and shut down periods.

## GAS PIPING CONNECTIONS



### CAUTION

**TO AVOID POSSIBLE UNSATISFACTORY OPERATION OR EQUIPMENT DAMAGE DUE TO UNDERFIRING OF EQUIPMENT, USE THE PROPER SIZE OF NATURAL/PROPANE GAS PIPING NEEDED WHEN RUNNING PIPE FROM THE METER/TANK TO THE FURNACE.**

The gas piping supplying the furnace must be properly sized based on the gas flow required, specific gravity of the gas, and length of the run. The gas line installation must comply with local codes, or in their absence, with the latest edition of the National Fuel Gas Code, NFPA 54/ANSI Z223.1.

Natural Gas Capacity of Pipe In Cubic Feet of Gas Per Hour (CFH)					
Length of Pipe in Feet	Nominal Black Pipe Size				
	1/2"	3/4"	1"	1 1/4"	1 1/2"
10	132	278	520	1050	1600
20	92	190	350	730	1100
30	73	152	285	590	980
40	63	130	245	500	760
50	56	115	215	440	670
60	50	105	195	400	610
70	46	96	180	370	560
80	43	90	170	350	530
90	40	84	160	320	490
100	38	79	150	305	460

(Pressure 0.5 psig or less and pressure drop of 0.3" W.C.; Based on 0.60 Specific Gravity Gas)

$$CFH = \frac{BTUH \text{ Furnace Input}}{\text{Heating Value of Gas (BTU/Cubic Foot)}}$$

To connect the furnace to the building's gas piping, the installer must supply a ground joint union, drip leg, manual shutoff valve, and line and fittings to connect to gas valve. In some cases, the installer may also need to supply a transition piece from 1/2" pipe to a larger pipe size.

The following stipulations apply when connecting gas piping. Refer to the following figures for typical gas line connections to the furnace.

1. Use black iron or steel pipe and fittings for the building piping.
2. Use pipe joint compound on male threads only. Pipe joint compound must be resistant to the action of the fuel used.
3. Use ground joint unions.
4. Install a drip leg to trap dirt and moisture before it can enter the gas valve. The drip leg must be a minimum of three inches long.
5. Install a 1/8" NPT pipe plug fitting, accessible for test gage connection, immediately upstream of the gas supply connection to the furnace.
6. Use two pipe wrenches when making connection to the gas valve to keep it from turning. The orientation of the gas valve on the manifold must be maintained as shipped from the factory.
7. Install a manual shutoff valve between the gas meter and unit within six feet of the unit. If a union is installed, the union must be downstream of the manual shutoff valve, between the shutoff valve and the furnace.
8. Tighten all joints securely.

# SYSTEM OPERATION

## GAS PIPING CHECKS

Before placing unit in operation, leak test the unit and gas connections.

### WARNING

**TO AVOID THE POSSIBILITY OF EXPLOSION OR FIRE, NEVER USE A MATCH OR OPEN FLAME TO TEST FOR LEAKS.**

Check for leaks using an approved chloride-free soap and water solution, an electronic combustible gas detector, or other approved testing methods.

**NOTE:** Never exceed specified pressures for testing. Higher pressure may damage the gas valve and cause subsequent overfiring, resulting in heat exchanger failure. Disconnect this unit and shutoff valve from the gas supply piping system before pressure testing the supply piping system with pressures in excess of 1/2 psig (3.48 kPa). Isolate this unit from the gas supply piping system by closing its external manual gas shutoff valve before pressure testing supply piping system with test pressures equal to or less than 1/2 psig (3.48 kPa).

## PROPANE GAS TANKS AND PIPING

### WARNING

**PROPANE GAS IS HEAVIER THAN AIR AND ANY LEAKING GAS CAN SETTLE IN ANY LOW AREAS OR CONFINED SPACES. TO PREVENT PROPERTY DAMAGE, PERSONAL INJURY, OR DEATH DUE TO FIRE OR EXPLOSION CAUSED BY A PROPANE GAS LEAK, INSTALL A GAS DETECTION WARNING DEVICE.**

A gas detecting warning system is the only reliable way to detect a propane gas leak. Iron oxide (rust) can reduce the level of odorant in propane gas. Do not rely on your sense of smell. Contact a local propane gas supplier about installing a gas detecting warning system. If the presence of gas is suspected, follow the instructions on this page.

All propane gas equipment must conform to the safety standards of the National Board of Fire Underwriters, NBFU Manual 58.

For satisfactory operation, propane gas pressure must be 10 inch WC at the furnace manifold with all gas appliances in operation. Maintaining proper gas pressure depends on three main factors:

1. Vaporization rate, depending on temperature of the liquid, and "wetted surface" area of the container or containers.
2. Proper pressure regulation. (Two-stage regulation is recommended for both cost and efficiency).
3. Pressure drop in lines between regulators, and between second stage regulator and the appliance. Pipe size will depend on length of pipe run and total load of all appliances.

Complete information regarding tank sizing for vaporization, recommended regulator settings, and pipe sizing is

available from most regulator manufacturers and propane gas suppliers.

Use pipe dope approved for use with L.P. gas.

Refer to the following illustration for typical propane gas installations and piping.

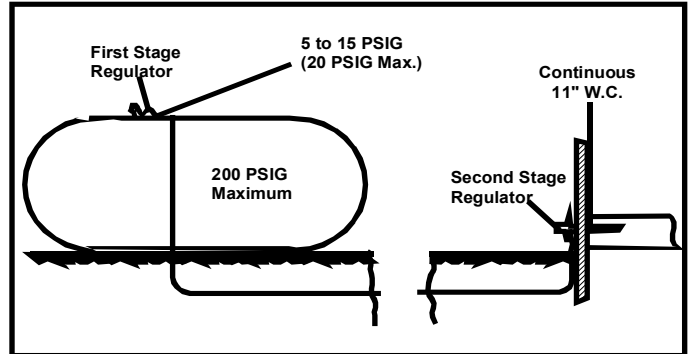

Typical Propane Gas Installation

### WARNING

**IF THE GAS FURNACE IS INSTALLED IN A BASEMENT, AN EXCAVATED AREA OR A CONFINED SPACE, IT IS STRONGLY RECOMMENDED TO CONTACT A PROPANE SUPPLIER TO INSTALL A GAS DETECTING WARNING DEVICE IN CASE OF A GAS LEAK.**

- **SINCE PROPANE GAS IS HEAVIER THAN AIR, ANY LEAKING GAS CAN SETTLE IN ANY LOW AREAS OR CONFINED SPACES.**
- **PROPANE GAS ODORANT MAY FADE, MAKING THE GAS UNDETECTABLE EXCEPT WITH A WARNING DEVICE.**

### WARNING

**AN UNDETECTED GAS LEAK WILL CREATE A DANGER OF EXPLOSION OR FIRE. IF THE PRESENCE OF GAS IS SUSPECTED, FOLLOW THE INSTRUCTIONS ON THE COVER OF THIS MANUAL. FAILURE TO DO SO COULD RESULT IN SERIOUS PERSONAL INJURY OR DEATH.**

# SYSTEM OPERATION



## WARNING

IF THE INFORMATION IN THESE INSTRUCTIONS IS NOT FOLLOWED EXACTLY, A FIRE OR EXPLOSION MAY RESULT CAUSING PROPERTY DAMAGE, PERSONAL INJURY OR LOSS OF LIFE.

- DO NOT STORE OR USE GASOLINE OR OTHER FLAMMABLE VAPORS AND LIQUIDS IN THE VICINITY OF THIS OR ANY OTHER APPLIANCE.

### - WHAT TO DO IF YOU SMELL GAS:

- DO NOT TRY TO LIGHT ANY APPLIANCE.
- DO NOT TOUCH ANY ELECTRICAL SWITCH; DO NOT USE ANY PHONE IN YOUR BUILDING.
- IMMEDIATELY CALL YOUR GAS SUPPLIER FROM A NEIGHBOR'S PHONE. FOLLOW THE GAS SUPPLIER'S INSTRUCTIONS.
- IF YOU CANNOT REACH YOUR GAS SUPPLIER, CALL THE FIRE DEPARTMENT.

- INSTALLATION AND SERVICE MUST BE PERFORMED BY A QUALIFIED INSTALLER, SERVICE AGENCY OR THE GAS SUPPLIER.

### Sizing Between First and Second Stage Regulator\*

Maximum Propane Capacities listed are based on 2 psig pressure drop at 10 psig setting. Capacities in 1,000 BTU/hour.

Pipe or Tubing Length Feet	Tubing Size, O.D. Type L					Nominal Pipe Size Schedule 40	
	3/8"	1/2"	5/8"	3/4"	7/8"	1/2"	3/4"
10	730	1,700	3,200	5,300	8,300	3,200	7,500
20	500	1,100	220	3,700	5,800	2,200	4,200
30	400	920	2,000	2,900	4,700	1,800	4,000
40	370	850	1,700	2,700	4,100	1,600	3,700
50	330	770	1,500	2,400	3,700	1,500	3,400
60	300	700	1,300	2,200	3,300	1,300	3,100
80	260	610	1,200	1,900	2,900	1,200	2,600
100	220	540	1,000	1,700	2,600	1,000	2,300
125	200	490	900	1,400	2,300	900	2,100
150	190	430	830	1,300	2,100	830	1,900
175	170	400	780	1,200	1,900	770	1,700
200	160	380	730	1,100	1,800	720	1,500

To convert to capacities at 15 psig settings - multiply by 1.130  
 To convert to capacities at 5 psig settings - multiply by 0.879

### Sizing Between Second or Second Stage Regulator & Appliance\*

Maximum Propane Capacities listed are based on 1/2" W.C. pressure drop at 11" W.C. setting. Capacities in 1,000 BTU/hour.

Pipe or Tubing Length Feet	Tubing Size, O.D. Type L					Nominal Pipe Size Schedule 40				
	3/8"	1/2"	5/8"	3/4"	7/8"	1/2"	3/4"	1"	1-1/4"	1-1/2"
10	39	92	199	329	501	275	567	1,071	2,205	3,307
20	26	62	131	216	346	189	393	732	1,496	2,299
30	21	50	107	181	277	152	315	590	1,212	1,858
40	19	41	90	145	233	129	267	504	1,039	1,559
50	18	37	79	131	198	114	237	448	913	1,417
60	16	35	72	1,211	187	103	217	409	834	1,275
80	13	29	62	104	155	89	185	346	724	1,066
100	11	26	55	90	138	78	162	307	630	976
125	10	24	48	81	122	69	146	275	567	866
150	9	21	43	72	109	63	132	252	511	787
200	8	19	39	66	100	54	112	209	439	665
250	8	17	36	60	93	48	100	185	390	590

\*Data in accordance with NFPA pamphlet No. 54

## Propane Gas Piping Charts

When installing a propane storage tank, the contractor must consider proper tank sizing, safety, efficiency, ground characteristics and aesthetics. For a residential customer, the size may range from 100-1,000 gallons, depending on household use. Typically, a 500 gallon tank is ample for an average four-bedroom home. However, it is best to consult your local propane supplier to ensure the proper sizing for propane storage requirements. Determining the correct tank size for each household is a function of demand, economy, efficiency and convenience. It is a process that requires cooperation between the propane supplier and customer.

## ELECTRICAL CONNECTIONS



## WARNING

TO AVOID THE RISK OF ELECTRICAL SHOCK, WIRING TO THE UNIT MUST BE PROPERLY POLARIZED AND GROUNDED.



## WARNING

### HIGH VOLTAGE

DISCONNECT ALL POWER BEFORE SERVICING OR INSTALLING THIS UNIT. MULTIPLE POWER SOURCES MAY BE PRESENT. FAILURE TO DO SO MAY CAUSE PROPERTY DAMAGE, PERSONAL INJURY OR DEATH.

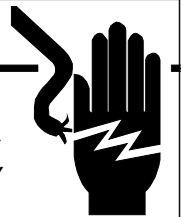

## CAUTION

LABEL ALL WIRES PRIOR TO DISCONNECTION WHEN SERVICING CONTROLS. WIRING ERRORS CAN CAUSE IMPROPER AND DANGEROUS OPERATION. VERIFY PROPER OPERATION AFTER SERVICING.

## WIRING HARNESS

The wiring harness is an integral part of this furnace. Field alteration to comply with electrical codes should not be required. Wires are color coded for identification purposes. Refer to the wiring diagram for wire routings. If any of the original wire as supplied with the furnace must be replaced, it must be replaced with wiring material having a temperature rating of at least 105° C. Any replacement wiring must be copper conductor.

### 115 VOLT LINE VOLTAGE CONNECTION OF ACCESSORIES (HUMIDIFIER AND ELECTRONIC AIR CLEANER - 96% MODELS ONLY)

The furnace integrated control module is equipped with line voltage accessory terminals for controlling power to an optional field-supplied humidifier and/or electronic air cleaner.

The accessory load specifications are as follows:

Turn OFF power to the furnace before installing any accessories. Follow the humidifier or air cleaner manufacturers' instructions for locating, mounting, grounding, and controlling these accessories. Accessory wiring connections are to be made through the 1/4" quick connect terminals provided on the furnace integrated control module. The humidifier and electronic air cleaner hot terminals

# SYSTEM OPERATION

are identified as HUM and EAC. The humidifier and electronic air cleaner neutral terminals are identified as NEUTRAL. All field wiring must conform to applicable codes. Connections should be made as shown. (See Figure 28.)

If it is necessary for the installer to supply additional line voltage wiring to the inside of the furnace, the wiring must conform to all local codes, and have a minimum temperature rating of 105°C. All line voltage wire splices must be made inside the furnace junction box.

The integrated control module single humidifier terminal (HUM) is energized with 115 volts whenever the induced draft blower is energized. This terminal can also be used to provide 115 volt power to a humidifier transformer. The remaining primary transformer wire would be connected to the Line N on the control board. The integrated control module electronic air cleaner terminals (EAC) are energized with 115 volts whenever the circulator blower is energized.

**NOTE:** Wire routing must not to interfere with circulator blower operation, filter removal, or routine maintenance.

 **CAUTION**

**EDGES OF SHEET METAL HOLES MAY BE SHARP. USE GLOVES AS PRECAUTION WHEN REMOVING HOLE PLUGS.**

 **WARNING**

**TO AVOID THE RISK OF ELECTRICAL SHOCK, INJURY, OR DEATH, THE FURNACE MUST BE ELECTRICALLY GROUNDED IN ACCORDANCE WITH LOCAL CODES OR, IN THEIR ABSENCE, WITH THE LATEST EDITION OF THE NATIONAL ELECTRIC CODE.**

 **WARNING**

**HIGH VOLTAGE**

**DISCONNECT ALL POWER BEFORE SERVICING OR CHANGING ANY ELECTRICAL WIRING. MULTIPLE POWER SOURCES MAY BE PRESENT. FAILURE TO DO SO MAY CAUSE PROPERTY DAMAGE, PERSONAL INJURY OR DEATH.**

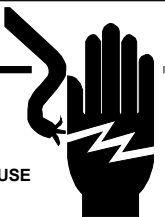

## 24 VOLT HUMIDIFIER

A 24 volt humidifier can be connected to the normally open terminal of the main pressure switch. The humidifier common would then be connected to “C” on the control board low voltage terminal strip.

If it is necessary for the installer to supply additional line voltage wiring to the inside of the furnace, the wiring must conform to all local codes, and have a minimum temperature rating of 105°C. All line voltage wire splices must be made inside the furnace junction box.

## 24 VOLT THERMOSTAT WIRING

**NOTE:** Low voltage connections can be made through either the right or left side panel. Wire routing must not interfere with circulator blower operation, filter removal, or routine maintenance.

A 40 V.A. transformer and an integrated electronic control are built into the furnace to allow use with most cooling equipment. Consult the wiring diagram, located in the Technical Manual or on the blower door for further details of 115 Volt and 24 Volt wiring.

## THERMOSTAT WIRING

The single stage furnace will have a “W” terminal and will use a single stage thermostat. The following drawing illustrates the typical field wiring for a heat only single stage system and a single stage heating/single stage cooling system. Refer to the following figures for proper connections to the integrated control module.

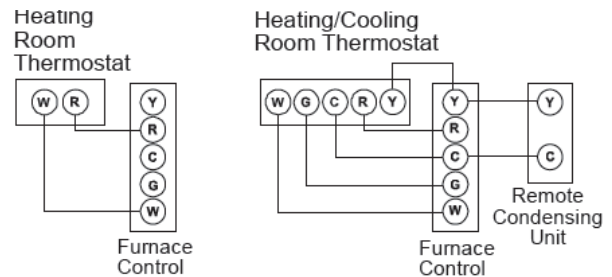

**Typical Field Wiring (24 VAC Control Circuit)**

## CIRCULATING AIR AND FILTERS

### DUCTWORK - AIR FLOW

Duct systems and register sizes must be properly designed for the C.F.M. and external static pressure rating of the furnace. Ductwork should be designed in accordance with the recommended methods of “Air Conditioning Contractors of America” manual D.

A duct system should be installed in accordance with Standards of the National Board of Fire Underwriters for the Installation of Air Conditioning, Warm Air Heating and Ventilating Systems, Pamphlets No. 90A and 90B.

A return air filter is not supplied with the furnace. The installer must supply a means of filtering all of the return air. Filter(s) shall comply with UL900 or CAN/ULC-S111 Standards.

*Upflow furnaces with air delivery of less than 1800 CFM:*

Use one side return or one bottom return ductwork connection.

*Upflow furnaces with air delivery of 1800 CFM or higher:*

Use two side returns or one side return and one bottom return connection.

Guide dimples locate the side and bottom return cutout locations. Use a straight edge to scribe lines connecting the dimples. Cut out the opening on these lines. An undersized opening will cause reduced airflow. For bottom return connection, remove the bottom of the cabinet before setting the furnace on the raised platform or return air duct.

A closed return duct system must be used, with the return duct connected to the furnace. **NOTE: Ductwork must never be attached to the back of the furnace.** Supply and return connections to the furnace may be made with flexible joints to reduce noise transmission, if desired. If a central return is



# SYSTEM OPERATION

used, a connecting duct must be installed between the unit and the utility room wall so the blower will not interfere with combustion air or draft. The room, closet, or alcove must not be used as a return air chamber.

When the furnace is used in connection with a cooling unit, the furnace should be installed in parallel with or on the upstream side of the cooling unit to avoid condensation in the heating element. With a parallel flow arrangement, the dampers or other means used to control the flow of air must be adequate to prevent chilled air from entering the furnace and, if manually operated, must be equipped with means to prevent operation of either unit unless the damper is in the full heat or cool position.

When the furnace is heating, the temperature of the return air entering the furnace must be between **55°F** and **100°F**.

## UPRIGHT FILTER INSTALLATIONS

Depending on the installation and/or customer preference, differing filter arrangements can be applied. Filters can be installed in the central return register and a side panel external filter rack kit (upflow filter kit # EFR02). As an alternative a media air filter or electronic air cleaner can be used as the requested filter. Refer to the following minimum filter requirement charts for determination of the minimum filter area to ensure proper unit performance. **The following figures** show possible filter locations. **NOTE:** A ductwork access door must be used in counterflow applications to allow filter removal. If the filter rack is used, the side of the plenum must be at least as tall as dimension "A" shown in the following illustration. For dimension of "A" refer to the following chart. Refer to Minimum Filter Area tables to determine filter area requirement. **NOTE:** Filters can also be installed elsewhere in the duct system such as a central return.

## Horizontal Installations

Filter(s) must be installed external to the furnace casing for horizontal installations. For most installations it is preferable to use a central return with filters installed in the duct behind the return air grill. In this way filter replacement is relatively simple by merely removing the grille, rather than going into the attic or crawl space.

## ADDITIONAL FILTERING ACCESSORIES

### External Filter Rack Kit (EFR02)

The external filter rack kit is intended to provide a location external to the furnace casing, for installation of a permanent filter on upflow model furnaces. The rack is designed to mount over the indoor blower compartment area of either side panel, and provide filter retention as well as a location for attaching return air ductwork.

### Electronic Air Cleaner (ASAS and GSAS) or Media Air Cleaner (AMU and GMU)

The electronic air cleaner and media air cleaner are multi-positional high efficiency air filtration devices that can be installed in any position, except with the access door facing down. The best location for the air cleaner is in the return air duct next to the blower compartment. Before installing

the air cleaner, consider the application. The electronic air cleaner must be readily accessible for periodic inspection and cleaning of the pre-filters and electronic cells while the media air cleaner must be readily accessible for periodic inspection and replacement of the Media Air Cleaner (AMU and GMU) filter cartridge (3 per carton) M0-1056, M1-1056, M2-1056, M8-1056, to maintain maximum efficiency and trouble-free operation. Carbon Filters 1156-3 and 1856-3 (set of 3) are also available. See Product Catalog for exact filter for your model.

## NORMAL SEQUENCE OF OPERATION

### POWER UP

1. 115 VAC power applied to furnace.
2. Integrated ignition control module performs internal checks.
3. Integrated ignition control module LED will light.
4. Integrated ignition control monitors safety circuits continuously.
5. Furnace awaits call from thermostat.

### NORMAL HEATING SEQUENCE

1. R and W thermostat contacts close, initiating a call for heat.
2. Integrated control module performs safety circuit checks.
3. The induced draft blower is energized causing pressure switch contacts to close. Induced draft blower remains energized for pre-purge period.
4. Ignitor warm up begins after pre-purge is completed. The ignition control has a WARM UP PERIOD OF 17 SECONDS.
5. Gas valve opens at end of ignitor warm up period, delivering gas to burners to establish flame.
6. The control checks for a signal from the flame sensor within seven (4) seconds after the gas valve is energized. Gas will only continue to flow if a flame signal is present.
7. Circulator blower is energized on heat speed following a fixed thirty (30) second blower on delay.
8. Furnace runs, integrated control module monitors safety circuits continuously.
9. R and W thermostat contacts open, allowing the gas valve to cycle off.
10. Induced draft blower is de-energized following a fifteen (15) -second post purge.
11. Circulator blower is de-energized following heat off delay period.
12. Furnace awaits next call from thermostat.

# SYSTEM OPERATION

## Cooling Mode

The normal operational sequence in cooling mode is as follows:

1. R and Y thermostat contacts close, initiating a call for cool.
2. Integrated control module performs safety circuit checks.
3. Outdoor fan and compressor are energized.
4. Circulator blower is energized on cool speed following a fixed seven (7) second on delay.
5. Furnace circulator blower and outdoor cooling unit run, integrated control module monitors safety circuits continuously.
6. R and Y thermostat contacts open, completing the call for cool.
7. Outdoor fan and compressor are de-energized.
8. Circulator blower is de-energized following a fixed sixty five (65) second cool off delay period.
9. Furnace awaits next call from thermostat.

## Fan Only Mode

The normal operational sequence in fan only mode is as follows:

1. R and G thermostat contacts close, initiating a call for fan.
2. Integrated control module performs safety circuit checks.
3. Circulator blower is energized on **heat speed**. Electronic air cleaner terminals are energized.
4. Circulator blower runs, integrated control module monitors safety circuits continuously.
5. R and G thermostat contacts open, completing the call for fan.
6. Furnace awaits next call from thermostat
7. Furnace awaits next call from thermostat.

## HEATING - Abnormal Operation

The following presents the probable causes of questionable furnace operation and how to fix them. Look through the observation window in the blower access door and make a note of the number of flashes in sequence between pauses. Next, refer to the *Troubleshooting Chart* on the following pages for an interpretation of the LED signals and to the information in this section for a description of the problem.

1. **Internal Control Failure with Integrated Ignition Control.** Check for voltage to the furnace and low voltage at the control board. Check for blown fuse on the control board. If the control determines it has an internal fault, it enters a locked-out state. Any of the situations mentioned will cause the diagnostic LED to provide **no signal**. The control board should only be replaced after all other checks from the *Troubleshooting Chart* have been verified.
2. **System Lockout.** If a flame is not sensed during the first seven (4) seconds after the gas valve is energized, the control turns off the gas. There will then be a 30 second delay while the induced draft blower is energized to purge the heat exchanger. The ignitor will next be energized and preheated. The gas valve will then be energized. If flame

is not sensed in seven (4) seconds the gas valve will be de-energized and another purge will occur. The control will cycle the gas valve a total of three (3) times before it determines it cannot establish measurable combustion and enters a locked out state. The diagnostic light code for this problem is **one short flash** followed by a longer pause. The control can be reset and brought out of lockout mode by turning the thermostat off for more than (5) seconds and less than (20) seconds and then back on. It can also be reset by turning off the electrical disconnect switch to the furnace for a minimum of 5 seconds.

**NOTE:** The control board will automatically reset one hour after lockout occurs. If the furnace frequently has to be reset, it means that a problem exists that should be corrected. Refer to *Troubleshooting Chart* on the following pages for aid in determining the cause.

3. **Pressure Switch Stuck Closed.** If the control senses the pressure switch is closed when the induced draft blower is off, it waits until the fault is corrected. The diagnostic light code for this problem is **2 flashes**. The probable cause is either a faulty pressure switch or wiring.
4. **Pressure Switch Stuck Open.** If, after the induced draft blower is energized, the pressure switch does not close within 5 minutes, the control will go into a 1-hour lockout. The control will automatically reset from lockout and restart the ignition sequence. The diagnostic light code for this problem is **three short flashes** followed by a pause. The probable causes are either disconnected hose to the pressure switch, faulty pressure switch or wiring, or restricted air intake or flue piping.
5. **Open Primary or Auxiliary Limit.** If the limit control opens, the air circulator blower will be turned on until the limit closes. The induced draft blower will turn off for 5 seconds then turn off. The diagnostic light code for this problem is **four short flashes** followed by a pause. The probable cause is either low conditioned air flow due to dirty filter or resistance in duct work, faulty limit, faulty blower, or blower speed set to low.
6. **Flame Sensed with No Call for Heat.** If the control senses a flame when the gas valve is de-energized, it will run the air circulation blower and the induced draft blower continuously with no further furnace operation. The diagnostic flash code for this is a **five flashes**. **The probable causes are either a short to ground in flame sense circuit, miswiring, lingering burner flame or a slow closing gas valve.**
7. **Open Rollout Limit/Open Control Board Fuse.** If the rollout control opens, the air circulator blower will be energized all the time. The diagnostic light code for this problem is **six flashes** followed by a pause. The probable cause is either restricted flue piping or improper air requirements.

# SYSTEM OPERATION

8. **Low Flame Sense Signal.** If the furnace continues to operate and the micro-amp signal from the flame sensor falls below specified level, the diagnostic light code for this problem will be **seven flashes** followed by a pause. The probable cause is either a coated/oxidized sensor, incorrectly positioned sensor in burner flame or lazy burner flame due to improper gas pressure or combustion air.
9. **Igniter circuit or poor ground.** Improperly connected igniter, bad igniter or poor ground to the equipment. The diagnostic light code for this problem is **eight flashes**.

## Combustion Quality

Combustion quality can be affected by several factors. Major factors are venting and draining.

## Venting

The venting system should be planned and installed with the following in mind;

- Should not be longer than necessary
- Use 45° elbows rather than 90° elbows when possible
- Must not sag or otherwise trap condensate
- Use longest radius fittings possible
- If using 3" venting, make the transition from 2" to 3" as close as practically possible
- Make sure there is no flue gas recirculation into the combustion air pipe

## Condensate Drainage

Furnace combustion can be affected if a furnace is holding condensate. Check for proper connections of drain hoses, make sure furnace condensate trap is clean. Make sure furnace is not improperly sloped. Make sure air conditioning coil drain is not interfering with furnace drain.

## Other Causes

1. Manifold Gas Pressure must be set for the gas being used, Natural or L.P., high and low firing rates. If converted to L.P. gas, check size of all orifices
2. Remove Draft Inducer, Check the integrity of the gasket between the inducer and the collector box cover, any air leak here will have a negative effect on combustion. Check the orifice hole in the collector box, it must be free of burrs on both sides
3. Make sure burners are clean, not out of position and line up correctly with exchanger tubes, including the heat exchanger orifice plate between the burners and the heat exchanger tubes, make sure it is not loose, missing a screw or hanging down between the burners and heat exchangers causing flame impingement.
4. Make sure the field installed gas line is not binding and causing distortion of burner assembly
5. If the furnace is installed as a one pipe system; make sure the surrounding area and structure are adequate to provide combustion air

6. Make sure there are no cabinet air leaks allowing supply air to affect combustion
7. If heat exchanger integrity is uncertain, follow procedures in Service Bulletin SF-041

## TWINNING



### CAUTION

TO PREVENT UNRELIABLE OPERATION OR EQUIPMENT DAMAGE, THE GAS MANIFOLD PRESSURE MUST BE AS SPECIFIED ON THE UNIT RATING PLATE. ONLY MINOR ADJUSTMENTS SHOULD BE MADE BY ADJUSTING THE GAS VALVE PRESSURE REGULATOR.



### WARNING

POSSIBLE PROPERTY DAMAGE, PERSONAL INJURY OR DEATH MAY OCCUR IF THE CORRECT CONVERSION KITS ARE NOT INSTALLED. THE APPROPRIATE KITS MUST BE APPLIED TO INSURE SAFE AND PROPER FURNACE OPERATION. ALL CONVERSIONS MUST BE PERFORMED BY A QUALIFIED INSTALLER OR SERVICE AGENCY.

Furnaces may be twinned without the use of a twinning kit. Furnaces must be the same model and equipped with PCBBF145 control boards. Follow the diagram provided in this manual. Connection of the "twin" terminals of each control together will allow simultaneous operation of two or more furnace indoor blowers to operate synchronously on a common duct system. Field installed low voltage thermostat wiring, 3/16" terminals are required to make this connection. An isolating relay (24 VAC coil & N/O SPST) contacts is also required if the furnaces are not fed from the same line voltage phase. A pulsing DC signal is used to share the call for fan operation between furnaces. The duration of the Pulse width determines the speed that the reading control will energize its blower motor.

# SCHEDULED MAINTENANCE

**⚠ WARNING**

---

**HIGH VOLTAGE**  
DISCONNECT ALL POWER BEFORE SERVICING, REMOVING THE FILTER OR PREFORING ANY OTHER MAINTENEACE. MULTIPLE POWER SOURCES MAY BE PRESENT. FAILURE TO DO SO MAY CAUSE PROPERTY DAMAGE, PERSONAL INJURY OR DEATH.



## Maintenance

Improper filter maintenance is the most common cause of inadequate heating or cooling performance. Filters should be cleaned (permanent) or replaced (disposable) every two months or as required. It is the owner's responsibility to keep air filters clean. When replacing a filter, it must be replaced with a filter of the same type and size.

## Filter Removal

Depending on the installation, differing filter arrangements can be applied. Filters can be installed in the central return register, the bottom of the blower compartment (upflow only), a side panel external filter rack kit (upflow only), or the ductwork above a counterflow furnace. A media air filter or electronic air cleaner can be used as an alternate filter. The filter sizes given in the *Product Design* section of this manual or the product *Specification Sheet* must be followed to ensure proper unit performance. Refer to the following information for removal and installation of filters.

## FILTER REMOVAL PROCEDURE

### Media Air Filter or Electronic Air Cleaner Removal

Follow the manufacturer's directions for service.

### Horizontal Unit Filter Removal

Filters in horizontal installations are located in the central return register.

## INDUCED DRAFT AND CIRCULATION BLOWERS

The bearings in the induced draft blower and circulator blower motors are permanently lubricated by the manufacturer. No further lubrication is required. Check motor windings for accumulation of dust which may cause overheating. Clean as necessary.

## CONDENSATE DRAINAGE SYSTEM (QUALIFIED SERVICER ONLY)

The drain tubes, standpipe, and field supplied drain line must be checked annually and cleaned as often as necessary to ensure proper condensate drainage.

## FLAME SENSOR (QUALIFIED SERVICER ONLY)

Under some conditions, the fuel or air supply can create a nearly invisible coating on the flame sensor. This coating acts as an insulator, causing a drop in the flame sensing signal. If this occurs, a qualified servicer must carefully clean the flame sensor with steel wool. After cleaning, the flame sensor output should be as listed on the specification sheet.

## BURNERS

**⚠ WARNING**

---

**HIGH VOLTAGE**  
ELECTRICAL COMPONENTS ARE CONTAINED IN BOTH COMPARTMENTS. TO AVOID ELECTRICAL SHOCK, INJURY OR DEATH, DO NOT REMOVE ANY INTERNAL COMPARTMENT COVERS OR ATTEMPT ANY ADJUSTMENT. CONTACT A QUALIFIED SERVICE AGENT AT ONCE IF AN ABNORMAL FLAME APPEARANCE SHOULD DEVELOP.



Periodically during the heating season make a visual check of the burner flames. Turn the furnace on at the thermostat. Wait a few minutes since any dislodged dust will alter the normal flame appearance. Flames should be stable, quiet, soft and blue with slightly orange tips. They should not be yellow. They should extend directly outward from the burner ports without curling downward, floating or lifting off the ports.

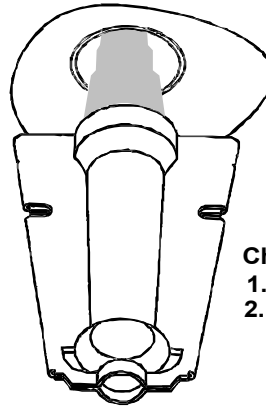

**Check the burner flames for:**

- 1. Stable, soft and blue**
- 2. Not curling, floating, or lifting off.**

Burner Flame

## TEST EQUIPMENT

Proper test equipment for accurate diagnosis is as essential as regular hand tools.

The following is a must for every service technician and service shop.

1. Dial type thermometers or thermocouple meter (optional) - to measure dry bulb temperature.
2. Amprobe - to measure amperage and voltage.
3. Volt-Ohm Meter - testing continuity, capacitors, and motor windings.
4. Inclined Manometer - to measure static pressure, pressure drop across coils, filters, and draft.
5. Water Manometer (12") - to test gas inlet and manifold pressure.

Other recording type instruments can be essential in solving abnormal problems, however, in many instances they may be rented from local sources.

Proper equipment promotes faster, more efficient service and accurate repairs resulting in fewer call backs.

# SCHEDULED MAINTENANCE

## HEATING PERFORMANCE TEST

Before attempting to diagnose an operating fault, run a heating performance test and apply the results to the *Service Problem Analysis Guide*.

To conduct a heating performance test, the BTU input to the furnace must be calculated.

After the heating cycle has been in operation for at least fifteen minutes and with all other gas appliances turned off, the gas meter should be clocked.

To find the BTU input, multiply the number of cubic feet of gas consumed per hour by the heating value of the gas being used. (The calorific value of the gas being used is found by contacting your local utility.)

**EXAMPLE:** It is found by the gas meter, that it takes forty (40) seconds for the hand on the cubic foot dial to make one complete revolution, with all appliances off, except the furnace. Take this information and locate it on the gas rate chart. Observe the forty (40) seconds, locate and read across to the one (1) cubic foot dial column. There we find the number 90, which shows that ninety (90) cubic feet of gas will be consumed in one (1) hour.

Let's assume the local gas utility has stated that the calorific value of the gas is 1,025 BTU per cubic foot.

Multiplying the ninety (90) cubic feet by 1,025 BTU per cubic foot gives us an input of 92,250 BTUH.

Checking the BTU input on the rating plate of the furnace being tested.

### **EXAMPLE:**

**INPUT:** 92,000 BTU/HR

**OUTPUT CAP:** 84,000

Should the figure you calculated not fall within five (5) percent of the nameplate rating of the unit, adjust the gas valve pressure regulator or resize orifices.



### **CAUTION**

**ALWAYS CONNECT A MONOMETER TO THE OUTLET TAP AT THE GAS VALVE BEFORE ADJUSTING THE PRESSURE REGULATOR. IN NO CASE SHOULD THE FINAL MANIFOLD PRESSURE VARY MORE THAN PLUS OR MINUS .3 INCHES WATER COLUMN FROM 3.5 INCHES WATER COLUMN FOR NATURAL GAS OR 10 INCHES WATER COLUMN FOR PROPANE GAS.**

To adjust the pressure regulator on the gas valve, turn down (clockwise) to increase pressure and input, and out (counterclockwise) to decrease pressure and input.

Since normally propane gas is not installed with a gas meter, clocking will be virtually impossible. The gas orifices used with propane are calculated for 2500 BTU per cubic foot gas and with proper inlet pressures and correct piping size, full capacity will be obtained.

With propane gas, no unit gas valve regulator is used; however, the second stage supply line pressure regulator should be adjusted to give 10" water column with all other gas consuming appliances running.

The dissipation of the heat transferred to the heat exchanger is now controlled by the amount of air circulated over its surface.

The amount (CFM) of air circulated is governed by the external static pressure in inches of water column of duct work, cooling coil, registers, etc., applied externally to the unit versus the motor speed tap (direct drive) or pulley adjustments of the motor and blower (belt drive).

A properly operating unit must have the BTU per hour input and CFM of air, within the limits shown to prevent short cycling of the equipment. As the external static pressure goes up, the temperature rise will also increase. Consult the proper tables for temperature rise limitation.

# SCHEDULED MAINTENANCE

*MES92 Pressure Switch Trip Points And Usage Chart					
Model	Coil Cover Set Point on Pressure Fall (PF) W.C.	Coil Cover Max Make On Pressure Rise W.C.	ID Blower Set Point on Pressure Fall (PF) W.C.	ID Blower Max Make On Pressure Rise W.C.	ID Blower Coil Cover Pressure Switch Assembly Part #
*MES920403ANAA	- 0.10 ± .05	-0.25	- 0.20 ± .05	-.035	0130F00641
*MES920603BNAA	- 0.10 ± .05	-0.25	- 1.20 ± .05	-1.41	0130F00480
*MES920803BNAA	- 0.10 ± .05	-0.25	- 0.97 ± .05	-1.12	0130F00479
*MES920804CNAA	- 0.10 ± .05	-0.25	- 1.20 ± .05	-1.41	0130F00480
*MES920805CNAA	- 0.10 ± .05	-0.25	- 1.20 ± .05	-1.20	0130F00480
*MES921004CNAA	- 0.10 ± .05	-0.25	- 0.97 ± .05	-1.12	0130F00479
*MES921005CNAA	- 0.10 ± .05	-0.25	- 0.97 ± .05	-1.12	0130F00479
*MES921205DNAA	- 0.10 ± .05	-0.25	- 1.20 ± .05	-1.41	0130F00480

*MES96 / *CES96 Pressure Switch Trip Points And Usage Chart					
Model	Coil Cover Set Point on Pressure Fall (PF) W.C.	Coil Cover Max Make On Pressure Rise W.C.	ID Blower Set Point on Pressure Fall (PF) W.C.	ID Blower Max Make On Pressure Rise W.C.	ID Blower Coil Cover Pressure Switch Assembly Part #
*MES960403ANAA	- 0.10 ± .05	- 0.25	- 0.35 ± .05	- 0.50	0130F00642
*MES960603BNAA	- 0.10 ± .05	- 0.25	- 1.49 ± .07	- 1.70	0130F00478
*MES960803BNAA	- 0.10 ± .05	- 0.25	- 1.27 ± .07	- 1.48	0130F00477
*MES960804CNAA	- 0.10 ± .05	- 0.25	- 1.27 ± .07	- 1.48	0130F00477
*MES960805CNAA	- 0.10 ± .05	- 0.25	- 1.27 ± .07	-1.48	0130F00477
*MES961004CNAA	- 0.10 ± .05	- 0.25	- 1.27 ± .07	- 1.48	0130F00477
*MES961205DNAA	- 0.10 ± .05	- 0.25	- 0.85 ± .05	- 1.00	0130F00476
*CES960403BNAA	- 0.08 ± .04	- 0.16	- 1.49 ± .07	- 1.70	0130F00484
*CES960603BNAA	- 0.10 ± .05	- 0.25	- 1.49 ± .07	- 1.70	0130F00477
*CES960804CNAA	- 0.10 ± .05	- 0.25	- 1.49 ± .07	- 1.70	0130F00477
*CES961005CNAA	- 0.10 ± .05	- 0.25	- 1.49 ± .07	- 1.70	0130F00477
*CES961205CNAA	- 0.10 ± .05	- 0.25	- 0.85 ± .05	- 1.00	0130F00476

# SERVICING

## SERVICE NUMBERS

S-1	CHECKING VOLTAGE .....	35
S-2	CHECKING WIRING .....	35
S-3A	THERMOSTAT AND WIRING .....	35
S-3B	HEATING ANTICIPATOR.....	35
S-4	CHECKING TRANSFORMER AND CONTROL CIRCUIT.....	36
S-16A	CHECKING AIR CIRCULATOR BLOWER MOTOR (MULTI-SPEED ECM MOTOR) .....	36
S-200	CHECKING DUCT STATIC.....	37
S-201	CHECKING TEMPERATURE RISE .....	37
S-300	CHECKING PRIMARY LIMIT CONTROL.....	38
S-302	CHECKING FLAME ROLLOUT CONTROL.....	39
S-303	INDUCED DRAFT BLOWER MOTOR .....	40
S-304	CHECKING GAS VALVE (REDUNDANT).....	40
S-305	CHECKING MAIN BURNERS .....	40
S-306	CHECKING ORIFICES .....	40
S-307	CHECKING GAS PRESSURE.....	41
S-308	CHECKING HOT SURFACE IGNITOR.....	43
S-309	CHECKING FOR FLASHBACK.....	43
S-310	CHECKING PRESSURE SWITCH.....	43
S-311	HIGH ALTITUDE APPLICATION (USA).....	43
S-312	CHECKING FOR DELAYED IGNITION .....	44
S-313	CHECKING INTEGRATED IGNITION CONTROL BOARDS.....	44
S-314	CHECKING FLAME SENSOR.....	46

# SERVICING

As more and more electronic's are introduced to the Heating Trade, Polarization of incoming power and phasing of primary to secondary voltage on transformers becomes more important.

Polarization has been apparent in the Appliance industry since the introduction of the three prong plug, however, the Heating Industry does not use a plug for incoming power, but is hard wired.

Some of the electronic boards being used today, with flame rectification, will not function properly and/or at all without polarization of incoming power. Some also require phasing between the primary and secondary sides of step-down transformers.

We recommend that these two items be checked during normal installation and/or service calls. See as follows:

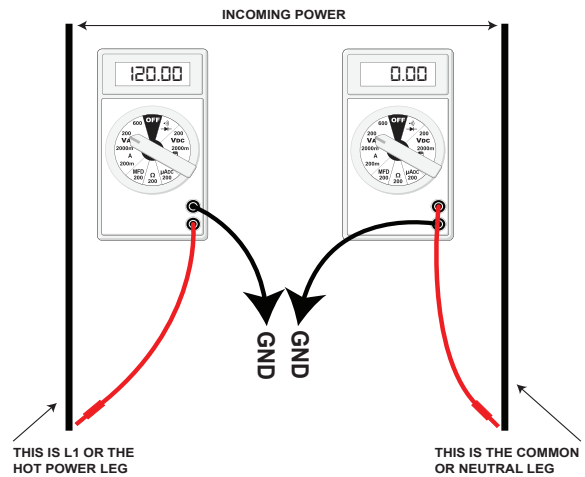

## CHECKING FOR PHASING - PRIMARY TO SECONDARY OF UNMARKED TRANSFORMERS\*

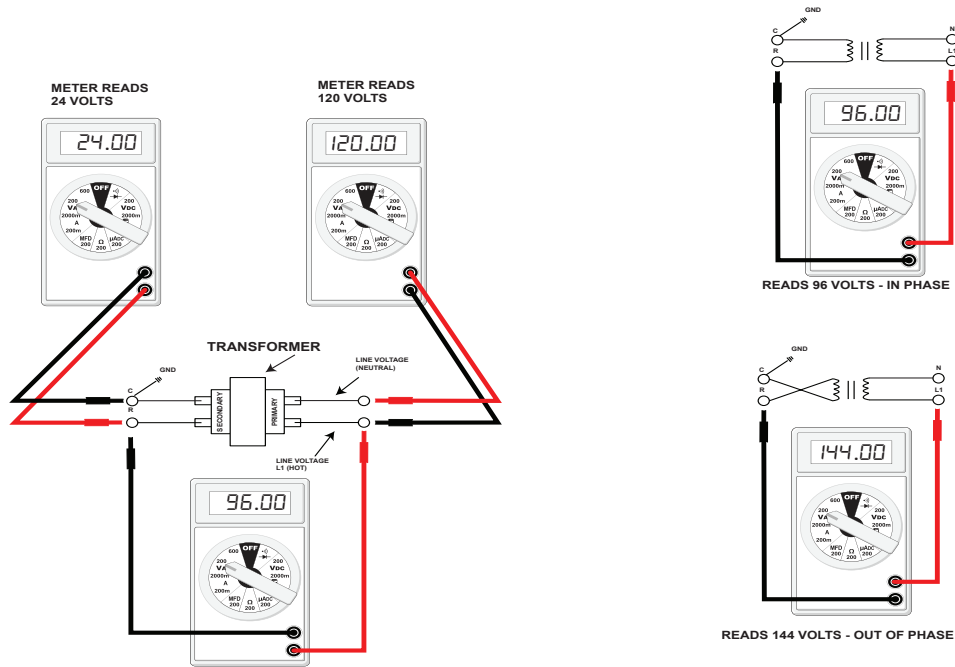

If meter reads approximately 96 volts - the primary to secondary are in phase - if reads approximately 144 volts out of phase - reverse low voltage wires.

**\*NOTE:** For flame rectification the common side of the secondary voltage (24 V) is cabinet grounded. If you were to bench test a transformer the primary neutral and secondary common must be connected together for testing purposes.

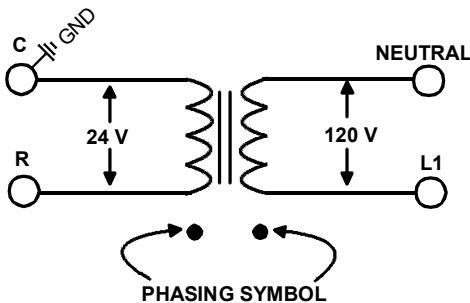

These then should be wired to the furnace accordingly. Some transformers will display phasing symbols as shown in the illustration to the left to assist in determining proper transformer phasing.

Checking for polarization and phasing should become a habit in servicing. Let's start now.



# SERVICING

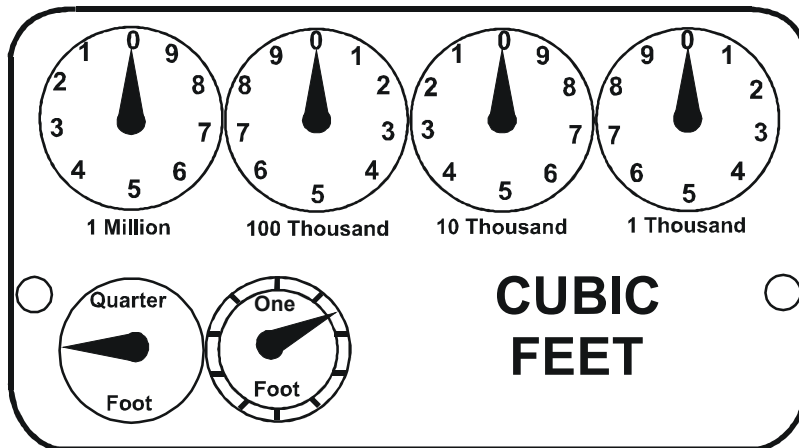

## GAS RATE -- CUBIC FEET PER HOUR



Seconds for One Revolution	Size of Test Dial					Seconds for One Revolution	Size of Test Dial				
	1/4 cu/ft	1/2 cu/ft	1 cu/ft	2 cu/ft	5 cu/ft		1/4 cu/ft	1/2 cu/ft	1 cu/ft	2 cu/ft	5 cu/ft
10	90	180	360	720	1800	36	25	50	100	200	500
11	82	164	327	655	1636	37	--	--	97	195	486
12	75	150	300	600	1500	38	23	47	95	189	474
13	69	138	277	555	1385	39	--	--	92	185	462
14	64	129	257	514	1286	40	22	45	90	180	450
15	60	120	240	480	1200	41	--	--	--	176	439
16	56	113	225	450	1125	42	21	43	86	172	429
17	53	106	212	424	1059	43	--	--	--	167	419
18	50	100	200	400	1000	44	--	41	82	164	409
19	47	95	189	379	947	45	20	40	80	160	400
20	45	90	180	360	900	46	--	--	78	157	391
21	43	86	171	343	857	47	19	38	76	153	383
22	41	82	164	327	818	48	--	--	75	150	375
23	39	78	157	313	783	49	--	--	--	147	367
24	37	75	150	300	750	50	18	36	72	144	360
25	36	72	144	288	720	51	--	--	--	141	355
26	34	69	138	277	692	52	--	--	69	138	346
27	33	67	133	265	667	53	17	34	--	136	340
28	32	64	129	257	643	54	--	--	67	133	333
29	31	62	124	248	621	55	--	--	--	131	327
30	30	60	120	240	600	56	16	32	64	129	321
31	--	--	116	232	581	57	--	--	--	126	316
32	28	56	113	225	563	58	--	31	62	124	310
33	--	--	109	218	545	59	--	--	--	122	305
34	26	53	106	212	529	60	15	30	60	120	300
35	--	--	103	206	514						

# SERVICING

Service Problem		No Heat			Unsatisfactory Heat			Test Method Remedy	See Service Procedure Reference			
POSSIBLE CAUSE	SYMPTOM	System Will Not Start	Burner Won't Ignite	Burner Ignites-Locks Out	Burner Shuts Off prior to T'Stat being Satisfied	Short Cycles	Long Cycles			Soot and/or Fumes	Too Much Heat	Not Enough Heat
Power Failure		●									Test Voltage	S-1
Blown Fuse		●									Test Voltage	S-4
Loose Connection		●									Check Wiring	S-2
Shorted or Broken Wires		●									Check Wiring	S-3A
No Low Voltage		●									Check Transformer	S-4
Faulty Thermostat		●				●	●		●	●	Check Thermostat	S-3A
Faulty Transformer		●									Check Transformer	S-4
Poor or High Resistance Ground				●							Measure Ground Resistance	S-17B
Improper Heat Anticipator Setting						●	●		●	●	Adjust Heat Anticipator Setting	S-3B
Improper Thermostat Location						●	●		●	●	Relocate Thermostat	S-316
Faulty Limit or Roll Out Switch			●		●						Test Control	S-300 / S-302
Faulty Flame Sensor				●							Test Flame Sensor	S-314
Faulty Ignition Control		●	●	●							Test Control	S-313
Gas Valve or Gas Supply Shut Off			●								Turn Valves to On Position	S-317
Faulty Induced Draft Blower			●					●			Test Induced Draft Motor	S-303
Faulty Blower Motor			●		●						Test Blower Motor	S-16A,B,C
Broken or Shorted Ignitor			●								Test Ignitor	S-308
Dirty Flame Sensor, Low UA				●							Clean Flame Sensor	S-314
Stuck Gas Valve			●					●	●		Replace Gas Valve	S-304
Faulty Gas Valve			●					●	●		Replace Gas Valve	S-304
Open Auxiliary Limit			●		●						Reset Control	S-301
Improper Air Flow or Distribution					●					●	Check Duct Static	S-200
Cycling on Limit					●	●				●	Check Controls & Temperature Rise	S-201 / S-300
Delayed Ignition								●			Test for Delayed Ignition	S-312
Flashback								●			Test for Flashback	S-309 / S-311
Orifice Size								●	●	●	Check Orifices	S-306 / S-311
Gas Pressure			●					●	●	●	Check Gas Pressure	S-307
Cracked Heat Exchanger								●			Check Burner Flames	S-305
Furnace Undersized							●			●	Replace with Proper Size Furnace	S-318
Furnace Oversized						●					Replace with Proper Size Furnace	S-318
Faulty Pressure Switch			●	●	●						Test Pressure Switch	S-310
Blocked or Restricted Flue								●			Check Flue/Draw down Pressure	S-310
Open Roll Out Switch			●	●							Test Flame Roll Out Control	S-302
Bouncing On Pressure Switch				●							Test Negative Pressure	S-310

# SERVICING

## S-1 CHECKING VOLTAGE

 <b>WARNING</b>	
<b>HIGH VOLTAGE</b> DISCONNECT ALL POWER BEFORE SERVICING OR CHANGING ANY ELECTRICAL WIRING. MULTIPLE POWER SOURCES MAY BE PRESENT. FAILURE TO DO SO MAY CAUSE PROPERTY DAMAGE, PERSONAL INJURY OR DEATH.	

1. Remove the burner door on furnaces to gain entry to the Junction Box.
2. Remove cover from the Junction Box and gain access to incoming power lines.

With Power ON:

 <b>WARNING</b>
<b>LINE VOLTAGE NOW PRESENT</b>

3. Using a voltmeter, measure the voltage across the hot and neutral connections.

**NOTE:** To energize the furnace, the Door Interlock Switch must be engaged at this point.

4. No reading - indicates open wiring, open fuse, no power, or faulty Door Interlock Switch from unit to fused disconnect service. Repair as needed.
5. With ample voltage at line voltage connectors, energize the furnace blower motor by jumpering terminals R to G on the integrated ignition control.
6. With the blower motor in operation, the voltage should be 115 volts  $\pm$  10 percent.
7. If the reading falls below the minimum voltage, check the line wire size. Long runs of undersized wire can cause low voltage. If wire size is adequate, notify the local power company of the condition.
8. After completing check and/or repair, replace Junction Box cover and reinstall the service panel doors.
9. Turn on electrical power and verify proper unit operation.

## S-2 CHECKING WIRING

 <b>WARNING</b>
<b>DISCONNECT ALL POWER BEFORE SERVICING.</b>

1. Check wiring visually for signs of overheating, damaged insulation and loose connections.
2. Use an ohmmeter to check continuity of any suspected open wires.
3. If any wires must be replaced, replace with AWM, 105°C. 2/64 thick insulation of the same gauge or its equivalent.

## CHECKING THERMOSTAT, WIRING AND ANTICIPATOR

### S-3A THERMOSTAT AND WIRING

 <b>WARNING</b>
<b>DISCONNECT ALL POWER BEFORE SERVICING.</b>

1. Remove the blower compartment door to gain access to the thermostat low voltage wires located at the furnace integrated control module terminals.
2. Remove the thermostat low voltage wires at the furnace control panel terminal board.
3. Jumper terminals R to W (or W1 and W2 for two-stage models) on the integrated ignition control.

With Power On (and Door Interlock Switch closed):

 <b>WARNING</b>
<b>LINE VOLTAGE NOW PRESENT</b>

4. Induced Draft Motor must run and pull in pressure switch.
5. If the hot surface ignitor heats and at the end of the ignitor warm-up period the gas valve opens and the burners ignite, the trouble is in the thermostat or wiring.
6. With power off, check the continuity of the thermostat and wiring. Repair or replace as necessary.

If checking the furnace in the air conditioning mode, proceed as follows.

7. With power off, Jumper terminals R to Y to G.
8. Turn on the power.
9. If the furnace blower motor starts and the condensing unit runs, then the trouble is in the thermostat or wiring. Repair or replace as necessary.
10. After completing check and/or repair of wiring and check and/or replacement of thermostat, reinstall blower compartment door.
11. Turn on electrical power and verify proper unit operation.

### S-3B HEATING ANTICIPATOR

On older thermostats the heating anticipator is a wire wound adjustable heater which is energized during the "ON" cycle to help prevent overheating of the conditioned space.

The anticipator is a part of the thermostat and if it should fail for any reason, the thermostat must be replaced. Modern thermostats do not have this type of heat anticipator. Many have a selector switch to adjust the number of cycles per hour.

# SERVICING

## Cooling Anticipator

The cooling anticipator is a small heater (resistor) in the thermostat. During the "OFF" cycle it heats the bimetal element helping the thermostat call for the next cooling cycle. This prevents the room temperature from rising too high before the system is restarted. A properly sized anticipator should maintain room temperature within 1 1/2 to 2 degrees.

The anticipator is fixed in the subbase and is not to be replaced. If the anticipator should fail for any reason, the subbase must be changed.

## S-4 CHECKING TRANSFORMER AND Control CIRCUIT

A step-down transformer 120 volt primary to 24 volt secondary, 40 VA (Heating and Cooling Models) supplies ample capacity of power for either operation.

 **WARNING**

**HIGH VOLTAGE**  
DISCONNECT ALL POWER BEFORE SERVICING OR CHANGING ANY ELECTRICAL WIRING. MULTIPLE POWER SOURCES MAY BE PRESENT. FAILURE TO DO SO MAY CAUSE PROPERTY DAMAGE, PERSONAL INJURY OR DEATH.



1. Remove blower compartment door to gain access to the thermostat low voltage wires located at the furnace integrated control module.
2. Remove the thermostat low voltage wires at the furnace integrated control module terminals.

With Power On (and Door Interlock Switch closed):

 **WARNING**

**LINE VOLTAGE NOW PRESENT**

3. Use a voltmeter, check voltage across terminals R and C. Must read 24 VAC.
4. No voltage indicates faulty transformer, open fuse, bad wiring, bad splice, or open door interlock switch.
5. Check transformer primary voltage at incoming line voltage connections, fuse, splices, and blower door interlock switch.
6. If line voltage is available to the primary side of transformer and not at secondary side, the transformer is inoperative. Replace.
7. After completing check and/or replacement of transformer and check and/or repair of control circuit, reinstall blower compartment door.
8. Turn on electrical power and verify proper unit operation.

## S-16A CHECKING AIR CIRCULATOR BLOWER MOTOR (MULTI-SPEED ECM MOTOR)

 **WARNING**

**DISCONNECT ALL POWER BEFORE SERVICING.**

1. Remove blower compartment door to gain access to the circulator blower motor and integrated ignition control.
2. Check for any obstruction that would keep the fan wheel / fan motor from turning.
3. Check wiring, the motor has two wiring harnesses, a main harness and a control harness. The main pin harness has: White neutral wire connected to the Neutral terminal on the control board. Black wire connected to the CIRC H terminal on the control board. Red wire connected to the COM terminal, which is a female spade connection next to the T1 – T4 wires on the control board.

Green ground wire connected to cabinet ground .

The control harness has:

Blue wire connected to T1 on the control board.

Red wire connected to T2 on the control board.

Orange wire connected to T3 on the control board.

Black wire connected to T4 on the control board.

The multi-speed ECM motor requires a line voltage power supply (black connected to CIRC H and white connected to neutral on the control board) as well as a signal on one of the speed taps (T1-T4).

The speed tap voltage is A.C. and can vary which tap is energized depending on DIP switch selection. The voltage reading from any one of the speed taps is referenced between the female COM terminal next to the speed taps on the control board. From COM to T1 or T2, T3, T4, you should read 24 VAC on the low voltage speed taps.

Motor Tap Identification		
CONNECTOR ID	DESCRIPTION	CONNECTOR VOLTAGE
L	LINE, L1	LINE, L1
G	GROUND	CHASSIS GROUND
N	LINE, L2	LINE, L2
C	SIGNAL COMMON	24VAC COMMON
1	TAP 1	24VAC
2	TAP 2	24VAC
3	TAP 3	24VAC
4	TAP 4	24VAC
5	TAP 5	24VAC

Heat Off Delay (S1-4)				
S1-4	Min	Nom	Max	Units
ON		*150		Seconds
OFF		100		Seconds

\* = DEFAULT SETTING

# SERVICING

COOL MOTOR SPEED DIP SWITCH SETTING (S1-1, S1-2, S1-3)					
		1 2 3	1 2 3	1 2 3	1 2 3
	Position	OFF OFF OFF	ON OFF OFF	ON ON OFF	OFF ON OFF
Motor Speed <b>COOL</b>	Y	T1	T2	T3	T4
		*1 2 3	1 2 3	1 2 3	1 2 3
	Position	OFF OFF ON	OFF ON ON	ON OFF ON	ON ON ON
Motor Speed <b>COOL</b>	Y	T1+T2	T1	T1	T1

\* = DEFAULT SETTING

HEAT MOTOR SPEED DIP SWITCH SETTING (S2-1, S2-2)					
		1 2	*1 2	1 2	1 2
	Position	OFF OFF	ON OFF	ON ON	OFF ON
Motor Speed <b>HEAT</b>	W	T1	T2	T3	T4

\* = DEFAULT SETTING

FAN MOTOR SPEED DIP SWITCH SETTING (S2-3, S2-4)					
		*3 4	3 4	3 4	3 4
	Position	OFF OFF	ON OFF	OFF ON	ON ON
Motor Speed <b>FAN</b>	G	T1	T2	T4	T1+T2

\* = DEFAULT SETTING

## S-200 CHECKING DUCT STATIC

The maximum and minimum allowable external static pressures are found in the specification section. These tables also show the amount of air being delivered at a given static by a given motor speed or pulley adjustment.

The furnace motor cannot deliver proper air quantities (CFM) against statics other than those listed.

Too great of an external static pressure will result in insufficient air that can cause excessive temperature rise, resulting in limit tripping, etc. Whereas not enough static may result in motor overloading.

To determine proper air movement, proceed as follows:

1. With clean filters in the furnace, use a draft gauge (inclined manometer) to measure the static pressure of the return duct at the inlet of the furnace. (Negative Pressure)
2. Measure the static pressure of the supply duct. (Positive Pressure)
3. Add the two (2) readings together for total external static pressure.

**NOTE:** Both readings may be taken simultaneously and read directly on the manometer if so desired. If an air conditioner coil or Electronic Air Cleaner is used in conjunction with the furnace, the readings must also include these components, as shown in the following drawing.

4. Consult proper tables for the quantity of air.

If the total external static pressure exceeds the minimum or maximum allowable statics, check for closed dampers, registers, undersized and/or oversized poorly laid out duct work.

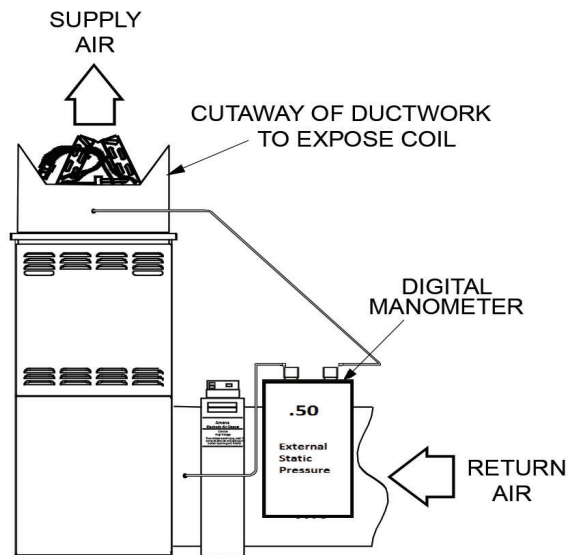

Checking Static Pressure

## S-201 CHECKING TEMPERATURE RISE

The more air (CFM) being delivered through a given furnace, the less the rise will be; so the less air (CFM) being delivered, the greater the rise. The temperature rise should be adjusted in accordance to a given furnace specifications and its external static pressure. An incorrect temperature rise may result in condensing in or overheating of the heat exchanger. An airflow and temperature rise table is provided in the blower performance specification section. Determine and adjust temperature rise as follows:

1. Operate furnace with burners firing for approximately ten minutes. Check BTU input to furnace - do not exceed input rating stamped on rating plate. Ensure all registers are open and all duct dampers are in their final (fully or partially open) position.
2. Place thermometers in the return and supply ducts as close to the furnace as possible. Thermometers must not be influenced by radiant heat by being able to "see" the heat exchanger.

CROSS-HATCHED AREA SUBJECTED TO RADIANT HEAT. DO NOT MEASURE SUPPLY AIR TEMPERATURE IN THIS AREA.

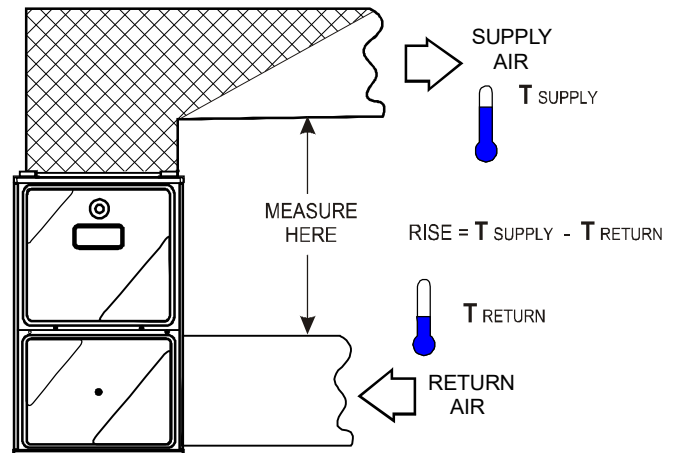

Checking Temperature Rise

# SERVICING

3. Subtract the return air temperature from the supply air temperature to determine the air temperature rise. Allow adequate time for thermometer readings to stabilize.
4. Adjust temperature rise by adjusting the circulator blower speed. Increase blower speed to reduce temperature rise. Decrease blower speed to increase temperature rise. Refer to *Circulator Blower Speed* section in the Product Design section of this manual for speed changing details. Temperature rise is related to the BTUH output of the furnace and the amount of air (CFM) circulated over the heat exchanger. Measure motor current draw to determine that the motor is not overloaded during adjustments.

## S-300 CHECKING PRIMARY LIMIT CONTROL

Primary limit controls are nonadjustable, automatic reset, bi-metal type limit control. Refer to the following drawing for the location of the primary limit.

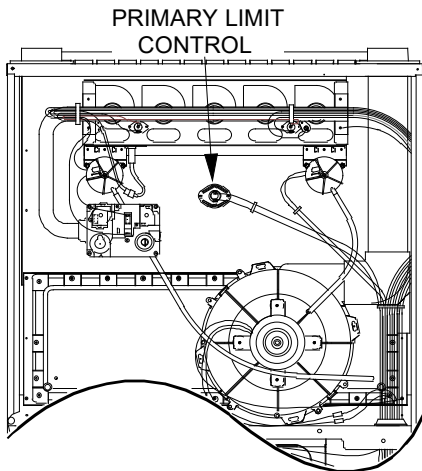

Primary Limit Control Location

The following drawing illustrates the style of limit switches used on the 90% furnaces.

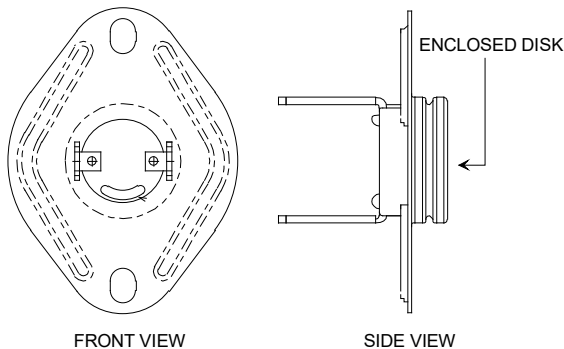

Primary Limit Control Style (90% Furnaces)

**WARNING**

**HIGH VOLTAGE**  
**DISCONNECT ALL POWER BEFORE SERVICING OR CHANGING ANY ELECTRICAL WIRING. MULTIPLE POWER SOURCES MAY BE PRESENT. FAILURE TO DO SO MAY CAUSE PROPERTY DAMAGE, PERSONAL INJURY OR DEATH.**

1. Remove burner compartment door to gain access to the primary limit.
2. Remove low voltage wires at limit control terminals.
3. With an ohmmeter, test between these two terminals as shown in the following drawing. The ohmmeter should read continuous unless heat exchanger temperature is above limit control setting. If not as above, replace the control.

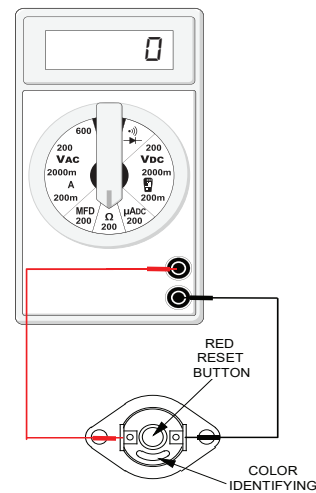

Testing Primary Limit Control

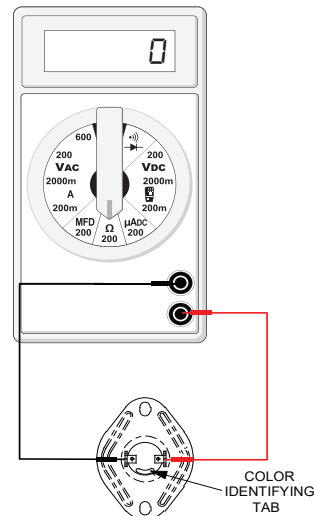

Testing Primary Limit Control (90% Furnaces)

4. After completing check and/or replacement of primary limit control, reinstall burner compartment door.
5. Turn on electrical power and verify proper unit operation.

# SERVICING

To aid in identifying these controls, refer to the *Primary Limit Charts* in furnace Technical Manual for part number, temperature setting and color(s) code.

## Manual Reset Auxiliary Limit Located in Blower Deck

The **90% single-stage** upflow furnaces use two auxiliary limit switch for control of high temperatures within the furnace or duct work. This control is preset, nonadjustable and auto reset. The control is located in the blower compartment of the furnace on the blower deck, as shown in the following illustration.

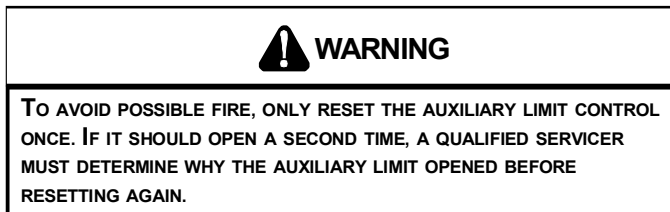
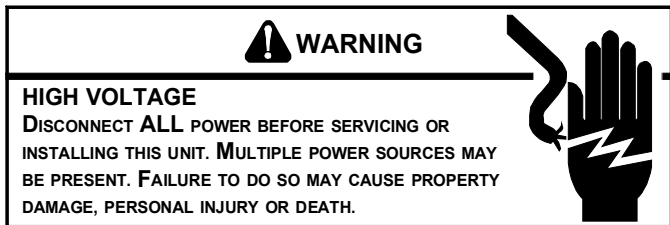

To aid in identifying these controls, color coded labels are attached to the back of the controls. Refer to the *Auxiliary Limit Charts* in furnace Technical Manual for color codes and temperature settings.

## S-302 CHECKING FLAME ROLLOUT CONTROL

A temperature activated manual reset control is mounted to the manifold assembly on 90% furnaces, as shown in the following illustrations.

Should read continuous unless heat exchanger temperature is above limit control setting. If not as above, replace the control.

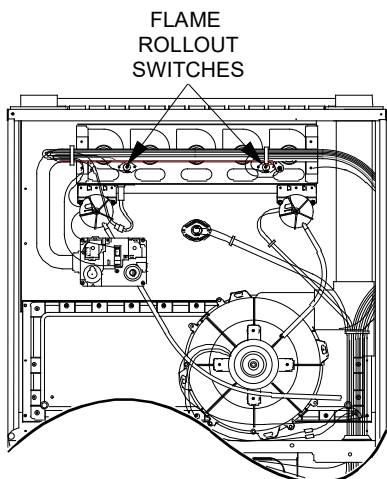

Flame Rollout Switch Location

The control is designed to open should a flame roll out or control opens, the air circulation blower will run continuously. On single-stage models, the ignition control diagnostic light will flash (6) six times indicating a trip of the rollout switch or an open control board fuse.

To aid in identifying these controls, color-coded labels have been affixed to the back of these controls. Refer to the Rollout Limit Charts in furnace Technical Manual for temperature settings and color codes.



1. Remove the burner compartment door to gain access to the rollout switch(es) mounted to burner bracket.

The servicer should reset the ignition control by opening and closing the thermostat circuit. Then look for the ignitor glowing which indicates there is power to the ignition control. Measure the voltage between each side of the rollout control and ground while the ignition control tries to power the gas valve.

2. Measure the voltage between each side of the rollout control and ground during the ignition attempt. Refer to the following figure.

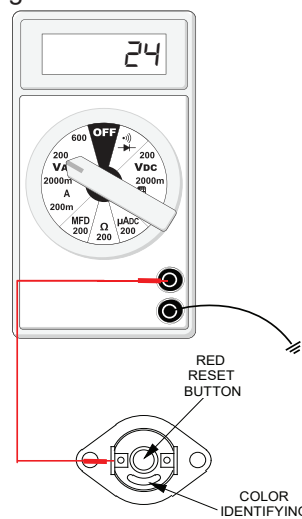



Checking Flame Rollout Switch

- a. If no voltage is measured on either side of control it indicates ignition control or wiring to control problem.
  - b. If voltage is measured on one side of the control and not the other it indicates the control is open.
  - c. If voltage is measured on both sides of the control the wiring to gas valve or valve is at fault.
3. After check and/or replacement of rollout switch, reinstall burner compartment door and verify proper unit operation.

# SERVICING

## S-303 INDUCED DRAFT BLOWER Motor

 <b>WARNING</b>	
<b>HIGH VOLTAGE</b> DISCONNECT ALL POWER BEFORE SERVICING OR INSTALLING THIS UNIT. MULTIPLE POWER SOURCES MAY BE PRESENT. FAILURE TO DO SO MAY CAUSE PROPERTY DAMAGE, PERSONAL INJURY OR DEATH.	

1. Remove burner compartment door to gain access to the induced draft blower motor.
2. Disconnect the motor wire leads from its connection point at the induced draft motor.
3. Using an ohmmeter, test for continuity between each of the motor leads.
4. Touch one probe of the ohmmeter to the motor frame (ground) and the other probe in turn to each lead. If the windings do not test continuous or a reading is obtained to ground, replace the motor.
5. If the windings have a continuity reading, reconnect wires. Turn power on to the furnace and turn the thermostat on in the heating mode. Check voltage for 115V at the induced draft motor terminals during the trial for ignition. If you have 115V and the motor does not run, replace the induced draft motor.
6. After completing check and/or replacement of induced draft motor, reinstall burner compartment door.
7. Turn on electrical power and verify proper unit operation.

### S-304 CHECKING GAS VALVE (Redundant)

A combination redundant operator type gas valve which provides all manual and automatic control functions required for gas fired heating equipment is used.

The valve provides control of main burner gas flow, pressure regulation, and 100 percent safety shut-off.

 <b>WARNING</b>
<b>DISCONNECT ALL POWER BEFORE SERVICING</b>

Single stage gas valves should be tested on the furnace with 24 VAC connected to the gas valve and manometers reading supply line and manifold pressures.

### S-305 CHECKING MAIN BURNERS

The main burners are used to provide complete combustion of various fuels in a limited space, and transfer this heat of the burning process to the heat exchanger.

Proper ignition, combustion, and extinction are primarily due to burner design, orifice sizing, gas pressure, primary and secondary air, vent and proper seating of burners.

Burners have been redesigned for 34.5" chassis furnaces. Overall length and width dimensions remain the same as 40" model burners. The burners used 34.5" models have burner head insert with larger diameter center hole and a larger number of surrounding holes.

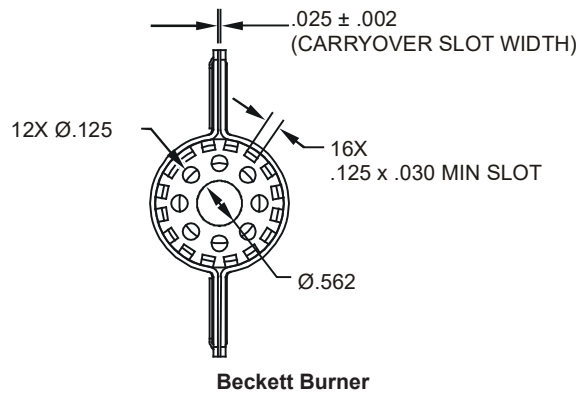

 <b>WARNING</b>
<b>DISCONNECT ALL GAS AND ELECTRICAL POWER SUPPLY.</b>

In checking main burners, look for signs of rust, oversized and undersized carry over ports restricted with foreign material, etc, refer to previous drawing. Burner cross-over slots should not be altered in size.

### S-306 CHECKING ORIFICES

Single stage furnaces are factory equipped with #45 gas orifices.

Orifices should be treated with care in order to prevent damage. They should be removed and installed with a box-end wrench in order to prevent distortion. In no instance should an orifice be peened over and redrilled. This will change the angle or deflection of the vacuum effect or entraining of primary air, which will make it difficult to adjust the flame properly.

 <b>WARNING</b>
<b>DISCONNECT ALL GAS AND ELECTRICAL POWER SUPPLY.</b>

1. Check orifice visually for distortion and/or burrs.
2. Check orifice size with orifice sizing drills.
3. If resizing is required, a new orifice of the same physical size and angle with proper drill size opening should be installed.



# SERVICING

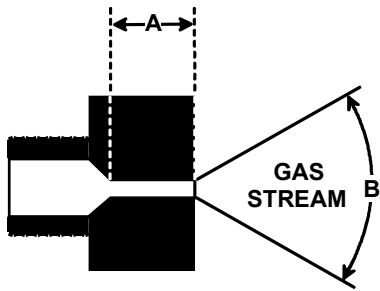

The length of Dimension "A" determines the angle of Gas Stream "B".

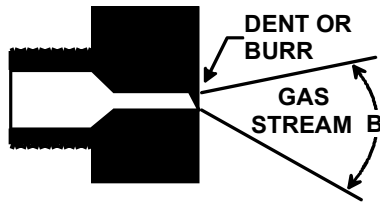

A dent or burr will cause a severe deflection of the gas stream.

## S-307 CHECKING GAS PRESSURE

### Gas Supply Pressure Measurement

**CAUTION**

**TO PREVENT UNRELIABLE OPERATION OR EQUIPMENT DAMAGE, THE INLET GAS SUPPLY PRESSURE MUST BE AS SPECIFIED ON THE UNIT RATING PLATE WITH ALL OTHER HOUSEHOLD GAS FIRED APPLIANCES OPERATING.**

Gas inlet and manifold pressures should be checked and adjusted in accordance to the type of fuel being consumed.

The line pressure supplied to the gas valve must be within the range specified below. The supply pressure can be measured at the gas valve inlet pressure tap or at a hose fitting installed in the gas piping drip leg. The supply pressure must be measured with the burners operating. To measure the gas supply pressure, use the following procedure.

**WARNING**

**DISCONNECT ELECTRICAL POWER AND SHUT OFF GAS SUPPLY.**

1. After turning off gas to furnace at the manual gas shutoff valve external to the furnace, remove burner compartment door to gain access to the gas valve.
2. Connect a calibrated water manometer (or appropriate gas pressure gauge) at either the gas valve inlet pressure tap or the gas piping drip leg as shown in the following figures.

**NOTE:** At either location, a hose fitting must be installed prior to making the hose connection.

**NOTE:** Use adapter kit #0151K00000S to measure gas pressure on White-Rodgers 36G22 gas valves.

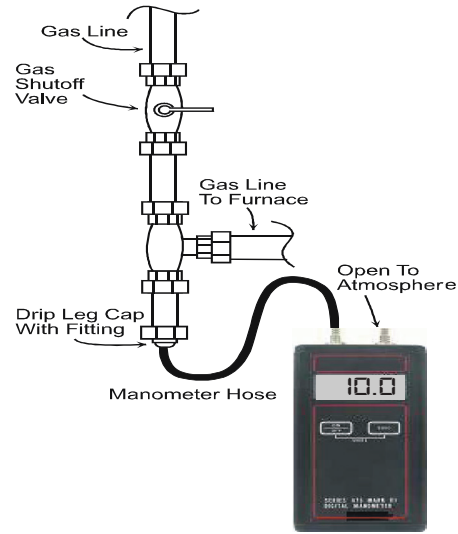

Measuring Inlet Gas Pressure (Alternate Method)

3. Turn ON the gas and electrical power supply and operate the furnace and all other gas consuming appliances on the same gas supply line.
4. Measure furnace gas supply pressure with burners firing. Supply pressure must be within the range specified in the following table.

INLET GAS SUPPLY PRESSURE		
Natural Gas	Minimum: 4.5" w.c.	Maximum: 10.0" w.c.
Propane Gas	Minimum: 11.0" w.c.	Maximum: 13.0" w.c.

If supply pressure differs from above, make necessary adjustments to pressure regulator, gas piping size, etc., and/or consult with local gas utility.

**WARNING**

**HIGH VOLTAGE**  
**DISCONNECT ALL ELECTRICAL POWER AND SHUT OFF GAS SUPPLY BEFORE SERVICING OR INSTALLING THIS UNIT.**  
**MULTIPLE POWER SOURCES MAY BE PRESENT. FAILURE TO DO SO MAY CAUSE PROPERTY DAMAGE, PERSONAL INJURY OR DEATH.**

5. Disconnect manometer after turning off gas at manual shutoff valve. Reinstall plug before turning on gas to furnace.
6. Turn OFF any unnecessary gas appliances started in step 3.
7. Turn on gas to furnace and check for leaks. If leaks are found, repair and then reinstall burner compartment door.
8. Turn on electrical power and verify proper unit operation.

# SERVICING

## Gas Manifold Pressure Measurement and Adjustment



**TO PREVENT UNRELIABLE OPERATION OR EQUIPMENT DAMAGE, THE GAS MANIFOLD PRESSURE MUST BE AS SPECIFIED ON THE UNIT RATING PLATE. ONLY MINOR ADJUSTMENTS SHOULD BE MADE BY ADJUSTING THE GAS VALVE PRESSURE REGULATOR.**

**NOTE:** Use adapter kit #0151K00000S to measure gas pressure on White-Rodgers 36J22 gas valves.

Only small variations in gas pressure should be made by adjusting the gas valve pressure regulator. The manifold pressure must be measured with the burners operating. To measure and adjust the manifold pressure, use the following procedure.



**HIGH VOLTAGE**  
DISCONNECT ALL ELECTRICAL POWER AND SHUT OFF GAS SUPPLY BEFORE SERVICING OR INSTALLING.

1. After turning off gas to furnace at the manual gas shutoff valve external to the furnace, remove burner compartment door to gain access to the gas valve.
2. Connect a calibrated water manometer (or appropriate gas pressure gauge) at the gas valve outlet pressure tap. Refer to *Measuring Gas Pressure: Single Stage Valves* figure for single stage valve outlet pressure tap connections.



**LINE VOLTAGE NOW PRESENT**

3. Turn ON the gas and electrical power supply and operate the furnace.
4. Measure gas manifold pressure with burners firing. Adjust manifold pressure using the table below.

Manifold Gas Pressure	
Natural Gas	3.5" w.c.
Propane Gas	10.0" w.c.

The final manifold pressure must not vary more than  $\pm 0.3$  " w.c. from the above specified pressures. Any necessary major changes in gas flow rate should be made by changing the size of the burner orifice.

5. White-Rodgers 36J22 Valves:
  - a. Back outlet pressure test screw (inlet/outlet pressure boss) out one turn (counterclockwise, not more than one turn).
  - b. Attach a hose and manometer to the outlet pressure outlet pressure boss.

- c. Turn ON the gas supply.
- d. Turn on power and close thermostat "R" and "W1" contacts to provide a call for heat.
- e. Measure the gas manifold pressure with burners firing. Adjust manifold pressure using the *Manifold Gas Pressure* table shown below.
- f. Remove regulator cover screw from the outlet pressure regulator adjust tower and turn screw clockwise to increase pressure or counterclockwise to decrease pressure. Replace regulator cover screw.
- i. Turn off all electrical power and gas supply to the system.
- j. Remove the manometer hose from the hose barb fitting or outlet pressure boss.
- k. Turn outlet pressure test screw in to seal pressure port (clockwise, 7 in-lb minimum).

### 6. Honeywell VR8215 Valve:

- a. Remove the outlet pressure boss plug. Install an 1/8" NPT hose barb fitting into the outlet pressure tap.
- b. Attach a hose and manometer to the outlet pressure barb fitting.
- c. Turn ON the gas supply.
- d. Turn on power and close thermostat "R" and "W1" contacts to provide a call for low stage heat.
- e. Measure the gas manifold pressure with burners firing. Adjust manifold pressure using the *Manifold Gas Pressure* table shown.
- f. Remove regulator cover screw from the outlet pressure regulator adjust tower and turn screw clockwise to increase pressure or counterclockwise to decrease pressure. Replace regulator cover screw.
- i. Turn off all electrical power and gas supply to the system.
- j. Remove the manometer hose from the hose barb fitting or outlet pressure boss.
- k. Remove the 1/8" NPT hose barb fitting from the outlet pressure tap. Replace the outlet pressure boss plug and seal with a high quality thread sealer.



**HIGH VOLTAGE**  
DISCONNECT ALL ELECTRICAL POWER AND SHUT OFF GAS SUPPLY BEFORE SERVICING OR INSTALLING THIS UNIT. MULTIPLE POWER SOURCES MAY BE PRESENT. FAILURE TO DO SO MAY CAUSE PROPERTY DAMAGE, PERSONAL INJURY OR DEATH.



7. Turn on gas to furnace and check for leaks. If leaks are found, repair and then reinstall burner compartment door.
8. Turn on electrical power and verify proper unit operation.

# SERVICING

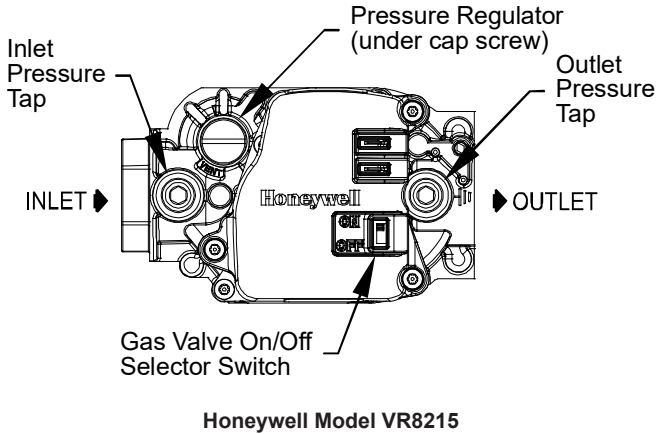
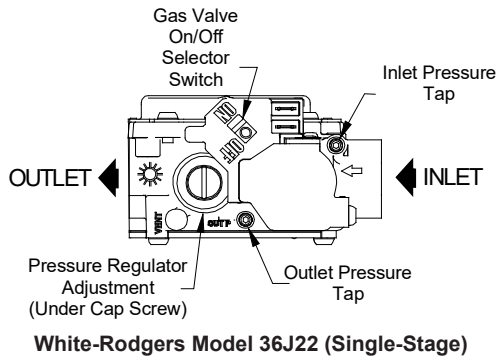

Manifold Gas Pressure			
Gas	Rate	Range	Nominal
Propane Gas	High Stage	9.7 to 10.3" w.c.	10.0" w.c.
	Low Stage	5.7 to 6.3" w.c.	6.0" w.c.

## S-308 CHECKING HOT SURFACE IGNITOR

Single stage furnaces use a 115 volt silicon carbide igniter (p/n 0130F00008) with 17-second warm up time.

**⚠ WARNING**

**DISCONNECT ALL POWER BEFORE SERVICING.**

1. Remove burner compartment door to gain access to the ignitor.
2. Ignitor cool - approximately 70 - 77°F.
3. Disconnect the ignitor from the Ignition Control.
4. Using an ohmmeter measure the resistance of the ignitor: -at room temperature a normal reading will be 37 - 68 ohms.
5. Reconnect ignitor.

**⚠ WARNING**

**LINE VOLTAGE NOW PRESENT**

6. Place unit in heating cycle, measure current draw of ignitor during preheat cycle.

## S-309 CHECKING FOR FLASHBACK

Flashback will also cause burning in the burner venturi, but is caused by the burning speed being greater than the gas-air flow velocity coming from a burner port.

Flashback may occur at the moment of ignition, after a burner heats up or when the burner turns off. The latter is known as extinction pop.

Since the end results of flashback and delayed ignition can be the same (burning in the burner venturi) a definite attempt should be made to determine which has occurred.

If flashback should occur, check for the following:

1. Improper gas pressure - adjust to proper pressure (See S-307 CHECKING GAS PRESSURE)..
2. Check burner for proper alignment and/or replace burner.
3. Improper orifice size - check orifice for obstruction.

## S-310 CHECKING PRESSURE SWITCH

The pressure control is a safety device to prevent the combustion cycle from occurring with inadequate venting caused by a restricted or blocked vent pipe.

**⚠ WARNING**

**HIGH VOLTAGE**  
DISCONNECT ALL POWER BEFORE SERVICING OR INSTALLING THIS UNIT. MULTIPLE POWER SOURCES MAY BE PRESENT. FAILURE TO DO SO MAY CAUSE PROPERTY DAMAGE, PERSONAL INJURY OR DEATH.

1. Remove burner compartment door to gain access to pressure switch(es).
2. Remove wires from the pressure switch(es) electrical terminals.
3. Remove the pressure control hose from the control and interconnect with an inclined manometer as shown in the following figures.

With a call for heat and the inducer running, check across the pressure switch contacts with an ohm meter. If the contacts are not closed, compare the negative reading on the inclined manometer with the rating on the pressure switch to determine whether the switch is defective or if the negative pressure is inadequate to close the switch.

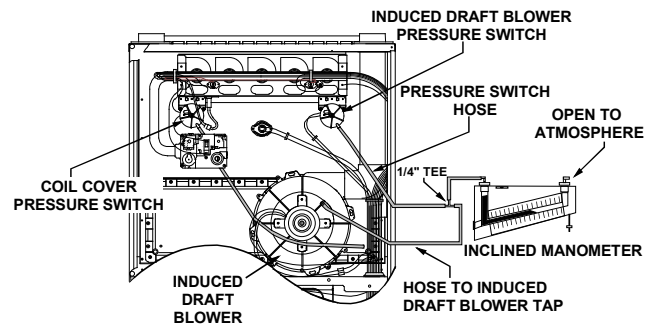

**Blower Pressure Switch  
Negative Pressure Measurement**

## S-311 HIGH ALTITUDE APPLICATION (USA)

A high altitude kit is required for installations above 7,000 ft. Refer to the accessory matrix in this manual to determine the proper natural gas and LP gas high altitude kit for your furnace.

# SERVICING

## S-312 CHECKING FOR DELAYED IGNITION

Delayed ignition is a delay in lighting a combustible mixture of gas and air which has accumulated in the combustion chamber.

Furnace design makes this extremely unlikely unless safety controls have been by-passed or tampered with. Never by-pass or alter furnace controls.

If delayed ignition should occur, the following should be checked:

1. Improper gas pressure - adjust to proper pressure (See S-307 CHECKING GAS PRESSURE).
2. Improper burner positioning - burners should be in locating slots, level front to rear and left to right.
3. Carry over (lighter tube or cross lighter) obstructed - clean.
4. Main burner orifice(s) deformed, or out of alignment to burner - replace.

## S-313 CHECKING INTEGRATED IGNITION CONTROL BOARDS

**NOTE:** Failure to earth ground the furnace, reversing the neutral and hot wire connection to the line (polarity), or a high resistance connection in the neutral line may cause the control to lockout due to failure to sense flame.

 **WARNING**

**TO AVOID THE RISK OF ELECTRICAL SHOCK, WIRING TO THE UNIT MUST BE PROPERLY POLARIZED AND GROUNDED. DISCONNECT POWER BEFORE PERFORMING SERVICE LISTED BELOW.**

The ground wire must run from the furnace all the way back to the electrical panel. Proper grounding can be confirmed by disconnecting the electrical power and measuring resistance between the neutral (white) connection and the burner closest to the flame sensor. Resistance should be less than 2 ohms. The ignition control is a combination electronic and electromechanical device and is not field repairable. Complete unit must be replaced.

 **WARNING**

**LINE VOLTAGE NOW PRESENT**

These tests must be completed within a given time frame due to the operation of the ignition control.

The ignition control is capable of diagnosing many furnace failures to help in troubleshooting. The trial for ignition period is 4 seconds.

The indicator light/display may be viewed by looking through the sight glass in the blower compartment door. If the blower compartment door is removed, failure to hold the door switch closed while removing the blower compartment door will result in the loss of the stored failure code. In most cases recycling the ignition control will result in the same failure code originally displayed.

 **WARNING**

**LINE VOLTAGE NOW PRESENT**

These tests must be completed within a given time frame due to the operation of the ignition control.

1. Check for 120 volts from Line 1 (Hot) to Line 2 (Neutral) at the ignition control. No voltage, check the door switch connections and wire harness for continuity.
2. Check for 24 volts from W to C terminal on the ignition control. No voltage. Check transformer, room thermostat, and wiring.  
If you have 24 volts coming off the transformer but receive approximately 13 volts on the terminal board between (C) and (R), check for blown fuse.
3. Check for 120 volts to the induced draft blower by measuring voltage between Pin 1 (on the 2-pin connector) and Line (Neutral) on the control board. No voltage, replace ignition control.
4. If voltage is present in Steps 1 through 3 and the induced draft blower is operating, check for 120 volts to the ignitor during the preheat cycle. Measure voltage between Pin 2 (on the 2-pin connector) and Line (Neutral) on the control board. No voltage, check pressure switch.
5. After the ignitor warm-up time, begin checking for 24 volts to the gas valve. Voltage will be present for seven seconds only if proof of flame has been established.

ERROR CODE	
Red LED Flash	Error / Condition
<b>Flash Codes stored in memory (auto-erased after 14 days)</b>	
1	System Lockout (Retries Exceeded)
2	Pressure Switch stuck Closed
3	Pressure Switch stuck Open
4	Open High Temperature Limit Switch
5	Flame Sensed > 4.25 Seconds with Gas Valve De-Energized
6	Open High Temperature Limit Switch
8	Igniter Relay Fault
10	Open Fuse
11	Igniter Open
12	Inducer Relay Error
<b>Flash Codes NOT stored in memory</b>	
7	Low Flame Sense Signal
9	Twinning Fault
OFF	Control Failure / No Power / Internal Fault / IRQ Loss. Gas Heating Lockout (Gas valve energized when it should be de-energized) Or Gas Valve De-energized when it should be Energized
Rapid Flash	Reverse Polarity

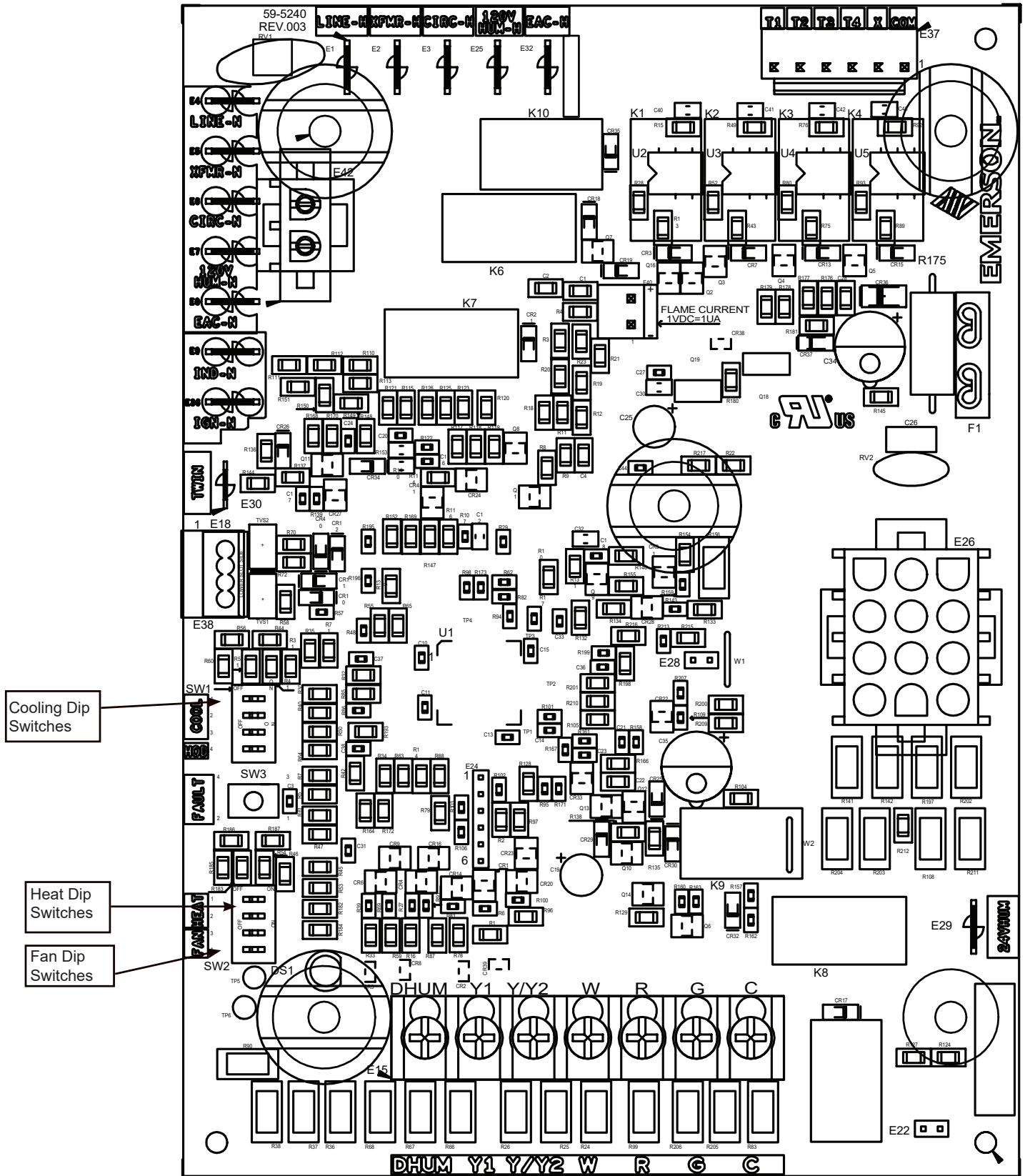

# SERVICING PCBBF145 DIAGRAM



# SERVICING

## S-314 CHECKING FLAME SENSOR

A flame sensing device is used in conjunction with the ignition control module to prove combustion. If proof of flame is not present the control will de-energize the gas valve and “retry” for ignition or lockout.



 <b>WARNING</b>	
<b>HIGH VOLTAGE</b> DISCONNECT <b>ALL</b> POWER BEFORE SERVICING OR INSTALLING THIS UNIT. <b>MULTIPLE</b> POWER SOURCES MAY BE PRESENT. <b>FAILURE TO DO SO MAY CAUSE PROPERTY DAMAGE, PERSONAL INJURY OR DEATH.</b>	

1. Connect a micro-amp meter in series with this wire and the sensor terminal.
2. Be sure the positive side of the meter is to the sensor (depending on the model) and the negative side of the meter is to sensor terminal.

 <b>WARNING</b>
<b>LINE VOLTAGE NOW PRESENT</b>

3. Place the unit into a heating cycle.
4. As soon as flame is established a micro-amp reading should be evident once proof of flame (micro-amp reading) is established, the hot surface ignitor will be de-energized.
5. The Integrated Ignition controls will have 1 to 4 micro-amps. If the micro-amp reading is less than the minimum specified, check for high resistance wiring connections, sensor to burner gap, dirty flame sensor, or poor grounding.
6. If absolutely no reading, check for continuity on all components and if good - replace ignition control module.

**NOTE:** Contaminated fuel or combustion air can create a nearly invisible coating on the flame sensor. This coating works as an insulator causing a loss in the flame sense signal. If this situation occurs the flame sensor must be cleaned with steel wool.

 <b>WARNING</b>	
<b>HIGH VOLTAGE</b> DISCONNECT <b>ALL</b> POWER BEFORE SERVICING OR INSTALLING THIS UNIT. <b>MULTIPLE</b> POWER SOURCES MAY BE PRESENT. <b>FAILURE TO DO SO MAY CAUSE PROPERTY DAMAGE, PERSONAL INJURY OR DEATH.</b>	
 <b>CAUTION</b>	
<b>IF YOU MUST HANDLE THE ITNITOR, HANDLE WITH CARE. TOUCHING THE IGNITOR BODY WITH BARE FINGERS, ROUGH HANDLING, OR VIBRATION COULD RESULT IN EARLY IGNITOR FAILURE. ONLY A QUALIFIED SERVICER SHOULD EVER HANDLE THE IGNITOR.</b>	

## ANNUAL INSPECTION

The furnace should be inspected by a qualified installer, or service agency at least once per year. This check should be performed at the beginning of the heating season. This will ensure that all furnace components are in proper working order and that the heating system functions appropriately. Pay particular attention to the following items. Repair or service as necessary.

- Flue pipe system. Check for blockage and/or leakage. Check the outside termination and the connections at and internal to the furnace.
- Combustion air intake pipe system (where applicable). Check for blockage and/or leakage. Check the outside termination and the connection at the furnace.
- Heat exchanger. Check for corrosion and/or buildup within the heat exchanger passageways.
- Burners. Check for proper ignition, burner flame, and flame sense.
- Drainage system. Check for blockage and/or leakage. Check hose connections at and internal to furnace.
- Wiring. Check electrical connections for tightness and/or corrosion. Check wires for damage.
- Filters.

## AIR FILTER

 <b>WARNING</b>
<b>NEVER OPERATE FURNACE WIHTOUT A FILTER INSTALLED AS DUST AND LINT WILL BUILD UP ON INTERNAL PARTS RESULTING IN LOSS OF EFFICIENCY, EQUIPMENT DAMAMGE, AND POSSIBLE FIRE.</b>

Filters must be used with this furnace. Filters do not ship with these furnaces but must be provided by the installer for proper furnace operation.

Remember that dirty filters are the most common cause of inadequate heating or cooling performance.

# ACCESSORIES

MODEL #	MFG #	DESCRIPTION
AFE18-60A	N/A	<b>Fossil Fuel Kit.</b> The AFE18-60A control is designed for use where the indoor coil is located above/downstream of a gas or fossil fuel furnace when used with a heat pump. It will operate with single and two stage heat pumps and single and two stage furnaces. The AFE18-60A control will turn the heat pump unit off when the furnace is turned on. An anti-short cycle feature initiates a 3 minute timed off delay when the compressor goes off.
AMU1620 AMU1625 AMU2020 AMU2025	P1251305F P1251306F P1251307F P1251308F	<b>Media Air Cleaner.</b> A high efficiency air filtration device designed to remove dirt, dust, pollen and other microscopic particles from the air passing through it. Flexible performance range up to 2,000 CFM capacity. The air cleaner should be installed in the system so that all the system air is circulated through the air cleaner. The air cleaner will only remove the airborne contaminants delivered to it. Maximum performance is obtained when the system blower is set for continuous operation. Carbon filters (optional) are available.
GMU1620 GMU1625 GMU2020 GMU2025	N/A	
ASAS-10 ASAS-11 ASAS-12 ASAS-18	P1251301F P1251302F P1251303F P1251304F	<b>Electronic Air Cleaner.</b> The High-Efficiency Electronic Air Cleaner is designed to remove air contaminants down to .01 microns. Carbon filters (optional) remove odors. Dual indicator lights show unit operation at a glance. Electronic proving switch cycles the air cleaner On/Off with the system fan. Durable powder-coat paint finish resists corrosion.
CFSB17 CFSB21 CFSB24	N/A	<b>Counterflow Subbase Kit.</b> For use with 34.5" down flow furnace models. These kits are available for the following furnace widths: 17.5" wide (CFSB17), 21" wide (CFSB21) and 24.5" wide (CFSB24). The kits must be used to prevent excessive temperature from reaching combustible materials, if the furnace is installed on a combustible floor. This subbase effectively separated the furnace base and plenum from combustible materials. To ensure safe installation, do not install the counterflow floor base directly on carpeting, tile, or other combustible material other than wood flooring.

# ACCESSORIES

MODEL #	MFG #	DESCRIPTION
DCVK-20 (CVENT-2)  DCVK-30 (CVENT-3)	N/A	<b>Concentric Vent Kit.</b> This kit is designed to allow terminations of a direct vent furnace to be "concentrically" vented through a wall or roof. This kit allows a single penetration to support terminations for both the vent/flue and the combustion air intake
EFR02	N/A	<b>External Filter Rack Kit.</b> For use with 34.5" up flow gas furnaces. This kit is intended to provide a location, external to the furnace casing for installation of a permanent filter. The rack is mounted over the indoor air blower compartment area of either
0170K00000S	N/A	<b>Side Wall Only Concentric Vent Kit.</b> This kit is to be used with 2" - 3" vent systems. The vent kit must terminate outside the structure. This kit is NOT intended for use with single pipe (indirect vent) installations.
0170K00001S	N/A	<b>Side Wall Only Concentric Vent Kit.</b> This kit is to be used with 2" vent systems. The vent kit must terminate outside the structure. This kit is NOT intended for use with single pipe (indirect vent) installation
LPLP03	N/A	<b>LP Gas Low Pressure Kit.</b> Designed for use with furnaces converted to LP gas. The kit monitors gas line pressure with a pressure switch and will open the circuit to the gas valve if the LP tank pressure gets low.
LPM-07	N/A	<b>LP Conversion Kit</b> Converts a 34.5" single stage furnace to operate on L.P. gas. The kit contains an L.P. gas valve and a set of six L.P. orifices.
RF000142	N/A	<b>Drain Coupling Kit</b> For use when the drain/vent elbow has been removed in a horizontal left installation. This kit prevents condensate from getting in the inducer and routes the condensate to a drain. This kit can also be used on the furnace combustion air inlet to catch condensate.



# ACCESSORIES

GOODMAN® and AMANA® BRAND \*MES9\*/\*CES9\* Model Furnace Accessories - 92% Single Stage

MODEL NUMBER	EFR02	AMU / GMU	ASAS / GSAS	0170K00001S	0170K00000S	DCVK-20 (CVENT-2)	DCVK-30 (CVENT-3)	LPM07	CFSB-17	CFSB-21	CFSB-24	LPLP03	AFE16-60A	RF000142	HASFK-4	HASFK-4	HASFK-5
Description	EFR External Filter Rack	Media Air Cleaners	Electronic Air Cleaner	Concentric Side Wall Flush Mount Vent Kit (2")	Concentric Side Wall Flush Mount Vent Kit (3")	Concentric Vent Kit (2")	Concentric Vent Kit (3")	Propane Gas Conversion Kit	Down Flow Base	Down Flow Base	Down Flow Base	LP Low Pressure Shut Off Kit	Dual Fuel Board	Drain Coupling	High Alt Nat Gas Kit	High Alt LP Gas Kit	High Alt LP Gas Kit
*MES920403ANAA	•	•	•	•	•	•	•	•				•	•	•	1	1	
*MES920603BNAA	•	•	•	•	•	•	•	•				•	•	•	1	1	
*MES920803BNAA	•	•	•	•	•	•	•	•				•	•	•	1		1
*MES920804CNAA	•	•	•	•	•	•	•	•				•	•	•	1	1	
*MES920805CNAA	•	•	•	•	•	•	•	•				•	•	•	1	1	
*MES921004CNAA	•	•	•	•	•	•	•	•				•	•	•	1	1	
*MES921005CNAA	•	•	•	•	•	•	•	•				•	•	•	1		1
*MES921205DNAA	•	•	•		•		•	•				•	•	•	1	1	

(1) Required above 7,000 Ft altitude





# ACCESSORIES

GOODMAN® and AMANA® BRAND \*MES9\* Model Furnace Accessories - 96% Single Stage







MODEL NUMBER	EFR02	AMU / GMU	ASAS / GSAS	0170K00001S	0170K00000S	DCVK-20 (CVENT-2)	DCVK-30 (CVENT-3)	LPM07	CFSB-17	CFSB-21	CFSB-24	LPLP03	AFE16-60A	RF000142	HASFK-4	HASFK-4	HASFK-5	HASFK-6
	Description	EFR External Filter Ra	Media Air Cleaners	Electronic Air Cleaner	Concentric Side Wall Flush Mount Vent Kit (2")	Concentric Side Wall Flush Mount Vent Kit (3")	Concentric Vent Kit (2")	Concentric Vent Kit (3")	Propane Gas Conversion Kit	Down Flow Base	Down Flow Base	Down Flow Base	LP Low Pressure Shut Off Kit	Dual Fuel Board	Drain Coupling	High Alt Nat Gas Kit	High Alt LP Gas Kit	High Alt LP Gas Kit
*MES960403ANAA	•	•	•	•	•	•	•	•				•	•	•	1	1		
*MES960603BNAA	•	•	•	•	•	•	•	•				•	•	•	1			1
*MES960803BNAA	•	•	•	•	•	•	•	•				•	•	•	1			1
*MES960804CNAA	•	•	•	•	•	•	•	•				•	•	•	1			1
*MES960805CNAA	•	•	•	•	•	•	•	•				•	•	•	1		1	
*MES961005CNAA	•	•	•	•	•	•	•	•				•	•	•	1		1	
*MES1005CNAB	•	•	•		•		•	•				•	•	•	1		1	
*MES961205DNAA		•	•		•	•	•	•				•	•	•	1		1	
*CES960403BNAA		•	•	•	•	•	•	•	•			•	•	•	1		1	
*CES960603BNAA		•	•	•	•	•	•	•	•			•	•	•	1		1	
*CES960804CNAA		•	•	•	•	•	•	•		•		•	•	•	1			
*CES961005CNAA		•	•	•	•		•	•		•		•	•	•	1	1		
*CES961205DNAA		•	•	•	•		•	•			•	•	•	•	1	1		

(1) Required above 7,000 Ft altitude





# TROUBLESHOOTING

Symptoms of Abnormal Operation	Associated LED Code <sup>2</sup>	Fault Description(s)	Possible Causes	Corrective Action	Cautions and Notes
<ul style="list-style-type: none"> <li>Furnace fails to operate.</li> <li>Integrated control module diagnostic LED provides no signal.</li> </ul>	OFF	<ul style="list-style-type: none"> <li>No 115 volt power to furnace, or no 24 volt power to integrated control module.</li> <li>Blown fuse or circuit breaker.</li> <li>Integrated control module has an internal fault.</li> </ul>	<ul style="list-style-type: none"> <li>Manual disconnect switch OFF, door switch open, or 24 volt wires improperly connected or loose.</li> <li>Blown fuse or circuit breaker.</li> <li>Integrated control module has an internal fault.</li> </ul>	<ul style="list-style-type: none"> <li>Assure 115 and 24 volt power to furnace integrated control module.</li> <li>Check integrated control module fuse (3A). Replace if necessary.</li> <li>Check for possible shorts in 115 and 24 volt circuits. Repair as necessary.</li> <li>Replace bad integrated control module.</li> </ul>	<ul style="list-style-type: none"> <li>Turn power OFF prior to repair.</li> <li>Replace integrated control module fuse with 3A automotive fuse.</li> <li>Read precautions in "Electrostatic Discharge" section of manual.</li> </ul>
<ul style="list-style-type: none"> <li>LED is Steady On.</li> </ul>	 CONTINUOUS ON	<ul style="list-style-type: none"> <li>Normal Operation</li> </ul>	<ul style="list-style-type: none"> <li>Normal Operation</li> </ul>	<ul style="list-style-type: none"> <li>None</li> </ul>	<ul style="list-style-type: none"> <li>Normal Operation</li> </ul>
<ul style="list-style-type: none"> <li>Furnace fails to operate.</li> <li>Integrated control module diagnostic LED is flashing ONE (1) flash.</li> </ul>	 1 FLASH	<ul style="list-style-type: none"> <li>Furnace lockout due to an excessive number of ignition "retries" (3 total)<sup>1</sup>.</li> </ul>	<ul style="list-style-type: none"> <li>Failure to establish flame. Cause may be no gas to burners, front cover pressure switch stuck open, bad igniter or igniter alignment, improper orifices, coated/oxidized or improperly connected flame sensor.</li> <li>Loss of flame after establishment. Cause may be interrupted gas supply, lazy burner flames (improper gas pressure or restriction in flue and/or combustion air piping), front cover pressure switch opening, improper induced draft blower performance.</li> </ul>	<ul style="list-style-type: none"> <li>Locate and correct gas interruption.</li> <li>Check front cover pressure switch operation (hose, wiring, contact operation). Correct if necessary.</li> <li>Replace or realign igniter.</li> <li>Check flame sense signal. Sand sensor if coated and/or oxidized.</li> <li>Check flue piping for blockage, proper length, elbows, and termination.</li> <li>Verify proper induced draft blower performance.</li> </ul>	<ul style="list-style-type: none"> <li>Turn power OFF prior to repair.</li> <li>Igniter is fragile, handle with care.</li> <li>Sand flame sensor with emery cloth.</li> <li>See "Vent/ Flue Pipe" section for piping details.</li> </ul>
<ul style="list-style-type: none"> <li>Furnace fails to operate.</li> <li>Integrated control module diagnostic LED is flashing TWO (2) flashes.</li> </ul>	 2 FLASHES	<ul style="list-style-type: none"> <li>Pressure switch circuit is closed.</li> <li>Induced draft blower is not operating.</li> </ul>	<ul style="list-style-type: none"> <li>Induced draft blower pressure switch contacts sticking.</li> <li>Shorts in pressure switch circuit.</li> </ul>	<ul style="list-style-type: none"> <li>Replace induced draft blower pressure switch.</li> <li>Repair short.</li> </ul>	<ul style="list-style-type: none"> <li>Turn power OFF prior to repair.</li> <li>Replace pressure switch with proper replacement part.</li> </ul>
<ul style="list-style-type: none"> <li>Induced draft blower runs continuously with no further furnace operation.</li> <li>Integrated control module diagnostic LED is flashing THREE (3) flashes.</li> </ul>	 3 FLASHES	<ul style="list-style-type: none"> <li>Pressure switch circuit not closed.</li> <li>Induced draft blower is operating.</li> </ul>	<ul style="list-style-type: none"> <li>Pressure switch hose blocked, pinched or connected improperly.</li> <li>Blocked flue and/or inlet air pipe, blocked drain system, or weak induced draft blower.</li> <li>Incorrect pressure switch setpoint or malfunctioning switch contacts.</li> <li>Loose or improperly connected wiring.</li> </ul>	<ul style="list-style-type: none"> <li>Inspect pressure switch hose. Repair, if necessary.</li> <li>Inspect flue and/or inlet air piping for blockage, proper length, elbows, and termination. Check drain system. Correct as necessary.</li> <li>Correct pressure switch setpoint or contact motion.</li> <li>Tighten or correct wiring connection.</li> </ul>	<ul style="list-style-type: none"> <li>Turn power OFF prior to repair.</li> <li>Replace pressure switch with proper replacement part.</li> </ul>

# TROUBLESHOOTING

<ul style="list-style-type: none"> <li>• Circulator blower runs continuously. No furnace operation.</li> <li>• Integrated control module diagnostic LED is flashing <b>FOUR (4)</b> flashes.</li> </ul>	 <p>4 FLASHES</p>	<ul style="list-style-type: none"> <li>• Primary or auxiliary limit circuit is open.</li> </ul>	<ul style="list-style-type: none"> <li>• Faulty primary or auxiliary limit switch.</li> <li>• Insufficient conditioned air over the heat exchanger. Blocked filters, restrictive ductwork, improper circulator blower speed, or failed circulator blower.</li> <li>• Loose or improperly connected wiring.</li> </ul>	<ul style="list-style-type: none"> <li>• Check primary/auxiliary limit. Replace if necessary.</li> <li>• Check filters and ductwork for blockage. Clean filters or remove obstruction.</li> <li>• Check circulator blower speed and performance. Correct speed or replace blower if necessary.</li> <li>• Tighten or correct</li> </ul>	<ul style="list-style-type: none"> <li>• Turn power OFF prior to repair.</li> <li>• Replace primary/auxiliary limit with proper replacement part.</li> <li>• Replace blower with correct replacement part.</li> </ul>
<ul style="list-style-type: none"> <li>• Induced draft blower and circulation blower runs continuously. No furnace operation.</li> <li>• Integrated control module diagnostic LED is flashing <b>FIVE (5)</b> flashes.</li> </ul>	 <p>5 FLASHES</p>	<ul style="list-style-type: none"> <li>• Flame sensed with no call for heat.</li> </ul>	<ul style="list-style-type: none"> <li>• Short to ground in flame sense circuit.</li> </ul>	<ul style="list-style-type: none"> <li>• Correct short at flame sensor or in flame sensor wiring.</li> </ul>	<ul style="list-style-type: none"> <li>• Turn power OFF prior to repair.</li> </ul>
<ul style="list-style-type: none"> <li>• Furnace fails to operate.</li> <li>• Integrated control module diagnostic LED is flashing <b>SIX (6)</b> flashes.</li> <li>• No furnace operation.</li> </ul>	 <p>6 FLASHES</p>	<ul style="list-style-type: none"> <li>• Rollout limit open.</li> <li>• Integrated control module fuse is blown.</li> </ul>	<ul style="list-style-type: none"> <li>• Flame rollout.</li> <li>• Misaligned burners, blocked flue and/or air inlet pipe, or failed induced draft blower.</li> <li>• Loose or improperly connected wiring.</li> <li>• Short in 24 volt AC control circuits or safety circuits.</li> <li>• Faulty rollout limit.</li> </ul>	<ul style="list-style-type: none"> <li>• Check burners for proper alignment.</li> <li>• Check flue and air inlet piping for blockage, proper length, elbows, and termination. Correct as necessary.</li> <li>• Check rollout limit. Replace if necessary.</li> <li>• Check induced draft blower for proper performance. Replace, if necessary.</li> <li>• Tighten or correct wiring connection.</li> </ul>	<ul style="list-style-type: none"> <li>• Turn power OFF prior to repair.</li> <li>• See "Vent/Flue Pipe" section for piping details.</li> <li>• Replace induced draft blower with correct replacement part.</li> <li>• Replace integrated control module fuse with 3A automotive fuse.</li> <li>• Read precautions in "Electrostatic Discharge" section of manual.</li> <li>• Replace rollout limit with correct replacement part.</li> </ul>
<ul style="list-style-type: none"> <li>• Normal furnace operation.</li> <li>• Integrated control module diagnostic LED is flashing <b>SEVEN (7)</b> flashes.</li> </ul>	 <p>7 FLASHES</p>	<ul style="list-style-type: none"> <li>• Flame sense microamp signal is low.</li> </ul>	<ul style="list-style-type: none"> <li>• Flame sensor is coated/oxidized.</li> <li>• Flame sensor incorrectly positioned in burner flame.</li> <li>• Lazy burner flame due to improper gas pressure or combustion air.</li> </ul>	<ul style="list-style-type: none"> <li>• Sand flame sensor.</li> <li>• Inspect for proper sensor alignment.</li> <li>• Compare current gas pressure to rating plate info. Adjust as needed.</li> </ul>	<ul style="list-style-type: none"> <li>• Turn power OFF prior to repair.</li> <li>• Clean flame sensor with steel wool.</li> <li>• See "Vent/Flue Pipe" section for piping details.</li> <li>• See rating plate for proper gas pressure.</li> </ul>
<ul style="list-style-type: none"> <li>• Furnace not operating.</li> <li>• Integrated control module diagnostic LED is flashing <b>EIGHT (8)</b> flashes.</li> </ul>	 <p>8 FLASHES</p>	<ul style="list-style-type: none"> <li>• Igniter Relay Fault</li> </ul>	<ul style="list-style-type: none"> <li>• Improperly connected igniter.</li> <li>• Bad igniter.</li> <li>• Poor unit ground.</li> <li>• Poor burner ground.</li> <li>• Faulty integrated control module.</li> </ul>	<ul style="list-style-type: none"> <li>• Check and correct wiring from integrated control module to igniter.</li> <li>• Replace bad igniter.</li> <li>• Check &amp; correct unit ground wire.</li> <li>• Replace bad integrated control module.</li> </ul>	<ul style="list-style-type: none"> <li>• Turn power OFF prior to repair.</li> <li>• Replace igniter w/proper replacement part.</li> <li>• Read precautions in "Electrostatic Discharge" section of manual.</li> </ul>
<ul style="list-style-type: none"> <li>• Circulating blowers not operating simultaneously. No blower operation.</li> </ul>	 <p>9 FLASHES</p>	<ul style="list-style-type: none"> <li>• Twinning Fault</li> </ul>	<ul style="list-style-type: none"> <li>• Furnace twin terminals not connected together by field wiring.</li> <li>• Isolating relay not used or improperly installed</li> </ul>	<ul style="list-style-type: none"> <li>• Install field wiring connecting twin terminals, check continuity of wiring.</li> <li>• Verify each furnace fan motor is operable without twinning connection.</li> <li>• Wire per twinning diagram in this installation manual</li> </ul>	<ul style="list-style-type: none"> <li>• Verify line voltage supply is turned off before proceeding with corrections</li> </ul>

# TROUBLESHOOTING

<ul style="list-style-type: none"> <li>Furnace not operating.</li> <li>Integrated control module diagnostic LED is flashing TEN (10) flashes.</li> </ul>	 10 FLASHES	<ul style="list-style-type: none"> <li>Open Fuse / No 24V power to integrated control module</li> </ul>	<ul style="list-style-type: none"> <li>High voltage surge blows off the fuse.</li> </ul>	<ul style="list-style-type: none"> <li>Replace the Fuse.</li> </ul>	<ul style="list-style-type: none"> <li>Verify line voltage supply is turned off before proceeding with corrections</li> </ul>
<ul style="list-style-type: none"> <li>Furnace not operating.</li> <li>Integrated control module diagnostic LED is flashing ELEVEN (11) flashes.</li> </ul>	 11 FLASHES	<ul style="list-style-type: none"> <li>Igniter Open</li> </ul>	<ul style="list-style-type: none"> <li>Improperly connected igniter.</li> <li>Bad igniter.</li> <li>Poor unit ground.</li> <li>Poor burner ground.</li> </ul>	<ul style="list-style-type: none"> <li>Check and correct wiring from integrated control module to igniter.</li> <li>Replace bad igniter.</li> <li>Check &amp; correct unit ground wire.</li> <li>Replace bad integrated</li> </ul>	<ul style="list-style-type: none"> <li>Turn power OFF prior to repair.</li> <li>Replace igniter w/proper replacement part.</li> <li>Read precautions in "Electrostatic Discharge" section</li> </ul>
<ul style="list-style-type: none"> <li>Furnace not operating.</li> <li>Integrated control module diagnostic LED is flashing TWELVE (12) flashes.</li> </ul>	 12 FLASHES	<ul style="list-style-type: none"> <li>Inducer Relay Fault</li> </ul>	<ul style="list-style-type: none"> <li>Improperly connected inducer.</li> <li>Bad inducer.</li> <li>Poor unit ground.</li> <li>Faulty integrated control module.</li> </ul>	<ul style="list-style-type: none"> <li>Check and correct wiring from integrated control module to inducer.</li> <li>Check for Blockage in inducer &amp; in Vent / replace Inducer.</li> <li>Check &amp; correct unit ground wire.</li> <li>Replace bad integrated control module.</li> </ul>	<ul style="list-style-type: none"> <li>Turn power OFF prior to repair.</li> <li>Replace inducer w/proper replacement part.</li> <li>Read precautions in "Electrostatic Discharge" section of manual.</li> </ul>
<ul style="list-style-type: none"> <li>Furnace fails to operate.</li> <li>Integrated control module diagnostic LED is flashing continuously.</li> </ul>	 CONTINUOUS RAPID FLASH	<ul style="list-style-type: none"> <li>Polarity of 115 or 24 volt power is reversed.</li> </ul>	<ul style="list-style-type: none"> <li>Polarity of 115 volt AC power to furnace or integrated control module is reversed.</li> <li>Orange and gray wires to transformer are reversed.</li> <li>Poor unit ground.</li> </ul>	<ul style="list-style-type: none"> <li>Review wiring diagram to correct polarity.</li> <li>Reverse orange and gray wires going to transformer.</li> <li>Verify proper ground. Correct if necessary.</li> </ul>	<ul style="list-style-type: none"> <li>Turn power OFF prior to repair</li> </ul>

<sup>1</sup>Integrated control module will automatically attempt to reset from lockout after one hour.

<sup>2</sup>LED Flash code will cease if power to the control module is interrupted through the disconnect or door switch.

# WIRING DIAGRAMS

## ALL FUEL SYSTEM CONTROL BOARD - AFE1860A

**WARNING**  
 HIGH VOLTAGE!  
 DISCONNECT ALL POWER BEFORE SERVICING OR INSTALLING THIS UNIT. MULTIPLE POWER SOURCES MAY BE PRESENT. FAILURE TO DO SO MAY CAUSE PROPERTY DAMAGE, PERSONAL INJURY OR DEATH.

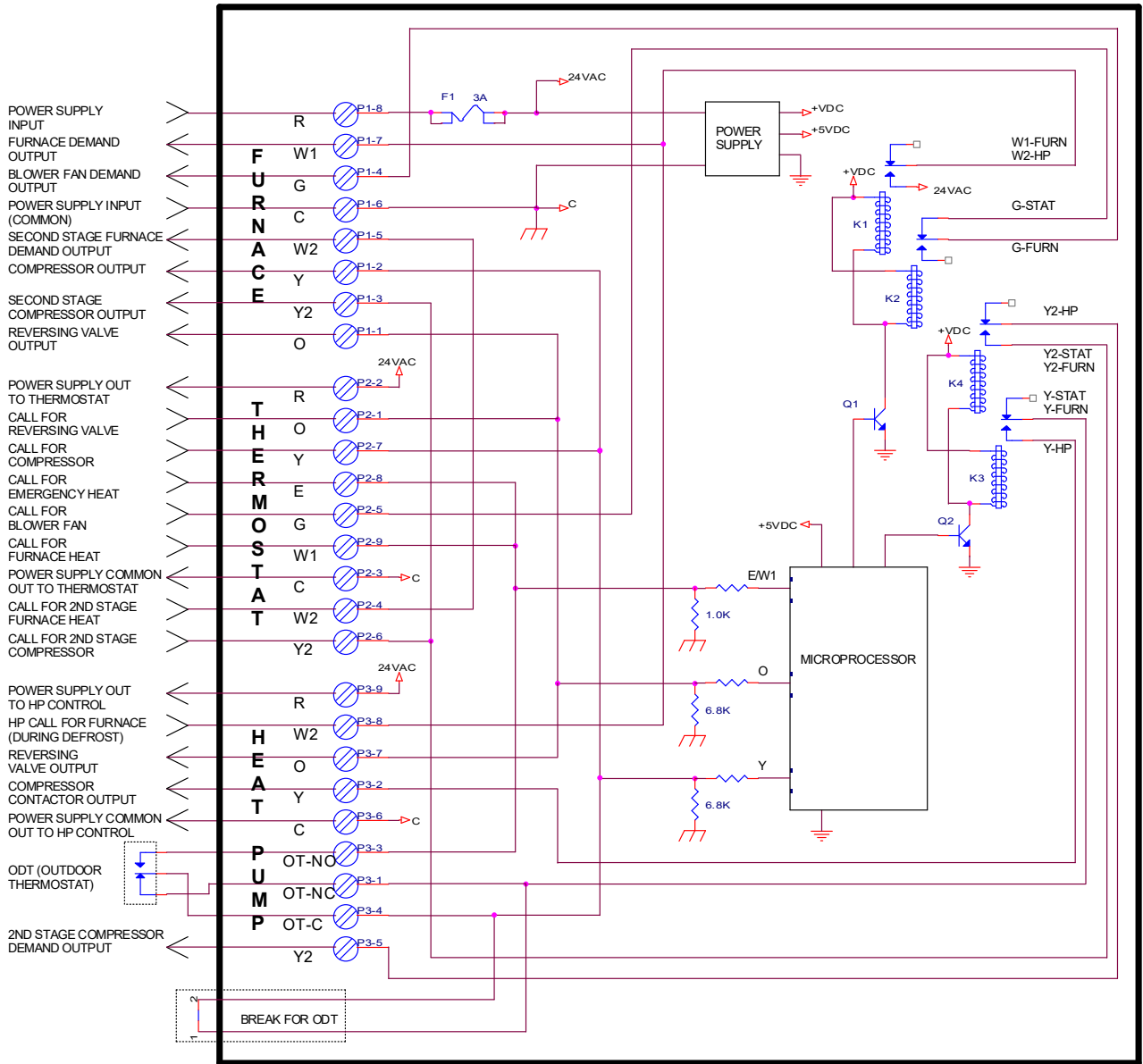

## ALL FUEL SYSTEM CONTROL BOARD - AFE18-60A

This wiring diagram is for reference only. Not all wiring is as shown above.  
 Refer to the appropriate wiring diagram for the unit being serviced.  
 (For use with Heat Pumps in conjunction with 80% or 90% Single-Stage or Two-Stage Furnaces)

Wiring is subject to change. Always refer to the wiring diagram on the unit for the most up-to-date wiring.

# WIRING DIAGRAMS

# \*MES96\*\*/\*CES96\*\*A\* PCBBF145 CONTROL

**WARNING**  
 HIGH VOLTAGE!  
 DISCONNECT ALL POWER BEFORE SERVICING OR INSTALLING THIS UNIT. MULTIPLE POWER SOURCES MAY BE PRESENT. FAILURE TO DO SO MAY CAUSE PROPERTY DAMAGE, PERSONAL INJURY OR DEATH.

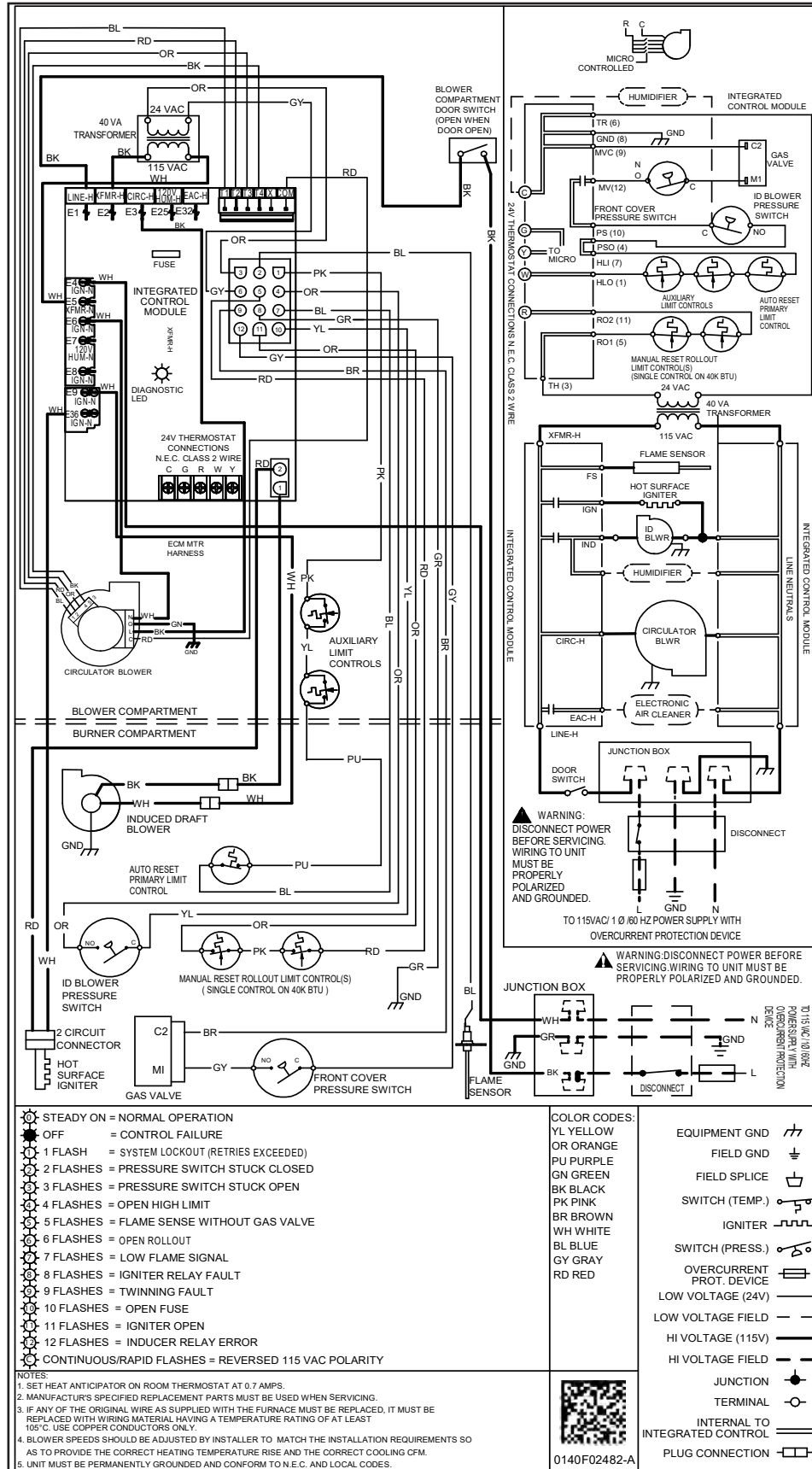

Wiring is subject to change. Always refer to the wiring diagram on the unit for the most up-to-date wiring.

CUSTOMER FEEDBACK

We are very interested in all product comments.

Please fill out the feedback form on one of the following links:

Goodman® Brand Products: (<http://www.goodmanmfg.com/about/contact-us>).

Amana® Brand Products: (<http://www.amana-hac.com/about-us/contact-us>).

You can also scan the QR code on the right for the product brand you purchased to be directed to the feedback page.



GOODMAN® BRAND



AMANA® BRAND

**Amana** is a registered trademark of Maytag Corporation or its related companies and is used under license.

All rights reserved.

Copyright © 2019-2020 Goodman Manufacturing Company, L.P.