



EDUS041502

R-410A

Engineering Data

Split Type Air Conditioners
- Cooling Only / Heat Pump -
SEER 18 Models

FTK(X)-N Series

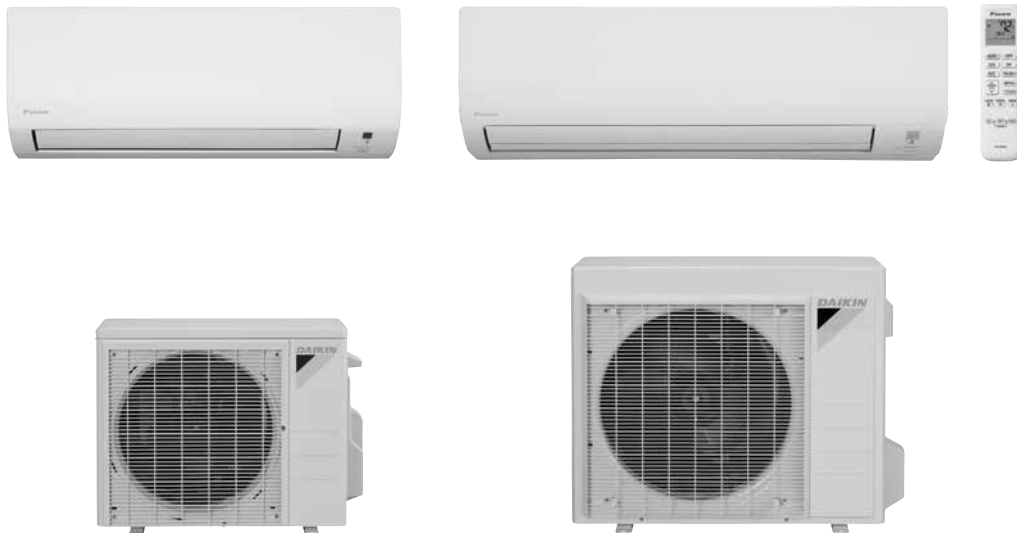

INVERTER

Split Type Air Conditioners FTK(X)-N Series

Cooling Only	FTK09NMVJU	RK09NMVJU
	FTK12NMVJU	RK12NMVJU
	FTK18NMVJU	RK18NMVJU
	FTK24NMVJU	RK24NMVJU
Heat Pump	FTX09NMVJU	RX09NMVJU
	FTX12NMVJU	RX12NMVJU
	FTX18NMVJU	RX18NMVJU
	FTX24NMVJU	RX24NMVJU

1. Power Supply	3
2. Functions.....	4
3. Specifications	6
3.1 Cooling Only.....	6
3.2 Heat Pump	8
4. Dimensions	10
4.1 Indoor Unit.....	10
4.2 Outdoor Unit.....	13
5. Wiring Diagrams.....	15
5.1 Indoor Unit.....	15
5.2 Outdoor Unit.....	16
6. Piping Diagrams.....	17
6.1 Indoor Unit.....	17
6.2 Outdoor Unit.....	19
7. Capacity Tables	23
7.1 Cooling Only.....	23
7.2 Heat Pump	31
7.3 Capacity Correction Factor by the Length of Refrigerant Piping (Reference)	43
8. Operation Limit.....	45
9. Sound Level	46
9.1 Measuring Location	46
9.2 Indoor Unit.....	47
9.3 Outdoor Unit.....	50
10. Electric Characteristics.....	53

11. Installation Manual	54
11.1 Indoor Unit	54
11.2 Outdoor Unit	66
12. Operation Manual	78
12.1 Cooling Only	78
12.2 Heat Pump	106
13. Optional Accessories	134
13.1 Option List	134
13.2 <BRC944B2> Wired Remote Controller	135
13.3 <KRC72A> Centralized Control Board-Up to 5 Rooms	149
13.4 <KRP413AB1S> Wiring Adaptor for Timer Clock / Remote Controller	151
13.5 <KRP928BB2S> Interface Adaptor for DIII-NET (Residential Air Conditioner)	155
13.6 <KRP067A41> Interface Adaptor for Residential Air Conditioner	158
13.7 <KRP980B2> Interface Adaptor for Residential Air Conditioner	162
13.8 <KPW937E4> Air Direction Adjustment Grille	166
13.9 <KPW063A4> Air Direction Adjustment Grille	168

Cautions

1. Air conditioners should not be installed in areas where corrosive gases, such as acid gas or alkaline gas, are produced.
2. If the outdoor unit is to be installed close to the sea shore, direct exposure to the sea breeze should be avoided and choose an outdoor unit with anti-corrosion treatment.

1. Power Supply

Indoor Unit	Outdoor Unit	Power Supply
FTK09NMVJU	RK09NMVJU	1 phase, 208 - 230 V, 60 Hz
FTK12NMVJU	RK12NMVJU	
FTK18NMVJU	RK18NMVJU	
FTK24NMVJU	RK24NMVJU	
FTX09NMVJU	RX09NMVJU	
FTX12NMVJU	RX12NMVJU	
FTX18NMVJU	RX18NMVJU	
FTX24NMVJU	RX24NMVJU	

Note: Power Supply Intake; Outdoor Unit

2. Functions

Category	Functions	FTK09/12NMVJU RK09/12NMVJU	FTX09/12NMVJU RX09/12NMVJU	Category	Functions	FTK09/12NMVJU RK09/12NMVJU	FTX09/12NMVJU RX09/12NMVJU
Basic Function	Inverter (with inverter power control)	●	●	Health & Clean	Air-purifying filter	—	—
	Operation limit for cooling (°CDB)	10 ~ 46	10 ~ 46		Photocatalytic deodorizing filter	—	—
	Operation limit for cooling (°FDB)	50 ~ 114.8	50 ~ 114.8		Air-purifying filter with photocatalytic deodorizing function	—	—
	Operation limit for heating (°CWB)	—	-15 ~ 18		Titanium apatite photocatalytic air-purifying filter (option)	●	●
	Operation limit for heating (°FWB)	—	5 ~ 64.4		Air filter (prefilter)	●	●
	PAM control	●	●		Wipe-clean flat panel	●	●
	Standby electricity saving	●	●		Washable grille	—	—
Compressor	Oval scroll compressor	—	—	Timer	WEEKLY TIMER	—	—
	Swing compressor	●	●		Count up-down ON/OFF timer	●	●
	Rotary compressor	—	—		24-hour ON/OFF TIMER	—	—
	Reluctance DC motor	●	●		NIGHT SET mode	●	●
Comfortable Airflow	Power-airflow flap (horizontal blade)	●	●	Worry Free (Reliability & Durability)	Auto-restart (after power failure)	●	●
	Power-airflow dual flaps	—	—		Self-diagnosis (R/C, LED)	●	●
	Power-airflow diffuser	—	—		Wiring error check function	—	—
	Wide-angle louvers (vertical blade)	●	●	Flexibility	Anti-corrosion treatment of outdoor heat exchanger	●	●
	Auto-swing (up and down)	●	●		Multi-split / split type compatible indoor unit	—	—
	Auto-swing (right and left)	—	—		H/P, C/O compatible indoor unit	—	—
	3-D airflow	—	—		Flexible power supply correspondence	—	—
COMFORT AIRFLOW operation	●	●	Chargeless	32.8 ft (10 m)	32.8 ft (10 m)		
Comfort Control	Auto fan speed	●	●	Either side drain (right or left)	●	●	
	Indoor unit quiet operation	●	●	Power selection	—	—	
	NIGHT QUIET mode (automatic)	—	—	Low temperature cooling operation (-15°C) (5°F)	●	●	
	OUTDOOR UNIT QUIET operation (manual)	—	—	°F/°C changeover R/C temperature display (factory setting: °F)	●	●	
	INTELLIGENT EYE operation	—	—	Remote Control	5-rooms centralized controller (option)	●	●
	Quick warming function	—	●		Remote control adaptor (normal open-pulse contact) (option)	●	●
	Hot-start function	—	●		Remote control adaptor (normal open contact) (option)	●	●
Automatic defrosting	—	●	DIII-NET compatible (adaptor) (option)	●	●		
Operation	Automatic operation	—	●	Remote Controller	Wireless	●	●
	Program dry function	●	●		Wired (option)	●	●
	Fan only	●	●				
Lifestyle Convenience	New POWERFUL operation (non-inverter)	—	—				
	Inverter POWERFUL operation	●	●				
	Priority-room setting	—	—				
	COOL / HEAT mode lock	—	—				
	HOME LEAVE operation	—	—				
	ECONO operation	●	●				
	Indoor unit ON/OFF button	●	●				
	Signal receiving sign	●	●				
	R/C with back light	●	●				
Temperature display	—	—					

Note: ● : Available
 — : Not available

Category	Functions	FTK18/24NMVJU RK18/24NMVJU	FTX18/24NMVJU RX18/24NMVJU	Category	Functions	FTK18/24NMVJU RK18/24NMVJU	FTX18/24NMVJU RX18/24NMVJU	
Basic Function	Inverter (with inverter power control)	●	●	Health & Clean	Air-purifying filter	—	—	
	Operation limit for cooling (°CDB)	10 ~ 46	10 ~ 46		Photocatalytic deodorizing filter	—	—	
	Operation limit for cooling (°FDB)	50 ~ 114.8	50 ~ 114.8		Air-purifying filter with photocatalytic deodorizing function	—	—	
	Operation limit for heating (°CWB)	—	-15 ~ 18		Titanium apatite photocatalytic air-purifying filter (option)	●	●	
	Operation limit for heating (°FWB)	—	5 ~ 64.4		Air filter (prefilter)	●	●	
	PAM control	●	●		Wipe-clean flat panel	●	●	
	Standby electricity saving	●	●		Washable grille	—	—	
						MOLD PROOF operation	—	—
Compressor	Oval scroll compressor	—	—	Timer	Good-sleep cooling operation	—	—	
	Swing compressor	●	●		WEEKLY TIMER	—	—	
	Rotary compressor	—	—		Count up-down ON/OFF timer	●	●	
	Reluctance DC motor	●	●		24-hour ON/OFF TIMER	—	—	
Comfortable Airflow	Power-airflow flap (horizontal blade)	—	—	Worry Free (Reliability & Durability)	NIGHT SET mode	●	●	
	Power-airflow dual flaps	●	●		Auto-restart (after power failure)	●	●	
	Power-airflow diffuser	—	—		Self-diagnosis (R/C, LED)	●	●	
	Wide-angle louvers (vertical blade)	●	●		Wiring error check function	—	—	
	Auto-swing (up and down)	●	●	Flexibility	Anti-corrosion treatment of outdoor heat exchanger	●	●	
	Auto-swing (right and left)	—	—		Multi-split / split type compatible indoor unit	—	—	
	3-D airflow	—	—		H/P, C/O compatible indoor unit	—	—	
	COMFORT AIRFLOW operation	●	●		Flexible power supply correspondence	—	—	
Comfort Control	Auto fan speed	●	●	Remote Control	Chargeless	32.8 ft (10 m)	32.8 ft (10 m)	
	Indoor unit quiet operation	●	●		Either side drain (right or left)	●	●	
	NIGHT QUIET mode (automatic)	—	—		Power selection	—	—	
	OUTDOOR UNIT QUIET operation (manual)	—	—		Low temperature cooling operation (-15°C) (5°F)	●	●	
	INTELLIGENT EYE operation	—	—		°F/°C changeover R/C temperature display (factory setting: °F)	●	●	
	Quick warming function	—	●		Remote Controller	5-rooms centralized controller (option)	●	●
	Hot-start function	—	●			Remote control adaptor (normal open-pulse contact) (option)	●	●
	Automatic defrosting	—	●			Remote control adaptor (normal open contact) (option)	●	●
			DIII-NET compatible (adaptor) (option)	●		●		
Operation	Automatic operation	—	●	Remote Controller	Wireless	●	●	
	Program dry function	●	●		Wired (option)	●	●	
	Fan only	●	●					
Lifestyle Convenience	New POWERFUL operation (non-inverter)	—	—					
	Inverter POWERFUL operation	●	●					
	Priority-room setting	—	—					
	COOL / HEAT mode lock	—	—					
	HOME LEAVE operation	—	—					
	ECONO operation	●	●					
	Indoor unit ON/OFF button	●	●					
	Signal receiving sign	●	●					
	R/C with back light	●	●					
Temperature display	—	—						

Note: ● : Available
— : Not available

3. Specifications

3.1 Cooling Only

60 Hz, 208 - 230 V

Model	Indoor Unit		FTK09NMVJU		FTK12NMVJU	
	Outdoor Unit		RK09NMVJU		RK12NMVJU	
Capacity Rated (Min. ~ Max.)	kW		2.64 (1.30 ~ 3.00)		3.20 (1.30 ~ 3.90)	
	Btu/h		9,000 (4,400 ~ 10,200)		10,900 (4,400 ~ 13,300)	
	kcal/h		2,270 (1,120 ~ 2,580)		2,750 (1,120 ~ 3,350)	
Moisture Removal	gal/h		0.32		0.45	
Running Current (Rated)	A		3.77 - 3.41		4.42 - 3.99	
Power Consumption Rated (Min. ~ Max.)	W		721 (250 ~ 962)		874 (260 ~ 1,383)	
Power Factor (Rated)	%		91.9 - 91.9		95.1 - 95.2	
COP Rated (Min. ~ Max.)	W/W		3.66 (5.20 ~ 3.12)		3.66 (5.00 ~ 2.82)	
EER Rated (Min. ~ Max.)	Btu/h-W		12.5 (17.6 ~ 10.6)		12.5 (16.9 ~ 9.6)	
SEER			19.0		19.0	
Piping Connections	Liquid	in. (mm)	φ 1/4 (φ 6.4)		φ 1/4 (φ 6.4)	
	Gas	in. (mm)	φ 3/8 (φ 9.5)		φ 3/8 (φ 9.5)	
	Drain	in. (mm)	φ 5/8 (φ 16.0)		φ 5/8 (φ 16.0)	
Heat Insulation			Both Liquid and Gas Pipes		Both Liquid and Gas Pipes	
Max. Interunit Piping Length	ft (m)		65-5/8 (20)		65-5/8 (20)	
Max. Interunit Height Difference	ft (m)		49-1/4 (15)		49-1/4 (15)	
Chargeless	ft (m)		32-13/16 (10)		32-13/16 (10)	
Amount of Additional Charge of Refrigerant	oz/ft (g/m)		0.21 (20)		0.21 (20)	
Indoor Unit			FTK09NMVJU		FTK12NMVJU	
Front Panel Color			White		White	
Airflow Rate	H	m ³ /min (cfm)	11.8 (417)		12.3 (434)	
	M		8.4 (297)		8.8 (311)	
	L		6.9 (244)		7.0 (247)	
	SL		4.0 (141)		4.1 (145)	
Fan	Type		Cross Flow Fan		Cross Flow Fan	
	Motor Output	W	21		28	
	Speed	Steps	5 Steps, Quiet, Auto		5 Steps, Quiet, Auto	
Air Direction Control			Right, Left, Horizontal, Downward		Right, Left, Horizontal, Downward	
Air Filter			Removable, Washable, Mildew Proof		Removable, Washable, Mildew Proof	
Running Current (Rated)	A		0.25 - 0.23		0.28 - 0.25	
Power Consumption (Rated)	W		28 - 28		31 - 31	
Power Factor (Rated)	%		53.8 - 52.9		53.2 - 53.9	
Temperature Control			Microcomputer Control		Microcomputer Control	
Dimensions (H x W x D)	in. (mm)		11-1/4 x 30-5/16 x 8-3/4 (285 x 770 x 223)		11-1/4 x 30-5/16 x 8-3/4 (285 x 770 x 223)	
Packaged Dimensions (H x W x D)	in. (mm)		12 x 32-11/16 x 14-3/16 (305 x 831 x 360)		12 x 32-11/16 x 14-3/16 (305 x 831 x 360)	
Weight	Lbs (kg)		18 (8)		18 (8)	
Gross Weight	Lbs (kg)		24 (11)		25 (11)	
Sound Pressure Level	H / M / L / SL	dB(A)	43 / 36 / 30 / 19		45 / 37 / 30 / 19	
Outdoor Unit			RK09NMVJU		RK12NMVJU	
Casing Color			Ivory White		Ivory White	
Compressor	Type		Hermetically Sealed Swing Type		Hermetically Sealed Swing Type	
	Model		1YC23AUXD		1YC23AUXD	
Refrigerant Oil	Type		FVC50K		FVC50K	
	Charge	oz (L)	12.4 (0.375)		12.4 (0.375)	
Refrigerant	Type		R-410A		R-410A	
	Charge	Lbs (kg)	1.54 (0.70)		2.09 (0.95)	
Airflow Rate	H	m ³ /min (cfm)	31.2 (1,102)		31.3 (1,105)	
	SL		29.3 (1,035)		24.5 (865)	
Fan	Type		Propeller		Propeller	
	Motor Output	W	14		18	
Running Current (Rated)	A		3.52 - 3.18		4.14 - 3.74	
Power Consumption (Rated)	W		693 - 693		843 - 843	
Power Factor (Rated)	%		94.7 - 94.7		97.9 - 98.0	
Starting Current	A		3.77		—	
Dimensions (H x W x D)	in. (mm)		21-5/8 x 26-9/16 x 11-3/16 (550 x 675 x 284)		21-5/8 x 26-9/16 x 11-3/16 (550 x 675 x 284)	
Packaged Dimensions (H x W x D)	in. (mm)		24-3/4 x 32-11/16 x 16 (629 x 830 x 407)		24-3/4 x 32-11/16 x 16 (629 x 830 x 407)	
Weight	Lbs (kg)		55 (25)		60 (27)	
Gross Weight	Lbs (kg)		66 (30)		71 (32)	
Sound Pressure Level	H	dB(A)	46		49	
Drawing No.			C: 3D093560		C: 3D093561A	

Note: ■ The data are based on the conditions shown in the table below.

Cooling	Indoor ; 80°FDB (26.7°CDB) / 67°FWB (19.4°CWB) Outdoor ; 95°FDB (35°CDB) / 75°FWB (24°CWB)
Piping Length	25 ft (7.5 m)

Conversion Formulae
kcal/h = kW x 860
Btu/h = kW x 3412
cfm = m ³ /min x 35.3

60 Hz, 208 - 230 V

Model	Indoor Unit		FTK18NMVJU		FTK24NMVJU	
	Outdoor Unit		RK18NMVJU		RK24NMVJU	
Capacity Rated (Min. ~ Max.)	kW		5.28 (1.60 ~ 5.86)		6.20 (1.60 ~ 7.03)	
	Btu/h		18,000 (5,500 ~ 20,000)		21,200 (5,500 ~ 24,000)	
	kcal/h		4,540 (1,380 ~ 5,040)		5,330 (1,380 ~ 6,050)	
Moisture Removal	gal/h		1.0		1.2	
Running Current (Rated)	A		7.20 - 6.51		8.41 - 7.60	
Power Consumption Rated (Min. ~ Max.)	W		1,441 (295 ~ 1,745)		1,696 (290 ~ 2,255)	
Power Factor (Rated)	%		96.2 - 96.2		97.0 - 97.0	
COP Rated (Min. ~ Max.)	W/W		3.66 (5.42 ~ 3.36)		3.66 (5.52 ~ 3.12)	
EER Rated (Min. ~ Max.)	Btu/h-W		12.5 (18.6 ~ 11.5)		12.5 (19.0 ~ 10.6)	
SEER			18.0		18.0	
Piping Connections	Liquid	in. (mm)	φ 1/4 (φ 6.4)		φ 1/4 (φ 6.4)	
	Gas	in. (mm)	φ 1/2 (φ 12.7)		φ 5/8 (φ 15.9)	
	Drain	in. (mm)	φ 5/8 (φ 16.0)		φ 5/8 (φ 16.0)	
Heat Insulation			Both Liquid and Gas Pipes		Both Liquid and Gas Pipes	
Max. Interunit Piping Length	ft (m)		98-1/2 (30)		98-1/2 (30)	
Max. Interunit Height Difference	ft (m)		65-5/8 (20)		65-5/8 (20)	
Chargeless	ft (m)		32-13/16 (10)		32-13/16 (10)	
Amount of Additional Charge of Refrigerant	oz/ft (g/m)		0.21 (20)		0.21 (20)	
Indoor Unit			FTK18NMVJU		FTK24NMVJU	
Front Panel Color			White		White	
Airflow Rate	H	m ³ /min (cfm)	20.2 (713)		20.2 (713)	
	M		16.4 (579)		16.4 (579)	
	L		12.7 (448)		14.5 (512)	
	SL		11.4 (403)		11.4 (403)	
Fan	Type		Cross Flow Fan		Cross Flow Fan	
	Motor Output	W	46		46	
	Speed	Steps	5 Steps, Quiet, Auto		5 Steps, Quiet, Auto	
Air Direction Control			Right, Left, Horizontal, Downward		Right, Left, Horizontal, Downward	
Air Filter			Removable, Washable, Mildew Proof		Removable, Washable, Mildew Proof	
Running Current (Rated)	A		0.43 - 0.39		0.43 - 0.39	
Power Consumption (Rated)	W		58 - 58		58 - 58	
Power Factor (Rated)	%		64.8 - 64.7		64.8 - 64.7	
Temperature Control			Microcomputer Control		Microcomputer Control	
Dimensions (H x W x D)	in. (mm)		11-5/8 x 39 x 10-3/8 (295 x 990 x 263)		11-5/8 x 39 x 10-3/8 (295 x 990 x 263)	
Packaged Dimensions (H x W x D)	in. (mm)		14-9/16 x 42-1/2 x 15-3/8 (370 x 1,080 x 390)		14-9/16 x 42-1/2 x 15-3/8 (370 x 1,080 x 390)	
Weight	Lbs (kg)		27 (12)		27 (12)	
Gross Weight	Lbs (kg)		37 (17)		37 (17)	
Sound Pressure Level	H / M / L / SL	dB(A)	49 / 44 / 38 / 33		53 / 45 / 39 / 34	
Outdoor Unit			RK18NMVJU		RK24NMVJU	
Casing Color			Ivory White		Ivory White	
Compressor	Type		Hermetically Sealed Swing Type		Hermetically Sealed Swing Type	
	Model		2YC36PXD		2YC36PXD	
	Motor Output	W	1,100		1,100	
Refrigerant Oil	Type		FVC50K		FVC50K	
	Charge	oz (L)	21.5 (0.650)		21.5 (0.650)	
Refrigerant	Type		R-410A		R-410A	
	Charge	Lbs (kg)	2.49 (1.13)		3.20 (1.45)	
Airflow Rate	H	m ³ /min (cfm)	69.7 (2,461)		59.5 (2,101)	
	SL		59.7 (2,108)		49.9 (1,762)	
Fan	Type		Propeller		Propeller	
	Motor Output	W	69		58	
Running Current (Rated)	A		6.77 - 6.12		7.98 - 7.21	
Power Consumption (Rated)	W		1,383 - 1,383		1,638 - 1,638	
Power Factor (Rated)	%		98.2 - 98.3		98.7 - 98.8	
Starting Current	A		7.20		8.41	
Dimensions (H x W x D)	in. (mm)		28-15/16 x 34-1/4 x 12-5/8 (735 x 870 x 320)		28-15/16 x 34-1/4 x 12-5/8 (735 x 870 x 320)	
Packaged Dimensions (H x W x D)	in. (mm)		31-7/8 x 41-9/16 x 17-1/2 (810 x 1,056 x 444)		31-7/8 x 41-9/16 x 17-1/2 (810 x 1,056 x 444)	
Weight	Lbs (kg)		97 (44)		108 (49)	
Gross Weight	Lbs (kg)		115 (52)		126 (57)	
Sound Pressure Level	H	dB(A)	54		55	
Drawing No.			3D093564A		3D093565A	

Note: ■ The data are based on the conditions shown in the table below.

Cooling	Indoor ; 80°FDB (26.7°CDB) / 67°FWB (19.4°CWB) Outdoor ; 95°FDB (35°CDB) / 75°FWB (24°CWB)
Piping Length	25 ft (7.5 m)

Conversion Formulae
kcal/h = kW x 860
Btu/h = kW x 3412
cfm = m ³ /min x 35.3

3.2 Heat Pump

60 Hz, 208 - 230 V

Model	Indoor Unit		FTX09NMVJU		FTX12NMVJU	
	Outdoor Unit		RX09NMVJU		RX12NMVJU	
			Cooling	Heating	Cooling	Heating
Capacity Rated (Min. ~ Max.)	kW		2.64 (1.30 ~ 3.00)	2.93 (1.30 ~ 3.80)	3.20 (1.30 ~ 3.90)	3.96 (1.30 ~ 4.80)
	Btu/h		9,000 (4,400 ~ 10,200)	10,000 (4,400 ~ 13,000)	10,900 (4,400 ~ 13,300)	13,500 (4,400 ~ 16,400)
	kcal/h		2,270 (1,120 ~ 2,580)	2,520 (1,120 ~ 3,270)	2,750 (1,120 ~ 3,350)	3,410 (1,120 ~ 4,130)
Moisture Removal	gal/h		0.32	—	0.45	—
Running Current (Rated)	A		3.77 - 3.41	3.76 - 3.40	4.42 - 3.99	5.24 - 4.73
Power Consumption Rated (Min. ~ Max.)	W		721 (250 ~ 962)	722 (260 ~ 1,100)	874 (260 ~ 1,383)	1,041 (260 ~ 1,350)
Power Factor (Rated)	%		91.9 - 91.9	92.3 - 92.3	95.1 - 95.2	95.5 - 95.7
COP Rated (Min. ~ Max.)	W/W		3.66 (5.20 ~ 3.12)	4.06 (5.00 ~ 3.42)	3.66 (5.00 ~ 2.82)	3.80 (5.00 ~ 3.56)
EER Rated (Min. ~ Max.)	Btu/h-W		12.5 (17.6 ~ 10.6)	13.9 (16.9 ~ 11.7)	12.5 (16.9 ~ 9.6)	13.0 (16.9 ~ 12.1)
SEER / HSPF			19.0	9.0	19.0	9.0
Piping Connections	Liquid	in. (mm)	φ 1/4 (φ 6.4)		φ 1/4 (φ 6.4)	
	Gas	in. (mm)	φ 3/8 (φ 9.5)		φ 3/8 (φ 9.5)	
	Drain	in. (mm)	φ 5/8 (φ 16.0)		φ 5/8 (φ 16.0)	
Heat Insulation			Both Liquid and Gas Pipes		Both Liquid and Gas Pipes	
Max. Interunit Piping Length	ft (m)		65-5/8 (20)		65-5/8 (20)	
Max. Interunit Height Difference	ft (m)		49-1/4 (15)		49-1/4 (15)	
Chargeless	ft (m)		32-13/16 (10)		32-13/16 (10)	
Amount of Additional Charge of Refrigerant	oz/ft (g/m)		0.21 (20)		0.21 (20)	
Indoor Unit			FTX09NMVJU		FTX12NMVJU	
Front Panel Color			White		White	
Airflow Rate	H	m ³ /min (cfm)	11.8 (417)	11.4 (403)	12.3 (434)	11.7 (413)
	M		8.4 (297)	9.3 (328)	8.8 (311)	9.1 (321)
	L		6.9 (244)	7.1 (251)	7.0 (247)	7.3 (258)
	SL		4.0 (141)	6.1 (215)	4.1 (145)	6.2 (219)
Fan	Type	Cross Flow Fan		Cross Flow Fan		
	Motor Output	W		28		
	Speed	Steps		5 Steps, Quiet, Auto		
Air Direction Control			Right, Left, Horizontal, Downward		Right, Left, Horizontal, Downward	
Air Filter			Removable, Washable, Mildew Proof		Removable, Washable, Mildew Proof	
Running Current (Rated)	A		0.25 - 0.23	0.23 - 0.21	0.28 - 0.25	0.25 - 0.23
Power Consumption (Rated)	W		28 - 28	25 - 25	31 - 31	28 - 28
Power Factor (Rated)	%		53.8 - 52.9	52.3 - 51.8	53.2 - 53.9	53.8 - 52.9
Temperature Control			Microcomputer Control		Microcomputer Control	
Dimensions (H x W x D)	in. (mm)		11-1/4 x 30-5/16 x 8-3/4 (285 x 770 x 223)		11-1/4 x 30-5/16 x 8-3/4 (285 x 770 x 223)	
Packaged Dimensions (H x W x D)	in. (mm)		12 x 32-11/16 x 14-3/16 (305 x 831 x 360)		12 x 32-11/16 x 14-3/16 (305 x 831 x 360)	
Weight	Lbs (kg)		18 (8)		18 (8)	
Gross Weight	Lbs (kg)		24 (11)		25 (11)	
Sound Pressure Level	H / M / L / SL	dB(A)	43 / 36 / 30 / 19		45 / 37 / 30 / 19	
Outdoor Unit			RX09NMVJU		RX12NMVJU	
Casing Color			Ivory White		Ivory White	
Compressor	Type	Hermetically Sealed Swing Type		Hermetically Sealed Swing Type		
	Model	1YC23AUXD		1YC23AUXD		
Refrigerant Oil	Motor Output	W		790		
	Type	FVC50K		FVC50K		
Refrigerant	Charge	oz (L)		12.4 (0.375)		
	Type	R-410A		R-410A		
Airflow Rate	H	m ³ /min (cfm)	31.2 (1,102)	28.5 (1,006)	31.3 (1,105)	26.1 (922)
	SL		29.3 (1,035)	26.0 (918)	24.5 (865)	22.0 (777)
Fan	Type	Propeller		Propeller		
	Motor Output	W		18		
Running Current (Rated)	A		3.52 - 3.18	3.53 - 3.19	4.14 - 3.74	4.99 - 4.50
Power Consumption (Rated)	W		693 - 693	697 - 697	843 - 843	1,013 - 1,013
Power Factor (Rated)	%		94.7 - 94.7	94.9 - 95.0	97.9 - 98.0	97.6 - 97.9
Starting Current	A		3.77		5.24	
Dimensions (H x W x D)	in. (mm)		21-5/8 x 26-9/16 x 11-3/16 (550 x 675 x 284)		21-5/8 x 26-9/16 x 11-3/16 (550 x 675 x 284)	
Packaged Dimensions (H x W x D)	in. (mm)		24-3/4 x 32-11/16 x 16 (629 x 830 x 407)		24-3/4 x 32-11/16 x 16 (629 x 830 x 407)	
Weight	Lbs (kg)		55 (25)		60 (27)	
Gross Weight	Lbs (kg)		66 (30)		71 (32)	
Sound Pressure Level	H	dB(A)	46	48	49	49
Drawing No.			C: 3D093558		C: 3D093559A	

Note: ■ The data are based on the conditions shown in the table below.

Cooling	Indoor ; 80°FDB (26.7°CDB) / 67°FWB (19.4°CWB) Outdoor ; 95°FDB (35°CDB) / 75°FWB (24°CWB)
Heating	Indoor ; 70°FDB (21°CDB) / 60°FWB (15.6°CWB) Outdoor ; 47°FDB (8.3°CDB) / 43°FWB (6°CWB)
Piping Length	25 ft (7.5 m)

Conversion Formulae
kcal/h = kW x 860
Btu/h = kW x 3412
cfm = m ³ /min x 35.3

60 Hz, 208 - 230V

Model	Indoor Unit		FTX18NMVJU		FTX24NMVJU	
	Outdoor Unit		RX18NMVJU		RX24NMVJU	
			Cooling	Heating	Cooling	Heating
Capacity Rated (Min. ~ Max.)	kW		5.28 (1.60 ~ 5.86)	6.33 (1.60 ~ 7.03)	6.20 (1.60 ~ 7.03)	7.03 (1.70 ~ 8.10)
	Btu/h		18,000 (5,500 ~ 20,000)	21,600 (5,500 ~ 24,000)	21,200 (5,500 ~ 24,000)	24,000 (5,800 ~ 27,600)
	kcal/h		4,540 (1,380 ~ 5,040)	5,440 (1,380 ~ 6,050)	5,330 (1,380 ~ 6,050)	6,050 (1,460 ~ 6,970)
Moisture Removal	gal/h		1.00	—	1.20	—
Running Current (Rated)	A		7.20 - 6.51	8.68 - 7.85	8.41 - 7.60	9.90 - 8.95
Power Consumption Rated (Min. ~ Max.)	W		1,441 (295 ~ 1,745)	1,758 (348 ~ 2,000)	1,696 (290 ~ 2,255)	2,010 (381 ~ 2,380)
Power Factor (Rated)	%		96.2 - 96.2	97.4 - 97.4	97.0 - 97.0	97.6 - 97.6
COP Rated (Min. ~ Max.)	W/W		3.66 (5.42 ~ 3.36)	3.60 (4.60 ~ 3.52)	3.66 (5.52 ~ 3.12)	3.50 (4.46 ~ 3.40)
EER Rated (Min. ~ Max.)	Btu/h·W		12.5 (18.6 ~ 11.5)	12.3 (15.8 ~ 12.0)	12.5 (19.0 ~ 10.6)	11.9 (15.2 ~ 11.6)
SEER / HSPF			18.0	9.0	18.0	9.0
Piping Connections	Liquid	in. (mm)	φ 1/4 (φ 6.4)		φ 1/4 (φ 6.4)	
	Gas	in. (mm)	φ 1/2 (φ 12.7)		φ 5/8 (φ 15.9)	
	Drain	in. (mm)	φ 5/8 (φ 16.0)		φ 5/8 (φ 16.0)	
Heat Insulation			Both Liquid and Gas Pipes		Both Liquid and Gas Pipes	
Max. Interunit Piping Length	ft (m)		98-1/2 (30)		98-1/2 (30)	
Max. Interunit Height Difference	ft (m)		65-5/8 (20)		65-5/8 (20)	
Chargeless	ft (m)		32-13/16 (10)		32-13/16 (10)	
Amount of Additional Charge of Refrigerant	oz/ft (g/m)		0.21 (20)		0.21 (20)	
Indoor Unit			FTX18NMVJU		FTX24NMVJU	
Front Panel Color			White		White	
Airflow Rate	H	m ³ /min (cfm)	20.2 (713)	21.1 (745)	20.2 (713)	21.1 (745)
	M		16.4 (579)	17.1 (604)	16.4 (579)	17.1 (604)
	L		12.7 (448)	13.3 (470)	14.5 (512)	13.3 (470)
	SL		11.4 (403)	11.9 (420)	11.4 (403)	11.9 (420)
Fan	Type		Cross Flow Fan		Cross Flow Fan	
	Motor Output	W	46		46	
	Speed	Steps	5 Steps, Quiet, Auto		5 Steps, Quiet, Auto	
Air Direction Control			Right, Left, Horizontal, Downward		Right, Left, Horizontal, Downward	
Air Filter			Removable, Washable, Mildew Proof		Removable, Washable, Mildew Proof	
Running Current (Rated)	A		0.43 - 0.39	0.43 - 0.39	0.43 - 0.39	0.43 - 0.39
Power Consumption (Rated)	W		58 - 58	58 - 58	58 - 58	58 - 58
Power Factor (Rated)	%		64.8 - 64.7	64.8 - 64.7	64.8 - 64.7	64.8 - 64.7
Temperature Control			Microcomputer Control		Microcomputer Control	
Dimensions (H x W x D)	in. (mm)		11-5/8 x 39 x 10-3/8 (295 x 990 x 263)		11-5/8 x 39 x 10-3/8 (295 x 990 x 263)	
Packaged Dimensions (H x W x D)	in. (mm)		14-9/16 x 42-1/2 x 15-3/8 (370 x 1,080 x 390)		14-9/16 x 42-1/2 x 15-3/8 (370 x 1,080 x 390)	
Weight	Lbs (kg)		27 (12)		27 (12)	
Gross Weight	Lbs (kg)		37 (17)		37 (17)	
Sound Pressure Level	H / M / L / SL	dB(A)	49 / 44 / 38 / 33	49 / 42 / 37 / 33	53 / 45 / 39 / 34	53 / 43 / 37 / 34
Outdoor Unit			RX18NMVJU		RX24NMVJU	
Casing Color			Ivory White		Ivory White	
Compressor	Type		Hermetically Sealed Swing Type		Hermetically Sealed Swing Type	
	Model		2YC36PXD		2YC36PXD	
	Motor Output	W	1,100		1,100	
Refrigerant Oil	Type		FVC50K		FVC50K	
	Charge	oz (L)	21.5 (0.650)		21.5 (0.650)	
Refrigerant	Type		R-410A		R-410A	
	Charge	Lbs (kg)	2.49 (1.13)		3.20 (1.45)	
Airflow Rate	H	m ³ /min (cfm)	69.7 (2,461)	62.8 (2,217)	59.5 (2,101)	53.6 (1,893)
	SL		59.7 (2,108)	53.7 (1,896)	49.9 (1,762)	44.9 (1,585)
Fan	Type		Propeller		Propeller	
	Motor Output	W	69		58	
Running Current (Rated)	A		6.77 - 6.12	8.25 - 7.46	7.98 - 7.21	9.47 - 8.56
Power Consumption (Rated)	W		1,383 - 1,383	1,700 - 1,700	1,638 - 1,638	1,952 - 1,952
Power Factor (Rated)	%		98.2 - 98.3	99.1 - 99.1	98.7 - 98.8	99.1 - 99.1
Starting Current	A		8.68		9.90	
Dimensions (H x W x D)	in. (mm)		28-15/16 x 34-1/4 x 12-5/8 (735 x 870 x 320)		28-15/16 x 34-1/4 x 12-5/8 (735 x 870 x 320)	
Packaged Dimensions (H x W x D)	in. (mm)		31-7/8 x 41-9/16 x 17-1/2 (810 x 1,056 x 444)		31-7/8 x 41-9/16 x 17-1/2 (810 x 1,056 x 444)	
Weight	Lbs (kg)		97 (44)		108 (49)	
Gross Weight	Lbs (kg)		115 (52)		126 (57)	
Sound Pressure Level	H	dB(A)	54	54	55	55
Drawing No.			3D093562		3D093563A	

Note: ■ The data are based on the conditions shown in the table below.

Cooling	Indoor ; 80°FDB (26.7°CDB) / 67°FWB (19.4°CWB) Outdoor ; 95°FDB (35°CDB) / 75°FWB (24°CWB)
Heating	Indoor ; 70°FDB (21°CDB) / 60°FWB (15.6°CWB) Outdoor ; 47°FDB (8.3°CDB) / 43°FWB (6°CWB)
Piping Length	25 ft (7.5 m)

Conversion Formulae
kcal/h = kW x 860
Btu/h = kW x 3412
cfm = m ³ /min x 35.3

4. Dimensions

4.1 Indoor Unit

4.1.1 Cooling Only

FTK09/12NMVJU

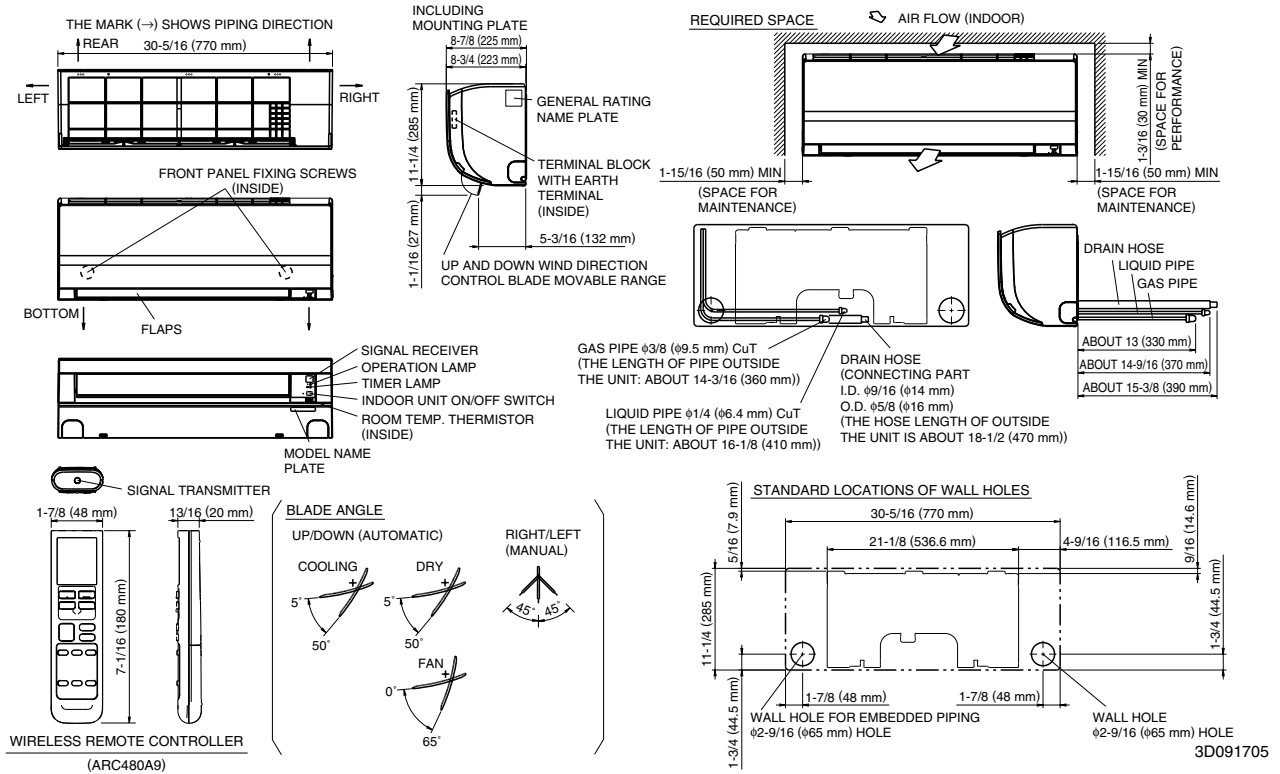

FTK18NMVJU

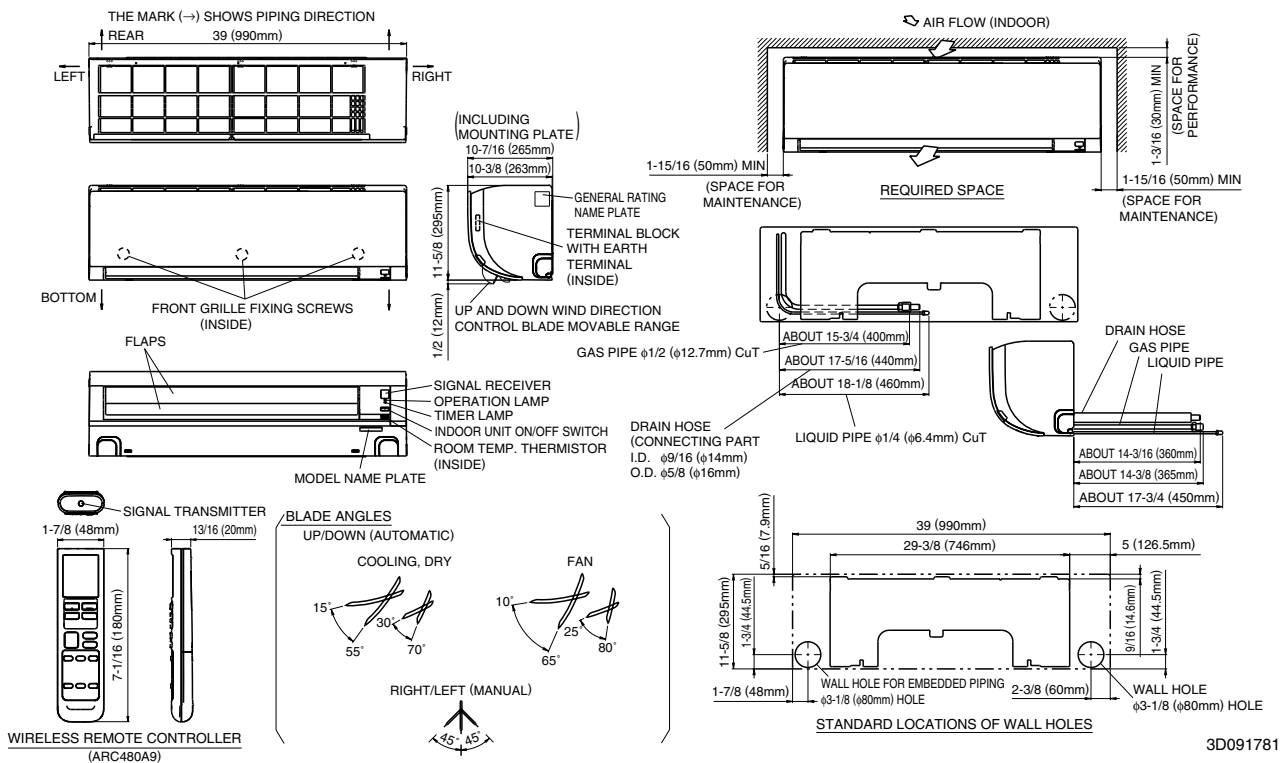

FTK24NMVJU

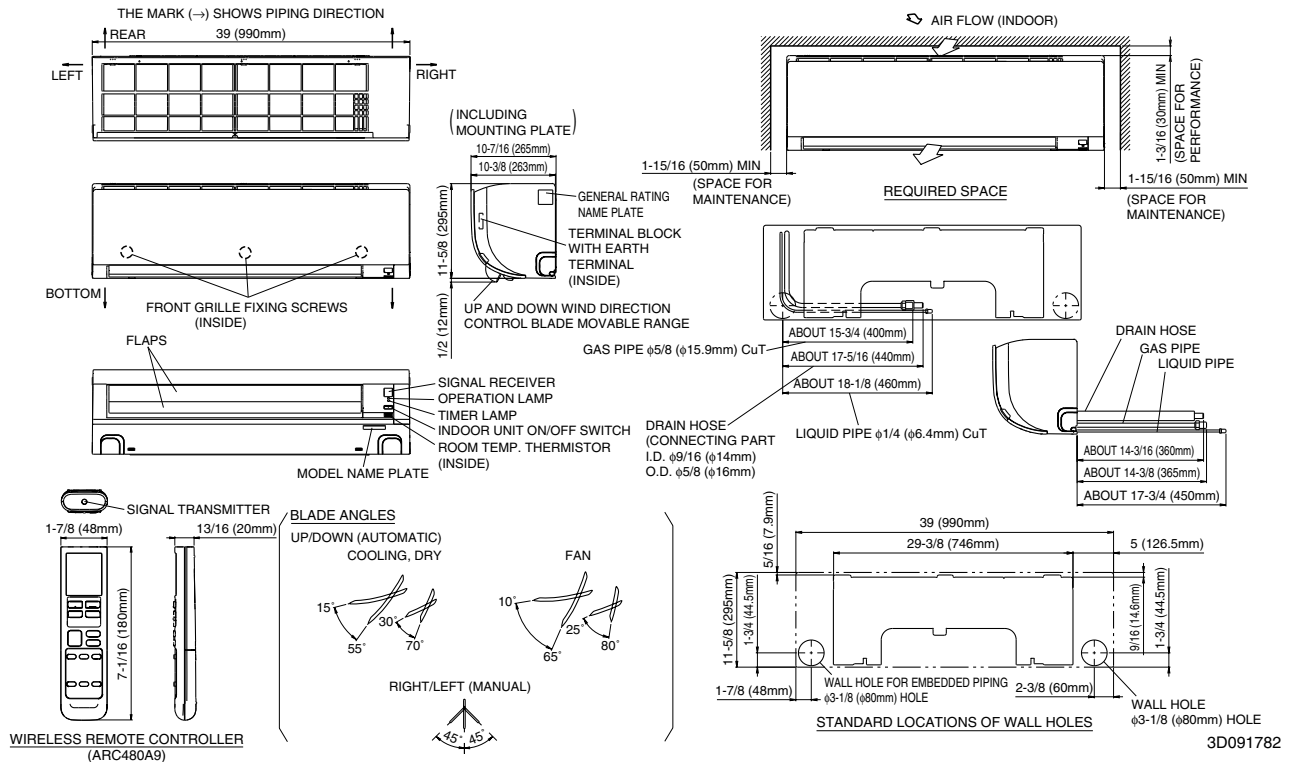

4.1.2 Heat Pump

FTX09/12NMVJU

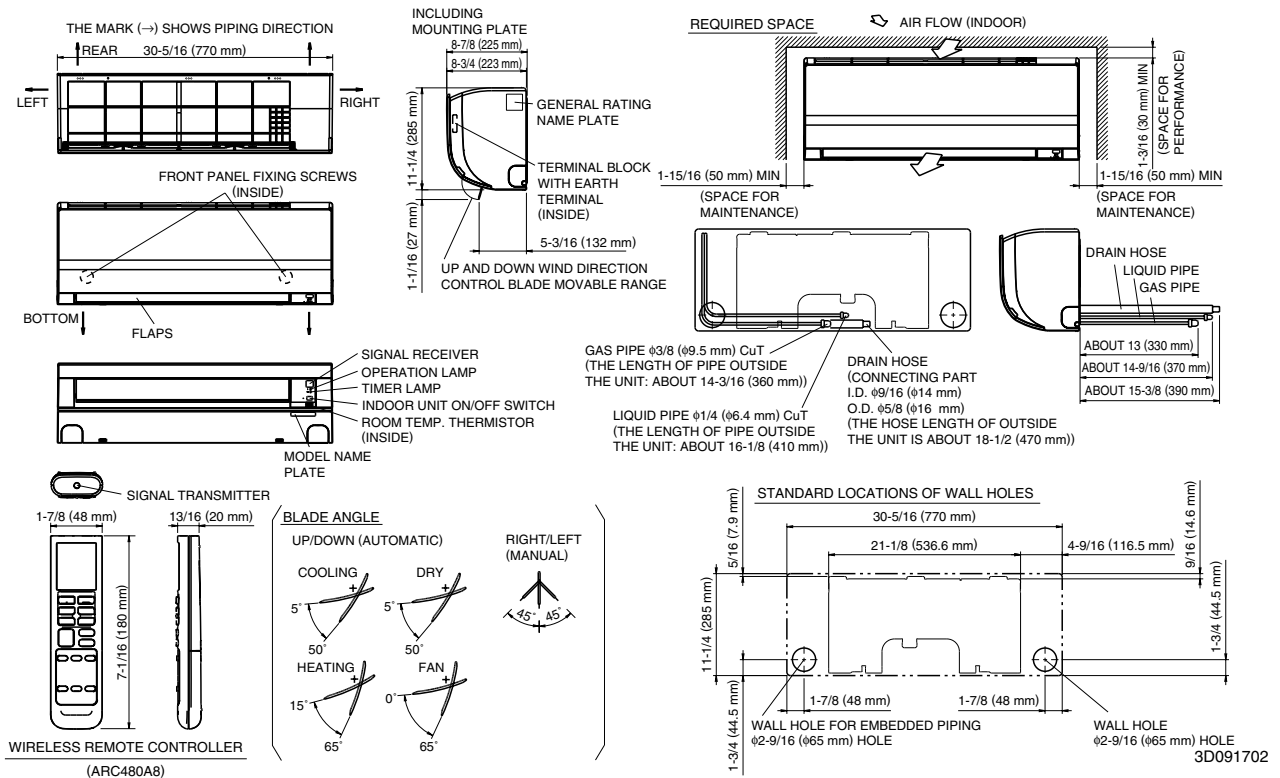

FTX18NMVJU

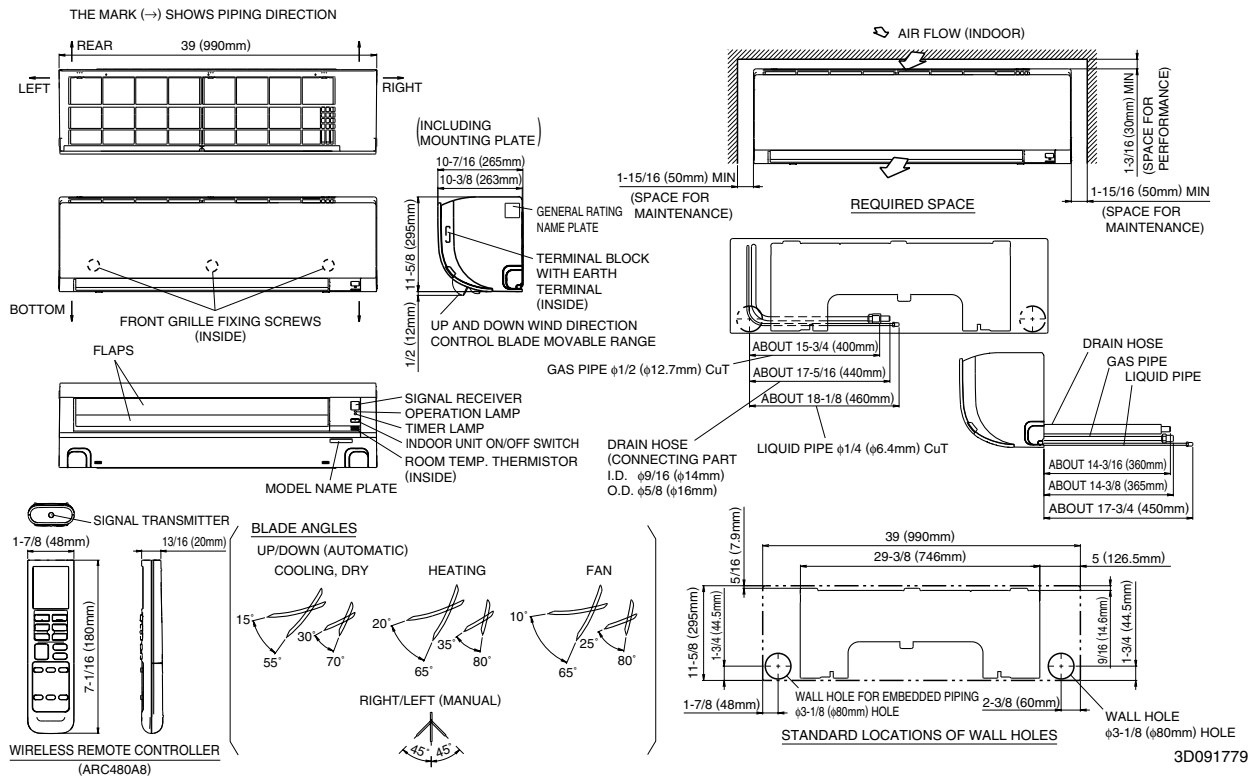

FTX24NMVJU

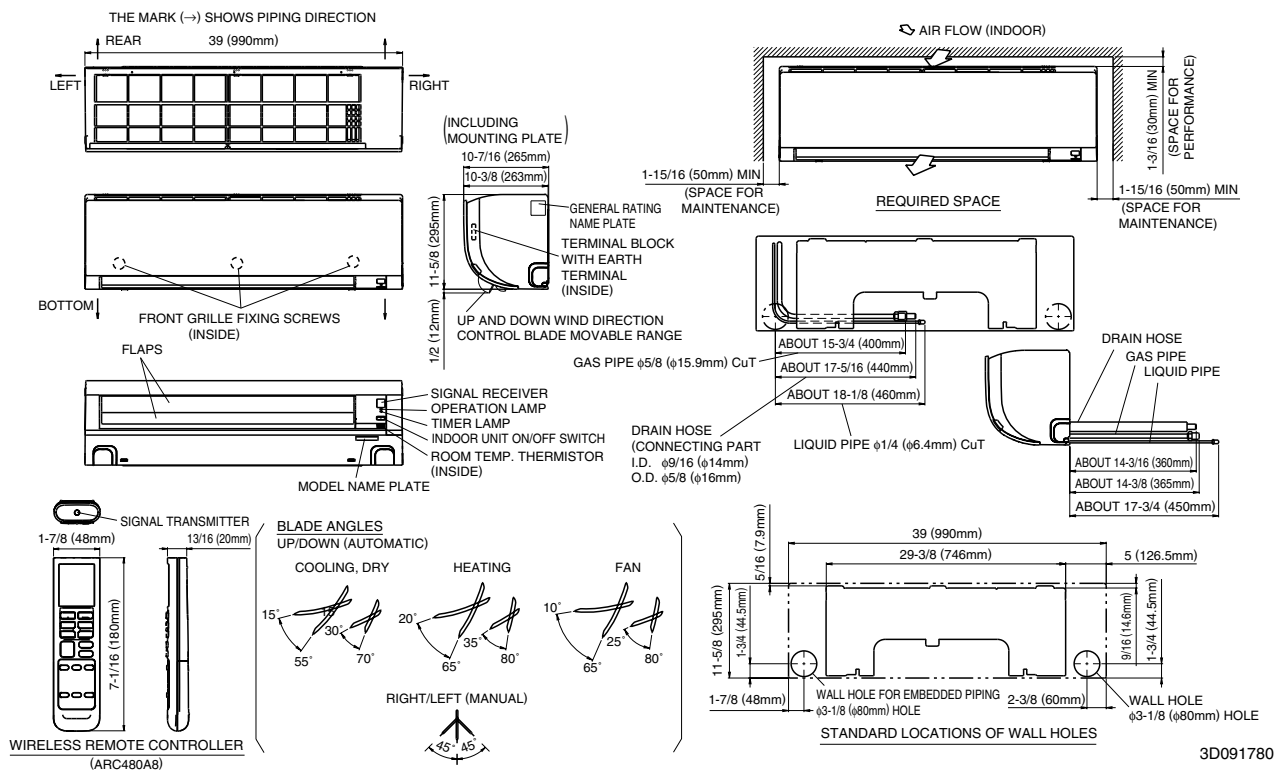

4.2 Outdoor Unit

RK09/12NMVJU, RX09/12NMVJU

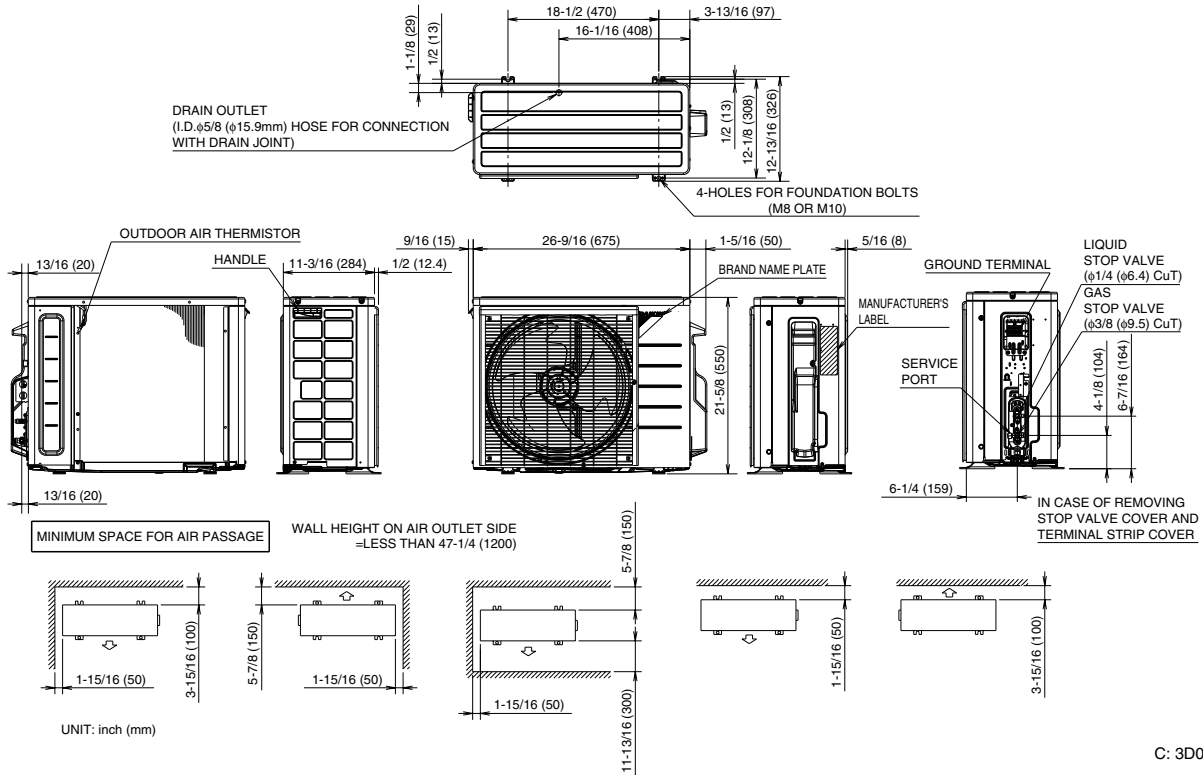

C: 3D092206

RK18NMVJU, RX18NMVJU

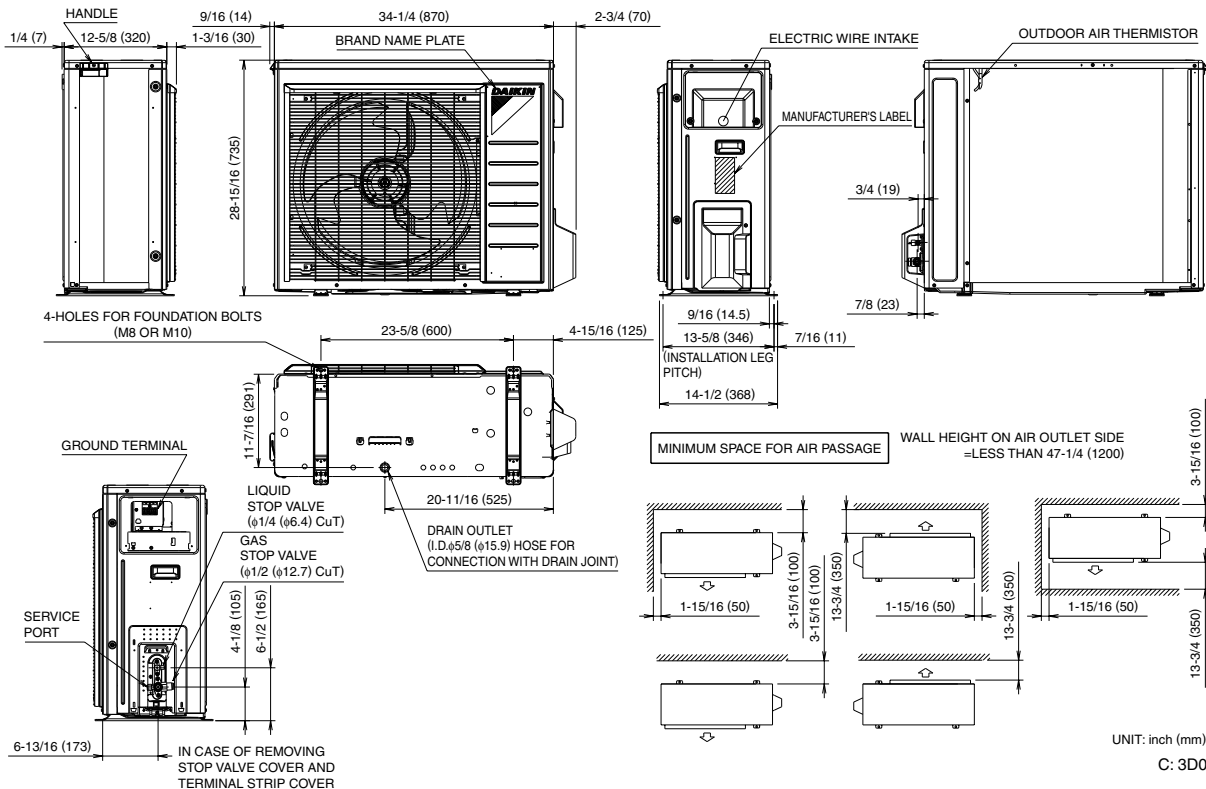

C: 3D092224

RK24NMVJU, RX24NMVJU

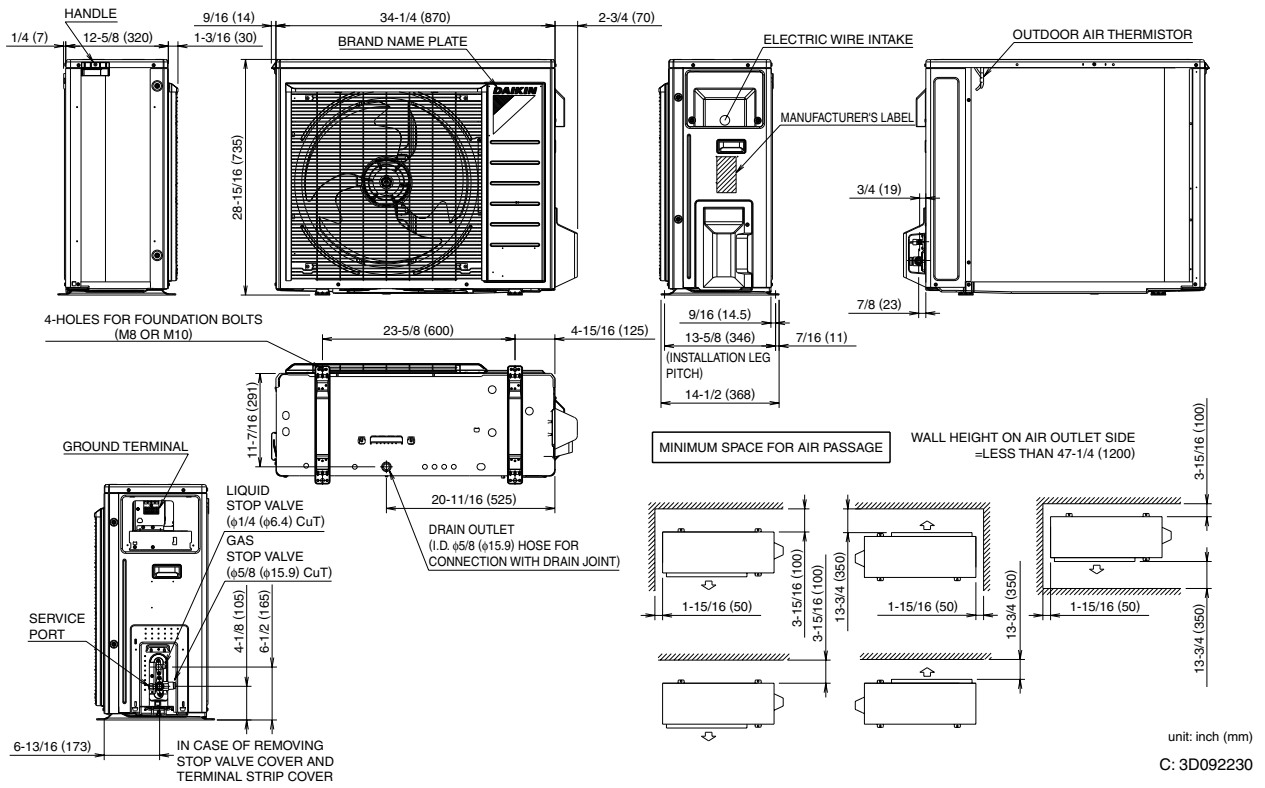

5. Wiring Diagrams

5.1 Indoor Unit

FTK09/12NMVJU, FTX09/12NMVJU

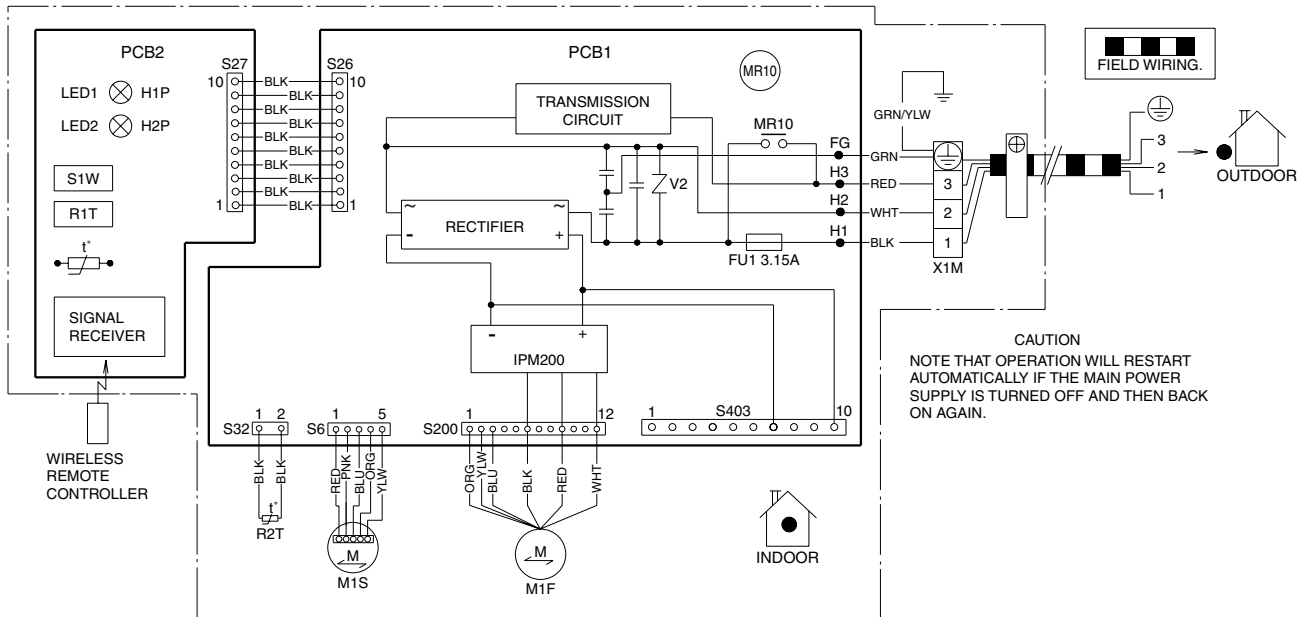

- | | | | | | | | |
|-------|----------------|------------|-------------------------|------|--------------------|---|---------------------|
| FG | : FRAME GROUND | M1S | : SWING MOTOR | S1W | : OPERATION SWITCH | ⊕ | : PROTECTIVE GROUND |
| FU1 | : FUSE | PCB1, PCB2 | : PRINTED CIRCUIT BOARD | X1M | : TERMINAL STRIP | | |
| H1-H3 | : HARNESS | R1T, R2T | : THERMISTOR | V2 | : VARISTOR | | |
| M1F | : FAN MOTOR | S6-S403 | : CONNECTOR | MR10 | : RELAY | | |

C: 3D086429B

FTK18/24NMVJU, FTX18/24NMVJU

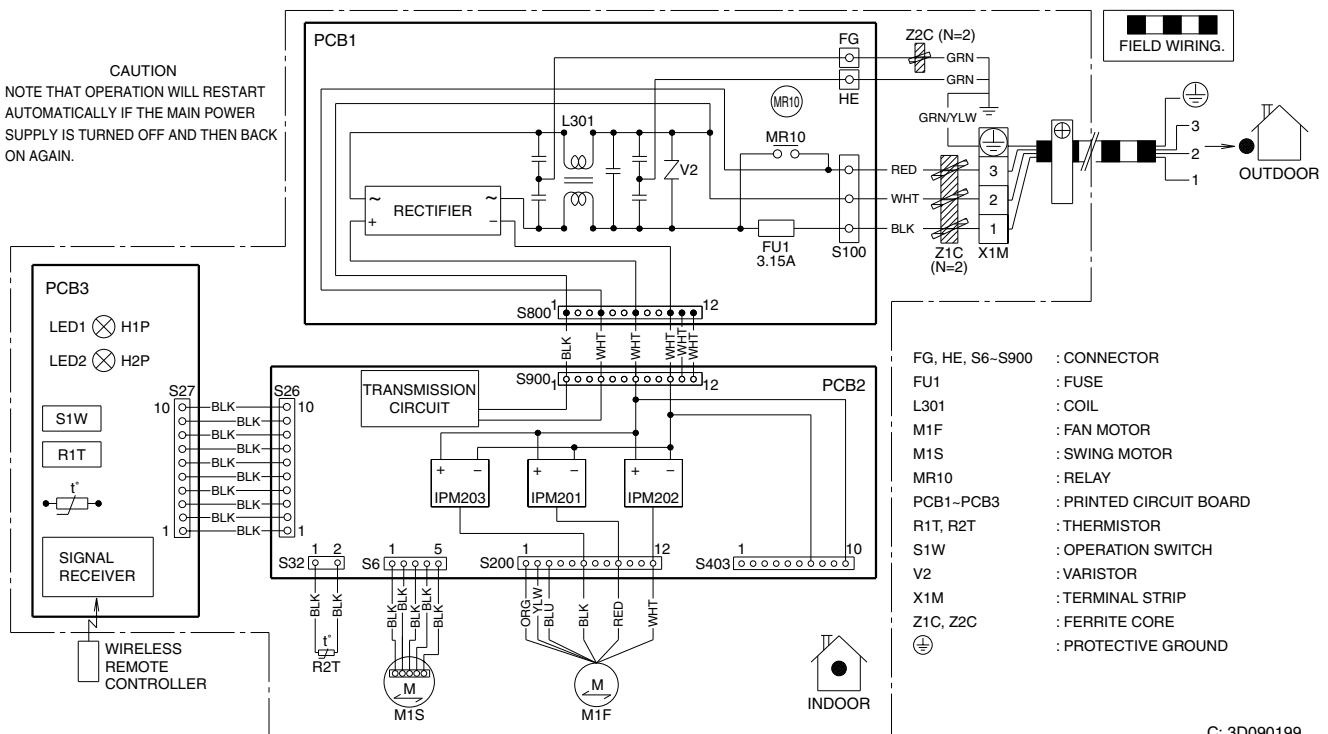

- | | |
|-----------------|-------------------------|
| FG, HE, S6-S900 | : CONNECTOR |
| FU1 | : FUSE |
| L301 | : COIL |
| M1F | : FAN MOTOR |
| M1S | : SWING MOTOR |
| MR10 | : RELAY |
| PCB1-PCB3 | : PRINTED CIRCUIT BOARD |
| R1T, R2T | : THERMISTOR |
| S1W | : OPERATION SWITCH |
| V2 | : VARISTOR |
| X1M | : TERMINAL STRIP |
| Z1C, Z2C | : FERRITE CORE |
| ⊕ | : PROTECTIVE GROUND |

C: 3D090199

5.2 Outdoor Unit

RK09/12NMVJU, RX09/12NMVJU

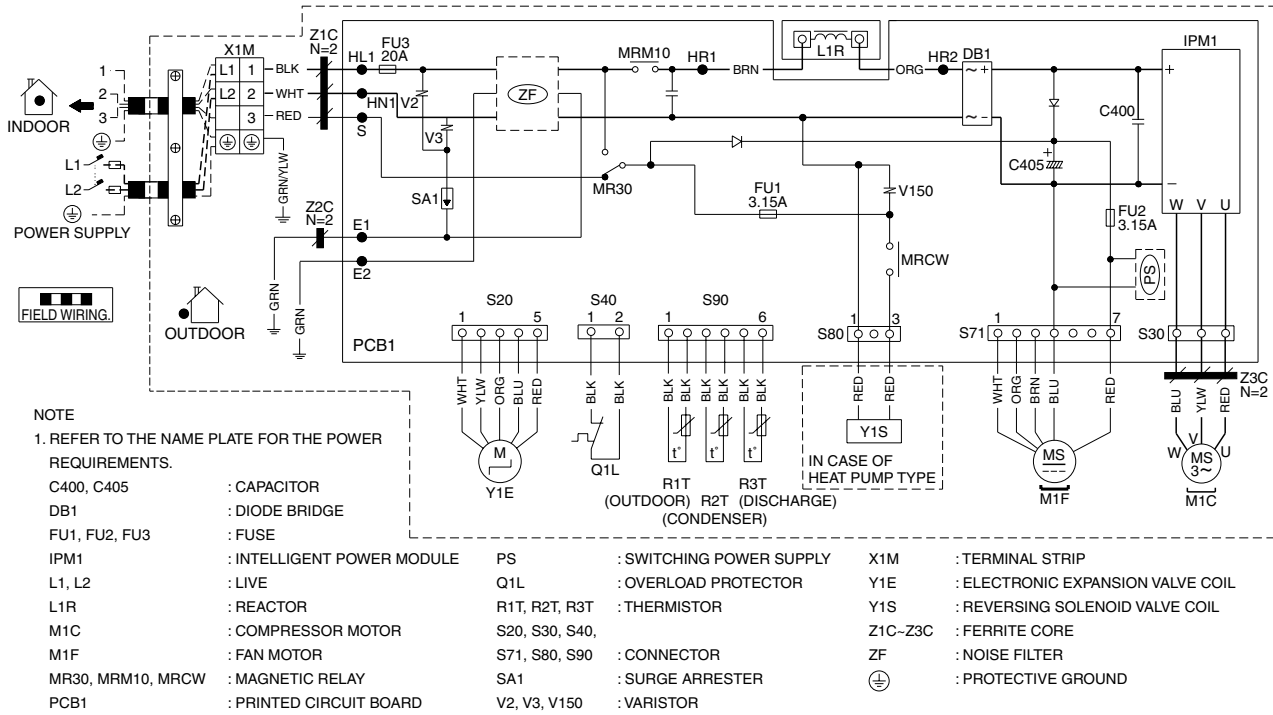

C: 3D089069

RK18/24NMVJU, RX18/24NMVJU

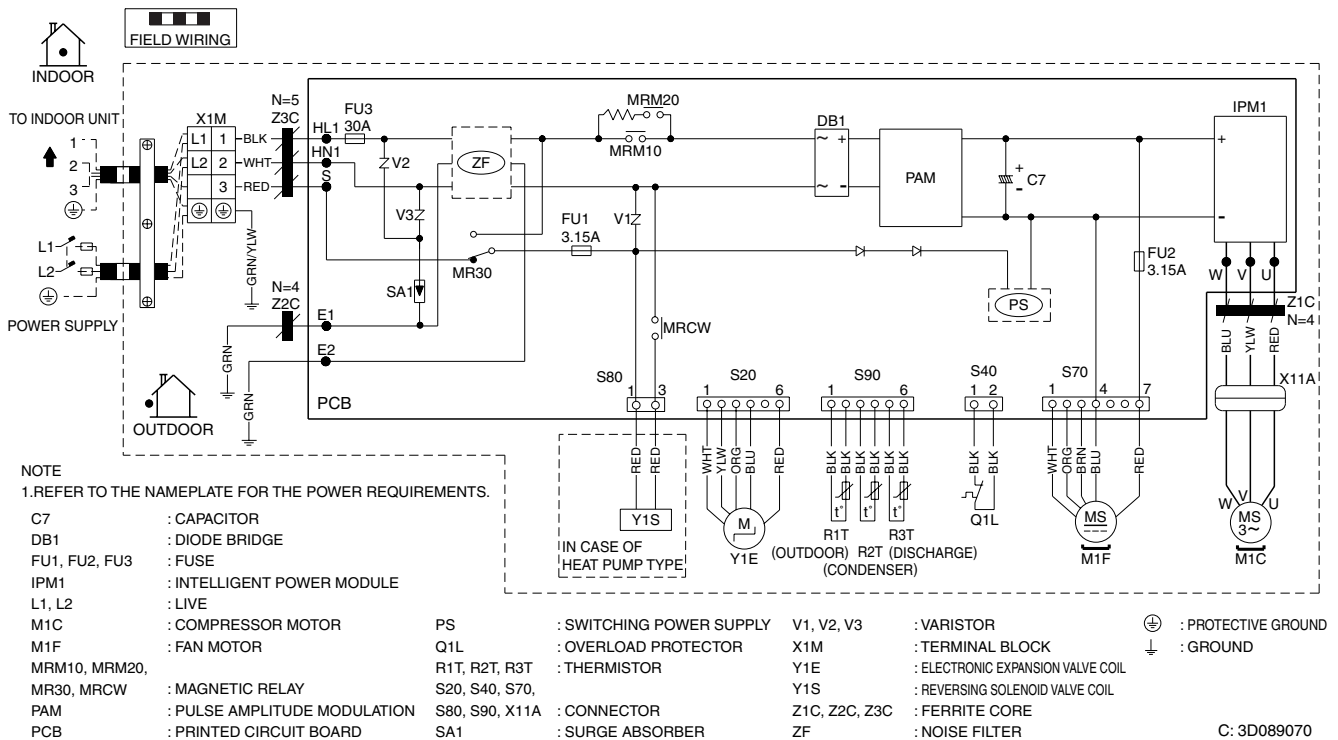

C: 3D089070

6. Piping Diagrams

6.1 Indoor Unit

6.1.1 Cooling Only

FTK09/12NMVJU

FTK18NMVJU

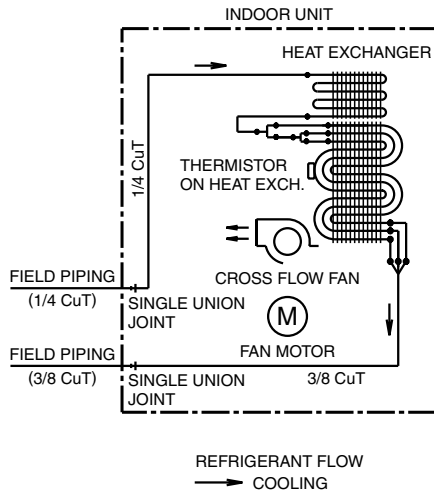

4D092108

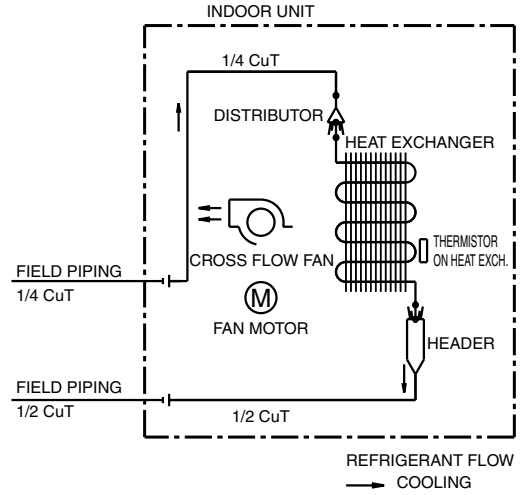

4D091771

FTK24NMVJU

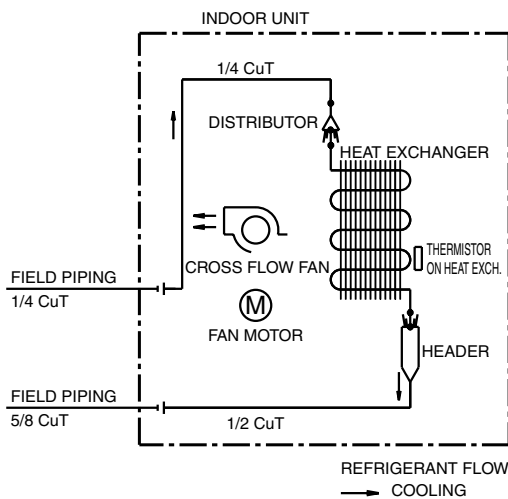

4D091770

6.1.2 Heat Pump

FTX09/12NMVJU

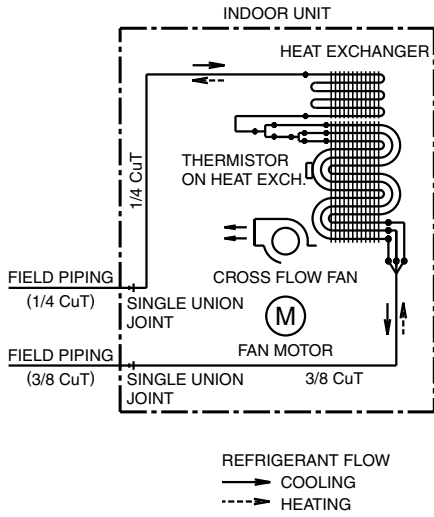

4D091708A

FTX18NMVJU

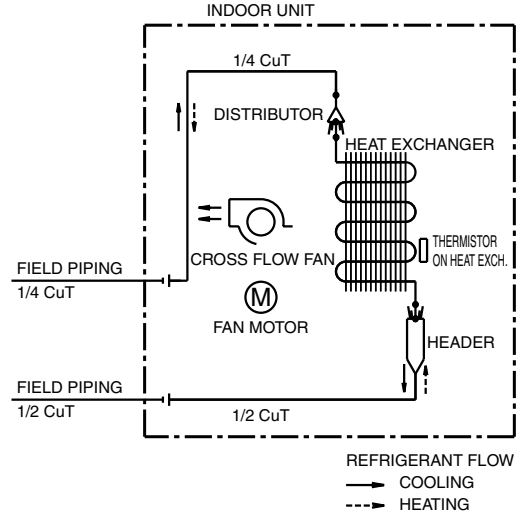

4D091769

FTX24NMVJU

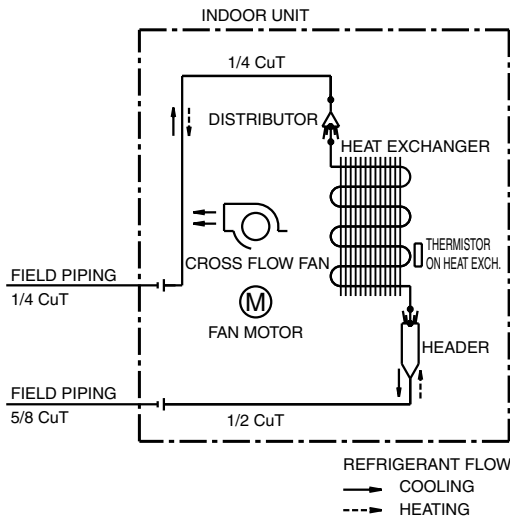

4D091768

6.2 Outdoor Unit

6.2.1 Cooling Only

RK09NMVJU

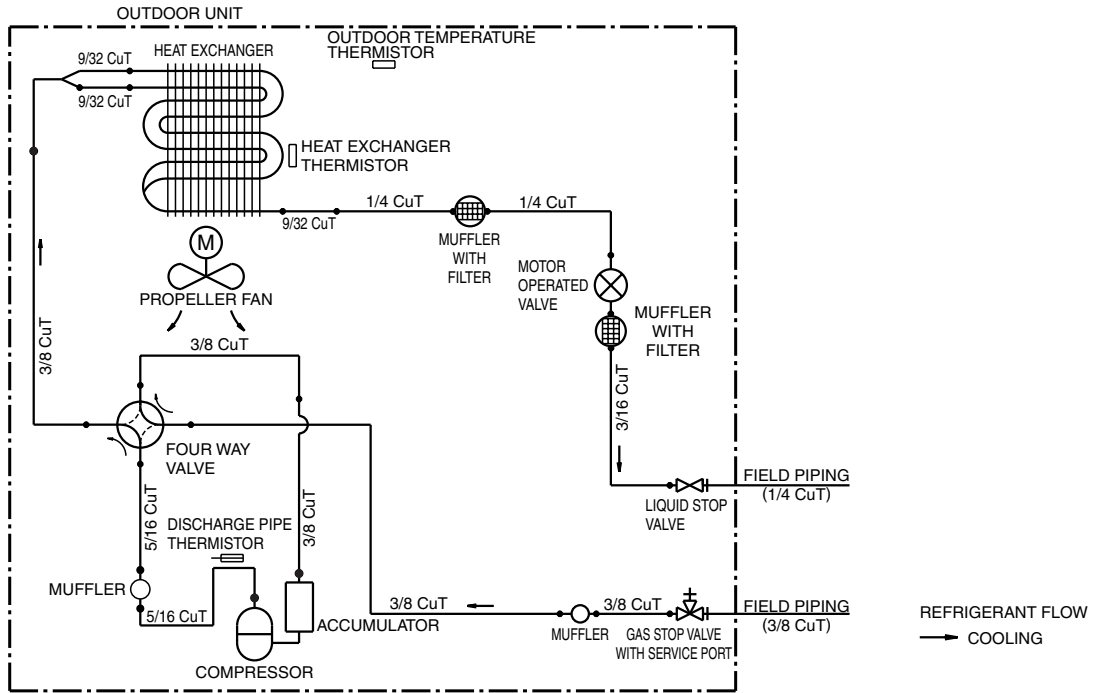

3D092245

RK12NMVJU

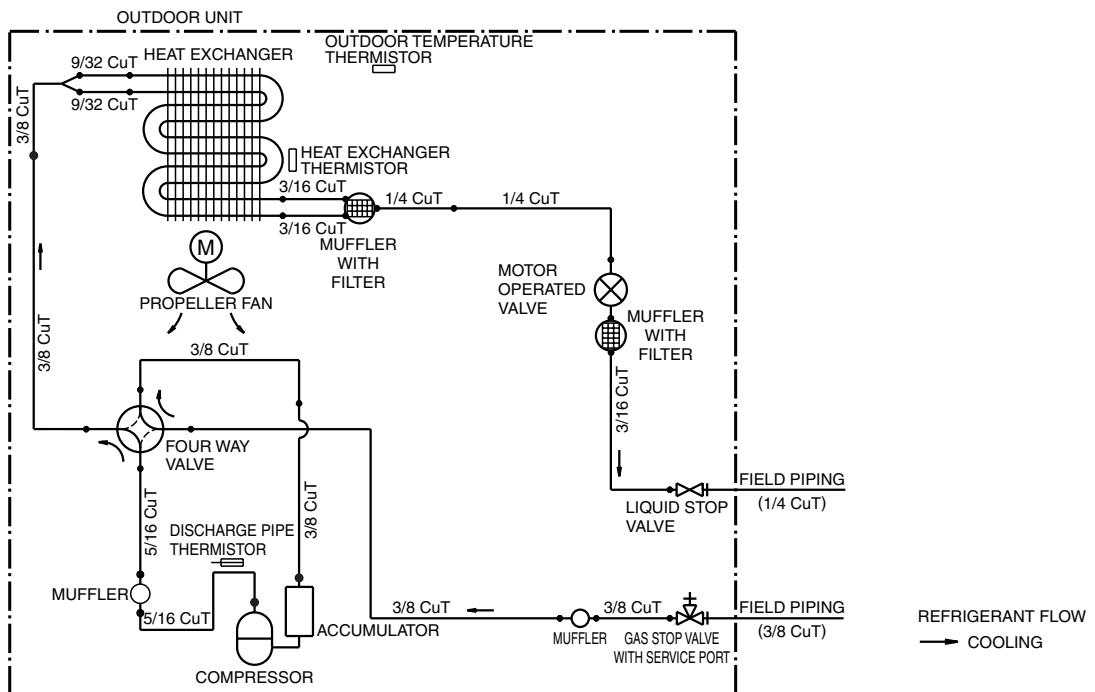

3D092208

RK18NMVJU

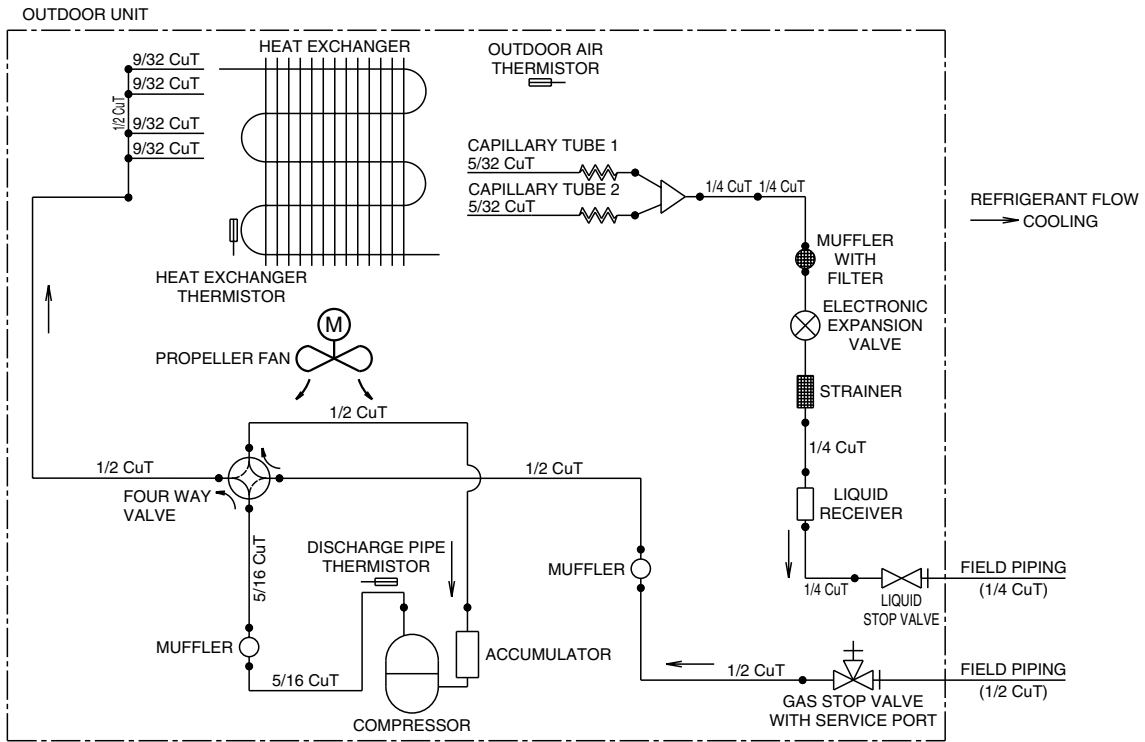

3D092222

RK24NMVJU

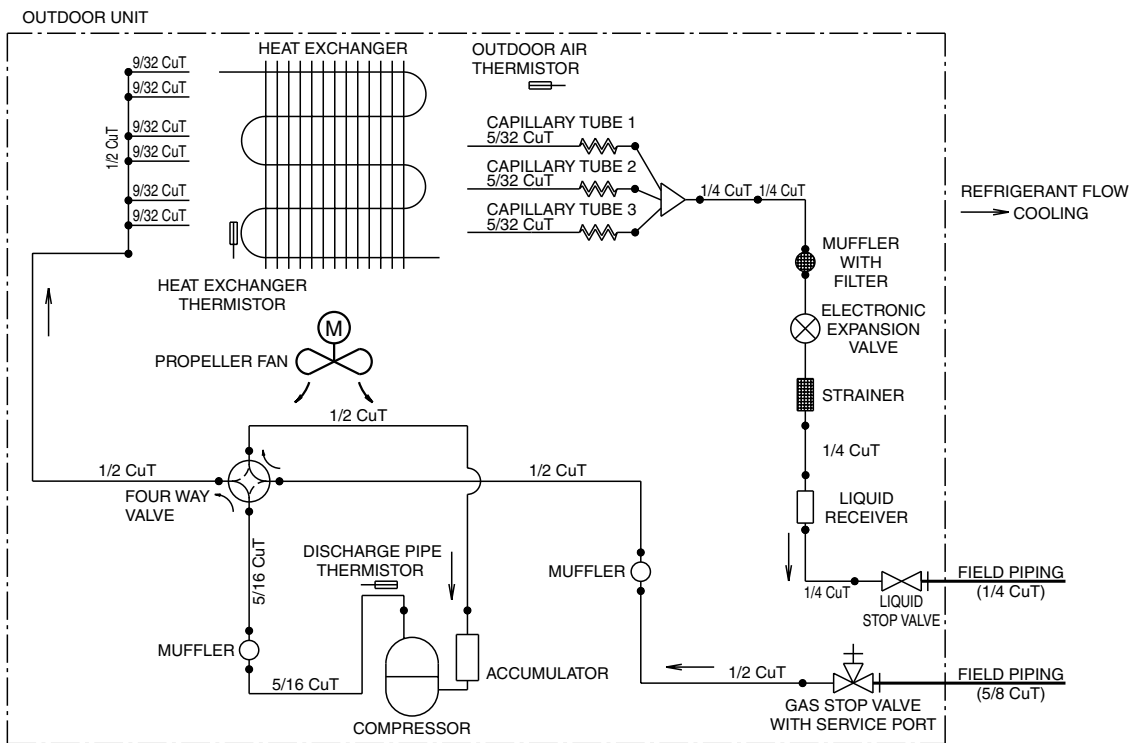

3D092250

6.2.2 Heat Pump

RX09NMVJU

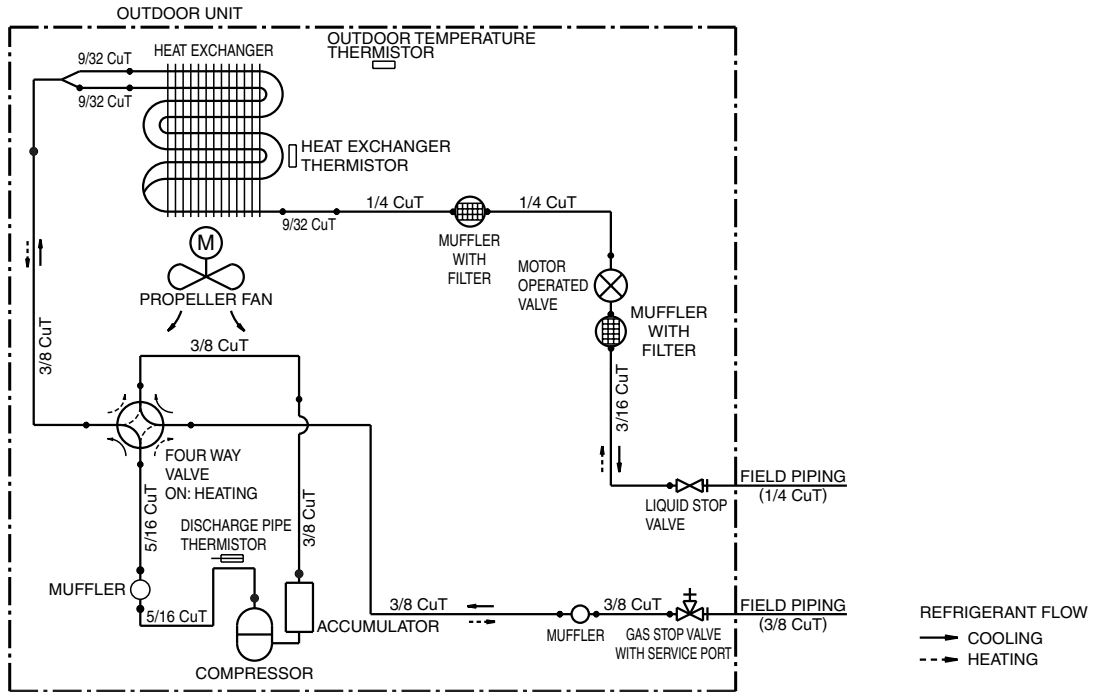

3D092244

RX12NMVJU

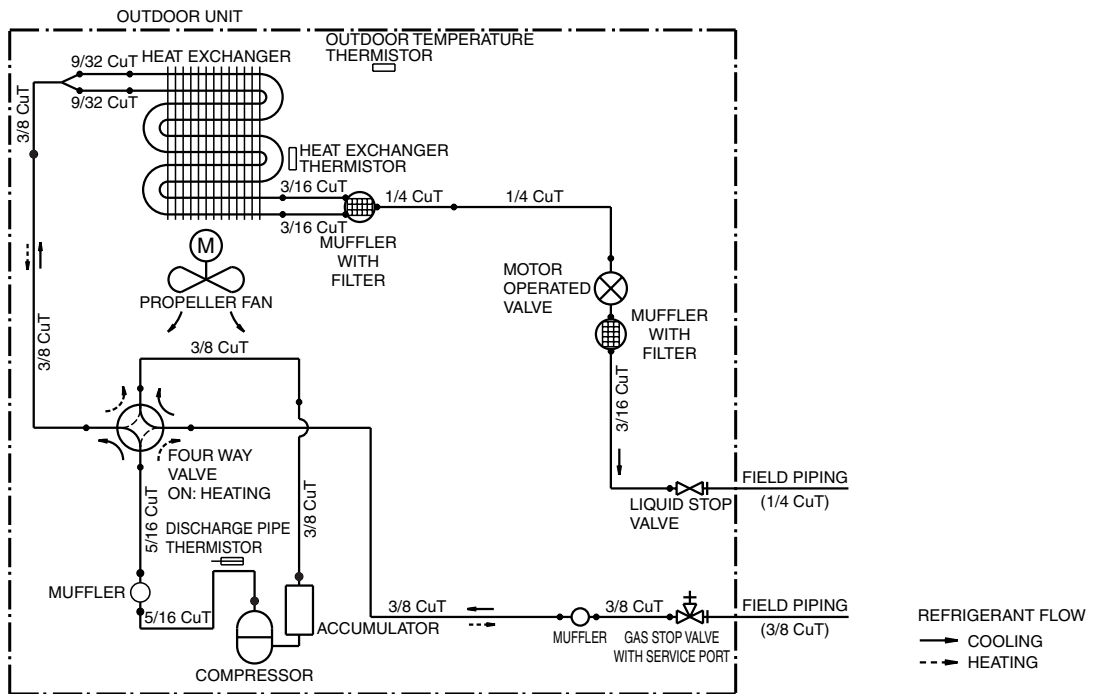

3D092207

RX18NMVJU

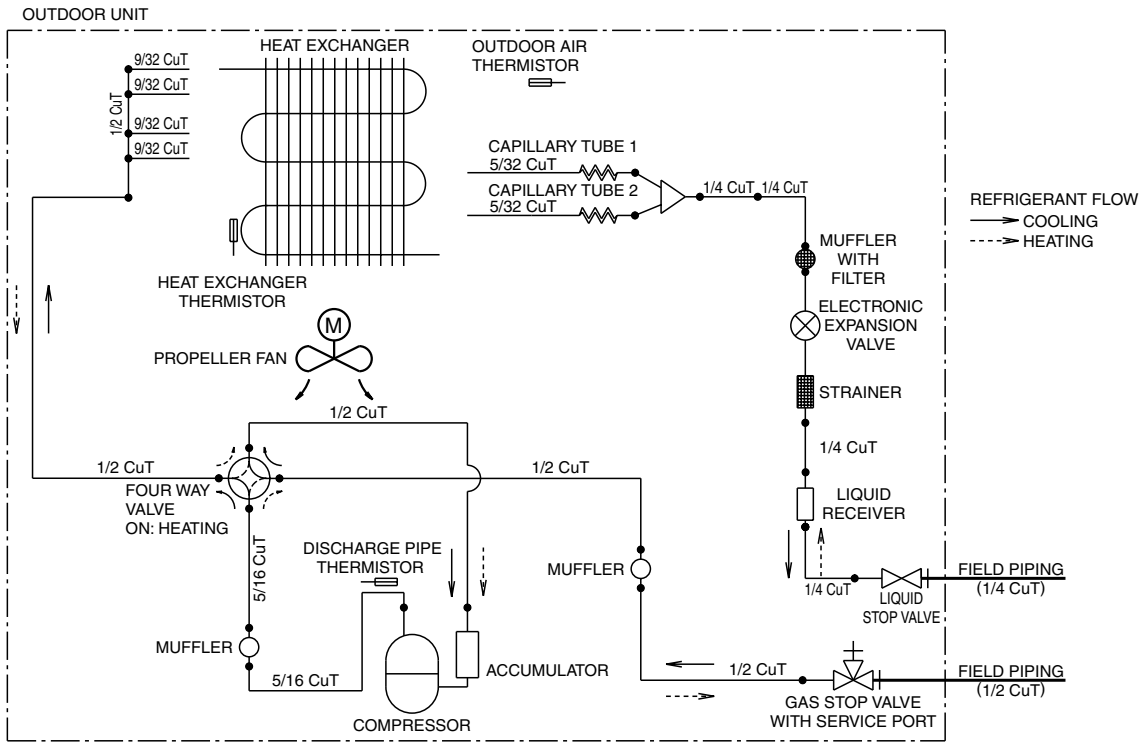

3D092220

RX24NMVJU

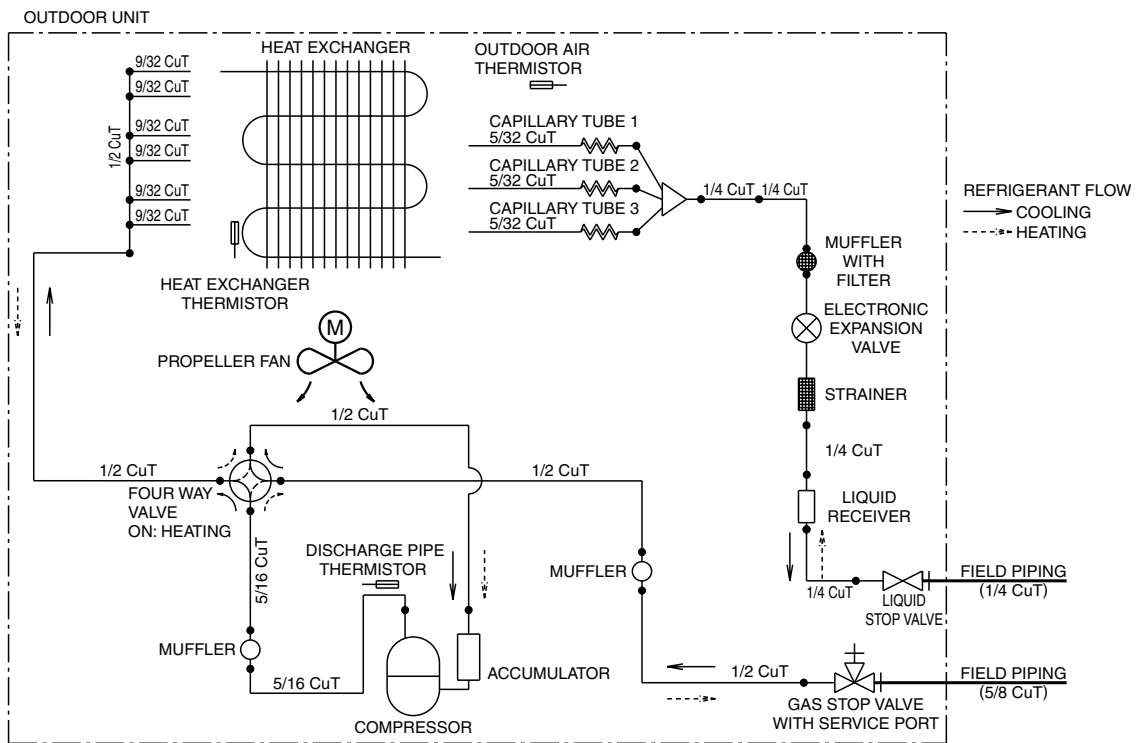

3D092249

7. Capacity Tables

7.1 Cooling Only

FTK09NMVJU + RK09NMVJU

AFR	11.8
BF	0.22

60 Hz, 208 V

Temp: Celsius
 TC, SHC, PI: kW

INDOOR		OUTDOOR TEMPERATURE (°CDB)																	
EWB	EDB	20			25			30			32			35			40		
°C	°C	TC	SHC	PI	TC	SHC	PI	TC	SHC	PI	TC	SHC	PI	TC	SHC	PI	TC	SHC	PI
14.0	20.0	2.70	2.27	0.55	2.58	2.21	0.61	2.46	2.15	0.66	2.41	2.13	0.68	2.34	2.10	0.71	2.21	2.04	0.77
16.0	22.0	2.83	2.23	0.56	2.70	2.18	0.61	2.58	2.12	0.66	2.53	2.10	0.68	2.46	2.07	0.72	2.33	2.02	0.77
18.0	25.0	2.95	2.37	0.56	2.83	2.32	0.61	2.70	2.27	0.67	2.65	2.25	0.69	2.58	2.22	0.72	2.46	2.18	0.77
19.4	26.7	3.01	2.54	0.56	2.89	2.49	0.61	2.76	2.44	0.67	2.71	2.42	0.69	2.64	2.39	0.72	2.52	2.35	0.77
22.0	30.0	3.19	2.46	0.57	3.07	2.42	0.62	2.95	2.37	0.67	2.90	2.36	0.69	2.82	2.33	0.73	2.70	2.29	0.78
24.0	32.0	3.31	2.41	0.57	3.19	2.37	0.62	3.07	2.33	0.68	3.02	2.31	0.70	2.94	2.29	0.73	2.82	2.25	0.78

Temp: Fahrenheit
 TC, SHC: kBtu/h
 PI: kW

INDOOR		OUTDOOR TEMPERATURE (°FDB)																	
EWB	EDB	68			77			86			90			95			104		
°F	°F	TC	SHC	PI	TC	SHC	PI	TC	SHC	PI	TC	SHC	PI	TC	SHC	PI	TC	SHC	PI
57.2	68.0	9.23	7.73	0.55	8.81	7.54	0.61	8.39	7.34	0.66	8.22	7.27	0.68	7.97	7.15	0.71	7.55	6.96	0.77
60.8	71.6	9.64	7.61	0.56	9.22	7.42	0.61	8.80	7.24	0.66	8.64	7.17	0.68	8.39	7.06	0.72	7.97	6.89	0.77
64.4	77.0	10.06	8.09	0.56	9.64	7.92	0.61	9.22	7.76	0.67	9.05	7.69	0.69	8.80	7.59	0.72	8.38	7.43	0.77
67.0	80.0	10.27	8.65	0.56	9.85	8.49	0.61	9.43	8.33	0.67	9.26	8.26	0.69	9.00	8.17	0.72	8.59	8.01	0.77
71.6	86.0	10.89	8.39	0.57	10.47	8.24	0.62	10.05	8.10	0.67	9.88	8.05	0.69	9.63	7.96	0.73	9.21	7.82	0.78
75.2	89.6	11.30	8.21	0.57	10.88	8.08	0.62	10.46	7.95	0.68	10.30	7.90	0.70	10.05	7.82	0.73	9.63	7.69	0.78

60 Hz, 230 V

Temp: Celsius
 TC, SHC, PI: kW

INDOOR		OUTDOOR TEMPERATURE (°CDB)																	
EWB	EDB	20			25			30			32			35			40		
°C	°C	TC	SHC	PI	TC	SHC	PI	TC	SHC	PI	TC	SHC	PI	TC	SHC	PI	TC	SHC	PI
14.0	20.0	2.70	2.27	0.55	2.58	2.21	0.61	2.46	2.15	0.66	2.41	2.13	0.68	2.34	2.10	0.71	2.21	2.04	0.77
16.0	22.0	2.83	2.23	0.56	2.70	2.18	0.61	2.58	2.12	0.66	2.53	2.10	0.68	2.46	2.07	0.72	2.33	2.02	0.77
18.0	25.0	2.95	2.37	0.56	2.83	2.32	0.61	2.70	2.27	0.67	2.65	2.25	0.69	2.58	2.22	0.72	2.46	2.18	0.77
19.4	26.7	3.01	2.54	0.56	2.89	2.49	0.61	2.76	2.44	0.67	2.71	2.42	0.69	2.64	2.39	0.72	2.52	2.35	0.77
22.0	30.0	3.19	2.46	0.57	3.07	2.42	0.62	2.95	2.37	0.67	2.90	2.36	0.69	2.82	2.33	0.73	2.70	2.29	0.78
24.0	32.0	3.31	2.41	0.57	3.19	2.37	0.62	3.07	2.33	0.68	3.02	2.31	0.70	2.94	2.29	0.73	2.82	2.25	0.78

Temp: Fahrenheit
 TC, SHC: kBtu/h
 PI: kW

INDOOR		OUTDOOR TEMPERATURE (°FDB)																	
EWB	EDB	68			77			86			90			95			104		
°F	°F	TC	SHC	PI	TC	SHC	PI	TC	SHC	PI	TC	SHC	PI	TC	SHC	PI	TC	SHC	PI
57.2	68.0	9.23	7.73	0.55	8.81	7.54	0.61	8.39	7.34	0.66	8.22	7.27	0.68	7.97	7.15	0.71	7.55	6.96	0.77
60.8	71.6	9.64	7.61	0.56	9.22	7.42	0.61	8.80	7.24	0.66	8.64	7.17	0.68	8.39	7.06	0.72	7.97	6.89	0.77
64.4	77.0	10.06	8.09	0.56	9.64	7.92	0.61	9.22	7.76	0.67	9.05	7.69	0.69	8.80	7.59	0.72	8.38	7.43	0.77
67.0	80.0	10.27	8.65	0.56	9.85	8.49	0.61	9.43	8.33	0.67	9.26	8.26	0.69	9.00	8.17	0.72	8.59	8.01	0.77
71.6	86.0	10.89	8.39	0.57	10.47	8.24	0.62	10.05	8.10	0.67	9.88	8.05	0.69	9.63	7.96	0.73	9.21	7.82	0.78
75.2	89.6	11.30	8.21	0.57	10.88	8.08	0.62	10.46	7.95	0.68	10.30	7.90	0.70	10.05	7.82	0.73	9.63	7.69	0.78

Symbols:

AFR	: Airflow rate	(m ³ /min.)
BF	: Bypass factor	
EWB	: Entering wet bulb temp.	(°C) / (°F)
EDB	: Entering dry bulb temp.	(°C) / (°F)
TC	: Total capacity	(kW) / (kBtu/h)
SHC	: Sensible heat capacity	(kW) / (kBtu/h)
PI	: Power input	(kW)

Notes:

1. ■ shows nominal (rated) capacities and power input.
2. TC, PI and SHC must be calculated by interpolation using the figures in the above tables. (Figures out of the tables should not be used for calculation.)
3. Capacities are based on the following conditions.
Corresponding refrigerant piping length : 25 ft (7.5 m)
Level difference : 0 ft (0 m)
4. Cooling capacity at -15°CDB and 5°FDB.

Temp: Celsius
TC, SHC, PI: kW
60 Hz, 208 - 230 V

INDOOR		OUTDOOR		
EWB	EDB	-15 (°CDB)		
°C	°C	TC	SHC	PI
14.0	20.0	2.90	2.18	0.37

Temp: Fahrenheit
TC, SHC: kBtu/h
PI: kW
60 Hz, 208 - 230 V

INDOOR		OUTDOOR		
EWB	EDB	5 (°FDB)		
°F	°F	TC	SHC	PI
57.2	68.0	9.90	7.45	0.37

3D093239

FTK12NMVJU + RK12NMVJU

AFR	12.3
BF	0.16

60 Hz, 208 V

Temp: Celsius
TC, SHC, PI: kW

INDOOR		OUTDOOR TEMPERATURE (°CDB)																	
EWB	EDB	20			25			30			32			35			40		
		°C	°C	TC	SHC	PI	TC	SHC	PI	TC	SHC	PI	TC	SHC	PI	TC	SHC	PI	
14.0	20.0	3.28	2.66	0.67	3.13	2.59	0.74	2.98	2.52	0.80	2.92	2.49	0.83	2.83	2.45	0.86	2.68	2.38	0.93
16.0	22.0	3.43	2.61	0.67	3.28	2.55	0.74	3.13	2.48	0.80	3.07	2.46	0.83	2.98	2.42	0.87	2.83	2.35	0.93
18.0	25.0	3.57	2.77	0.68	3.42	2.71	0.74	3.28	2.65	0.81	3.22	2.63	0.83	3.13	2.59	0.87	2.98	2.53	0.94
19.4	26.7	3.65	2.95	0.68	3.50	2.89	0.74	3.35	2.84	0.81	3.29	2.81	0.84	3.20	2.78	0.87	3.05	2.72	0.94
22.0	30.0	3.87	2.86	0.69	3.72	2.81	0.75	3.57	2.76	0.82	3.51	2.74	0.84	3.42	2.70	0.88	3.27	2.65	0.94
24.0	32.0	4.02	2.79	0.69	3.87	2.75	0.75	3.72	2.70	0.82	3.66	2.68	0.84	3.57	2.65	0.88	3.42	2.61	0.95

Temp: Fahrenheit
TC, SHC: kBtu/h
PI: kW

INDOOR		OUTDOOR TEMPERATURE (°FDB)																	
EWB	EDB	68			77			86			90			95			104		
		°F	°F	TC	SHC	PI	TC	SHC	PI	TC	SHC	PI	TC	SHC	PI	TC	SHC	PI	
57.2	68.0	11.19	9.07	0.67	10.68	8.83	0.74	10.17	8.59	0.80	9.97	8.50	0.83	9.66	8.36	0.86	9.15	8.12	0.93
60.8	71.6	11.69	8.92	0.67	11.18	8.69	0.74	10.67	8.47	0.80	10.47	8.38	0.83	10.16	8.25	0.87	9.66	8.03	0.93
64.4	77.0	12.19	9.46	0.68	11.68	9.25	0.74	11.18	9.04	0.81	10.97	8.96	0.83	10.67	8.83	0.87	10.16	8.63	0.94
67.0	80.0	12.44	10.07	0.68	11.94	9.87	0.74	11.43	9.67	0.81	11.22	9.59	0.84	10.90	9.48	0.87	10.41	9.28	0.94
71.6	86.0	13.20	9.75	0.69	12.69	9.58	0.75	12.18	9.40	0.82	11.98	9.33	0.84	11.67	9.23	0.88	11.16	9.06	0.94
75.2	89.6	13.70	9.53	0.69	13.19	9.37	0.75	12.68	9.21	0.82	12.48	9.15	0.84	12.18	9.05	0.88	11.67	8.90	0.95

60 Hz, 230 V

Temp: Celsius
TC, SHC, PI: kW

INDOOR		OUTDOOR TEMPERATURE (°CDB)																	
EWB	EDB	20			25			30			32			35			40		
		°C	°C	TC	SHC	PI	TC	SHC	PI	TC	SHC	PI	TC	SHC	PI	TC	SHC	PI	
14.0	20.0	3.28	2.66	0.67	3.13	2.59	0.74	2.98	2.52	0.80	2.92	2.49	0.83	2.83	2.45	0.86	2.68	2.38	0.93
16.0	22.0	3.43	2.61	0.67	3.28	2.55	0.74	3.13	2.48	0.80	3.07	2.46	0.83	2.98	2.42	0.87	2.83	2.35	0.93
18.0	25.0	3.57	2.77	0.68	3.42	2.71	0.74	3.28	2.65	0.81	3.22	2.63	0.83	3.13	2.59	0.87	2.98	2.53	0.94
19.4	26.7	3.65	2.95	0.68	3.50	2.89	0.74	3.35	2.84	0.81	3.29	2.81	0.84	3.20	2.78	0.87	3.05	2.72	0.94
22.0	30.0	3.87	2.86	0.69	3.72	2.81	0.75	3.57	2.76	0.82	3.51	2.74	0.84	3.42	2.70	0.88	3.27	2.65	0.94
24.0	32.0	4.02	2.79	0.69	3.87	2.75	0.75	3.72	2.70	0.82	3.66	2.68	0.84	3.57	2.65	0.88	3.42	2.61	0.95

Temp: Fahrenheit
TC, SHC: kBtu/h
PI: kW

INDOOR		OUTDOOR TEMPERATURE (°FDB)																	
EWB	EDB	68			77			86			90			95			104		
		°F	°F	TC	SHC	PI	TC	SHC	PI	TC	SHC	PI	TC	SHC	PI	TC	SHC	PI	
57.2	68.0	11.19	9.07	0.67	10.68	8.83	0.74	10.17	8.59	0.80	9.97	8.50	0.83	9.66	8.36	0.86	9.15	8.12	0.93
60.8	71.6	11.69	8.92	0.67	11.18	8.69	0.74	10.67	8.47	0.80	10.47	8.38	0.83	10.16	8.25	0.87	9.66	8.03	0.93
64.4	77.0	12.19	9.46	0.68	11.68	9.25	0.74	11.18	9.04	0.81	10.97	8.96	0.83	10.67	8.83	0.87	10.16	8.63	0.94
67.0	80.0	12.44	10.07	0.68	11.94	9.87	0.74	11.43	9.67	0.81	11.22	9.59	0.84	10.90	9.48	0.87	10.41	9.28	0.94
71.6	86.0	13.20	9.75	0.69	12.69	9.58	0.75	12.18	9.40	0.82	11.98	9.33	0.84	11.67	9.23	0.88	11.16	9.06	0.94
75.2	89.6	13.70	9.53	0.69	13.19	9.37	0.75	12.68	9.21	0.82	12.48	9.15	0.84	12.18	9.05	0.88	11.67	8.90	0.95

Symbols:

AFR	: Airflow rate	(m ³ /min.)
BF	: Bypass factor	
EWB	: Entering wet bulb temp.	(°C) / (°F)
EDB	: Entering dry bulb temp.	(°C) / (°F)
TC	: Total capacity	(kW) / (kBtu/h)
SHC	: Sensible heat capacity	(kW) / (kBtu/h)
PI	: Power input	(kW)

Notes:

1. ■ shows nominal (rated) capacities and power input.
2. TC, PI and SHC must be calculated by interpolation using the figures in the above tables. (Figures out of the tables should not be used for calculation.)
3. Capacities are based on the following conditions.
Corresponding refrigerant piping length : 25 ft (7.5 m)
Level difference : 0 ft (0 m)
4. Cooling capacity at -15°CDB and 5°FDB.

Temp: Celsius
TC, SHC, PI: kW
60 Hz, 208 - 230 V

INDOOR		OUTDOOR		
EWB	EDB	-15 (°CDB)		
°C	°C	TC	SHC	PI
14.0	20.0	3.42	2.53	0.52

Temp: Fahrenheit
TC, SHC: kBtu/h
PI: kW
60 Hz, 208 - 230 V

INDOOR		OUTDOOR		
EWB	EDB	5 (°FDB)		
°F	°F	TC	SHC	PI
57.2	68.0	11.66	8.61	0.52

3D093240

FTK18NMVJU + RK18NMVJU

AFR	20.2
BF	0.27

60 Hz, 208 V

Temp: Celsius
TC, SHC, PI: kW

INDOOR		OUTDOOR TEMPERATURE (°CDB)																	
EWB	EDB	20			25			30			32			35			40		
		°C	°C	TC	SHC	PI	TC	SHC	PI	TC	SHC	PI	TC	SHC	PI	TC	SHC	PI	
14.0	20.0	5.41	4.15	1.11	5.16	4.03	1.21	4.92	3.91	1.32	4.82	3.86	1.36	4.67	3.79	1.43	4.43	3.67	1.53
16.0	22.0	5.65	4.08	1.11	5.41	3.96	1.22	5.16	3.85	1.32	5.06	3.81	1.37	4.92	3.74	1.43	4.67	3.63	1.54
18.0	25.0	5.90	4.29	1.12	5.65	4.19	1.22	5.40	4.08	1.33	5.31	4.04	1.37	5.16	3.98	1.44	4.91	3.88	1.54
19.4	26.7	6.02	4.54	1.12	5.77	4.44	1.23	5.53	4.34	1.33	5.43	4.30	1.38	5.28	4.24	1.44	5.03	4.15	1.55
22.0	30.0	6.38	4.39	1.13	6.14	4.30	1.24	5.89	4.21	1.34	5.79	4.18	1.39	5.64	4.12	1.45	5.40	4.04	1.56
24.0	32.0	6.63	4.28	1.14	6.38	4.20	1.24	6.13	4.12	1.35	6.04	4.09	1.39	5.89	4.04	1.46	5.64	3.96	1.56

Temp: Fahrenheit
TC, SHC: kBtu/h
PI: kW

INDOOR		OUTDOOR TEMPERATURE (°FDB)																	
EWB	EDB	68			77			86			90			95			104		
		°F	°F	TC	SHC	PI	TC	SHC	PI	TC	SHC	PI	TC	SHC	PI	TC	SHC	PI	
57.2	68.0	18.46	14.15	1.11	17.62	13.74	1.21	16.78	13.34	1.32	16.44	13.17	1.36	15.94	12.93	1.43	15.10	12.54	1.53
60.8	71.6	19.29	13.91	1.11	18.45	13.52	1.22	17.61	13.14	1.32	17.27	12.99	1.37	16.77	12.77	1.43	15.93	12.40	1.54
64.4	77.0	20.12	14.64	1.12	19.28	14.28	1.22	18.44	13.93	1.33	18.10	13.79	1.37	17.60	13.58	1.44	16.76	13.23	1.54
67.0	80.0	20.53	15.50	1.12	19.69	15.16	1.23	18.85	14.82	1.33	18.52	14.68	1.38	18.00	14.48	1.44	17.18	14.15	1.55
71.6	86.0	21.78	14.97	1.13	20.94	14.67	1.24	20.10	14.37	1.34	19.76	14.25	1.39	19.26	14.07	1.45	18.42	13.78	1.56
75.2	89.6	22.61	14.60	1.14	21.77	14.32	1.24	20.93	14.05	1.35	20.59	13.94	1.39	20.09	13.78	1.46	19.25	13.51	1.56

60 Hz, 230 V

Temp: Celsius
TC, SHC, PI: kW

INDOOR		OUTDOOR TEMPERATURE (°CDB)																	
EWB	EDB	20			25			30			32			35			40		
		°C	°C	TC	SHC	PI	TC	SHC	PI	TC	SHC	PI	TC	SHC	PI	TC	SHC	PI	
14.0	20.0	5.41	4.15	1.11	5.16	4.03	1.21	4.92	3.91	1.32	4.82	3.86	1.36	4.67	3.79	1.43	4.43	3.67	1.53
16.0	22.0	5.65	4.08	1.11	5.41	3.96	1.22	5.16	3.85	1.32	5.06	3.81	1.37	4.92	3.74	1.43	4.67	3.63	1.54
18.0	25.0	5.90	4.29	1.12	5.65	4.19	1.22	5.40	4.08	1.33	5.31	4.04	1.37	5.16	3.98	1.44	4.91	3.88	1.54
19.4	26.7	6.02	4.54	1.12	5.77	4.44	1.23	5.53	4.34	1.33	5.43	4.30	1.38	5.28	4.24	1.44	5.03	4.15	1.55
22.0	30.0	6.38	4.39	1.13	6.14	4.30	1.24	5.89	4.21	1.34	5.79	4.18	1.39	5.64	4.12	1.45	5.40	4.04	1.56
24.0	32.0	6.63	4.28	1.14	6.38	4.20	1.24	6.13	4.12	1.35	6.04	4.09	1.39	5.89	4.04	1.46	5.64	3.96	1.56

Temp: Fahrenheit
TC, SHC: kBtu/h
PI: kW

INDOOR		OUTDOOR TEMPERATURE (°FDB)																	
EWB	EDB	68			77			86			90			95			104		
		°F	°F	TC	SHC	PI	TC	SHC	PI	TC	SHC	PI	TC	SHC	PI	TC	SHC	PI	
57.2	68.0	18.46	14.15	1.11	17.62	13.74	1.21	16.78	13.34	1.32	16.44	13.17	1.36	15.94	12.93	1.43	15.10	12.54	1.53
60.8	71.6	19.29	13.91	1.11	18.45	13.52	1.22	17.61	13.14	1.32	17.27	12.99	1.37	16.77	12.77	1.43	15.93	12.40	1.54
64.4	77.0	20.12	14.64	1.12	19.28	14.28	1.22	18.44	13.93	1.33	18.10	13.79	1.37	17.60	13.58	1.44	16.76	13.23	1.54
67.0	80.0	20.53	15.50	1.12	19.69	15.16	1.23	18.85	14.82	1.33	18.52	14.68	1.38	18.00	14.48	1.44	17.18	14.15	1.55
71.6	86.0	21.78	14.97	1.13	20.94	14.67	1.24	20.10	14.37	1.34	19.76	14.25	1.39	19.26	14.07	1.45	18.42	13.78	1.56
75.2	89.6	22.61	14.60	1.14	21.77	14.32	1.24	20.93	14.05	1.35	20.59	13.94	1.39	20.09	13.78	1.46	19.25	13.51	1.56

Symbols:

AFR	: Airflow rate	(m ³ /min.)
BF	: Bypass factor	
EWB	: Entering wet bulb temp.	(°C) / (°F)
EDB	: Entering dry bulb temp.	(°C) / (°F)
TC	: Total capacity	(kW) / (kBtu/h)
SHC	: Sensible heat capacity	(kW) / (kBtu/h)
PI	: Power input	(kW)

Notes:

1. ■ shows nominal (rated) capacities and power input.
2. TC, PI and SHC must be calculated by interpolation using the figures in the above tables. (Figures out of the tables should not be used for calculation.)
3. Capacities are based on the following conditions.
Corresponding refrigerant piping length : 25 ft (7.5 m)
Level difference : 0 ft (0 m)
4. Cooling capacity at -15°CDB and 5°FDB.

Temp: Celsius
TC, SHC, PI: kW
60 Hz, 208 - 230 V

INDOOR		OUTDOOR		
EWB	EDB	-15 (°CDB)		
°C	°C	TC	SHC	PI
14.0	20.0	5.44	4.02	0.71

Temp: Fahrenheit
TC, SHC: kBtu/h
PI: kW
60 Hz, 208 - 230 V

INDOOR		OUTDOOR		
EWB	EDB	5 (°FDB)		
°F	°F	TC	SHC	PI
57.2	68.0	18.54	13.69	0.71

3D093241

FTK24NMVJU + RK24NMVJU

AFR	20.2
BF	0.27

60 Hz, 208 V

Temp: Celsius

TC, SHC, PI: kW

INDOOR		OUTDOOR TEMPERATURE (°CDB)																	
EWB	EDB	20			25			30			32			35			40		
°C	°C	TC	SHC	PI	TC	SHC	PI	TC	SHC	PI	TC	SHC	PI	TC	SHC	PI	TC	SHC	PI
14.0	20.0	6.05	4.47	1.29	6.05	4.47	1.43	5.77	4.33	1.55	5.66	4.27	1.60	5.49	4.19	1.68	5.20	4.04	1.71
16.0	22.0	6.64	4.54	1.31	6.35	4.40	1.43	6.06	4.27	1.56	5.94	4.21	1.61	5.77	4.13	1.68	5.48	4.00	1.72
18.0	25.0	6.92	4.74	1.32	6.63	4.61	1.44	6.35	4.49	1.57	6.23	4.43	1.62	6.06	4.36	1.69	5.77	4.24	1.73
19.4	26.7	7.07	4.99	1.32	6.78	4.86	1.45	6.49	4.74	1.57	6.37	4.69	1.62	6.20	4.62	1.70	5.91	4.50	1.73
22.0	30.0	7.49	4.80	1.33	7.21	4.69	1.46	6.92	4.59	1.58	6.80	4.54	1.63	6.63	4.48	1.71	6.34	4.37	1.74
24.0	32.0	7.78	4.67	1.34	7.49	4.57	1.46	7.20	4.47	1.59	7.09	4.43	1.64	6.91	4.38	1.71	6.63	4.28	1.75

Temp: Fahrenheit

TC, SHC: kBtu/h

PI: kW

INDOOR		OUTDOOR TEMPERATURE (°FDB)																	
EWB	EDB	68			77			86			90			95			104		
°F	°F	TC	SHC	PI	TC	SHC	PI	TC	SHC	PI	TC	SHC	PI	TC	SHC	PI	TC	SHC	PI
57.2	68.0	20.65	15.25	1.29	20.65	15.25	1.43	19.70	14.77	1.55	19.31	14.57	1.60	18.72	14.28	1.68	17.73	13.80	1.71
60.8	71.6	22.65	15.49	1.31	21.66	15.02	1.43	20.68	14.55	1.56	20.28	14.37	1.61	19.69	14.09	1.68	18.71	13.64	1.72
64.4	77.0	23.62	16.18	1.32	22.64	15.74	1.44	21.65	15.30	1.57	21.26	15.13	1.62	20.67	14.87	1.69	19.68	14.45	1.73
67.0	80.0	24.11	17.01	1.32	23.12	16.59	1.45	22.14	16.17	1.57	21.75	16.01	1.62	21.20	15.76	1.70	20.17	15.35	1.73
71.6	86.0	25.57	16.39	1.33	24.59	16.01	1.46	23.60	15.64	1.58	23.21	15.50	1.63	22.62	15.28	1.71	21.63	14.92	1.74
75.2	89.6	26.55	15.94	1.34	25.56	15.60	1.46	24.58	15.26	1.59	24.18	15.13	1.64	23.59	14.93	1.71	22.61	14.60	1.75

60 Hz, 230 V

Temp: Celsius

TC, SHC, PI: kW

INDOOR		OUTDOOR TEMPERATURE (°CDB)																	
EWB	EDB	20			25			30			32			35			40		
°C	°C	TC	SHC	PI	TC	SHC	PI	TC	SHC	PI	TC	SHC	PI	TC	SHC	PI	TC	SHC	PI
14.0	20.0	6.05	4.47	1.29	6.05	4.47	1.43	5.77	4.33	1.55	5.66	4.27	1.60	5.49	4.19	1.68	5.20	4.04	1.71
16.0	22.0	6.64	4.54	1.31	6.35	4.40	1.43	6.06	4.27	1.56	5.94	4.21	1.61	5.77	4.13	1.68	5.48	4.00	1.72
18.0	25.0	6.92	4.74	1.32	6.63	4.61	1.44	6.35	4.49	1.57	6.23	4.43	1.62	6.06	4.36	1.69	5.77	4.24	1.73
19.4	26.7	7.07	4.99	1.32	6.78	4.86	1.45	6.49	4.74	1.57	6.37	4.69	1.62	6.20	4.62	1.70	5.91	4.50	1.73
22.0	30.0	7.49	4.80	1.33	7.21	4.69	1.46	6.92	4.59	1.58	6.80	4.54	1.63	6.63	4.48	1.71	6.34	4.37	1.74
24.0	32.0	7.78	4.67	1.34	7.49	4.57	1.46	7.20	4.47	1.59	7.09	4.43	1.64	6.91	4.38	1.71	6.63	4.28	1.75

Temp: Fahrenheit

TC, SHC: kBtu/h

PI: kW

INDOOR		OUTDOOR TEMPERATURE (°FDB)																	
EWB	EDB	68			77			86			90			95			104		
°F	°F	TC	SHC	PI	TC	SHC	PI	TC	SHC	PI	TC	SHC	PI	TC	SHC	PI	TC	SHC	PI
57.2	68.0	20.65	15.25	1.29	20.65	15.25	1.43	19.70	14.77	1.55	19.31	14.57	1.60	18.72	14.28	1.68	17.73	13.80	1.71
60.8	71.6	22.65	15.49	1.31	21.66	15.02	1.43	20.68	14.55	1.56	20.28	14.37	1.61	19.69	14.09	1.68	18.71	13.64	1.72
64.4	77.0	23.62	16.18	1.32	22.64	15.74	1.44	21.65	15.30	1.57	21.26	15.13	1.62	20.67	14.87	1.69	19.68	14.45	1.73
67.0	80.0	24.11	17.01	1.32	23.12	16.59	1.45	22.14	16.17	1.57	21.75	16.01	1.62	21.20	15.76	1.70	20.17	15.35	1.73
71.6	86.0	25.57	16.39	1.33	24.59	16.01	1.46	23.60	15.64	1.58	23.21	15.50	1.63	22.62	15.28	1.71	21.63	14.92	1.74
75.2	89.6	26.55	15.94	1.34	25.56	15.60	1.46	24.58	15.26	1.59	24.18	15.13	1.64	23.59	14.93	1.71	22.61	14.60	1.75

Symbols:

AFR	: Airflow rate	(m ³ /min.)
BF	: Bypass factor	
EWB	: Entering wet bulb temp.	(°C) / (°F)
EDB	: Entering dry bulb temp.	(°C) / (°F)
TC	: Total capacity	(kW) / (kBtu/h)
SHC	: Sensible heat capacity	(kW) / (kBtu/h)
PI	: Power input	(kW)

Notes:

1. ■ shows nominal (rated) capacities and power input.
2. TC, PI and SHC must be calculated by interpolation using the figures in the above tables. (Figures out of the tables should not be used for calculation.)
3. Capacities are based on the following conditions.
Corresponding refrigerant piping length : 25 ft (7.5 m)
Level difference : 0 ft (0 m)
4. Cooling capacity at -15°CDB and 5°FDB.

Temp: Celsius
TC, SHC, PI: kW
60 Hz, 208 - 230 V

INDOOR		OUTDOOR		
EWB	EDB	-15 (°CDB)		
°C	°C	TC	SHC	PI
14.0	20.0	5.95	4.39	0.56

Temp: Fahrenheit
TC, SHC: kBtu/h
PI: kW
60 Hz, 208 - 230 V

INDOOR		OUTDOOR		
EWB	EDB	5 (°FDB)		
°F	°F	TC	SHC	PI
57.2	68.0	20.35	15.03	0.56

3D093242

7.2 Heat Pump

FTX09NMVJU + RX09NMVJU

60 Hz, 208 V

Cooling

AFR	11.8
BF	0.22

Temp: Celsius
TC, SHC, PI: kW

INDOOR		OUTDOOR TEMPERATURE (°CDB)																	
EWB	EDB	20			25			30			32			35			40		
°C	°C	TC	SHC	PI	TC	SHC	PI	TC	SHC	PI	TC	SHC	PI	TC	SHC	PI	TC	SHC	PI
14.0	20.0	2.70	2.27	0.55	2.58	2.21	0.61	2.46	2.15	0.66	2.41	2.13	0.68	2.34	2.10	0.71	2.21	2.04	0.77
16.0	22.0	2.83	2.23	0.56	2.70	2.18	0.61	2.58	2.12	0.66	2.53	2.10	0.68	2.46	2.07	0.72	2.33	2.02	0.77
18.0	25.0	2.95	2.37	0.56	2.83	2.32	0.61	2.70	2.27	0.67	2.65	2.25	0.69	2.58	2.22	0.72	2.46	2.18	0.77
19.4	26.7	3.01	2.54	0.56	2.89	2.49	0.61	2.76	2.44	0.67	2.71	2.42	0.69	2.64	2.39	0.72	2.52	2.35	0.77
22.0	30.0	3.19	2.46	0.57	3.07	2.42	0.62	2.95	2.37	0.67	2.90	2.36	0.69	2.82	2.33	0.73	2.70	2.29	0.78
24.0	32.0	3.31	2.41	0.57	3.19	2.37	0.62	3.07	2.33	0.68	3.02	2.31	0.70	2.94	2.29	0.73	2.82	2.25	0.78

Temp: Fahrenheit
TC, SHC: kBtu/h
PI: kW

INDOOR		OUTDOOR TEMPERATURE (°FDB)																	
EWB	EDB	68			77			86			90			95			104		
°F	°F	TC	SHC	PI	TC	SHC	PI	TC	SHC	PI	TC	SHC	PI	TC	SHC	PI	TC	SHC	PI
57.2	68.0	9.23	7.73	0.55	8.81	7.54	0.61	8.39	7.34	0.66	8.22	7.27	0.68	7.97	7.15	0.71	7.55	6.96	0.77
60.8	71.6	9.64	7.61	0.56	9.22	7.42	0.61	8.80	7.24	0.66	8.64	7.17	0.68	8.39	7.06	0.72	7.97	6.89	0.77
64.4	77.0	10.06	8.09	0.56	9.64	7.92	0.61	9.22	7.76	0.67	9.05	7.69	0.69	8.80	7.59	0.72	8.38	7.43	0.77
67.0	80.0	10.27	8.65	0.56	9.85	8.49	0.61	9.43	8.33	0.67	9.26	8.26	0.69	9.00	8.17	0.72	8.59	8.01	0.77
71.6	86.0	10.89	8.39	0.57	10.47	8.24	0.62	10.05	8.10	0.67	9.88	8.05	0.69	9.63	7.96	0.73	9.21	7.82	0.78
75.2	89.6	11.30	8.21	0.57	10.88	8.08	0.62	10.46	7.95	0.68	10.30	7.90	0.70	10.05	7.82	0.73	9.63	7.69	0.78

Heating

AFR	11.4
-----	------

Temp: Celsius
TC, PI: kW

INDOOR		OUTDOOR TEMPERATURE (°CWB)											
EDB		-15		-10		-5		0		6		10	
°C		TC	PI	TC	PI	TC	PI	TC	PI	TC	PI	TC	PI
15.0		1.40	0.46	1.68	0.49	1.96	0.51	2.63	0.67	3.03	0.71	3.30	0.73
21.1		1.31	0.48	1.59	0.50	1.87	0.53	2.53	0.69	2.93	0.72	3.19	0.75
22.0		1.27	0.48	1.56	0.51	1.84	0.53	2.49	0.69	2.89	0.73	3.15	0.75
24.0		1.24	0.49	1.52	0.51	1.80	0.54	2.45	0.70	2.85	0.74	3.11	0.76
25.0		1.22	0.49	1.50	0.51	1.79	0.54	2.43	0.70	2.83	0.74	3.09	0.76
27.0		1.19	0.50	1.47	0.52	1.75	0.54	2.39	0.71	2.79	0.74	3.05	0.77

Temp: Fahrenheit
TC: kBtu/h
PI: kW

INDOOR		OUTDOOR TEMPERATURE (°FWB)											
EDB		5		14		23		32		43		50	
°F		TC	PI	TC	PI	TC	PI	TC	PI	TC	PI	TC	PI
59.0		4.76	0.46	5.72	0.49	6.68	0.51	8.99	0.67	10.34	0.71	11.25	0.73
70.0		4.47	0.48	5.43	0.50	6.39	0.53	8.64	0.69	10.00	0.72	10.90	0.75
71.6		4.35	0.48	5.31	0.51	6.27	0.53	8.50	0.69	9.86	0.73	10.76	0.75
75.2		4.23	0.49	5.19	0.51	6.15	0.54	8.37	0.70	9.72	0.74	10.62	0.76
77.0		4.17	0.49	5.13	0.51	6.09	0.54	8.30	0.70	9.65	0.74	10.56	0.76
80.6		4.06	0.50	5.02	0.52	5.98	0.54	8.16	0.71	9.51	0.74	10.42	0.77

60 Hz, 230 V

Cooling

AFR	11.8
BF	0.22

Temp: Celsius
TC, SHC, PI: kW

INDOOR		OUTDOOR TEMPERATURE (°CDB)																	
EWB	EDB	20			25			30			32			35			40		
°C	°C	TC	SHC	PI	TC	SHC	PI	TC	SHC	PI	TC	SHC	PI	TC	SHC	PI	TC	SHC	PI
14.0	20.0	2.70	2.27	0.55	2.58	2.21	0.61	2.46	2.15	0.66	2.41	2.13	0.68	2.34	2.10	0.71	2.21	2.04	0.77
16.0	22.0	2.83	2.23	0.56	2.70	2.18	0.61	2.58	2.12	0.66	2.53	2.10	0.68	2.46	2.07	0.72	2.33	2.02	0.77
18.0	25.0	2.95	2.37	0.56	2.83	2.32	0.61	2.70	2.27	0.67	2.65	2.25	0.69	2.58	2.22	0.72	2.46	2.18	0.77
19.4	26.7	3.01	2.54	0.56	2.89	2.49	0.61	2.76	2.44	0.67	2.71	2.42	0.69	2.64	2.39	0.72	2.52	2.35	0.77
22.0	30.0	3.19	2.46	0.57	3.07	2.42	0.62	2.95	2.37	0.67	2.90	2.36	0.69	2.82	2.33	0.73	2.70	2.29	0.78
24.0	32.0	3.31	2.41	0.57	3.19	2.37	0.62	3.07	2.33	0.68	3.02	2.31	0.70	2.94	2.29	0.73	2.82	2.25	0.78

Temp: Fahrenheit
TC, SHC: kBtu/h
PI: kW

INDOOR		OUTDOOR TEMPERATURE (°FDB)																	
EWB	EDB	68			77			86			90			95			104		
°F	°F	TC	SHC	PI	TC	SHC	PI	TC	SHC	PI	TC	SHC	PI	TC	SHC	PI	TC	SHC	PI
57.2	68.0	9.23	7.73	0.55	8.81	7.54	0.61	8.39	7.34	0.66	8.22	7.27	0.68	7.97	7.15	0.71	7.55	6.96	0.77
60.8	71.6	9.64	7.61	0.56	9.22	7.42	0.61	8.80	7.24	0.66	8.64	7.17	0.68	8.39	7.06	0.72	7.97	6.89	0.77
64.4	77.0	10.06	8.09	0.56	9.64	7.92	0.61	9.22	7.76	0.67	9.05	7.69	0.69	8.80	7.59	0.72	8.38	7.43	0.77
67.0	80.0	10.27	8.65	0.56	9.85	8.49	0.61	9.43	8.33	0.67	9.26	8.26	0.69	9.00	8.17	0.72	8.59	8.01	0.77
71.6	86.0	10.89	8.39	0.57	10.47	8.24	0.62	10.05	8.10	0.67	9.88	8.05	0.69	9.63	7.96	0.73	9.21	7.82	0.78
75.2	89.6	11.30	8.21	0.57	10.88	8.08	0.62	10.46	7.95	0.68	10.30	7.90	0.70	10.05	7.82	0.73	9.63	7.69	0.78

Heating

AFR	11.4
-----	------

Temp: Celsius
TC, PI: kW

INDOOR		OUTDOOR TEMPERATURE (°CWB)											
EDB		-15		-10		-5		0		6		10	
°C		TC	PI	TC	PI	TC	PI	TC	PI	TC	PI	TC	PI
15.0		1.40	0.46	1.68	0.49	1.96	0.51	2.63	0.67	3.03	0.71	3.30	0.73
21.1		1.31	0.48	1.59	0.50	1.87	0.53	2.53	0.69	2.93	0.72	3.19	0.75
22.0		1.27	0.48	1.56	0.51	1.84	0.53	2.49	0.69	2.89	0.73	3.15	0.75
24.0		1.24	0.49	1.52	0.51	1.80	0.54	2.45	0.70	2.85	0.74	3.11	0.76
25.0		1.22	0.49	1.50	0.51	1.79	0.54	2.43	0.70	2.83	0.74	3.09	0.76
27.0		1.19	0.50	1.47	0.52	1.75	0.54	2.39	0.71	2.79	0.74	3.05	0.77

Temp: Fahrenheit
TC: kBtu/h
PI: kW

INDOOR		OUTDOOR TEMPERATURE (°FWB)											
EDB		5		14		23		32		43		50	
°F		TC	PI	TC	PI	TC	PI	TC	PI	TC	PI	TC	PI
59.0		4.76	0.46	5.72	0.49	6.68	0.51	8.99	0.67	10.34	0.71	11.25	0.73
70.0		4.47	0.48	5.43	0.50	6.39	0.53	8.64	0.69	10.00	0.72	10.90	0.75
71.6		4.35	0.48	5.31	0.51	6.27	0.53	8.50	0.69	9.86	0.73	10.76	0.75
75.2		4.23	0.49	5.19	0.51	6.15	0.54	8.37	0.70	9.72	0.74	10.62	0.76
77.0		4.17	0.49	5.13	0.51	6.09	0.54	8.30	0.70	9.65	0.74	10.56	0.76
80.6		4.06	0.50	5.02	0.52	5.98	0.54	8.16	0.71	9.51	0.74	10.42	0.77

Symbols:

- AFR : Airflow rate (m³/min.)
- BF : Bypass factor
- EWB : Entering wet bulb temp. (°C) / (°F)
- EDB : Entering dry bulb temp. (°C) / (°F)
- TC : Total capacity (kW) / (kBtu/h)
- SHC : Sensible heat capacity (kW) / (kBtu/h)
- PI : Power input (kW)

Notes:

1. ■ shows nominal (rated) capacities and power input.
2. TC, PI and SHC must be calculated by interpolation using the figures in the above tables. (Figures out of the tables should not be used for calculation.)
3. Capacities are based on the following conditions.
Corresponding refrigerant piping length : 25 ft (7.5 m)
Level difference : 0 ft (0 m)
4. Cooling capacity at -15°CDB and 5°FDB.

Temp: Celsius
TC, SHC, PI: kW
60 Hz, 208 - 230 V

INDOOR		OUTDOOR		
EWB	EDB	-15 (°CDB)		
°C	°C	TC	SHC	PI
14.0	20.0	2.90	2.18	0.37

Temp: Fahrenheit
TC, SHC: kBtu/h
PI: kW
60 Hz, 208 - 230 V

INDOOR		OUTDOOR		
EWB	EDB	5 (°FDB)		
°F	°F	TC	SHC	PI
57.2	68.0	9.90	7.45	0.37

3D093235

FTX12NMVJU + RX12NMVJU

60 Hz, 208 V

Cooling

AFR	12.3
BF	0.16

Temp: Celsius

TC, SHC, PI: kW

INDOOR		OUTDOOR TEMPERATURE (°CDB)																	
EWB	EDB	20			25			30			32			35			40		
°C	°C	TC	SHC	PI	TC	SHC	PI	TC	SHC	PI	TC	SHC	PI	TC	SHC	PI	TC	SHC	PI
14.0	20.0	3.28	2.66	0.67	3.13	2.59	0.74	2.98	2.52	0.80	2.92	2.49	0.83	2.83	2.45	0.86	2.68	2.38	0.93
16.0	22.0	3.43	2.61	0.67	3.28	2.55	0.74	3.13	2.48	0.80	3.07	2.46	0.83	2.98	2.42	0.87	2.83	2.35	0.93
18.0	25.0	3.57	2.77	0.68	3.42	2.71	0.74	3.28	2.65	0.81	3.22	2.63	0.83	3.13	2.59	0.87	2.98	2.53	0.94
19.4	26.7	3.65	2.95	0.68	3.50	2.89	0.74	3.35	2.84	0.81	3.29	2.81	0.84	3.20	2.78	0.87	3.05	2.72	0.94
22.0	30.0	3.87	2.86	0.69	3.72	2.81	0.75	3.57	2.76	0.82	3.51	2.74	0.84	3.42	2.70	0.88	3.27	2.65	0.94
24.0	32.0	4.02	2.79	0.69	3.87	2.75	0.75	3.72	2.70	0.82	3.66	2.68	0.84	3.57	2.65	0.88	3.42	2.61	0.95

Temp: Fahrenheit

TC, SHC: kBtu/h

PI: kW

INDOOR		OUTDOOR TEMPERATURE (°FDB)																	
EWB	EDB	68			77			86			90			95			104		
°F	°F	TC	SHC	PI	TC	SHC	PI	TC	SHC	PI	TC	SHC	PI	TC	SHC	PI	TC	SHC	PI
57.2	68.0	11.19	9.07	0.67	10.68	8.83	0.74	10.17	8.59	0.80	9.97	8.50	0.83	9.66	8.36	0.86	9.15	8.12	0.93
60.8	71.6	11.69	8.92	0.67	11.18	8.69	0.74	10.67	8.47	0.80	10.47	8.38	0.83	10.16	8.25	0.87	9.66	8.03	0.93
64.4	77.0	12.19	9.46	0.68	11.68	9.25	0.74	11.18	9.04	0.81	10.97	8.96	0.83	10.67	8.83	0.87	10.16	8.63	0.94
67.0	80.0	12.44	10.07	0.68	11.94	9.87	0.74	11.43	9.67	0.81	11.22	9.59	0.84	10.90	9.48	0.87	10.41	9.28	0.94
71.6	86.0	13.20	9.75	0.69	12.69	9.58	0.75	12.18	9.40	0.82	11.98	9.33	0.84	11.67	9.23	0.88	11.16	9.06	0.94
75.2	89.6	13.70	9.53	0.69	13.19	9.37	0.75	12.68	9.21	0.82	12.48	9.15	0.84	12.18	9.05	0.88	11.67	8.90	0.95

Heating

AFR	11.7
-----	------

Temp: Celsius

TC, PI: kW

INDOOR		OUTDOOR TEMPERATURE (°CWB)											
EDB		-15		-10		-5		0		6		10	
°C		TC	PI	TC	PI	TC	PI	TC	PI	TC	PI	TC	PI
15.0		1.89	0.67	2.27	0.70	2.65	0.74	3.56	0.97	4.10	1.02	4.45	1.05
21.1		1.77	0.69	2.15	0.72	2.53	0.76	3.42	0.99	3.96	1.04	4.32	1.08
22.0		1.72	0.70	2.10	0.73	2.48	0.76	3.37	1.00	3.91	1.05	4.26	1.08
24.0		1.68	0.70	2.06	0.74	2.44	0.77	3.31	1.01	3.85	1.06	4.21	1.09
25.0		1.65	0.71	2.03	0.74	2.41	0.78	3.29	1.01	3.82	1.06	4.18	1.10
27.0		1.61	0.72	1.99	0.75	2.37	0.78	3.23	1.02	3.77	1.07	4.13	1.11

Temp: Fahrenheit

TC: kBtu/h

PI: kW

INDOOR		OUTDOOR TEMPERATURE (°FWB)											
EDB		5		14		23		32		43		50	
°F		TC	PI	TC	PI	TC	PI	TC	PI	TC	PI	TC	PI
59.0		6.43	0.67	7.73	0.70	9.03	0.74	12.15	0.97	13.98	1.02	15.20	1.05
70.0		6.04	0.69	7.33	0.72	8.63	0.76	11.68	0.99	13.50	1.04	14.73	1.08
71.6		5.88	0.70	7.18	0.73	8.47	0.76	11.49	1.00	13.32	1.05	14.55	1.08
75.2		5.72	0.70	7.02	0.74	8.31	0.77	11.31	1.01	13.14	1.06	14.36	1.09
77.0		5.64	0.71	6.94	0.74	8.24	0.78	11.21	1.01	13.05	1.06	14.27	1.10
80.6		5.48	0.72	6.78	0.75	8.08	0.78	11.03	1.02	12.86	1.07	14.08	1.11

60 Hz, 230 V

Cooling

AFR	12.3
BF	0.16

Temp: Celsius
TC, SHC, PI: kW

INDOOR		OUTDOOR TEMPERATURE (°CDB)																	
EWB	EDB	20			25			30			32			35			40		
		TC	SHC	PI	TC	SHC	PI	TC	SHC	PI	TC	SHC	PI	TC	SHC	PI	TC	SHC	PI
14.0	20.0	3.28	2.66	0.67	3.13	2.59	0.74	2.98	2.52	0.80	2.92	2.49	0.83	2.83	2.45	0.86	2.68	2.38	0.93
16.0	22.0	3.43	2.61	0.67	3.28	2.55	0.74	3.13	2.48	0.80	3.07	2.46	0.83	2.98	2.42	0.87	2.83	2.35	0.93
18.0	25.0	3.57	2.77	0.68	3.42	2.71	0.74	3.28	2.65	0.81	3.22	2.63	0.83	3.13	2.59	0.87	2.98	2.53	0.94
19.4	26.7	3.65	2.95	0.68	3.50	2.89	0.74	3.35	2.84	0.81	3.29	2.81	0.84	3.20	2.78	0.87	3.05	2.72	0.94
22.0	30.0	3.87	2.86	0.69	3.72	2.81	0.75	3.57	2.76	0.82	3.51	2.74	0.84	3.42	2.70	0.88	3.27	2.65	0.94
24.0	32.0	4.02	2.79	0.69	3.87	2.75	0.75	3.72	2.70	0.82	3.66	2.68	0.84	3.57	2.65	0.88	3.42	2.61	0.95

Temp: Fahrenheit
TC, SHC: kBtu/h
PI: kW

INDOOR		OUTDOOR TEMPERATURE (°FDB)																	
EWB	EDB	68			77			86			90			95			104		
		TC	SHC	PI	TC	SHC	PI	TC	SHC	PI	TC	SHC	PI	TC	SHC	PI	TC	SHC	PI
57.2	68.0	11.19	9.07	0.67	10.68	8.83	0.74	10.17	8.59	0.80	9.97	8.50	0.83	9.66	8.36	0.86	9.15	8.12	0.93
60.8	71.6	11.69	8.92	0.67	11.18	8.69	0.74	10.67	8.47	0.80	10.47	8.38	0.83	10.16	8.25	0.87	9.66	8.03	0.93
64.4	77.0	12.19	9.46	0.68	11.68	9.25	0.74	11.18	9.04	0.81	10.97	8.96	0.83	10.67	8.83	0.87	10.16	8.63	0.94
67.0	80.0	12.44	10.07	0.68	11.94	9.87	0.74	11.43	9.67	0.81	11.22	9.59	0.84	10.90	9.48	0.87	10.41	9.28	0.94
71.6	86.0	13.20	9.75	0.69	12.69	9.58	0.75	12.18	9.40	0.82	11.98	9.33	0.84	11.67	9.23	0.88	11.16	9.06	0.94
75.2	89.6	13.70	9.53	0.69	13.19	9.37	0.75	12.68	9.21	0.82	12.48	9.15	0.84	12.18	9.05	0.88	11.67	8.90	0.95

Heating

AFR	11.7
-----	------

Temp: Celsius
TC, PI: kW

INDOOR		OUTDOOR TEMPERATURE (°CWB)											
EDB	°C	-15		-10		-5		0		6		10	
		TC	PI	TC	PI	TC	PI	TC	PI	TC	PI	TC	PI
15.0	1.89	0.67	2.27	0.70	2.65	0.74	3.56	0.97	4.10	1.02	4.45	1.05	
21.1	1.77	0.69	2.15	0.72	2.53	0.76	3.42	0.99	3.96	1.04	4.32	1.08	
22.0	1.72	0.70	2.10	0.73	2.48	0.76	3.37	1.00	3.91	1.05	4.26	1.08	
24.0	1.68	0.70	2.06	0.74	2.44	0.77	3.31	1.01	3.85	1.06	4.21	1.09	
25.0	1.65	0.71	2.03	0.74	2.41	0.78	3.29	1.01	3.82	1.06	4.18	1.10	
27.0	1.61	0.72	1.99	0.75	2.37	0.78	3.23	1.02	3.77	1.07	4.13	1.11	

Temp: Fahrenheit
TC: kBtu/h
PI: kW

INDOOR		OUTDOOR TEMPERATURE (°FWB)											
EDB	°F	5		14		23		32		43		50	
		TC	PI	TC	PI	TC	PI	TC	PI	TC	PI	TC	PI
59.0	6.43	0.67	7.73	0.70	9.03	0.74	12.15	0.97	13.98	1.02	15.20	1.05	
70.0	6.04	0.69	7.33	0.72	8.63	0.76	11.68	0.99	13.50	1.04	14.73	1.08	
71.6	5.88	0.70	7.18	0.73	8.47	0.76	11.49	1.00	13.32	1.05	14.55	1.08	
75.2	5.72	0.70	7.02	0.74	8.31	0.77	11.31	1.01	13.14	1.06	14.36	1.09	
77.0	5.64	0.71	6.94	0.74	8.24	0.78	11.21	1.01	13.05	1.06	14.27	1.10	
80.6	5.48	0.72	6.78	0.75	8.08	0.78	11.03	1.02	12.86	1.07	14.08	1.11	

Symbols:

AFR	: Airflow rate	(m ³ /min.)
BF	: Bypass factor	
EWB	: Entering wet bulb temp.	(°C) / (°F)
EDB	: Entering dry bulb temp.	(°C) / (°F)
TC	: Total capacity	(kW) / (kBtu/h)
SHC	: Sensible heat capacity	(kW) / (kBtu/h)
PI	: Power input	(kW)

Notes:

1. ■ shows nominal (rated) capacities and power input.
2. TC, PI and SHC must be calculated by interpolation using the figures in the above tables. (Figures out of the tables should not be used for calculation.)
3. Capacities are based on the following conditions.
Corresponding refrigerant piping length : 25 ft (7.5 m)
Level difference : 0 ft (0 m)
4. Cooling capacity at -15°CDB and 5°FDB.

Temp: Celsius
TC, SHC, PI: kW
60 Hz, 208 - 230 V

INDOOR		OUTDOOR		
EWB	EDB	-15 (°CDB)		
°C	°C	TC	SHC	PI
14.0	20.0	3.42	2.53	0.52

Temp: Fahrenheit
TC, SHC: kBtu/h
PI: kW
60 Hz, 208 - 230 V

INDOOR		OUTDOOR		
EWB	EDB	5 (°FDB)		
°F	°F	TC	SHC	PI
57.2	68.0	11.66	8.61	0.52

3D093236

FTX18NMVJU + RX18NMVJU

60 Hz, 208 V

Cooling

AFR	20.2
BF	0.27

Temp: Celsius
TC, SHC, PI: kW

INDOOR		OUTDOOR TEMPERATURE (°CDB)																	
EWB	EDB	20			25			30			32			35			40		
°C	°C	TC	SHC	PI	TC	SHC	PI	TC	SHC	PI	TC	SHC	PI	TC	SHC	PI	TC	SHC	PI
14.0	20.0	5.41	4.15	1.11	5.16	4.03	1.21	4.92	3.91	1.32	4.82	3.86	1.36	4.67	3.79	1.43	4.43	3.67	1.53
16.0	22.0	5.65	4.08	1.11	5.41	3.96	1.22	5.16	3.85	1.32	5.06	3.81	1.37	4.92	3.74	1.43	4.67	3.63	1.54
18.0	25.0	5.90	4.29	1.12	5.65	4.19	1.22	5.40	4.08	1.33	5.31	4.04	1.37	5.16	3.98	1.44	4.91	3.88	1.54
19.4	26.7	6.02	4.54	1.12	5.77	4.44	1.23	5.53	4.34	1.33	5.43	4.30	1.38	5.28	4.24	1.44	5.03	4.15	1.55
22.0	30.0	6.38	4.39	1.13	6.14	4.30	1.24	5.89	4.21	1.34	5.79	4.18	1.39	5.64	4.12	1.45	5.40	4.04	1.56
24.0	32.0	6.63	4.28	1.14	6.38	4.20	1.24	6.13	4.12	1.35	6.04	4.09	1.39	5.89	4.04	1.46	5.64	3.96	1.56

Temp: Fahrenheit
TC, SHC: kBtu/h
PI: kW

INDOOR		OUTDOOR TEMPERATURE (°FDB)																	
EWB	EDB	68			77			86			90			95			104		
°F	°F	TC	SHC	PI	TC	SHC	PI	TC	SHC	PI	TC	SHC	PI	TC	SHC	PI	TC	SHC	PI
57.2	68.0	18.46	14.15	1.11	17.62	13.74	1.21	16.78	13.34	1.32	16.44	13.17	1.36	15.94	12.93	1.43	15.10	12.54	1.53
60.8	71.6	19.29	13.91	1.11	18.45	13.52	1.22	17.61	13.14	1.32	17.27	12.99	1.37	16.77	12.77	1.43	15.93	12.40	1.54
64.4	77.0	20.12	14.64	1.12	19.28	14.28	1.22	18.44	13.93	1.33	18.10	13.79	1.37	17.60	13.58	1.44	16.76	13.23	1.54
67.0	80.0	20.53	15.50	1.12	19.69	15.16	1.23	18.85	14.82	1.33	18.52	14.68	1.38	18.00	14.48	1.44	17.18	14.15	1.55
71.6	86.0	21.78	14.97	1.13	20.94	14.67	1.24	20.10	14.37	1.34	19.76	14.25	1.39	19.26	14.07	1.45	18.42	13.78	1.56
75.2	89.6	22.61	14.60	1.14	21.77	14.32	1.24	20.93	14.05	1.35	20.59	13.94	1.39	20.09	13.78	1.46	19.25	13.51	1.56

Heating

AFR	21.1
-----	------

Temp: Celsius
TC, PI: kW

INDOOR		OUTDOOR TEMPERATURE (°CWB)											
EDB		-15		-10		-5		0		6		10	
°C		TC	PI	TC	PI	TC	PI	TC	PI	TC	PI	TC	PI
15.0		3.01	1.13	3.62	1.19	4.23	1.25	5.69	1.63	6.55	1.72	7.12	1.78
21.1		2.83	1.16	3.44	1.22	4.04	1.28	5.47	1.67	6.33	1.76	6.90	1.82
22.0		2.75	1.18	3.36	1.23	3.97	1.29	5.38	1.69	6.24	1.77	6.81	1.83
24.0		2.68	1.19	3.29	1.25	3.90	1.30	5.30	1.70	6.16	1.79	6.73	1.85
25.0		2.64	1.19	3.25	1.25	3.86	1.31	5.25	1.71	6.11	1.80	6.68	1.86
27.0		2.57	1.21	3.18	1.27	3.78	1.32	5.17	1.73	6.02	1.81	6.60	1.87

Temp: Fahrenheit
TC: kBtu/h
PI: kW

INDOOR		OUTDOOR TEMPERATURE (°FWB)											
EDB		5		14		23		32		43		50	
°F		TC	PI	TC	PI	TC	PI	TC	PI	TC	PI	TC	PI
59.0		10.29	1.13	12.36	1.19	14.43	1.25	19.42	1.63	22.34	1.72	24.29	1.78
70.0		9.65	1.16	11.72	1.22	13.80	1.28	18.67	1.67	21.60	1.76	23.55	1.82
71.6		9.40	1.18	11.47	1.23	13.54	1.29	18.37	1.69	21.30	1.77	23.25	1.83
75.2		9.14	1.19	11.22	1.25	13.29	1.30	18.07	1.70	21.00	1.79	22.95	1.85
77.0		9.02	1.19	11.09	1.25	13.16	1.31	17.93	1.71	20.85	1.80	22.80	1.86
80.6		8.76	1.21	10.84	1.27	12.91	1.32	17.63	1.73	20.55	1.81	22.51	1.87

60 Hz, 230 V

Cooling

AFR	20.2
BF	0.27

Temp: Celsius
TC, SHC, PI: kW

INDOOR		OUTDOOR TEMPERATURE (°CDB)																	
EWB	EDB	20			25			30			32			35			40		
		TC	SHC	PI	TC	SHC	PI	TC	SHC	PI	TC	SHC	PI	TC	SHC	PI	TC	SHC	PI
14.0	20.0	5.41	4.15	1.11	5.16	4.03	1.21	4.92	3.91	1.32	4.82	3.86	1.36	4.67	3.79	1.43	4.43	3.67	1.53
16.0	22.0	5.65	4.08	1.11	5.41	3.96	1.22	5.16	3.85	1.32	5.06	3.81	1.37	4.92	3.74	1.43	4.67	3.63	1.54
18.0	25.0	5.90	4.29	1.12	5.65	4.19	1.22	5.40	4.08	1.33	5.31	4.04	1.37	5.16	3.98	1.44	4.91	3.88	1.54
19.4	26.7	6.02	4.54	1.12	5.77	4.44	1.23	5.53	4.34	1.33	5.43	4.30	1.38	5.28	4.24	1.44	5.03	4.15	1.55
22.0	30.0	6.38	4.39	1.13	6.14	4.30	1.24	5.89	4.21	1.34	5.79	4.18	1.39	5.64	4.12	1.45	5.40	4.04	1.56
24.0	32.0	6.63	4.28	1.14	6.38	4.20	1.24	6.13	4.12	1.35	6.04	4.09	1.39	5.89	4.04	1.46	5.64	3.96	1.56

Temp: Fahrenheit
TC, SHC: kBtu/h
PI: kW

INDOOR		OUTDOOR TEMPERATURE (°FDB)																	
EWB	EDB	68			77			86			90			95			104		
		TC	SHC	PI	TC	SHC	PI	TC	SHC	PI	TC	SHC	PI	TC	SHC	PI	TC	SHC	PI
57.2	68.0	18.46	14.15	1.11	17.62	13.74	1.21	16.78	13.34	1.32	16.44	13.17	1.36	15.94	12.93	1.43	15.10	12.54	1.53
60.8	71.6	19.29	13.91	1.11	18.45	13.52	1.22	17.61	13.14	1.32	17.27	12.99	1.37	16.77	12.77	1.43	15.93	12.40	1.54
64.4	77.0	20.12	14.64	1.12	19.28	14.28	1.22	18.44	13.93	1.33	18.10	13.79	1.37	17.60	13.58	1.44	16.76	13.23	1.54
67.0	80.0	20.53	15.50	1.12	19.69	15.16	1.23	18.85	14.82	1.33	18.52	14.68	1.38	18.00	14.48	1.44	17.18	14.15	1.55
71.6	86.0	21.78	14.97	1.13	20.94	14.67	1.24	20.10	14.37	1.34	19.76	14.25	1.39	19.26	14.07	1.45	18.42	13.78	1.56
75.2	89.6	22.61	14.60	1.14	21.77	14.32	1.24	20.93	14.05	1.35	20.59	13.94	1.39	20.09	13.78	1.46	19.25	13.51	1.56

Heating

AFR	21.1
-----	------

Temp: Celsius
TC, PI: kW

INDOOR		OUTDOOR TEMPERATURE (°CWB)											
EDB	°C	-15		-10		-5		0		6		10	
		TC	PI	TC	PI	TC	PI	TC	PI	TC	PI	TC	PI
15.0	3.01	1.13	3.62	1.19	4.23	1.25	5.69	1.63	6.55	1.72	7.12	1.78	
21.1	2.83	1.16	3.44	1.22	4.04	1.28	5.47	1.67	6.33	1.76	6.90	1.82	
22.0	2.75	1.18	3.36	1.23	3.97	1.29	5.38	1.69	6.24	1.77	6.81	1.83	
24.0	2.68	1.19	3.29	1.25	3.90	1.30	5.30	1.70	6.16	1.79	6.73	1.85	
25.0	2.64	1.19	3.25	1.25	3.86	1.31	5.25	1.71	6.11	1.80	6.68	1.86	
27.0	2.57	1.21	3.18	1.27	3.78	1.32	5.17	1.73	6.02	1.81	6.60	1.87	

Temp: Fahrenheit
TC: kBtu/h
PI: kW

INDOOR		OUTDOOR TEMPERATURE (°FWB)											
EDB	°F	5		14		23		32		43		50	
		TC	PI	TC	PI	TC	PI	TC	PI	TC	PI	TC	PI
59.0	10.29	1.13	12.36	1.19	14.43	1.25	19.42	1.63	22.34	1.72	24.29	1.78	
70.0	9.65	1.16	11.72	1.22	13.80	1.28	18.67	1.67	21.60	1.76	23.55	1.82	
71.6	9.40	1.18	11.47	1.23	13.54	1.29	18.37	1.69	21.30	1.77	23.25	1.83	
75.2	9.14	1.19	11.22	1.25	13.29	1.30	18.07	1.70	21.00	1.79	22.95	1.85	
77.0	9.02	1.19	11.09	1.25	13.16	1.31	17.93	1.71	20.85	1.80	22.80	1.86	
80.6	8.76	1.21	10.84	1.27	12.91	1.32	17.63	1.73	20.55	1.81	22.51	1.87	

Symbols:

AFR	: Airflow rate	(m ³ /min.)
BF	: Bypass factor	
EWB	: Entering wet bulb temp.	(°C) / (°F)
EDB	: Entering dry bulb temp.	(°C) / (°F)
TC	: Total capacity	(kW) / (kBtu/h)
SHC	: Sensible heat capacity	(kW) / (kBtu/h)
PI	: Power input	(kW)

Notes:

1. ■ shows nominal (rated) capacities and power input.
2. TC, PI and SHC must be calculated by interpolation using the figures in the above tables. (Figures out of the tables should not be used for calculation.)
3. Capacities are based on the following conditions.
Corresponding refrigerant piping length : 25 ft (7.5 m)
Level difference : 0 ft (0 m)
4. Cooling capacity at -15°CDB and 5°FDB.

Temp: Celsius
TC, SHC, PI: kW
60 Hz, 208 - 230 V

INDOOR		OUTDOOR		
EWB	EDB	-15 (°CDB)		
°C	°C	TC	SHC	PI
14.0	20.0	5.44	4.02	0.71

Temp: Fahrenheit
TC, SHC: kBtu/h
PI: kW
60 Hz, 208 - 230 V

INDOOR		OUTDOOR		
EWB	EDB	5 (°FDB)		
°F	°F	TC	SHC	PI
57.2	68.0	18.54	13.69	0.71

3D093237

FTX24NMVJU + RX24NMVJU

60 Hz, 208 V

Cooling

AFR	20.2
BF	0.27

Temp: Celsius

TC, SHC, PI: kW

INDOOR		OUTDOOR TEMPERATURE (°CDB)																	
EWB	EDB	20			25			30			32			35			40		
		°C	°C	TC	SHC	PI	TC	SHC	PI	TC	SHC	PI	TC	SHC	PI	TC	SHC	PI	TC
14.0	20.0	6.05	4.47	1.29	6.05	4.47	1.43	5.77	4.33	1.55	5.66	4.27	1.60	5.49	4.19	1.68	5.20	4.04	1.71
16.0	22.0	6.64	4.54	1.31	6.35	4.40	1.43	6.06	4.27	1.56	5.94	4.21	1.61	5.77	4.13	1.68	5.48	4.00	1.72
18.0	25.0	6.92	4.74	1.32	6.63	4.61	1.44	6.35	4.49	1.57	6.23	4.43	1.62	6.06	4.36	1.69	5.77	4.24	1.73
19.4	26.7	7.07	4.99	1.32	6.78	4.86	1.45	6.49	4.74	1.57	6.37	4.69	1.62	6.20	4.62	1.70	5.91	4.50	1.73
22.0	30.0	7.49	4.80	1.33	7.21	4.69	1.46	6.92	4.59	1.58	6.80	4.54	1.63	6.63	4.48	1.71	6.34	4.37	1.74
24.0	32.0	7.78	4.67	1.34	7.49	4.57	1.46	7.20	4.47	1.59	7.09	4.43	1.64	6.91	4.38	1.71	6.63	4.28	1.75

Temp: Fahrenheit

TC, SHC: kBtu/h

PI: kW

INDOOR		OUTDOOR TEMPERATURE (°FDB)																	
EWB	EDB	68			77			86			90			95			104		
		°F	°F	TC	SHC	PI	TC	SHC	PI	TC	SHC	PI	TC	SHC	PI	TC	SHC	PI	TC
57.2	68.0	20.65	15.25	1.29	20.65	15.25	1.43	19.70	14.77	1.55	19.31	14.57	1.60	18.72	14.28	1.68	17.73	13.80	1.71
60.8	71.6	22.65	15.49	1.31	21.66	15.02	1.43	20.68	14.55	1.56	20.28	14.37	1.61	19.69	14.09	1.68	18.71	13.64	1.72
64.4	77.0	23.62	16.18	1.32	22.64	15.74	1.44	21.65	15.30	1.57	21.26	15.13	1.62	20.67	14.87	1.69	19.68	14.45	1.73
67.0	80.0	24.11	17.01	1.32	23.12	16.59	1.45	22.14	16.17	1.57	21.75	16.01	1.62	21.20	15.76	1.70	20.17	15.35	1.73
71.6	86.0	25.57	16.39	1.33	24.59	16.01	1.46	23.60	15.64	1.58	23.21	15.50	1.63	22.62	15.28	1.71	21.63	14.92	1.74
75.2	89.6	26.55	15.94	1.34	25.56	15.60	1.46	24.58	15.26	1.59	24.18	15.13	1.64	23.59	14.93	1.71	22.61	14.60	1.75

Heating

AFR	21.1
-----	------

Temp: Celsius

TC, PI: kW

INDOOR		OUTDOOR TEMPERATURE (°CWB)											
EDB	°C	-15		-10		-5		0		6		10	
		TC	PI	TC	PI	TC	PI	TC	PI	TC	PI	TC	PI
15.0	3.35	1.29	4.02	1.36	4.70	1.43	6.32	1.87	7.27	1.96	7.91	2.03	
21.1	3.14	1.33	3.82	1.40	4.49	1.46	6.08	1.91	7.03	2.01	7.67	2.08	
22.0	3.06	1.34	3.73	1.41	4.41	1.48	5.98	1.93	6.93	2.03	7.57	2.09	
24.0	2.98	1.36	3.65	1.43	4.33	1.49	5.88	1.95	6.84	2.05	7.47	2.11	
25.0	2.94	1.37	3.61	1.43	4.28	1.50	5.83	1.96	6.79	2.06	7.42	2.12	
27.0	2.85	1.38	3.53	1.45	4.20	1.51	5.74	1.97	6.69	2.07	7.33	2.14	

Temp: Fahrenheit

TC: kBtu/h

PI: kW

INDOOR		OUTDOOR TEMPERATURE (°FWB)											
EDB	°F	5		14		23		32		43		50	
		TC	PI	TC	PI	TC	PI	TC	PI	TC	PI	TC	PI
59.0	11.42	1.29	13.73	1.36	16.03	1.43	21.56	1.87	24.81	1.96	26.98	2.03	
70.0	10.72	1.33	13.02	1.40	15.32	1.46	20.74	1.91	24.00	2.01	26.15	2.08	
71.6	10.44	1.34	12.74	1.41	15.04	1.48	20.40	1.93	23.66	2.03	25.82	2.09	
75.2	10.16	1.36	12.46	1.43	14.76	1.49	20.07	1.95	23.32	2.05	25.49	2.11	
77.0	10.02	1.37	12.32	1.43	14.62	1.50	19.91	1.96	23.16	2.06	25.33	2.12	
80.6	9.73	1.38	12.04	1.45	14.34	1.51	19.58	1.97	22.83	2.07	24.99	2.14	

60 Hz, 230 V

Cooling

AFR	20.2
BF	0.27

Temp: Celsius
TC, SHC, PI: kW

INDOOR		OUTDOOR TEMPERATURE (°CDB)																	
EWB	EDB	20			25			30			32			35			40		
		TC	SHC	PI	TC	SHC	PI	TC	SHC	PI	TC	SHC	PI	TC	SHC	PI	TC	SHC	PI
14.0	20.0	6.05	4.47	1.29	6.05	4.47	1.43	5.77	4.33	1.55	5.66	4.27	1.60	5.49	4.19	1.68	5.20	4.04	1.71
16.0	22.0	6.64	4.54	1.31	6.35	4.40	1.43	6.06	4.27	1.56	5.94	4.21	1.61	5.77	4.13	1.68	5.48	4.00	1.72
18.0	25.0	6.92	4.74	1.32	6.63	4.61	1.44	6.35	4.49	1.57	6.23	4.43	1.62	6.06	4.36	1.69	5.77	4.24	1.73
19.4	26.7	7.07	4.99	1.32	6.78	4.86	1.45	6.49	4.74	1.57	6.37	4.69	1.62	6.20	4.62	1.70	5.91	4.50	1.73
22.0	30.0	7.49	4.80	1.33	7.21	4.69	1.46	6.92	4.59	1.58	6.80	4.54	1.63	6.63	4.48	1.71	6.34	4.37	1.74
24.0	32.0	7.78	4.67	1.34	7.49	4.57	1.46	7.20	4.47	1.59	7.09	4.43	1.64	6.91	4.38	1.71	6.63	4.28	1.75

Temp: Fahrenheit
TC, SHC: kBtu/h
PI: kW

INDOOR		OUTDOOR TEMPERATURE (°FDB)																	
EWB	EDB	68			77			86			90			95			104		
		TC	SHC	PI	TC	SHC	PI	TC	SHC	PI	TC	SHC	PI	TC	SHC	PI	TC	SHC	PI
57.2	68.0	20.65	15.25	1.29	20.65	15.25	1.43	19.70	14.77	1.55	19.31	14.57	1.60	18.72	14.28	1.68	17.73	13.80	1.71
60.8	71.6	22.65	15.49	1.31	21.66	15.02	1.43	20.68	14.55	1.56	20.28	14.37	1.61	19.69	14.09	1.68	18.71	13.64	1.72
64.4	77.0	23.62	16.18	1.32	22.64	15.74	1.44	21.65	15.30	1.57	21.26	15.13	1.62	20.67	14.87	1.69	19.68	14.45	1.73
67.0	80.0	24.11	17.01	1.32	23.12	16.59	1.45	22.14	16.17	1.57	21.75	16.01	1.62	21.20	15.76	1.70	20.17	15.35	1.73
71.6	86.0	25.57	16.39	1.33	24.59	16.01	1.46	23.60	15.64	1.58	23.21	15.50	1.63	22.62	15.28	1.71	21.63	14.92	1.74
75.2	89.6	26.55	15.94	1.34	25.56	15.60	1.46	24.58	15.26	1.59	24.18	15.13	1.64	23.59	14.93	1.71	22.61	14.60	1.75

Heating

AFR	21.1
-----	------

Temp: Celsius
TC, PI: kW

INDOOR		OUTDOOR TEMPERATURE (°CWB)											
EDB	°C	-15		-10		-5		0		6		10	
		TC	PI	TC	PI	TC	PI	TC	PI	TC	PI	TC	PI
15.0	3.35	1.29	4.02	1.36	4.70	1.43	6.32	1.87	7.27	1.96	7.91	2.03	
21.1	3.14	1.33	3.82	1.40	4.49	1.46	6.08	1.91	7.03	2.01	7.67	2.08	
22.0	3.06	1.34	3.73	1.41	4.41	1.48	5.98	1.93	6.93	2.03	7.57	2.09	
24.0	2.98	1.36	3.65	1.43	4.33	1.49	5.88	1.95	6.84	2.05	7.47	2.11	
25.0	2.94	1.37	3.61	1.43	4.28	1.50	5.83	1.96	6.79	2.06	7.42	2.12	
27.0	2.85	1.38	3.53	1.45	4.20	1.51	5.74	1.97	6.69	2.07	7.33	2.14	

Temp: Fahrenheit
TC: kBtu/h
PI: kW

INDOOR		OUTDOOR TEMPERATURE (°FWB)											
EDB	°F	5		14		23		32		43		50	
		TC	PI	TC	PI	TC	PI	TC	PI	TC	PI	TC	PI
59.0	11.42	1.29	13.73	1.36	16.03	1.43	21.56	1.87	24.81	1.96	26.98	2.03	
70.0	10.72	1.33	13.02	1.40	15.32	1.46	20.74	1.91	24.00	2.01	26.15	2.08	
71.6	10.44	1.34	12.74	1.41	15.04	1.48	20.40	1.93	23.66	2.03	25.82	2.09	
75.2	10.16	1.36	12.46	1.43	14.76	1.49	20.07	1.95	23.32	2.05	25.49	2.11	
77.0	10.02	1.37	12.32	1.43	14.62	1.50	19.91	1.96	23.16	2.06	25.33	2.12	
80.6	9.73	1.38	12.04	1.45	14.34	1.51	19.58	1.97	22.83	2.07	24.99	2.14	

Symbols:

AFR	: Airflow rate	(m ³ /min.)
BF	: Bypass factor	
EWB	: Entering wet bulb temp.	(°C) / (°F)
EDB	: Entering dry bulb temp.	(°C) / (°F)
TC	: Total capacity	(kW) / (kBtu/h)
SHC	: Sensible heat capacity	(kW) / (kBtu/h)
PI	: Power input	(kW)

Notes:

1. ■ shows nominal (rated) capacities and power input.
2. TC, PI and SHC must be calculated by interpolation using the figures in the above tables. (Figures out of the tables should not be used for calculation.)
3. Capacities are based on the following conditions.
Corresponding refrigerant piping length : 25 ft (7.5 m)
Level difference : 0 ft (0 m)
4. Cooling capacity at -15°CDB and 5°FDB.

Temp: Celsius

TC, SHC, PI: kW

60 Hz, 208 - 230 V

INDOOR		OUTDOOR		
EWB	EDB	-15 (°CDB)		
°C	°C	TC	SHC	PI
14.0	20.0	5.95	4.39	0.56

Temp: Fahrenheit

TC, SHC: kBtu/h

PI: kW

60 Hz, 208 - 230 V

INDOOR		OUTDOOR		
EWB	EDB	5 (°FDB)		
°F	°F	TC	SHC	PI
57.2	68.0	20.35	15.03	0.56

3D093238A

7.3 Capacity Correction Factor by the Length of Refrigerant Piping (Reference)

The cooling capacity and the heating capacity of the unit have to be corrected in accordance with the length of refrigerant piping — the distance between the indoor unit and the outdoor unit.

<— line : cooling capacity>

<--- line : heating capacity>

7.3.1 09/12 Class

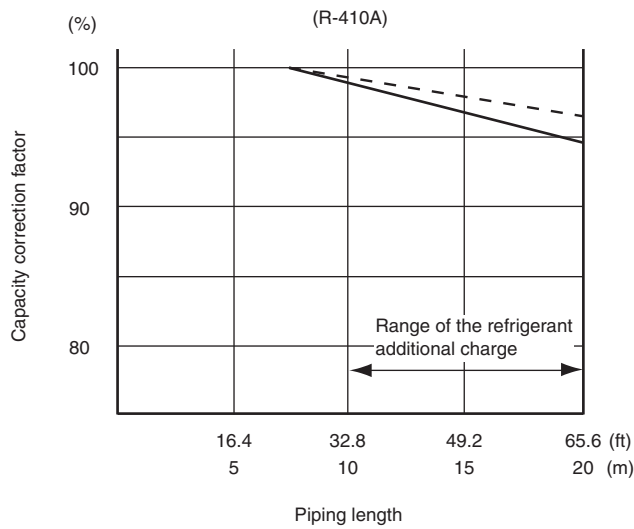

7.3.2 18 Class

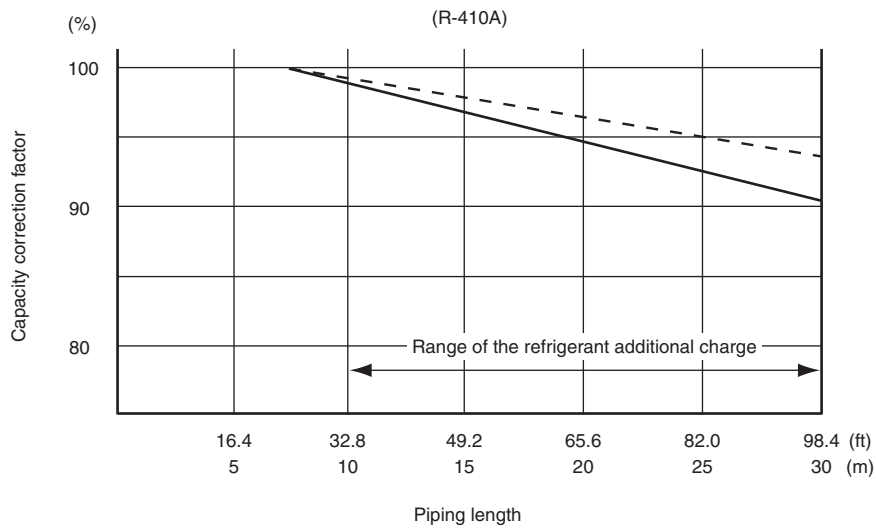

7.3.3 24 Class

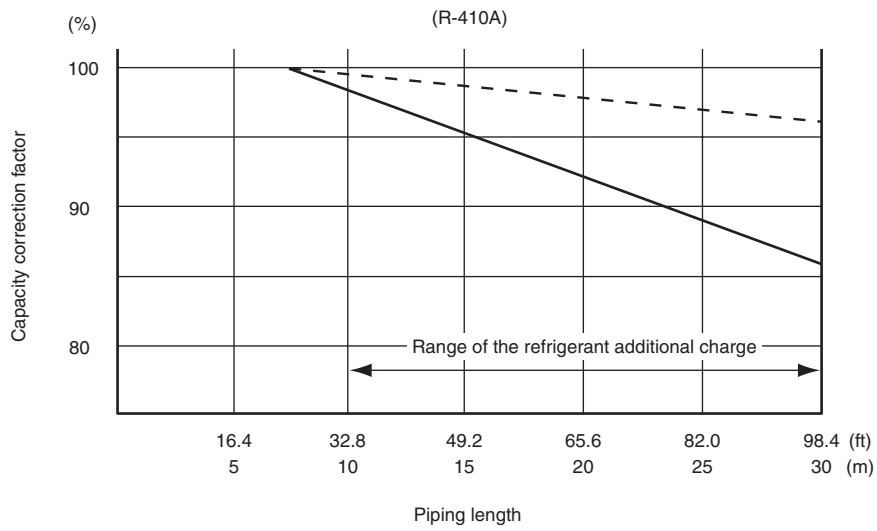

Note: The graphs show the factor when additional refrigerant of the proper quantity is charged.

8. Operation Limit

RK09/12/18/24NMVJU

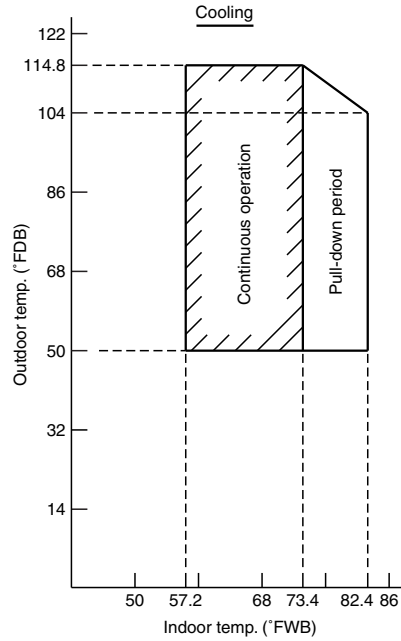

Notes:

- The graphs are based on the following conditions.
- Equivalent piping length 25ft
 - Level difference 0ft
 - Air flow rate High

4D092212

RX09/12/18/24NMVJU

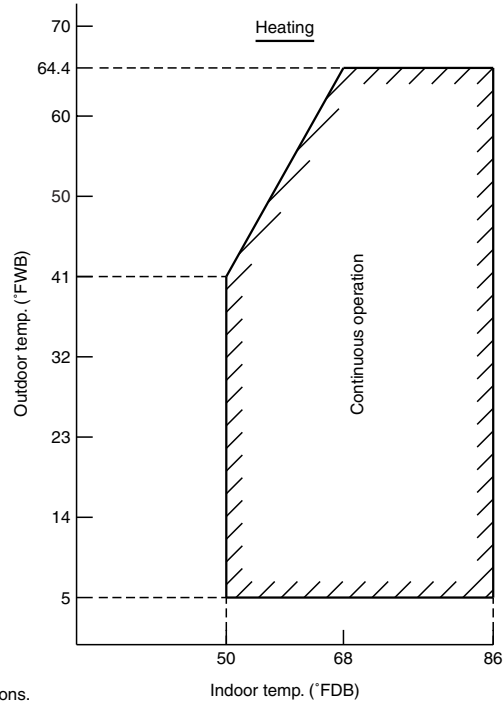
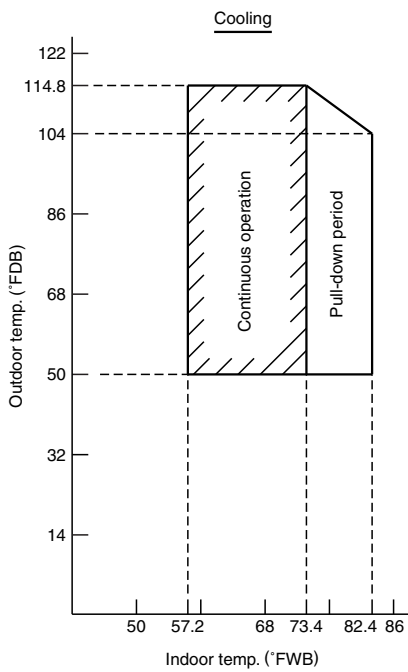

Notes:

- The graphs are based on the following conditions.
- Equivalent piping length 25ft
 - Level difference 0ft
 - Air flow rate High

3D092209

9. Sound Level

9.1 Measuring Location

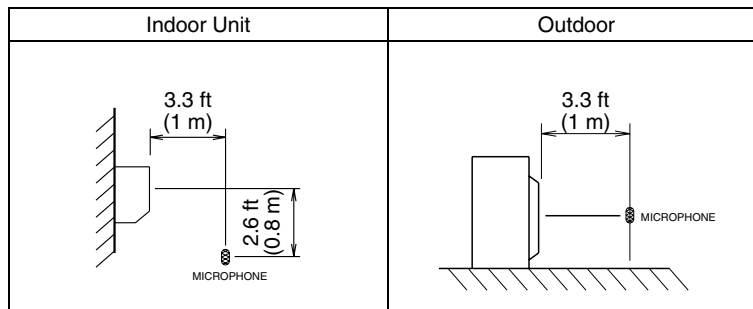

- Notes:**
1. Operation sound is measured in an anechoic chamber.
 2. The data are based on the conditions shown in the table below.

Cooling	Heating	Piping Length
Indoor ; 80°FDB (26.7°CDB) / 67°FWB (19.4°CWB) Outdoor ; 95°FDB (35°CDB) / 75°FWB (24°CWB)	Indoor ; 70°FDB (21°CDB) / 60°FWB (15.6°CWB) Outdoor ; 47°FDB (8.3°CDB) / 43°FWB (6°CWB)	16.4 ft (5 m)

9.2 Indoor Unit

9.2.1 Cooling Only

FTK09NMVJU

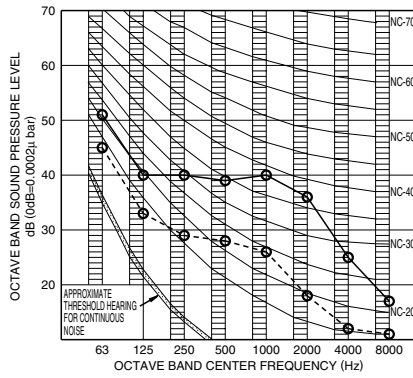

4D092958A

FTK12NMVJU

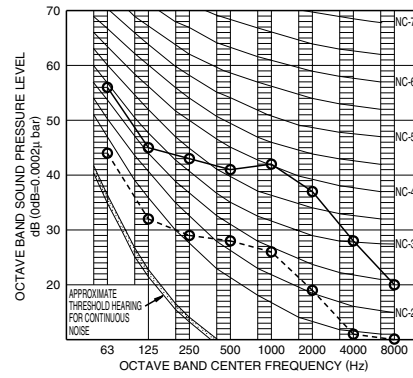

4D092887A

FTK18NMVJU

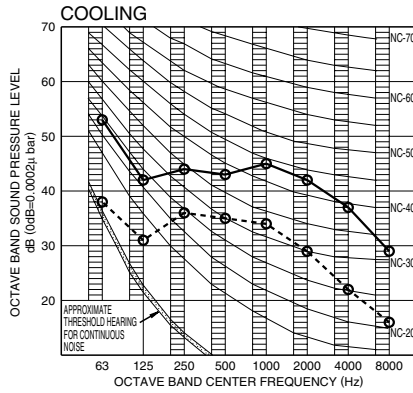

4D093070

FTK24NMVJU

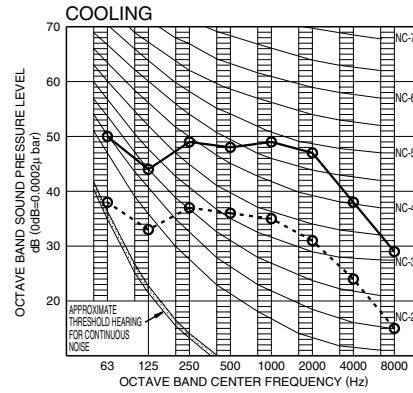

4D093071

9.2.2 Heat Pump FTX09NMVJU

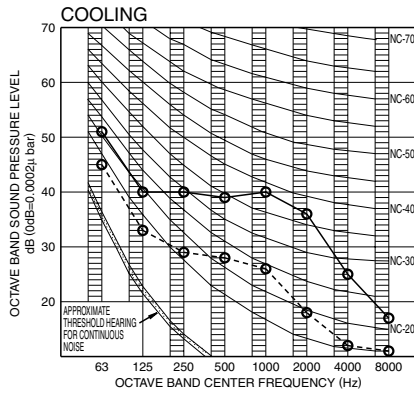

OVER ALL (dB)

SCALE	60Hz 208/230V (H)	60Hz 208/230V (L)
A	43	30

(B.G.N IS ALREADY RECTIFIED)

OPERATING CONDITIONS
POWER SOURCE 208/230V 60Hz

JIS STANDARD

○—○ 60Hz 208/230V (H)
○- -○ 60Hz 208/230V (L)
Cooling

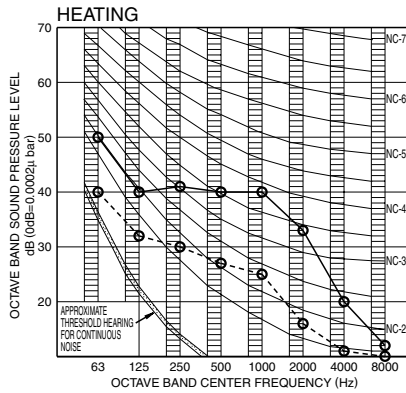

OVER ALL (dB)

SCALE	60Hz 208/230V (H)	60Hz 208/230V (L)
A	43	29

(B.G.N IS ALREADY RECTIFIED)

OPERATING CONDITIONS
POWER SOURCE 208/230V 60Hz

JIS STANDARD

○—○ 60Hz 208/230V (H)
○- -○ 60Hz 208/230V (L)
Heating

3D092957A

FTX12NMVJU

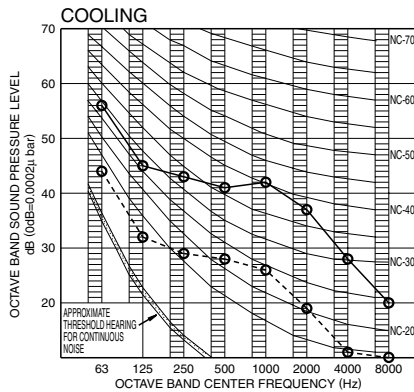

OVER ALL (dB)

SCALE	60Hz 208/230V (H)	60Hz 208/230V (L)
A	45	30

(B.G.N IS ALREADY RECTIFIED)

OPERATING CONDITIONS
POWER SOURCE 208/230V 60Hz

JIS STANDARD

○—○ 60Hz 208/230V (H)
○- -○ 60Hz 208/230V (L)
Cooling

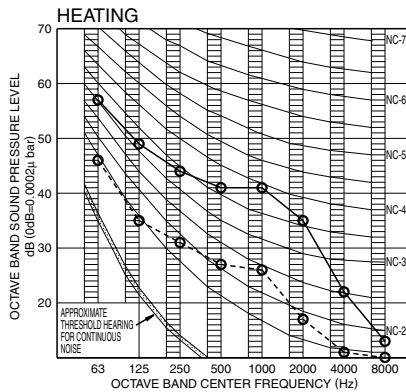

OVER ALL (dB)

SCALE	60Hz 208/230V (H)	60Hz 208/230V (L)
A	45	30

(B.G.N IS ALREADY RECTIFIED)

OPERATING CONDITIONS
POWER SOURCE 208/230V 60Hz

JIS STANDARD

○—○ 60Hz 208/230V (H)
○- -○ 60Hz 208/230V (L)
Heating

3D092886A

FTX18NMVJU

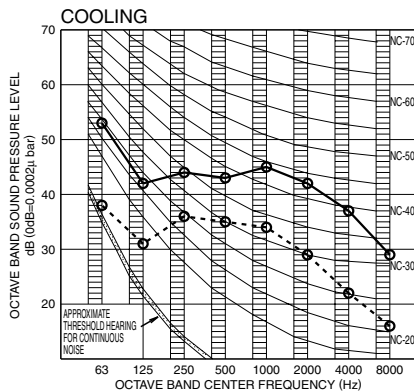

OVER ALL (dB)

SCALE	60Hz 208/230V (H)	60Hz 208/230V (L)
A	49	38

(B.G.N IS ALREADY RECTIFIED)

OPERATING CONDITIONS
POWER SOURCE 208/230V 60Hz

JIS STANDARD

○—○ 60Hz 208/230V (H)
○- -○ 60Hz 208/230V (L)
Cooling

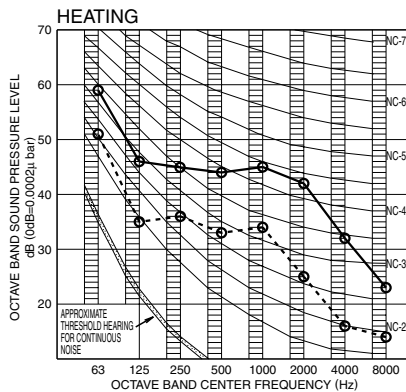

OVER ALL (dB)

SCALE	60Hz 208/230V (H)	60Hz 208/230V (L)
A	49	37

(B.G.N IS ALREADY RECTIFIED)

OPERATING CONDITIONS
POWER SOURCE 208/230V 60Hz

JIS STANDARD

○—○ 60Hz 208/230V (H)
○- -○ 60Hz 208/230V (L)
Heating

3D093064

FTX24NMVJU

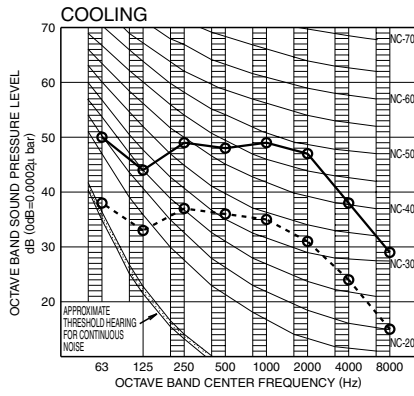

SCALE	60Hz 208/230V (H)	60Hz 208/230V (L)
A	53	39

(B.G.N IS ALREADY RECTIFIED)

OPERATING CONDITIONS

POWER SOURCE 208/230V 60Hz

JIS STANDARD

○—○ 60Hz 208/230V (H)

○- -○ 60Hz 208/230V (L)

Cooling

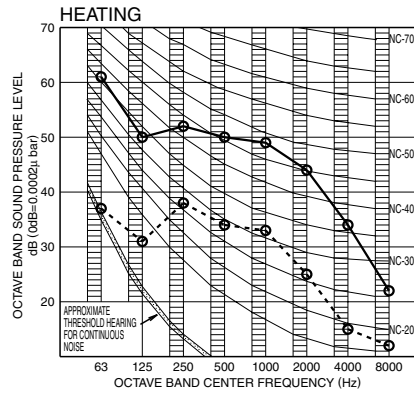

SCALE	60Hz 208/230V (H)	60Hz 208/230V (L)
A	53	37

(B.G.N IS ALREADY RECTIFIED)

OPERATING CONDITIONS

POWER SOURCE 208/230V 60Hz

JIS STANDARD

○—○ 60Hz 208/230V (H)

○- -○ 60Hz 208/230V (L)

Heating

3D093065

9.3 Outdoor Unit

9.3.1 Cooling Only

RK09NMVJU

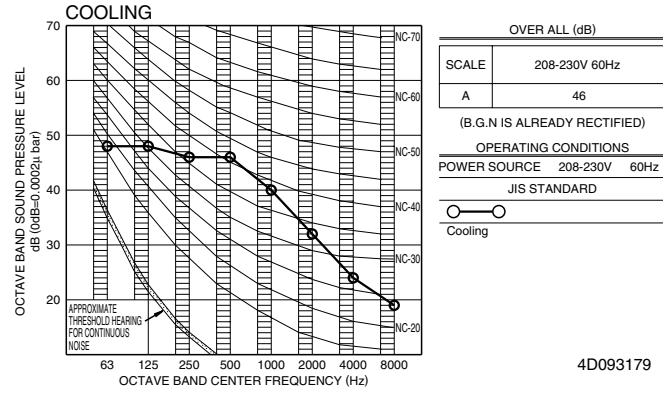

RK12NMVJU

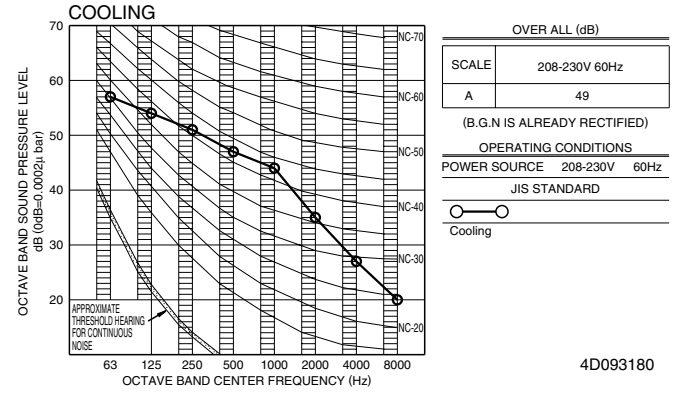

RK18NMVJU

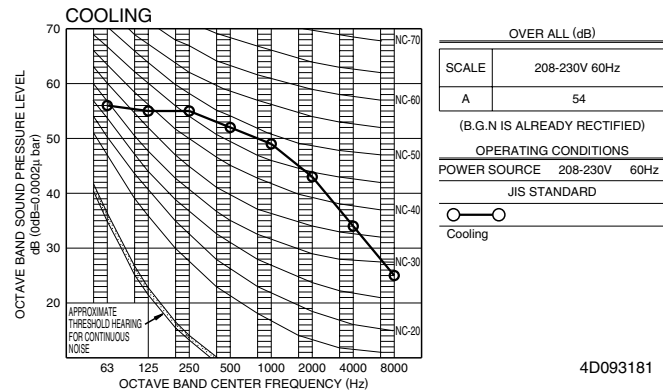

RK24NMVJU

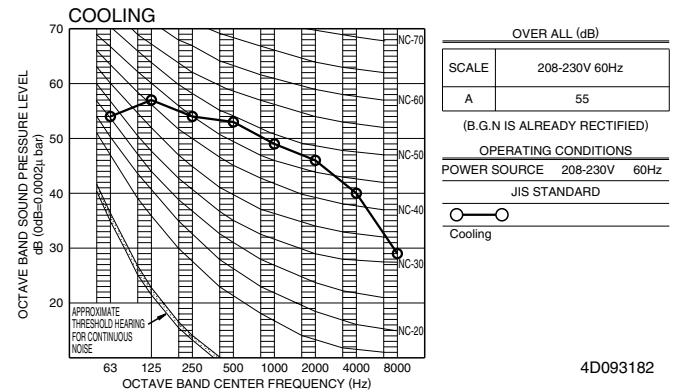

9.3.2 Heat Pump RX09NMVJU

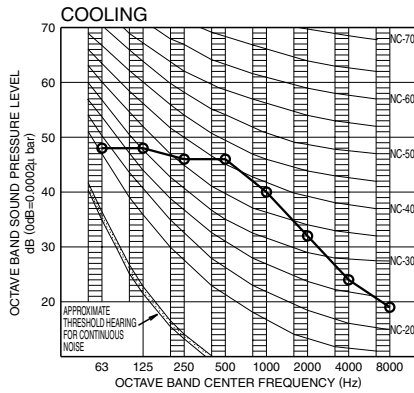

OVER ALL (dB)	
SCALE	208-230V 60Hz
A	46
(B.G.N IS ALREADY RECTIFIED)	
OPERATING CONDITIONS	
POWER SOURCE	208-230V 60Hz
JIS STANDARD	
○—○ Cooling	

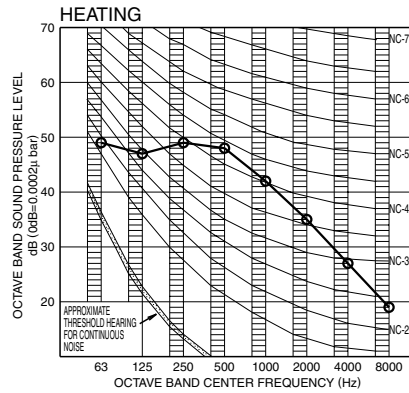

OVER ALL (dB)	
SCALE	208-230V 60Hz
A	48
(B.G.N IS ALREADY RECTIFIED)	
OPERATING CONDITIONS	
POWER SOURCE	208-230V 60Hz
JIS STANDARD	
○—○ Heating	

3D093170

RX12NMVJU

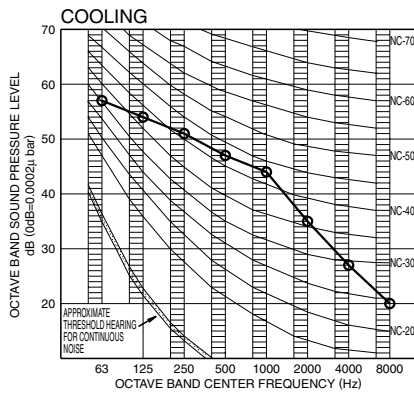

OVER ALL (dB)	
SCALE	208-230V 60Hz
A	49
(B.G.N IS ALREADY RECTIFIED)	
OPERATING CONDITIONS	
POWER SOURCE	208-230V 60Hz
JIS STANDARD	
○—○ Cooling	

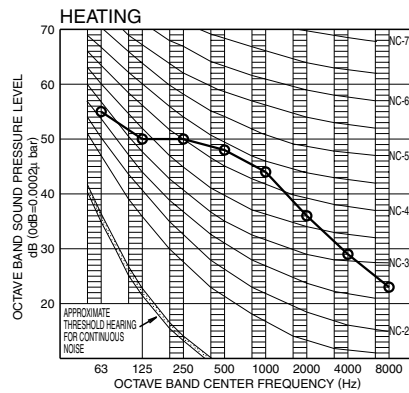

OVER ALL (dB)	
SCALE	208-230V 60Hz
A	49
(B.G.N IS ALREADY RECTIFIED)	
OPERATING CONDITIONS	
POWER SOURCE	208-230V 60Hz
JIS STANDARD	
○—○ Heating	

3D093171

RX18NMVJU

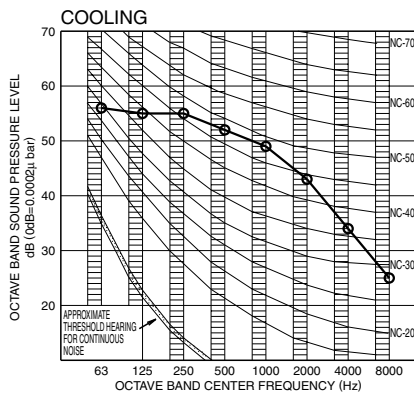

OVER ALL (dB)	
SCALE	208-230V 60Hz
A	54
(B.G.N IS ALREADY RECTIFIED)	
OPERATING CONDITIONS	
POWER SOURCE	208-230V 60Hz
JIS STANDARD	
○—○ Cooling	

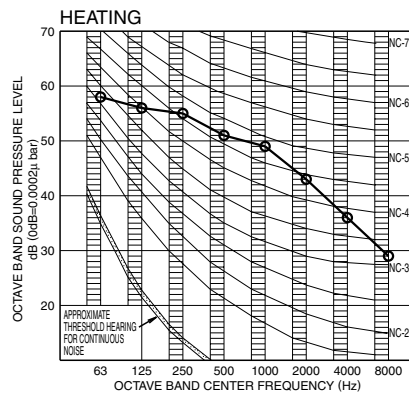

OVER ALL (dB)	
SCALE	208-230V 60Hz
A	54
(B.G.N IS ALREADY RECTIFIED)	
OPERATING CONDITIONS	
POWER SOURCE	208-230V 60Hz
JIS STANDARD	
○—○ Heating	

3D093172

RX24NMVJU

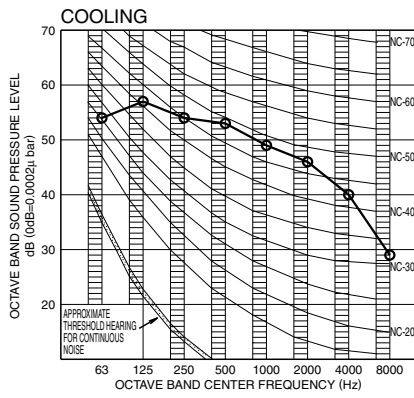

OVER ALL (dB)

SCALE	208-230V 60Hz
A	55

(B.G.N IS ALREADY RECTIFIED)

OPERATING CONDITIONS

POWER SOURCE	208-230V 60Hz
JIS STANDARD	

○—○
Cooling

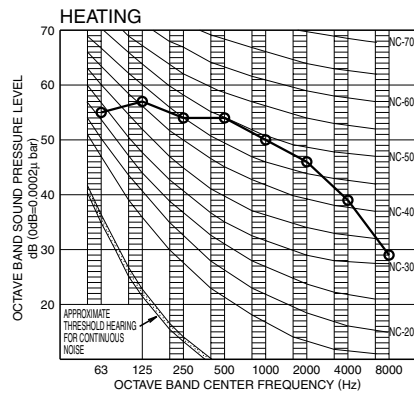

OVER ALL (dB)

SCALE	208-230V 60Hz
A	55

(B.G.N IS ALREADY RECTIFIED)

OPERATING CONDITIONS

POWER SOURCE	208-230V 60Hz
JIS STANDARD	

○—○
Heating

3D093173

10. Electric Characteristics

Unit Combination		Power Supply				Compressor		OFM		IFM	
Indoor Unit	Outdoor Unit	Hz - Volts	Voltage Range	MCA	MFA	RHz	RLA	W	FLA	W	FLA
FTK09NMVJU	RK09NMVJU	60 - 208	Min. 187 V Max. 253 V	12.1	15	64	6.8	14	0.13	21	0.20
		60 - 230									
FTK12NMVJU	RK12NMVJU	60 - 208	Min. 187 V Max. 253 V	12.2	15	88	7.5	18	0.15	28	0.23
		60 - 230									
FTK18NMVJU	RK18NMVJU	60 - 208	Min. 187 V Max. 253 V	18.3	20	70	10.0	69	0.45	46	0.30
		60 - 230									
FTK24NMVJU	RK24NMVJU	60 - 208	Min. 187 V Max. 253 V	18.3	20	92	12.0	58	0.38	46	0.30
		60 - 230									
FTX09NMVJU	RX09NMVJU	60 - 208	Min. 187 V Max. 253 V	12.1	15	88	8.5	14	0.13	21	0.20
		60 - 230									
FTX12NMVJU	RX12NMVJU	60 - 208	Min. 187 V Max. 253 V	12.2	15	96	8.5	18	0.15	28	0.23
		60 - 230									
FTX18NMVJU	RX18NMVJU	60 - 208	Min. 187 V Max. 253 V	18.3	20	90	10.8	69	0.45	46	0.30
		60 - 230									
FTX24NMVJU	RX24NMVJU	60 - 208	Min. 187 V Max. 253 V	18.3	20	96	12.0	58	0.38	46	0.30
		60 - 230									

Symbols:

MCA	: Min. circuit amps (A)
MFA	: Max. fuse amps (A)
RHz	: Rated operating frequency (Hz)
RLA	: Rated load amps (A)
OFM	: Outdoor fan motor
IFM	: Indoor fan motor
W	: Fan motor rated output (W)
FLA	: Full load amps (A)

Notes:

1. RHz is the max frequency that comes in cooling operation and heating operation.
2. RLA is the max current that comes in cooling operation and heating operation.
3. Maximum allowable voltage variation between phases is 2%.
4. Select wire size based on the larger value of MCA.
5. Instead of a fuse, use a circuit breaker.
6. Be sure to install a ground leak detector.
(This unit uses an inverter, which means that a ground leak detector capable of handling high harmonics must be used in order to prevent malfunctioning of the ground leak detector.)

3D093165

11. Installation Manual

11.1 Indoor Unit

Contents

Safety Considerations	1	Refrigerant Piping Work	9
Accessories	3	1. Flaring the pipe end.....	9
Choosing an Installation Site	3	2. Refrigerant piping	9
1. Indoor unit	3	Installation Tips	10
2. Wireless remote controller.....	3	1. Removing and installing the front panel	10
Indoor Unit Installation Drawings	4	2. Removing and installing the front grille.....	11
Indoor Unit Installation	5	3. How to set the different addresses	11
1. Installing the mounting plate.....	5	Trial Operation and Testing	12
2. Drilling a wall hole and installing wall embedded pipe	6	1. Trial operation and testing	12
3. Installing the indoor unit	6	2. Test items	12
4. Wiring	8		
5. Drain piping	8		

Safety Considerations

- Read these **Safety Considerations** carefully to ensure correct installation.
 - This manual classifies the precautions into **DANGER**, **WARNING** and **CAUTION**. Be sure to follow all the precautions below: they are all important for ensuring safety.
- ⚠ DANGER** Indicates an imminently hazardous situation which, if not avoided, will result in death or serious injury.
- ⚠ WARNING** Failure to follow any of **WARNING** is likely to result in such grave consequences as death or serious injury.
- ⚠ CAUTION** Failure to follow any of **CAUTION** may in some cases result in grave consequences.
- After completing installation, test the unit to check for installation errors. Give the user adequate instructions concerning the use and cleaning of the unit according to the Operation Manual.

⚠ DANGER _____

- Refrigerant gas is heavier than air and replaces oxygen. A massive leak could lead to oxygen depletion, especially in basements, and an asphyxiation hazard could occur leading to serious injury or death.
- If the refrigerant gas leaks during installation, ventilate the area immediately. Refrigerant gas may produce a toxic gas if it comes in contact with fire such as from a fan heater, stove or cooking device. Exposure to this gas could cause severe injury or death.
- After completing the installation work, check that the refrigerant gas does not leak. Refrigerant gas may produce a toxic gas if it comes in contact with fire such as from a fan heater, stove or cooking device. Exposure to this gas could cause severe injury or death.
- Do not ground units to water pipes, telephone wires or lightning rods because incomplete grounding could cause a severe shock hazard resulting in severe injury or death, and to gas pipes because a gas leak could result in an explosion which could lead to severe injury or death.
- Safely dispose of the packing materials. Packing materials, such as nails and other metal or wooden parts, may cause stabs or other injuries. Tear apart and throw away plastic packaging bags so that children will not play with them. Children playing with plastic bags face the danger of death by suffocation.

- Do not install unit in an area where flammable materials are present due to risk of explosion resulting in serious injury or death.
- Do not ground units to telephone wires or lightning rods because lightning strikes could cause a severe shock hazard resulting in severe injury or death, and to gas pipes because a gas leak could result in an explosion which could lead to severe injury or death.

WARNING

- Installation shall be left to the authorized dealer or another trained professional. Improper installation may cause water leakage, electrical shock, fire, or equipment damage.
- Install the air conditioner according to the instructions given in this manual. Incomplete installation may cause water leakage, electrical shock, fire or equipment damage.
- Be sure to use the supplied or exact specified installation parts. Use of other parts may cause the unit to come to fall, water leakage, electrical shock, fire or equipment damage.
- Install the air conditioner on a solid base that is level and can support the weight of the unit. An inadequate base or incomplete installation may cause injury or equipment damage in the event the unit falls off the base or comes loose.
- Electrical work shall be carried out in accordance with the installation manual and the national, state and local electrical wiring codes. Insufficient capacity or incomplete electrical work may cause electrical shock, fire or equipment damage.
- Be sure to use a dedicated power circuit. Never use a power supply shared by another appliance. Follow all appropriate electrical codes.
- For wiring, use a wire or cable long enough to cover the entire distance with no splices if possible. Do not use an extension cord. Do not put other loads on the power supply. Use only a separate dedicated power circuit. (Failure to do so may cause abnormal heat, electric shock, fire or equipment damage.)
- Use the specified types of wires for electrical connections between the indoor and outdoor units. Follow all state and local electrical codes. Firmly clamp the inter-unit wire so their terminals receive no external stresses. Incomplete connections or clamping may cause terminal overheating, fire or equipment damage.
- After connecting all wires be sure to shape the cables so that they do not put undue stress on the electrical covers, panels or terminals. Install covers over the wires. Incomplete cover installation may cause terminal overheating, electrical shock, fire or equipment damage.
- When installing or relocating the system, be sure to keep the refrigerant circuit free from all substances other than the specified refrigerant (R410A), such as air. (Any presence of air or other foreign substance in the refrigerant circuit causes an abnormal pressure rise which may result in rupture, resulting in injury.)
- During pump down, stop the compressor before removing the refrigerant piping. If the compressor is still running and the stop valve is open during pump down, air will be sucked in when the refrigerant piping is removed, causing abnormally high pressure which could lead to equipment damage or and personal injury.
- During installation, attach the refrigerant piping securely before running the compressor. If the refrigerant pipes are not attached and the stop valve is open during installation, air will be sucked in when the compressor is run, causing abnormally high pressure which could lead to equipment damage and personal injury.
- Be sure to install a ground fault circuit interrupter. Failure to install a ground fault circuit interrupter may result in electrically shocks, or fire personal injury.

CAUTION

- Do not install the air conditioner where gas leakage would be exposed to open flames. If the gas leaks and builds up around the unit, it may catch fire.
- Establish drain piping according to the instructions of this manual. Inadequate piping may cause water damage.
- Tighten the flare nut according to the specified torque. A torque wrench should be used. If the flare nut is tightened too much, the flare nut may crack over time and cause refrigerant leakage.
- Do not touch the heat exchanger fins. Improper handling may result in injury.
- Be very careful about product transportation. Some products use PP bands for packaging. Do not use any PP bands for a means of transportation. It is dangerous.
- Electrical work must be performed in accordance with the NEC/CEC by authorized personnel only.

Accessories

Ⓐ Mounting plate	1	Ⓑ Mounting plate fixing screw 3/16" × 1" (M4 × 25mm)	7	Ⓒ Titanium apatite photocatalytic air-purifying filter ^{*1*2}	2
Ⓓ Wireless remote controller	1	Ⓔ Remote controller holder	1	Ⓕ Fixing screw for remote controller holder 1/8" × 13/16" (M3 × 20mm)	2
Ⓖ Dry battery AAA. LR03(alkaline)	2	Ⓗ Indoor unit fixing screw 3/16" × 1/2" (M4 × 12mm)	2	Ⓖ Insulation tape	1
Ⓚ Operation manual	1	Ⓛ Installation manual	1		

1 Only for FTX(K)09/12/18/24

*2 09/12 class: without frame
18/24 class: with frame

Choosing an Installation Site

Before choosing the installation site, obtain user approval.

1. Indoor unit

The indoor unit should be positioned in a place where:

- 1) the restrictions on the installation requirements specified in "Indoor unit installation drawings" on page 4 are met,
- 2) both the air inlet and air outlet are unobstructed,
- 3) the unit is not exposed to direct sunlight,
- 4) the unit is away from sources of heat or steam,
- 5) there is no source of machine oil vapour (this may shorten the indoor unit service life),
- 6) cool/warm air is circulated throughout the room,
- 7) the unit is away from electronic ignition type fluorescent lamps (inverter or rapid start type) as they may affect the remote controller range,
- 8) the unit is at least 3.3ft (1m) away from any television or radio set (the unit may cause interference with the picture or sound),
- 9) no laundry equipment is nearby.

2. Wireless remote controller

Turn on all the fluorescent lamps in the room, if any, and find a location where the remote controller signals are properly received by the indoor unit (within 23ft (7m)).

Indoor Unit Installation Drawings

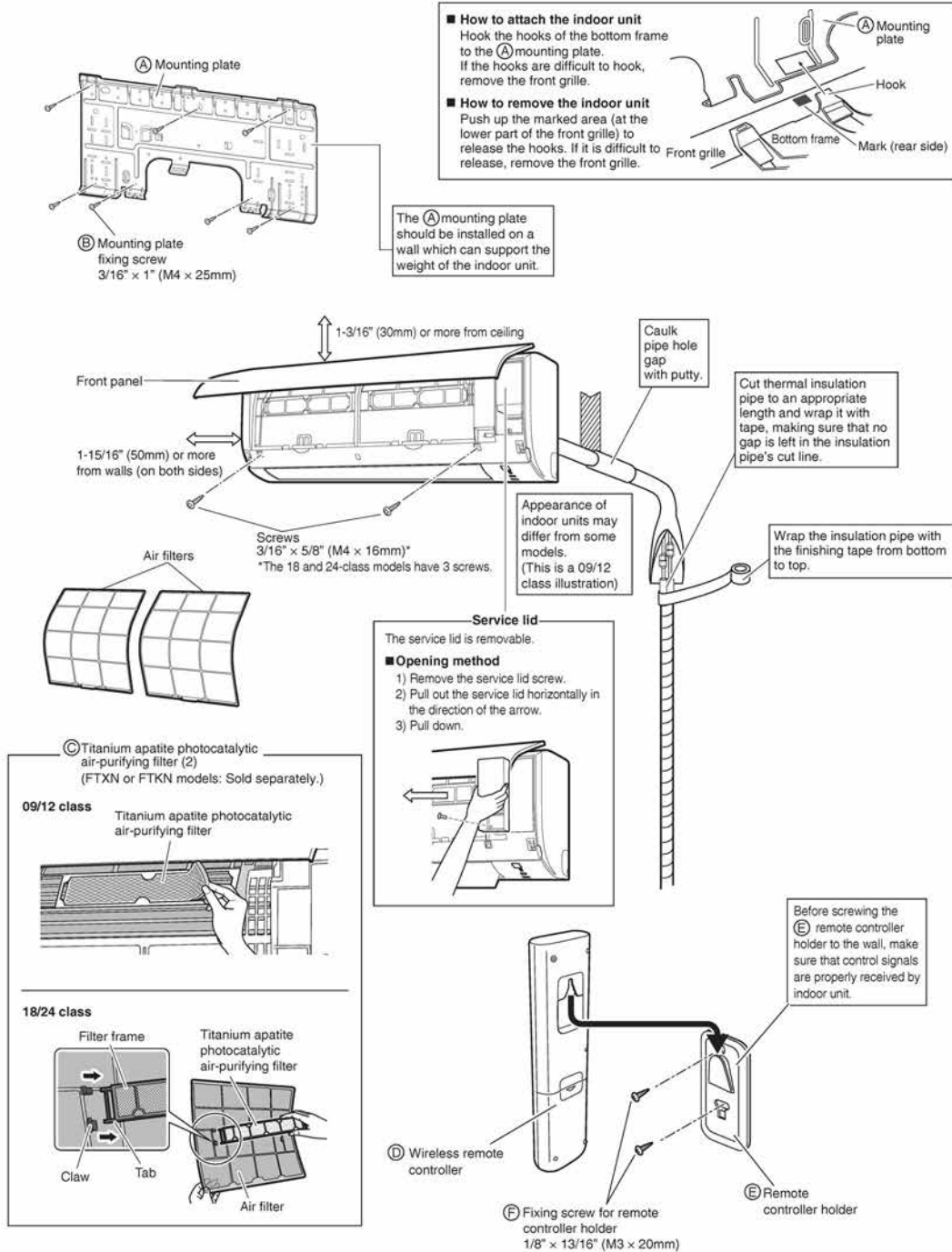

Indoor Unit Installation

1. Installing the mounting plate

- The mounting plate should be installed on a wall which can support the weight of the indoor unit.
 - Temporarily secure the mounting plate to the wall, make sure that the panel is completely level, and mark the drilling points on the wall.
 - Secure the mounting plate to the wall with screws.

Recommended mounting plate retention spots and dimensions

09/12 class

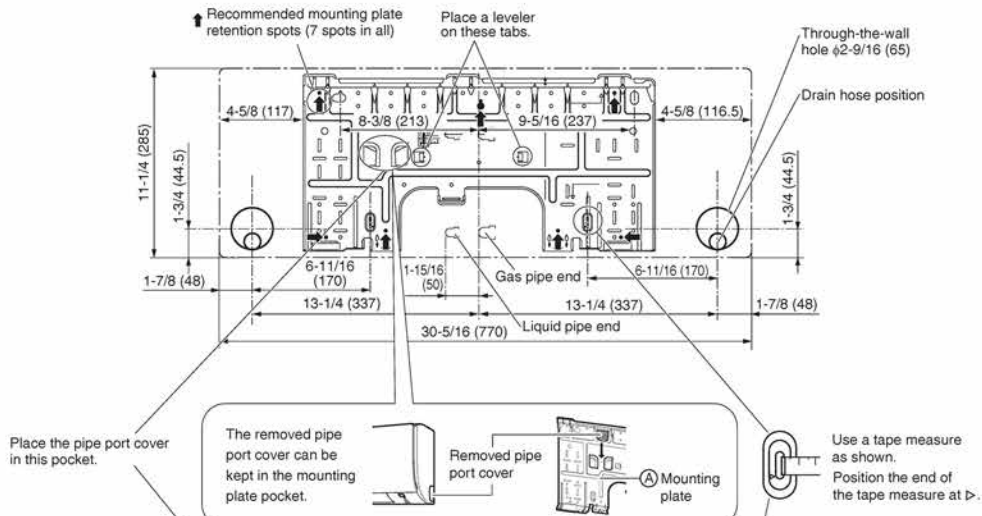

18/24 class

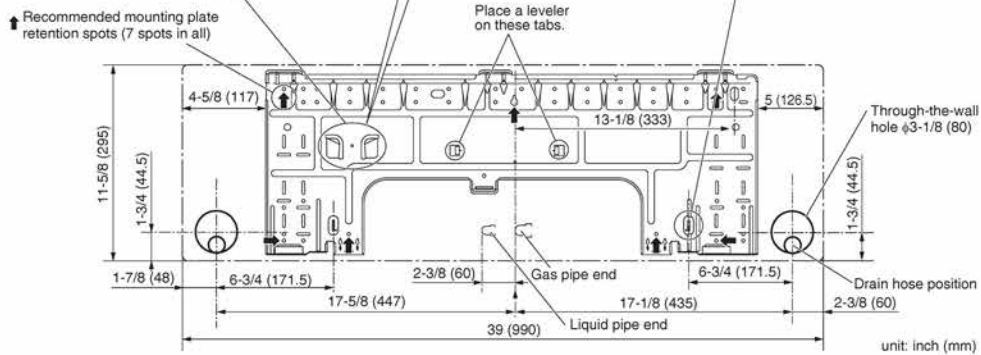

2. Drilling a wall hole and installing wall embedded pipe

- For metal frame or metal board walls, be sure to use a wall embedded pipe and wall hole cover in the feed-through hole to prevent possible heat, electrical shock, or fire.
 - Be sure to caulk the gaps around the pipes with caulking material to prevent water leakage.
- 1) Drill a feed-through hole with a $\phi 2\text{-}9/16$ inch (65mm) (for 09/12 class), $\phi 3\text{-}1/8$ inch (80mm) (for 18/24 class) diameter through the wall at a downward angle toward the outside.
 - 2) Insert a wall embedded pipe into the hole.
 - 3) Insert a wall hole cover into wall pipe.
 - 4) After completing refrigerant piping, wiring, and drain piping, caulk the pipe hole gap with putty.

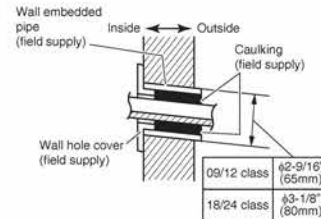

3. Installing the indoor unit

In the case of bending or curing refrigerant pipes, keep the following precautions in mind.
Abnormal sound may be generated if improper work is conducted.

- Do not strongly press the refrigerant pipes onto the bottom frame.
- Do not strongly press the refrigerant pipes on the front grille, either.

3-1. Right-side, right-back, or right-bottom piping

- 1) Attach the drain hose to the underside of the refrigerant pipes with adhesive vinyl tape.
- 2) Wrap the refrigerant pipes and drain hose together with U insulation tape.

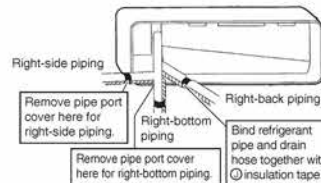

- 3) Pass the drain hose and refrigerant pipes through the wall hole, then set the indoor unit on the A mounting plate hooks by using the Δ markings at the top of the indoor unit as a guide.

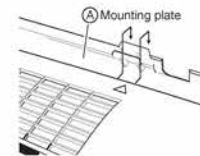

- 4) Open the front panel (Refer to "Installation Tips" on page 10), then open the service lid (Refer to "Indoor Unit Installation Drawings" on page 4).
- 5) Pass the inter-unit wire from the outdoor unit through the feed-through wall hole and pass to the front of indoor unit from the back. Then pull them at front side. Bend the ends of cable tie wires upward for easier work in advance.
- 6) Press the bottom frame of the indoor unit with both hands to set it on the A mounting plate hooks. Make sure the wire leads do not catch on the edge of the indoor unit.

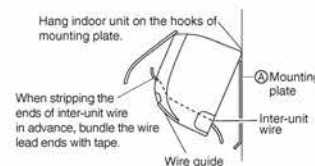

Indoor Unit Installation

3-2. Left-side, left-back, or left-bottom piping

How to replace the drain plug and drain hose

• Replacing onto the left side

- 1) Remove the fixing screw of drain hose on the right and remove the drain hose.
- 2) Remove the drain plug on the left side and attach it to the right side.
- 3) Insert the drain hose and tighten with the included fixing screw.
Forgetting to tighten this may cause water leakages.

Drain hose attachment position

The drain hose is on the back of the unit.

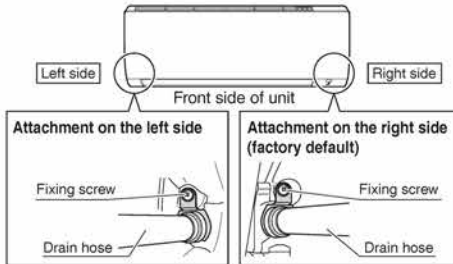

- 1) Attach the drain hose to the underside of the refrigerant pipes with adhesive vinyl tape.

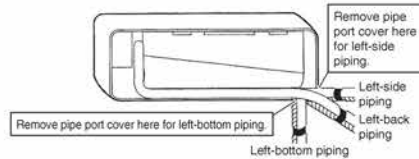

- 2) Be sure to connect the drain plug to the drain port in place of without drain hose.

How to set the drain plug.

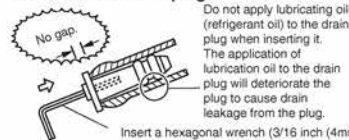

- 3) Shape the refrigerant pipes along the pipe path marking on the (A) mounting plate.
- 4) Pass the drain hose and refrigerant pipes through the wall hole, then position the indoor unit on the (A) mounting plate hooks, using the (B) markings at the top of the indoor unit as a guide.
- 5) Pull in the inter-unit wire.
- 6) Connect the inter-unit pipes.

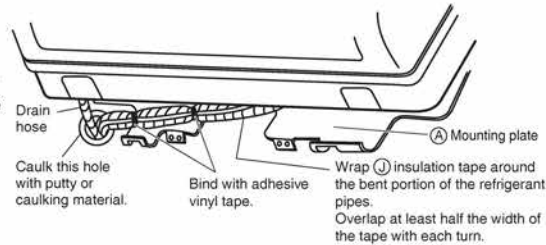

- 7) In case of pulling the drain hose through the back of the indoor unit, wrap the refrigerant pipes and drain hose together with (C) insulation tape as shown in the right figure.
- 8) To confirm that the inter-unit wire does not catch by the indoor unit, press the bottom edge of the indoor unit with both hands until it is firmly caught by the (A) mounting plate hooks. Secure the indoor unit to the mounting plate with the (H) indoor unit fixing screws 3/16" x 1/2" (M4 x 12mm).

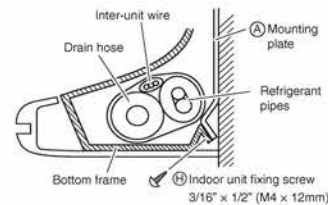

3-3. Wall embedded piping

Follow the instructions given under left-side, left-back, or left-bottom piping.

- 1) Insert the drain hose to this depth so it won't be pulled out of the drain pipe.

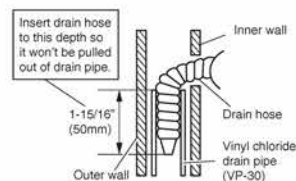

4. Wiring

- 1) As shown in the illustration, insert the wires including the ground wire into the conduit and secure them with lock nut onto the conduit mounting plate.
- 2) Strip wire ends (3/4 inch (20mm)).
- 3) Match wire colours with terminal numbers on the terminal block of indoor and outdoor unit and firmly secure the wires in the corresponding terminals with screws.
- 4) Connect the ground wire to the corresponding terminals.
- 5) Pull the wires lightly to make sure they are securely connected.
- 6) While close the service lid, shape the wires so that the service lid fits securely, then close the service lid.

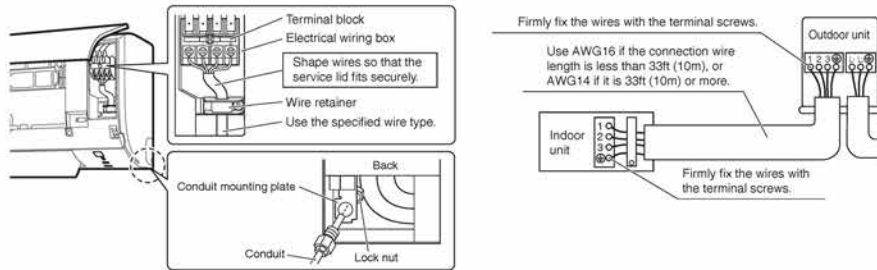

⚠ WARNING

- Do not use tapped wires, extension cords, or starburst connections, as they may cause overheating, electrical shock, or fire.
- Do not use locally purchased electrical parts inside the product. (Do not branch the power for the drain pump, etc., from the terminal block.) Doing so may cause electric shock or fire.
- Do not connect the power wire to the indoor unit. Doing so may cause electric shock or fire.

5. Drain piping

- 1) Connect the drain hose, as described on the right.
- 2) Remove the air filters and pour some water into the drain pan to check the water flows smoothly.
- 3) If drain hose extension or embedded drain piping is required, use appropriate parts that match the hose front end.
- 4) When extending the drain hose, use a commercially available extension hose with an inner diameter of 5/8 inch (16mm). Be sure to thermally insulate the indoor section of the extension hose.

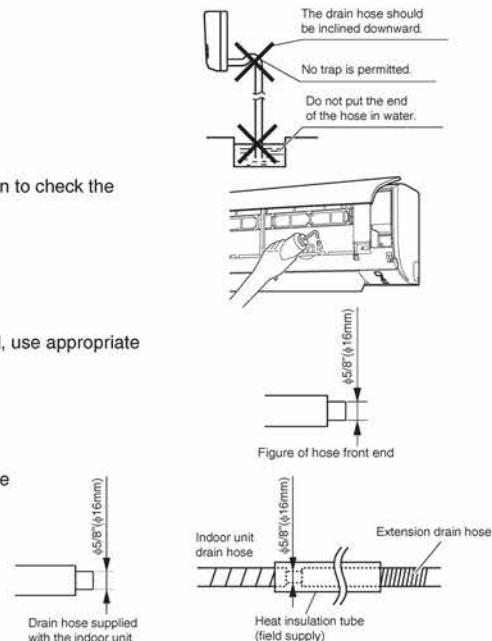

Refrigerant Piping Work

1. Flaring the pipe end

- 1) Cut the pipe end with a pipe cutter.
- 2) Remove burrs with the cut surface facing downward so that the chips do not enter the pipe.
- 3) Put the flare nut on the pipe.
- 4) Flare the pipe.
- 5) Check that the flaring is properly made.



Cut exactly at right angles. Remove burrs.

Flaring

Set exactly at the position shown below.

A	Flare tool for R410A		Conventional flare tool	
	Clutch-type	Clutch-type (Rigid-type)	Clutch-type (Rigid-type)	Wing-nut type (Imperial-type)
	0-0.020 inch (0-0.5mm)	0.039-0.059 inch (1.0-1.5mm)	0.039-0.059 inch (1.0-1.5mm)	0.059-0.079 inch (1.5-2.0mm)

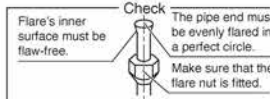

Check
Flare's inner surface must be flaw-free. The pipe end must be evenly flared in a perfect circle. Make sure that the flare nut is fitted.

⚠ WARNING

- Do not use mineral oil on flared part.
- Prevent mineral oil from getting into the system as this would reduce the lifetime of the units.
- Never use piping which has been used for previous installations. Only use parts which are delivered with the unit.
- Never install a drier to this R410A unit in order to guarantee its lifetime.
- The drying material may dissolve and damage the system.
- Incomplete flaring may cause refrigerant gas leakage.

2. Refrigerant piping

⚠ CAUTION

- Use the flare nut fixed to the main unit. (This is to prevent cracking of the flare nut as a result of deterioration over time.)
 - To prevent gas leakage, apply refrigeration oil only to the inner surface of the flare. (Use refrigeration oil for R410A.)
 - Use a torque wrench when tightening the flare nuts to prevent damage to the flare nuts and gas leakage.
- Align the centers of both flares and tighten the flare nuts 3 or 4 turns by hand. Then tighten them fully with a spanner and a torque wrench.

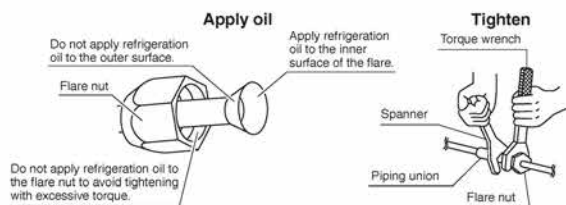

Apply oil
Do not apply refrigeration oil to the outer surface.
Apply refrigeration oil to the inner surface of the flare.
Do not apply refrigeration oil to the flare nut to avoid tightening with excessive torque.

Tighten
Torque wrench
Spanner
Piping union
Flare nut

Flare nut tightening torque			
Gas side		Liquid side	
3/8 inch (9.5mm)	1/2 inch (12.7mm)	5/8 inch (15.9mm)	1/4 inch (6.4mm)
24-1/8 - 29-1/2ft • lbf (32.7-39.9N • m)	36-1/2 - 44-1/2ft • lbf (49.5-60.3N • m)	45-5/8 - 55-5/8ft • lbf (61.8-75.4N • m)	10-1/2 - 12-3/4ft • lbf (14.2-17.2 N • m)

2-1. Caution on piping handling

- Protect the open end of the pipe against dust and moisture.
- All pipe bends should be as gentle as possible. Use a pipe bender for bending.



2-2. Selection of copper and heat insulation materials

When using commercial copper pipes and fittings, observe the following:

- Insulation material: Polyethylene foam
Heat transfer rate: 0.041 to 0.052W/mK (0.024 to 0.030Btu/fth°F (0.035 to 0.045kcal/mh°C))
Be sure to use insulation that is designed for use with HVAC Systems.
- ACR Copper only.

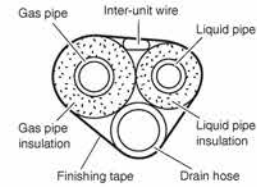

- Be sure to insulate both the gas and liquid piping and observe the insulation dimensions as below.

	Piping size	Minimum bend radius	Piping thickness	Thermal insulation size	Thermal insulation thickness
Gas side	O.D. 3/8 inch (9.5mm)	1-3/16 inch (30mm) or more	0.031 inch (0.8mm) (C1220T-O)	I.D. 15/32-19/32 inch (12-15mm)	13/32 inch (10mm) Min.
	O.D. 1/2 inch (12.7mm)	1-9/16 inch (40mm) or more		I.D. 9/16-5/8 inch (14-16mm)	
	O.D. 5/8 inch (15.9mm)	1-15/16 inch (50mm) or more	0.039 inch (1.0mm) (C1220T-O)	I.D. 5/8-13/16 inch (16-20mm)	
Liquid side	O.D. 1/4 inch (6.4mm)	1-3/16 inch (30mm) or more	0.031 inch (0.8mm) (C1220T-O)	I.D. 5/16-13/32 inch (8-10mm)	

- Use separate thermal insulation pipes for gas and liquid refrigerant pipes.

Installation Tips

1. Removing and installing the front panel

• Removal method

- 1) Place your fingers in the indentations on the main unit (one each on the left and right sides), and open the front panel until it stops.
- 2) While pushing the left side front panel shaft outward, push up the front panel and remove it. (Remove the right side front panel shaft in the same manner.)
- 3) After removing both front panel shafts, pull the front panel toward yourself and remove it.

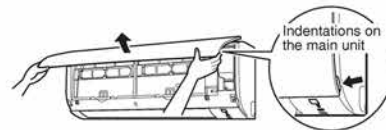

• Installation method

Align the shaft of the front panel with the grooves of grill, and push all the way in. Then close slowly. Push the center of the lower panel surface firmly to engage the hooks.

2. Removing and installing the front grille

• **Removal method**

- 1) Remove the front panel to remove the air filter.
- 2) Remove the 2 screws from the front grille.
(The 18 and 24-class models have 3 screws.)
- 3) In front of the ○○○ mark on the front grille, there are 3 upper hooks. Lightly pull the front grille toward you with one hand, and push down on the hooks with the fingers of your other hand.

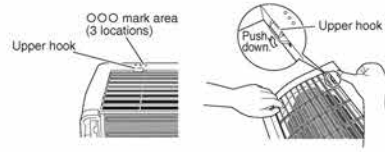

When there is insufficient work space because the unit is close to ceiling

CAUTION

- Be sure to wear protection gloves.

Place both hands under the center of the front grille, and while pushing up, pull it toward you.

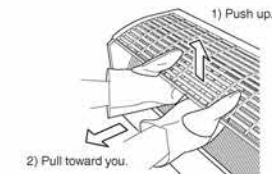

• **Installation method**

- 1) Install the front grille and firmly engage the upper hooks (3 locations).
- 2) Install 2 screws of the front grille.
(The 18 and 24-class models have 3 screws.)
- 3) Install the air filter and then mount the front panel.

3. How to set the different addresses

When 2 indoor units are installed in one room, the 2 wireless remote controllers can be set for different addresses. Change the address setting of one of the two units. When cutting the jumper be careful not to damage any of the surrounding parts.

- 1) Remove the battery cover on the remote controller and cut the address jumper.
- 2) Press **TEMP 7/°C**, **TEMP 7/°C** and **OFF** at the same time.
- 3) Press **TEMP 7/°C**, then select **R**, press **FAN**.
(The indoor unit OPERATION lamp will blink for about 1 minute.)
- 4) Press the indoor unit ON/OFF switch while the OPERATION lamp is blinking.



Jumper	ADDRESS
EXIST	1
CUT	2



- If setting could not be carried out completely while the OPERATION lamp was blinking, carry out the setting process once again from the beginning.
- After setting is complete, pressing **FAN** for about 5 seconds will cause the remote controller to return to the previous display.

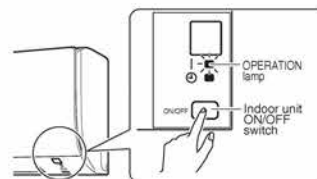

Trial Operation and Testing

1. Trial operation and testing

- Trial operation should be carried out in either COOL or HEAT operation.

1-1. Measure the supply voltage and make sure that it is within the specified range.

1-2. In COOL operation, select the lowest programmable temperature; in HEAT operation, select the highest programmable temperature.



1-3. Carry out the trial operation in accordance with the operation manual to ensure that all functions and parts, such as flap movement, are working properly.

- For protection, the system disables restart operation for 3 minutes after it is turned off.

1-4. After trial operation is complete, set the temperature to a normal level (78°F to 82°F (26°C to 28°C) in COOL operation, 68°F to 75°F (20°C to 24°C) in HEAT operation).

- When operating the air conditioner in COOL operation in winter, or HEAT operation in summer, set it to the trial operation mode using the following method.

1) Press ,  and  at the same time.

2) Press , then select , press .

3) Press  or  to turn on the system.

- Trial operation will stop automatically after about 30 minutes.

To stop the operation, press .

- Some of the functions cannot be used in the trial operation mode.



HEAT PUMP model



COOLING ONLY model

- The air conditioner draws a small amount of power in its standby mode. If the system is not to be used for some time after installation, shut off the circuit breaker to eliminate unnecessary power consumption.
- If the circuit breaker trips to shut off the power to the air conditioner, the system will restore the original operation mode when the circuit breaker is opened again.

2. Test items

Test items	Symptom	Check
Indoor and outdoor units are installed properly on solid bases.	Fall, vibration, noise	
No refrigerant gas leaks.	Incomplete cooling/heating function	
Refrigerant gas and liquid pipes and indoor drain hose extension are thermally insulated.	Water leakage	
Draining line is properly installed.	Water leakage	
System is properly grounded.	Electrical leakage	
The specified wires are used for inter-unit wiring.	No operation or burn damage	
Indoor or outdoor unit's air inlet or air outlet are unobstructed.	Incomplete cooling/heating function	
Stop valves are opened.	Incomplete cooling/heating function	
Indoor unit properly receives remote control commands.	No operation	

11.2 Outdoor Unit

Contents

Safety Considerations	1	4. Refrigerant piping	6
Accessories	3	5. Pressure test and evacuating system.....	7
Precautions for Selecting the Location	3	6. Refilling refrigerant	8
Precautions on Installation	4	7. Refrigerant piping work	8
Outdoor Unit Installation Drawings	4	Wiring	9
Installation Guidelines	5	Facility Setting	
Outdoor Unit Installation	5	(cooling at low outdoor temperature)	11
1. Installing the outdoor unit	5	Pump Down Operation	11
2. Drain work (only for heat pump models).....	6	Trial Operation and Testing	12
3. Flaring the pipe end.....	6	1. Trial operation and testing	12
		2. Test items	12

Safety Considerations

- Read these **Safety Considerations** carefully to ensure correct installation.
 - This manual classifies the precautions into **DANGER**, **WARNING** and **CAUTION**. Be sure to follow all the precautions below: they are all important for ensuring safety.
- ⚠ DANGER** Indicates an imminently hazardous situation which, if not avoided, will result in death or serious injury.
- ⚠ WARNING** Failure to follow any of **WARNING** is likely to result in such grave consequences as death or serious injury.
- ⚠ CAUTION** Failure to follow any of **CAUTION** may in some cases result in grave consequences.
- After completing installation, test the unit to check for installation errors. Give the user adequate instructions concerning the use and cleaning of the unit according to the Operation Manual.

- ⚠ DANGER**
- Refrigerant gas is heavier than air and replaces oxygen. A massive leak could lead to oxygen depletion, especially in basements, and an asphyxiation hazard could occur leading to serious injury or death.
 - If the refrigerant gas leaks during installation, ventilate the area immediately.

- Refrigerant gas may produce a toxic gas if it comes in contact with fire such as from a fan heater, stove or cooking device. Exposure to this gas could cause severe injury or death.
- After completing the installation work, check that the refrigerant gas does not leak. Refrigerant gas may produce a toxic gas if it comes in contact with fire such as from a fan heater, stove or cooking device. Exposure to this gas could cause severe injury or death.
 - Do not ground units to water pipes, telephone wires or lightning rods because incomplete grounding could cause a severe shock hazard resulting in severe injury or death, and to gas pipes because a gas leak could result in an explosion which could lead to severe injury or death.
 - Safely dispose of the packing materials. Packing materials, such as nails and other metal or wooden parts, may cause stabs or other injuries. Tear apart and throw away plastic packaging bags so that children will not play with them. Children playing with plastic bags face the danger of death by suffocation.
 - Do not install unit in an area where flammable materials are present due to risk of explosion resulting in serious injury or death.
 - Do not ground units to telephone wires or lightning rods because lightning strikes could cause a severe shock hazard resulting in severe injury or death, and to gas pipes because a gas leak could result in an explosion which could lead to severe injury or death.

WARNING

- Installation shall be left to the authorized dealer or another trained professional.
Improper installation may cause water leakage, electrical shock, fire, or equipment damage.
- Install the air conditioner according to the instructions given in this manual.
Incomplete installation may cause water leakage, electrical shock, fire or equipment damage.
- Be sure to use the supplied or exact specified installation parts. Use of other parts may cause the unit to come to fall, water leakage, electrical shock, fire or equipment damage.
- Install the air conditioner on a solid base that is level and can support the weight of the unit.
An inadequate base or incomplete installation may cause injury or equipment damage in the event the unit falls off the base or comes loose.
- Electrical work shall be carried out in accordance with the installation manual and the national, state and local electrical wiring codes.
Insufficient capacity or incomplete electrical work may cause electrical shock, fire or equipment damage.
- Be sure to use a dedicated power circuit. Never use a power supply shared by another appliance.
Follow all appropriate electrical codes.
- For wiring, use a wire or cable long enough to cover the entire distance with no splices if possible.
Do not use an extension cord. Do not put other loads on the power supply.
Use only a separate dedicated power circuit.
(Failure to do so may cause abnormal heat, electric shock, fire or equipment damage.)
- Use the specified types of wires for electrical connections between the indoor and outdoor units.
Follow all state and local electrical codes.
Firmly clamp the inter-unit wire so their terminals receive no external stresses.
Incomplete connections or clamping may cause terminal overheating, fire or equipment damage.
- After connecting all wires be sure to shape the cables so that they do not put undue stress on the electrical covers, panels or terminals.
Install covers over the wires. Incomplete cover installation may cause terminal overheating, electrical shock, fire or equipment damage.
- When installing or relocating the system, be sure to keep the refrigerant circuit free from all substances other than the specified refrigerant (R410A), such as air.
(Any presence of air or other foreign substance in the refrigerant circuit causes an abnormal pressure rise which may result in rupture, resulting in injury.)
- During pump down, stop the compressor before removing the refrigerant piping.
If the compressor is still running and the stop valve is open during pump down, air will be sucked in when the refrigerant piping is removed, causing abnormally high

pressure which could lead to equipment damage or and personal injury.



- During installation, attach the refrigerant piping securely before running the compressor.
If the refrigerant pipes are not attached and the stop valve is open during installation, air will be sucked in when the compressor is run, causing abnormally high pressure which could lead to equipment damage and personal injury.
- Be sure to install a ground fault circuit interrupter.
Failure to install a ground fault circuit interrupter may result in electrically shocks, or fire personal injury.

CAUTION

- Do not install the air conditioner where gas leakage would be exposed to open flames.
If the gas leaks and builds up around the unit, it may catch fire.
- Establish drain piping according to the instructions of this manual.
Inadequate piping may cause water damage.
- Tighten the flare nut according to the specified torque. A torque wrench should be used.
If the flare nut is tightened too much, the flare nut may crack over time and cause refrigerant leakage.
- Do not touch the heat exchanger fins.
Improper handling may result in injury.
- Be very careful about product transportation.
Some products use PP bands for packaging. Do not use any PP bands for a means of transportation. It is dangerous.
- Make sure to provide for adequate measures in order to prevent that the outdoor unit be used as a shelter by small animals.
Small animals making contact with electrical parts can cause malfunctions, smoke or fire. Please instruct the customer to keep the area around the unit clean.
- The temperature of refrigerant circuit will be high, please keep the inter-unit wire away from copper pipes that are not thermally insulated.
- Electrical work must be performed in accordance with the NEC/CEC by authorized personnel only.

Accessories

Accessories supplied with the outdoor unit:

(A) Installation manual		1	(B) Drain socket*  It is on the bottom packing case.		1
(C) Drain cap (1)* 	09/12 class	4	(D) Drain cap (2)* 	09/12 class	2
	18/24 class	6		18/24 class	3

*Only for heat pump models.

Precautions for Selecting the Location

- 1) Choose a place solid enough to bear the weight and vibration of the unit, where the operating sound will not be amplified.
- 2) Choose a location where the hot air discharged from the unit or the operating sound will not cause a nuisance to the neighbours of the user.
- 3) Avoid places near a bedroom and the like, so that the operating sound will cause no trouble.
- 4) There must be sufficient spaces for carrying the unit into and out of the site.
- 5) There must be sufficient space for air passage and no obstructions around the air inlet and the air outlet.
- 6) The site must be free from the possibility of flammable gas leakage in a nearby place.
- 7) Install units, power cords and inter-unit wire at least 10ft (3m) away from television and radio sets. (This is to prevent interference to images and sounds. Noise may be experienced even if they are more than 10ft (3m) away depending on radio wave conditions.)
- 8) In coastal areas or other places with a salty atmosphere or one containing sulphate gas, corrosion may shorten the life of the air conditioner.
- 9) Since water will flow from the drain of the outdoor unit, do not place under the unit anything which must be kept away from moisture.

NOTE

Cannot be installed suspended from ceiling or stacked.

⚠ CAUTION

When operating the air conditioner in a low outdoor ambient temperature, be sure to follow the instructions described below.

- To prevent exposure to wind, install the outdoor unit with its suction side facing the wall.
- Never install the outdoor unit at a site where the suction side may be exposed directly to wind.
- To prevent exposure to wind, it is recommended to install a baffle plate on the air discharge side of the outdoor unit.
- In heavy snowfall areas, select an installation site where the snow will not affect the unit.

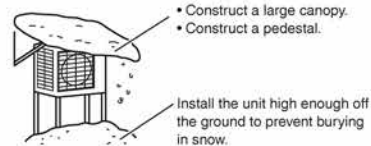

Precautions on Installation

- Check the strength and level of the installation surface so that the unit does not cause any operating vibration or noise after installation.
- In accordance with the foundation drawing, fix the unit securely by means of the foundation bolts. (Prepare 4 sets of M8 or M10 foundation bolts, nuts and washers; all separately available.)
- It is best to screw in the foundation bolts until their ends are 3/4 inch (20mm) from the foundation surface.

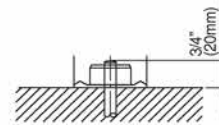

Outdoor Unit Installation Drawings

	RX09/12* RK09/12*	RXN09/12* RKN09/12*	RX18*, RXN18* RK18*, RKN18*	RX24*, RXN24* RK24*, RKN24*
Max. allowable piping length	65-5/8ft (20m)	49-1/4ft (15m)	98-1/2ft (30m)	
Min. allowable piping length	10ft (3m)			
Max. allowable piping height	49-1/4ft (15m)	39-3/8ft (12m)	65-5/8ft (20m)	
Additional refrigerant required for refrigerant pipe exceeding 32.8ft (10m) in length.	0.21oz/ft (20g/m)			
Gas pipe	O.D. 3/8 inch (9.5mm)	O.D. 1/2 inch (12.7mm)	O.D. 5/8 inch (15.9mm)	
Liquid pipe	O.D. 1/4 inch (6.4mm)			

*Be sure to add the proper amount of additional refrigerant. Failure to do so may result in reduced performance.
 **The suggested shortest pipe length is 10ft (3m), in order to avoid noise from the outdoor unit and vibration.
 (Mechanical noise and vibration may occur depending on how the unit is installed and the environment in which it is used.)

Wrap the insulation pipe with finishing tape from bottom to top.

CAUTION
 Keep the piping length between 10ft (3m) and 65-5/8ft (20m) (for RX09/12, RK09/12), 10ft (3m) and 49-1/4ft (15m) (for RXN09/12, RKN09/12), 10ft (3m) and 98-1/2ft (30m) (for 18/24 class).

Stop valve cover
How to remove the stop valve cover
 1) Remove the screw on the stop valve cover.
 2) Slide the stop valve cover downward to remove it.
How to attach the stop valve cover
 1) Insert the upper part of the stop valve cover into the outdoor unit.
 2) Tighten the screw.

Allow 11-13/16" (300mm) of work space below the ceiling surface.

	X	Y	Z
09/12 class	18-1/2 inch (470mm)	12-1/8 inch (309mm)	3-13/16 inch (97mm)
18/24 class	23-5/8 inch (600mm)	13-5/8 inch (345mm)	4-15/16 inch (123mm)

In sites with poor drainage, use block bases for the outdoor unit. Adjust foot height until the unit is level. Otherwise, water leakage or pooling of water may occur.

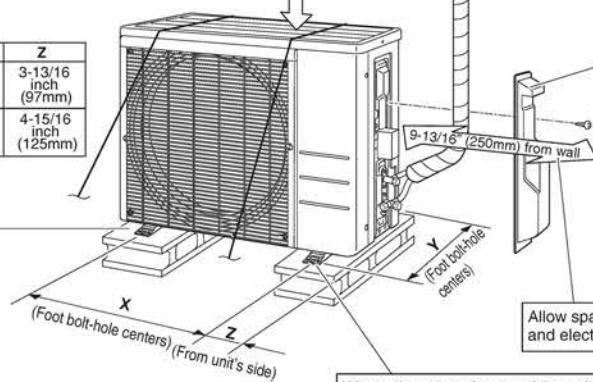

Where there is a danger of the unit falling, use foot bolts, or wires.

Appearance of outdoor units may differ from some models.

Installation Guidelines

- Where a wall or other obstacle is in the path of the outdoor unit's intake or exhaust airflow, follow the installation guidelines below.
- For any of the below installation patterns, the wall height on the outlet side should be 47-1/4 inch (1200mm) or less.

09/12 class

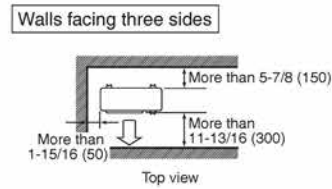
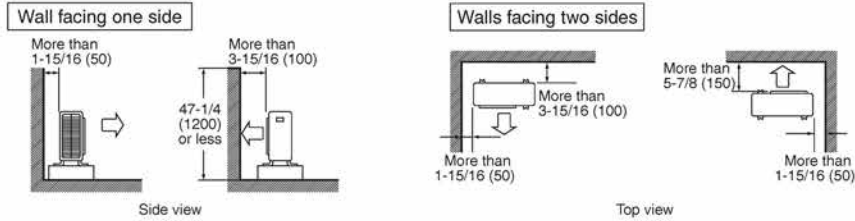

unit: inch (mm)

18/24 class

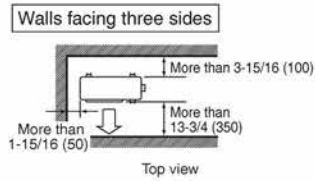
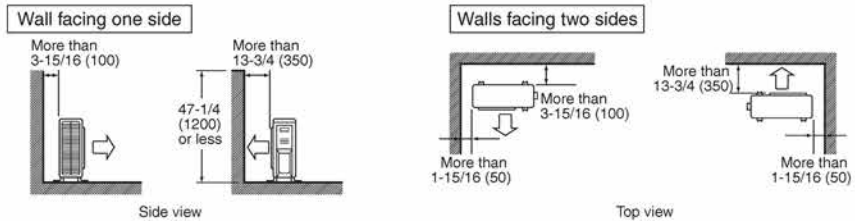

unit: inch (mm)

Outdoor Unit Installation

1. Installing the outdoor unit

- 1) When installing the outdoor unit, refer to "Precautions for Selecting the Location" and the "Outdoor Unit Installation Drawings".
- 2) If drain work is necessary, follow the procedures below.

2. Drain work (only for heat pump models)

- If the drain port is covered by a mounting base or floor surface, place additional foot bases of at least 1-1/4 inch (30mm) in height under the outdoor unit's feet.
- In cold areas, do not use a drain socket, drain caps (1,2) and a drain hose with the outdoor unit. (Otherwise, the drain water may freeze, impairing heating performance.)

- 1) Attach ③ drain cap (1) and ④ drain cap (2).
- 2) Attach ⑤ drain socket.

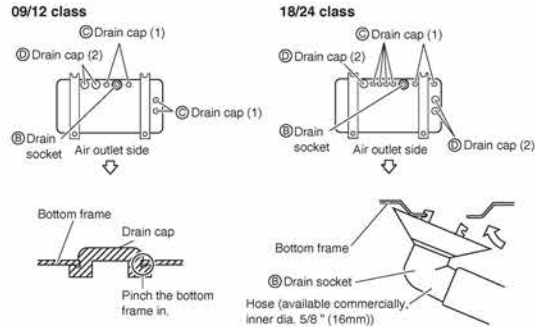

3. Flaring the pipe end

- 1) Cut the pipe end with a pipe cutter.
- 2) Remove burrs with the cut surface facing downward so that the chips do not enter the pipe.
- 3) Put the flare nut on the pipe.
- 4) Flare the pipe.
- 5) Check that the flaring is properly made.

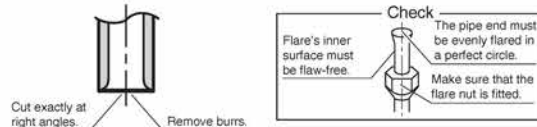

Flaring

Set exactly at the position shown below.			
Die	Flare tool for R410A		Conventional flare tool
	Clutch-type	Clutch-type (Rigid-type)	Wing-nut type (Imperial-type)
A	0-0.020 inch (0-0.5mm)	0.039-0.059 inch (1.0-1.5mm)	0.059-0.079 inch (1.5-2.0mm)

⚠ WARNING

- Do not use mineral oil on flared part.
- Prevent mineral oil from getting into the system as this would reduce the lifetime of the units.
- Never use piping which has been used for previous installations. Only use parts which are delivered with the unit.
- Never install a drier to this R410A unit in order to guarantee its lifetime.
- The drying material may dissolve and damage the system.
- Incomplete flaring may cause refrigerant gas leakage.

4. Refrigerant piping

⚠ CAUTION

- Use the flare nut fixed to the main unit. (This is to prevent cracking of the flare nut as a result of deterioration over time.)
 - To prevent gas leakage, apply refrigeration oil only to the inner surface of the flare. (Use refrigeration oil for R410A.)
 - Use a torque wrench when tightening the flare nuts to prevent damage to the flare nuts and gas leakage.
- Align the centers of both flares and tighten the flare nuts 3 or 4 turns by hand. Then tighten them fully with a spanner and a torque wrench.

Flare nut tightening torque			
Gas side		Liquid side	
3/8 inch (9.5mm)	1/2 inch (12.7mm)	5/8 inch (15.9mm)	1/4 inch (6.4mm)
24-1/8 - 29-1/2ft • lbf (32.7-39.9N • m)	36-1/2 - 44-1/2ft • lbf (49.5-60.3N • m)	45-5/8 - 55-5/8ft • lbf (61.8-75.4N • m)	10-1/2 - 12-3/4ft • lbf (14.2-17.2 N • m)
Width across flats	11/16 inch (17mm)	3/4 inch (19mm)	7/8 inch (22mm)
Valve cap tightening torque	10-1/2 - 12-5/8ft • lbf (14.2-17.2N • m)	12-5/8 - 15-3/8ft • lbf (17.1-20.9N • m)	16 - 20-1/4ft • lbf (21.6-27.4N • m)
	35-3/8 - 44-1/8ft • lbf (48-59.8N • m)		
Service port cap tightening torque			
8 - 10-7/8ft • lbf (10.8-14.7N • m)			

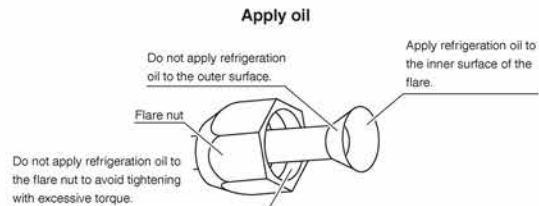

Outdoor Unit Installation

5. Pressure test and evacuating system

⚠ WARNING

- Do not mix any substance other than the specified refrigerant (R410A) into the refrigeration cycle.
- If refrigerant gas leaks should occur, ventilate the room as soon and as much as possible.
- R410A, as well as other refrigerants, should always be recovered and never be released directly into the environment.
- Use a vacuum pump for R410A exclusively. Using the same vacuum pump for different refrigerants may damage the vacuum pump or the unit.

- When piping work is complete, it is necessary to perform a pressure test and evacuate system with a vacuum pump.
- If using additional refrigerant, perform air purging of the refrigerant pipes and indoor unit using a vacuum pump, then charge additional refrigerant.
- Use a hexagonal wrench (3/16 inch (4mm)) to operate the stop valve rod.
- All refrigerant pipe joints should be tightened with a torque wrench to the specified tightening torque.

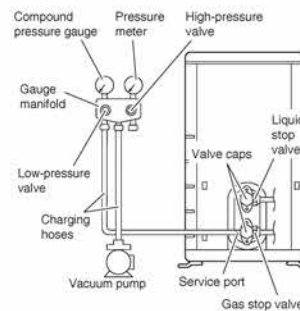

- 1) Pressurize the liquid pipe and gas pipe from the service ports of each stop valve to 550psi (3.8MPa) (do not pressurize more than 550psi (3.8MPa)) for 1 hour minimum, 24 hours recommended. If there is a pressure drop, check for leaks, make repairs and perform the pressure test again.
- 2) Connect projection side of charging hose (which comes from gauge manifold) to gas stop valve's service port.
- 3) Fully open gauge manifold's low-pressure valve (Lo) and completely close its high-pressure valve (Hi).
(High-pressure valve subsequently requires no operation.)
- 4) Evacuate system using vacuum pump to below 500 microns for 1 hour minimum.
- 5) Close gauge manifold's low-pressure valve (Lo) and stop vacuum pump.
(Keep this state for a few minutes to make sure that the compound pressure gauge pointer does not swing back.)*¹
- 6) Remove covers from liquid stop valve and gas stop valve.
- 7) Turn the liquid stop valve's rod 90° counter-clockwise with a hexagonal wrench to open the valve.
Close it after 5 seconds, and check for gas leakage.
Using soapy water, check for gas leakage from indoor unit's flare and outdoor unit's flare and valve rods.
After the check is complete, wipe all soapy water off.
- 8) Disconnect charging hose from gas stop valve's service port, then fully open liquid and gas stop valves.
(Do not attempt to turn valve rod beyond its stop.)
- 9) Tighten valve caps and service port caps for the liquid and gas stop valves with a torque wrench to the specified torques.

*¹ If the compound pressure gauge pointer swings back, refrigerant may have water content or a loose pipe joint may exist. Check all pipe joints and retighten nuts as needed, then repeat steps 3) through 5).

6. Refilling refrigerant

Check the type of refrigerant to be used on the machine nameplate.

Precautions when adding R410A

Fill from the liquid pipe in liquid form.

This is a mixed refrigerant, so adding it in gas form may cause the refrigerant composition to change, preventing normal operation.

- 1) Before filling, check whether the cylinder has a siphon attached or not. (It should have something like "liquid filling siphon attached" displayed on it.)

Filling a cylinder with an attached siphon



Stand the cylinder upright when filling.

(There is a siphon pipe inside, so the cylinder need not be upside-down to fill with liquid.)

Filling other cylinders



Turn the cylinder upside-down when filling.

- Be sure to use the R410A tools to ensure pressure and to prevent foreign objects entering.

7. Refrigerant piping work

7-1. Cautions on pipe handling

- Protect the open end of the pipe against dust and moisture.
- All pipe bends should be as gentle as possible. Use a pipe bender for bending.

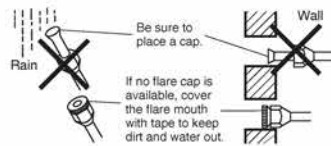

7-2. Selection of copper and heat insulation materials

When using commercial copper pipes and fittings, observe the following:

- Insulation material: Polyethylene foam
Heat transfer rate: 0.041 to 0.052W/mK (0.024 to 0.030Btu/ft^h°F (0.035 to 0.045kcal/mh°C))
Be sure to use insulation that is designed for use with HVAC Systems.
- ACR Copper only.
- Be sure to insulate both the gas and liquid piping and observe the insulation dimensions as below.

	Piping size	Minimum bend radius	Piping thickness	Thermal insulation size	Thermal insulation thickness
Gas side	O.D. 3/8 inch (9.5mm)	1-3/16 inch (30mm) or more	0.031 inch (0.8mm) (C1220T-O)	I.D. 15/32-19/32 inch (12-15mm)	13/32 inch (10mm) Min.
	O.D. 1/2 inch (12.7mm)	1-9/16 inch (40mm) or more		I.D. 9/16-5/8 inch (14-16mm)	
	O.D. 5/8 inch (15.9mm)	1-15/16 inch (50mm) or more	0.039 inch (1.0mm) (C1220T-O)	I.D. 5/8-13/16 inch (16-20mm)	
Liquid side	O.D. 1/4 inch (6.4mm)	1-3/16 inch (30mm) or more	0.031 inch (0.8mm) (C1220T-O)	I.D. 5/16-13/32 inch (8-10mm)	

- Use separate thermal insulation pipes for gas and liquid refrigerant pipes.

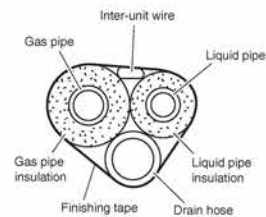

Wiring

⚠ WARNING

- Do not use tapped wires, extension cords, or starburst connections, as they may cause overheating, electrical shock, or fire.
- Do not use locally purchased electrical parts inside the product. (Do not branch the power for the drain pump, etc., from the terminal block.) Doing so may cause electric shock or fire.
- Be sure to install a ground fault circuit interrupter. (One that can handle higher harmonics.)
(This unit uses an inverter, which means that a ground fault circuit interrupter capable of handling harmonics must be used in order to prevent any malfunction of the ground fault circuit interrupter itself.)
- Use an all-pole disconnection type circuit breaker with at least 1/8 inch (3mm) between the contact point gaps.
- When carrying out wiring connection, take care not to pull at the conduit.
- Do not connect the power wire to the indoor unit. Doing so may cause electric shock or fire.

- Do not turn on the circuit breaker until all work is completed.
 - 1) Strip the insulation from the wire (3/4 inch (20mm)).
 - 2) Connect the inter-unit wires between the indoor and outdoor units so that the terminal numbers match. Tighten the terminal screws securely. We recommend a flathead screwdriver be used to tighten the screws. The screws are packed with the terminal block.

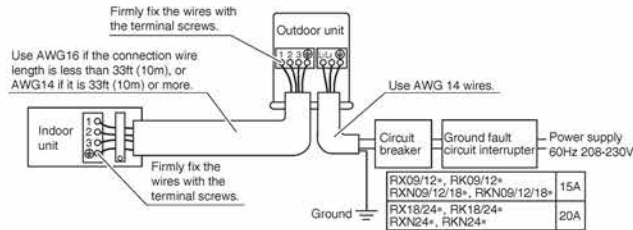

09/12 class

<Method of mounting conduit>

- A protection plate is fixed for protection from the high-voltage section.
 - 1) Dismount the stop valve cover by removing the screw.
 - 2) Dismount the protection plate by removing the 2 screws.
 - 3) Dismount the conduit mounting cover by removing the 2 screws.
 - 4) Pass wires through the conduit and secure them with a lock nut.
 - 5) After completing the work, reattach the stop valve cover, the conduit mounting cover, and the protection plate to its original position.

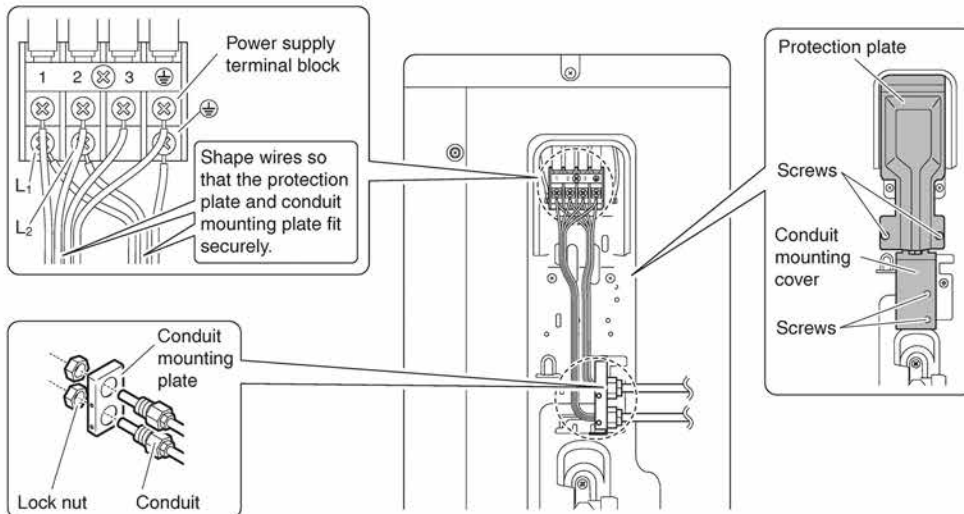

18/24 class

<Method of mounting conduit>

- 1) Dismount the service lid by removing the 2 screws.
- 2) Pass wires through the conduit and secure them with a lock nut.
- 3) After completing the work, reattach the service lid to its original position.

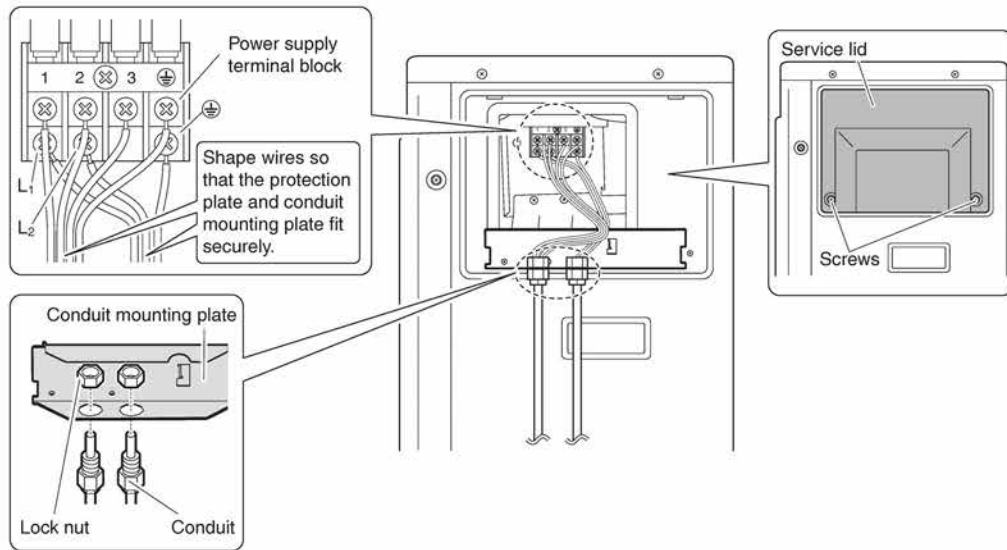

CAUTION

- Precautions to be taken for power supply wiring. When using stranded wires, make sure to use the round crimp-style terminal for connection to the power supply terminal block.

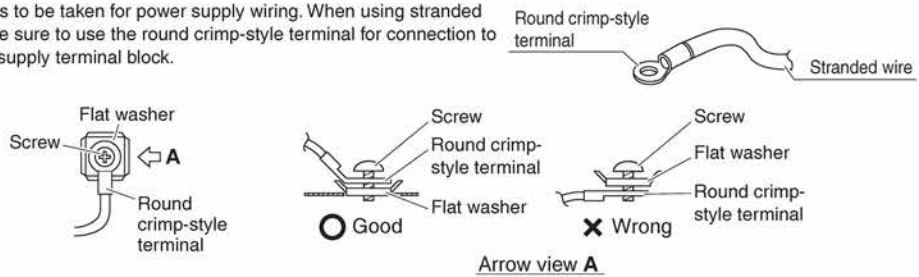

- When connecting the inter-unit wires to the terminal block using a single core wire, be sure to curl the end of the lead. Improper work may cause heat and fires.

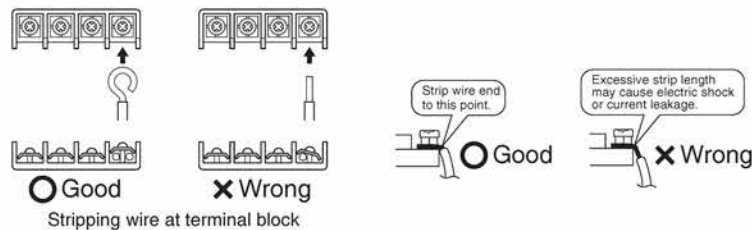

Facility Setting* (cooling at low outdoor temperature)

This function is limited only for facilities (the target of air conditioning is equipment (such as computer)).
Never use it in a residence or office (the space where there is a human).

*Only for RX and RK models.

- Cutting jumper 6 (J6) on the circuit board will expand the operation range down to 5°F (–15°C). However it will stop if the outdoor temperature drops below –4°F (–20°C) and start back up once the temperature rises again.
 - 1) Remove the top plate of the outdoor unit. (09/12 class: 3 screws, 18/24 class: 6 screws)
 - 2) Remove the front plate. (09/12 class: 4 screws, 18/24 class: 8 screws)
 - 3) Cut the jumper (J6) of the PCB inside.

⚠ CAUTION

- If the outdoor unit is installed where the heat exchanger of the unit is exposed to direct wind, provide a windbreak wall.
- Intermittent noises may be produced by the indoor unit due to the outdoor fan turning on and off when using facility settings.
- Do not place humidifiers or other items which might raise the humidity in rooms where facility settings are being used.
A humidifier might cause dew jumping from the indoor unit outlet vent.
- Cutting jumper 6 (J6) sets the indoor fan tap to the highest position. Notify the user about this.

Pump Down Operation

In order to protect the environment, be sure to pump down when relocating or disposing of the unit.

- 1) Remove the valve cap from the liquid stop valve and gas stop valve.
- 2) Carry out forced cooling operation.
- 3) After 5 to 10 minutes, close the liquid stop valve with a hexagonal wrench.
- 4) After 2 to 3 minutes, close the gas stop valve and stop forced cooling operation.

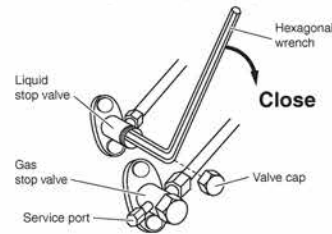

Forced cooling operation

■ Using the indoor unit ON/OFF switch

Press the indoor unit ON/OFF switch for at least 5 seconds. (The operation will start.)

- Forced cooling operation will stop automatically after about 15 minutes.
To stop the operation, press the indoor unit ON/OFF switch.

■ Using the indoor unit's remote controller

- 1) Press **TEMP** (up/down), **TEMP** (up/down), and **OFF** at the same time.
 - 2) Press **TEMP** (up/down), then select **7**, press **FAN**.
 - 3) Press **COOL** to turn on the system.
- Forced cooling operation will stop automatically after about 30 minutes.
To stop the operation, press **OFF**.



HEAT PUMP model



COOLING ONLY model

⚠ CAUTION

- When pressing the switch, do not touch the terminal block. It has a high voltage, and touching it could cause electric shock.
- After closing the liquid stop valve, close the gas stop valve within 3 minutes, then stop the forced operation.

Trial Operation and Testing

1. Trial operation and testing

- Trial operation should be carried out in either COOL or HEAT operation.

1-1. Measure the supply voltage and make sure that it is within the specified range.









1-2. In COOL operation, select the lowest programmable temperature; in HEAT operation, select the highest programmable temperature.

1-3. Carry out the trial operation in accordance with the operation manual to ensure that all functions and parts, such as flap movement, are working properly.

- For protection, the system disables restart operation for 3 minutes after it is turned off.

1-4. After trial operation is complete, set the temperature to a normal level (78°F to 82°F (26°C to 28°C) in COOL operation, 68°F to 75°F (20°C to 24°C) in HEAT operation).

- When operating the air conditioner in COOL operation in winter, or HEAT operation in summer, set it to the trial operation mode using the following method.

- 1) Press ,  and  at the same time.
- 2) Press , then select **7°**, press .
- 3) Press  or  to turn on the system.
 - Trial operation will stop automatically after about 30 minutes.
 - To stop the operation, press .
 - Some of the functions cannot be used in the trial operation mode.



HEAT PUMP model



COOLING ONLY model

- The air conditioner draws a small amount of power in its standby mode. If the system is not to be used for some time after installation, shut off the circuit breaker to eliminate unnecessary power consumption.
- If the circuit breaker trips to shut off the power to the air conditioner, the system will restore the original operation mode when the circuit breaker is opened again.

2. Test items

Test items	Symptom	Check
Indoor and outdoor units are installed properly on solid bases.	Fall, vibration, noise	
No refrigerant gas leaks.	Incomplete cooling/heating function	
Refrigerant gas and liquid pipes and indoor drain hose extension are thermally insulated.	Water leakage	
Draining line is properly installed.	Water leakage	
System is properly grounded.	Electrical leakage	
The specified wires are used for inter-unit wiring.	No operation or burn damage	
Indoor or outdoor unit's air inlet or air outlet are unobstructed.	Incomplete cooling/heating function	
Stop valves are opened.	Incomplete cooling/heating function	
Indoor unit properly receives remote control commands.	No operation	

12. Operation Manual

12.1 Cooling Only

Read Before Operation

Safety Considerations

- Read these **Safety Considerations** for operation carefully before installing air conditioning equipment. After completing the installation, make sure that the unit operates properly during the startup operation. Instruct the customer on how to operate and maintain the unit. Inform customers that they should store this operation manual with the installation manual for future reference. Meanings of **DANGER**, **WARNING**, and **CAUTION** Symbols:

⚠ DANGER Indicates an imminently hazardous situation which, if not avoided, will result in death or serious injury.

⚠ WARNING Indicates a potentially hazardous situation which, if not avoided, could result in death or serious injury.

⚠ CAUTION Indicates a potentially hazardous situation which, if not avoided, may result in minor or moderate injury. It may also be used to alert against unsafe practices.

⚠ DANGER

- For refrigerant leakage, consult your dealer. Refrigerant gas is heavier than air and replaces oxygen. A massive leak could lead to oxygen depletion, especially in basements, and an asphyxiation hazard could occur leading to serious injury or death.
- Refrigerant gas may produce a toxic gas if it comes in contact with fire such as from a fan heater, stove or cooking device. Exposure to this gas could cause severe injury or death.
- Any abnormalities in the operation of the air conditioner such as smoke or fire could result in severe injury or death. Turn off the power and contact your dealer immediately for instructions.
- Do not install the unit in an area where flammable materials are present due to risk of explosion resulting in serious injury or death.
- If equipment utilizing a burner is used in the same room as the air conditioner, there is the danger of oxygen deficiency which could lead to an asphyxiation hazard resulting in serious injury or death. Be sure to ventilate the room sufficiently to avoid this hazard.
- Safely dispose of the packing materials. Packing materials, such as nails and other metal or wooden parts, may cause stabs or other injuries. Tear apart and throw away plastic packaging bags so that children will not play with them. Children playing with plastic bags face the danger of death by suffocation.

⚠ WARNING

- Do not put your finger or other objects into the air outlet or inlet as the fan is rotating at high speed and could cause injury. Always keep small children away from the unit during operation.
- Do not attempt to repair, relocate, modify or reinstall the air conditioner by yourself. Incorrect work or modifications could cause electric shocks, fire or other damage. For repairs and reinstallation, consult your Daikin dealer for advice and information.
- Do not use a refrigerant other than the one indicated on the outdoor unit (R410A) when installing, moving or repairing. Using other refrigerants may cause trouble or damage to the unit, and personal injury.
- Do not operate the air conditioner with wet hands.
- If the air conditioner is not cooling properly, the refrigerant may be leaking, contact your authorized dealer or qualified service repairman. When making repairs which requires adding refrigerant, consult with your authorized dealer or qualified service repairman.
- Do not attempt to install the air conditioner by yourself. Improper installation could result in water leakage, electric shocks or fire. For installation, consult your authorized dealer or a qualified technician.

⚠ CAUTION

- The air conditioner must be grounded. Improper grounding may result in electric shocks. Do not connect the grounding wire to a gas pipe, water pipe, lightning rod, or a telephone ground line. Follow all local and state electrical codes.
- Do not use this unit for cooling precision instruments, food, plants, animals or works of art.
- Never expose little children, plants or animals directly to the airflow.
- Do not block air inlets nor outlets. Impaired airflow may result in poor performance or equipment problems.
- Do not stand, sit, or place objects on the outdoor unit. To avoid injury, do not remove the fan guard.
- Do not place anything under the indoor or outdoor unit that must be kept away from moisture, such as electrical or electronic equipment. In certain conditions, moisture in the air may condense and drip.
- Check the unit stand and fittings for damage annually.
- Do not touch the air inlet and aluminum fins of outdoor unit. It may cause injury and/or damage the heat transfer surface.
- This appliance is NOT intended for use by young children or impaired persons without proper supervision.

Read Before Operation

- Young children should be supervised to ensure that they DO NOT play with or near the airflow of this appliance.
- Do not pull at the conduit or hang anything on it. Otherwise it will cause fire or electric shock.
- Do not touch the heat exchanger fins. Improper handling may result in injury.
- Do not turn off the power immediately after stopping operation. Always wait at least 5 minutes before turning off the power to avoid water leakage or other problems.
- Do not wash the indoor unit with excessive water, only use a slightly wet cloth.
- Do not place things such as vessels containing water or anything else on top of the unit. Water may penetrate into the unit and degrade electrical insulations, resulting in an electric shock.
- To avoid personal injury or equipment damage be sure to stop the operation, turn off the circuit breaker or pull out the supply cord before cleaning or servicing the unit. NOTE: More than one disconnect may be required to shut off all power.
- Do not connect the air conditioner to a power supply different from the one specified. It may cause improper operation or fire.
- Depending on the environment, state and local electrical codes, a ground fault circuit interrupter may be required. Improper grounding or lack of a ground fault circuit interrupter may result in electrical shock, injuries, or death.
- It is recommended to install a ground fault circuit interrupter if one is not already available. This helps prevent electrical shocks or fire.
- Arrange the drain hose to ensure smooth drainage. Improper drainage may cause water damage to the building, or its furnishing.
- Depending on the usage environment, water may leak from the air conditioner. If this happens, contact your Daikin dealer.
- The remote controller should be installed in such way that children cannot play with it.
- Do not place objects in direct proximity of the outdoor unit and do not let leaves and other debris accumulate around the unit.
Leaves attract small animals which can enter the unit. Once in the unit, such animals can cause malfunctions, smoke or fire when making contact with electrical parts.

Installation site

- Operate the air conditioner in a sufficiently ventilated area and not surrounded by obstacles. Do not use the air conditioner in the following places:
 - a. Places with a mist of mineral oil, such as cutting oil.
 - b. Locations such as coastal areas where there is a lot of salt in the air.
 - c. Locations such as hot springs where there is a lot of sulfur in the air.
 - d. Locations such as factories where the power voltage varies a lot.
 - e. In cars, boats, and other vehicles.
 - f. Locations such as kitchens where oil may splatter or where there is steam in the air.
 - g. Locations where equipment produces electromagnetic waves.
 - h. Places with an acid or alkaline mist.

Consider the nuisance of noise to your neighbors

- Pay Attention to Operating Sound. Be sure to use the following places:
 - a. Places that can sufficiently withstand the weight of the air conditioner yet can suppress the operating sound and vibration of the air conditioner.
 - b. Places where warm air from the air outlet of the outside unit or the operating sound of the outside unit does not annoy neighbors.
Make sure that there are no obstacles close to the outside unit. Obstacles close to the outside unit may drop the performance of the outside unit or increase the operating sound of the outside unit. Consult your dealer if the air conditioner in operation generates unusual sounds.

Electrical work

- For power supply, be sure to use a separate power circuit dedicated to the air conditioner.

System relocation

- Relocating the air conditioner requires specialized knowledge and skills. Please consult the dealer if relocation is necessary for moving or remodeling.

Read Before Operation

Names of Parts

FTK09NMVJU / FTK12NMVJU / FTKN09NMVJU / FTKN12NMVJU

Indoor Unit

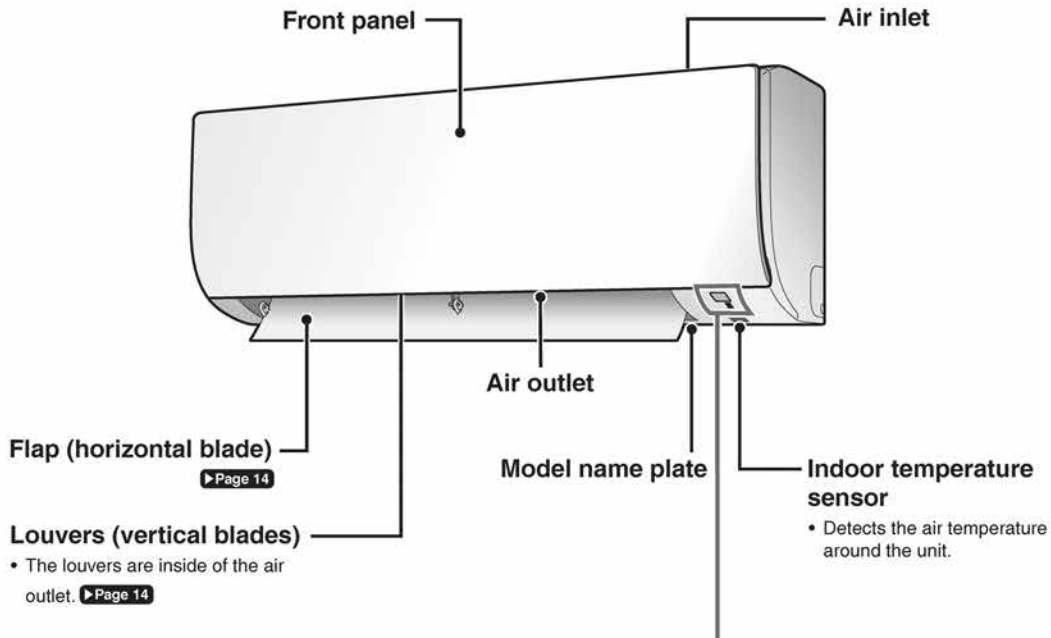

Display

Signal receiver

- Receives signals from the remote controller.
- When the unit receives a signal, you will hear a beep sound.

Case	Sound type
Operation start	beep-beep
Setting changed	beep
Operation stop	long beep

OPERATION lamp (green)

TIMER lamp (orange)
▶Page 17,18

Indoor unit ON/OFF switch

- Press this switch once to start operation. Press once again to stop it.
- For the operation mode setting, refer to the following table.

Mode	Temperature setting	Airflow rate
COOL	72°F (22°C)	AUTO

- This switch can be used when the remote controller is missing.

Read Before Operation

■ **Open the front panel**

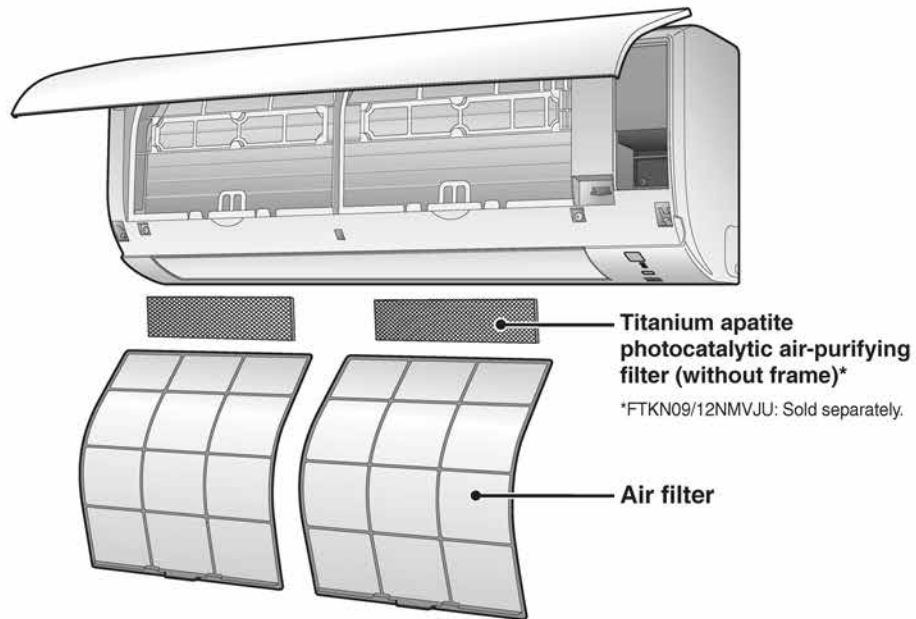

Outdoor Unit

• The appearance of the outdoor unit may differ between different models.

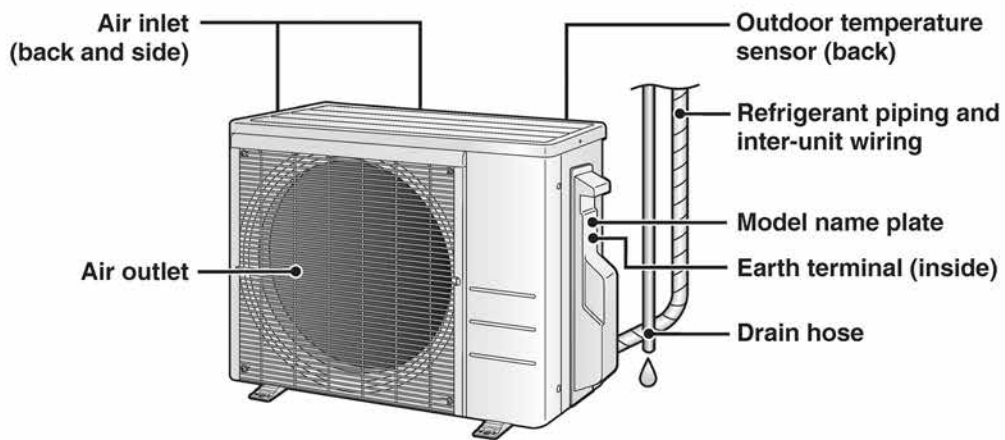

Read Before Operation

Names of Parts

FTK18NMVJU / FTK24NMVJU / FTKN18NMVJU / FTKN24NMVJU

Indoor Unit

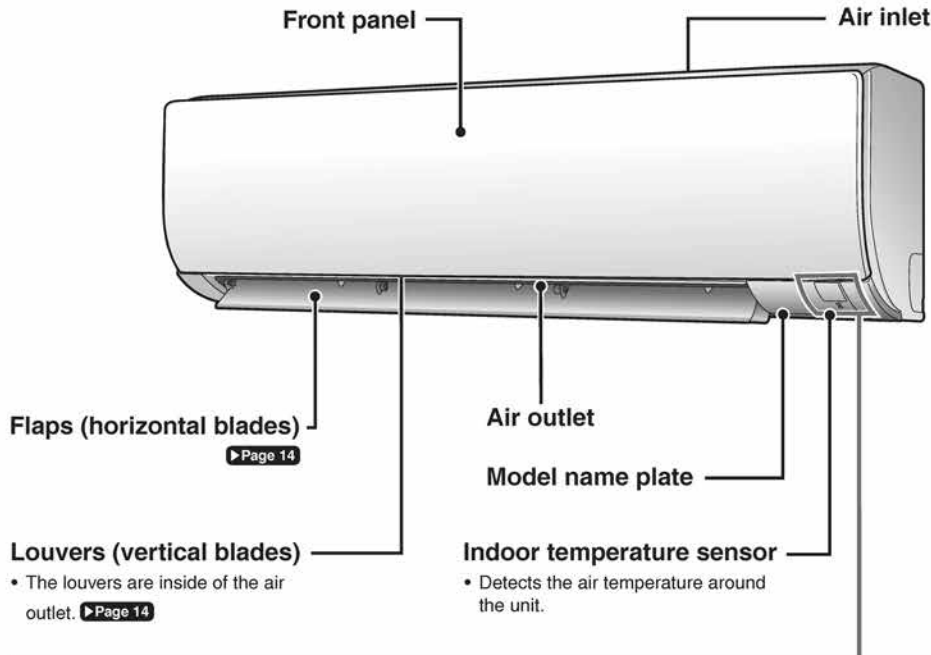

Display

Signal receiver

- Receives signals from the remote controller.
- When the unit receives a signal, you will hear a beep sound.

Case	Sound type
Operation start	beep-beep
Setting changed	beep
Operation stop	long beep

OPERATION lamp (green)

TIMER lamp (orange)
▶Page 17,18

Indoor unit ON/OFF switch

- Press this switch once to start operation. Press once again to stop it.
- For the operation mode setting, refer to the following table.

Mode	Temperature setting	Airflow rate
COOL	72°F (22°C)	AUTO

- This switch can be used when the remote controller is missing.

Read Before Operation

■ **Open the front panel**

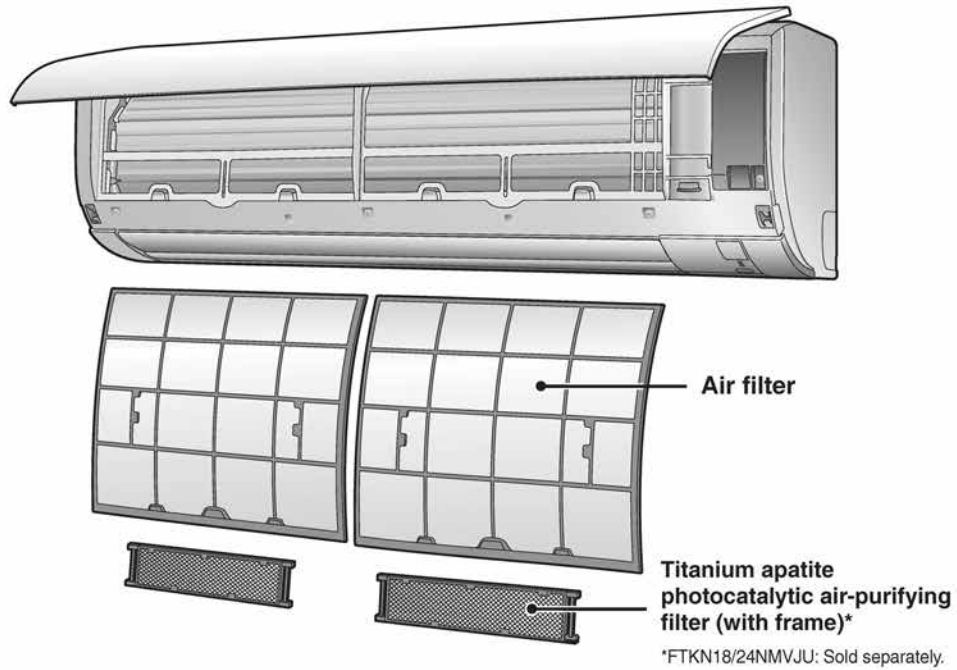

Outdoor Unit

• The appearance of the outdoor unit may differ between different models.

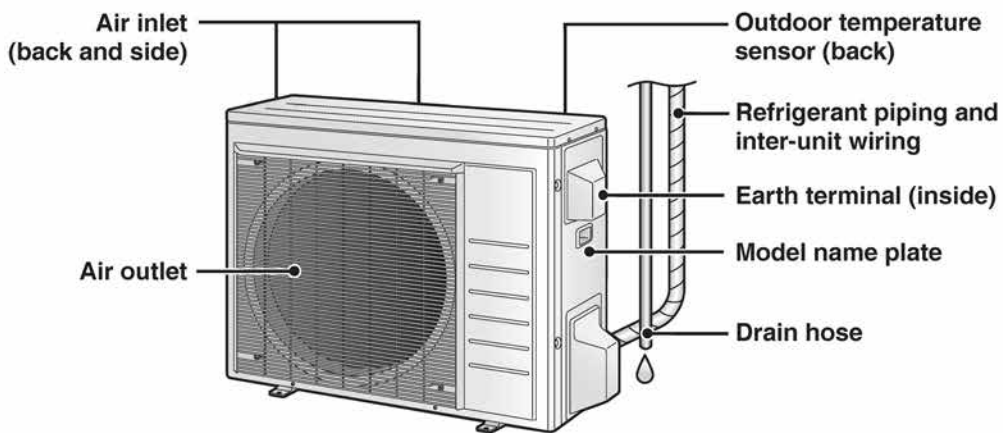

Read Before Operation

Names of Parts

Remote Controller

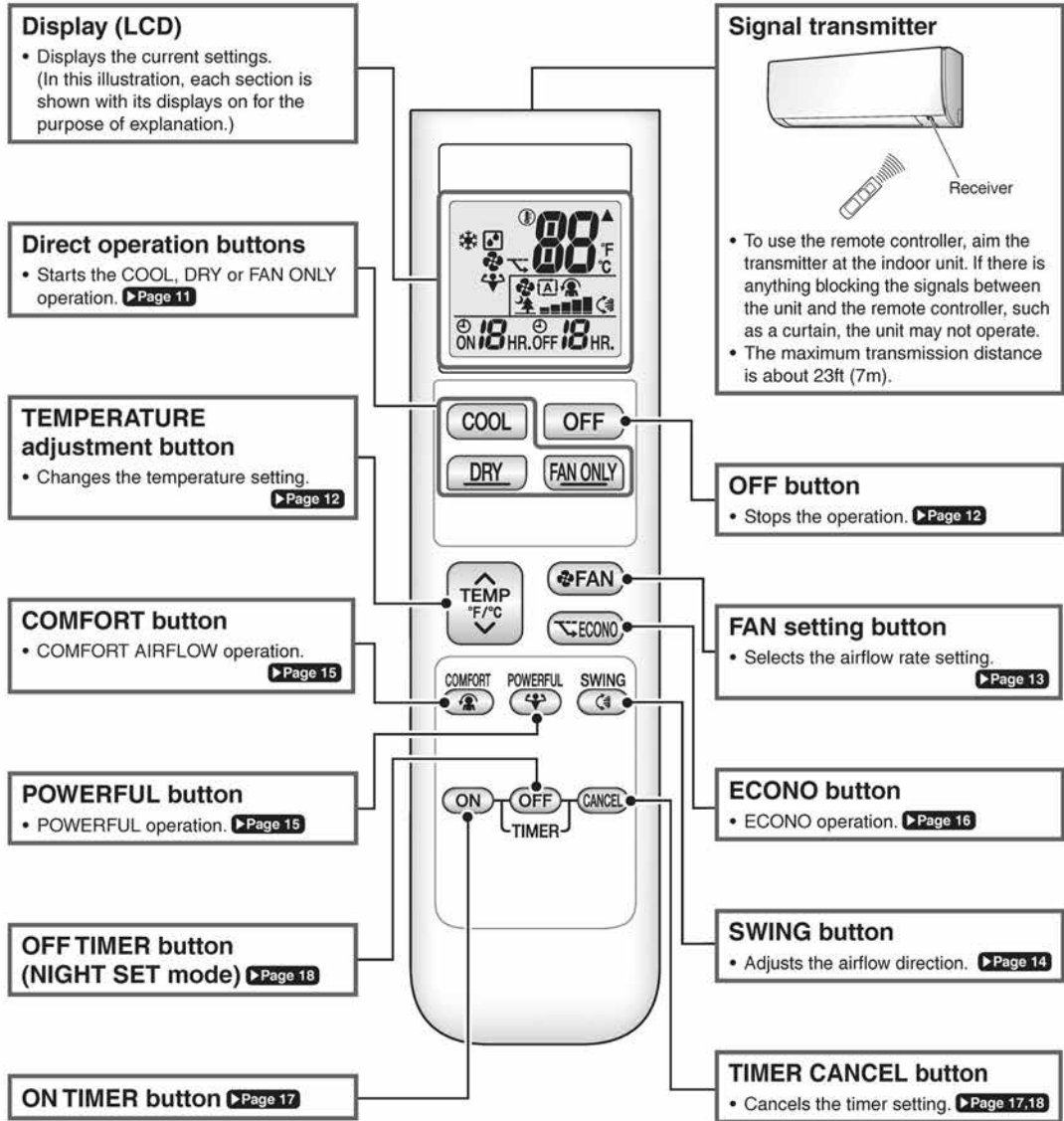

Unit	Remote Controller	
FTK09/12/18/24NMVJU	ARC480A9	with backlight
FTKN09/12/18/24NMVJU	ARC480A7	without backlight

Read Before Operation

Preparation Before Operation

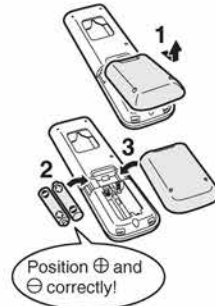

To insert the batteries

- 1.** Remove the back cover by sliding and then slightly lifting it.
- 2.** Insert 2 dry batteries AAA.LR03 (alkaline).
- 3.** Replace the back cover.

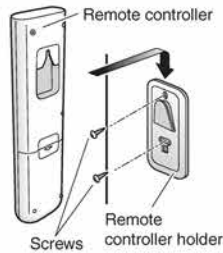

To fix the remote controller holder to a wall

- 1.** Choose a place where the signals reach the unit.
- 2.** Attach the holder to a wall, a pillar, or similar location with the screws supplied with the holder.
- 3.** Hang the remote controller on the remote controller holder.

Fahrenheit/Celsius display switch



- ▶ Press  and  (TIMER button) simultaneously for about 5 seconds.

- The temperature will be displayed in Celsius when it is presently displayed in Fahrenheit, and vice versa.
- The switch operation is only possible when the temperature is being displayed.

Turn on the circuit breaker

- After the power is turned on, the flap of the indoor unit opens and closes once to set the reference position.

NOTE

Notes on batteries

- When replacing the batteries, use batteries of the same type, and replace both old batteries together.
- The batteries will last for about 1 year. If the remote controller display begins to fade and the possible transmission range becomes shorter within a year, however, replace both batteries with new, size AAA.LR03 (alkaline).
- The batteries supplied with the remote controller are for initial operation. The batteries may run out in less than 1 year.

Note on remote controller

- Do not drop the remote controller. Do not get it wet.

Fahrenheit/Celsius display change function of remote controller

- The set temperature may increase when the display is changed to Celsius from Fahrenheit, because a fraction of 0.5°C is rounded up.
- Example: A set temperature of 65°F (equivalent to 18.5°C) will be converted into 19°C. When the display is changed to Fahrenheit again, the set temperature will be converted into 66°F (equivalent to 19°C) instead of the original set temperature (65°F) but a set temperature of 66°F (equivalent to 19°C) will be converted into 19°C with no temperature change.
- A reception sound will go off for the transmission of set temperature to the indoor unit at the time of setting the Fahrenheit/Celsius display change function.

Basic Operation



COOL · DRY · FAN ONLY Operation



The air conditioner operates with the operation mode of your choice.

To start operation

COOL operation

- To lower the temperature.

Press **COOL** .



DRY operation

- To lower the humidity.

Press **DRY** .



FAN ONLY operation

- To circulate air in the room.

Press **FAN ONLY** .



- The OPERATION lamp lights green.



Display

NOTE

Note on DRY operation

- Eliminates humidity while maintaining the indoor temperature as much as possible. It automatically controls temperature and airflow rate, so manual adjustment of these functions is unavailable.

Basic Operation

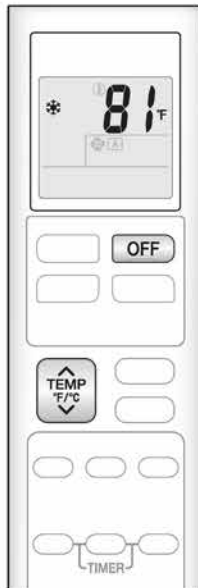

To stop operation

Press **OFF**.

- The OPERATION lamp goes off.

To change the temperature setting

Press **TEMP F/C**.

- Press **▲** to raise the temperature and press **▼** to lower the temperature.

COOL operation	DRY or FAN ONLY operation
64-90°F (18-32°C)	The temperature setting cannot be changed.

Tips for saving energy

Keeping the temperature setting at a moderate level helps save energy.

- Recommended temperature setting
 - For cooling: 78-82°F (26-28°C)

Cover windows with a blind or a curtain.

- Blocking sunlight and air from outdoors increases the cooling effect.

Keep the air filters clean.

- Clogged air filters cause inefficient operation and waste energy. Clean them once every 2 weeks. [▶ Page 20, 23](#)

If you are not going to use the air conditioner for a long period, for example in spring or autumn, turn off the circuit breaker.

- The air conditioner always consumes a small amount of electricity even while it is not operating.



Basic Operation



Adjusting the Airflow Rate

You can adjust the airflow rate to increase your comfort.

To adjust the airflow rate setting

Press **FAN**.

- Each pressing of **FAN** changes the airflow rate setting in sequence.

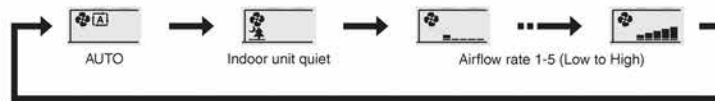

- When the airflow is set to "🌳", quiet operation starts and noise from the indoor unit will become quieter.
- In the quiet operation mode, the airflow rate is set to a weak level.

COOL and FAN ONLY operation			DRY operation
			The airflow rate setting cannot be changed.



NOTE

Note on airflow rate setting

- At smaller airflow rates, the cooling effect is also smaller.



Adjusting the Airflow Direction



You can adjust the airflow direction to increase your comfort.

⚠ CAUTION

- Always use a remote controller to adjust the angles of the flap. Moving the flap forcibly by hand may cause a malfunction.
- Be careful when adjusting the louvers. Inside the air outlet, a fan is rotating at a high speed.

To start auto swing

Up and down airflow direction

Press **SWING** .

- "☺" is displayed on the LCD.
- The flap (horizontal blade) will begin to swing.



To set the flap at the desired position

- This function is effective while the flap is in auto swing mode.

Press **SWING** when the flap reaches the desired position.

- "☺" disappears from the LCD.

To adjust the louvers at desired position

Hold the knobs and move the louvers (vertical blades).

FTK09NMVJU / FTK12NMVJU
FTKN09NMVJU / FTKN12NMVJU

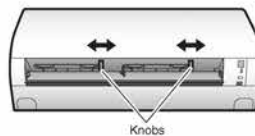

Knobs

FTK18NMVJU / FTK24NMVJU
FTKN18NMVJU / FTKN24NMVJU

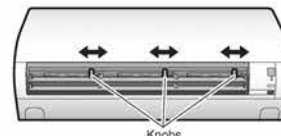

Knobs

NOTE

Notes on airflow direction setting

- The movable range of the flap varies according to the operation mode.
- The flap will stop at the upper position when the airflow rate is changed to low during the up and down swing setting.

Movable range of the flap

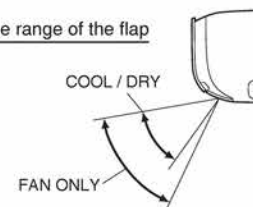

Useful Functions



COMFORT AIRFLOW Operation



The air direction and flow rate are adjusted so that the air will not blow directly at people in the room.

To start COMFORT AIRFLOW operation

Press  .

- "  " is displayed on the LCD.

	COOL and DRY operation
Flap direction	Goes up
Airflow rate	AUTO

- Not available in FAN ONLY mode.

To cancel COMFORT AIRFLOW operation

Press  again.

- "  " disappears from the LCD.
- The flap will return to the memory position from before COMFORT AIRFLOW operation.





POWERFUL Operation



POWERFUL operation quickly maximizes the cooling effect in any operation mode. In this mode, the air conditioner operates at maximum capacity.

To start POWERFUL operation

Press  .

- "  " is displayed on the LCD.
- POWERFUL operation ends in 20 minutes. Then the system automatically operates again with the previous settings which were used before POWERFUL operation.

To cancel POWERFUL operation

Press  again.

- "  " disappears from the LCD.

Useful Functions



ECONO Operation



ECONO operation enables efficient operation by limiting the maximum power consumption.

This function is useful to prevent the circuit breaker from tripping when the unit operates alongside other appliances on the same circuit.

To start ECONO operation

Press .

- “” is displayed on the LCD.
- Not available in FAN ONLY mode.

To cancel ECONO operation

Press again.

- “” disappears from the LCD.

NOTE

Note on COMFORT AIRFLOW operation

- If the up and down airflow direction is selected, the COMFORT AIRFLOW operation will be canceled.

Notes on POWERFUL operation

- Pressing causes the settings to be canceled, and “” disappears from the LCD.
- POWERFUL operation will not increase the capacity of the air conditioner if the air conditioner is already in operation with its maximum capacity demonstrated.
 - In COOL operation
 - To maximize the cooling effect, the capacity of outdoor unit increases and the airflow rate becomes fixed at the maximum setting.
 - The temperature setting cannot be changed.
 - In DRY operation
 - The temperature setting is lowered by 4.5°F (2.5°C) and the airflow rate is slightly increased.
 - In FAN ONLY operation
 - The airflow rate is fixed at the maximum setting.

Notes on ECONO operation

- Pressing causes the settings to be canceled, and “” disappears from the LCD.
- If the power consumption level is already low, switching to ECONO operation will not reduce the power consumption.

Some useful functions can be used together.

COMFORT AIRFLOW + ECONO	Available
POWERFUL + COMFORT AIRFLOW	Not available*
POWERFUL + ECONO	Not available*

*Priority is given to the function of whichever button is pressed last.

TIMER Operation



ON/OFF TIMER Operation



Timer functions are useful for automatically switching the air conditioner on or off at night or in the morning. You can also use the ON TIMER and OFF TIMER together.

To use ON TIMER operation

Press **ON**.

"ON 1HR." is displayed on the LCD.

- Each pressing of **ON** advances the time setting by 1 hour. The time can be set between 1 and 12 hours.
- The TIMER lamp lights orange.



Display

To cancel ON TIMER operation

Press **CANCEL**.

- "ON 1HR." disappears from the LCD.
- The TIMER lamp goes off.

NOTE

In the following cases, set the timer again.

- After the circuit breaker has turned off.
- After a power failure.
- After replacing the batteries in the remote controller.

TIMER Operation



To use OFF TIMER operation

Press **OFF**.

 "OFF  HR." is displayed on the LCD.

- Each pressing of **OFF** advances the time setting by 1 hour. The time can be set between 1 and 12 hours.
- The TIMER lamp lights orange.



Display

To cancel OFF TIMER operation

Press **CANCEL**.

- "OFF  HR." disappears from the LCD.
- The TIMER lamp goes off.

To combine ON TIMER and OFF TIMER operation

- A sample setting for combining the 2 timers is shown below.
- "ON" and "OFF" are displayed on the LCD.

[Example]



When setting while the unit is operating

- Stops the unit 1 hour later and starts it 7 hours after that.



When setting while the unit is stopped

- Starts the unit 2 hours later and stops it 3 hours after that.

NOTE**NIGHT SET mode**

- When the OFF TIMER is set, the air conditioner automatically adjusts the temperature setting (0.9°F (0.5°C) up in COOL) to prevent excessive cooling during sleeping hours.

Care

Care and Cleaning

FTK09NMVJU / FTK12NMVJU / FTKN09NMVJU / FTKN12NMVJU

CAUTION

- Before cleaning, be sure to stop the operation and turn off the circuit breaker.
- Do not touch the aluminium fins of the indoor unit. If you touch those parts, this may cause an injury.

Quick reference

Cleaning parts

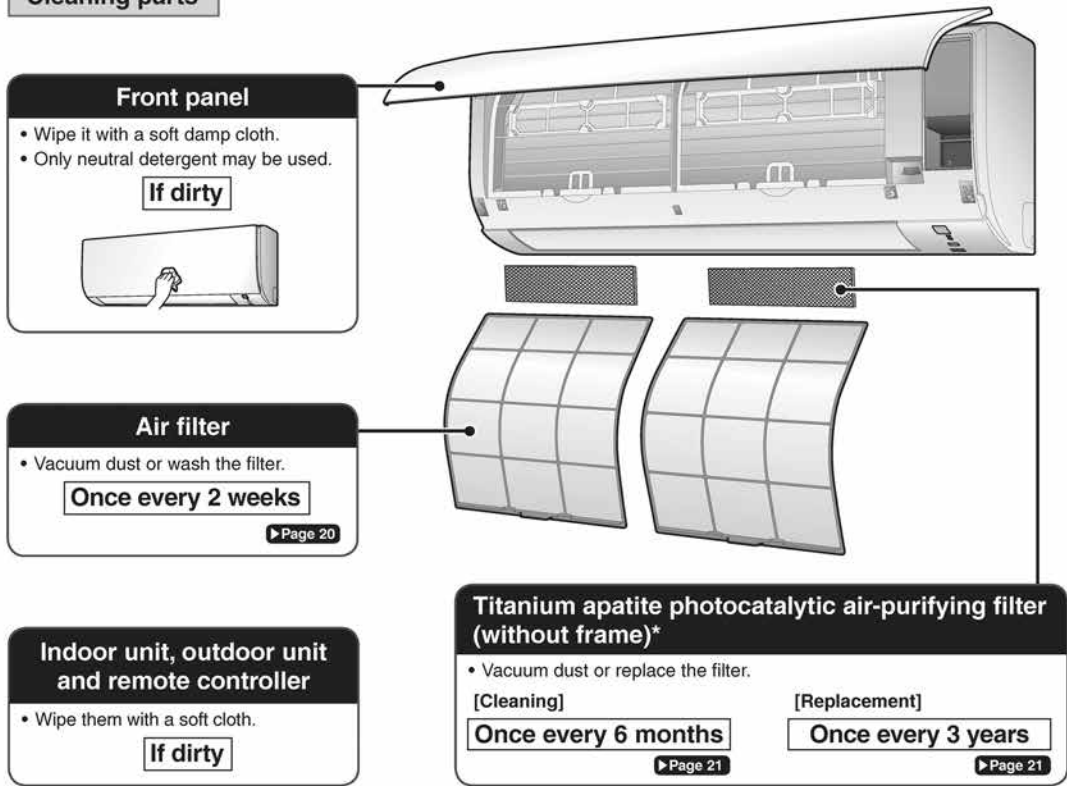

*FTKN09/12NMVJU: Sold separately.

NOTE

For cleaning, do not use any of the following:

- Water hotter than 104°F (40°C)
- Volatile liquid such as benzene, petrol and thinner
- Polishing compounds
- Rough materials such as a scrubbing brush



■ Air filter

1. Open the front panel.

- Hold the front panel by the sides and open it.

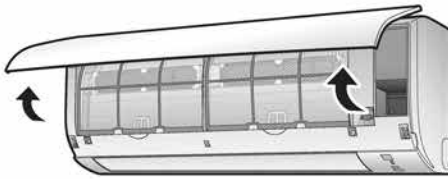

2. Pull out the air filters.

- Push the filter tab at the center of each air filter a little upwards, then pull it down.

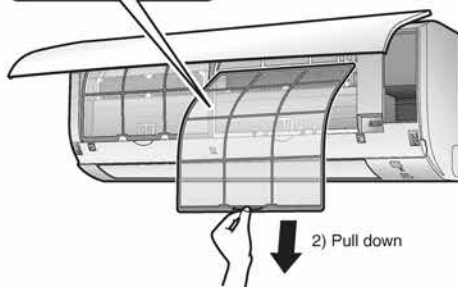
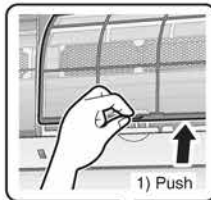

3. Wash the air filters with water or clean them with vacuum cleaner.

- It is recommended to clean the air filters every 2 weeks.

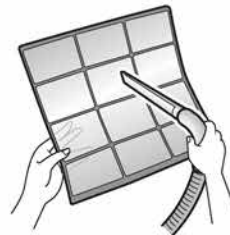

If the dust does not come off easily

- Wash the air filters with neutral detergent thinned with lukewarm water, then dry them up in the shade.



4. Reattach the filters.

5. Close the front panel slowly.

- Press the panel at both sides and the center.

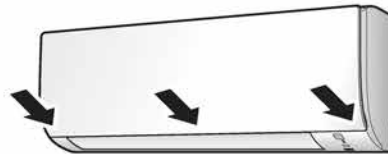

- Make sure that the front panel is securely fixed.

Care

Care and Cleaning

FTK09NMVJU / FTK12NMVJU / FTKN09NMVJU / FTKN12NMVJU

■ Titanium apatite photocatalytic air-purifying filter

1. Open the front panel and pull out the air filters. ▶Page 20

2. Take off the titanium apatite photocatalytic air-purifying filters.

- Remove the filters from the tabs.

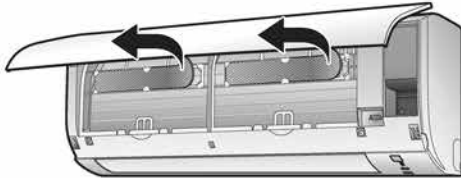

3. Clean or replace the titanium apatite photocatalytic air-purifying filters.

[Cleaning]

3-1 Vacuum dust, and soak in lukewarm water or water for about 10 to 15 minutes if very dirty.



3-2 After washing, shake off remaining water and let them dry in the shade.

- Do not wring out the filter to remove water from it.

[Replacement]

Remove the filter from the tabs and prepare a new one.



- Dispose of the old filter as non-flammable waste.

4. Insert the titanium apatite photocatalytic air-purifying filters as they were.

- When attaching the filter, check that the filter is properly set in the tabs.

5. Reattach the filters. ▶Page 20

6. Close the front panel slowly.

▶Page 20

NOTE

- Operation with dirty filters:
 - cannot deodorize the air,
 - cannot clean the air,
 - results in poor cooling,
 - may cause odor.
- Dispose of old filters as non-flammable waste.
- To order a titanium apatite photocatalytic air-purifying filter, contact the dealer where you bought the air conditioner.

Item	Titanium apatite photocatalytic air-purifying filter 1 set
Part No.	KAF970A46 (without frame)

Care and Cleaning

FTK18NMVJU / FTK24NMVJU / FTKN18NMVJU / FTKN24NMVJU

⚠ CAUTION

- Before cleaning, be sure to stop the operation and turn off the circuit breaker.
- Do not touch the aluminium fins of the indoor unit. If you touch those parts, this may cause an injury.

■ Quick reference

Cleaning parts

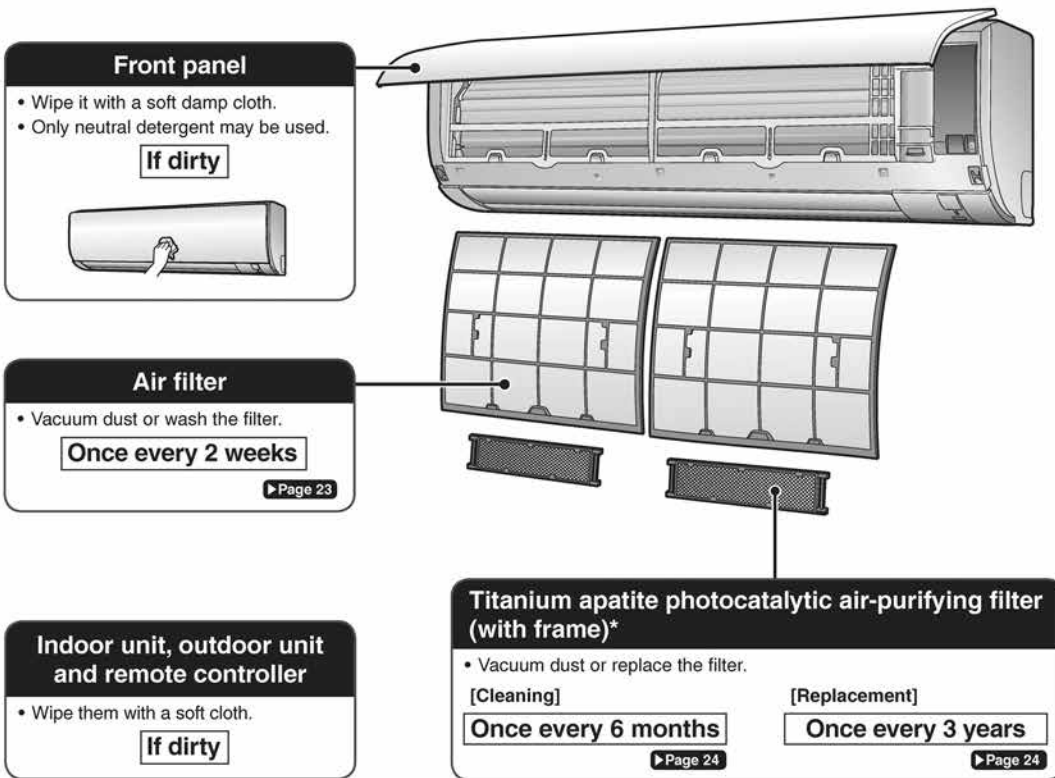

*FTKN18/24NMVJU: Sold separately.

NOTE

For cleaning, do not use any of the following:

- Water hotter than 104°F (40°C)
- Volatile liquid such as benzene, petrol and thinner
- Polishing compounds
- Rough materials such as a scrubbing brush



Care

Care and Cleaning

FTK18NMVJU / FTK24NMVJU / FTKN18NMVJU / FTKN24NMVJU

■ Air filter

1. Open the front panel.

- Hold the front panel by the sides and open it.

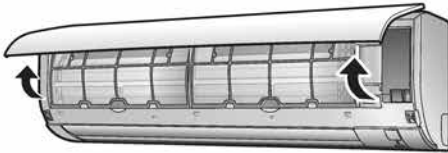

2. Pull out the air filters.

- Push the filter tab at the center of each air filter a little upwards, then pull it down.

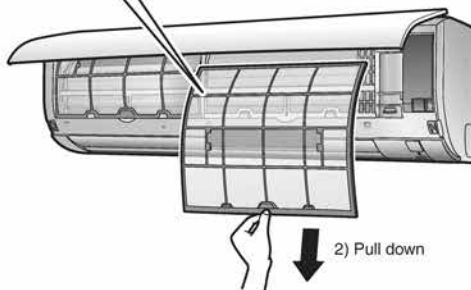
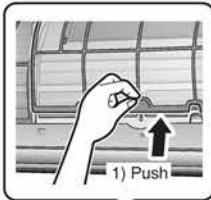

3. Wash the air filters with water or clean them with vacuum cleaner.

- It is recommended to clean the air filters every 2 weeks.



If the dust does not come off easily

- Wash the air filters with neutral detergent thinned with lukewarm water, then dry them up in the shade.
- Be sure to remove the titanium apatite photocatalytic air-purifying filter. Refer to "Titanium apatite photocatalytic air-purifying filter" on the next page.



4. Reattach the filters.

5. Close the front panel slowly.

- Press the front panel at both sides and in the central area.

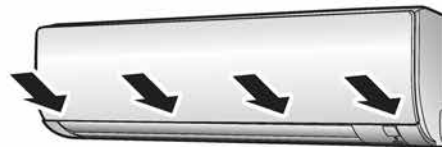

- Make sure that the front panel is securely fixed.

■ Titanium apatite photocatalytic air-purifying filter

1. Open the front panel and pull out the air filters. ▶ Page 23

2. Take off the titanium apatite photocatalytic air-purifying filters.

- Hold the recessed parts of the frame and unhook the 4 claws.

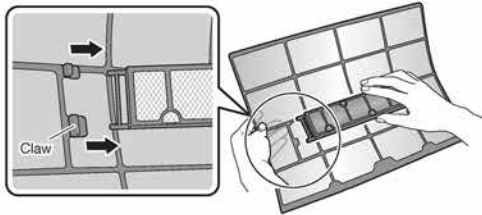

3. Clean or replace the titanium apatite photocatalytic air-purifying filters.

[Cleaning]

3-1 Vacuum dust, and soak in lukewarm water or water for about 10 to 15 minutes if very dirty.

- Do not remove the filter from the frame when washing with water.

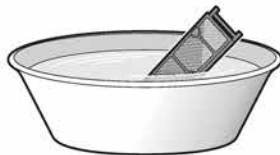

3-2 After washing, shake off remaining water and let them dry in the shade.

- Do not wring out the filter to remove water from it.

[Replacement]

Remove the filter from the filter frame and prepare a new one.

- Do not throw away the filter frame. Reuse the filter frame when replacing the titanium apatite photocatalytic air-purifying filter.

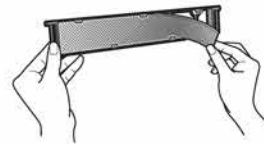

- Dispose of the old filter as non-flammable waste.

4. Insert the titanium apatite photocatalytic air-purifying filters as they were.

- When attaching the filter, check that the filter is properly set in the tabs.

5. Reattach the filters. ▶ Page 23

6. Close the front panel slowly.

▶ Page 23

NOTE

- Operation with dirty filters:
 - cannot deodorize the air,
 - cannot clean the air,
 - results in poor cooling,
 - may cause odor.
- Dispose of old filters as non-flammable waste.
- To order a titanium apatite photocatalytic air-purifying filter, contact the dealer where you bought the air conditioner.

Item	Titanium apatite photocatalytic air-purifying filter 1 set
Part No.	KAF970A46 (without frame)
	KAF970A45 (with frame)*

*For customers who are using the FTKN18/24NMVJU, please purchase the KAF970A45 (with frame) during your initial purchase.

Care

Care and Cleaning

All models

■ Prior to a long period of non-use

1. Operate the FAN ONLY mode for several hours to dry out the inside.

- Press **FAN ONLY**.

2. After operation stops, turn off the circuit breaker for the room air conditioner.

3. Take out the batteries from the remote controller.

■ We recommend periodical maintenance

- In certain operating conditions, the inside of the air conditioner may get foul after several seasons of use, resulting in poor performance. It is recommended to have periodical maintenance by a qualified contractor in addition to regular cleaning by the user.
- For qualified contractor maintenance, please contact the dealer where you bought the air conditioner.

When the Need Arises

FAQ

Indoor unit

The flap does not start swinging immediately.

- The air conditioner is adjusting the position of the flap. The flap will start moving soon.

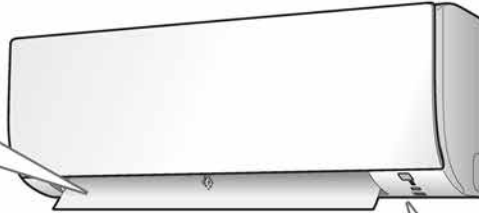
**Operation does not start soon.**

- **When any direct operation button was pressed soon after operation was stopped.**
- **When the mode was reselected.**
 - This is to protect the air conditioner. You should wait for about 3 minutes.

Different sounds are heard.

- **A sound like flowing water**
 - This sound is generated because the refrigerant in the air conditioner is flowing.
 - This is a pumping sound of the water in the air conditioner and can be heard when the water is pumped out from the air conditioner during COOL or DRY operation.
- **Ticking sound**
 - This sound is generated when the cabinet and frame of the air conditioner slightly expand or shrink as a result of temperature changes.
- **Clicking sound during operation or idle time**
 - This sound is generated when the refrigerant control valves or the electrical parts operate.
- **Clopping sound**
 - This sound is heard from the inside of the air conditioner when the exhaust fan is activated while the room doors are closed. Open the window or turn off the exhaust fan.

Outdoor unit

The outdoor unit emits water.

- **In COOL or DRY operation**
 - Moisture in the air condenses into water on the cool surface of the outdoor unit piping and drips.

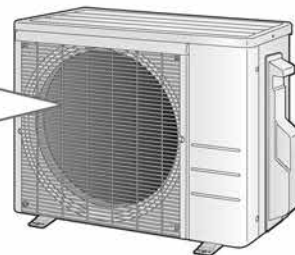

When the Need Arises

Troubleshooting

Before making an inquiry or a request for repair, please check the following.
If the problem persists, consult your dealer.



Not a problem

This case is not a problem.



Check

Please check again before requesting repairs.

The air conditioner does not operate

Case	Description / what to check
OPERATION lamp is off.	<ul style="list-style-type: none"> • Has the circuit breaker been tripped or the fuse blown? • Is there a power failure? • Are batteries set in the remote controller?
OPERATION lamp is blinking.	<ul style="list-style-type: none"> • Turn off the power with the circuit breaker and restart operation with the remote controller. If the OPERATION lamp is still blinking, check the error code and consult your dealer. ▶Page 30

The air conditioner suddenly stops operating

Case	Description / what to check
OPERATION lamp is on.	<ul style="list-style-type: none"> • To protect the system, the air conditioner may stop operating after sudden large voltage fluctuations. It automatically resumes operation in about 3 minutes.
OPERATION lamp is blinking.	<ul style="list-style-type: none"> • Is there anything blocking the air inlet or air outlet of the indoor unit or outdoor unit? Stop operation and after turning off the circuit breaker, remove the obstruction. Then restart operation with the remote controller. If the OPERATION lamp is still blinking, check the error code and consult your dealer. ▶Page 30

The air conditioner does not stop operating

Case	Description / what to check
The air conditioner continues operating even after operation is stopped.	<ul style="list-style-type: none"> <ul style="list-style-type: none"> ■ Immediately after the air conditioner is stopped <ul style="list-style-type: none"> • The outdoor unit fan continues rotating for about another 1 minute to protect the system. ■ While the air conditioner is not in operation <ul style="list-style-type: none"> • When the outdoor temperature is high, the outdoor unit fan may start rotating to protect the system.

The room does not cool down

Case	Description / what to check
Air does not come out / Air comes out.	<ul style="list-style-type: none"> <ul style="list-style-type: none"> ■ Is the airflow rate setting appropriate? <ul style="list-style-type: none"> • Is the airflow rate setting low, such as "Indoor unit quiet" or "Airflow rate 1"? Increase the airflow rate setting. ■ Is the set temperature appropriate? ■ Is the adjustment of the airflow direction appropriate?
Air comes out.	<ul style="list-style-type: none"> <ul style="list-style-type: none"> • Is there any furniture directly under or beside the indoor unit? • Is the air conditioner in ECONO operation? ▶Page 16 • Are the air filters dirty? • Is there anything blocking the air inlet or air outlet of the indoor unit or outdoor unit? • Is a window or door open? • Is an exhaust fan turning?

When the Need Arises

Mist comes out

Case	Description / what to check
Mist comes out of the indoor unit.	<input checked="" type="checkbox"/> • This happens when the air in the room is cooled into mist by the cold airflow during COOL or other operation.

Remote controller

Case	Description / what to check
The unit does not receive signals from the remote controller or has a limited operating range.	<input checked="" type="checkbox"/> • The batteries may be exhausted. Replace both batteries with new dry batteries AAA.LR03 (alkaline). For details, refer to "Preparation Before Operation": ▶ Page 10 • Signal communication may be disabled if an electronic-starter-type fluorescent lamp (such as inverter-type lamps) is in the room. Consult your dealer if that is the case. • The remote controller may not function correctly if the transmitter is exposed to direct sunlight.
LCD is faint, is not working, or the display is erratic.	<input checked="" type="checkbox"/> • The batteries may be exhausted. Replace both batteries with new dry batteries AAA.LR03 (alkaline). For details, refer to "Preparation Before Operation": ▶ Page 10
Other electric devices start operating.	<input checked="" type="checkbox"/> • If the remote controller activates other electric devices, move them away or consult your dealer.

Air has an odor

Case	Description / what to check
The air conditioner gives off an odor.	<input checked="" type="checkbox"/> • The room odor absorbed in the unit is discharged with the airflow. We recommend you to have the indoor unit cleaned. Please consult your dealer.

Others

Case	Description / what to check
The air conditioner suddenly starts behaving strangely during operation.	<input type="checkbox"/> • The air conditioner may malfunction due to lightning or radio. If the air conditioner malfunctions, turn off the power with the circuit breaker and restart the operation with the remote controller.

Notes on the operating conditions

- If operation continues under any conditions other than those listed in the table,
 - A safety device may activate to stop the operation.
 - Dew may form on the indoor unit and drip from it when COOL or DRY operation is selected.

Mode	Operating conditions
COOL / DRY	Outdoor temperature: 50-115°F (10-46°C) Indoor temperature: 64-90°F (18-32°C) Indoor humidity: 80% max.

When the Need Arises

Troubleshooting

■ Call your dealer immediately

WARNING

When an abnormality (such as a burning smell) occurs, stop operation and turn off the circuit breaker.

- Continued operation in an abnormal condition may result in troubles, electric shocks or fire.
- Consult the dealer where you bought the air conditioner.

Do not attempt to repair or modify the air conditioner by yourself.

- Incorrect work may result in electric shocks or fire.
- Consult the dealer where you bought the air conditioner.

If one of the following symptoms takes place, call your dealer immediately.

- The power cord is abnormally hot or damaged.
- An abnormal sound is heard during operation.
- The circuit breaker, a fuse, or the earth leakage circuit breaker cuts off the operation frequently.
- A switch or a button often fails to work properly.
- There is a burning smell.
- Water leaks from the indoor unit.

Turn off the circuit breaker and call your dealer.



■ After a power failure

- The air conditioner automatically resumes operation in about 3 minutes. You should just wait for a while.

■ Lightning

- If there is a risk lightning could strike in the neighborhood, stop operation and turn off the circuit breaker to protect the system.

■ Disposal requirements

- Dismantling of the unit, handling of the refrigerant, oil and other parts, should be done in accordance with the relevant local and national regulations.

When the Need Arises



■ Fault diagnosis by remote controller

- The remote controller can receive relevant error codes from the indoor unit.

1. When **CANCEL is held down for about 5 seconds, “00” blinks in the temperature display section.**

2. Press **CANCEL repeatedly until a continuous beep is produced.**

- The code indication changes as shown below, and notifies you with a long beep.

	CODE	MEANING
SYSTEM	00	NORMAL
	UA	INDOOR-OUTDOOR UNIT COMBINATION FAULT
	U0	REFRIGERANT SHORTAGE
	U2	DROP VOLTAGE OR MAIN CIRCUIT OVERVOLTAGE
	U4	FAILURE OF TRANSMISSION (BETWEEN INDOOR UNIT AND OUTDOOR UNIT)
INDOOR UNIT	A1	INDOOR PCB DEFECTIVENESS
	A5	HIGH PRESSURE CONTROL OR FREEZE-UP PROTECTOR
	A6	FAN MOTOR FAULT
	C4	FAULTY HEAT EXCHANGER TEMPERATURE SENSOR
	C9	FAULTY SUCTION AIR TEMPERATURE SENSOR
OUTDOOR UNIT	EA	COOLING-HEATING SWITCHING ERROR
	E1	CIRCUIT BOARD FAULT
	E5	OL STARTED
	E6	FAULTY COMPRESSOR START UP
	E7	DC FAN MOTOR FAULT
	E8	OVERCURRENT INPUT
	F3	HIGH TEMPERATURE DISCHARGE PIPE CONTROL
	F6	HIGH PRESSURE CONTROL (IN COOLING)
	H0	SENSOR FAULT
	H6	OPERATION HALT DUE TO FAULTY POSITION DETECTION SENSOR
	H8	DC CURRENT SENSOR FAULT
	H9	FAULTY SUCTION AIR TEMPERATURE SENSOR
	J3	FAULTY DISCHARGE PIPE TEMPERATURE SENSOR
	J6	FAULTY HEAT EXCHANGER TEMPERATURE SENSOR
	L3	ELECTRICAL PARTS HEAT FAULT
	L4	HIGH TEMPERATURE AT INVERTER CIRCUIT HEATSINK
L5	OUTPUT OVERCURRENT	
P4	FAULTY INVERTER CIRCUIT HEATSINK TEMPERATURE SENSOR	

NOTE

- A short beep indicates non-corresponding codes.
- To cancel the code display, hold **CANCEL** down for about 5 seconds. The code display also clears if no button is pressed for 1 minute.

12.2 Heat Pump

Read Before Operation

Safety Considerations

- Read these **Safety Considerations** for operation carefully before installing air conditioning equipment. After completing the installation, make sure that the unit operates properly during the startup operation. Instruct the customer on how to operate and maintain the unit. Inform customers that they should store this operation manual with the installation manual for future reference. Meanings of **DANGER**, **WARNING**, and **CAUTION** Symbols:

⚠ DANGER Indicates an imminently hazardous situation which, if not avoided, will result in death or serious injury.

⚠ WARNING Indicates a potentially hazardous situation which, if not avoided, could result in death or serious injury.

⚠ CAUTION Indicates a potentially hazardous situation which, if not avoided, may result in minor or moderate injury. It may also be used to alert against unsafe practices.

⚠ DANGER

- For refrigerant leakage, consult your dealer. Refrigerant gas is heavier than air and replaces oxygen. A massive leak could lead to oxygen depletion, especially in basements, and an asphyxiation hazard could occur leading to serious injury or death.
- Refrigerant gas may produce a toxic gas if it comes in contact with fire such as from a fan heater, stove or cooking device. Exposure to this gas could cause severe injury or death.
- Any abnormalities in the operation of the air conditioner such as smoke or fire could result in severe injury or death. Turn off the power and contact your dealer immediately for instructions.
- Do not install the unit in an area where flammable materials are present due to risk of explosion resulting in serious injury or death.
- If equipment utilizing a burner is used in the same room as the air conditioner, there is the danger of oxygen deficiency which could lead to an asphyxiation hazard resulting in serious injury or death. Be sure to ventilate the room sufficiently to avoid this hazard.
- Safely dispose of the packing materials. Packing materials, such as nails and other metal or wooden parts, may cause stabs or other injuries. Tear apart and throw away plastic packaging bags so that children will not play with them. Children playing with plastic bags face the danger of death by suffocation.

⚠ WARNING

- Do not put your finger or other objects into the air outlet or inlet as the fan is rotating at high speed and could cause injury. Always keep small children away from the unit during operation.
- Do not attempt to repair, relocate, modify or reinstall the air conditioner by yourself. Incorrect work or modifications could cause electric shocks, fire or other damage. For repairs and reinstallation, consult your Daikin dealer for advice and information.
- Do not use a refrigerant other than the one indicated on the outdoor unit (R410A) when installing, moving or repairing. Using other refrigerants may cause trouble or damage to the unit, and personal injury.
- Do not operate the air conditioner with wet hands.
- If the air conditioner is not cooling (heating) properly, the refrigerant may be leaking, contact your authorized dealer or qualified service repairman. When making repairs which requires adding refrigerant, consult with your authorized dealer or qualified service repairman.
- Do not attempt to install the air conditioner by yourself. Improper installation could result in water leakage, electric shocks or fire. For installation, consult your authorized dealer or a qualified technician.

⚠ CAUTION

- The air conditioner must be grounded. Improper grounding may result in electric shocks. Do not connect the grounding wire to a gas pipe, water pipe, lightning rod, or a telephone ground line. Follow all local and state electrical codes.
- Do not use this unit for cooling precision instruments, food, plants, animals or works of art.
- Never expose little children, plants or animals directly to the airflow.
- Do not block air inlets nor outlets. Impaired airflow may result in poor performance or equipment problems.
- Do not stand, sit, or place objects on the outdoor unit. To avoid injury, do not remove the fan guard.
- Do not place anything under the indoor or outdoor unit that must be kept away from moisture, such as electrical or electronic equipment. In certain conditions, moisture in the air may condense and drip.
- Check the unit stand and fittings for damage annually.
- Do not touch the air inlet and aluminum fins of outdoor unit. It may cause injury and/or damage the heat transfer surface.
- This appliance is NOT intended for use by young children or impaired persons without proper supervision.

Read Before Operation

- Young children should be supervised to ensure that they DO NOT play with or near the airflow of this appliance.
- Do not pull at the conduit or hang anything on it. Otherwise it will cause fire or electric shock.
- Do not touch the heat exchanger fins. Improper handling may result in injury.
- Do not turn off the power immediately after stopping operation. Always wait at least 5 minutes before turning off the power to avoid water leakage or other problems.
- Do not wash the indoor unit with excessive water, only use a slightly wet cloth.
- Do not place things such as vessels containing water or anything else on top of the unit. Water may penetrate into the unit and degrade electrical insulations, resulting in an electric shock.
- To avoid personal injury or equipment damage be sure to stop the operation, turn off the circuit breaker or pull out the supply cord before cleaning or servicing the unit. NOTE: More than one disconnect may be required to shut off all power.
- Do not connect the air conditioner to a power supply different from the one specified. It may cause improper operation or fire.
- Depending on the environment, state and local electrical codes, a ground fault circuit interrupter may be required. Improper grounding or lack of a ground fault circuit interrupter may result in electrical shock, injuries, or death.
- It is recommended to install a ground fault circuit interrupter if one is not already available. This helps prevent electrical shocks or fire.
- Arrange the drain hose to ensure smooth drainage. Improper drainage may cause water damage to the building, or its furnishing.
- Depending on the usage environment, water may leak from the air conditioner. If this happens, contact your Daikin dealer.
- The remote controller should be installed in such way that children cannot play with it.
- Do not place objects in direct proximity of the outdoor unit and do not let leaves and other debris accumulate around the unit.
Leaves attract small animals which can enter the unit. Once in the unit, such animals can cause malfunctions, smoke or fire when making contact with electrical parts.

Installation site

- Operate the air conditioner in a sufficiently ventilated area and not surrounded by obstacles. Do not use the air conditioner in the following places:
 - a. Places with a mist of mineral oil, such as cutting oil.
 - b. Locations such as coastal areas where there is a lot of salt in the air.
 - c. Locations such as hot springs where there is a lot of sulfur in the air.
 - d. Locations such as factories where the power voltage varies a lot.
 - e. In cars, boats, and other vehicles.
 - f. Locations such as kitchens where oil may splatter or where there is steam in the air.
 - g. Locations where equipment produces electromagnetic waves.
 - h. Places with an acid or alkaline mist.

Consider the nuisance of noise to your neighbors

- Pay Attention to Operating Sound. Be sure to use the following places:
 - a. Places that can sufficiently withstand the weight of the air conditioner yet can suppress the operating sound and vibration of the air conditioner.
 - b. Places where warm air from the air outlet of the outside unit or the operating sound of the outside unit does not annoy neighbors.
Make sure that there are no obstacles close to the outside unit. Obstacles close to the outside unit may drop the performance of the outside unit or increase the operating sound of the outside unit. Consult your dealer if the air conditioner in operation generates unusual sounds.

Electrical work

- For power supply, be sure to use a separate power circuit dedicated to the air conditioner.

System relocation

- Relocating the air conditioner requires specialized knowledge and skills. Please consult the dealer if relocation is necessary for moving or remodeling.

Read Before Operation

Names of Parts

FTX09NMVJU / FTX12NMVJU / FTXN09NMVJU / FTXN12NMVJU

Indoor Unit

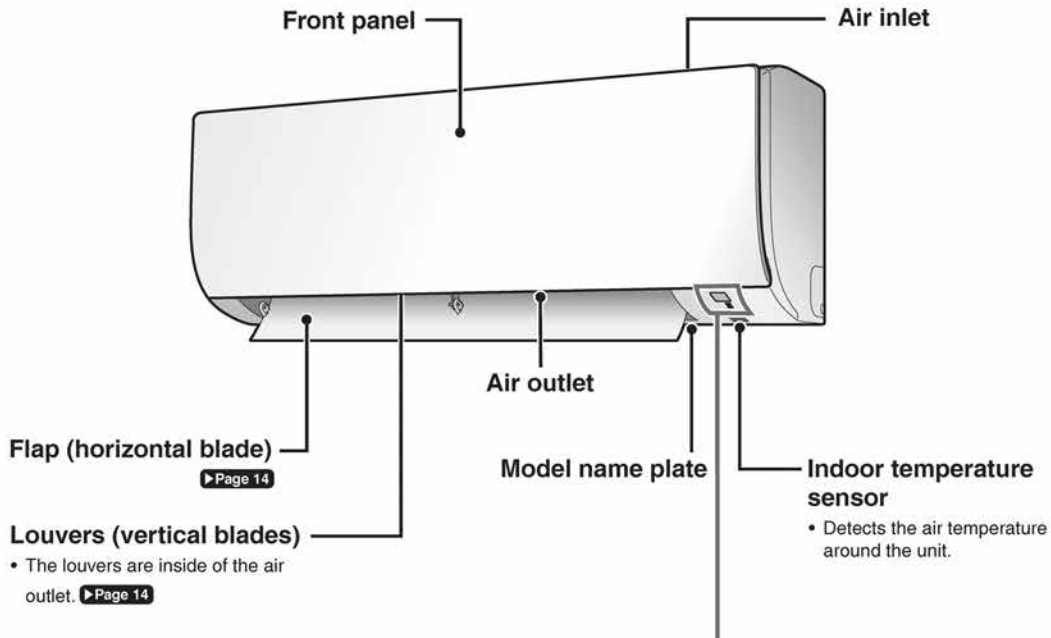

Display

Signal receiver

- Receives signals from the remote controller.
- When the unit receives a signal, you will hear a beep sound.

Case	Sound type
Operation start	beep-beep
Setting changed	beep
Operation stop	long beep

OPERATION lamp (green)

TIMER lamp (orange)
▶Page 17,18

Indoor unit ON/OFF switch

- Press this switch once to start operation. Press once again to stop it.
- For the operation mode setting, refer to the following table.

Mode	Temperature setting	Airflow rate
AUTO	77°F (25°C)	AUTO

- This switch can be used when the remote controller is missing.

Read Before Operation

■ **Open the front panel**

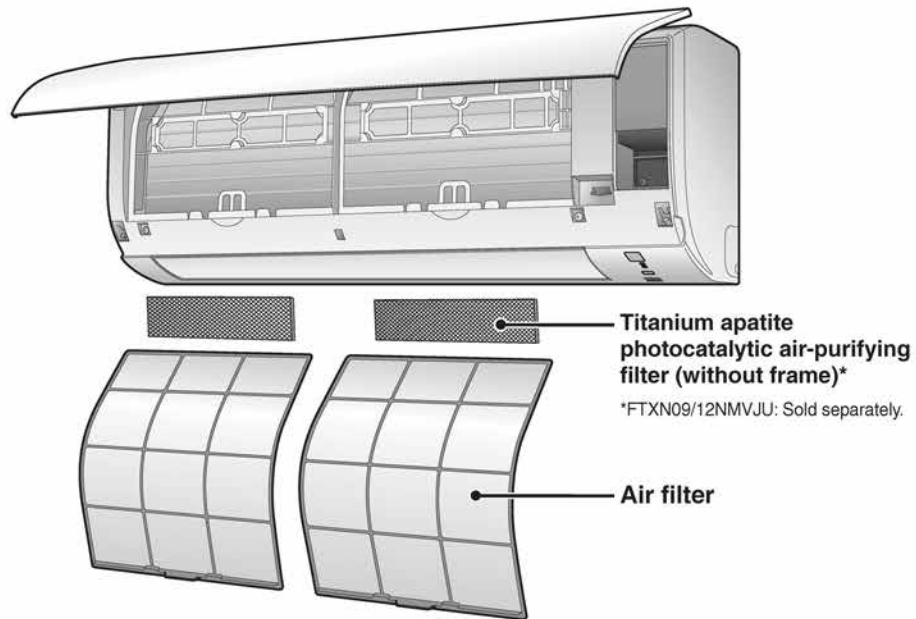

Outdoor Unit

• The appearance of the outdoor unit may differ between different models.

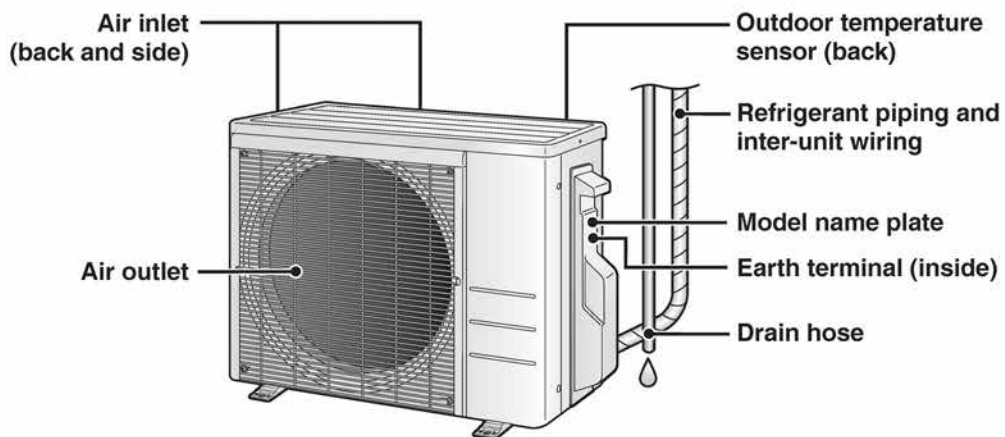

Read Before Operation

Names of Parts

FTX18NMVJU / FTX24NMVJU / FTXN18NMVJU / FTXN24NMVJU

Indoor Unit

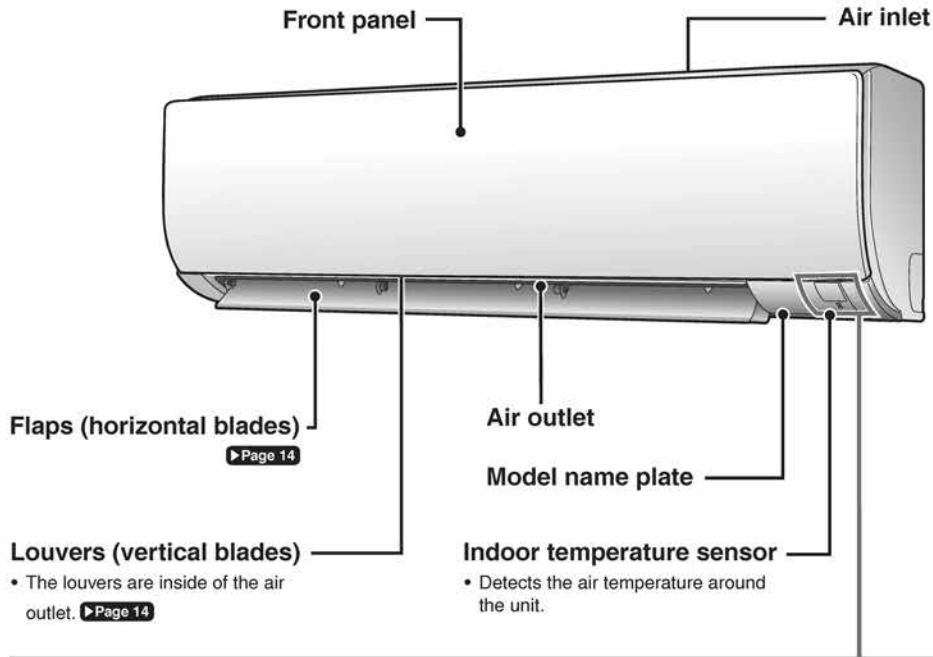

Display

Signal receiver

- Receives signals from the remote controller.
- When the unit receives a signal, you will hear a beep sound.

Case	Sound type
Operation start	beep-beep
Setting changed	beep
Operation stop	long beep

OPERATION lamp (green)

TIMER lamp (orange)
▶Page 17,18

Indoor unit ON/OFF switch

- Press this switch once to start operation. Press once again to stop it.
- For the operation mode setting, refer to the following table.

Mode	Temperature setting	Airflow rate
AUTO	77°F (25°C)	AUTO

- This switch can be used when the remote controller is missing.

Read Before Operation

■ **Open the front panel**

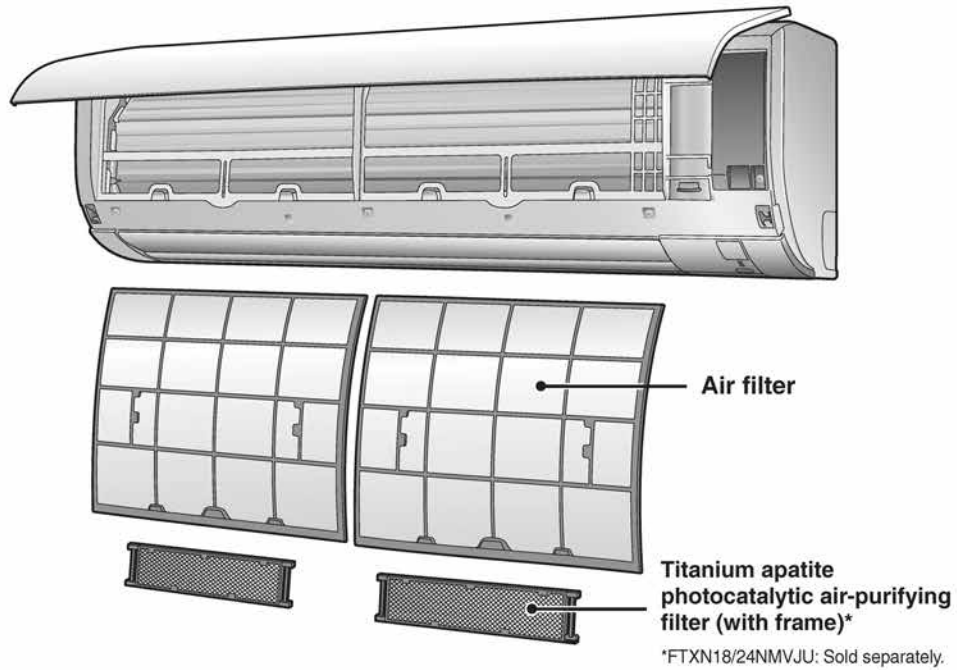

Outdoor Unit

• The appearance of the outdoor unit may differ between different models.

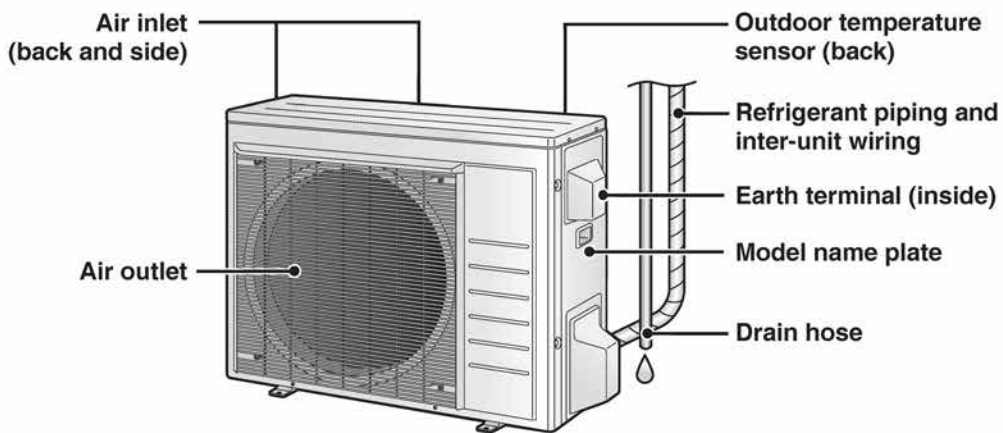

Read Before Operation

Names of Parts

Remote Controller

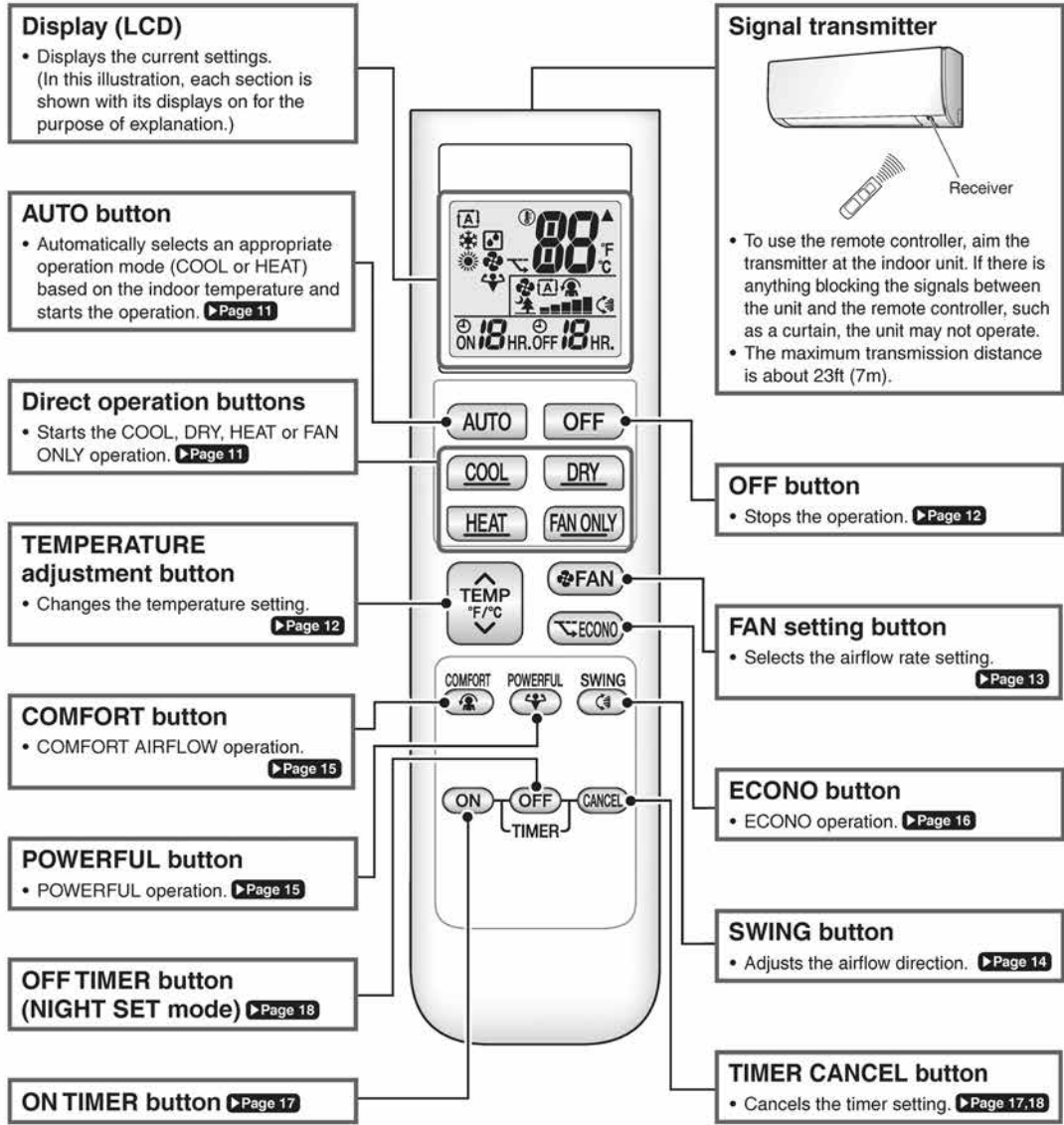

Unit	Remote Controller	
FTX09/12/18/24NMVJU	ARC480A8	with backlight
FTXN09/12/18/24NMVJU	ARC480A6	without backlight

Read Before Operation

Preparation Before Operation

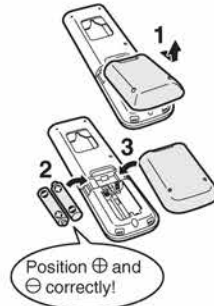

To insert the batteries

1. Remove the back cover by sliding and then slightly lifting it.
2. Insert 2 dry batteries AAA.LR03 (alkaline).
3. Replace the back cover.

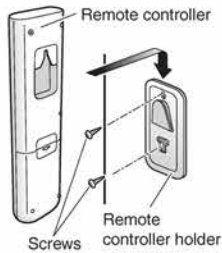

To fix the remote controller holder to a wall

1. Choose a place where the signals reach the unit.
2. Attach the holder to a wall, a pillar, or similar location with the screws supplied with the holder.
3. Hang the remote controller on the remote controller holder.



Fahrenheit/Celsius display switch

- Press  and  (TIMER button) simultaneously for about 5 seconds.

- The temperature will be displayed in Celsius when it is presently displayed in Fahrenheit, and vice versa.
- The switch operation is only possible when the temperature is being displayed.

Turn on the circuit breaker

- After the power is turned on, the flap of the indoor unit opens and closes once to set the reference position.

NOTE

Notes on batteries

- When replacing the batteries, use batteries of the same type, and replace both old batteries together.
- The batteries will last for about 1 year. If the remote controller display begins to fade and the possible transmission range becomes shorter within a year, however, replace both batteries with new, size AAA.LR03 (alkaline).
- The batteries supplied with the remote controller are for initial operation. The batteries may run out in less than 1 year.

Note on remote controller

- Do not drop the remote controller. Do not get it wet.

Fahrenheit/Celsius display change function of remote controller

- The set temperature may increase when the display is changed to Celsius from Fahrenheit, because a fraction of 0.5°C is rounded up.
- Example: A set temperature of 65°F (equivalent to 18.5°C) will be converted into 19°C. When the display is changed to Fahrenheit again, the set temperature will be converted into 66°F (equivalent to 19°C) instead of the original set temperature (65°F) but a set temperature of 66°F (equivalent to 19°C) will be converted into 19°C with no temperature change.
- A reception sound will go off for the transmission of set temperature to the indoor unit at the time of setting the Fahrenheit/Celsius display change function.

Basic Operation



AUTO · COOL · DRY · HEAT · FAN ONLY Operation



The air conditioner operates with the operation mode of your choice.

To start operation

AUTO operation

- To automatically select an appropriate temperature and operation mode.

Press **AUTO**.



COOL operation

- To lower the temperature.

Press **COOL**.



DRY operation

- To lower the humidity.

Press **DRY**.



HEAT operation

- To raise the temperature.

Press **HEAT**.



FAN ONLY operation

- To circulate air in the room.

Press **FAN ONLY**.



- The OPERATION lamp lights green.



Display

NOTE

Notes on AUTO operation

- In AUTO operation, the system selects an appropriate operation mode (COOL or HEAT) based on the indoor temperature and starts the operation.
- The system automatically reselects setting at a regular interval to bring the indoor temperature to the user-setting level.

Note on DRY operation

- Eliminates humidity while maintaining the indoor temperature as much as possible. It automatically controls temperature and airflow rate, so manual adjustment of these functions is unavailable.

Basic Operation



To stop operation

Press **OFF**.

- The OPERATION lamp goes off.

To change the temperature setting

Press **TEMP F/C**.

- Press **▲** to raise the temperature and press **▼** to lower the temperature.

COOL operation	HEAT operation	AUTO operation	DRY or FAN ONLY operation
64-90°F (18-32°C)	50-86°F (10-30°C)	64-86°F (18-30°C)	The temperature setting cannot be changed.

Tips for saving energy

Keeping the temperature setting at a moderate level helps save energy.

- Recommended temperature setting
 - For cooling: 78-82°F (26-28°C)
 - For heating: 68-75°F (20-24°C)

Cover windows with a blind or a curtain.

- Blocking sunlight and air from outdoors increases the cooling (heating) effect.

Keep the air filters clean.

- Clogged air filters cause inefficient operation and waste energy. Clean them once every 2 weeks. [▶ Page 20, 23](#)

If you are not going to use the air conditioner for a long period, for example in spring or autumn, turn off the circuit breaker.

- The air conditioner always consumes a small amount of electricity even while it is not operating.



Basic Operation



Adjusting the Airflow Rate

You can adjust the airflow rate to increase your comfort.

To adjust the airflow rate setting

Press **FAN**.

- Each pressing of **FAN** changes the airflow rate setting in sequence.

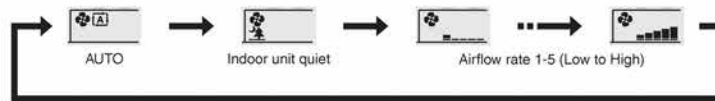

- When the airflow is set to “”, quiet operation starts and noise from the indoor unit will become quieter.
- In the quiet operation mode, the airflow rate is set to a weak level.

AUTO, COOL, HEAT and FAN ONLY operation	DRY operation
	<p>The airflow rate setting cannot be changed.</p>



NOTE

Note on airflow rate setting

- At smaller airflow rates, the cooling (heating) effect is also smaller.



Adjusting the Airflow Direction



You can adjust the airflow direction to increase your comfort.

⚠ CAUTION

- Always use a remote controller to adjust the angles of the flap. Moving the flap forcibly by hand may cause a malfunction.
- Be careful when adjusting the louvers. Inside the air outlet, a fan is rotating at a high speed.

To start auto swing

Up and down airflow direction

Press **SWING** .

- "☺" is displayed on the LCD.
- The flap (horizontal blade) will begin to swing.



To set the flap at the desired position

- This function is effective while the flap is in auto swing mode.

Press **SWING** when the flap reaches the desired position.

- "☺" disappears from the LCD.

To adjust the louvers at desired position

Hold the knobs and move the louvers (vertical blades).

FTX09NMVJU / FTX12NMVJU
FTXN09NMVJU / FTXN12NMVJU

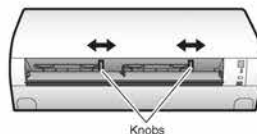

Knobs

FTX18NMVJU / FTX24NMVJU
FTXN18NMVJU / FTXN24NMVJU

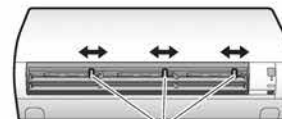

Knobs

NOTE

Notes on airflow direction setting

- The movable range of the flap varies according to the operation mode.
- The flap will stop at the upper position when the airflow rate is changed to low during the up and down swing setting.

Movable range of the flap

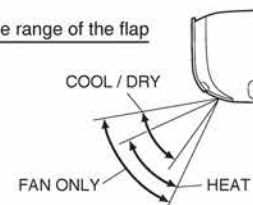

Useful Functions



COMFORT AIRFLOW Operation



The air direction and flow rate are adjusted so that the air will not blow directly at people in the room.

To start COMFORT AIRFLOW operation

Press  .

- "  " is displayed on the LCD.

	COOL and DRY operation	HEAT operation
Flap direction	Goes up	Goes down
Airflow rate	AUTO	

- Not available in FAN ONLY mode.

To cancel COMFORT AIRFLOW operation

Press  again.

- "  " disappears from the LCD.
- The flap will return to the memory position from before COMFORT AIRFLOW operation.



POWERFUL Operation



POWERFUL operation quickly maximizes the cooling (heating) effect in any operation mode. In this mode, the air conditioner operates at maximum capacity.

To start POWERFUL operation

Press  .

- "  " is displayed on the LCD.
- POWERFUL operation ends in 20 minutes. Then the system automatically operates again with the previous settings which were used before POWERFUL operation.

To cancel POWERFUL operation

Press  again.

- "  " disappears from the LCD.

Useful Functions



ECONO Operation



ECONO operation enables efficient operation by limiting the maximum power consumption.

This function is useful to prevent the circuit breaker from tripping when the unit operates alongside other appliances on the same circuit.

To start ECONO operation

Press .

- “” is displayed on the LCD.
- Not available in FAN ONLY mode.

To cancel ECONO operation

Press  again.



- “” disappears from the LCD.

NOTE



Note on COMFORT AIRFLOW operation

- If the up and down airflow direction is selected, the COMFORT AIRFLOW operation will be canceled.

Notes on POWERFUL operation

- Pressing  causes the settings to be canceled, and “” disappears from the LCD.
- POWERFUL operation will not increase the capacity of the air conditioner if the air conditioner is already in operation with its maximum capacity demonstrated.
 - In COOL, HEAT and AUTO operation
 - To maximize the cooling (heating) effect, the capacity of outdoor unit increases and the airflow rate becomes fixed at the maximum setting. The temperature setting cannot be changed.
 - In DRY operation
 - The temperature setting is lowered by 4.5°F (2.5°C) and the airflow rate is slightly increased.
 - In FAN ONLY operation
 - The airflow rate is fixed at the maximum setting.

Notes on ECONO operation

- Pressing  causes the settings to be canceled, and “” disappears from the LCD.
- If the power consumption level is already low, switching to ECONO operation will not reduce the power consumption.

Some useful functions can be used together.

COMFORT AIRFLOW + ECONO	Available
POWERFUL + COMFORT AIRFLOW	Not available*
POWERFUL + ECONO	Not available*

*Priority is given to the function of whichever button is pressed last.

TIMER Operation



ON/OFF TIMER Operation



Timer functions are useful for automatically switching the air conditioner on or off at night or in the morning. You can also use the ON TIMER and OFF TIMER together.

To use ON TIMER operation

Press **ON**.

"ON HR." is displayed on the LCD.

- Each pressing of **ON** advances the time setting by 1 hour. The time can be set between 1 and 12 hours.
- The TIMER lamp lights orange.



Display

To cancel ON TIMER operation

Press **CANCEL**.

- "ON HR." disappears from the LCD.
- The TIMER lamp goes off.

NOTE

In the following cases, set the timer again.

- After the circuit breaker has turned off.
- After a power failure.
- After replacing the batteries in the remote controller.

TIMER Operation



To use OFF TIMER operation

Press **OFF**.

"OFF 1HR." is displayed on the LCD.

- Each pressing of **OFF** advances the time setting by 1 hour. The time can be set between 1 and 12 hours.
- The TIMER lamp lights orange.

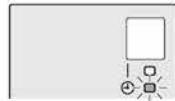

Display

To cancel OFF TIMER operation

Press **CANCEL**.

- "OFF 1HR." disappears from the LCD.
- The TIMER lamp goes off.

To combine ON TIMER and OFF TIMER operation

- A sample setting for combining the 2 timers is shown below.
- "ON" and "OFF" are displayed on the LCD.

[Example]

When setting while the unit is operating

- Stops the unit 1 hour later and starts it 7 hours after that.

When setting while the unit is stopped

- Starts the unit 2 hours later and stops it 3 hours after that.

NOTE**NIGHT SET mode**

- When the OFF TIMER is set, the air conditioner automatically adjusts the temperature setting (0.9°F (0.5°C) up in COOL, 3.6°F (2.0°C) down in HEAT) to prevent excessive cooling (heating) during sleeping hours.

Care

Care and Cleaning

FTX09NMVJU / FTX12NMVJU / FTXN09NMVJU / FTXN12NMVJU

CAUTION

- Before cleaning, be sure to stop the operation and turn off the circuit breaker.
- Do not touch the aluminium fins of the indoor unit. If you touch those parts, this may cause an injury.

Quick reference

Cleaning parts

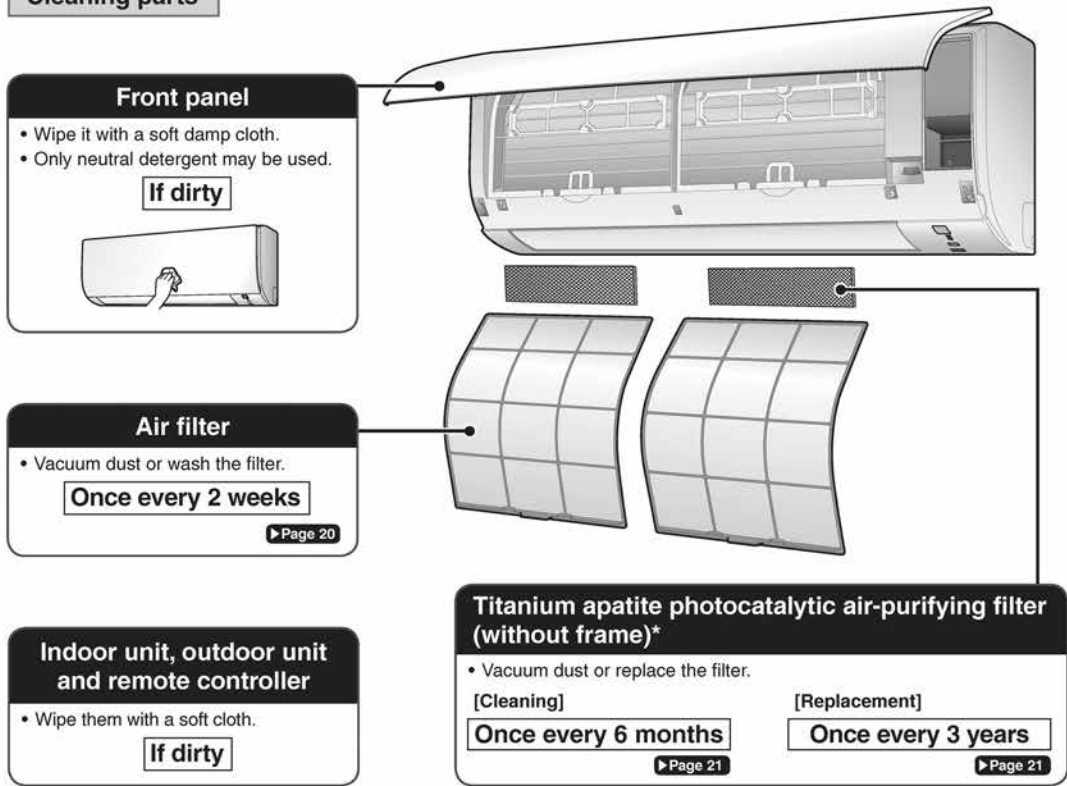

*FTXN09/12NMVJU: Sold separately.

NOTE

For cleaning, do not use any of the following:

- Water hotter than 104°F (40°C)
- Volatile liquid such as benzene, petrol and thinner
- Polishing compounds
- Rough materials such as a scrubbing brush



■ Air filter

1. Open the front panel.

- Hold the front panel by the sides and open it.

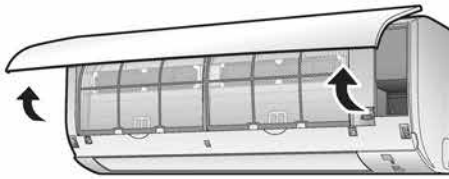

2. Pull out the air filters.

- Push the filter tab at the center of each air filter a little upwards, then pull it down.

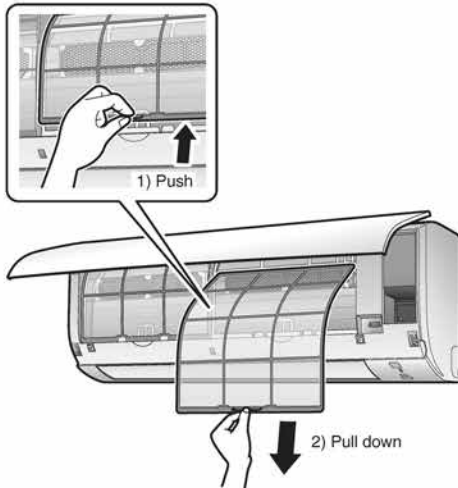

3. Wash the air filters with water or clean them with vacuum cleaner.

- It is recommended to clean the air filters every 2 weeks.

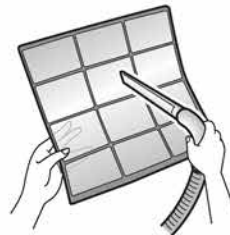

If the dust does not come off easily

- Wash the air filters with neutral detergent thinned with lukewarm water, then dry them up in the shade.



4. Reattach the filters.

5. Close the front panel slowly.

- Press the panel at both sides and the center.

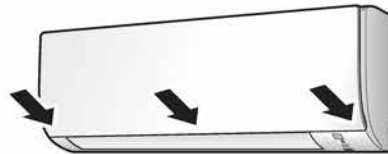

- Make sure that the front panel is securely fixed.

Care

Care and Cleaning

FTX09NMVJU / FTX12NMVJU / FTXN09NMVJU / FTXN12NMVJU

■ Titanium apatite photocatalytic air-purifying filter

1. Open the front panel and pull out the air filters. ▶Page 20

2. Take off the titanium apatite photocatalytic air-purifying filters.

- Remove the filters from the tabs.

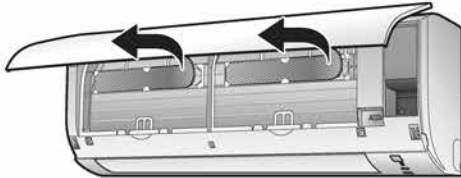

3. Clean or replace the titanium apatite photocatalytic air-purifying filters.

[Cleaning]

3-1 Vacuum dust, and soak in lukewarm water or water for about 10 to 15 minutes if very dirty.



3-2 After washing, shake off remaining water and let them dry in the shade.

- Do not wring out the filter to remove water from it.

[Replacement]

Remove the filter from the tabs and prepare a new one.



- Dispose of the old filter as non-flammable waste.

4. Insert the titanium apatite photocatalytic air-purifying filters as they were.

- When attaching the filter, check that the filter is properly set in the tabs.

5. Reattach the filters. ▶Page 20

6. Close the front panel slowly.

▶Page 20

NOTE

- Operation with dirty filters:
 - cannot deodorize the air,
 - cannot clean the air,
 - results in poor heating or cooling,
 - may cause odor.
- Dispose of old filters as non-flammable waste.
- To order a titanium apatite photocatalytic air-purifying filter, contact the dealer where you bought the air conditioner.

Item	Titanium apatite photocatalytic air-purifying filter 1 set
Part No.	KAF970A46 (without frame)

Care and Cleaning

FTX18NMVJU / FTX24NMVJU / FTXN18NMVJU / FTXN24NMVJU

⚠ CAUTION

- Before cleaning, be sure to stop the operation and turn off the circuit breaker.
- Do not touch the aluminium fins of the indoor unit. If you touch those parts, this may cause an injury.

■ Quick reference

Cleaning parts

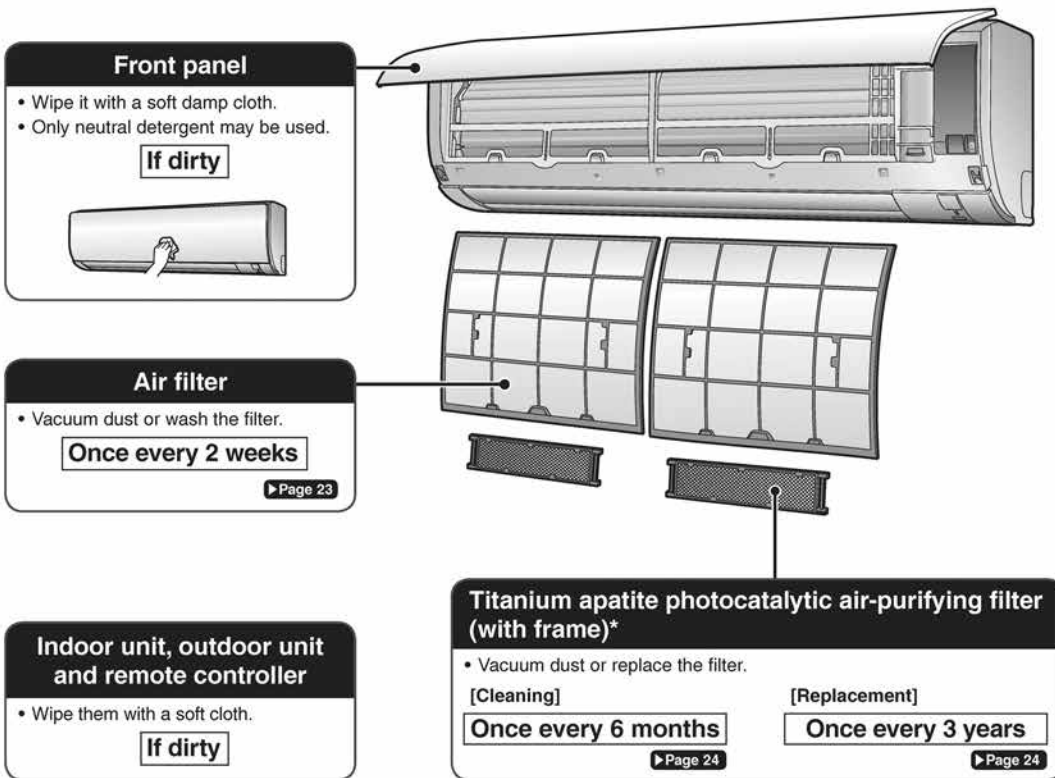

*FTXN18/24NMVJU: Sold separately.

NOTE

For cleaning, do not use any of the following:

- Water hotter than 104°F (40°C)
- Volatile liquid such as benzene, petrol and thinner
- Polishing compounds
- Rough materials such as a scrubbing brush



Care

Care and Cleaning

FTX18NMVJU / FTX24NMVJU / FTXN18NMVJU / FTXN24NMVJU

■ Air filter

1. Open the front panel.

- Hold the front panel by the sides and open it.

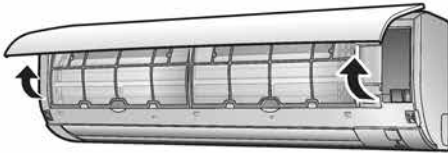

2. Pull out the air filters.

- Push the filter tab at the center of each air filter a little upwards, then pull it down.

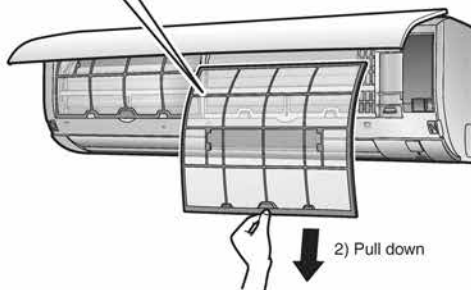
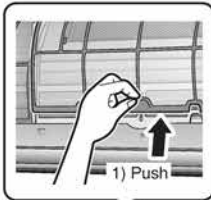

3. Wash the air filters with water or clean them with vacuum cleaner.

- It is recommended to clean the air filters every 2 weeks.



If the dust does not come off easily

- Wash the air filters with neutral detergent thinned with lukewarm water, then dry them up in the shade.
- Be sure to remove the titanium apatite photocatalytic air-purifying filter. Refer to "Titanium apatite photocatalytic air-purifying filter" on the next page.



4. Reattach the filters.

5. Close the front panel slowly.

- Press the front panel at both sides and in the central area.

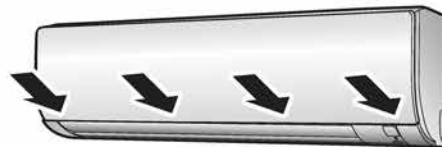

- Make sure that the front panel is securely fixed.

■ Titanium apatite photocatalytic air-purifying filter

1. Open the front panel and pull out the air filters. ▶ Page 23

2. Take off the titanium apatite photocatalytic air-purifying filters.

- Hold the recessed parts of the frame and unhook the 4 claws.

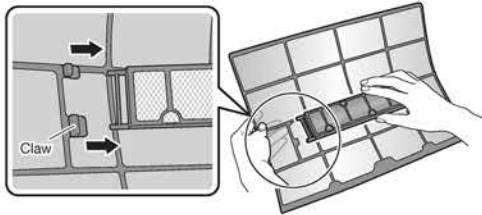

3. Clean or replace the titanium apatite photocatalytic air-purifying filters.

[Cleaning]

3-1 Vacuum dust, and soak in lukewarm water or water for about 10 to 15 minutes if very dirty.

- Do not remove the filter from the frame when washing with water.



3-2 After washing, shake off remaining water and let them dry in the shade.

- Do not wring out the filter to remove water from it.

[Replacement]

Remove the filter from the filter frame and prepare a new one.

- Do not throw away the filter frame. Reuse the filter frame when replacing the titanium apatite photocatalytic air-purifying filter.

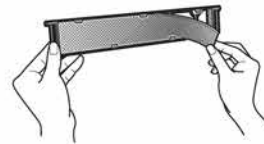

- Dispose of the old filter as non-flammable waste.

4. Insert the titanium apatite photocatalytic air-purifying filters as they were.

- When attaching the filter, check that the filter is properly set in the tabs.

5. Reattach the filters. ▶ Page 23

6. Close the front panel slowly.

▶ Page 23

NOTE

- Operation with dirty filters:
 - cannot deodorize the air,
 - cannot clean the air,
 - results in poor heating or cooling,
 - may cause odor.
- Dispose of old filters as non-flammable waste.
- To order a titanium apatite photocatalytic air-purifying filter, contact the dealer where you bought the air conditioner.

Item	Titanium apatite photocatalytic air-purifying filter 1 set
Part No.	KAF970A46 (without frame)
	KAF970A45 (with frame)*

*For customers who are using the FTXN18/24NMVJU, please purchase the KAF970A45 (with frame) during your initial purchase.

Care

Care and Cleaning

All models

■ Prior to a long period of non-use

1. Operate the FAN ONLY mode for several hours to dry out the inside.

- Press **FAN ONLY**.

2. After operation stops, turn off the circuit breaker for the room air conditioner.

3. Take out the batteries from the remote controller.

■ We recommend periodical maintenance

- In certain operating conditions, the inside of the air conditioner may get foul after several seasons of use, resulting in poor performance. It is recommended to have periodical maintenance by a qualified contractor in addition to regular cleaning by the user.
- For qualified contractor maintenance, please contact the dealer where you bought the air conditioner.

When the Need Arises

FAQ

Indoor unit

The flap does not start swinging immediately.

- The air conditioner is adjusting the position of the flap. The flap will start moving soon.

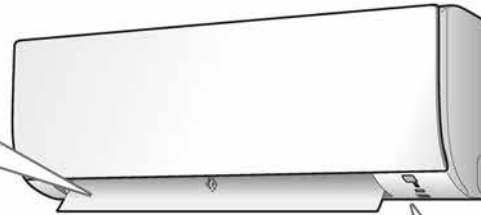
**The air conditioner stops generating airflow during HEAT operation.**

- Once the set temperature is reached, the airflow rate is reduced and operation stopped in order to avoid generating a cool airflow. Operation will resume automatically when the indoor temperature falls.

HEAT operation stops suddenly and a flowing sound is heard.

- The outdoor unit is defrosting. HEAT operation starts after the frost on the outdoor unit has been removed. This can take about 4 to 12 minutes.

Operation does not start soon.

- When **AUTO** or any direct operation button was pressed soon after operation was stopped.
- When the mode was reselected.
 - This is to protect the air conditioner. You should wait for about 3 minutes.

Different sounds are heard.■ **A sound like flowing water**

- This sound is generated because the refrigerant in the air conditioner is flowing.
- This is a pumping sound of the water in the air conditioner and can be heard when the water is pumped out from the air conditioner during COOL or DRY operation.

■ **Blowing sound**

- This sound is generated when the flow of the refrigerant in the air conditioner is switched over.

■ **Ticking sound**

- This sound is generated when the cabinet and frame of the air conditioner slightly expand or shrink as a result of temperature changes.

■ **Whistling sound**

- This sound is generated when refrigerant flows during defrosting operation.

■ **Clicking sound during operation or idle time**

- This sound is generated when the refrigerant control valves or the electrical parts operate.

■ **Clopping sound**

- This sound is heard from the inside of the air conditioner when the exhaust fan is activated while the room doors are closed. Open the window or turn off the exhaust fan.

Outdoor unit

The outdoor unit emits water or steam.

- **In HEAT operation**
 - The frost on the outdoor unit melts into water or steam when the air conditioner is in defrosting operation.
- **In COOL or DRY operation**
 - Moisture in the air condenses into water on the cool surface of the outdoor unit piping and drips.

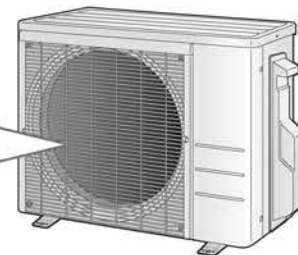

When the Need Arises

Troubleshooting

Before making an inquiry or a request for repair, please check the following.
If the problem persists, consult your dealer.



Not a problem

This case is not a problem.



Check

Please check again before requesting repairs.

The air conditioner does not operate

Case	Description / what to check
OPERATION lamp is off.	<ul style="list-style-type: none"> • Has the circuit breaker been tripped or the fuse blown? • Is there a power failure? • Are batteries set in the remote controller?
OPERATION lamp is blinking.	<ul style="list-style-type: none"> • Turn off the power with the circuit breaker and restart operation with the remote controller. If the OPERATION lamp is still blinking, check the error code and consult your dealer.

▶Page 30

The air conditioner suddenly stops operating

Case	Description / what to check
OPERATION lamp is on.	<ul style="list-style-type: none"> • To protect the system, the air conditioner may stop operating after sudden large voltage fluctuations. It automatically resumes operation in about 3 minutes.
OPERATION lamp is blinking.	<ul style="list-style-type: none"> • Is there anything blocking the air inlet or air outlet of the indoor unit or outdoor unit? Stop operation and after turning off the circuit breaker, remove the obstruction. Then restart operation with the remote controller. If the OPERATION lamp is still blinking, check the error code and consult your dealer. ▶Page 30

The air conditioner does not stop operating

Case	Description / what to check
The air conditioner continues operating even after operation is stopped.	<ul style="list-style-type: none"> <ul style="list-style-type: none"> ■ Immediately after the air conditioner is stopped <ul style="list-style-type: none"> • The outdoor unit fan continues rotating for about another 1 minute to protect the system. ■ While the air conditioner is not in operation <ul style="list-style-type: none"> • When the outdoor temperature is high, the outdoor unit fan may start rotating to protect the system.

The room does not cool down / warm up

Case	Description / what to check
Air does not come out.	<ul style="list-style-type: none"> <ul style="list-style-type: none"> ■ In HEAT operation <ul style="list-style-type: none"> • The air conditioner is warming up. Wait for about 1 to 4 minutes. • During defrosting operation, hot air does not flow out of the indoor unit.
Air does not come out / Air comes out.	<ul style="list-style-type: none"> <ul style="list-style-type: none"> ■ Is the airflow rate setting appropriate? <ul style="list-style-type: none"> • Is the airflow rate setting low, such as "Indoor unit quiet" or "Airflow rate 1"? Increase the airflow rate setting. ■ Is the set temperature appropriate? ■ Is the adjustment of the airflow direction appropriate?
Air comes out.	<ul style="list-style-type: none"> <ul style="list-style-type: none"> • Is there any furniture directly under or beside the indoor unit? • Is the air conditioner in ECONO operation? ▶Page 16 • Are the air filters dirty? • Is there anything blocking the air inlet or air outlet of the indoor unit or outdoor unit? • Is a window or door open? • Is an exhaust fan turning?

When the Need Arises

Mist comes out

Case	Description / what to check
Mist comes out of the indoor unit.	<input checked="" type="checkbox"/> • This happens when the air in the room is cooled into mist by the cold airflow during COOL or other operation.

Remote controller

Case	Description / what to check
The unit does not receive signals from the remote controller or has a limited operating range.	<input checked="" type="checkbox"/> • The batteries may be exhausted. Replace both batteries with new dry batteries AAA.LR03 (alkaline). For details, refer to "Preparation Before Operation". ▶ Page 10 <input checked="" type="checkbox"/> • Signal communication may be disabled if an electronic-starter-type fluorescent lamp (such as inverter-type lamps) is in the room. Consult your dealer if that is the case. <input checked="" type="checkbox"/> • The remote controller may not function correctly if the transmitter is exposed to direct sunlight.
LCD is faint, is not working, or the display is erratic.	<input checked="" type="checkbox"/> • The batteries may be exhausted. Replace both batteries with new dry batteries AAA.LR03 (alkaline). For details, refer to "Preparation Before Operation". ▶ Page 10
Other electric devices start operating.	<input checked="" type="checkbox"/> • If the remote controller activates other electric devices, move them away or consult your dealer.

Air has an odor

Case	Description / what to check
The air conditioner gives off an odor.	<input checked="" type="checkbox"/> • The room odor absorbed in the unit is discharged with the airflow. We recommend you to have the indoor unit cleaned. Please consult your dealer.

Others

Case	Description / what to check
The air conditioner suddenly starts behaving strangely during operation.	<input type="checkbox"/> • The air conditioner may malfunction due to lightning or radio. If the air conditioner malfunctions, turn off the power with the circuit breaker and restart the operation with the remote controller.

Notes on the operating conditions

- If operation continues under any conditions other than those listed in the table,
 - A safety device may activate to stop the operation.
 - Dew may form on the indoor unit and drip from it when COOL or DRY operation is selected.

Mode	Operating conditions
COOL / DRY	Outdoor temperature: 50-115°F (10-46°C) Indoor temperature: 64-90°F (18-32°C) Indoor humidity: 80% max.
HEAT	Outdoor temperature: 5-75°F (-15-24°C) Indoor temperature: 50-86°F (10-30°C)

When the Need Arises

Troubleshooting

■ **Call your dealer immediately**

 **WARNING**

When an abnormality (such as a burning smell) occurs, stop operation and turn off the circuit breaker.

- Continued operation in an abnormal condition may result in troubles, electric shocks or fire.
- Consult the dealer where you bought the air conditioner.

Do not attempt to repair or modify the air conditioner by yourself.

- Incorrect work may result in electric shocks or fire.
- Consult the dealer where you bought the air conditioner.

If one of the following symptoms takes place, call your dealer immediately.

- The power cord is abnormally hot or damaged.
- An abnormal sound is heard during operation.
- The circuit breaker, a fuse, or the earth leakage circuit breaker cuts off the operation frequently.
- A switch or a button often fails to work properly.
- There is a burning smell.
- Water leaks from the indoor unit.

Turn off the circuit breaker and call your dealer.



■ **After a power failure**

- The air conditioner automatically resumes operation in about 3 minutes. You should just wait for a while.

■ **Lightning**

- If there is a risk lightning could strike in the neighborhood, stop operation and turn off the circuit breaker to protect the system.

■ **Disposal requirements**

- Dismantling of the unit, handling of the refrigerant, oil and other parts, should be done in accordance with the relevant local and national regulations.

When the Need Arises



■ Fault diagnosis by remote controller

- The remote controller can receive relevant error codes from the indoor unit.

1. When **CANCEL** is held down for about 5 seconds, “00” blinks in the temperature display section.

2. Press **CANCEL** repeatedly until a continuous beep is produced.

- The code indication changes as shown below, and notifies you with a long beep.

	CODE	MEANING
SYSTEM	00	NORMAL
	UA	INDOOR-OUTDOOR UNIT COMBINATION FAULT
	U0	REFRIGERANT SHORTAGE
	U2	DROP VOLTAGE OR MAIN CIRCUIT OVERVOLTAGE
	U4	FAILURE OF TRANSMISSION (BETWEEN INDOOR UNIT AND OUTDOOR UNIT)
INDOOR UNIT	A1	INDOOR PCB DEFECTIVENESS
	A5	HIGH PRESSURE CONTROL OR FREEZE-UP PROTECTOR
	A6	FAN MOTOR FAULT
	C4	FAULTY HEAT EXCHANGER TEMPERATURE SENSOR
	C9	FAULTY SUCTION AIR TEMPERATURE SENSOR
OUTDOOR UNIT	EA	COOLING-HEATING SWITCHING ERROR
	E1	CIRCUIT BOARD FAULT
	E5	OL STARTED
	E6	FAULTY COMPRESSOR START UP
	E7	DC FAN MOTOR FAULT
	E8	OVERCURRENT INPUT
	F3	HIGH TEMPERATURE DISCHARGE PIPE CONTROL
	F6	HIGH PRESSURE CONTROL (IN COOLING)
	H0	SENSOR FAULT
	H6	OPERATION HALT DUE TO FAULTY POSITION DETECTION SENSOR
	H8	DC CURRENT SENSOR FAULT
	H9	FAULTY SUCTION AIR TEMPERATURE SENSOR
	J3	FAULTY DISCHARGE PIPE TEMPERATURE SENSOR
	J6	FAULTY HEAT EXCHANGER TEMPERATURE SENSOR
	L3	ELECTRICAL PARTS HEAT FAULT
	L4	HIGH TEMPERATURE AT INVERTER CIRCUIT HEATSINK
L5	OUTPUT OVERCURRENT	
P4	FAULTY INVERTER CIRCUIT HEATSINK TEMPERATURE SENSOR	

NOTE

- A short beep indicates non-corresponding codes.
- To cancel the code display, hold **CANCEL** down for about 5 seconds. The code display also clears if no button is pressed for 1 minute.

13. Optional Accessories

13.1 Option List

13.1.1 Indoor Unit

	Option Name	09/12 Class	18/24 Class
1	Wired remote controller ★1	BRC944B2 +KRP067A41	BRC944B2 +KRP980B2
2	Wired remote controller cord (shielded wire)	Length 9.8 ft (3 m)	BRCW901A03
		Length 26.3 ft (8 m)	BRCW901A08
3	Centralized control board-up to 5 rooms ★2	KRC72A	
4	Wiring adaptor for timer clock / remote controller ★3 (normal open pulse contact / normal open contact)	KRP413AB1S +KRP067A41	KRP413AB1S +KRP980B2
5	Central remote controller ★4	DCS302C71	
6	Unified ON/OFF controller ★4	DCS301C71	
7	Schedule timer controller ★4	DST301BA61	
8	Interface adaptor for DIII-NET (residential air conditioner)	KRP928BB2S +KRP067A41	KRP928BB2S +KRP980B2
9	Interface adaptor for residential air conditioner	KRP067A41	KRP980B2
10	Titanium apatite photocatalytic air-purifying filter (without frame)	KAF970A46 ★5	KAF970A46
11	Titanium apatite photocatalytic air-purifying filter (with frame)	—	KAF970A45 ★5
12	Remote controller loss prevention with chain	KKF936A4	

- Notes:**
- ★1 A wired remote controller cord BRCW901A03 or BRCW901A08 is necessary.
 - ★2 A wiring adaptor (KRP413AB1S) is also required for each indoor unit.
 - ★3 Timer clock and other devices ; obtained locally.
 - ★4 An interface adaptor (KRP928BB2S) is also required for each indoor unit.
 - ★5 Standard accessory

13.1.2 Outdoor Unit

	Option Name	09/12 Class	18/24 Class
1	Air direction adjustment grille	KPW937E4	KPW063A4
2	Back protection wire net	KKG067A41	KKG063A42
3	Side protection wire net	—	KKG063A43
4	Drain plug ★	KKP937A4	

- Note:** ★ Standard accessory for heat pump model

13.2 <BRC944B2> Wired Remote Controller

13.2.1 Installation Manual

⚠ CAUTION

1. No switch box or staple is supplied. Prepare them locally.
2. No remote controller cord is supplied. Prepare the optional remote controller cord 4 wire.
3. Be sure to turn off the power to any apparatus connected prior to mounting.
4. Prior to mounting equipment, touch something metallic such as a doorknob to remove static electricity from your body. Never touch the remote controller board or the adapter board.
5. Keep the wiring away from any other power source lines to avoid electric noise (external noise).
6. Select a flat surface, wherever possible, to mount the remote controller. To prevent deformation of the cases, do not overtighten the mounting screws.

1. Securing the remote controller lower case

Insert a bladed screwdriver into the concave (凹) in the remote controller lower case to remove the upper case assembly (two locations).

The remote controller board is located on the upper case. Take care not to scratch the board with the screwdriver.

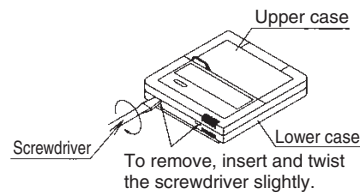

(1) Exposed mounting

Secure the remote controller lower case with the two supplied wood screws.



(2) Embedded mounting

Secure the remote controller lower case with the two supplied machine screws.

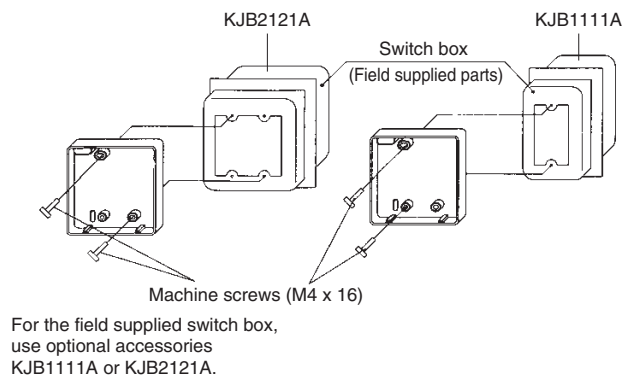

2. Securing the remote control adapter

Remove the upper case of the remote control adapter and secure the lower case assembly.

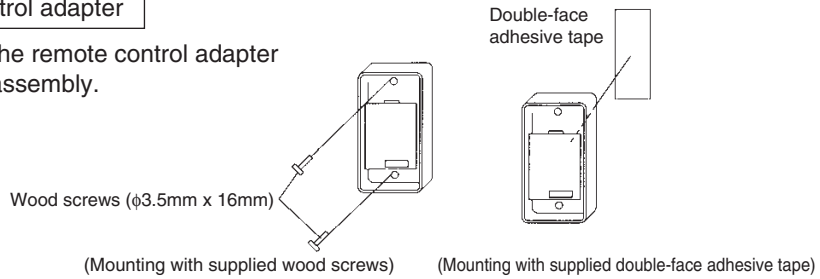

3. Wiring

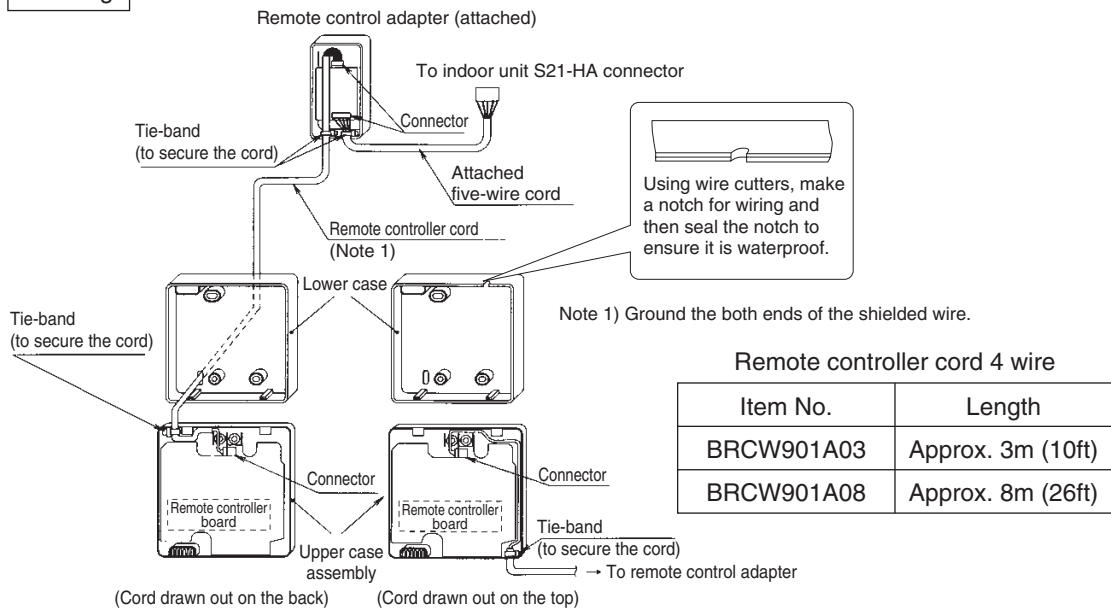

4. Placing the upper case assembly of the remote controller and the upper case of the remote controller adapter back into their original positions

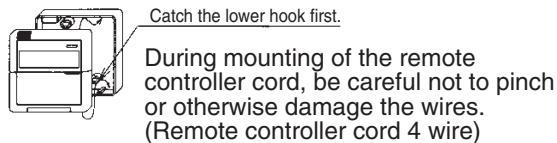

5. Temperature indication change

To change from Celsius temperature indication to Fahrenheit one

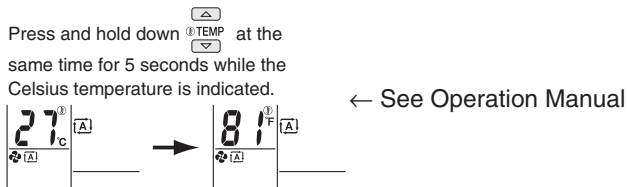

13.2.2 Operation Manual

Controller Commands and their Corresponding Functions

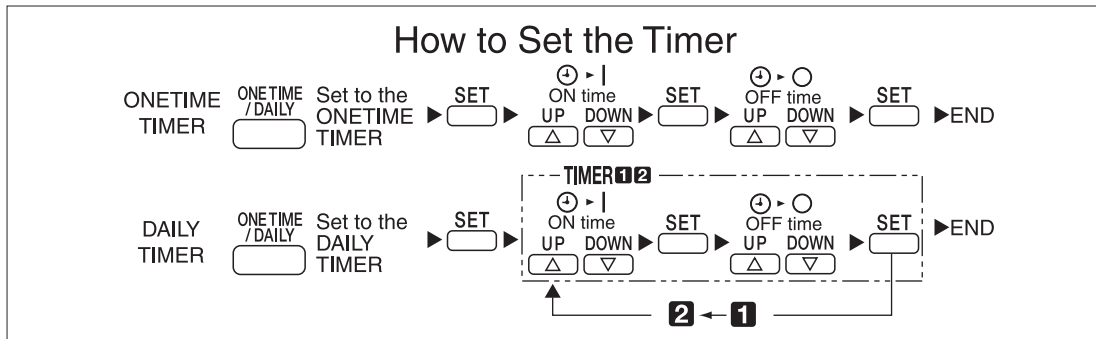
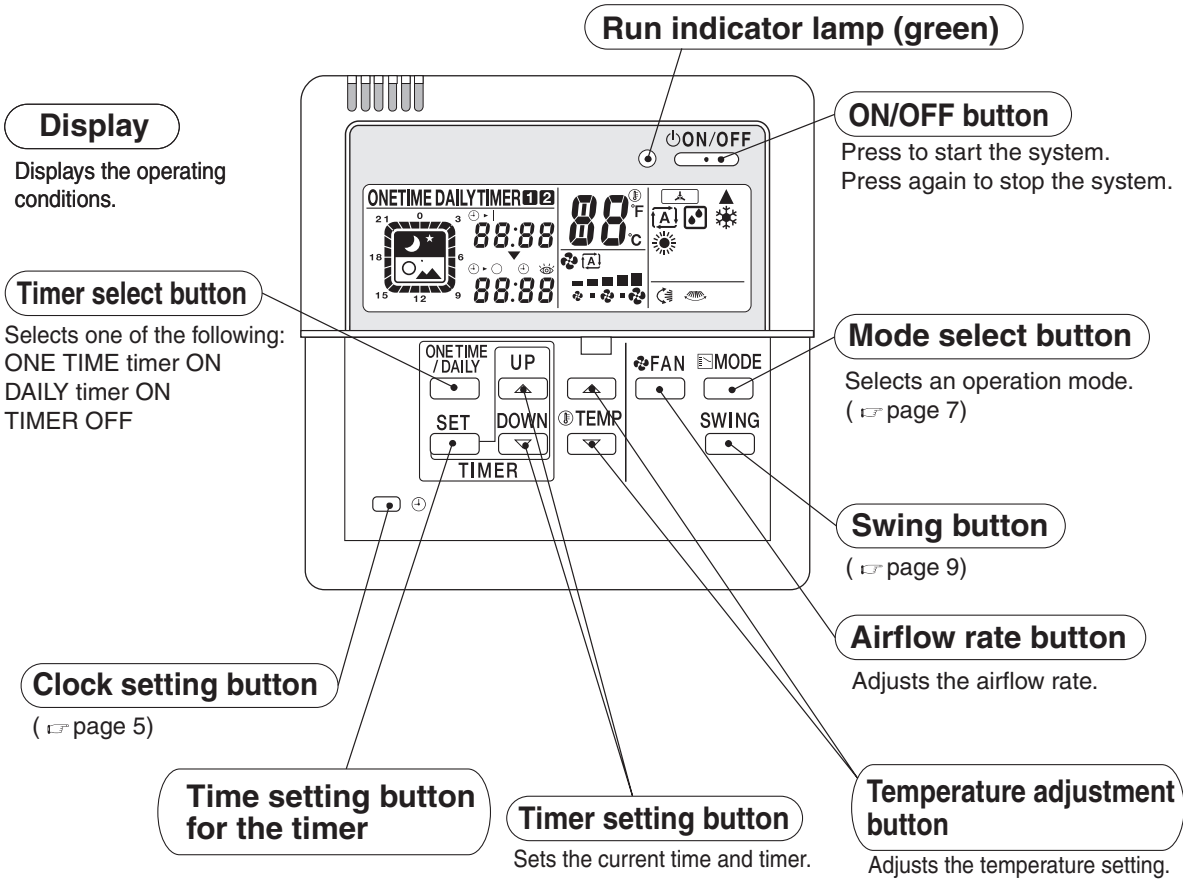

CAUTION

• This remote controller cannot be used together with a standard wireless remote controller. Otherwise, what appears on this remote controller's display may fail to correspond to actual operating conditions.

Preparation before Operation

■ Checking the power

If nothing appears on the remote controller's display, turn on the circuit breaker.

■ Setting the current time

1 Press  .



The current time starts blinking.
0:00 lights up.



2 Press  and set the current time.

- Hold the button down to rapidly advance the time.

3 Press  .

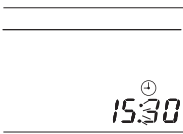

: blinks.
(This completes the current time setting)

- The clock's accuracy is ±30 seconds per month.

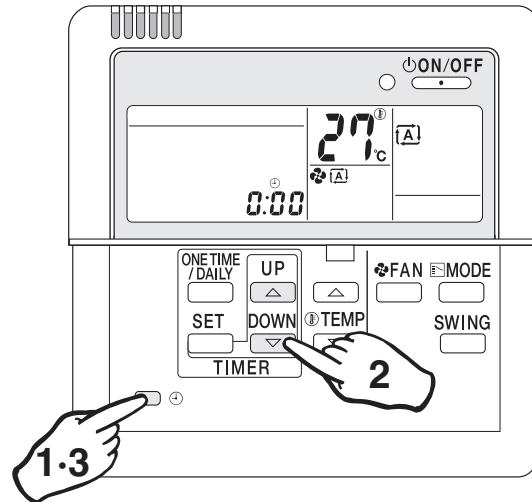

Notes

To use the unit efficiently

- Avoid overcooling or overheating. Moderate room temperature setting contributes to power saving.

Recommended temperature setting

For cooling 26~28°C (79°F~82°F)

For heating 20~22°C (68°F~72°F)
- Hang a blind or a curtain on the window. This will enhance the cooling/heating effect by intercepting direct sunlight and drafts.
- A clogged air filter reduces the cooling/heating effect and wastes energy. Clean the air filter monthly (every two weeks as required) or so.

Please take note of the following points

- Electric power is consumed even when the air conditioner is not in operation.
- When the unit is not used for a long period of time such as during off-season, turn off the breaker.

Operating conditions

- If the operation is continued under any conditions other than the following, the safety device may work to stop the operation. Also, dew may form on the indoor unit and drip from it. (Cooling/DRY)

Cooling	Outdoor temp.	-10 to 46°C (14°F to 115°F)
	Room temp.	18 to 32°C (64°F to 90°F)
	Indoor humidity	Less than 80%
DRY	Outdoor temp.	-10 to 46°C (14°F to 115°F)
	Room temp.	18 to 32°C (64°F to 90°F)
	Indoor humidity	Less than 80%
Heating	Outdoor temp.	-15 to 20°C (5°F to 68°F)
	Room temp.	Less than 27°C

- Operation limit differ according to the model.

Preparation before Operation

■ Setting Temperature Indication change

Temperature indication can be changed between Celsius and Fahrenheit before use.

To change from Celsius temperature indication to Fahrenheit one

- 1 Press and hold down  at the same time for 5 seconds while the Celsius temperature is indicated.

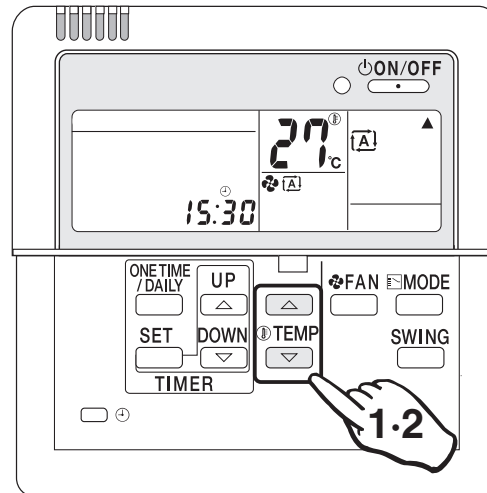

To change from Fahrenheit temperature indication to Celsius one

- 2 Press and hold down  at the same time for 5 seconds while the Fahrenheit temperature is indicated.



Notes

■ Temperature indication change between Celsius and Fahrenheit on the remote controller

- Change the temperature indication in the modes other than the DRY mode.
In the DRY mode, temperature indication setting cannot be changed because the temperature is not indicated.
- When the Fahrenheit temperature indication is changed to Celsius one, the temperature value (0.5°C) will be rounded up. Thus, the preset temperature may be changed.

Example:



A preset temperature of 65°F (equivalent to 18.5°C) will be changed to 19°C (66°F) by changing the temperature indication. In this case, if you change the Celsius temperature indication again to the Fahrenheit one, the preset temperature is shown not as 65°F but as 66°F (equivalent to 19°C). If the preset temperature is 66°F (equivalent to 19°C) and is changed to the Celsius temperature indication, the indication becomes 19°C (66°F). In this case, no change by the temperature indication change is observed.



- When the temperature indication change is set, the preset temperature is transmitted to the indoor unit so that the reception sound will be heard from the indoor unit.



Automatic·DRY·Cooling·Heating Operation

Select your desired operation mode.

Once preset, the system can get restarted in the same operation mode.

- 1** Press  to select your desired operation mode.
- Each time the button is pressed, the mode changes as follows.
-  → 
 (Automatic) → (DRY)

 ← 
 (Heating) ← (Cooling)

Heat pump model
-  → 
 (DRY) → (Cooling)

Cooling only model
- The system does not have the FAN mode.

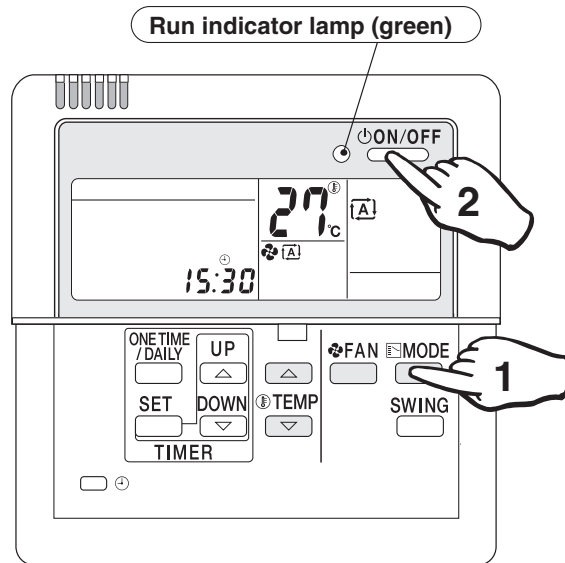

- 2** Press  .
- The run indicator lamp lights up.

■ **To stop the operation:**

- Press  again.
- The run indicator lamp goes out.

Automatic operation

- In Automatic, the temperature setting and operation mode (DRY, Cooling or Heating) are automatically selected according to the room temperature and outdoor temperature at the time of starting operation.

DRY operation







- In this mode, humidity is removed from the air.



Note

- While running in the DRY mode, you may feel cool or warm air from the air outlet. In this case, readjust the airflow direction with the vertical airflow direction louvers. (except Duct Connected type)

■ To adjust the temperature and airflow rate:

Setting to be adjusted / Operation mode	Automatic	Cooling	Heating	DRY
 (Temperature)	Temperature is adjustable. Recommended temperature Cooling : 26°C-28°C (79°F~82°F) Heating : 20°C-22°C (68°F~72°F)			Temperature cannot be adjusted.
 (Airflow rate)	Five levels of airflow rate setting from "  " to "  " plus "  " are available. 			Airflow rate cannot be adjusted.

- When the unit runs in the cooling or heating mode at a low airflow rate, the cooling or heating effect may be insufficient.

■ To adjust the airflow direction:

( page 9)

Heating operation

- Since the heating operation is performed by taking the heat from outdoor into the room, the heating capacity decreases as the outdoor temperature lowers. If the room is not heated sufficiently, it is recommended to use other heating appliance at the same time.
- Since the air conditioner heats the whole room by circulating hot air, it takes some time to heat the entire room completely.
- If the outdoor unit gets frosted during heating operation, the heating capacity is decreased. In this case, the unit starts defrosting operation.
- No hot air comes out of the indoor unit during defrosting operation.

Adjusting Airflow Direction

Adjust the airflow direction for maximum comfort.

To adjust the Airflow Direction

- 1 Press SWING during operation.
 - Each time the button is pressed, the airflow direction louvers change their movement.

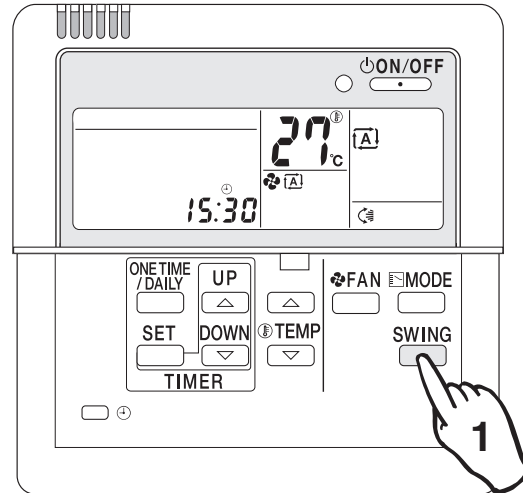

■ Wall Mounted Types (without horizontal swing function)

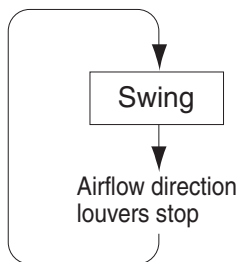

The horizontal airflow direction louvers move up and down.

The louvers stop just when the button is pressed.

Adjustment of horizontal airflow direction

- The automatic moving range of the horizontal airflow direction louvers varies depending on the operation mode.



Notes

- In fixing the horizontal airflow direction, keep the horizontal airflow direction louvers tilted downward in the heating mode, and keep them nearly horizontal level in the cooling or DRY mode. This will enhance the cooling and heating effect.
- On the air conditioners with vertical and horizontal swing function, be sure to adjust the airflow directions using the remote controller. Do not forcibly adjust louvers by hand or a malfunction may occur.

■ Wall Mounted Type (with horizontal swing function)

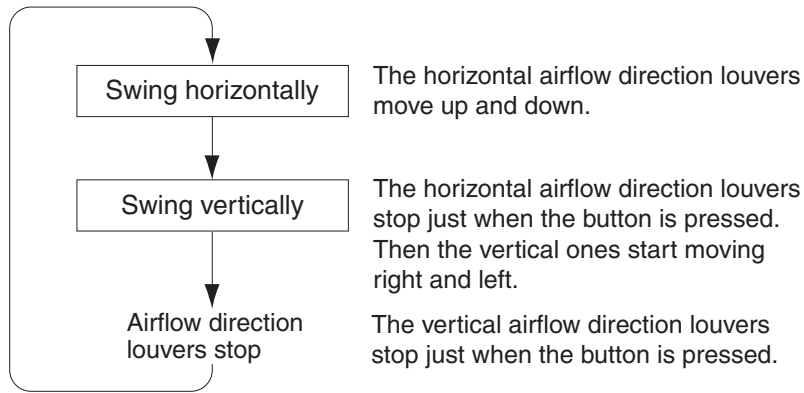

- The vertical and horizontal louvers cannot move at the same time.

■ Duct Connected Type (without swing function)

This function cannot be used.



Note

- The operating procedure and remote controller display are different depending on the indoor unit being connected. Read **How to Adjust the Airflow Direction** in the air conditioner's Operation Manual.

Timer Operation

The Timer Operation feature automatically turns off operation when you go to sleep and turns it back on when you wake up.

Use the DAILY Timer mode on weekdays, and the ONE TIME timer mode on weekends.

■ To select the ONE TIME timer mode:

1 Press  to select the ONE TIME timer mode.

- Each time the button is pressed, the modes change as follows.

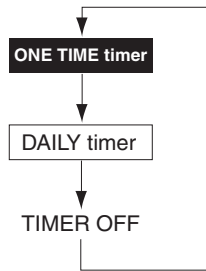

The timer lamp lights up.

■ To cancel the timer settings:

1 Press  to clear the timer settings.

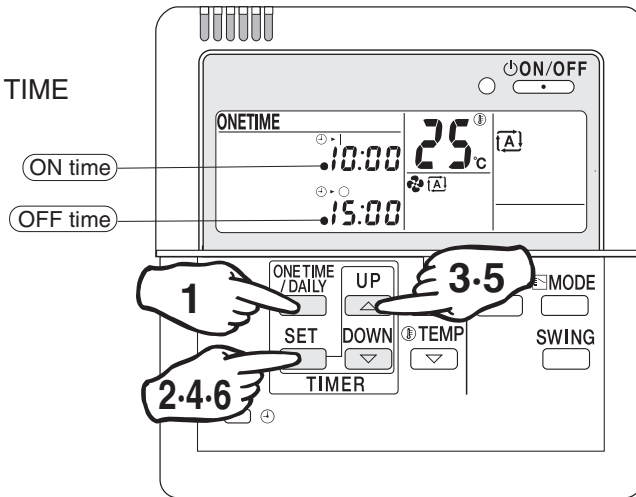
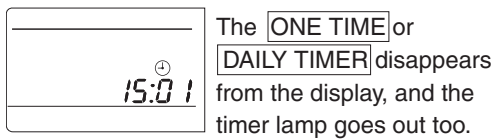

(Timer settings displayed)



Notes

- Even when the timer has been off, its programmed settings are still in memory.
- If the system has the timer control ON but you start and stop it manually using the ON/OFF button before the designated ON time, the system will restart again at the programmed ON time.

Precautions in setting the timer

- Before starting the timer operation, make sure the current time is correct. If not, set the clock correctly. (☞ page 5)
- In making time settings, --:-- is displayed to make it easy to disable the timer too.
- If one minute has passed before making any timer setting, the previous timer settings are reintroduced and the timer is on standby.



In this case, use the  (time setting) button and make your desired timer settings.

Timer operation

- When the ON timer is programmed, the system starts one hour (maximum) earlier so that the temperature set by the remote controller is reached just in time.
- When the ONE TIME timer is programmed, the current time is no longer displayed.

■ ONE TIME timer



Once the timer has been activated and then deactivated, it is in the OFF mode. The ON or OFF timers can be programmed.

1 Press  to select the ONE TIME timer. **4** Press  .

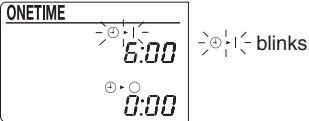

 light up.

2 Press  .

 blinks.

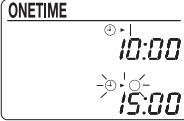
5 Press   to make the OFF timer setting.

 When the OFF timer is not used, save the setting as 0:00:--:--.

3 Press   to make the ON timer setting.

 When the ON timer is not used, save the setting as 0:0:--:--

- Each time the button is pressed, the setting changes in a 10-minute increment or decrement. Hold the button down to advance quickly.

6 Press  .
(The ONE TIME timer is now programmed.)

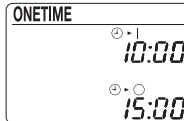
 Both of the ON and OFF time cannot be set as --:--:--

Example of display with the ONE TIME timer programmed

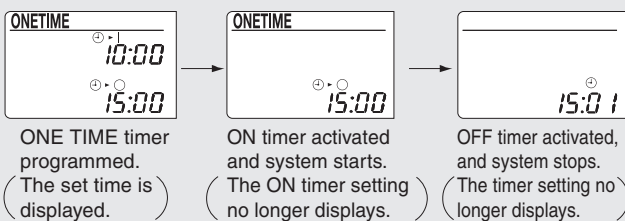

Notes

- In the following cases, reset the clock (the time setting is kept in the memory).
 - The circuit breaker has been activated.
 - The power fails.

Timer Operation

■ To select the DAILY timer mode:

1 Press  to select the DAILY timer mode.

- Each time the button is pressed, the modes change as follows.

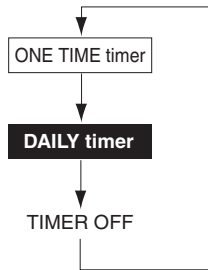

The timer lamp lights up.

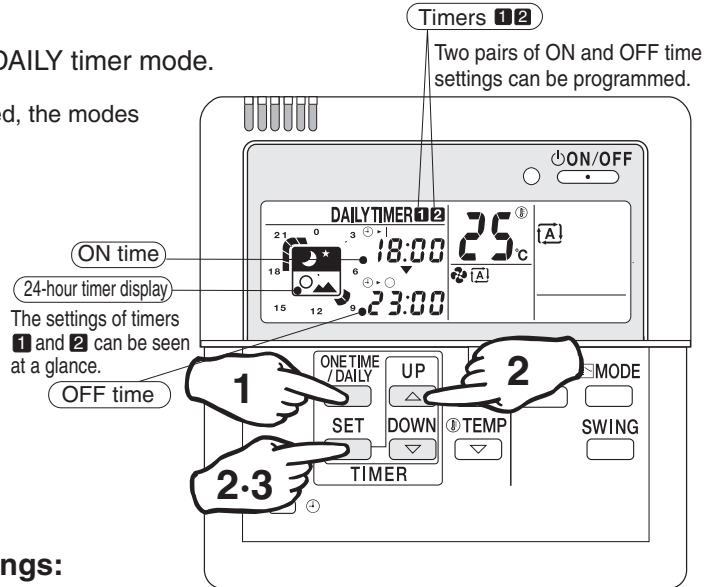

(Timer settings displayed)

■ To cancel the timer settings:

1 Press  to clear the timer settings.

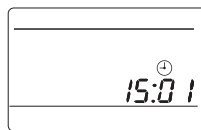

The **ONE TIME** or **DAILY TIMER**, and the timer lamp are no longer displayed.

Example of display with DAILY timer programmed

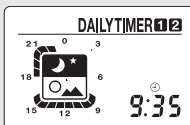

Timers **1** and **2** programmed.

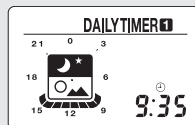

Timer **1** alone programmed.





Note



- The system starts and stops repeatedly until the DAILY timer is set off. Before you leave home for a long time, set the DAILY timer off.

■ **DAILY timer**

After programming, the system starts and stops each day at the preset times. Two pairs of time settings can be programmed.

(Example: 8:00 ~ 10:00, and 18:00 ~ 23:00)

- 1 Press  to select the DAILY timer. DAILY timer indication appears.  lights up.
- 2 Make the ON and OFF time settings. • Take the steps from ① to ⑧.
Program example: 8:00 ~ 10:00, and 18:00 ~ 23:00

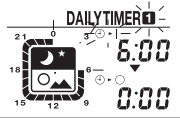
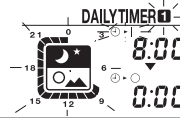
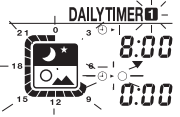
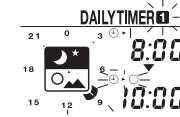
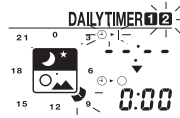
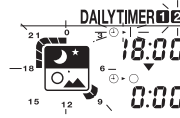
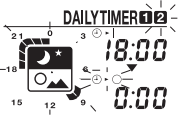
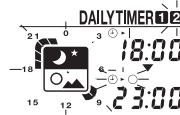
Settings		Procedure	
		Press 	Press  to make the timer setting. 
Timer 1	ON time setting • When the timer 1 is not used, save the setting as $\odot \cdot \cdot - \cdot -$	① 	② 
	OFF time setting	③ 	④ 
Timer 2	ON time setting • When the timer 2 is not used, save the setting as $\odot \cdot \cdot - \cdot -$	⑤ 	⑥ 
	OFF time setting	⑦ 	⑧ 

- 3 Press  . The DAILY timer is now programmed.



Note

- If the following appears on the display, the timer must be reprogrammed.

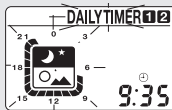

The 24-hour timer display is blinking.

This means that Timers 1 and 2 are programmed for the same time settings. New time settings must be made.



The 24-hour timer display is blinking.

This means that the timer has not been programmed yet.

Cleaning

Cleaning the remote controller

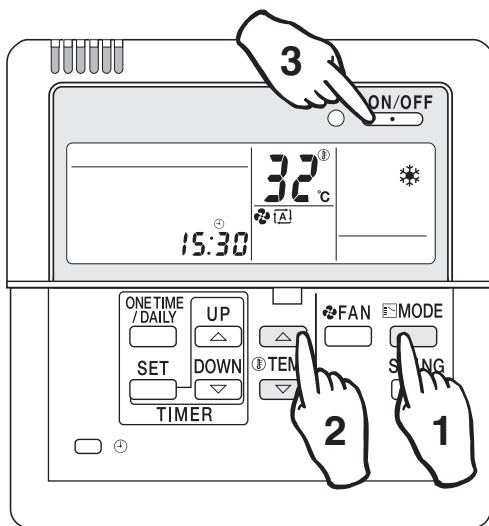

- Wipe it clean with soft, dry cloth.
Do not use any water hotter than 40°C (104°F), or volatile liquids such as benzine, gasoline and thinner, polishing powder, or anything hard such as a scrub brush.

When the unit is not used for a long time



- On a sunny day, keep the system running for half a day in the FAN mode to dry it up inside.

FAN mode

- Press  to select the cooling mode.
 - Press  to adjust the set temperature to 32°C (90°F).
 - Press  .
 - The airflow rate remains the same, and is not adjustable.
 - Run the system when the room temperature is below 28°C (82°F).
- Finally turn off the circuit breaker dedicated for the room air conditioner.
 - Clean the air filter and place it back into position.

13.3 <KRC72A> Centralized Control Board-Up to 5 Rooms

1. Appearance and Functions

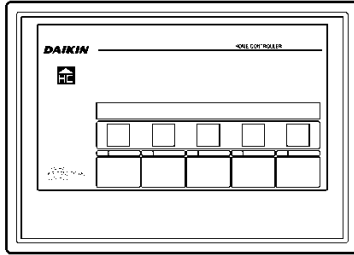

- Centralized control can apply to max. 5 Room Air conditioners handling from one location.
- Contribute to save energy by eliminating turn-off of lamps.
- Possible to control the action of ON/OFF individually for each Room Air conditioner.
(Last command priority is adopted from either an indoor remote controller or a home controller.)
- It understands an operation situation with the operation display lamp.

2. Accessories

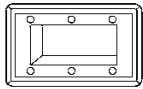
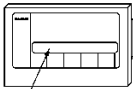
Lower casing × 1	Control panel × 1	Room label × 1
		M4 truss small screw × 6
	Room label	Manual × 1
		Switch box

4. External Dimensions

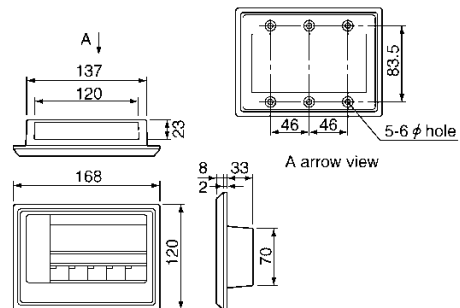

3. Indispensable Optional Accessories

- Central remote controller for 5 Room Air conditioners <KRC72>
- Remote control PC board <KRP413A1S>

5. Controller

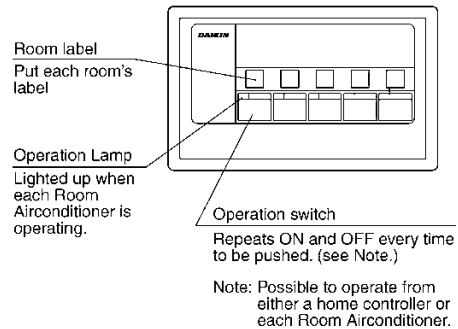

6. Wiring Example

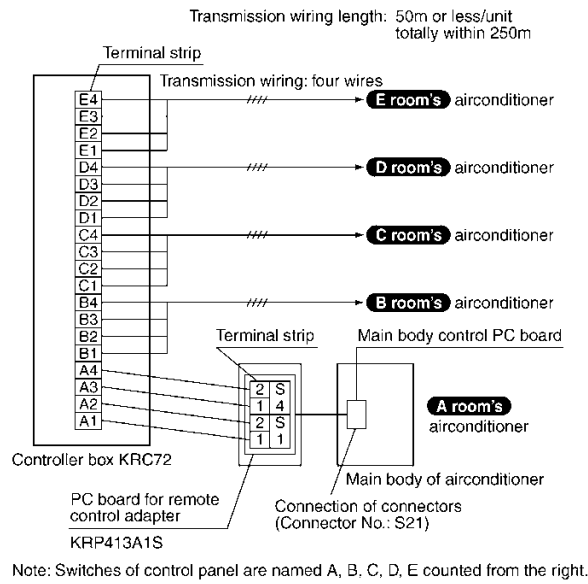

7. Key Points

- Connect to the terminal number 1 ~ 4 on the control panel as shown below.

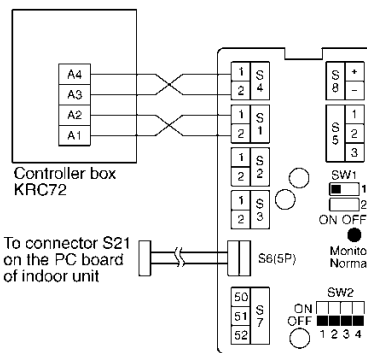

8. Switch Setting of KRP413A1S

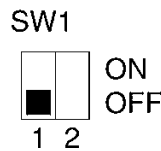

- Choose the action mode 1 by switching SW1-1 to OFF.



13.4 <KRP413AB1S> Wiring Adaptor for Timer Clock / Remote Controller

Safety Precautions

- Read these safety precautions carefully before installing the unit, and be sure to install the unit properly.
- This manual classifies precautions to the user into the following two categories. These warnings and cautions are for your safety. Follow them.

 WARNING	Faulty installation can result in death or serious injury.
 CAUTION	Faulty installation can result in serious injury, damage to property, or other serious consequences.

- After installation is complete, test the unit to confirm that it is working properly, and instruct the owner its proper use.

WARNING

- Installation should be left to the dealer from whom you purchased the unit, or another qualified professionals.
- Install the unit securely according to the installation manual. Faulty installation may lead to electric shock or fire.
- Be sure to use the supplied or specified parts. Using other parts may lead to electric shock or fire.
- Install the unit securely in a location that will support its weight. If installed in a poor location or improperly installed, the unit may not work as intended.
- For electrical work, follow local electric standards and the installation manual. Faulty installation may lead to fire or electric shock.
- Do not bundle the power cord, or attempt to extend it by splicing it with another cord or by using an extension cord. Do not place any other load on the power circuit used for the unit. Improper wiring may lead to electric shock, heat generation or fire.
- Use dedicated wiring for all electrical connections, and be sure to arrange the wiring so that force applied to the wiring will not damage the terminals. Poor wiring or installation may cause electric shock, heat generation or fire.

CAUTION

- Before installation, unplug the air conditioner to ensure safety. Failure to do so may cause electric shock.
- Static electricity may damage electric components. Before connecting cables and communication lines, and operating the switches, be sure to discharge any electrical charge from your body (by, for example, touching the earth line)
- Do not install the unit in a location where it may be exposed to flammable gases. If gas leaks and build up around the unit, it may catch fire.
- Do not place the wiring close to the power cord, inter-unit cable, or pipes which generate noise. Treat the wiring with care.

1. Functions and Features

- On/Off setting
- Switching between Instantaneous Contact/Normal Contact
- Connection with five-room central controller (KRC72 for oversea model)
- Connection with fan coil remote controller
- Automatic reset after power failure
- Output of normal operation signals/malfunction signals

2. Field Wiring

For interconnecting wiring, use Daikin KDC100A12 cable (not supplied) or other similar cable. Use a vinyl-covered wire or cable with four conductors each with a thickness of 0.2 to 1.25 mm².

■ Optional cable KDC100A12 (without connectors)

Specifications: 0.2 mm² × 4 core (sheathed)
 Outer diameter: φ5.3
 Length: 100 m
 Colour: Grey

Note : Keep any wiring for the control unit away from the power cord to prevent electrical noise.

Installation ①

1 Installation diagram

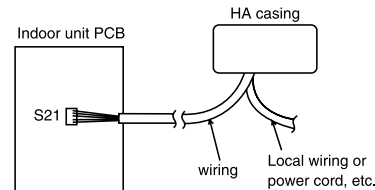

2 Components

① HA casing ASSY

(Remote Control PCB is attached in the HA casing.)

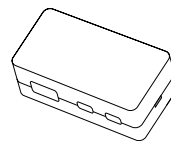

② Wiring (approx. 0.8 m)

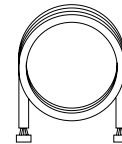

③ Accessories

- Binding band (6 pcs.)
- Screws for attaching to the wall (3 pcs.)

④ Installation manual

Installation ②

Attaching HA Case ASSY

- Use the 3 supplied screws to attach the HA casing ASSY.

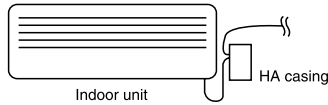

Install the HA casing ASSY as close to the indoor unit as possible.

① Removal of upper HA casing

- (1) Insert a flat-blade screwdriver into the groove between the upper and lower HA casings.

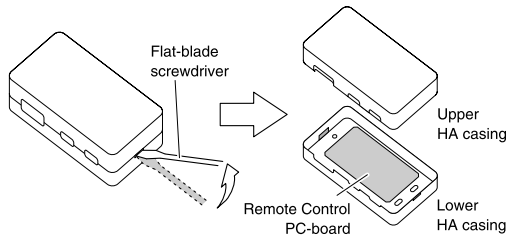

- (2) Lift the handle of the screwdriver upward.

- ② Mount and secure the lower HA casing directly on the wall with the provided screws inserted into the screw holes (a round hole and two ellipse holes) of the casing.

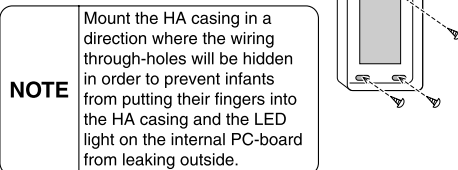

NOTE

Mount the HA casing in a direction where the wiring through-holes will be hidden in order to prevent infants from putting their fingers into the HA casing and the LED light on the internal PC-board from leaking outside.

- ③ After connecting the cables (refer to the following sections), replace the case front. Be careful not to damage the wiring in the case.

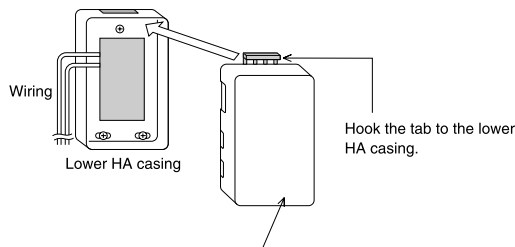

Press the lower part of the upper HA casing and press fit it onto the lower HA casing.
Press the upper HA casing precisely until a clicking sound is heard.

Wiring ①

1. Wiring

- ① Connect one end of the wiring to connector S21 of the PCB in the indoor unit.
- ② Connect the other end of the wiring to connector S6 of the Remote Control PCB.
- ③ Connect field wiring according to the functions assigned to each connection terminal of the Remote Control PCB.
- ④ Secure all wires.

1 Securing wires in the HA casing ASSY

① Connection of wiring

Connect the wiring to the connector terminals.

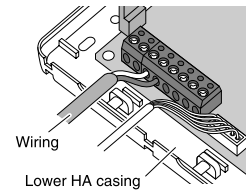

② Fixation of wiring

- (1) Insert the provided binding band under the pillar of the HA casing and secure the covers of the wiring with the binding band.

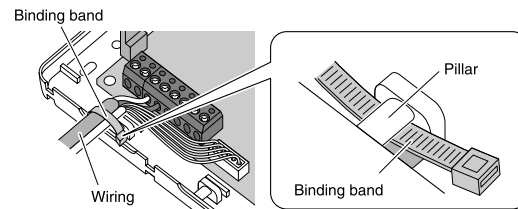

- (2) Insert the second binding band into the groove on the side of the HA casing and fix the wiring securely so that the wiring will not be disconnected.

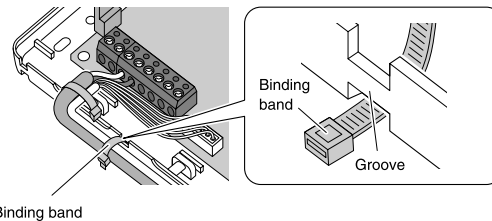

A large number of wires

Make a slit with an appropriate tool, such as a cutter knife, on the thin part of the upper HA casing along the frame. Then cut the part with an appropriate tool, such as a pair of nippers.

(NOTE) Cut off only the thin part required for wiring.

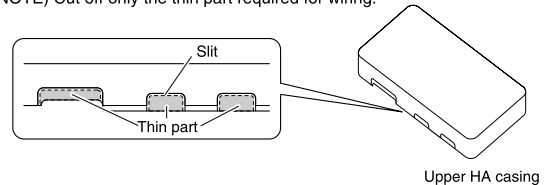

2 Securing wires in the indoor unit

- The method for securing wire varies depending on the model of the air conditioner. See your air conditioner installation manual for details.

Wiring ②

2. Automatic Reset After Power Failure

- This PCB stores the following data in the event of a power failure (the storage period is limitless).
 - ① On/Off (see Note 1)
 - ② Operation modes (see Note 2)
 - ③ Temperature setting
 - ④ Air flow rate
 - ⑤ On/Off status of remote controller
- (Note 1 When SW1-2 is in Off mode, the unit will not be activated.)
 (Note 2 The following settings apply to the models below.)

Mode before the power outage	COOLING	HEATING
Room air conditioner		
Models with Humid heating and Reheating dehumidifying functions.	DRY COOLING	HUMID HEATING
Models with Reheating dehumidifying function.		HEATING

(Note 3 Not all settings will be saved (e.g., humidity or swing settings will not be saved).)

3. Monitor Signal Output (normal operation and malfunction)

- Maximum length of the wiring is 100 m. No external power supply is required.

1 Monitor signal output for LED

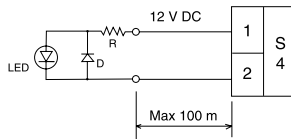

Locally procured parts

Item	Manufacturer	Type
LED	Rohm	SLR-342
D	Rohm	1SS133
R		510 ohm 1/4W

2 Monitor signal output (normal operation and malfunction) using external relay contacts

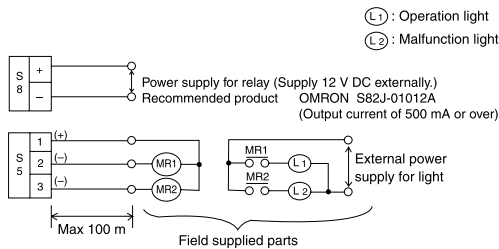

Field procured parts (Recommended external relay contacts)

Manufacturer	Type	Coil rated voltage	Coil resistance
Omron	MY relay	12 V DC	160 ohm ± 10%
Panasonic	HC relay	12 V DC	160 ohm ± 10%

4. Connection with Remote Controller

Example connections with three kinds of remote controllers are shown below.
 Note: These connections cannot be used in combination.

1 Remote control with switch (field supply)

- Set SW1-1 to Off and select Operation Mode 1.



<Instantaneous Contact>

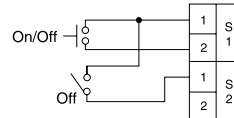

- The remote controller most recently used (local or air conditioner) takes precedence.
- Use a remote controller with a pulse width of 100 msec or more.

<Normal Contact>

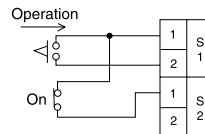

- Power On/Off cannot be controlled from the unit's remote controller. (Three beeps for signal reception will be heard continuously when the wireless remote controller is operated.)
- When power is restored after a power failure in this mode, On or Off is determined according to the current settings of the remote controller.

2 Five-room central controller (KRC72)

- Set SW1-1 to Off and select Operation Mode 1.
- The remote controller most recently used takes precedence.

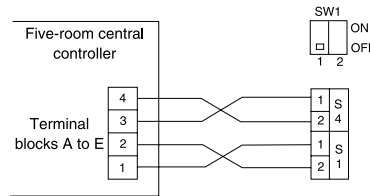

3 Fan coil remote controller

- Set SW1-1 to On and select Operation Mode 2.
- Most settings (power On/Off, air flow rate, mode change) cannot be made using the air conditioner's remote controller.
- When power is restored after a power failure in this mode, On or Off is determined according to the current settings of the remote controller.
- When the Cooling/Heating mode is changed, use the air conditioner's remote controller to adjust the temperature.

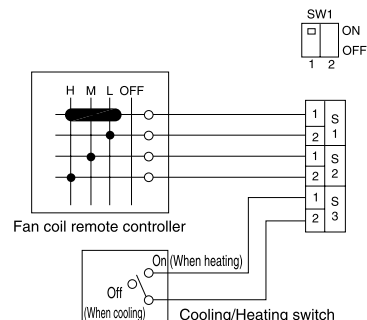

Test Operation and Confirmation

1. When the System is Not Working

- Is the air conditioner working properly?
- Are the connectors of the wiring properly connected?
- Are the remote controller and field wiring properly connected?
- Are all switch settings correct?
- If there is nothing apparently wrong, conduct a diagnostic check using the following procedure.

■ Diagnostic check

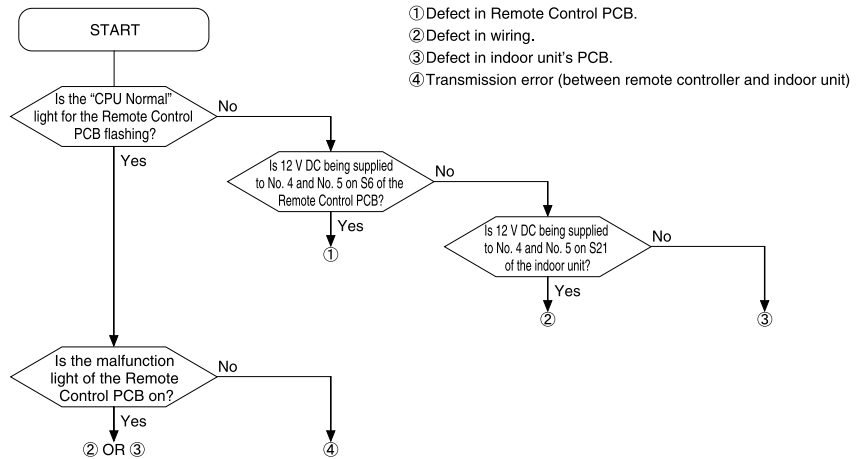

2. Switch Settings and Connection Terminals

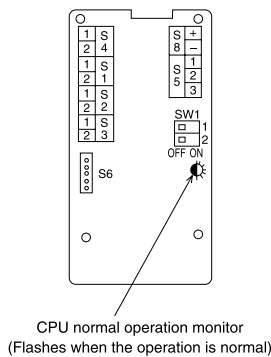

SW1-1	Selecting the operation mode	OFF	Operation mode 1 (Used with the exception of fan coil remote controller settings)		
		ON	Operation mode 2 (Used with fan coil remote controller settings)		
SW1-2	Selecting On/Off when power is restored after a power failure	OFF	Always Off		
		ON	Off if operation was in Off mode before power failure; On if operation was in On mode before power failure		
S1 S2 S3	SW1-1: OFF (Operation mode 1)			Instantaneous contact	Normal contact
		S1 (1) - S2 (1)		OPEN	CLOSE
		S1 (1) - S1 (2)		Pulse input On/Off switching	
				OPEN, Not activated	CLOSE, Activated
				Not used	
	SW1-1: ON (Operation mode 2)		S1, S2 OPEN		Not activated
			S1 (1) - S1 (2) CLOSE		On, airflow: L tap
			S1 (1) - S2 (1) CLOSE		On, airflow: M tap
			S1 (1) - S2 (2) CLOSE		On, airflow: H tap
			S3 (With the remote controller only)		
		OPEN	Cooling		
		CLOSE	Heating		
S4	(1) - (2)	Voltage on (12 V DC), normal operation light output			
S5	(1) - (2)	Normal operation light output (power for light required)			
	(1) - (3)	Malfunction light output (power for light required)			
S6 connector		Connect with connector S21 on the PCB of the indoor unit			
S8	(+) - (-)	Relay 12 V DC power supply terminal (Field supplied parts)			

13.5 <KRP928BB2S> Interface Adaptor for DIII-NET (Residential Air Conditioner)

Safety Precautions

• Read these Safety Precautions carefully to ensure correct installation. This manual classifies precautions into WARNING and CAUTION.

WARNING : Failure to follow WARNING is very likely to result in such grave consequences as death or serious injury.

CAUTION : Failure to follow CAUTION may result in serious injury or property damage, and in certain circumstances, may result in a grave consequence.

Be sure to follow all the precautions below ; they are all important for ensuring safety.

WARNING

- **Installation should be left to the dealer or another qualified professional.** Improper installation by yourself may cause malfunction, electrical shock, or fire.
- **Install the set according to the instructions given in this manual.** Incomplete or improper installation may cause malfunction, electrical shock, or fire.
- **Be sure to use the standard attachments or the genuine parts.** Use of other parts may cause malfunction, electrical shock, or fire.
- **Disconnect power to the connected equipment before starting installation.** Failure to do so may cause malfunction, electrical shock, or fire.

CAUTION

- **A ground fault circuit interrupter / an earth leakage circuit breaker should be installed.** If the breaker is not installed, electrical shock may occur.
- **Do not install the set in a location where there is danger of exposure to inflammable gas.** Gas accumulated around the unit at the worst may cause fire.
- **To prevent damage due to electrostatic discharge, touch your hand to a nearby metal object (doorknob, aluminum sash, etc.) to discharge static electricity from your body before touching this kit.** Static electricity can damage this kit.
- **Lay this cable separately from other power cables to avoid external electrical noises.**

• After installation is complete, test the operation of the PCB set to check for problems, and explain how to use the set to the end-user.

1. Overview, Features and Compatible Models

This kit is the interface required when connecting the central controller and a Room Air Conditioner. Use of the central controller makes it possible to perform the following monitoring and operations. It is compatible with room air conditioners which have an HA connector S21.

- 1.Run / stop for the central controller and wired remote controller, operating mode selection, and temperature can be set.
- 2.The operating status, any errors, and the content of those errors can be monitored from the central controller and wired remote controller.
- 3.Run / stop for the central controller and wireless remote controller, operating mode selection, and the temperature setting can be limited by the central controller.
- 4.Zone control can be performed from the central controller.
- 5.The unit can remember the operating status of the air conditioner before a power outage and then start operating in the same status when the power comes back on.
- 6.Card keys, operating control panels, and other constant / instantaneous connection-compatible equipment can be connected.
- 7.The Operating / error signals can be read.
- 8.The indoor temperature can be monitored from the Intelligent Touch Controller.

Precaution

1. When reading the Operating / error signals, a separate external power source (12 V DC) is needed.
2. A separate timer power source (16 V DC) is needed when using the schedule timer independently, and not in conjunction with other central controllers.
3. The range of temperatures that can be set from the central controller is 18°C to 32°C in cooling and 14°C to 28°C in heating.
4. Fan operation cannot be selected from the central controller or wired remote controller.
5. Group control (i.e., control of multiple indoor units with a single remote controller) is not available.
6. Monitoring is not available of the thermo status, compressor operating status, indoor fan operating status, electric heater, or humidifier operating status.
7. Forced thermo off, filter sign display and reset, fan direction and speed settings, air conditioning fee management, energy savings instructions, low-noise instructions, and demand instructions cannot be made.

2. Component Parts

This kit includes the following components. Check to ensure that none of these are missing.

Parts	Q'ty	Parts	Q'ty
Kit assy PCB is in the housing.	1	Connection harness (about 1.6m)	1set
		Mounting screws	3pcs.
		Binding band	6pc.
		Installation manual	2set

3. Names of Parts and Electric Wiring

<Wiring procedure>

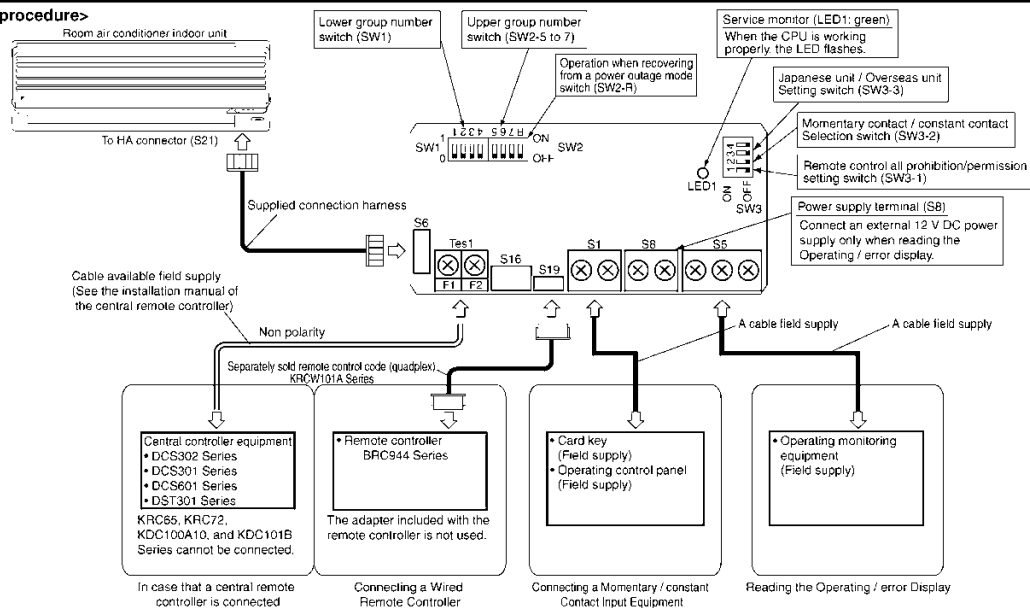

4. Switch Settings

NOTE Turn the power on after all the switches have been set. Settings made while the power is on are invalid.

Open the Kit's case and set the switches on the circuit board.
 (1) For Overseas / Japanese unit setting (SW3-3)
 Room air conditioners, different methods are used for setting the temperature in automatic mode, so this switch needs to be set.

Destination	SW3-3 setting	What Happens
Japan	OFF (Factory setting)	* "Automatic" operation is not available from the central controller. When using "automatic" operation using the wireless remote controller, the central controller displays automatic cooling (heating) and 25°C. Even if the temperature is changed, it will return to 25°C after a while.
Overseas	ON	* "Automatic" operation is available from the central controller.

(2) Group number settings (SW1 and SW2-5 to SW2-7)
 Set these when using the central controller. (Set to the ■ side.) Do not set more than one unit to the same number.
 Use SW2-R for (3) Settings when recovering from a power outage.

However, these settings do not need to be made when using the schedule timer independently.
 (The settings are needed when used in conjunction with another DCS Series central controller.)
 In this case, the schedule timer performs an auto address after the power is turned on, so group numbers are automatically set. Settings made using the switches will be overwritten.

Upper group NO.	Knob position	1	2	3	4	5	6	7	8
SW2 setting	OFF	■	■	■	■	■	■	■	■
Lower group NO.		00	01	02	03	04	05	06	07
SW1 setting	OFF	■	■	■	■	■	■	■	■
Lower group NO.		08	09	10	11	12	13	14	15
SW1 setting	OFF	■	■	■	■	■	■	■	■

NOTE also that a separate timer power source is needed when using the schedule timer independently.
 Power source specs: 16 V DC, +10%, -15%, 200mA.

(3) Settings when recovering from a power outage (SW2-R)
 This selects whether to restart operation when the power comes back on after a power outage occurred during operation. This setting is given priority in cases where the indoor unit has an auto start ON / OFF jumper. Note also that regardless of whether switch SW2-R is on or off, the operating mode (NOTE), set temperature, fan direction and speed settings, and remote control prohibition status are stored.

SW2-R setting	What Happens
OFF (Factory setting)	Stops after recovering from a power outage
ON	Stops if the unit was stopped before the power outage and runs if it was running.

(NOTE) The following settings apply to the models below.

Mode before the power outage	COOLING	HEATING
Room air conditioner		
Models with Humid heating and Reheating dehumidifying functions.		HUMID HEATING
Models with Reheating dehumidifying function.	DRY COOLING	HEATING

(4) Contact input function settings (SW3-1 to SW3-2)
 When using contact input (S1), choose one of the following functions.

S1 operating mode	SW3-1 setting	SW3-2 setting	What Happens	Control mode
Instantaneous contact input (factory setting)	OFF	OFF	The operating status of the air conditioner is reversed by an instantaneous input of 100 msec or more.	Last command priority
Constant contact input	OFF	ON	Contact: Open to close; air cond. runs. Close to open; air conditioner is stopped. (NOTE 1)	ON / OFF control is rejected (operate / stop / timer prohibition) (NOTE 2).
Remote control all prohibition/permission input	ON	Invalid	Contact: Open to close; air conditioner stops. Close to open; no change in operating status.	All remote controller actions are prohibited when the contact is closed. (NOTE 3)

NOTE1: Since central equipment uses last command priority, the contact status and operating status of the air conditioner might not match sometimes.
 Example: If the unit is run from the central controller while the air conditioner is stopped with an open contact, the contact will be open and the unit will be running.

NOTE2: Operating mode and fan direction and speed settings can be changed.
NOTE3: If the contact is closed while the ON timer is set, as the power ON timer function is still operating, the operation starts at the time specified by the timer. To prevent operation of the power ON timer, use of the (KRP413AB1S) remote control PC-board set is recommended. However, note that it cannot be used in tandem with the central controller.
 If this product is connected to an air conditioner manufactured in or after 2011, when the contact is closed, the power ON timer may be cancelled depending on the combination with the model.

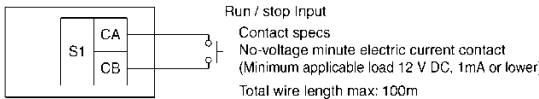

5. Control Codes

When using a central remote controller, the operating codes can be used to limit operation from wireless remote controllers. Three beeps for signal reception will be heard continuously when the wireless remote controller is operated while in central control.
 ○ : permitted; × : prohibited

S1 operating mode	Control mode	Control code	Operations from the remote controller						
			"Run" control from the central controller			"Stop" control from the central controller			
Instantaneous contact mode	ON / OFF control is rejected	0, 1, 3	×	×	×	×	×	×	×
	Only OFF control is accepted	2, 12-19	×	×	×	×	×	×	×
	Central priority	4	○	○	○	×	×	×	×
	Last command priority	5	○	○	○	×	×	×	×
	Timer operation is accepted by remote controller	6, 7	○	○	○	×	×	×	×
Constant contact mode	Timer operation is accepted by remote controller	8	○*	○*	○*	×	×	×	○
		9	○*	○*	○*	×	×	×	○
		2, 10-19	×	×	×	×	×	×	×
		0, 1, 3, 5-7	×	×	×	×	×	×	×
		4	×	×	×	×	×	×	×
All remote controller actions are prohibited		8	×	×	×	×	×	×	
		9	×	×	×	×	×	×	

* Only during timer operation.
 The remote controller permission / prohibition settings using the Intelligent Touch Controller are as follows.
 ○ : permitted; × : prohibited

S1 pin operating mode	Intelligent Touch Controller settings				Operations from the remote controller			
	Start / stop	Change operating mode	Change set temperature	Run / timer	Stop	Operating mode temperature	Fan direction and fan speed	Operations from central controller and contact input
Instantaneous contact mode	ON / OFF control is rejected	permitted	permitted/prohibited	×	×	○		
Constant contact mode	permitted	permitted/prohibited	×	×	×			
Instantaneous contact mode	Only OFF control is accepted	permitted	permitted/prohibited	×	○	×		
Constant contact mode	permitted	permitted/prohibited	×	×	×			
Instantaneous contact mode	Last command priority	permitted	permitted/prohibited	○	○	○		
Constant contact mode	permitted	permitted/prohibited	×	×	×			
All remote controller actions are prohibited	Does not affect settings	×	×	×	×			

6. Read Operating / Error Display Signal

The Operating / error signals can be read from the contact output (S5).
Output specs
 M1: Turn MR 1 ON when the air conditioner is running.
 M2: Turn MR 2 when a communication error has occurred between the KRP298BB2S and the air conditioner, or MR 1 is ON and the unit has stopped after an error.
 MR 2 is not turned ON during a warning.

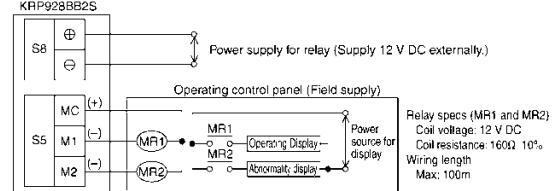

7. Combining Equipment

The central controller can be combined with the following devices.

	Central Remote Controller	ON / OFF controller	Schedule timer	D-BIPS	Contact input	Wired Remote Controller	Wireless Remote Controller
Central Remote Controller	○	○	○	○	○	○	○
ON / OFF controller	○	○	○	○	○	○	○
Schedule timer	○	○	×	×	○	○	○
D-BIPS	○	○	×	×	○	○	○
Contact input	○	○	○	○	×	○	○
Wired Remote Controller	○	○	○	○	○	×	×
Wireless Remote Controller	○	○	○	○	○	○	○

Connection to Remote Control PC-board

1. Removal of upper HA casing

① Insert a flat-blade screwdriver into the groove between the upper and lower casings.

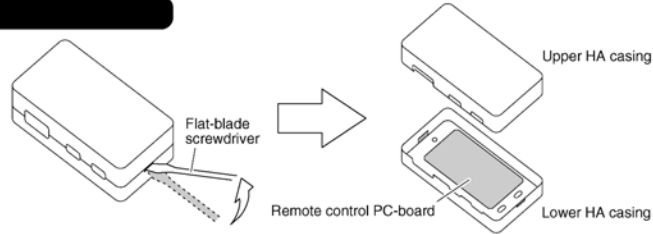

② Lift the handle of the screwdriver upward.

2. Securing of lower HA casing

Mount and secure the lower HA casing directly on the wall with the provided screws inserted into the screw holes (a round hole and two ellipse holes) of the casing.

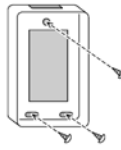

NOTE

Mount the HA casing in a direction where the wiring through-holes will be hidden in order to prevent infants from putting their fingers into the HA casing and the LED light on the internal PC board from leaking outside.

3. Connection of wiring

Connect the wiring to the connector terminals.

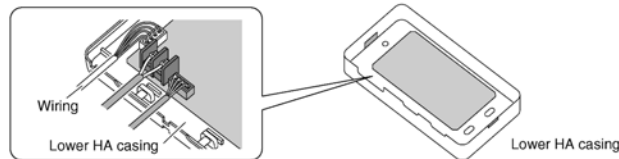

4. Fixation of wiring

① Insert the provided binding band under the pillar of the HA casing and secure the covers of the wiring with the binding band.

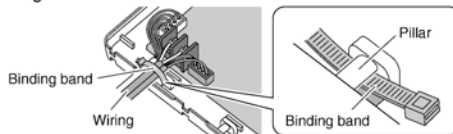

② Insert the second binding band into the groove on the side of the HA casing and fix the wiring securely so that the wiring will not be disconnected.

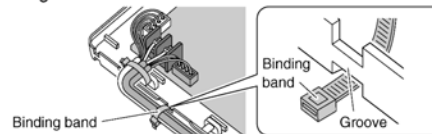

A large number of wires

Make a slit with an appropriate tool, such as a cutter knife, on the thin part of the upper HA casing along the frame. Then cut the part with an appropriate tool, such as a pair of nippers, such as a pair of nippers.

(NOTE) Cut off only the thin part required for wiring.

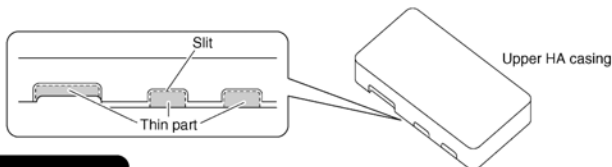

5. Finishing

Mount the upper HA casing to the original position.

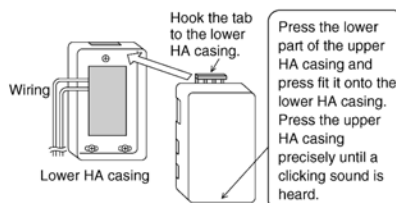

Press the lower part of the upper HA casing and press fit it onto the lower HA casing. Press the upper HA casing precisely until a clicking sound is heard.

Information

When the contact input device (such as card keys) and central controller are used in tandem:

Even when the operating mode of the S1 pin is set to prohibit all remote controller actions, run/stop operation from the central controller is possible. The operation also starts when the power ON timer of the indoor unit is up while all remote controller actions are prohibited. (*) In this case, stop the operation from the central controller. For the compatible models of the (KRC944 series) remote controller, the operation can be prohibited by using the remote controller in tandem with the central controller. *If this product is connected to an air conditioner manufactured in or after 2011, when the contact is closed, the power ON timer may be cancelled depending on the combination with the model.

13.6 <KRP067A41> Interface Adaptor for Residential Air Conditioner

Safety Considerations

- Read these **Safety Considerations** carefully to ensure correct installation.
- This manual classifies the precautions into **WARNING** and **CAUTION**. Be sure to follow all the precautions below: they are all important for ensuring safety.

⚠ WARNING : Failure to follow any of WARNING is likely to result in such grave consequences as death or serious injury.

⚠ CAUTION : Failure to follow any of CAUTION may in some cases result in grave consequences.

⚠ WARNING

- Installation shall be left to the authorized dealer or another trained professional. Improper installation may cause water leakage, electrical shock, fire, or equipment damage.
- Be sure to use the supplied or exact specified installation parts. Use of other parts may cause the unit to come to fall, water leakage, electrical shock, fire or equipment damage.
- Be sure to switch off the unit before touching any electrical parts.
- Be sure to install a ground fault circuit interrupter / earth leakage circuit breaker. Failure to install a ground fault circuit interrupter / earth leakage circuit breaker may result in electrical shock, fire or personal injury.

⚠ CAUTION

- Do not install the air conditioner where gas leakage would be exposed to open flames. If the gas leaks and builds up around the unit, it may catch fire.
- Touch a nearby metal object (doorknob, aluminium sash, etc.) to discharge static electricity from your body before touching this set.
(Static electricity from your body can damage this set.)
- Lay the cable separately from other power cables.
(Poor wiring may cause external electrical noise.)
- After completing installation, test the unit to check for installation errors. Give the user adequate instructions concerning the use and cleaning of the unit according to the Operation Manual.

Outline / Features

This set is an interface that connects a central control device to a room air conditioner and allows you to perform the following operations, or monitoring, in combination with the central control device using KRP413AB1S or KRP928BB2S (sold separately).

- Starting and stopping the air conditioner, and setting the mode and temperature, through the central control device or the wired remote controller. (64°F to 90°F (18°C to 32°C) in COOL operation, 57°F to 82°F (14°C to 28°C) in HEAT operation, none in FAN operation)
- Monitoring the operating conditions, occurrence of errors, and contents of errors of the air conditioner through the central control device or the wired remote controller.
- Restricting the operation with a wireless remote controller found near the air conditioner, such as starting and stopping operation, changing the mode, or setting the temperature, through the use of the central control device, coin timer, or card key.
- Zone control through the central control device.
- Restoring the operating conditions of the air conditioner to the previous conditions at the time of power recovery in case of power outage.

This set does not support the following functions.

- Group control (i.e., the control of multiple indoor units through a single remote controller)
- Monitoring of the following items: Indoor temperature and operating conditions of thermo, compressor, indoor fan, electric heater, and humidifier
- Control of the following items: Forced thermo OFF, filter sign display and reset, airflow direction, airflow rate setting, and air-conditioner charge management
- Energy-saving command, low-noise command, and demand command

Components

This set includes the following components. Please confirm them.

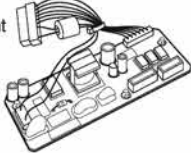
Component	Quantity	Component	Quantity
 Main component	1	Installation Manual	1

Installation Procedure

Installation Position

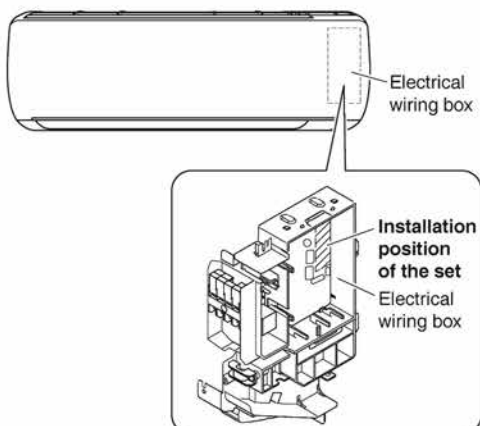

Wiring Outline

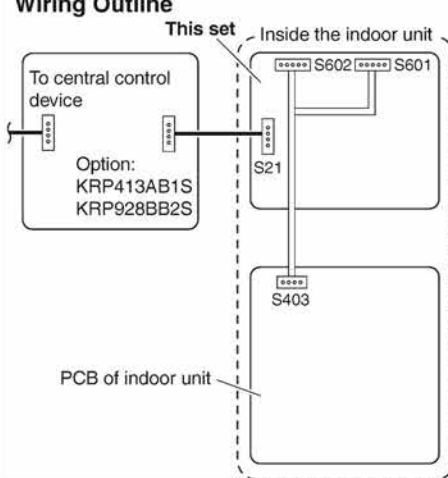

Note:
Wires indicated by thick lines are not included with the set.

Removal and Installation of Front Panel

• Removal method

- 1) Place your fingers in the indentations on the main unit (one each on the left and right sides), and open the panel until it stops.
- 2) Continue to open the front panel further while sliding the panel to the left and pulling it toward yourself in order to disengage the rotating shaft on the left side. To disengage the rotating shaft on the right side, slide the panel to the right while pulling it toward yourself.

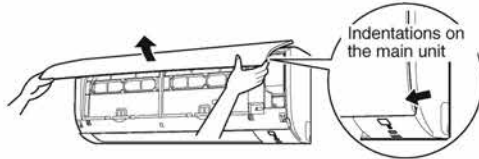

• Installation method

Align the rotating shaft of the front panel with the grooves, and push all the way in. Then close slowly. Push both the sides and the center of the lower surface of the panel firmly.

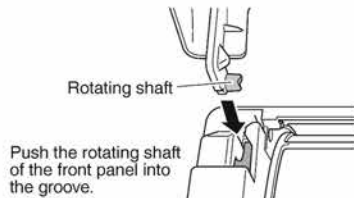

Opening service lid of indoor unit

The service lid is of removable type.

• Opening method

- 1) Remove the single screw of the service lid.
- 2) Pull out the service lid frontward.

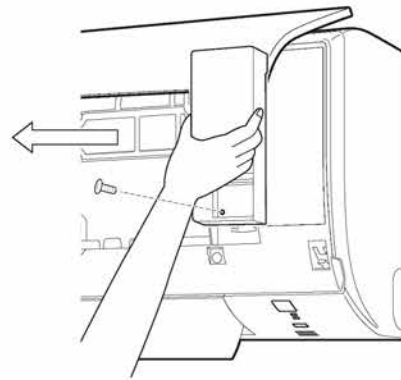

Removal and Installation of Front Grille

• Removal method

- 1) Remove front panel.
- 2) Remove the air filter.
- 3) Remove the screws (2) from the front grille.
- 4) Disengage 3 hooks (the location can be identified by ○○○ mark) at the top of the grille.

< When there is no work space because the unit is close to ceiling >

⚠ CAUTION

Be sure to wear protection gloves.

Disengage the flap (horizontal blade), and pull the lower part of the front grille toward yourself to remove it. If it is difficult to remove, place both hands under the center of the front grille, and while pushing up, pull it toward yourself.

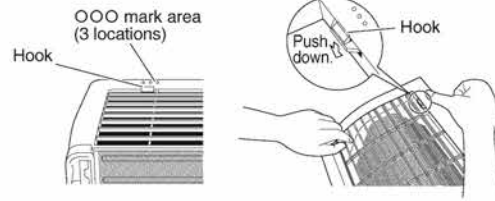
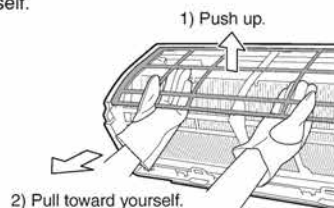

• Installation method

- 1) Install the front grille and firmly engage the upper hooks (3 locations).
- 2) Insert 2 screws of the front grille.
- 3) Install the air filter then mount the front panel.

Removal of Electrical Wiring Cover

1. Remove the front panel and the front grille and service lid of indoor unit.
(Refer to the front page for the removal of each part in detail.)
2. Remove the electrical wiring cover.

⚠ WARNING

- Be sure to turn OFF the power at the time of installation work.
Touching any electric parts with the power turned ON may cause electric shock.

Electrical wiring box

If there is workspace on the right-hand side of the indoor unit, the installation work can be conducted without removing the electrical wiring box.

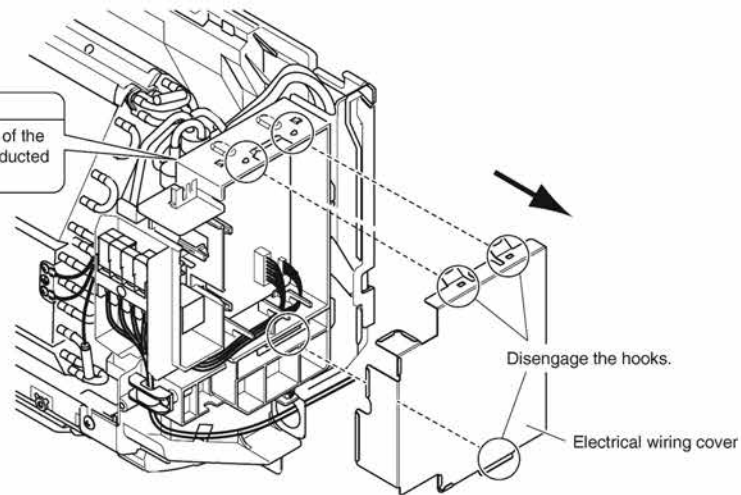

Removal of Electrical Wiring Box

If there is workspace on the right-hand side of the indoor unit, the installation work can be conducted without removing the electrical wiring box.
Connect HA without removing the electrical wiring box, if possible.

1. Disconnect the inter-unit wire.
2. Disconnect the fan motor connector (S200) and swing motor connector (S6, S11).
(Some models may not have S11 connector.)
3. Disconnect the thermistor and ground wire from the heat exchanger (two screws).
(Some models may not have ground wire.)
4. Remove the mounting screw of the electrical wiring box (one screw).

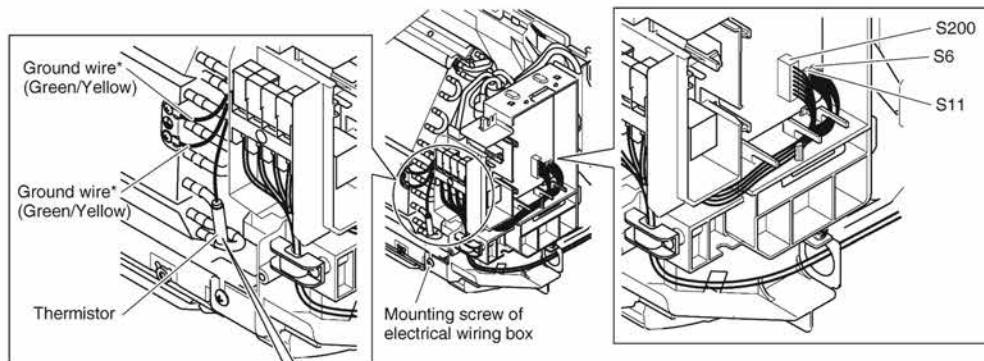

Make sure that the mounting bracket of the thermistor will not fall off.

*The position of the ground wire may differ depending on the model

Connecting HA PCB

1. Install the HA PCB (this set). (See Fig. 1)

- 1) Install the HA PCB (this set) to the electrical wiring box.
- 2) Insert the connector of the HA PCB (this set) to the connector (S403) on the electrical wiring box.

2. Connect the HA connection cord. (See Fig. 1 and 2)

- 1) Insert the HA connection cord into the HA connector "S21" (white) on the HA PCB (this set).
- 2) Route the HA connection cord as shown in Fig. 2.

Fig. 1 Connection points of the HA PCB

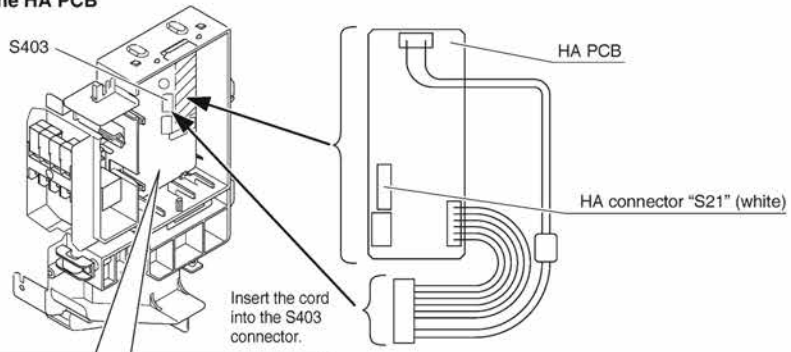

Installing HA PCB on the electrical wiring box

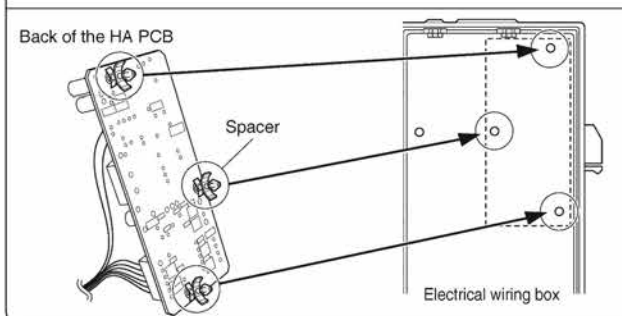
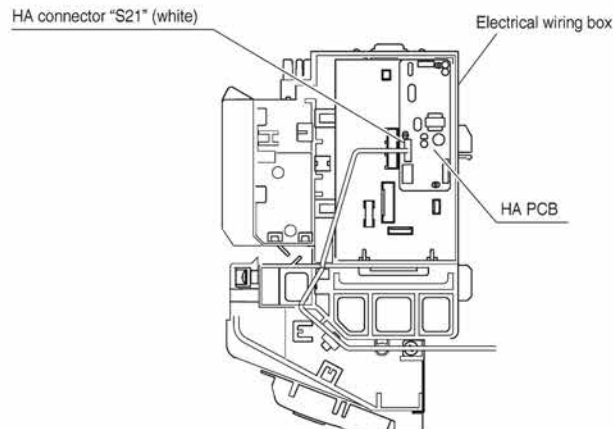

Fig. 2 Routing HA connection cord



13.7 <KRP980B2> Interface Adaptor for Residential Air Conditioner

Safety Considerations

- Read these **Safety Considerations** carefully to ensure correct installation.
- This manual classifies the precautions into **WARNING** and **CAUTION**. Be sure to follow all the precautions below: they are all important for ensuring safety.

⚠ WARNING : Failure to follow any of WARNING is likely to result in such grave consequences as death or serious injury.

⚠ CAUTION : Failure to follow any of CAUTION may in some cases result in grave consequences.

⚠ WARNING

- Installation shall be left to the authorized dealer or another trained professional. Improper installation may cause water leakage, electrical shock, fire, or equipment damage.
- Be sure to use the supplied or exact specified installation parts. Use of other parts may cause the unit to come to fall, water leakage, electrical shock, fire or equipment damage.
- Be sure to switch off the unit before touching any electrical parts.
- Be sure to install a ground fault circuit interrupter / earth leakage circuit breaker. Failure to install a ground fault circuit interrupter / earth leakage circuit breaker may result in electrical shock, fire or personal injury.

⚠ CAUTION

- Do not install the air conditioner where gas leakage would be exposed to open flames. If the gas leaks and builds up around the unit, it may catch fire.
- Touch a nearby metal object (doorknob, aluminium sash, etc.) to discharge static electricity from your body before touching this set. (Static electricity from your body can damage this set.)
- Lay the cable separately from other power cables. (Poor wiring may cause external electrical noise.)
- After completing installation, test the unit to check for installation errors. Give the user adequate instructions concerning the use and cleaning of the unit according to the Operation Manual.

Outline / Features

This set is an interface that connects a central control device to a room air conditioner and allows you to perform the following operations, or monitoring, in combination with the central control device using KRP413AB1S or KRP928BB2S (sold separately).

- Starting and stopping the air conditioner, and setting the mode and temperature, through the central control device or the wired remote controller. (64°F to 90°F (18°C to 32°C) in COOL operation, 57°F to 82°F (14°C to 28°C) in HEAT operation, none in FAN operation)
- Monitoring the operating conditions, occurrence of errors, and contents of errors of the air conditioner through the central control device or the wired remote controller.
- Restricting the operation with a wireless remote controller found near the air conditioner, such as starting and stopping operation, changing the mode, or setting the temperature, through the use of the central control device, coin timer, or card key.
- Zone control through the central control device.
- Restoring the operating conditions of the air conditioner to the previous conditions at the time of power recovery in case of power outage.

This set does not support the following functions.

- Group control (i.e., the control of multiple indoor units through a single remote controller)
- Monitoring of the following items: Indoor temperature and operating conditions of thermo, compressor, indoor fan, electric heater, and humidifier
- Control of the following items: Forced thermo OFF, filter sign display and reset, airflow direction, airflow rate setting, and air-conditioner charge management
- Energy-saving command, low-noise command, and demand command

Components

This set includes the following components. Please confirm them.

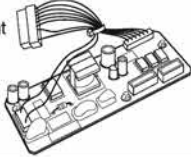
Component	Quantity	Component	Quantity
Main component 	1	Installation Manual	1

Installation Procedure

Installation Position

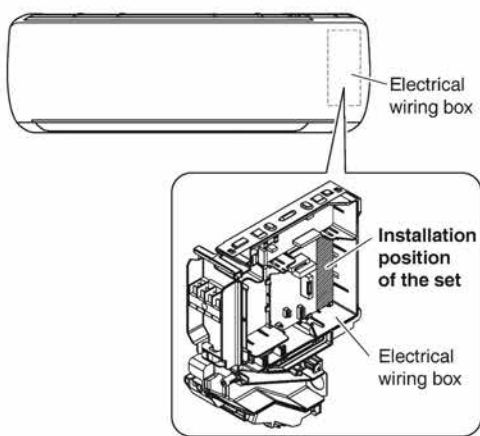

Wiring Outline

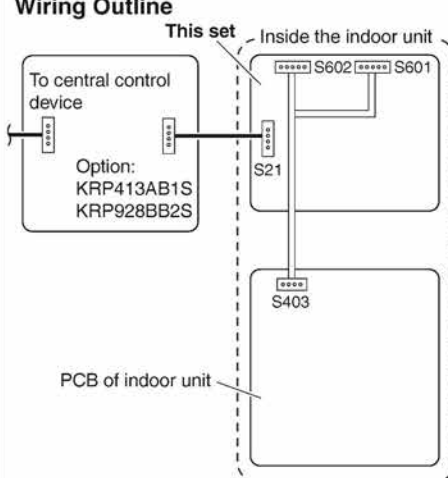

Note: Wires indicated by thick lines are not included with the set.

Removal and Installation of Front Panel

• Removal method

- 1) Place your fingers in the indentations on the main unit (one each on the left and right sides), and open the panel until it stops.
- 2) Continue to open the front panel further while sliding the panel to the left and pulling it toward yourself in order to disengage the rotating shaft on the left side.
To disengage the rotating shaft on the right side, slide the panel to the right while pulling it toward yourself.

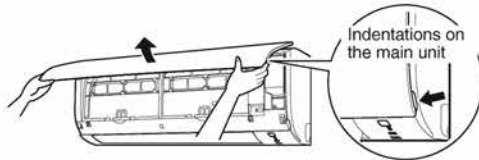

• Installation method

Align the rotating shaft of the front panel with the grooves, and push all the way in. Then close slowly. Push both the sides and the center of the lower surface of the panel firmly.

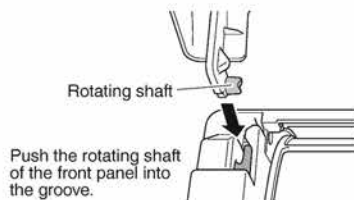

Opening service lid of indoor unit

The service lid is of removable type.

• Opening method

- 1) Remove the single screw of the service lid.
- 2) Pull out the service lid frontward.

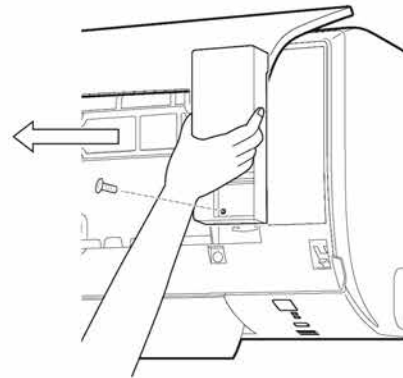

Removal and Installation of Front Grille

• Removal method

- 1) Remove front panel.
- 2) Remove the air filter.
- 3) Remove the screws (3) from the front grille.
- 4) Disengage 3 hooks (the location can be identified by ○○○ mark) at the top of the grille.

< When there is no work space because the unit is close to ceiling >

⚠ CAUTION

Be sure to wear protection gloves.

Disengage the flap (horizontal blade), and pull the lower part of the front grille toward yourself to remove it. If it is difficult to remove, place both hands under the center of the front grille, and while pushing up, pull it toward yourself.

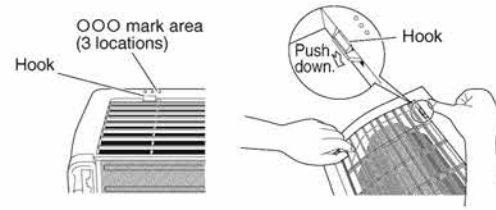
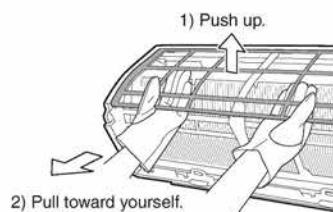

• Installation method

- 1) Install the front grille and firmly engage the upper hooks (3 locations).
- 2) Insert 3 screws of the front grille.
- 3) Install the air filter then mount the front panel.

Removal of Electrical Wiring Cover

1. Remove the front panel and the front grille and service lid of indoor unit.
(Refer to the front page for the removal of each part in detail.)
2. Remove the electrical wiring cover.

⚠ WARNING

- Be sure to turn OFF the power at the time of installation work.
Touching any electric parts with the power turned ON may cause electric shock.

Electrical wiring box

If there is workspace on the right-hand side of the indoor unit, the installation work can be conducted without removing the electrical wiring box.

Disengage the hooks.

Electrical wiring cover

Removal of Electrical Wiring Box

If there is workspace on the right-hand side of the indoor unit, the installation work can be conducted without removing the electrical wiring box.
Connect HA without removing the electrical wiring box, if possible.

1. Disconnect the inter-unit wire.
2. Disconnect the fan motor connector (S200) and swing motor connector (S6, S11).
(Some models may not have S11 connector.)
3. Disconnect the thermistor and ground wire from the heat exchanger (two screws).
(Some models may not have ground wire.)
4. Remove the mounting screw of the electrical wiring box (one screw).

Ground wire* (Green/Yellow)

Ground wire* (Green)

Thermistor

Make sure that the mounting bracket of the thermistor will not fall off.

Mounting screw of electrical wiring box

Inter-unit wire

* The position of the ground wire may differ depending on the model.

S6 S11 S200

Connecting HA PCB

1. Install the HA PCB (this set). (See Fig. 1)

- 1) Install the HA PCB (this set) to the electrical wiring box.
- 2) Insert the connector of the HA PCB (this set) to the connector (S403) on the electrical wiring box.

2. Connect the HA connection cord. (See Fig. 1 and 2)

- 1) Insert the HA connection cord into the HA connector "S21" (white) on the HA PCB (this set).
- 2) Route the HA connection cord as shown in Fig. 2.

Fig. 1 Connection points of the HA PCB

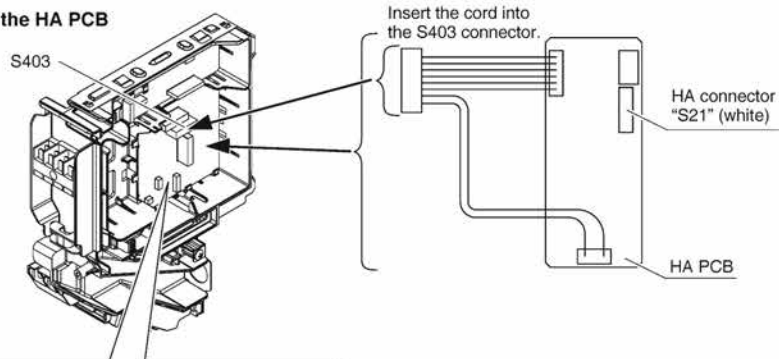

Installing HA PCB on the electrical wiring box

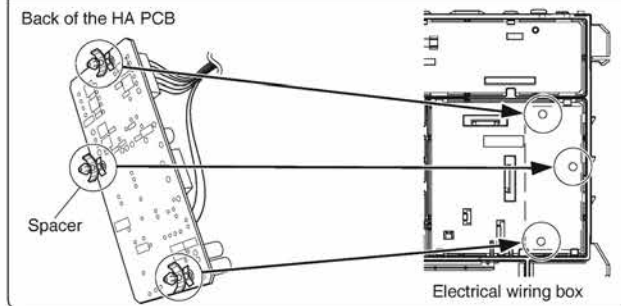
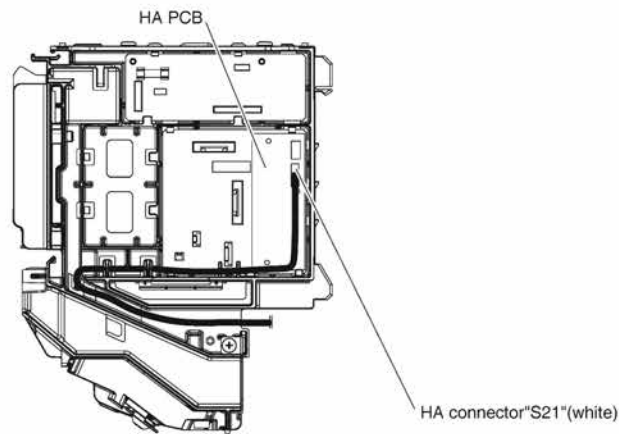

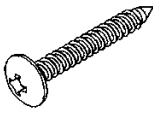



Fig. 2 Routing HA connection cord



13.8 <KPW937E4> Air Direction Adjustment Grille

Component parts Be sure to check that the following parts are included before installation.

Name	① Air direction adjustment grille	② Screw	③ Installation manual
Shape			
Q'ty	1 pc.	4 pcs.	1 sheet(this sheet)

Selection of installation site

- Use the air direction adjustment grille for installation at a location that fits the following conditions.
 1. When installing the outdoor unit near the neighbouring house.
 2. When changing the airflow direction to prevent exhaust blowing directly onto passersby or garden plants.

Cautions for usage

- Be sure to perform the following as installation precautions to ensure correct and safe use of the air direction adjustment grille.
 1. Be sure to stop the operation before installation.
 2. Avoid short-circuits during installation.
 3. When using the unit in areas with snow, install the grille to create a left-right or downward airflow. Do not install the grille to create an upward airflow to prevent snow accumulating in the air outlet of the outdoor unit as this may damage the unit.
 4. Be careful of foreign substances such as dead leaves, which may accumulate on the air outlet after installing the grille to create an upward airflow.
 5. Do not use screws other than those provided. Tighten the screws securely without any looseness.

Installation of air direction adjustment grille

- Pitch of the installation screws for the air direction adjustment grille(①) is 434mm in the vertical and horizontal directions.
- Installation can be performed in 4 directions: top, bottom, left and right.
- Temporarily secure the air direction adjustment grille(①) using 4 screws(②), check the installation angle, and then tighten the screws.

<Steel wire outlet grille>

1 Remove the 4 outlet grille fixing screws.

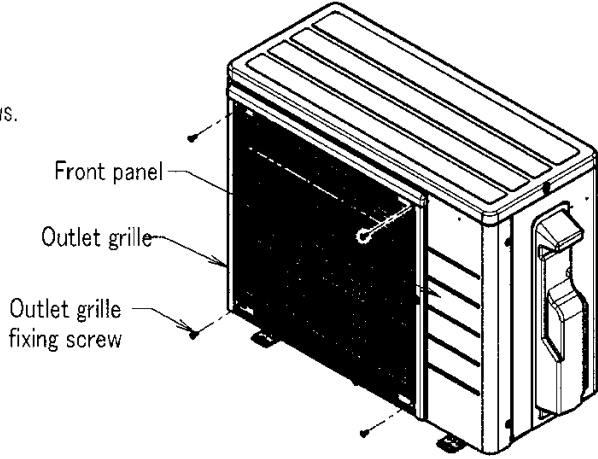

Labels in diagram: Front panel, Outlet grille, Outlet grille fixing screw

2 Install the air direction adjustment grille(①) attached on the front panel using 4 screws(②).

※ Attach the air direction adjustment grille on top of the outlet grille using the same screws.

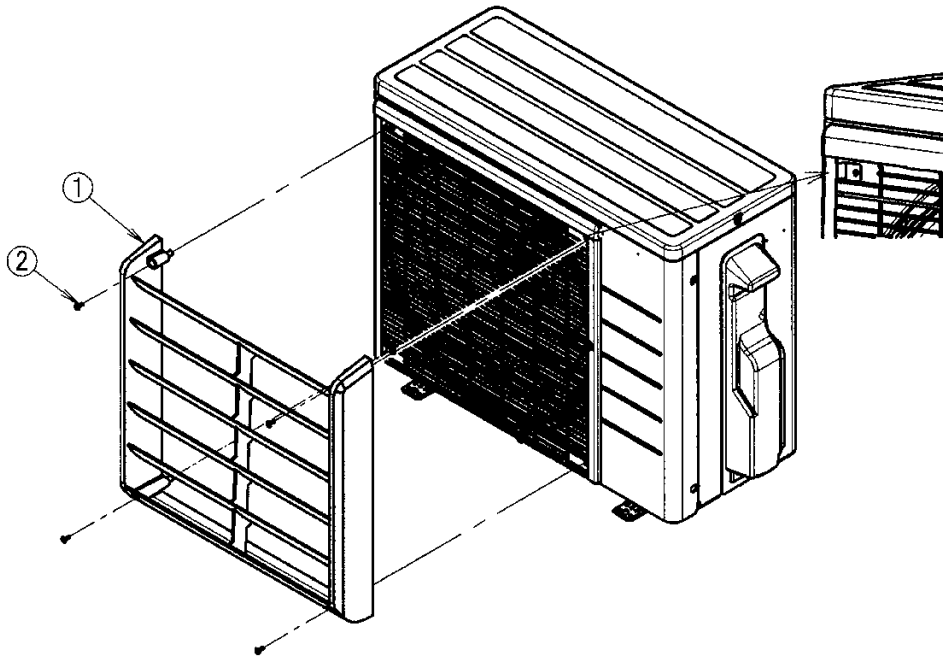

3 Appearance of the air direction adjustment panel following installation.
(When installed with the louvers facing up.)

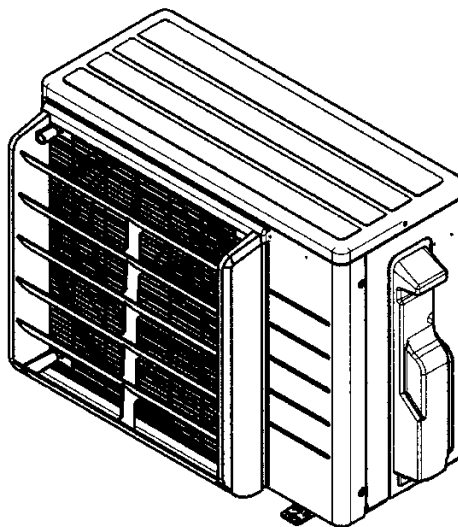



3P397163-1

13.9 <KPW063A4> Air Direction Adjustment Grille

Component parts Be sure to check that the following parts are included before installation.

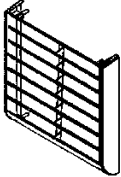
Component parts

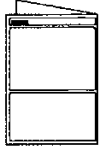
Name	① Air direction adjustment grille	② Screw	③ Spacer	④ Installation Manual
Illustration				
Quantity	1 pcs.	4 pcs.	4 pcs.	1 sheet(this sheet)

Selection of installation site

Install only on an outdoor unit in a location that satisfies the following conditions:

- When installing the outdoor unit near the neighbouring house,
- Where you wish to change the exhaust airflow direction because the outdoor unit has been installed facing a road, so that passing people are not exposed to its exhaust air
- When changing the airflow direction to prevent exhaust blowing directly onto passersby or garden plants.

Cautions for usage

- Be sure to perform the following as installation precautions to ensure correct and safe use of the air direction adjustment grille.
 1. Install the product so that it is situated high enough to allow access to the outdoor unit for maintenance purposes.
 2. When installing the product in a location in which it may be exposed to strong winds, install a rollover prevention bracket (sold separately) at the same time.
 3. Tighten screws securely. Failure to do so may result in vibration.

① Verifying the amount of space required for installation

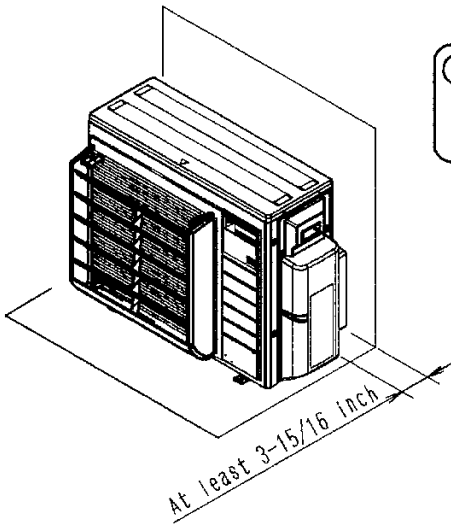

⚠ Caution

Leave at least 3-15/16 inch between the rear of the outdoor unit and any obstructions(walls, etc.).

2 Installation of air direction adjustment grille

⚠ Caution

Install the air direction adjustment grille on top of the outlet grille.
 Be sure to install the outlet grille as installing only the air direction adjustment grille would allow a person to reach his or her hand into the outdoor unit far enough to come into contact with the rotating fan.

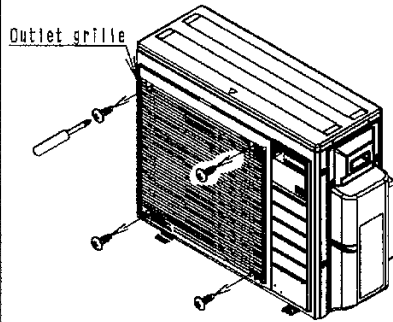

- (1) Remove the 4 outlet grille fixing screws.
- (2) Referring to the following illustration, attach the outlet grille and air direction adjustment grille, taking care to align them with the air outlet direction.
- Attach the air direction adjustment grille on top of the outlet grille using the same screws.

Upward facing

Downward facing

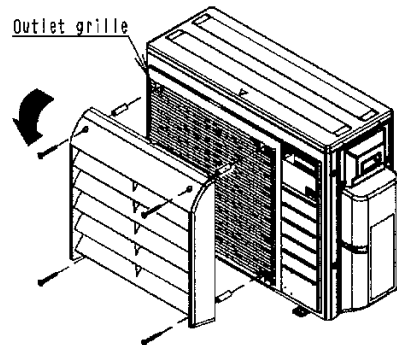
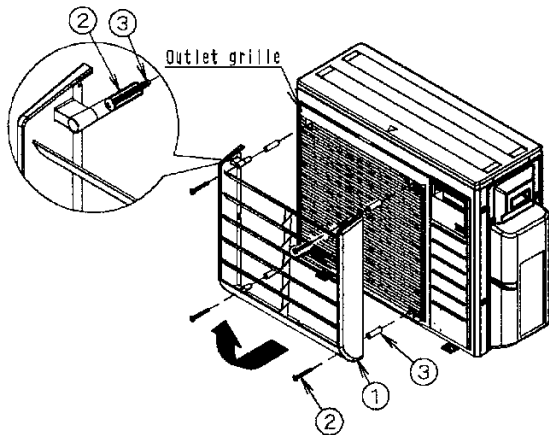

Appearance of the air direction adjustment grille after installation (when installed with the louvers facing up)

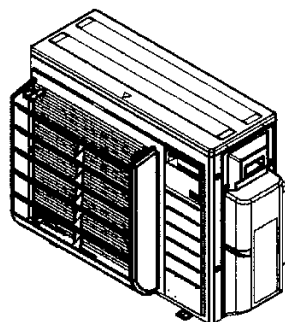



Warning



- Ask a qualified installer or contractor to install this product. Do not try to install the product yourself. Improper installation can result in water or refrigerant leakage, electrical shock, fire or explosion.
- Use only those parts and accessories supplied or specified by Daikin. Ask a qualified installer or contractor to install those parts and accessories. Use of unauthorized parts and accessories or improper installation of parts and accessories can result in water or refrigerant leakage, electrical shock, fire or explosion.
- Read the user's manual carefully before using this product. The user's manual provides important safety instructions and warnings. Be sure to follow these instructions and warnings.

If you have any enquiries, please contact your local importer, distributor and/or retailer.

Cautions on product corrosion

1. Air conditioners should not be installed in areas where corrosive gases, such as acid gas or alkaline gas, are produced.
2. If the outdoor unit is to be installed close to the sea shore, direct exposure to the sea breeze should be avoided. If you need to install the outdoor unit close to the sea shore, contact your local distributor.