

Service Manual

Inverter Pair Wall Mounted Type FTX-N Series Floor Standing Type FVXS-N Series

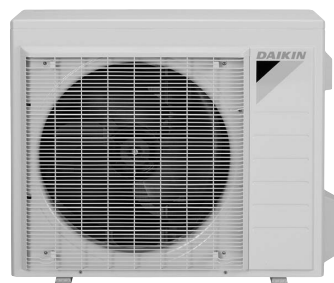
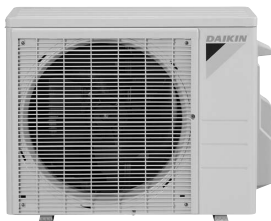
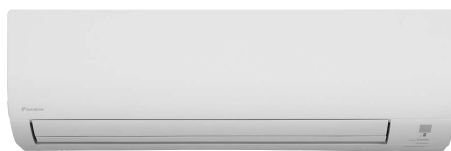

[Applied Models]

- Inverter Pair : Heat Pump

Inverter Pair Wall Mounted Type FTX-N Series Floor Standing Type FVXS-N Series

●Heat Pump

Indoor Unit

**FTX09NMVJU
FTX12NMVJU
FTX15NMVJU**

**FVXS09NVJU
FVXS12NVJU
FVXS15NVJU**

Outdoor Unit

**RXL09QMVJU
RXL12QMVJU
RXL15QMVJU**

1. Safety Cautions.....	v
1.1 Warnings and Cautions Regarding Safety of Workers.....	v
1.2 Warnings and Cautions Regarding Safety of Users.....	vii
2. Icons Used	x
Part 1 List of Functions	1
1. Functions.....	2
Part 2 Specifications	4
1. Specifications	5
Part 3 Printed Circuit Board Connector Wiring Diagram	9
1. Indoor Unit.....	10
1.1 FTX09/12NMVJU	10
1.2 FTX15NMVJU	12
1.3 FVXS09/12/15NVJU.....	14
2. Outdoor Unit.....	16
2.1 RXL09QMVJU.....	16
2.2 RXL12QMVJU.....	17
2.3 RXL15QMVJU	18
Part 4 Functions and Control.....	19
1. Main Functions.....	20
1.1 Temperature Control	20
1.2 Frequency Principle.....	20
1.3 Airflow Direction Control.....	22
1.4 Fan Speed Control for Indoor Unit	25
1.5 Program Dry Operation	26
1.6 Automatic Operation.....	27
1.7 Thermostat Control.....	28
1.8 NIGHT SET Mode	29
1.9 ECONO Operation	29
1.10 Inverter POWERFUL Operation	30
1.11 Clock setting.....	31
1.12 WEEKLY TIMER Operation (FVXS Series)	32
1.13 Other Functions.....	38
2. Thermistor Functions	39
3. Control Specification	40
3.1 Mode Hierarchy	40
3.2 Frequency Control.....	41
3.3 Controls at Mode Changing / Start-up.....	43
3.4 Discharge Pipe Temperature Control.....	45
3.5 Input Current Control.....	46
3.6 Freeze-up Protection Control	47
3.7 Heating Peak-cut Control	47

3.8 Outdoor Fan Control.....	48
3.9 Liquid Compression Protection Function.....	48
3.10 Defrost Control	49
3.11 Electronic Expansion Valve Control	50
3.12 Malfunctions	53

Part 5 Remote Controller 54

1. FTX Series	55
2. FVXS Series.....	57

Part 6 Service Diagnosis..... 59





1. General Problem Symptoms and Check Items	61
2. Troubleshooting with LED	62
2.1 Indoor Unit.....	62
2.2 Outdoor Unit.....	62
3. Service Diagnosis	63
3.1 ARC480 Series.....	63
3.2 ARC466 Series.....	66
4. Troubleshooting	69
4.1 Error Codes and Description	69
4.2 Indoor Unit PCB Abnormality	70
4.3 Freeze-up Protection Control / Heating Peak-cut Control	71
4.4 Fan Motor (DC Motor) or Related Abnormality.....	72
4.5 Thermistor or Related Abnormality (Indoor Unit).....	75
4.6 Low-voltage Detection or Over-voltage Detection.....	76
4.7 Signal Transmission Error (Between Indoor Unit and Outdoor Unit).....	78
4.8 Unspecified Voltage (Between Indoor Unit and Outdoor Unit).....	80
4.9 Outdoor Unit PCB Abnormality.....	81
4.10 OL Activation (Compressor Overload)	82
4.11 Compressor Lock	84
4.12 DC Fan Lock	85
4.13 Input Overcurrent Detection	86
4.14 Four Way Valve Abnormality.....	87
4.15 Discharge Pipe Temperature Control.....	89
4.16 High Pressure Control in Cooling	90
4.17 Compressor System Sensor Abnormality	92
4.18 Position Sensor Abnormality	93
4.19 Thermistor or Related Abnormality (Outdoor Unit).....	95
4.20 Electrical Box Temperature Rise.....	97
4.21 Radiation Fin Temperature Rise	98
4.22 Output Overcurrent Detection	99
5. Check	101
5.1 Thermistor Resistance Check	101
5.2 Indoor Fan Motor Connector Output Check	102
5.3 Power Supply Waveforms Check.....	103
5.4 Electronic Expansion Valve Check.....	103

5.5	Four Way Valve Performance Check.....	104
5.6	Inverter Unit Refrigerant System Check.....	104
5.7	Inverter Analyzer Check.....	105
5.8	Rotation Pulse Check on the Outdoor Unit PCB.....	107
5.9	Installation Condition Check.....	108
5.10	Discharge Pressure Check.....	108
5.11	Outdoor Fan System Check.....	109
5.12	Main Circuit Short Check.....	109
5.13	Power Module Check.....	111
Part 7 Trial Operation and Field Settings.....		113
1.	Pump Down Operation.....	114
2.	Forced Cooling Operation.....	115
3.	Trial Operation.....	116
4.	Field Settings.....	118
4.1	Temperature Display Switch.....	118
4.2	When 2 Units are Installed in 1 Room.....	119
4.3	Jumper and Switch Settings.....	121
4.4	Facility Setting Switch (cooling at low outdoor temperature).....	121
5.	Silicone Grease on Power Transistor / Diode Bridge.....	122
Part 8 Appendix.....		123
1.	Piping Diagrams.....	124
1.1	Indoor unit.....	124
1.2	Outdoor Unit.....	125
2.	Wiring Diagrams.....	127
2.1	Indoor Unit.....	127
2.2	Outdoor Unit.....	130



1. Safety Cautions

Be sure to read the following safety cautions before conducting repair work. After the repair work is complete, be sure to conduct a test operation to ensure that the equipment operates normally, and explain the cautions for operating the product to the customer.







Cautions Items





The caution items are classified into  **Warning** and  **Caution**. The  **Warning** items are especially important since death or serious injury can result if they are not followed closely. The  **Caution** items can also lead to serious accidents under some conditions if they are not followed. Therefore, be sure to observe all the safety caution items described below.







Pictograms



-  This symbol indicates an item for which caution must be exercised. The pictogram shows the item to which attention must be paid.
-  This symbol indicates a prohibited action. The prohibited item or action is shown in the illustration or near the symbol.
-  This symbol indicates an action that must be taken, or an instruction. The instruction is shown in the illustration or near the symbol.

1.1 Warnings and Cautions Regarding Safety of Workers







 Warning	
<p>Do not store equipment in a room with fire sources (e.g., naked flames, gas appliances, electric heaters).</p>	
<p>Be sure to disconnect the power cable from the socket before disassembling equipment for repair. Working on equipment that is connected to the power supply may cause an electrical shock. If it is necessary to supply power to the equipment to conduct the repair or inspect the circuits, do not touch any electrically charged sections of the equipment.</p>	
<p>If refrigerant gas is discharged during repair work, do not touch the discharged refrigerant gas. Refrigerant gas may cause frostbite.</p>	
<p>When disconnecting the suction or discharge pipe of the compressor at the welded section, evacuate the refrigerant gas completely at a well-ventilated place first. If there is gas remaining inside the compressor, the refrigerant gas or refrigerating machine oil discharges when the pipe is disconnected, and it may cause injury.</p>	
<p>If refrigerant gas leaks during repair work, ventilate the area. Refrigerant gas may generate toxic gases when it contacts flames.</p>	
<p>Be sure to discharge the capacitor completely before conducting repair work. The step-up capacitor supplies high-voltage electricity to the electrical components of the outdoor unit. A charged capacitor may cause an electrical shock.</p>	









 Warning	
<p>Do not turn the air conditioner on or off by plugging in or unplugging the power cable. Plugging in or unplugging the power cable to operate the equipment may cause an electrical shock or fire.</p>	
<p>Be sure to wear a safety helmet, gloves, and a safety belt when working in a high place (more than 2 m). Insufficient safety measures may cause a fall.</p>	
<p>In case of R-32 / R-410A refrigerant models, be sure to use pipes, flare nuts and tools intended for the exclusive use with the R-32 / R-410A refrigerant. The use of materials for R-22 refrigerant models may cause a serious accident, such as a damage of refrigerant cycle or equipment failure.</p>	
<p>Do not mix air or gas other than the specified refrigerant (R-32 / R-410A / R-22) in the refrigerant system. If air enters the refrigerant system, an excessively high pressure results, causing equipment damage and injury.</p>	









 Caution	
<p>Do not repair electrical components with wet hands. Working on the equipment with wet hands may cause an electrical shock.</p>	
<p>Do not clean the air conditioner with water. Washing the unit with water may cause an electrical shock.</p>	
<p>Be sure to provide an earth / grounding when repairing the equipment in a humid or wet place, to avoid electrical shocks.</p>	
<p>Be sure to turn off the power switch and unplug the power cable when cleaning the equipment. The internal fan rotates at a high speed, and may cause injury.</p>	
<p>Be sure to conduct repair work with appropriate tools. The use of inappropriate tools may cause injury.</p>	

 Caution	
Be sure to check that the refrigerating cycle section has cooled down enough before conducting repair work. Working on the unit when the refrigerating cycle section is hot may cause burns.	
Conduct welding work in a well-ventilated place. Using a welder in an enclosed room may cause oxygen deficiency.	

1.2 Warnings and Cautions Regarding Safety of Users





 Warning	
Do not store the equipment in a room with fire sources (e.g., naked flames, gas appliances, electric heaters).	
Be sure to use parts listed in the service parts list of the applicable model and appropriate tools to conduct repair work. Never attempt to modify the equipment. The use of inappropriate parts or tools may cause an electrical shock, excessive heat generation or fire.	
If the power cable and lead wires are scratched or have deteriorated, be sure to replace them. Damaged cable and wires may cause an electrical shock, excessive heat generation or fire.	
Do not use a joined power cable or extension cable, or share the same power outlet with other electrical appliances, since it may cause an electrical shock, excessive heat generation or fire.	
Be sure to use an exclusive power circuit for the equipment, and follow the local technical standards related to the electrical equipment, the internal wiring regulations, and the instruction manual for installation when conducting electrical work. Insufficient power circuit capacity and improper electrical work may cause an electrical shock or fire.	
Be sure to use the specified cable for wiring between the indoor and outdoor units. Make the connections securely and route the cable properly so that there is no force pulling the cable at the connection terminals. Improper connections may cause excessive heat generation or fire.	

 Warning	
<p>When wiring between the indoor and outdoor units, make sure that the terminal cover does not lift off or dismount because of the cable. If the cover is not mounted properly, the terminal connection section may cause an electrical shock, excessive heat generation or fire.</p>	
<p>Do not damage or modify the power cable. Damaged or modified power cables may cause an electrical shock or fire. Placing heavy items on the power cable, or heating or pulling the power cable may damage it.</p>	
<p>Do not mix air or gas other than the specified refrigerant (R-32 / R-410A / R-22) in the refrigerant system. If air enters the refrigerant system, an excessively high pressure results, causing equipment damage and injury.</p>	
<p>If the refrigerant gas leaks, be sure to locate the leaking point and repair it before charging the refrigerant. After charging the refrigerant, make sure that there is no leak. If the leaking point cannot be located and the repair work must be stopped, be sure to pump-down, and close the service valve, to prevent refrigerant gas from leaking into the room. Refrigerant gas itself is harmless, but it may generate toxic gases when it contacts flames, such as those from fan type and other heaters, stoves and ranges.</p>	
<p>When relocating the equipment, make sure that the new installation site has sufficient strength to withstand the weight of the equipment. If the installation site does not have sufficient strength or the installation work is not conducted securely, the equipment may fall and cause injury.</p>	
<p>Check to make sure that the power cable plug is not dirty or loose, then insert the plug into a power outlet securely. If the plug is dusty or has a loose connection, it may cause an electrical shock or fire.</p>	
<p>When replacing the coin battery in the remote controller, be sure to dispose of the old battery to prevent children from swallowing it. If a child swallows the coin battery, see a doctor immediately.</p>	

 Caution	
<p>Installation of a leakage breaker is necessary in some cases depending on the conditions of the installation site, to prevent electrical shocks.</p>	
<p>Do not install the equipment in a place where there is a possibility of combustible gas leaks. If combustible gas leaks and remains around the unit, it may cause a fire.</p>	
<p>Check to see if parts and wires are mounted and connected properly, and if connections at the soldered or crimped terminals are secure. Improper installation and connections may cause excessive heat generation, fire or an electrical shock.</p>	
<p>If the installation platform or frame has corroded, replace it. A corroded installation platform or frame may cause the unit to fall, resulting in injury.</p>	
<p>Check the earth / grounding, and repair it if the equipment is not properly earthed / grounded. Improper earth / grounding may cause an electrical shock.</p>	
<p>Be sure to measure insulation resistance after the repair, and make sure that the resistance is 1 MΩ or higher. Faulty insulation may cause an electrical shock.</p>	
<p>Be sure to check the drainage of the indoor unit after the repair. Faulty drainage may cause water to enter the room and wet the furniture and floor.</p>	
<p>Do not tilt the unit when removing it. The water inside the unit may spill and wet the furniture and floor.</p>	

2. Icons Used

The following icons are used to attract the attention of the reader to specific information.

Icon	Type of Information	Description
 Warning	Warning	A Warning is used when there is danger of personal injury.
 Caution	Caution	A Caution is used when there is danger that the reader, through incorrect manipulation, may damage equipment, lose data, get an unexpected result or have to restart (part of) a procedure.
 Note:	Note	A Note provides information that is not indispensable, but may nevertheless be valuable to the reader, such as tips and tricks.
	Reference	A Reference guides the reader to other places in this binder or in this manual, where he/she will find additional information on a specific topic.

Part 1

List of Functions

1. Functions.....2

1. Functions

Category	Functions	FTX09/12NMVJU RXL09/12QMJJU		Category	Functions	FTX09/12NMVJU RXL09/12QMJJU	
		●	●			●	●
Basic Functions	Inverter (with inverter power control)	●	●	Health & Cleanliness	Air-purifying filter	—	—
	Operation limit for cooling (°CDB)	10 ~ 46	10 ~ 46		Photocatalytic deodorizing filter	—	—
	Operation limit for cooling (°FDB)	50 ~ 114.8	50 ~ 114.8		Air-purifying filter with photocatalytic deodorizing function	—	—
	Operation limit for heating (°CWB)	-25 ~ 15.6	-25 ~ 15.6		Titanium apatite photocatalytic air-purifying filter (option)	●	●
	Operation limit for heating (°FWB)	-13 ~ 60	-13 ~ 60		Air filter (prefilter)	●	●
	PAM control	●	●		Wipe-clean flat panel	●	●
	Standby electricity saving	●	●		Washable grille	—	—
						MOLD PROOF operation	—
Compressor	Oval scroll compressor	—	—	Timer	Good-sleep cooling operation	—	—
	Swing compressor	●	●		WEEKLY TIMER	—	—
	Rotary compressor	—	—		Count up-down ON/OFF timer	●	●
	Reluctance DC motor	●	●		24-hour ON/OFF TIMER	—	—
Comfortable Airflow	Power-airflow flap (horizontal blade)	●	—	Worry Free (Reliability & Durability)	NIGHT SET mode	●	●
	Power-airflow dual flaps	—	●		Auto-restart (after power failure)	●	●
	Power-airflow diffuser	—	—		Self-diagnosis (R/C, LED)	●	●
	Wide-angle louvers (vertical blade)	●	●		Wiring error check function	—	—
	Auto-swing (up and down)	●	●	Flexibility	Anti-corrosion treatment of outdoor heat exchanger	●	●
	Auto-swing (right and left)	—	—		Multi-split/split type compatible indoor unit	—	—
	3-D airflow	—	—		H/P, C/O compatible indoor unit	—	—
	COMFORT AIRFLOW operation	●	●		Flexible power supply correspondence	—	—
Comfort Control	Auto fan speed	●	●	Remote Control	Chargeless	32.8 ft (10 m)	32.8 ft (10 m)
	Indoor unit quiet operation	●	●		Either side drain (right or left)	●	●
	NIGHT QUIET mode (automatic)	—	—		Power selection	—	—
	OUTDOOR UNIT QUIET operation (manual)	—	—		Low temperature cooling operation (-15°C) (5°F)	●	●
	INTELLIGENT EYE operation	—	—		°F/°C changeover R/C temperature display (factory setting: °F)	●	●
	Quick warming function	●	●		5-rooms centralized controller (option)	●	●
	Hot-start function	●	●		Remote control adaptor (normal open-pulse contact) (option)	●	●
	Automatic defrosting	●	●		Remote control adaptor (normal open contact) (option)	●	●
Operation	Automatic operation	●	●	Remote Controller	DIII-NET compatible (adaptor) (option)	●	●
	Program dry function	●	●		Wireless	●	●
	Fan only	●	●	Wired (option)	●	●	
	Lifestyle Convenience	New POWERFUL operation (non-inverter)	—	—			
		Inverter POWERFUL operation	●	●			
		Priority-room setting	—	—			
		COOL/HEAT mode lock	—	—			
		HOME LEAVE operation	—	—			
		ECONO operation	●	●			
		Indoor unit ON/OFF button	●	●			
Signal receiving sign		●	●				
R/C with back light	●	●					
Temperature display	—	—					

Note: ● : Available
— : Not available

Category	Functions	FVXS09/12/15NVJU RXL09/12/15QMVJU	Category	Functions	FVXS09/12/15NVJU RXL09/12/15QMVJU	
Basic Functions	Inverter (with inverter power control)	●	Health & Cleanliness	Air-purifying filter	—	
	Operation limit for cooling (°CDB)	10 ~ 46		Photocatalytic deodorizing filter	—	
	Operation limit for cooling (°FDB)	50 ~ 114.8		Air-purifying filter with photocatalytic deodorizing function	—	
	Operation limit for heating (°CWB)	-25 ~ 15.6		Titanium apatite photocatalytic air-purifying filter (option)	●	
	Operation limit for heating (°FWB)	-13 ~ 60		Air filter (prefilter)	●	
	PAM control	●		Wipe-clean flat panel	●	
	Standby electricity saving	—		Washable grille	—	
Compressor	Oval scroll compressor	—	Timer	WEEKLY TIMER	●	
	Swing compressor	●		Count up-down ON/OFF timer	—	
	Rotary compressor	—		24-hour ON/OFF TIMER	●	
	Reluctance DC motor	●		NIGHT SET mode	●	
Comfortable Airflow	Power-airflow flap (horizontal blade)	●	Worry Free (Reliability & Durability)	Auto-restart (after power failure)	●	
	Power-airflow dual flaps	—		Self-diagnosis (R/C, LED)	●	
	Power-airflow diffuser	—		Wiring error check function	—	
	Wide-angle louvers (vertical blade)	●	Flexibility	Anti-corrosion treatment of outdoor heat exchanger	●	
	Auto-swing (up and down)	●		Multi-split/split type compatible indoor unit	●	
	Auto-swing (right and left)	—		H/P, C/O compatible indoor unit	—	
	3-D airflow	—		Flexible power supply correspondence	—	
Comfort Control	COMFORT AIRFLOW operation	—	Remote Control	Chargeless	32.8 ft (10 m)	
	Auto fan speed	●		Either side drain (right or left)	—	
	Indoor unit quiet operation	●		Power selection	—	
	NIGHT QUIET mode (automatic)	—		Low temperature cooling operation (-15°C) (5°F)	●	
	OUTDOOR UNIT QUIET operation (manual)	●		°F/°C changeover R/C temperature display (factory setting: °F)	●	
	INTELLIGENT EYE operation	—		Remote Controller	5-rooms centralized controller (option)	●
	Quick warming function	—			Remote control adaptor (normal open-pulse contact) (option)	—
	Hot-start function	●			Remote control adaptor (normal open contact) (option)	—
Operation	Automatic defrosting	●	Remote Controller	DIII-NET compatible (adaptor) (option)	●	
	Automatic operation	●		Wireless	●	
	Program dry function	●		Wired (option)	—	
	Fan only	●				
	Lifestyle Convenience	New POWERFUL operation (non-inverter)		—		
		Inverter POWERFUL operation		●		
		Priority-room setting		—		
		COOL/HEAT mode lock		—		
		HOME LEAVE operation		—		
		ECONO operation		●		
Indoor unit ON/OFF button		●				
Signal receiving sign		●				
R/C with back light		●				
Temperature display		—				

Note: ● : Available
— : Not available

Part 2 Specifications

1. Specifications5

1. Specifications

60 Hz, 208 - 230V

Model	Indoor Unit		FTX09NMVJU		FTX12NMVJU	
	Outdoor Unit		RXL09QMVJU		RXL12QMVJU	
			Cooling	Heating	Cooling	Heating
Capacity Rated (Min. ~ Max.)	kW		2.64 (1.30 ~ 3.20)	3.20 (1.30 ~ 4.70)	3.20 (1.30 ~ 3.90)	4.00 (1.30 ~ 5.50)
	Btu/h		9,000 (4,400 ~ 10,900)	10,900 (4,400 ~ 16,000)	10,900 (4,400 ~ 13,300)	13,600 (4,400 ~ 18,800)
	kcal/h		2,270 (1,120 ~ 2,750)	2,750 (1,120 ~ 4,040)	2,750 (1,120 ~ 3,350)	3,440 (1,120 ~ 4,730)
Moisture Removal	gal/h		0.32	—	0.45	—
Running Current (Rated)	A		3.76 - 3.40	3.95 - 3.57	4.36 - 3.94	5.10 - 4.61
Power Consumption Rated (Min. ~ Max.)	W		720 (250 ~ 1,180)	760 (230 ~ 1,440)	870 (280 ~ 1,390)	1,025 (240 ~ 1,660)
Power Factor (Rated)	%		92.1 - 92.1	92.6 - 92.6	96.0 - 96.0	96.7 - 96.7
COP Rated (Min. ~ Max.)	W/W		3.66 (5.20 ~ 2.70)	4.20 (5.64 ~ 3.26)	3.68 (4.64 ~ 2.80)	3.90 (5.42 ~ 3.30)
EER Rated (Min. ~ Max.)	Btu/h-W		12.5 (17.6 ~ 9.2)	14.3 (19.1 ~ 11.1)	12.5 (15.7 ~ 9.6)	13.3 (18.3 ~ 11.3)
SEER / HSPF			20.0	12.5	20.0	12.0
Piping Connections	Liquid	in. (mm)	φ 1/4 (φ 6.4)		φ 1/4 (φ 6.4)	
	Gas	in. (mm)	φ 3/8 (φ 9.5)		φ 3/8 (φ 9.5)	
	Drain	in. (mm)	φ 5/8 (φ 16.0)		φ 5/8 (φ 16.0)	
Heat Insulation			Both Liquid and Gas Pipes		Both Liquid and Gas Pipes	
Max. Interunit Piping Length	ft (m)		65-5/8 (20)		65-5/8 (20)	
Max. Interunit Height Difference	ft (m)		49-1/4 (15)		49-1/4 (15)	
Chargeless	ft (m)		32-13/16 (10)		32-13/16 (10)	
Amount of Additional Charge of Refrigerant	oz/ft (g/m)		0.21 (20)		0.21 (20)	
Indoor Unit			FTX09NMVJU		FTX12NMVJU	
Front Panel Color			White		White	
Airflow Rate	H	m ³ /min (cfm)	11.8 (417)	11.4 (403)	12.3 (434)	11.7 (413)
	M		8.4 (297)	9.3 (328)	8.8 (311)	9.1 (321)
	L		6.9 (244)	7.1 (251)	7.0 (247)	7.3 (258)
	SL		4.0 (141)	6.1 (215)	4.1 (145)	6.2 (219)
Fan	Type		Cross Flow Fan		Cross Flow Fan	
	Motor Output	W	21		28	
	Speed	Steps	5 Steps, Quiet, Auto		5 Steps, Quiet, Auto	
Air Direction Control			Right, Left, Horizontal, Downward		Right, Left, Horizontal, Downward	
Air Filter			Removable, Washable, Mildew Proof		Removable, Washable, Mildew Proof	
Running Current (Rated)	A		0.25 - 0.23	0.23 - 0.21	0.28 - 0.25	0.25 - 0.23
Power Consumption (Rated)	W		28 - 28	25 - 25	31 - 31	28 - 28
Power Factor (Rated)	%		53.8 - 52.9	52.3 - 51.8	53.2 - 53.9	53.8 - 52.9
Temperature Control			Microcomputer Control		Microcomputer Control	
Dimensions (H x W x D)	in. (mm)		11-1/4 x 30-5/16 x 8-3/4 (285 x 770 x 223)		11-1/4 x 30-5/16 x 8-3/4 (285 x 770 x 223)	
Packaged Dimensions (H x W x D)	in. (mm)		12 x 32-11/16 x 14-3/16 (305 x 831 x 360)		12 x 32-11/16 x 14-3/16 (305 x 831 x 360)	
Weight	Lbs (kg)		18 (8)		18 (8)	
Gross Weight	Lbs (kg)		24 (11)		25 (12)	
Sound Pressure Level	H / M / L / SL	dB(A)	43 / 36 / 30 / 19	43 / 36 / 29 / 25	45 / 37 / 30 / 19	45 / 37 / 30 / 26
Outdoor Unit			RXL09QMVJU		RXL12QMVJU	
Casing Color			Ivory White		Ivory White	
Compressor	Type		Hermetically Sealed Swing Type		Hermetically Sealed Swing Type	
	Model		1YC23AUXD		2YC36PXD	
	Motor Output	W	790		1,100	
Refrigerant Oil	Type		FVC50K		FVC50K	
	Charge	oz (L)	12.4 (0.375)		21.5 (0.650)	
Refrigerant	Type		R-410A		R-410A	
	Charge	Lbs (kg)	2.09 (0.95)		2.09 (0.95)	
Airflow Rate	H	m ³ /min (cfm)	31.3 (1,105)	26.1 (922)	32.4 (1,144)	28.5 (1,006)
	SL		24.5 (865)	22.0 (777)	24.5 (865)	22.0 (777)
Fan	Type		Propeller		Propeller	
	Motor Output	W	18		20	
Running Current (Rated)	A		3.51 - 3.17	3.72 - 3.36	4.08 - 3.69	4.85 - 4.38
Power Consumption (Rated)	W		692 - 692	735 - 735	839 - 839	997 - 997
Power Factor (Rated)	%		94.8 - 94.9	95.1 - 95.1	98.9 - 98.9	98.9 - 99.0
Starting Current	A		3.95		4.94	
Dimensions (H x W x D)	in. (mm)		21-5/8 x 26-9/16 x 11-3/16 (550 x 675 x 284)		21-5/8 x 26-9/16 x 11-3/16 (550 x 675 x 284)	
Packaged Dimensions (H x W x D)	in. (mm)		24-3/4 x 32-11/16 x 16 (629 x 830 x 407)		24-3/4 x 32-11/16 x 16 (629 x 830 x 407)	
Weight	Lbs (kg)		60 (27)		70 (32)	
Gross Weight	Lbs (kg)		71 (32)		80 (36)	
Sound Pressure Level	H	dB(A)	49	49	50	50
Drawing No.			C: 3D101720		C: 3D101721	

Note: ■ The data are based on the conditions shown in the table below.

Cooling	Indoor ; 80°FDB (26.7°CDB) / 67°FWB (19.4°CWB) Outdoor ; 95°FDB (35°CDB) / 75°FWB (24°CWB)
Heating	Indoor ; 70°FDB (21°CDB) / 60°FWB (15.6°CWB) Outdoor ; 47°FDB (8.3°CDB) / 43°FWB (6°CWB)
Piping Length	24-5/8 ft (7.5 m)

Conversion Formulae
kcal/h = kW × 860
Btu/h = kW × 3412
cfm = m ³ /min × 35.3

60 Hz, 208 - 230V

Model	Indoor Unit		FTX15NMVJU	
	Outdoor Unit		RXL15QMVJU	
			Cooling	Heating
Capacity Rated (Min. ~ Max.)	kW		4.40 (1.70 ~ 5.40)	5.35 (1.70 ~ 7.20)
	Btu/h		15,000 (5,800 ~ 18,400)	18,300 (5,800 ~ 24,600)
	kcal/h		3,780 (1,460 ~ 4,640)	4,600 (1,460 ~ 6,190)
Moisture Removal	gal/h		0.63	—
Running Current (Rated)	A		5.92 - 5.35	6.81 - 6.16
Power Consumption Rated (Min. ~ Max.)	W		1,150 (290 ~ 1,630)	1,340 (390 ~ 2,310)
Power Factor (Rated)	%		93.5 - 93.5	94.6 - 94.6
COP Rated (Min. ~ Max.)	W/W		3.82 (5.86 ~ 3.30)	4.00 (4.36 ~ 3.12)
EER Rated (Min. ~ Max.)	Btu/h-W		13 (20 ~ 11.3)	13.7 (14.9 ~ 10.6)
SEER / HSPF			20.0	12.5
Piping Connections	Liquid	in. (mm)	φ 1/4 (φ 6.4)	
	Gas	in. (mm)	φ 1/2 (φ 12.7)	
	Drain	in. (mm)	φ 5/8 (φ 16.0)	
Heat Insulation			Both Liquid and Gas Pipes	
Max. Interunit Piping Length	ft (m)		98-1/2 (30)	
Max. Interunit Height Difference	ft (m)		65-5/8 (20)	
Chargeless	ft (m)		32-13/16 (10)	
Amount of Additional Charge of Refrigerant	oz/ft (g/m)		0.21 (20)	
Indoor Unit		FTX15NMVJU		
Front Panel Color			White	
Airflow Rate	H	m ³ /min (cfm)	16.8 (593)	18.5 (653)
	M		14.3 (505)	15.7 (554)
	L		12.2 (431)	13.3 (470)
	SL		10.4 (367)	11.3 (399)
Fan	Type		Cross Flow Fan	
	Motor Output	W	33	
	Speed	Steps	5 Steps, Quiet, Auto	
Air Direction Control			Right, Left, Horizontal, Downward	
Air Filter			Removable, Washable, Mildew Proof	
Running Current (Rated)	A		0.23 - 0.21	0.25 - 0.23
Power Consumption (Rated)	W		33 - 33	38 - 38
Power Factor (Rated)	%		69.0 - 68.3	73.1 - 71.8
Temperature Control			Microcomputer Control	
Dimensions (H x W x D)	in. (mm)		11-5/8 x 39 x 10-3/8 (295 x 990 x 263)	
Packaged Dimensions (H x W x D)	in. (mm)		14-9/16 x 42-1/2 x 15-3/8 (370 x 1,080 x 390)	
Weight	Lbs (kg)		27 (12)	
Gross Weight	Lbs (kg)		37 (17)	
Sound Pressure Level	H / M / L / SL	dB(A)	45 / 41 / 36 / 33	45 / 41 / 37 / 33
Outdoor Unit		RXL15QMVJU		
Casing Color			Ivory White	
Compressor	Type		Hermetically Sealed Swing Type	
	Model		2YC36PXD	
	Motor Output	W	1,100	
Refrigerant Oil	Type		FVC50K	
	Charge	oz (L)	21.5 (0.650)	
Refrigerant	Type		R-410A	
	Charge	Lbs (kg)	3.20 (1.45)	
Airflow Rate	H	m ³ /min (cfm)	57.9 (2,044)	57.9 (2,044)
	SL		49.9 (1,762)	44.9 (1,585)
Fan	Type		Propeller	
	Motor Output	W	71	
Running Current (Rated)	A		5.69 - 5.14	6.56 - 5.93
Power Consumption (Rated)	W		1,117 - 1,117	1,302 - 1,302
Power Factor (Rated)	%		94.4 - 94.5	95.4 - 95.5
Starting Current	A		6.81	
Dimensions (H x W x D)	in. (mm)		28-15/16 x 34-1/4 x 12-5/8 (735 x 870 x 320)	
Packaged Dimensions (H x W x D)	in. (mm)		31-7/8 x 41-9/16 x 18-1/4 (810 x 1,056 x 464)	
Weight	Lbs (kg)		108 (49)	
Gross Weight	Lbs (kg)		123 (56)	
Sound Pressure Level	H	dB(A)	50	55
Drawing No.			C: 3D101716	

Note: ■ The data are based on the conditions shown in the table below.

Cooling	Indoor ; 80°FDB (26.7°CDB) / 67°FWB (19.4°CWB) Outdoor ; 95°FDB (35°CDB) / 75°FWB (24°CWB)
Heating	Indoor ; 70°FDB (21°CDB) / 60°FWB (15.6°CWB) Outdoor ; 47°FDB (8.3°CDB) / 43°FWB (6°CWB)
Piping Length	24-5/8 ft (7.5 m)

Conversion Formulae
kcal/h = kW × 860
Btu/h = kW × 3412
cfm = m ³ /min × 35.3

60 Hz, 208 - 230V

Model	Indoor Unit		FVXS09NVJU		FVXS12NVJU	
	Outdoor Unit		RXL09QMVJU		RXL12QMVJU	
			Cooling	Heating	Cooling	Heating
Capacity Rated (Min. ~ Max.)	kW		2.64 (1.30 ~ 3.00)	2.95 (1.30 ~ 4.20)	3.00 (1.30 ~ 3.60)	3.80 (1.30 ~ 5.00)
	Btu/h		9,000 (4,400 ~ 10,200)	10,100 (4,400 ~ 14,300)	10,200 (4,400 ~ 12,300)	13,000 (4,400 ~ 17,100)
	kcal/h		2,270 (1,120 ~ 2,580)	2,540 (1,120 ~ 3,610)	2,580 (1,120 ~ 3,100)	3,270 (1,120 ~ 4,300)
Moisture Removal	gal/h		0.32	—	0.45	—
Running Current (Rated)	A		3.75 - 3.39	3.67 - 3.32	4.20 - 3.80	4.69 - 4.24
Power Consumption Rated (Min. ~ Max.)	W		720 (250 ~ 820)	720 (240 ~ 1,390)	850 (270 ~ 1,350)	950 (250 ~ 1,570)
Power Factor (Rated)	%		92.3 - 92.3	94.3 - 94.3	97.3 - 97.3	97.4 - 97.4
COP Rated (Min. ~ Max.)	W/W		3.66 (5.20 ~ 3.66)	4.10 (5.42 ~ 3.02)	3.52 (4.80 ~ 2.66)	4.00 (5.20 ~ 3.18)
EER Rated (Min. ~ Max.)	Btu/h-W		12.5 (17.6 ~ 12.4)	14 (18.3 ~ 10.3)	12.0 (16.3 ~ 9.1)	13.7 (17.6 ~ 10.9)
SEER / HSPF			20.0	11.7	20.0	11.4
Piping Connections	Liquid	in. (mm)	φ 1/4 (φ 6.4)		φ 1/4 (φ 6.4)	
	Gas	in. (mm)	φ 3/8 (φ 9.5)		φ 3/8 (φ 9.5)	
	Drain	in. (mm)	φ 13/16 (φ 20.0)		φ 13/16 (φ 20.0)	
Heat Insulation			Both Liquid and Gas Pipes		Both Liquid and Gas Pipes	
Max. Interunit Piping Length	ft (m)		65-5/8 (20)		65-5/8 (20)	
Max. Interunit Height Difference	ft (m)		49-1/4 (15)		49-1/4 (15)	
Chargeless	ft (m)		32-13/16 (10)		32-13/16 (10)	
Amount of Additional Charge of Refrigerant	oz/ft (g/m)		0.21 (20)		0.21 (20)	
Indoor Unit			FVXS09NVJU		FVXS12NVJU	
Front Panel Color			White		White	
Airflow Rate	H	m³/min (cfm)	8.2 (290)	8.8 (311)	8.5 (300)	9.4 (332)
	M		6.5 (230)	6.9 (244)	6.7 (237)	7.3 (258)
	L		4.8 (169)	5.0 (177)	4.9 (173)	5.2 (184)
	SL		4.1 (145)	4.4 (155)	4.5 (159)	4.7 (166)
Fan	Type		Turbo Fan		Turbo Fan	
	Motor Output	W	12.3		13.4	
	Speed	Steps	5 Steps, Quiet, Auto		5 Steps, Quiet, Auto	
Air Direction Control			Right, Left, Horizontal, Downward		Right, Left, Horizontal, Downward	
Air Filter			Removable, Washable, Mildew Proof		Removable, Washable, Mildew Proof	
Running Current (Rated)	A		0.14 - 0.13	0.15 - 0.14	0.14 - 0.13	0.15 - 0.14
Power Consumption (Rated)	W		15 - 15	17 - 17	15 - 15	17 - 17
Power Factor (Rated)	%		51.5 - 50.2	54.5 - 52.8	51.5 - 50.2	54.5 - 52.8
Temperature Control			Microcomputer Control		Microcomputer Control	
Dimensions (H x W x D)	in. (mm)		23-5/8 x 27-9/16 x 8-1/4 (600 x 700 x 210)		23-5/8 x 27-9/16 x 8-1/4 (600 x 700 x 210)	
Packaged Dimensions (H x W x D)	in. (mm)		27-3/8 x 30-15/16 x 11 (696 x 786 x 280)		27-3/8 x 30-15/16 x 11 (696 x 786 x 280)	
Weight	Lbs (kg)		31 (14)		31 (14)	
Gross Weight	Lbs (kg)		40 (18)		40 (18)	
Sound Pressure Level	H / M / L / SL	dB(A)	38 / 32 / 26 / 23	38 / 32 / 26 / 23	39 / 33 / 27 / 24	39 / 33 / 27 / 24
Outdoor Unit			RXL09QMVJU		RXL12QMVJU	
Casing Color			Ivory White		Ivory White	
Compressor	Type		Hermetically Sealed Swing Type		Hermetically Sealed Swing Type	
	Model		1YC23AUXD		2YC36PXD	
	Motor Output	W	790		1,100	
Refrigerant Oil	Type		FVC50K		FVC50K	
	Charge	oz (L)	12.4 (0.375)		21.5 (0.650)	
Refrigerant	Type		R-410A		R-410A	
	Charge	Lbs (kg)	2.09 (0.95)		2.09 (0.95)	
Airflow Rate	H	m³/min (cfm)	31.3 (1,105)	26.1 (922)	32.4 (1,144)	28.5 (1,006)
	SL		24.5 (865)	22.0 (777)	24.5 (865)	22.0 (777)
Fan	Type		Propeller		Propeller	
	Motor Output	W	18		20	
Running Current (Rated)	A		3.61 - 3.26	3.52 - 3.18	4.06 - 3.67	4.54 - 4.10
Power Consumption (Rated)	W		705 - 705	703 - 703	835 - 835	933 - 933
Power Factor (Rated)	%		93.9 - 94.0	96.0 - 96.1	98.8 - 98.9	98.8 - 98.9
Starting Current	A		3.76		4.54	
Dimensions (H x W x D)	in. (mm)		21-5/8 x 26-9/16 x 11-3/16 (550 x 675 x 284)		21-5/8 x 26-9/16 x 11-3/16 (550 x 675 x 284)	
Packaged Dimensions (H x W x D)	in. (mm)		24-3/4 x 32-11/16 x 16 (629 x 830 x 407)		24-3/4 x 32-11/16 x 16 (629 x 830 x 407)	
Weight	Lbs (kg)		60 (27)		70 (32)	
Gross Weight	Lbs (kg)		71 (32)		80 (36)	
Sound Pressure Level	H	dB(A)	49	49	50	50
Drawing No.			C: 3D101722		C: 3D101724	

Note: ■ The data are based on the conditions shown in the table below.

Cooling	Indoor ; 80°FDB (26.7°CDB) / 67°FWB (19.4°CWB) Outdoor ; 95°FDB (35°CDB) / 75°FWB (24°CWB)
Heating	Indoor ; 70°FDB (21°CDB) / 60°FWB (15.6°CWB) Outdoor ; 47°FDB (8.3°CDB) / 43°FWB (6°CWB)
Piping Length	24-5/8 ft (7.5 m)

Conversion Formulae
kcal/h = kW × 860
Btu/h = kW × 3412
cfm = m³/min × 35.3

60 Hz, 208 - 230V

Model	Indoor Unit		FVXS15NVJU	
	Outdoor Unit		RXL15QMVJU	
			Cooling	Heating
Capacity Rated (Min. ~ Max.)	kW		4.40 (1.70 ~ 5.00)	5.28 (1.70 ~ 7.00)
	Btu/h		15,000 (5,800 ~ 17,100)	18,000 (5,800 ~ 24,000)
	kcal/h		3,780 (1,460 ~ 4,300)	4,540 (1,460 ~ 6,020)
Moisture Removal	gal/h		0.63	—
Running Current (Rated)	A		6.06 - 5.48	7.00 - 6.33
Power Consumption Rated (Min. ~ Max.)	W		1,200 (320 ~ 1,560)	1,400 (340 ~ 2,190)
Power Factor (Rated)	%		95.2 - 95.2	96.2 - 96.2
COP Rated (Min. ~ Max.)	W/W		3.66 (5.30 ~ 3.20)	3.76 (5.00 ~ 3.20)
EER Rated (Min. ~ Max.)	Btu/h-W		12.5 (18.1 ~ 11.0)	12.9 (17.1 ~ 11.0)
SEER / HSPF			20.0	11.3
Piping Connections	Liquid	in. (mm)	φ 1/4 (φ 6.4)	
	Gas	in. (mm)	φ 1/2 (φ 12.7)	
	Drain	in. (mm)	φ 13/16 (φ 20.0)	
Heat Insulation			Both Liquid and Gas Pipes	
Max. Interunit Piping Length	ft (m)		98-1/2 (30)	
Max. Interunit Height Difference	ft (m)		65-5/8 (20)	
Chargeless	ft (m)		32-13/16 (10)	
Amount of Additional Charge of Refrigerant	oz/ft (g/m)		0.21 (20)	
Indoor Unit		FVXS15NVJU		
Front Panel Color			White	
Airflow Rate	H	m ³ /min (cfm)	10.7 (378)	11.8 (417)
	M		9.2 (325)	10.1 (357)
	L		7.8 (275)	8.5 (300)
	SL		6.6 (233)	7.1 (251)
Fan	Type		Turbo Fan	
	Motor Output	W	23.3	
	Speed	Steps	5 Steps, Quiet, Auto	
Air Direction Control			Right, Left, Horizontal, Downward	
Air Filter			Removable, Washable, Mildew Proof	
Running Current (Rated)	A		0.19 - 0.17	0.21 - 0.19
Power Consumption (Rated)	W		27 - 27	34 - 34
Power Factor (Rated)	%		68.3 - 69.1	77.8 - 77.8
Temperature Control			Microcomputer Control	
Dimensions (H x W x D)	in. (mm)		23-5/8 x 27-9/16 x 8-1/4 (600 x 700 x 210)	
Packaged Dimensions (H x W x D)	in. (mm)		27-3/8 x 30-15/16 x 11 (696 x 786 x 280)	
Weight	Lbs (kg)		31 (14)	
Gross Weight	Lbs (kg)		40 (18)	
Sound Pressure Level	H / M / L / SL	dB(A)	44 / 40 / 36 / 32	45 / 40 / 36 / 32
Outdoor Unit		RXL15QMVJU		
Casing Color			Ivory White	
Compressor	Type		Hermetically Sealed Swing Type	
	Model		2YC36PXD	
	Motor Output	W	1,100	
Refrigerant Oil	Type		FVC50K	
	Charge	oz (L)	21.5 (0.650)	
Refrigerant	Type		R-410A	
	Charge	Lbs (kg)	3.20 (1.45)	
Airflow Rate	H	m ³ /min (cfm)	57.9 (2,044)	57.9 (2,044)
	SL		49.9 (1,762)	44.9 (1,585)
Fan	Type		Propeller	
	Motor Output	W	71	
Running Current (Rated)	A		5.87 - 5.31	6.79 - 6.14
Power Consumption (Rated)	W		1,173 - 1,173	1,366 - 1,366
Power Factor (Rated)	%		96.1 - 96.0	96.7 - 96.7
Starting Current	A		6.79	
Dimensions (H x W x D)	in. (mm)		28-15/16 x 34-1/4 x 12-5/8 (735 x 870 x 320)	
Packaged Dimensions (H x W x D)	in. (mm)		31-7/8 x 41-9/16 x 18-1/4 (810 x 1,056 x 464)	
Weight	Lbs (kg)		108 (49)	
Gross Weight	Lbs (kg)		123 (56)	
Sound Pressure Level	H	dB(A)	50	55
Drawing No.			C: 3D101718	

Note: ■ The data are based on the conditions shown in the table below.

Cooling	Indoor ; 80°FDB (26.7°CDB) / 67°FWB (19.4°CWB) Outdoor ; 95°FDB (35°CDB) / 75°FWB (24°CWB)
Heating	Indoor ; 70°FDB (21°CDB) / 60°FWB (15.6°CWB) Outdoor ; 47°FDB (8.3°CDB) / 43°FWB (6°CWB)
Piping Length	24-5/8 ft (7.5 m)

Conversion Formulae
kcal/h = kW × 860
Btu/h = kW × 3412
cfm = m ³ /min × 35.3

Part 3

Printed Circuit Board

Connector Wiring Diagram

1. Indoor Unit.....	10
1.1 FTX09/12NMVJU	10
1.2 FTX15NMVJU	12
1.3 FVXS09/12/15NVJU.....	14
2. Outdoor Unit.....	16
2.1 RXL09QMVJU	16
2.2 RXL12QMVJU	17
2.3 RXL15QMVJU.....	18

1. Indoor Unit

1.1 FTX09/12NMVJU

Control PCB (PCB1)

- | | |
|-------------------|--|
| 1) S6 | Connector for swing motor (horizontal blade) |
| 2) S26 | Connector for display PCB |
| 3) S32 | Connector for indoor heat exchanger thermistor |
| 4) S200 | Connector for DC fan motor |
| 5) H1, H2, H3, FG | Connector for terminal board |
| 6) FU1 | Fuse (3.15 A, 250 V) |
| 7) V2 | Varistor |

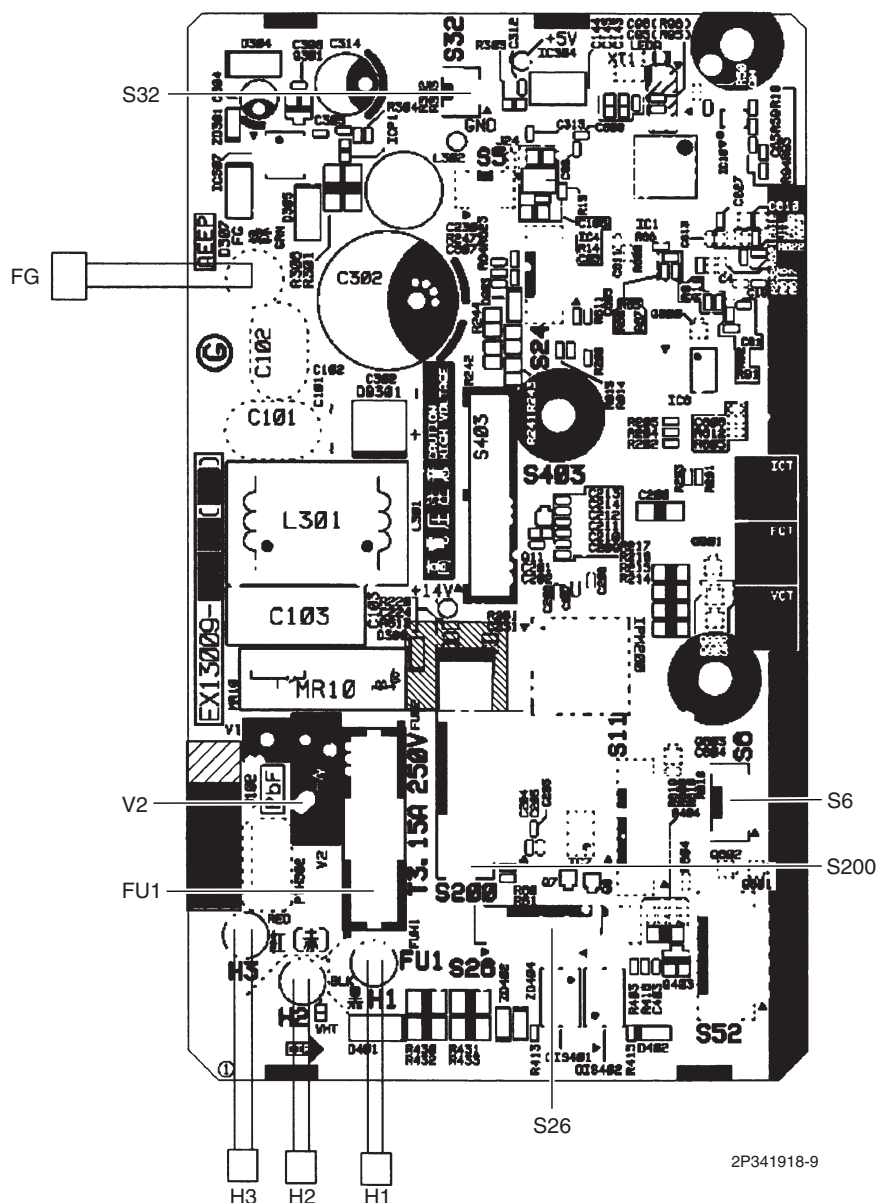

**Display PCB
(PCB2)**

- | | |
|---------------|--|
| 1) S27 | Connector for control PCB |
| 2) SW1 (S1W) | Forced cooling operation ON/OFF button
* Refer to page 115 for detail. |
| 3) LED1 (H1P) | LED for operation (green) |
| 4) LED2 (H2P) | LED for timer (yellow) |
| 5) RTH1 (R1T) | Room temperature thermistor |

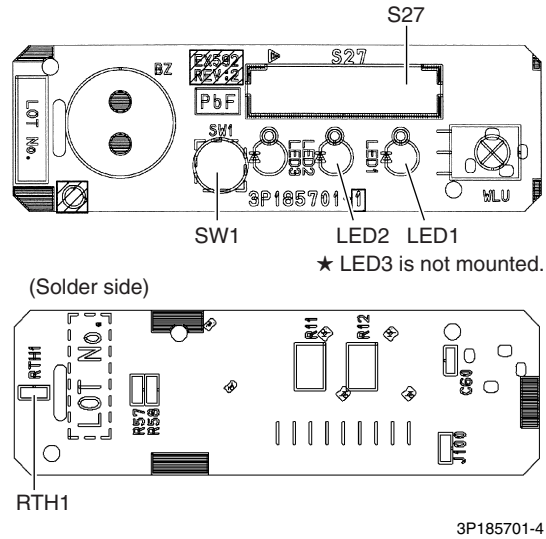

i Note: The symbols in the parenthesis are the names on the appropriate wiring diagram.

1.2 FTX15NMVJU

Control PCB (PCB2)

- 1) S6 Connector for swing motor (horizontal blade)
- 2) S26 Connector for display PCB
- 3) S32 Connector for indoor heat exchanger thermistor
- 4) S200 Connector for DC fan motor
- 5) S900 Connector for filter PCB

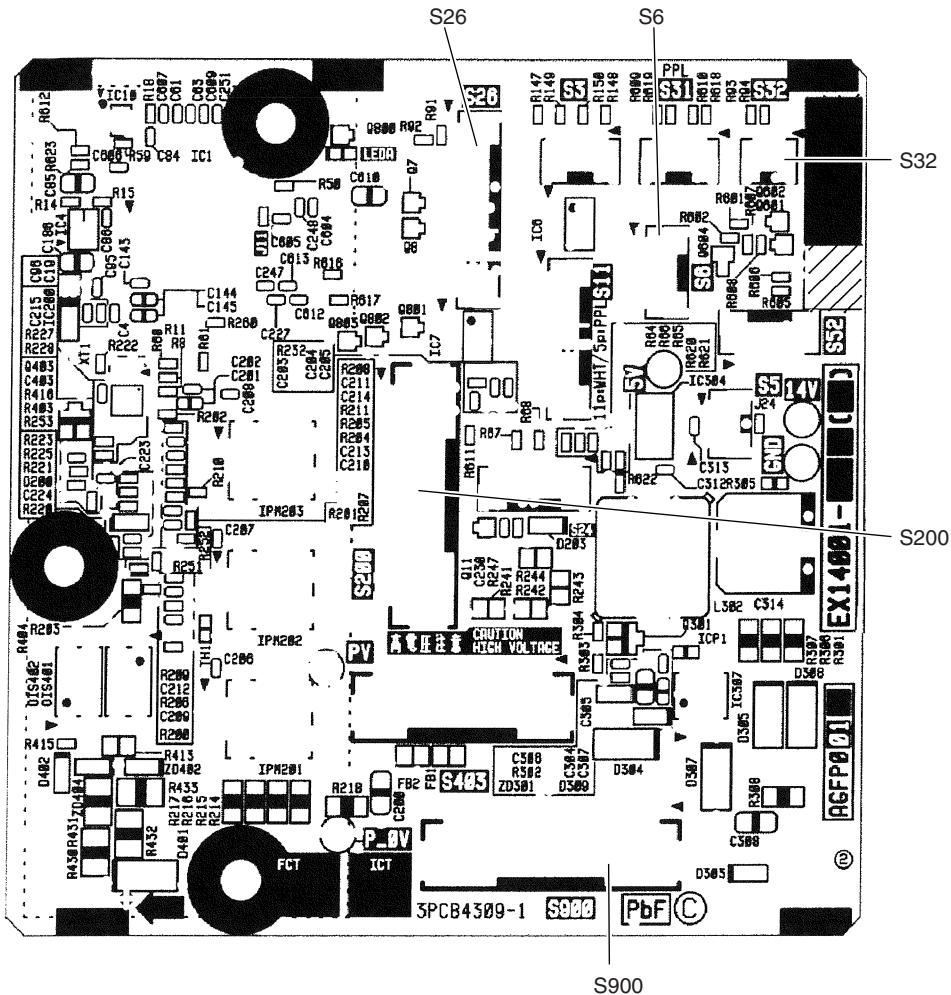

3P380931-1

**Filter PCB
(PCB1)**

- 1) S100 Connector for terminal board
- 2) S800 Connector for control PCB
- 3) FG, HE Connector for ground
- 4) FU1 Fuse (3.15 A, 250 V)
- 5) V2 Varistor

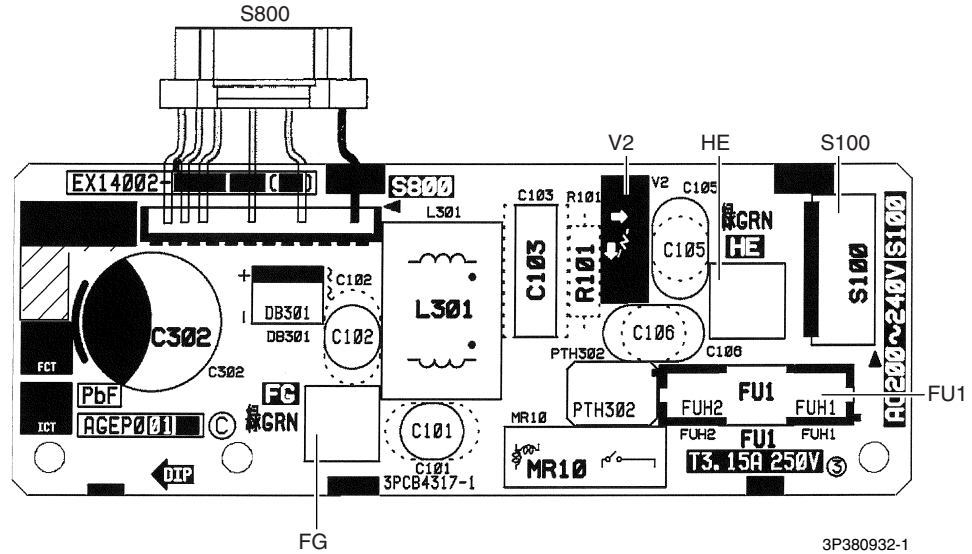

**Display PCB
(PCB3)**

- 1) S27 Connector for control PCB
- 2) SW1 (S1W) Forced cooling operation **ON/OFF** button
* Refer to page 115 for detail.
- 3) LED1 (H1P) LED for operation (green)
- 4) LED2 (H2P) LED for timer (yellow)
- 5) RTH1 (R1T) Room temperature thermistor

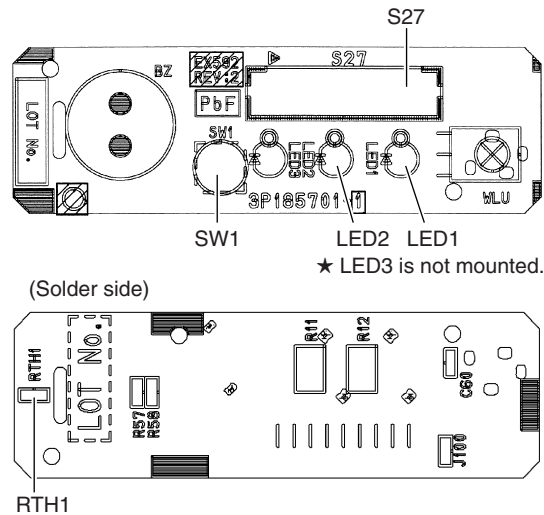

i Note: The symbols in the parenthesis are the names on the appropriate wiring diagram.

1.3 FVXS09/12/15NVJU

Control PCB (PCB2)

- | | |
|--------------------------|--|
| 1) S1 | Connector for fan motor |
| 2) S21 | Connector for centralized control (HA) |
| 3) S26 | Connector for service PCB |
| 4) S32 | Indoor heat exchanger thermistor |
| 5) S41 | Connector for lower air outlet motor |
| 6) S42 | Connector for swing motor |
| 7) S46 | Connector for display PCB |
| 8) S48 | Connector for sensor PCB |
| 9) H1, H2, H3 | Connector for terminal board |
| 10) E1 | Terminal for ground wire |
| 11) JA | Address setting jumper |
| | * Refer to page 119 for detail. |
| 12) JB | Fan speed setting when compressor stops for thermostat OFF |
| | * Refer to page 121 for detail. |
| 13) JC | Power failure recovery function |
| | * Refer to page 121 for detail. |
| 14) FU1 (F1U), FU2 (F2U) | Fuse (3.15 A, 250 V) |
| 15) LED A | LED for service monitor (green) |
| 16) V1, V2 | Varistor |

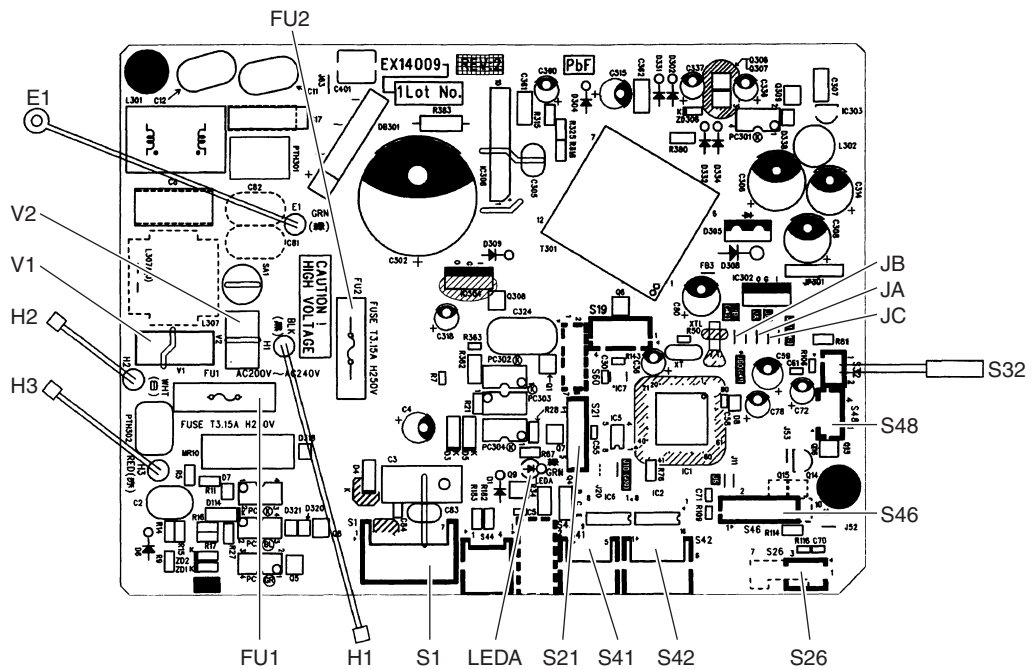

2P383711-1



Caution

Replace the PCB if you accidentally cut a wrong jumper.

Jumpers are necessary for electronic circuit. Improper operation may occur if you cut any of them.



Note:

The symbols in the parenthesis are the names on the appropriate wiring diagram.

**Sensor PCB
(PCB1)**

- 1) S49 Connector for control PCB
- 2) RTH2 (R1T) Room temperature thermistor

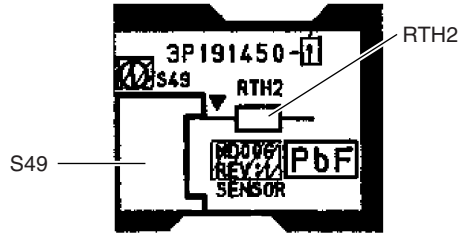

3P191450-1

**Service PCB
(PCB3)**

- 1) S27 Connector for control PCB
- 2) SW2 (S2W)-4 Switch for upward airflow limit setting
* Refer to page 121 for detail.
* Keep the other switches as factory setting.
- 3) SW4 (S4W) Switch for airflow selection
* Refer to page 23 for detail.

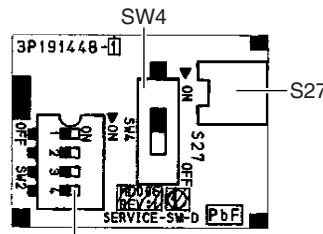

3P191448-1

**Display PCB
(PCB4)**

- 1) S47 Connector for control PCB
- 2) SW1 (S1W) Forced cooling operation **ON/OFF** button
- 3) LED1 (H1P) LED for operation (green)
- 4) LED2 (H2P) LED for timer (yellow)

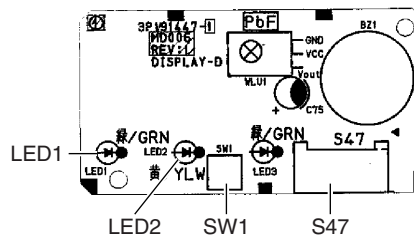

3P191447-1

★ LED3 does not function.



Note: The symbols in the parenthesis are the names on the appropriate wiring diagram.

2. Outdoor Unit

2.1 RXL09QMVJU

Main PCB (PCB1)

- | | |
|-----------------|--|
| 1) S20 | Connector for electronic expansion valve coil |
| 2) S30 | Connector for compressor |
| 3) S40 | Connector for overload protector |
| 4) S71 | Connector for DC fan motor |
| 5) S80 | Connector for four way valve coil |
| 6) S90 | Connector for thermistors
(outdoor temperature, outdoor heat exchanger, discharge pipe) |
| 7) HL1, HN1, S | Connector for terminal board |
| 8) E1, E2 | Terminal for ground wire |
| 9) HR1, HR2 | Connector for reactor |
| 10)FU1, FU2 | Fuse (3.15 A, 250 V) |
| 11)FU3 | Fuse (20 A, 250 V) |
| 12)J6 | Jumper for facility setting
* Refer to page 121 for detail. |
| 12)LED A | LED for service monitor (green) |
| 13)V2, V3, V150 | Varistor |

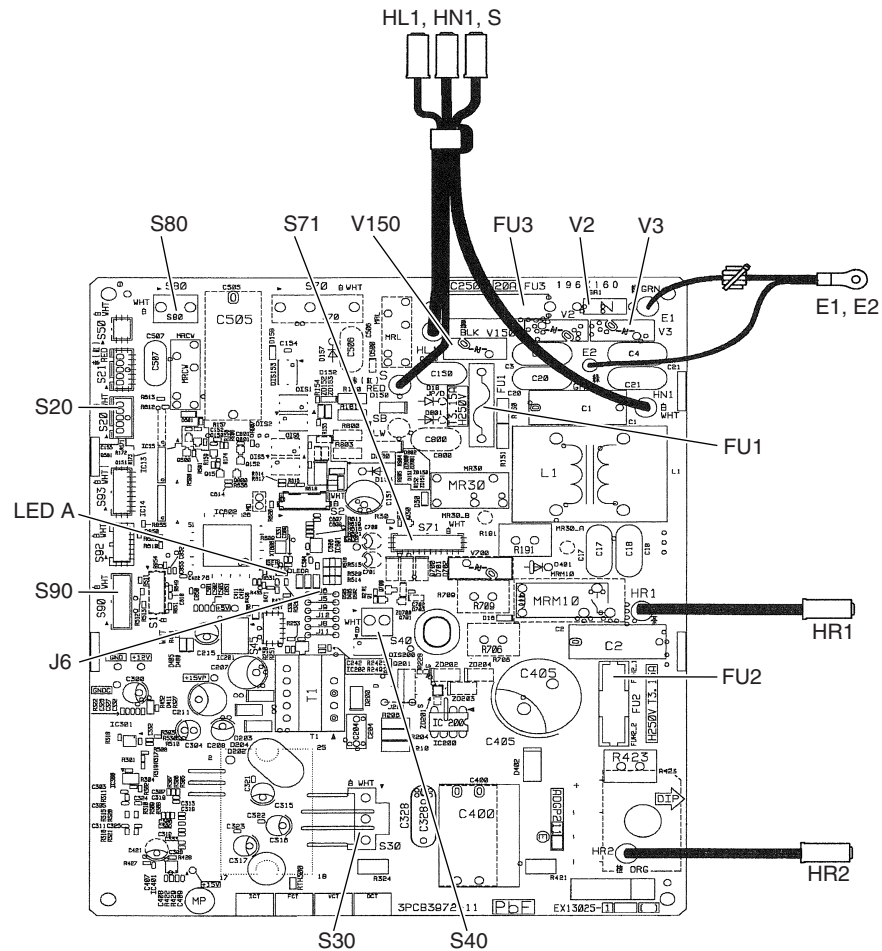

2P415459-42



Caution Replace the PCB if you accidentally cut a wrong jumper.

Jumpers are necessary for electronic circuit. Improper operation may occur if you cut any of them.

2.2 RXL12QMVJU

Main PCB

- | | |
|------------------|--|
| 1) S20 | Connector for electronic expansion valve coil |
| 2) S40 | Connector for overload protector |
| 3) S70 | Connector for DC fan motor |
| 4) S80 | Connector for four way valve coil |
| 5) S90 | Connector for thermistors
(outdoor temperature, outdoor heat exchanger, discharge pipe) |
| 6) HL1, HN1, S | Connector for terminal board |
| 7) E1, E2 | Terminal for ground wire |
| 8) U, V, W | Connector for compressor |
| 9) FU1, FU2 | Fuse (3.15 A, 250 V) |
| 10) FU3 | Fuse (20 A, 250 V) |
| 11) J6 | Jumper for facility setting
* Refer to page 121 for detail. |
| 12) LED A | LED for service monitor (green) |
| 13) V2, V3, V150 | Varistor |

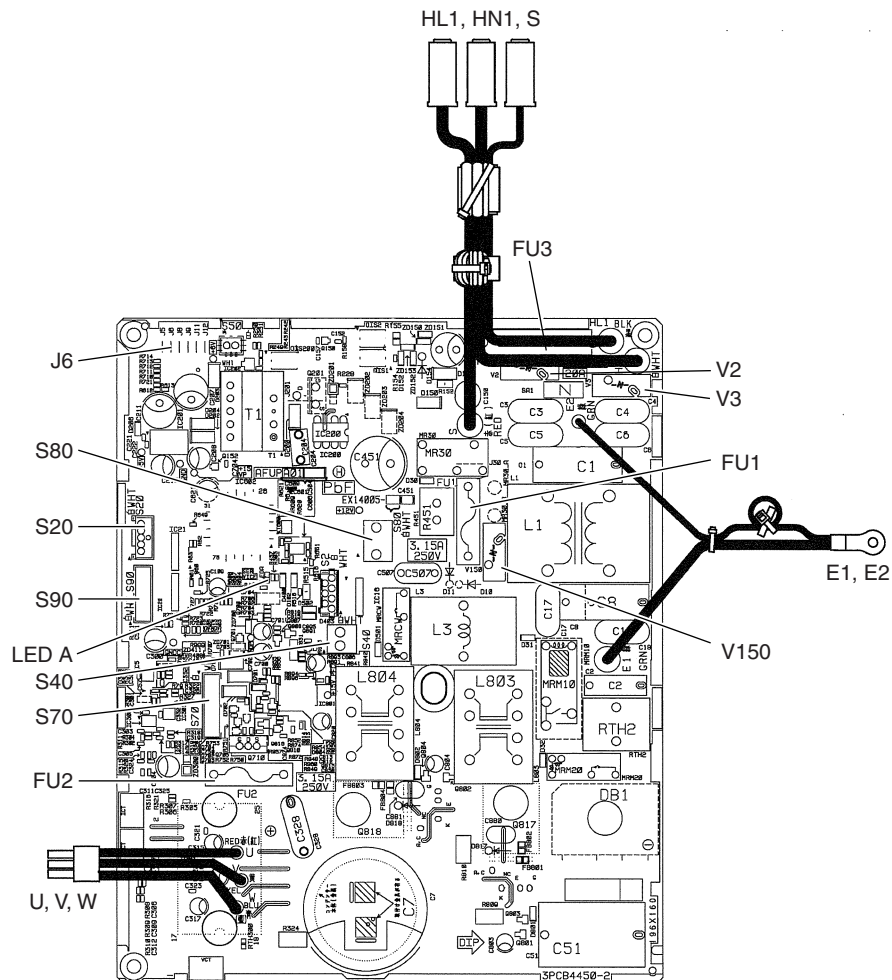

2P381219-4



Caution

Replace the PCB if you accidentally cut a wrong jumper.

Jumpers are necessary for electronic circuit. Improper operation may occur if you cut any of them.

2.3 RXL15QMVJU

Main PCB

- | | |
|----------------|--|
| 1) S20 | Connector for electronic expansion valve coil |
| 2) S40 | Connector for overload protector |
| 3) S70 | Connector for DC fan motor |
| 4) S80 | Connector for four way valve coil |
| 5) S90 | Connector for thermistors
(outdoor temperature, outdoor heat exchanger, discharge pipe) |
| 6) HL1, HN1, S | Connector for terminal board |
| 7) E1, E2 | Terminal for ground |
| 8) U, V, W | Connector for compressor |
| 9) FU1, FU2 | Fuse (3.15 A, 250 V) |
| 10) FU3 | Fuse (30 A, 250 V) |
| 11) J6 | Jumper for facility setting
* Refer to page 121 for detail. |
| 12) LED A | LED for service monitor (green) |
| 13) V1, V2, V3 | Varistor |

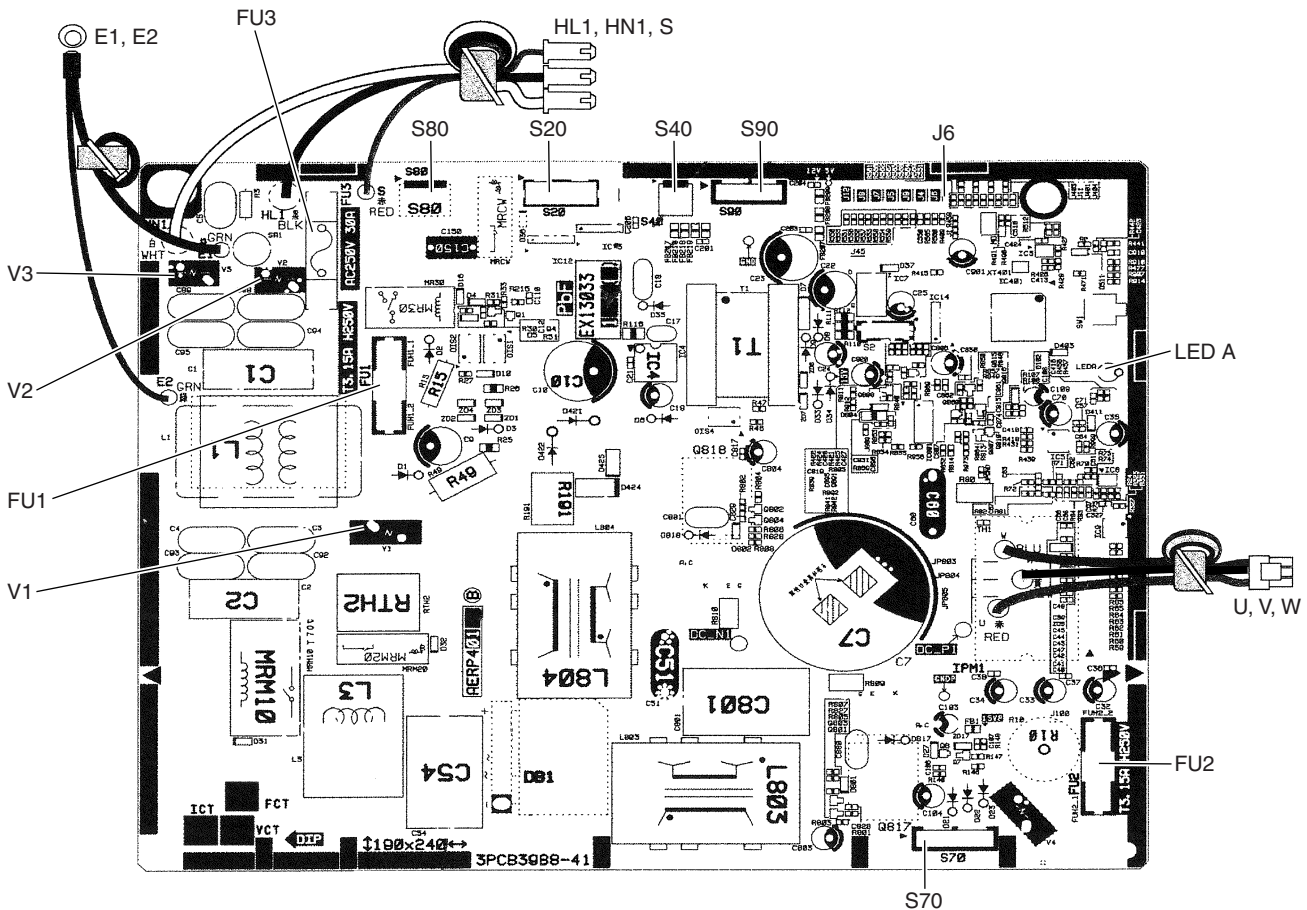

2P382390-14



Caution Replace the PCB if you accidentally cut a wrong jumper.
Jumpers are necessary for electronic circuit. Improper operation may occur if you cut any of them.

Part 4

Functions and Control

1. Main Functions	20
1.1 Temperature Control	20
1.2 Frequency Principle.....	20
1.3 Airflow Direction Control.....	22
1.4 Fan Speed Control for Indoor Unit	25
1.5 Program Dry Operation	26
1.6 Automatic Operation.....	27
1.7 Thermostat Control.....	28
1.8 NIGHT SET Mode	29
1.9 ECONO Operation	29
1.10 Inverter POWERFUL Operation	30
1.11 Clock setting.....	31
1.12 WEEKLY TIMER Operation (FVXS Series)	32
1.13 Other Functions.....	38
2. Thermistor Functions	39
3. Control Specification	40
3.1 Mode Hierarchy	40
3.2 Frequency Control.....	41
3.3 Controls at Mode Changing / Start-up.....	43
3.4 Discharge Pipe Temperature Control.....	45
3.5 Input Current Control.....	46
3.6 Freeze-up Protection Control	47
3.7 Heating Peak-cut Control	47
3.8 Outdoor Fan Control.....	48
3.9 Liquid Compression Protection Function.....	48
3.10 Defrost Control	49
3.11 Electronic Expansion Valve Control	50
3.12 Malfunctions	53

1. Main Functions

1.1 Temperature Control

Definitions of Temperatures

The definitions of temperatures are classified as following.

- ◆ Room temperature: temperature of lower part of the room
- ◆ Set temperature: temperature set by remote controller
- ◆ Room thermistor temperature: temperature detected by room temperature thermistor
- ◆ Target temperature: temperature determined by microcomputer

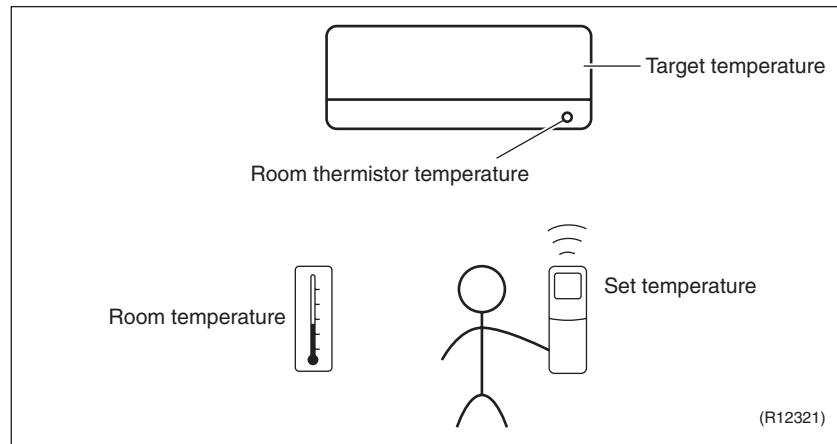

Temperature Control

The temperature of the room is detected by the room temperature thermistor. However, there is a difference between the temperature detected by room temperature thermistor and the temperature of lower part of the room, depending on the type of the indoor unit or installation condition. Practically, the temperature control is done by the target temperature appropriately adjusted for the indoor unit and the temperature detected by room temperature thermistor.

1.2 Frequency Principle

Control Parameters

The frequency of the compressor is controlled by the following 2 parameters:

- The load condition of the operating indoor unit
- The difference between the room thermistor temperature and the target temperature

The target frequency is adapted by additional parameters in the following cases:

- Frequency restrictions
- Initial settings
- Forced cooling operation

Inverter Principle

To regulate the capacity, a frequency control is needed. The inverter makes it possible to control the rotation speed of the compressor. The following table explains the inverter principle:

Phase	Description
1	The supplied AC power source is converted into the DC power source for the present.
2	The DC power source is reconverted into the three phase AC power source with variable frequency. <ul style="list-style-type: none"> ■ When the frequency increases, the rotation speed of the compressor increases resulting in an increase of refrigerant circulation. This leads to a larger amount of heat exchange per unit. ■ When the frequency decreases, the rotation speed of the compressor decreases resulting in a decrease of refrigerant circulation. This leads to a smaller amount of heat exchange per unit.

The following drawing shows a schematic view of the inverter principle:

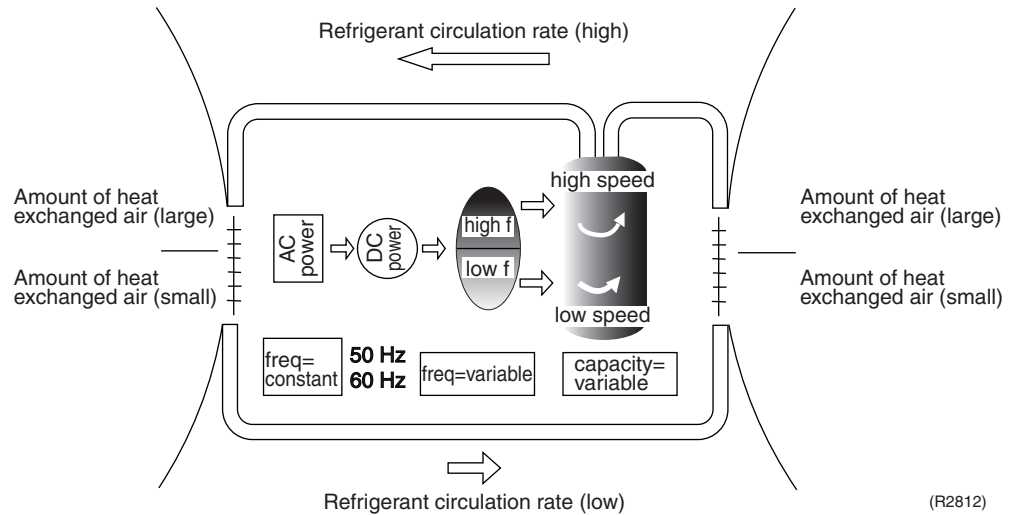

Inverter Features

The inverter provides the following features:

- The regulating capacity can be changed according to the changes in the outdoor temperature and cooling / heating load.
- Quick heating and quick cooling
The rotation speed of the compressor is increased when starting the heating (or cooling). This enables to reach the set temperature quickly.
- Even during extreme cold weather, high capacity is achieved. It is maintained even when the outdoor temperature is 2°C (35.6 °F).
- Comfortable air conditioning
A fine adjustment is integrated to keep the room temperature constant.
- Energy saving heating and cooling
Once the set temperature is reached, the energy saving operation enables to maintain the room temperature at low power.

Frequency Limits

The following functions regulate the minimum and maximum frequency:

Frequency	Functions
Low	<ul style="list-style-type: none"> ■ Four way valve operation compensation. Refer to page 44.
High	<ul style="list-style-type: none"> ■ Compressor protection function. Refer to page 44. ■ Discharge pipe temperature control. Refer to page 45. ■ Input current control. Refer to page 46. ■ Freeze-up protection control. Refer to page 47. ■ Heating peak-cut control. Refer to page 47. ■ Defrost control. Refer to page 49.

Forced Cooling Operation

Refer to page 115 for details.

1.3 Airflow Direction Control

Power-Airflow (Dual) Flap (s)

The large flap sends a large volume of air downward to the floor and provides an optimum control in cooling, dry, and heating operation.

Cooling/Dry

During cooling or dry operation, the flap retracts into the indoor unit. Then, cool air can be blown far and distributed all over the room.

Heating

During heating operation, the large flap directs airflow downward to spread the warm air to the entire room.

Wide-Angle Louvers

The louvers, made of elastic synthetic resin, provide a wide range of airflow that guarantees comfortable air distribution.

Auto-Swing

The following tables explain the auto-swing process for cooling, dry, heating, and fan:

FTX Series

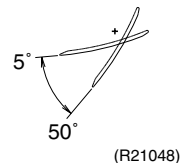
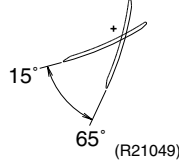
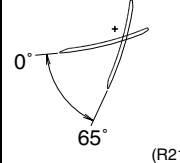
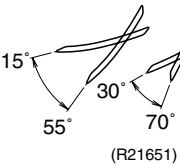
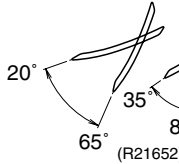
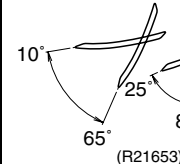
	Flap (up and down)		
	Cooling/Dry	Heating	Fan
09/12 class	 5° 50° (R21048)	 15° 65° (R21049)	 0° 65° (R21050)
15 class	 15° 30° 55° 70° (R21651)	 20° 35° 65° 80° (R21652)	 10° 25° 65° 80° (R21653)

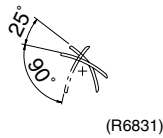
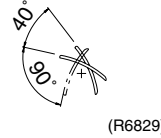
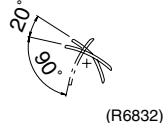
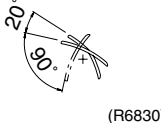

FVXS Series

	Flap (up and down)	
	Cooling/Dry	Heating
Upward airflow limit OFF	 25° 90° (R6831)	 40° 90° (R6829)
Upward airflow limit ON	 20° 90° (R6832)	 20° 90° (R6830)

COMFORT AIRFLOW Operation

FTX Series

The flap is controlled not to blow the air directly at the people in the room.

	Cooling	Heating
09/12 class	 0° (R21186)	 65° (R21187)
15 class	 10° (R21861)	

Airflow Selection setting

FVXS Series

Airflow direction can be set with the airflow selection switch.

- Open the front panel.

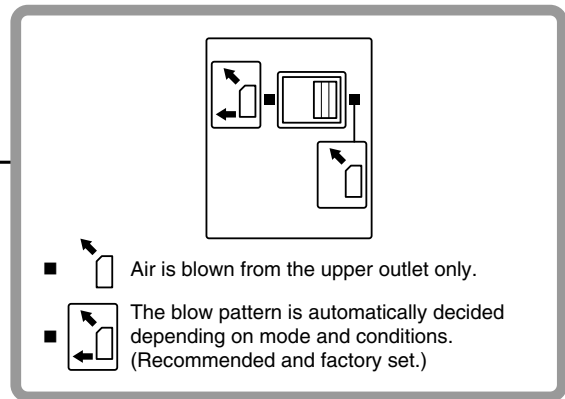
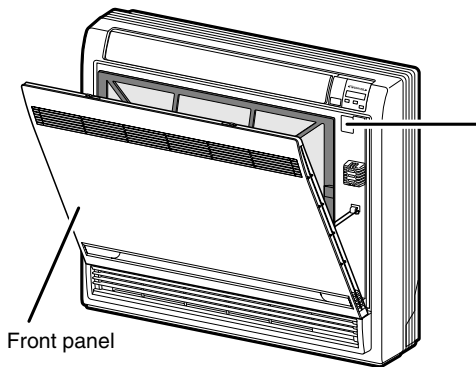

(R17866)







Caution:

Before opening the front panel, be sure to stop the operation and turn the breaker off. Do not touch the aluminum fins (indoor heat exchanger) inside of the indoor unit, as it may result in injury.

When setting the airflow selection switch to .

- Air conditioner automatically decides the appropriate blowing pattern depending on the operating mode/situation.

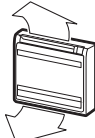
Operating mode	Situation	Blowing pattern	
Cooling	When the operation is activated or when the room is not fully cooled.		Air is blown from the upper and lower air outlets in order to reach the set temperature quickly.
	When the room has become fully cool, or when 1 hour has passed since turning on the air conditioner.		Air is blown only from the upper air outlet so that air does not come into direct contact with people and indoor temperature is equalized.
Heating	When the operation is activated or when air emitted is of low temperature.		Air is blown only from the upper air outlet so that air does not come into direct contact with people.
	At times other than the above situations.		Air is blown from the upper and lower air outlets so that warm air is spread throughout the whole room.
Dry	Whenever in DRY mode.		Air is blown only from the upper air outlet so that air does not come into direct contact with people.
Fan	Whenever in FAN mode.		
Automatic	Operates in the actual operation mode of the air conditioner according to the descriptions in this table. (COOL or HEAT)		

- During dry operation, air is blown upper air outlet, so that cold air does not come into direct contact with people.

When setting the airflow selection switch to .

- Regardless of the operating mode or situation, air is blown from the upper air outlet.
- Use this switch when you do not want air coming out of the lower air outlet (e.g., while sleeping).



1.4 Fan Speed Control for Indoor Unit

Outline

Phase control and fan speed control contains 9 steps: LLL, LL, SL, L, ML, M, MH, H, and HH. The airflow rate can be automatically controlled depending on the difference between the room thermistor temperature and the target temperature.

Automatic Fan Speed Control

In automatic fan speed operation, the step SL is not available.

Step	Cooling	Heating
LLL	 (R11681)	 (R6834)
LL		
L		
ML		
M		
MH		
H		
HH (POWERFUL)		

 = The airflow rate is automatically controlled within this range when the **FAN** button is set to automatic.

Cooling

The following drawing explains the principle of fan speed control for cooling.

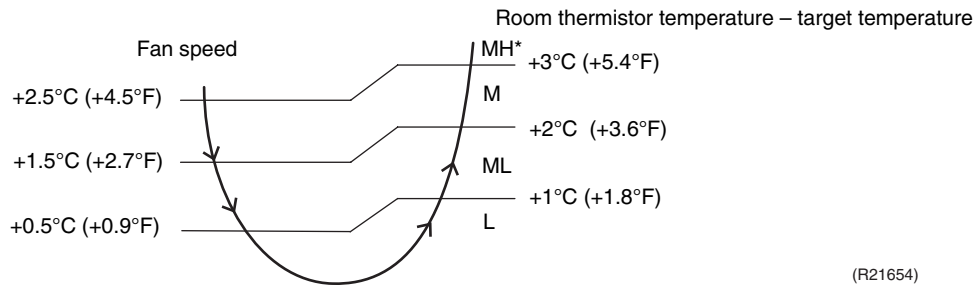

*The upper limit is M tap for 30 minutes from the operation start.

Heating

In heating operation, the fan speed is regulated according to the indoor heat exchanger temperature and the difference between the room thermistor temperature and the target temperature.



Note: The fan stops during defrost control.

COMFORT AIRFLOW Operation

FTX Series

- The fan speed is controlled automatically within the following steps.

Cooling

L tap ~ MH tap (same as automatic)

Heating

L tap ~ M tap

- The latest command has the priority between POWERFUL and COMFORT AIRFLOW.

1.5 Program Dry Operation

Outline

Program dry operation removes humidity while preventing the room temperature from lowering. Since the microcomputer controls both the temperature and airflow rate, the temperature adjustment and **FAN** setting buttons are inoperable.

Detail

The microcomputer automatically sets the temperature and airflow rate. The difference between the room thermistor temperature at start-up and the target temperature is divided into two zones. Then, the unit operates in an appropriate capacity for each zone to maintain the temperature and humidity at a comfortable level.

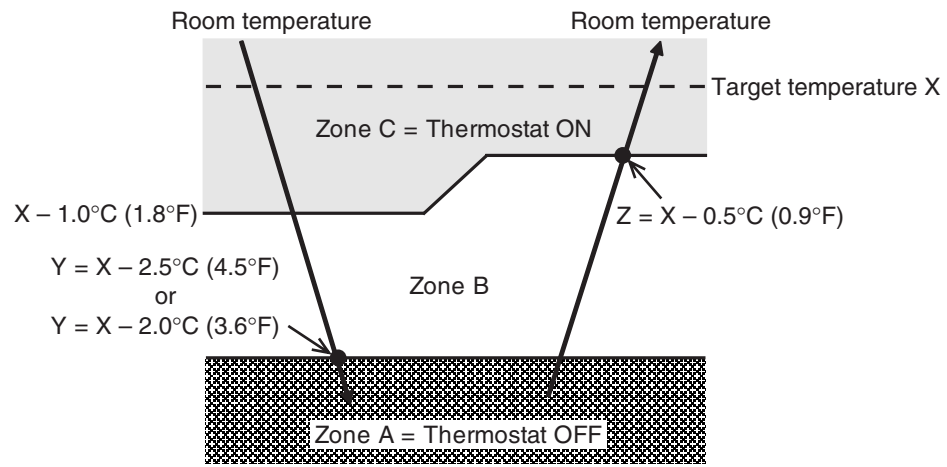

(R23000)

Room thermistor temperature at start-up	Target temperature X	Thermostat OFF point Y	Thermostat ON point Z ★
24°C or more (75.2°F or more)	Room thermistor temperature at start-up	$X - 2.5^{\circ}\text{C}$ ($X - 4.5^{\circ}\text{F}$)	$X - 0.5^{\circ}\text{C}$ ($X - 0.9^{\circ}\text{F}$)
18 ~ 23.5°C (64.4 ~ 74.3°F)		$X - 2.0^{\circ}\text{C}$ ($X - 3.6^{\circ}\text{F}$)	$X - 0.5^{\circ}\text{C}$ ($X - 0.9^{\circ}\text{F}$)
17.5°C or less (63.5°F or less)	18°C (64.4°F)	$X - 2.0^{\circ}\text{C}$ ($X - 3.6^{\circ}\text{F}$)	$X - 0.5^{\circ}\text{C} = 17.5^{\circ}\text{C}$ ($X - 0.9^{\circ}\text{F} = 63.5^{\circ}\text{F}$)

★ Thermostat turns on also when the room temperature is in the zone B for 10 min.

1.6 Automatic Operation

Outline

Automatic Cooling / Heating Function

When the automatic operation is selected with the remote controller, the microcomputer automatically determines the operation mode as cooling or heating according to the room temperature and the set temperature at start-up.

The unit automatically switches the operation mode to maintain the room temperature at the set temperature.

Detail

Ts: set temperature (set by remote controller)

Tt: target temperature (determined by microcomputer)

Tr: room thermistor temperature (detected by room temperature thermistor)

C: correction value

- The set temperature (Ts) determines the target temperature (Tt).
(Ts = 18 ~ 30°C, 64.4 ~ 86°F).
- The target temperature (Tt) is calculated as;
 $Tt = Ts + C$
where C is the correction value.
C = 0°C (0°F)
- Thermostat ON/OFF point and operation mode switching point are as follows.
Tr means the room thermistor temperature.
 - Heating → Cooling switching point:
 $Tr \geq Tt + 3.0^\circ\text{C} (+5.4^\circ\text{F})$
 - Cooling → Heating switching point:
 $Tr < Tt - 3.0^\circ\text{C} (-5.4^\circ\text{F})$
 - Thermostat ON/OFF point is the same as the ON/OFF point of cooling or heating operation.
- During initial operation
 $Tr \geq Ts$: Cooling operation
 $Tr < Ts$: Heating operation

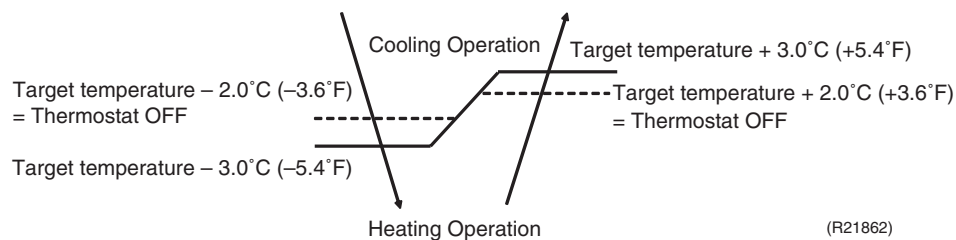

Ex: When the target temperature is 25°C (77°F)

Cooling → 23°C (73.4°F): Thermostat OFF → 22°C (71.6°F): Switch to heating

Heating → 27°C (80.6°F): Thermostat OFF → 28°C (82.4°F): Switch to cooling

1.7 Thermostat Control

Outline

Thermostat control is based on the difference between the room thermistor temperature and the target temperature.

Detail

Thermostat OFF Condition

- ◆ The temperature difference is in the zone A.

Thermostat ON Conditions

- ◆ The temperature difference returns to the zone C after being in the zone A.
- ◆ The system resumes from defrost control in any zones except A.
- ◆ The operation turns on in any zones except A.
- ◆ The monitoring time has passed while the temperature difference is in the zone B.
(Cooling: 10 minutes, Dry: 7.5 minutes, Heating: 10 seconds)

Cooling/Dry

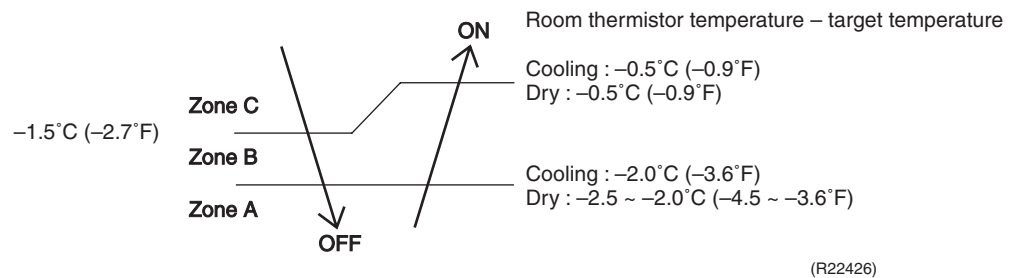

Heating

FTX Series

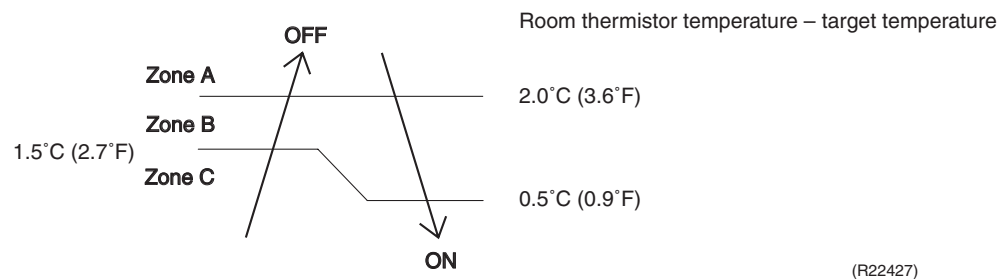

FVXS Series

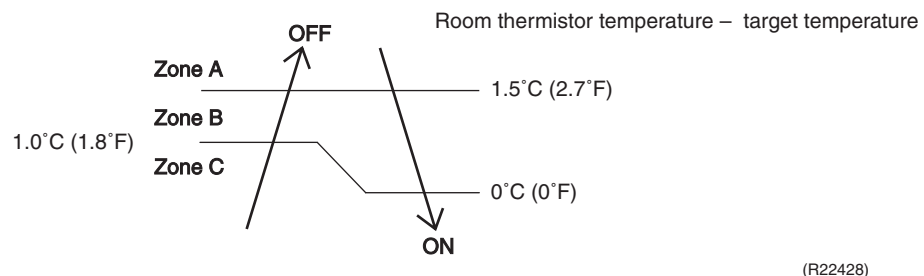

Refer to Temperature Control on page 20 for details.

1.8 NIGHT SET Mode

Outline When the OFF TIMER is set, NIGHT SET Mode is automatically activated. NIGHT SET Mode keeps the airflow rate setting.

Detail NIGHT SET Mode continues operation at the target temperature for the first one hour, then automatically raises the target temperature slightly in the case of cooling, or lowers it slightly in the case of heating. This prevents excessive cooling in summer and excessive heating in winter to ensure comfortable sleeping conditions, and also conserves electricity.

Cooling

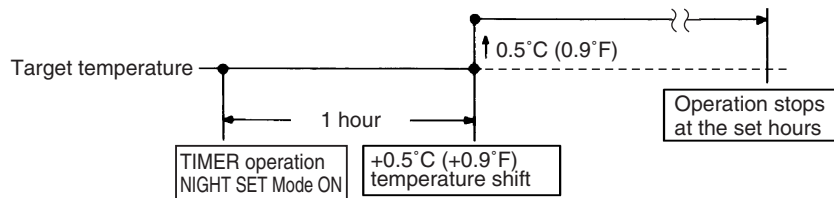

(R21657)

Heating

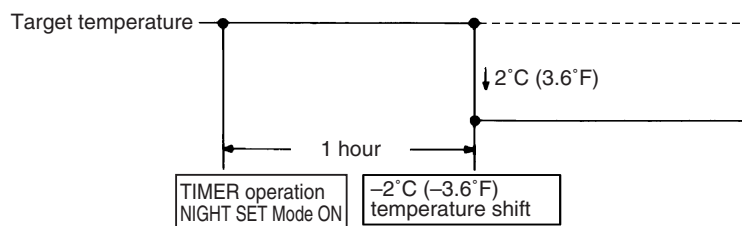

(R21658)

1.9 ECONO Operation

Outline ECONO operation reduces the maximum power consumption. This operation is particularly convenient for energy-saving. It is also a major bonus when breaker capacity does not allow the use of multiple electrical devices and air conditioners. It can be easily activated by pushing **ECONO** button on the wireless remote controller.

Detail

- When this function is activated, the maximum capacity also decreases.
- The remote controller can send the ECONO command when the unit is in cooling, heating, dry, or automatic operation. This function can only be set when the unit is running. Press **ON/OFF** button on the remote controller to cancel the function.
- This function and POWERFUL operation cannot be used at the same time. The latest command has the priority.

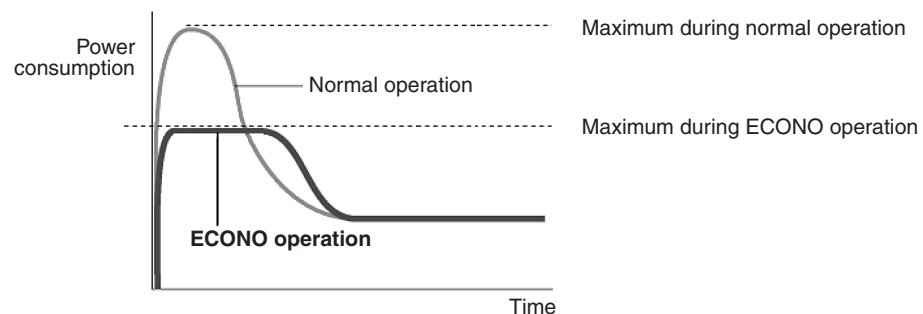

(R21051)

1.10 Inverter POWERFUL Operation

Outline

In order to exploit the cooling and heating capacity to full extent, the air conditioner can be operated by increasing the indoor fan rotating speed and the compressor frequency.

Detail

When **POWERFUL** button is pressed, the fan speed and target temperature are converted to the following states for 20 minutes.

Operation mode	Fan speed	Target temperature
COOL	H tap + A rpm	18°C (64.4°F)
DRY	Dry rotating speed + A rpm	Lowered by 2.5°C (4.5°F)
HEAT	H tap + A rpm	31°C (87.8°F)
FAN	H tap + A rpm	—
AUTO	Same as cooling / heating in POWERFUL operation	The target temperature is kept unchanged.

A = 09/12 class: 80 rpm
15 class: 50 rpm

Ex: POWERFUL operation in cooling

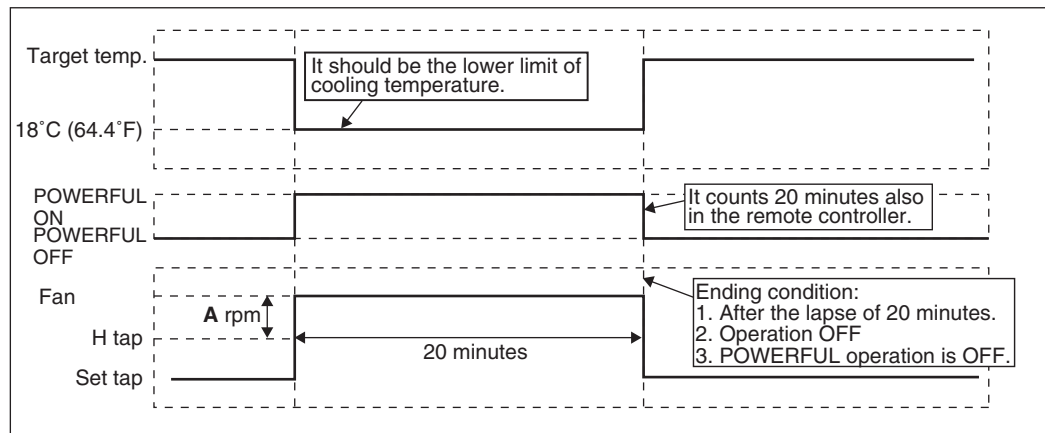

(R19193)



Note: POWERFUL operation cannot be used together with ECONO or COMFORT AIRFLOW operation.

1.11 Clock setting

ARC466 Series

The clock can be set by taking the following steps:

1. Press **Clock** button.
→ 0:00 is displayed and **MON** and ☉ blink.
2. Press **Select ▲** or **Select ▼** button to set the clock to the current day of the week.
3. Press **Clock** button.
→ ☉ blinks.
4. Press **Select ▲** or **Select ▼** button to adjust the clock to the present time.
Holding down **Select ▲** or **Select ▼** button increases or decreases the time display rapidly.
5. Press **Clock** button to set the clock. (Point the remote controller at the indoor unit when pressing the button.)
→ : blinks and clock setting is completed.

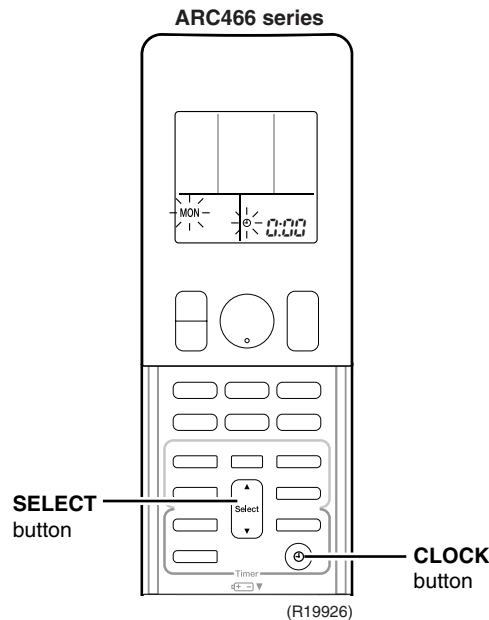

1.12 WEEKLY TIMER Operation (FVXS Series)

Outline

Up to 4 timer settings can be saved for each day of the week (up to 28 settings in total). The 3 items: ON/OFF, temperature, and time can be set.

Detail

Setting example of the WEEKLY TIMER

The same timer settings are used from Monday through Friday, while different timer settings are used for the weekend.

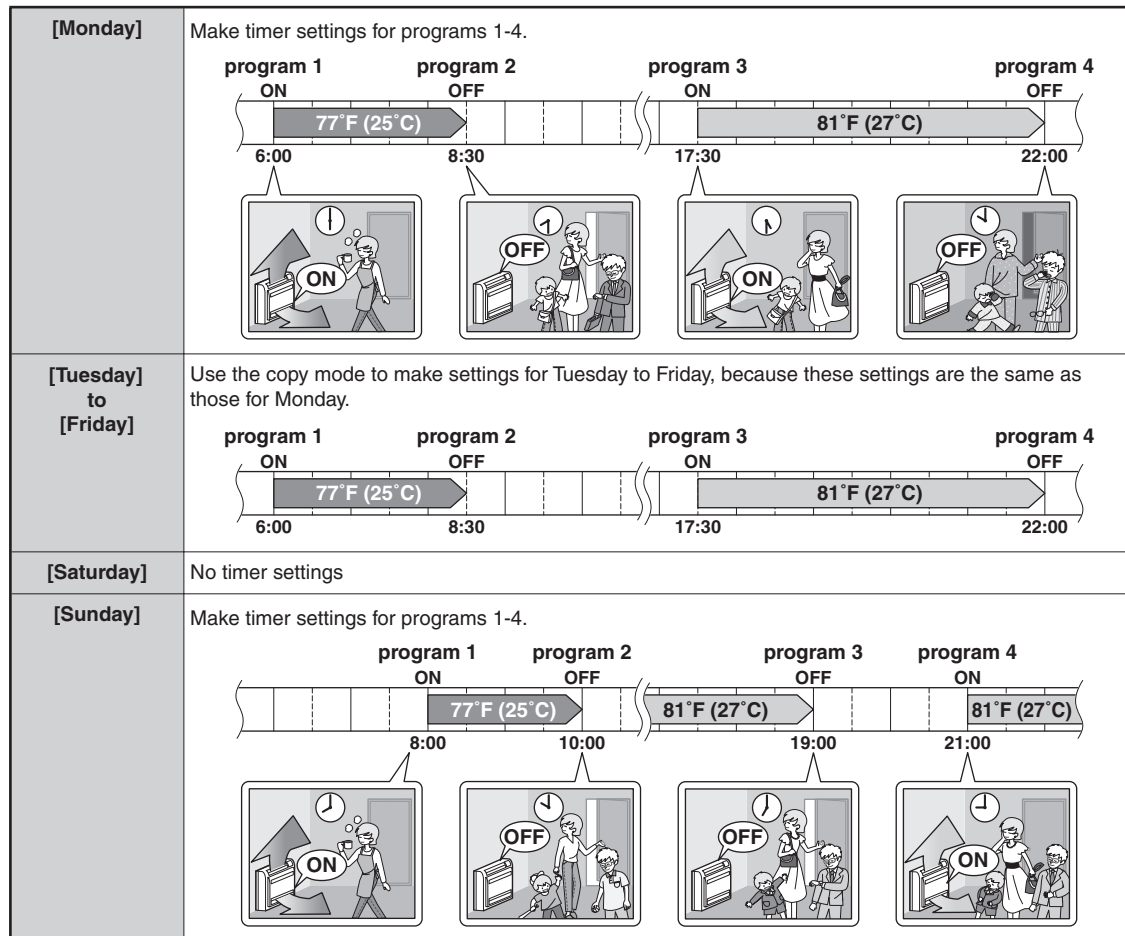

- Up to 4 reservations per day and 28 reservations per week can be set using the WEEKLY TIMER. The effective use of the copy mode simplifies timer programming.
- The use of ON-ON-ON-ON settings, for example, makes it possible to schedule operating mode and set temperature changes. Furthermore, by using OFF-OFF-OFF-OFF settings, only the turn off time of each day can be set. This will turn off the air conditioner automatically if you forget to turn it off.

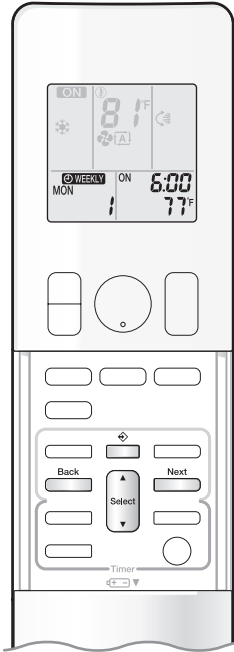

To use WEEKLY TIMER operation

Setting mode

- Make sure the day of the week and time are set.
If not, set the day of the week and time.

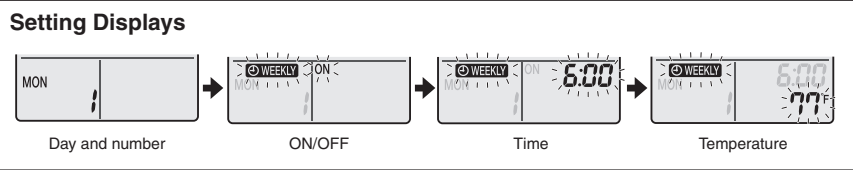
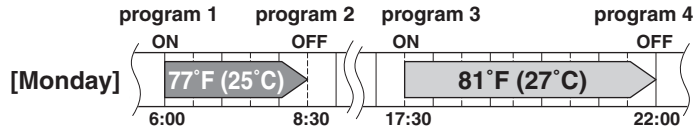

1. Press .

- The day of the week and the reservation number of the current day will be displayed.
- 1 to 4 settings can be made per day.

2. Press to select the desired day of the week and reservation number.

- Pressing  changes the reservation number and the day of the week.

3. Press .

- The day of the week and reservation number will be set.
- “ WEEKLY ” and “ON” blink.

4. Press to select the desired mode.

- Pressing  changes the “ON” or “OFF” setting in sequence.



- In case the reservation has already been set, selecting “blank” deletes the reservation.
- Proceed to **STEP 9** if “blank” is selected.
- To return to the day of the week and reservation number setting, press .

5. Press .

- The ON/OFF TIMER mode will be set.
- “ WEEKLY ” and the time blink.

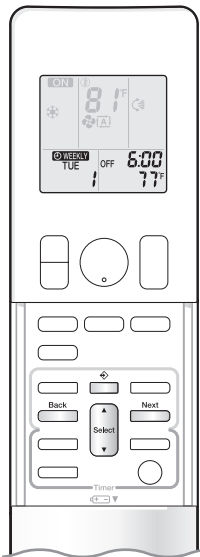

6. Press to select the desired time.

- The time can be set between 0:00 and 23:50 in 10-minute intervals.
- To return to the ON/OFF TIMER mode setting, press .
- Proceed to **STEP 9** when setting the OFF TIMER.

7. Press .

- The time will be set.
- “ WEEKLY” and the temperature blink.

8. Press to select the desired temperature.

- The temperature can be set between 50°F (10°C) and 90°F (32°C).
COOL or AUTO: The unit operates at 64°F (18°C) even if it is set at 50°F (10°C) to 63°F (17°C).
HEAT or AUTO : The unit operates at 86°F (30°C) even if it is set at 87°F (31°C) to 90°F (32°C).
- To return to the time setting, press .
- The set temperature is only displayed when the mode setting is on.

9. Press .

- The temperature will be set and go to the next reservation setting.
- The temperature is set while in ON TIMER operation, and the time is set while in OFF TIMER operation.
- The next reservation screen will appear.
- To continue further settings, repeat the procedure from **STEP 4**.

10. Press to complete the setting.

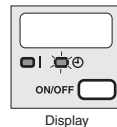

- Be sure to direct the remote controller toward the indoor unit and check for a receiving tone and blinking of the OPERATION lamp.
- “ WEEKLY” is displayed on the LCD and WEEKLY TIMER operation is activated.
- The TIMER lamp lights orange.



- A reservation made once can be easily copied and the same settings used for another day of the week. Refer to **Copy mode**.

NOTE

Notes on WEEKLY TIMER operation

- Do not forget to set the clock on the remote controller first.
- The day of the week, ON/OFF TIMER mode, time and set temperature (only for ON TIMER mode) can be set with the WEEKLY TIMER. Other settings for the ON TIMER are based on the settings just before the operation.
- WEEKLY TIMER and ON/OFF TIMER operation cannot be used at the same time. The ON/OFF TIMER operation has priority if it is set while WEEKLY TIMER is still active. The WEEKLY TIMER will enter the standby state, and “ WEEKLY” will disappear from the LCD. When the ON/OFF TIMER is up, the WEEKLY TIMER will automatically become active.
- Only the time and set temperature with the WEEKLY TIMER are sent with the . Set the WEEKLY TIMER only after setting the operation mode, the airflow rate and the airflow direction ahead of time.
- Turning off the circuit breaker, power failure, and other similar events will render operation of the indoor unit's internal clock inaccurate. Reset the clock.
-  can be used only for the time and temperature settings. It cannot be used to go back to the reservation number.

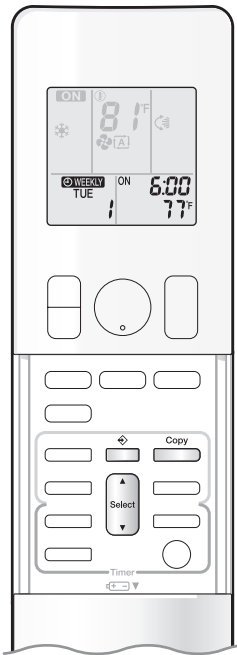

Copy mode

- A reservation made once can be copied to another day of the week. The whole reservation of the selected day of the week will be copied.

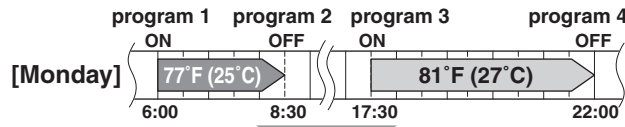

COPY

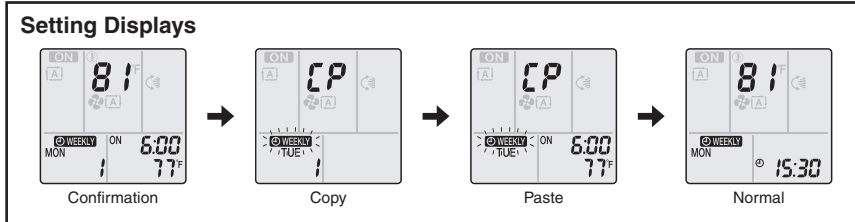
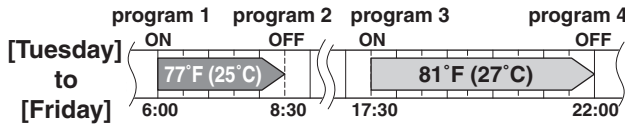

1. Press .
2. Press to confirm the day of the week to be copied.
3. Press .
 - The whole reservation of the selected day of the week will be copied.
4. Press to select the destination day of the week.
5. Press .
 - The reservation will be copied to the selected day of the week. The whole reservation of the selected day of the week will be copied.
 - To continue copying the settings to other days of the week, repeat **STEP 4** and **STEP 5**.
6. Press to complete the setting.
 - “ ” is displayed on the LCD and WEEKLY TIMER operation is activated.

NOTE

Note on COPY MODE

- The entire reservation of the source day of the week is copied in the copy mode.
- In the case of making a reservation change for any day of the week individually after copying the content of weekly reservations, press and change the settings in the steps of **Setting mode**.

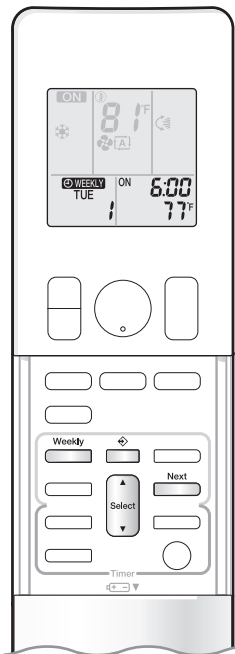

Confirming a reservation

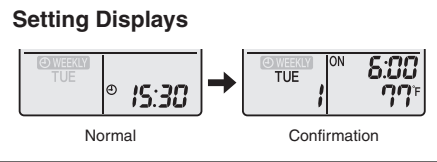

- The reservation can be confirmed.



1. Press .

- The day of the week and the reservation number of the current day will be displayed.

2. Press to select the day of the week and the reservation number to be confirmed.

- Pressing  displays the reservation details.
- To change the confirmed reserved settings, select the reservation number and press . The mode is switched to setting mode. Proceed to **Setting mode STEP 4**.

3. Press to exit the confirmation mode.

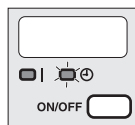

- “ WEEKLY” is displayed on the LCD and WEEKLY TIMER operation is activated.
- The TIMER lamp lights orange.



Display

To deactivate WEEKLY TIMER operation

Press while “ WEEKLY” is displayed on the LCD.

- “ WEEKLY” disappears from the LCD.
- The TIMER lamp goes off.
- To reactivate the WEEKLY TIMER operation, press  again.
- If a reservation deactivated with  is activated once again, the last reservation mode will be used.

NOTE

- If not all the reservation settings are reflected, deactivate the WEEKLY TIMER operation once. Then press  again to reactivate the WEEKLY TIMER operation.

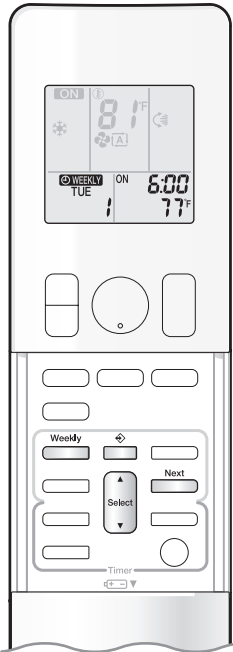

To delete reservations

An individual reservation

1. Press .

- The day of the week and the reservation number will be displayed.

2. Press to select the day of the week and the reservation number to be deleted.

3. Press .

- “ WEEKLY” and “ON” or “OFF” blink.

4. Press until no icon is displayed.

- Pressing  changes the ON/OFF TIMER mode in sequence.
- Selecting “blank” will cancel any reservation you may have.



Pressing  puts the sequence in reverse.

5. Press .

- The selected reservation will be deleted.

6. Press .

- If there are still other reservations, WEEKLY TIMER operation will be activated.

Reservations for each day of the week

- This function can be used for deleting reservations for each day of the week.
- It can be used while confirming or setting reservations.

1. Press .

- The day of the week and the reservation number will be displayed.

2. Press to select the day of the week to be deleted.

3. Hold for about 5 seconds.

- The reservation of the selected day of the week will be deleted.

4. Press .

- If there are still other reservations, WEEKLY TIMER operation will be activated.

All reservations

Hold for about 5 seconds with the normal display.

- Be sure to direct the remote controller toward the indoor unit and check for a receiving tone.
- This operation cannot be used for the WEEKLY TIMER setting display.
- All reservations will be deleted.

1.13 Other Functions

1.13.1 Hot-Start Function

In order to prevent the cold air blast that normally occurs when heating operation starts, the temperature of the indoor heat exchanger is detected, and the airflow is either stopped or significantly weakened resulting in comfortable heating.



Note: The cold air blast is prevented using similar control when defrost control starts or when the thermostat is turned ON.

1.13.2 Signal Receiving Sign

When the indoor unit receives a signal from the remote controller, the unit emits a signal receiving sound.

1.13.3 Indoor Unit ON/OFF Button

ON/OFF button is provided on the display of the unit.

- Press **ON/OFF** button once to start operation. Press once again to stop it.
- **ON/OFF** button is useful when the remote controller is missing or the battery has run out.

Mode	Temperature setting	Airflow rate
AUTO	25°C (77°F)	Automatic

FTX Series

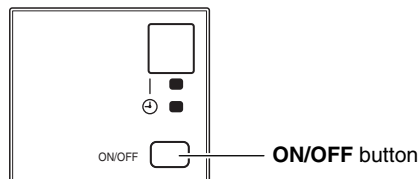

(R21052)

FVXS Series

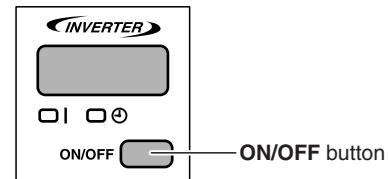

(R23001)

Forced Cooling Operation

Forced cooling operation can be started by pressing **ON/OFF** button for 5 to 9 seconds while the unit is not operating.

Refer to page 115 for details.



Note: When **ON/OFF** button is pressed for 10 seconds or more, the forced cooling operation is stopped.

1.13.4 Auto-restart Function

If a power failure (including one for just a moment) occurs during the operation, the operation restarts automatically when the power is restored in the same condition as before the power failure.



Note: It takes 3 minutes to restart the operation because the 3-minute standby function is activated.

2. Thermistor Functions

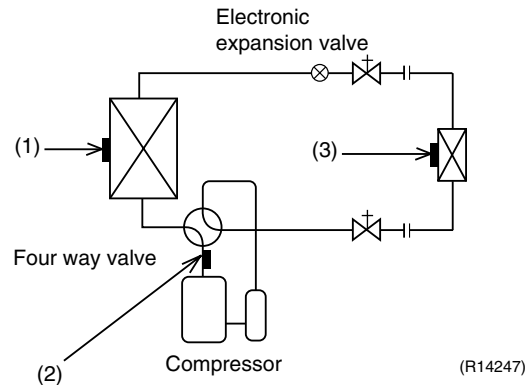

(1) Outdoor Heat Exchanger Thermistor

1. The outdoor heat exchanger thermistor is used for controlling the target discharge pipe temperature. The system sets the target discharge pipe temperature according to the outdoor and indoor heat exchanger temperature, and controls the electronic expansion valve opening so that the target discharge pipe temperature can be obtained.
2. In cooling operation, the outdoor heat exchanger thermistor is used for detecting the disconnection of the discharge pipe thermistor. When the discharge pipe temperature drops below the outdoor heat exchanger temperature by more than a certain value, the discharge pipe thermistor is judged as disconnected.
3. In cooling operation, the outdoor heat exchanger thermistor is used for high pressure protection.

(2) Discharge Pipe Thermistor

1. The discharge pipe thermistor is used for controlling discharge pipe temperature. If the discharge pipe temperature (used in place of the inner temperature of the compressor) rises abnormally, the operating frequency becomes lower or the operation halts.
2. The discharge pipe thermistor is used for detecting disconnection of the discharge pipe thermistor.

(3) Indoor Heat Exchanger Thermistor

1. The indoor heat exchanger thermistor is used for controlling the target discharge pipe temperature. The system sets the target discharge pipe temperature according to the outdoor and indoor heat exchanger temperature, and controls the electronic expansion valve opening so that the target discharge pipe temperature can be obtained.
2. In cooling operation, the indoor heat exchanger thermistor is used for freeze-up protection control. If the indoor heat exchanger temperature drops abnormally, the operating frequency becomes lower or the operation halts.
3. In heating operation, the indoor heat exchanger thermistor is used for detecting the disconnection of the discharge pipe thermistor. When the discharge pipe temperature drops below the indoor heat exchanger temperature by more than a certain value, the discharge pipe thermistor is judged as disconnected.

3. Control Specification

3.1 Mode Hierarchy

Outline The air conditioner control has normal operation mode, forced operation mode, and power transistor test mode for installation and servicing.

Detail **Heat Pump Model**

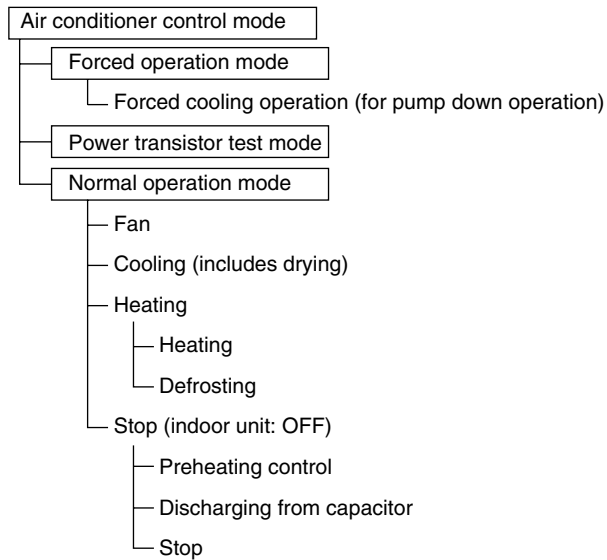

(R22375)



Note: Unless specified otherwise, a dry operation command is regarded as cooling operation.

3.2 Frequency Control

Outline

The compressor frequency is determined according to the difference between the room thermistor temperature and the target temperature.

When the shift of the frequency is less than zero ($\Delta F < 0$) by PI control, the target frequency is used as the command frequency.

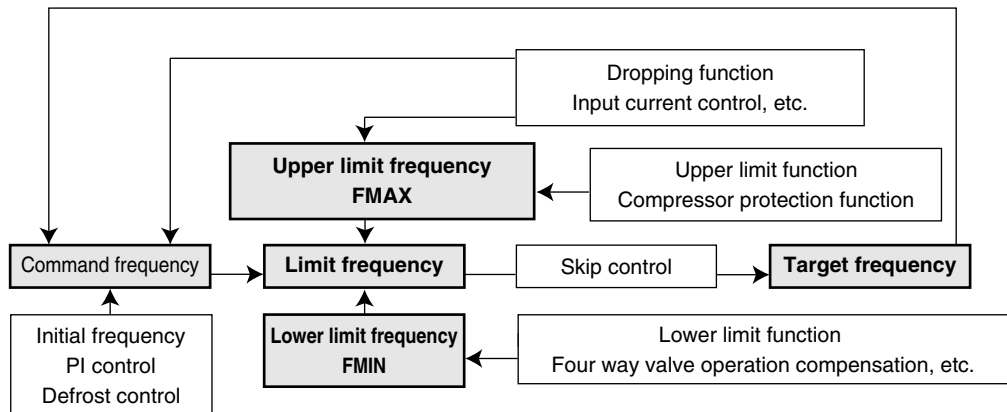

(R18023)

Detail

1. Determine command frequency

Command frequency is determined in the following order of priority.

1. Limiting defrost control time
2. Forced cooling
3. Indoor frequency command

2. Determine upper limit frequency

The minimum value is set as an upper limit frequency among the frequency upper limits of the following functions:

Compressor protection, input current, discharge pipe temperature, heating peak-cut, freeze-up protection, defrost control.

3. Determine lower limit frequency

The maximum value is set as a lower limit frequency among the frequency lower limits of the following functions:

Four way valve operation compensation, draft prevention, pressure difference upkeep.

4. Determine prohibited frequency

There is a certain prohibited frequency such as a power supply frequency.

Initial Frequency

When starting the compressor, the frequency is initialized according to the ΔD value of the indoor unit.

 ΔD signal: Indoor frequency command

The difference between the room thermistor temperature and the target temperature is taken as the ΔD value and is used for ΔD signal of frequency command.

Temperature difference	ΔD signal	Temperature difference	ΔD signal	Temperature difference	ΔD signal	Temperature difference	ΔD signal
-2.0°C (-3.6°F)	*OFF	0°C (0°F)	4	2.0°C (3.6°F)	8	4.0°C (7.2°F)	C
-1.5°C (-2.7°F)	1	0.5°C (0.9°F)	5	2.5°C (4.5°F)	9	4.5°C (8.1°F)	D
-1.0°C (-1.8°F)	2	1.0°C (1.8°F)	6	3.0°C (5.4°F)	A	5.0°C (9.0°F)	E
-0.5°C (-0.9°F)	3	1.5°C (2.7°F)	7	3.5°C (6.3°F)	B	5.5°C (9.9°F)	F

*OFF = Thermostat OFF

PI Control**1. P control**

The ΔD value is calculated in each sampling time (20 seconds), and the frequency is adjusted according to its difference from the frequency previously calculated.

2. I control

If the operating frequency does not change for more than a certain fixed time, the frequency is adjusted according to the ΔD value.

When the ΔD value is low, the frequency is lowered.

When the ΔD value is high, the frequency is increased.

3. Frequency control when other controls are functioning

- ◆ When frequency is dropping;
Frequency control is carried out only when the frequency drops.
- ◆ For limiting lower limit;
Frequency control is carried out only when the frequency rises.

4. Upper and lower limit of frequency by PI control

The frequency upper and lower limits are set according to the command of the indoor unit.

When the indoor or outdoor unit quiet operation command comes from the indoor unit, the upper limit frequency is lower than the usual setting.

3.3 Controls at Mode Changing / Start-up

3.3.1 Preheating Control

Outline The inverter operation in open phase starts with the conditions of the outdoor temperature, the discharge pipe temperature, the radiation fin temperature and the preheating command from the indoor unit.

Detail Outdoor temperature $\geq -2.5^{\circ}\text{C}$ (27.5°F) \rightarrow Control A (preheating for normal state)
 Outdoor temperature $< -2.5^{\circ}\text{C}$ (27.5°F) \rightarrow Control B (preheating of increased capacity)

Control A

- ◆ ON condition
 - Discharge pipe temperature $< 0^{\circ}\text{C}$ (32.0°F)
 - Radiation fin temperature $< 85^{\circ}\text{C}$ (185°F)
- ◆ OFF condition
 - Discharge pipe temperature $> 2^{\circ}\text{C}$ (35.6°F)
 - Radiation fin temperature $\geq 90^{\circ}\text{C}$ (194°F)

Control B

- ◆ ON condition
 - Discharge pipe temperature $< 10^{\circ}\text{C}$ (50.0°F)
 - Radiation fin temperature $< 85^{\circ}\text{C}$ (185°F)
- ◆ OFF condition
 - Discharge pipe temperature $> 12^{\circ}\text{C}$ (53.6°F)
 - Radiation fin temperature $\geq 90^{\circ}\text{C}$ (194°F)

3.3.2 Four Way Valve Switching

Outline The four way valve coil is energized / not energized depending on the operation mode. (Heating: ON, Cooling / Dry / Defrost: OFF)
 In order to eliminate the switching sound as the four way valve coil switches from ON to OFF when the heating is stopped, the OFF delay switch of the four way valve is carried out.

Detail **OFF delay switch of four way valve**
 The four way valve coil is energized for 160 seconds after the operation is stopped.

3.3.3 Four Way Valve Operation Compensation

Outline

At the beginning of operation as the four way valve is switched, the pressure difference to activate the four way valve is acquired when the output frequency is higher than a certain fixed frequency, for a certain fixed time.

Detail

Starting Conditions

1. When the compressor starts and the four way valve switches from OFF to ON
2. When the four way valve switches from ON to OFF during operation
3. When the compressor starts after resetting
4. When the compressor starts after the fault of four way valve switching

The lower limit of frequency keeps **A** Hz for **B** seconds with any conditions 1 through 4 above.

When the outdoor temperature is above **C** °C in heating, the frequency decreases depending on the outdoor temperature.

	09 class		12 class		15 class	
	Cooling	Heating	Cooling	Heating	Cooling	Heating
A (Hz)	40	54	24	34	48	
B (seconds)	60		60		70	
C	(°C)	10	10		15	
	(°F)	50	50		59	

3.3.4 3-Minute Standby

Turning on the compressor is prohibited for 3 minutes after turning it off.

(The function is not activated when defrosting.)

3.3.5 Compressor Protection Function

When turning the compressor from OFF to ON, the upper limit of frequency is set as follows.

(The function is not activated when defrosting.)

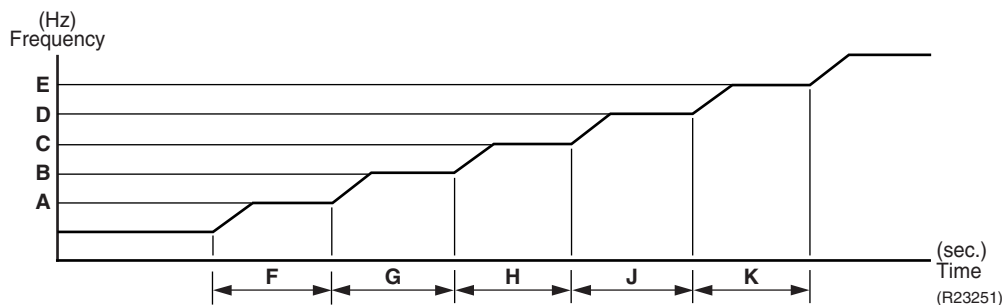

	09 class	12 class	15 class	15 class ★
A (Hz)	40	24	52	35
B (Hz)	54	34	68	52
C (Hz)	72	44	80	62
D (Hz)	90	56	98	80
E (Hz)	100	78	—	100
F (seconds)	180	180	300	1300
G (seconds)	420	420	200	250
H (seconds)	180	180	460	300
J (seconds)	120	120	200	200
K (seconds)	400	180	—	120

★: Values refer to 15 class only, when outside temperature is lower than -15°C (5°F)

3.4 Discharge Pipe Temperature Control

Outline

The discharge pipe temperature is used as the internal temperature of the compressor. If the discharge pipe temperature rises above a certain level, the upper limit of frequency is set to keep the discharge pipe temperature from rising further.

Detail

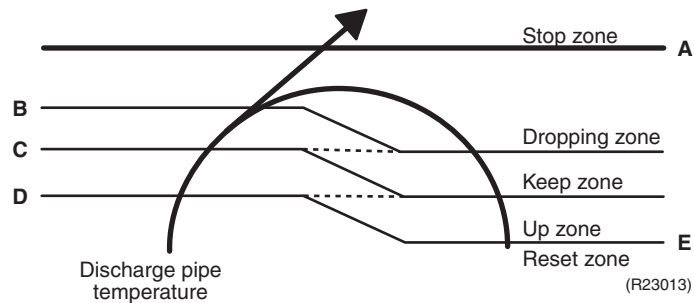

	09 class		12/15 class	
	(°C)	(°F)	(°C)	(°F)
A	110	230.0	110	230.0
B	103	217.4	103	217.4
C	98	208.4	101.5	214.7
D	93	199.4	100	212.0
E	88	190.4	95	203.0

Zone	Control
Stop zone	When the temperature reaches the stop zone, the compressor stops.
Dropping zone	The upper limit of frequency decreases.
Keep zone	The upper limit of frequency is kept.
Up zone	The upper limit of frequency increases.
Reset zone	The upper limit of frequency is canceled.

3.5 Input Current Control

Outline

The microcomputer calculates the input current while the compressor is running, and sets the frequency upper limit based on the input current.

In case of heat pump models, this control is the upper limit control of frequency and takes priority over the lower limit control of four way valve operation compensation.

Detail

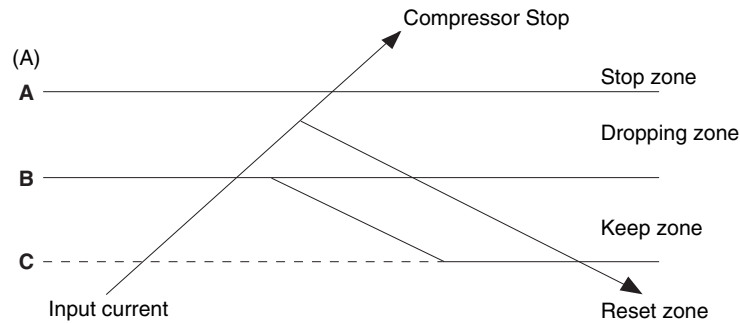

Frequency control in each zone

Stop zone

- After the input current remains in the stop zone for 2.5 seconds, the compressor is stopped.

Dropping zone

- The upper limit of the compressor frequency is defined as operation frequency – 2 Hz.
- After this, the output frequency is lowered by 2 Hz every second until it reaches the keep zone.

Keep zone

- The present maximum frequency goes on.

Reset zone

- Limit of the frequency is canceled.

	09 class		12 class		15 class	
	Cooling	Heating	Cooling	Heating	Cooling	Heating
A (A)	12		13		18	
B (A)	7.5	8.5	11.5	12	12	12
C (A)	6.5	7.5	10.75	11.25	11	11

Limitation of current dropping and stop value according to the outdoor temperature

- The current drops when outdoor temperature becomes higher than a certain level (depending on the model).

3.6 Freeze-up Protection Control

During cooling operation, the signal sent from the indoor unit determines the frequency upper limit and prevents freezing of the indoor heat exchanger. (The signal from the indoor unit is divided into zones.)

The operating frequency limitation is judged with the indoor heat exchanger temperature.

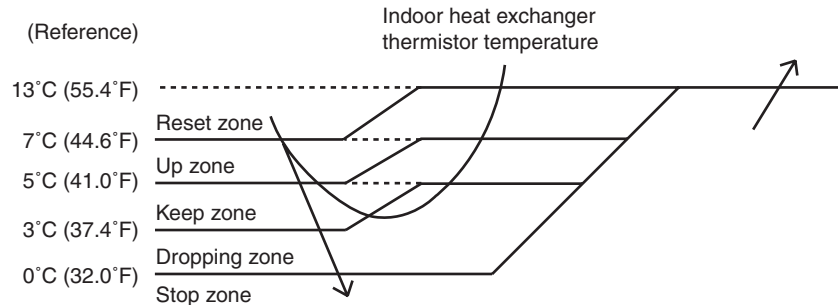

(R22994)

3.7 Heating Peak-cut Control

During heating operation, the indoor heat exchanger temperature determines the frequency upper limit to prevent abnormal high pressure.

The operating frequency limitation is judged with the indoor heat exchanger temperature.

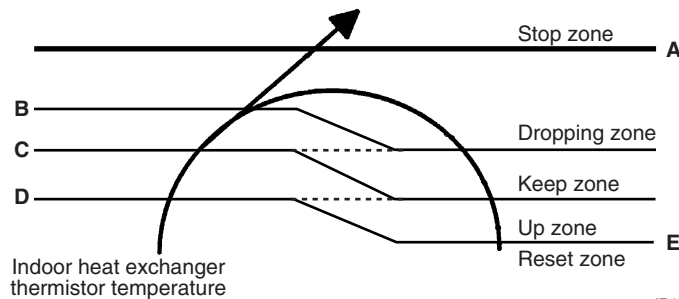

(R22995)

	09/12 class		15 class	
	(°C)	(°F)	(°C)	(°F)
A	59	138.2	60	140.0
B ★	55	131.0	54	129.2
C ★	52	125.6	51	123.8
D ★	50	122.0	49	120.2
E	45	113.0	44	111.2

★: The values might drop when the outdoor temperature is low to protect the compressor.

Zone	Control
Stop zone	When the temperature reaches the stop zone, the compressor stops.
Dropping zone	The upper limit of frequency decreases.
Keep zone	The upper limit of frequency is kept.
Up zone	The upper limit of frequency increases.
Reset zone	The upper limit of frequency is canceled.

3.8 Outdoor Fan Control

1. Fan ON control to cool down the electrical box

The outdoor fan is turned ON when the electrical box temperature is high while the compressor is OFF.

2. Fan OFF control during defrosting

The outdoor fan is turned OFF during defrosting.

3. Fan OFF delay when stopped

The outdoor fan is turned OFF 60 ~ 70 seconds after the compressor stops.

4. Fan speed control for pressure difference upkeep

The rotation speed of the outdoor fan is controlled for keeping the pressure difference during cooling operation with low outdoor temperature.

- ◆ When the pressure difference is low, the rotation speed of the outdoor fan is reduced.
- ◆ When the pressure difference is high, the rotation speed of the outdoor fan is controlled as well as normal operation.

5. Fan speed control during forced cooling operation

The outdoor fan is controlled as well as normal operation during forced cooling operation.

6. Fan speed control during POWERFUL operation

The rotation speed of the outdoor fan is increased during POWERFUL operation.

7. Fan speed control during indoor / outdoor unit quiet operation

The rotation speed of the outdoor fan is reduced by the command of the indoor / outdoor unit quiet operation.

8. Fan ON/OFF control when operation (cooling, heating, dry) starts / stops

The outdoor fan is turned ON when the operation starts. The outdoor fan is turned OFF when the operation stops.

3.9 Liquid Compression Protection Function

Outline

In order to increase the dependability of the compressor, the compressor is stopped according to the outdoor temperature.

Detail

Operation stops depending on the outdoor temperature
Compressor turns off under the conditions that the system is in cooling operation and outdoor temperature is below -20°C (-4°F).

3.10 Defrost Control

Outline

Defrosting is carried out by the cooling cycle (reverse cycle). The defrosting time or outdoor heat exchanger temperature must be more than a certain value to finish defrosting.

Detail

Conditions for Starting Defrost

- The starting conditions are determined with the outdoor temperature and the outdoor heat exchanger temperature.
- The system is in heating operation.
- The compressor operates for 6 minutes.
- More than **A** minutes (depending on the duration of the previous defrost control) of accumulated time have passed since the start of the operation, or ending the previous defrosting.

Conditions for Canceling Defrost

The judgment is made with the outdoor heat exchanger temperature (**B**°C).

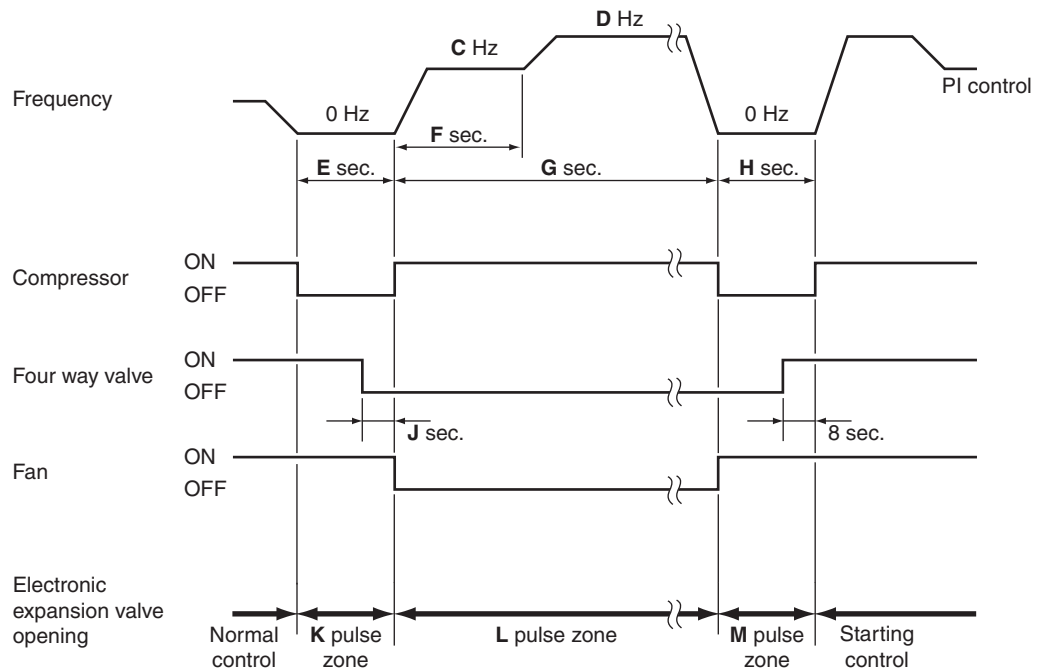

	09 class	12 class	15 class
A (minute)	20	20	25
B	(°C)	2 ~ 20	6 ~ 30
	(°F)	35.6 ~ 68.0	42.8 ~ 86.0
C (Hz)	64 ★	40 ★	48
D (Hz)	64 ★	40 ★	42
E (seconds)	40	40 ★	60 ★
F (seconds)	60	60	60 ★
G (seconds)	510	510	340
H (seconds)	50	50	90
J (seconds)	8	8	5
K (pulse)	400	400	450
L (pulse)	300	300	300 ~ 450
M (pulse)	350	350	200

★: The same value continues.

3.11 Electronic Expansion Valve Control

Outline

The following items are included in the electronic expansion valve control.

Electronic expansion valve is fully closed

1. Electronic expansion valve is fully closed when turning on the power.
2. Pressure equalizing control

Open Control

1. Electronic expansion valve control when starting operation
2. Electronic expansion valve control when the frequency changes
3. Electronic expansion valve control for defrosting
4. Electronic expansion valve control when the discharge pipe temperature is abnormally high
5. Electronic expansion valve control when the discharge pipe thermistor is disconnected

Feedback Control

Target discharge pipe temperature control

Detail

The followings are the examples of electronic expansion valve control which function in each operation mode.

	Power on : Compressor stop	Operation start	Frequency change under starting control	During target discharge pipe temperature control	Frequency change under target discharge pipe temperature control	Discharge pipe thermistor disconnection	Frequency change under discharge pipe thermistor disconnection control	During defrost control
Starting operation control	—	●	—	—	—	—	—	—
Control when the frequency changes	—	—	●	—	●	—	—	—
Target discharge pipe temperature control	—	—	—	●	—	—	—	—
Discharge pipe thermistor disconnection control	—	—	—	—	—	●	●	—
High discharge pipe temperature control	—	●	●	●	●	—	—	—
Defrost control (heating only)	—	—	—	—	—	—	—	●
Pressure equalizing control	●	—	—	—	—	—	—	—
Opening limit control	—	●	●	●	●	●	●	—

- : Available
- : Not available

3.11.1 Fully Closing with Power ON

The electronic expansion valve is initialized when turning on the power. The opening position is set and the pressure is equalized.

3.11.2 Pressure Equalizing Control

When the compressor is stopped, the pressure equalizing control is activated. The electronic expansion valve opens and the pressure is equalized.

3.11.3 Opening Limit Control

The maximum and minimum opening of the electronic expansion valve are limited.

	09/12 class	15 class
Maximum opening (pulse)	470	480
Minimum opening (pulse)	32	52

The electronic expansion valve is fully closed when cooling operation stops, and is opened at a fixed degree during defrosting.

3.11.4 Starting Operation Control

The electronic expansion valve opening is controlled when the operation starts, thus preventing the superheating or liquid compression.

3.11.5 Control when the frequency changes

When the target discharge pipe temperature control is active, if the target frequency changes to a specified value in a certain time period, the target discharge pipe temperature control is canceled and the target opening of the electronic expansion valve is changed according to the frequency shift.

3.11.6 High Discharge Pipe Temperature Control

When the compressor is operating, if the discharge pipe temperature exceeds a certain value, the electronic expansion valve opens and the refrigerant runs to the low pressure side. This procedure lowers the discharge pipe temperature.

3.11.7 Discharge Pipe Thermistor Disconnection Control

Outline

The disconnection of the discharge pipe thermistor is detected by comparing the discharge pipe temperature with the condensation temperature. If the discharge pipe thermistor is disconnected, the electronic expansion valve opens according to the outdoor temperature and the operation frequency, operates for a specified time, and then stops.

After 3 minutes, the operation restarts and checks if the discharge pipe thermistor is disconnected. If the discharge pipe thermistor is disconnected, the system stops after operating for a specified time.

If the disconnection is detected repeatedly, the system is shut down. When the compressor runs for 60 minutes without any error, the error counter is reset.

Detail

Determining thermistor disconnection

When the starting control finishes, the detection timer for disconnection of the discharge pipe thermistor (**A** seconds) starts. When the timer is over, the following adjustment is made.

- When the operation mode is cooling
 - When the following condition is fulfilled, the discharge pipe thermistor disconnection is ascertained.
 - Discharge pipe temperature +6°C (+10.8°F) < outdoor heat exchanger temperature

2. When the operation mode is heating

When the following condition is fulfilled, the discharge pipe thermistor disconnection is ascertained.

Discharge pipe temperature $+6^{\circ}\text{C}$ ($+10.8^{\circ}\text{F}$) $<$ indoor heat exchanger temperature

	A (seconds)	
	09/12 class	15 class
Other than below	720	540
Heating (when outdoor temperature is below -15°C (5°F))	1200	1800

When the thermistor is disconnected

When the disconnection is ascertained, the compressor continues operation for 9 minutes and then stops.

If the compressor stops repeatedly, the system is shut down.

3.11.8 Target Discharge Pipe Temperature Control

The target discharge pipe temperature is obtained from the indoor and outdoor heat exchanger temperature, and the electronic expansion valve opening is adjusted so that the actual discharge pipe temperature becomes close to the target discharge pipe temperature. (Indirect SH (superheating) control using the discharge pipe temperature)

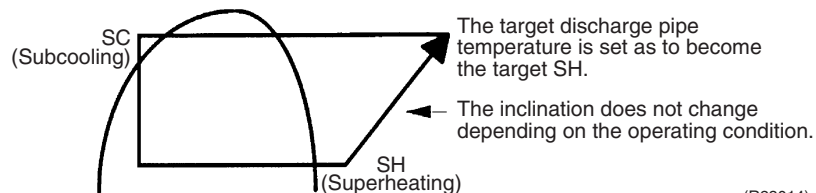

(R23014)

The electronic expansion valve opening and the target discharge pipe temperature are adjusted every **A** seconds. The opening degree of the electronic expansion valve is adjusted by the followings.

- ◆ Target discharge pipe temperature
- ◆ Actual discharge pipe temperature
- ◆ Previous discharge pipe temperature

	All outdoor units
A (seconds)	10 ~ 30 ★

★ The time depends on the opening of the electronic expansion valve.

3.12 Malfunctions

3.12.1 Sensor Malfunction Detection

Sensor malfunction can be detected in the following thermistor:

1. Outdoor heat exchanger thermistor
2. Discharge pipe thermistor
3. Radiation fin thermistor
4. Outdoor temperature thermistor

3.12.2 Detection of Overcurrent and Overload

Outline

An excessive output current is detected and the OL temperature is observed to protect the compressor.

Detail

- If the OL (compressor head) temperature exceeds 120 ~ 130°C (248 ~ 266°F) (depending on the model), the system shuts down the compressor.
- If the inverter current exceeds 12.0 ~ 18.0 A (depending on the model), the system shuts down the compressor.
The upper limit of the current decreases when the outdoor temperature exceeds a certain level.

Part 5

Remote Controller

1. FTX Series	55
2. FVXS Series.....	57

1. FTX Series

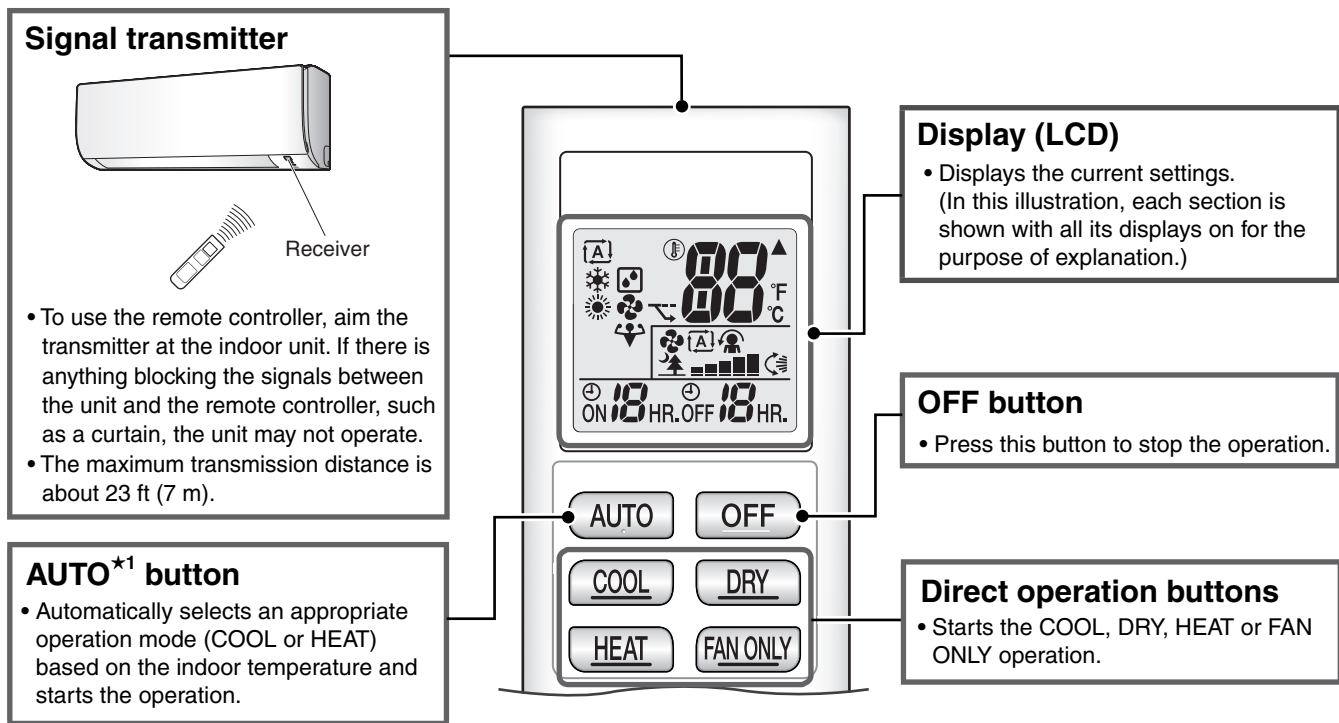

< ARC480A8 >

(R22996)

Reference

Refer to the following pages for details.

★1	Automatic operation	P.25
----	---------------------	------



Note:

Refer to the operation manual of applicable model for details. You can download operation manuals from Daikin Business Portal:

Daikin Business Portal → Document Search → Item Category → Installation/Operation Manual
(URL: https://global1d.daikin.com/business_portal/login/)

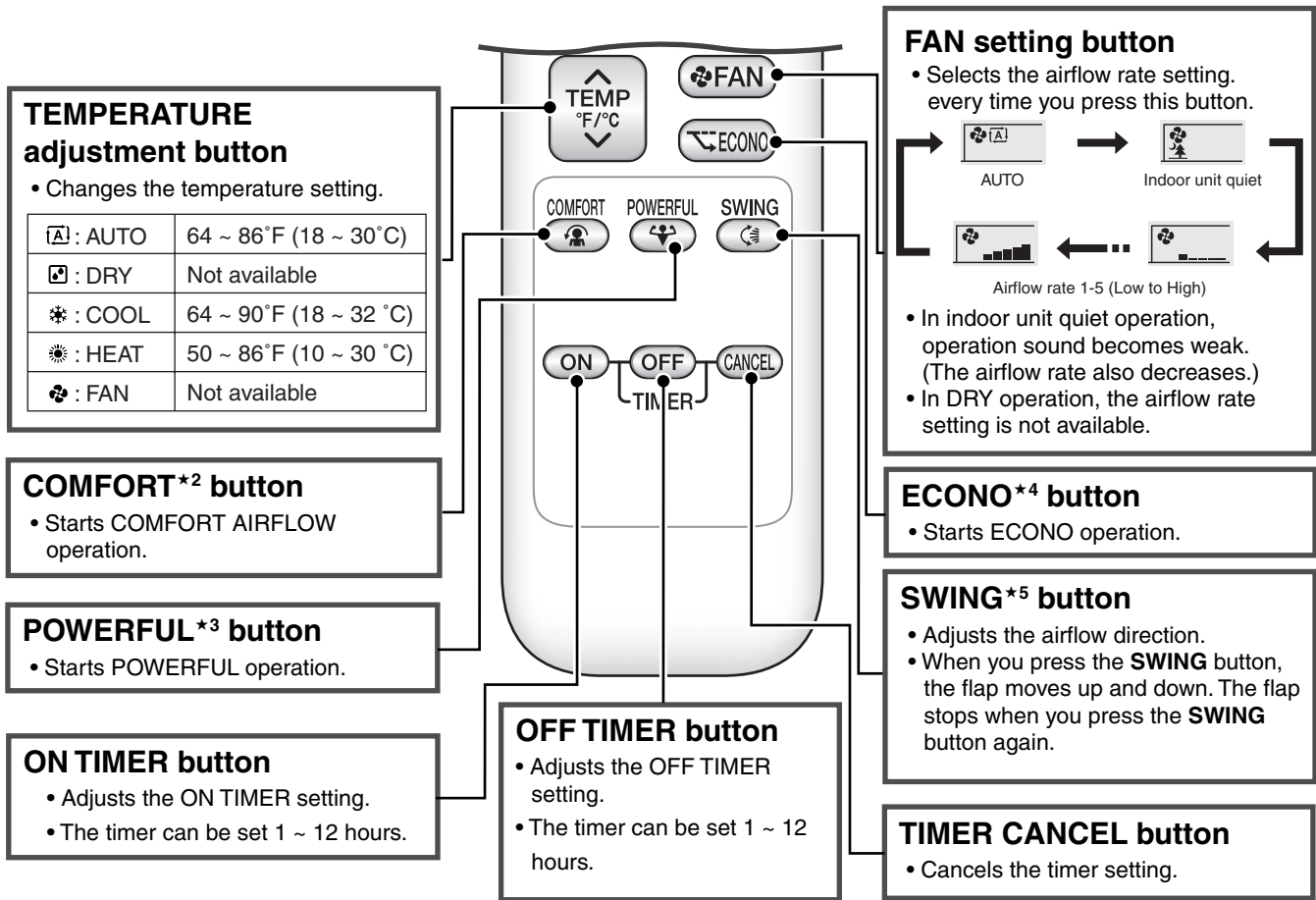

(R21664)

Reference

Refer to the following pages for details.

★2	COMFORT AIRFLOW operation	P.23 P.25	★4	ECONO operation	P.29
★3	Inverter POWERFUL operation	P.30	★5	Auto-swing	P.22



Note:

Refer to the operation manual of applicable model for details. You can download operation manuals from Daikin Business Portal:

Daikin Business Portal → Document Search → Item Category → Installation/Operation Manual
(URL: https://global1d.daikin.com/business_portal/login/)

2. FVXS Series

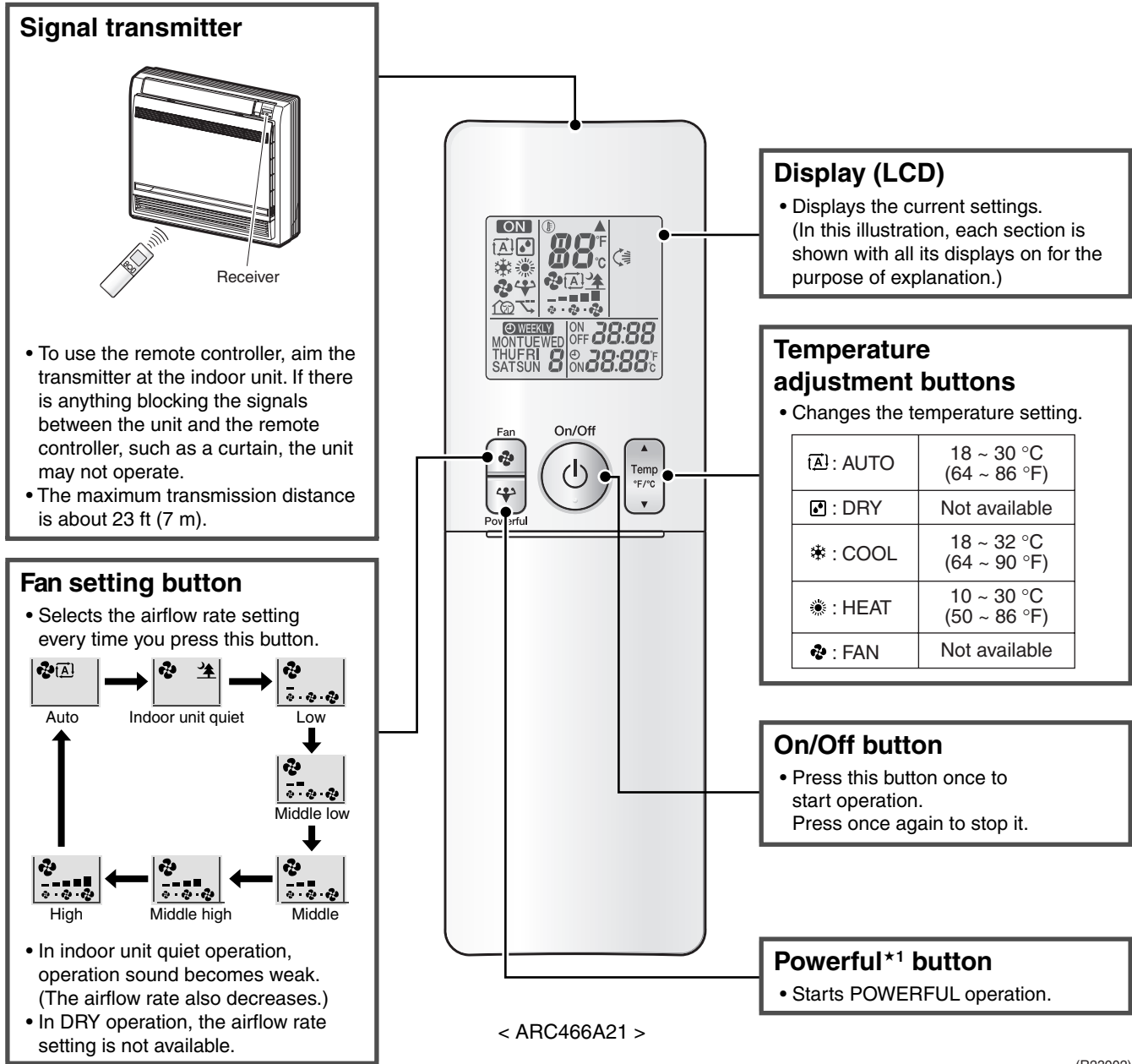

(R23002)

Reference

Refer to the following pages for details.

★1	Inverter POWERFUL operation	P.30
----	-----------------------------	------



Note:

Refer to the operation manual of applicable model for details. You can download operation manuals from Daikin Business Portal:
 Daikin Business Portal → Document Search → Item Category → Installation/Operation Manual
 (URL: https://global1d.daikin.com/business_portal/login/)

Open the Front Cover

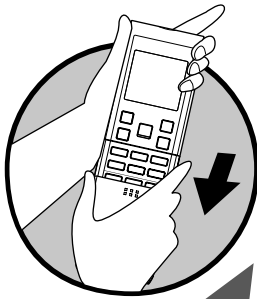

Mode button

- Selects the operation mode.

Quiet button

- OUTDOOR UNIT QUIET operation.
- OUTDOOR UNIT QUIET operation is not available in FAN and DRY operation.
- OUTDOOR UNIT QUIET operation and POWERFUL operation cannot be used at the same time. Priority is given to the function you pressed last.

Off Timer button

- Press this button and adjust the day and time with the **Select** button. Press this button again to complete TIMER setting.

Timer Cancel button

- Cancels the timer setting.
- Cannot be used for the WEEKLY TIMER operation.

Select button

- It changes the ON/OFF TIMER and WEEKLY TIMER settings.

Econo^{★2} button

- Starts ECONO operation.

Swing^{★3} button

- Adjusts the airflow direction.
- When you press the **Swing** button, the flap moves up and down. The flap stops when you press the **Swing** button again.

Weekly button

Weekly

- ◻ : Weekly button
- ◊ : Program button
- ◻ : Copy button
- ◻ : Back button
- ◻ : Next button

- WEEKLY TIMER^{★4} operation.

On Timer button

- Press this button and adjust the day and time with the **Select** button. Press this button again to complete TIMER setting.

Clock^{★5} button

(R23003)

Reference

Refer to the following pages for details.

★2	ECONO operation	P.29
★3	Auto-swing	P.22

★4	WEEKLY TIMER operation	P.32
★5	Clock setting	P.31



Note:

Refer to the operation manual of applicable model for details. You can download operation manuals from Daikin Business Portal:
 Daikin Business Portal → Document Search → Item Category → Installation/Operation Manual
 (URL: https://global1d.daikin.com/business_portal/login/)

Part 6

Service Diagnosis

1. General Problem Symptoms and Check Items	61
2. Troubleshooting with LED	62
2.1 Indoor Unit.....	62
2.2 Outdoor Unit.....	62
3. Service Diagnosis	63
3.1 ARC480 Series.....	63
3.2 ARC466 Series.....	66
4. Troubleshooting	69
4.1 Error Codes and Description	69
4.2 Indoor Unit PCB Abnormality	70
4.3 Freeze-up Protection Control / Heating Peak-cut Control	71
4.4 Fan Motor (DC Motor) or Related Abnormality.....	72
4.5 Thermistor or Related Abnormality (Indoor Unit).....	75
4.6 Low-voltage Detection or Over-voltage Detection.....	76
4.7 Signal Transmission Error (Between Indoor Unit and Outdoor Unit).....	78
4.8 Unspecified Voltage (Between Indoor Unit and Outdoor Unit)	80
4.9 Outdoor Unit PCB Abnormality.....	81
4.10 OL Activation (Compressor Overload)	82
4.11 Compressor Lock	84
4.12 DC Fan Lock	85
4.13 Input Overcurrent Detection	86
4.14 Four Way Valve Abnormality.....	87
4.15 Discharge Pipe Temperature Control.....	89
4.16 High Pressure Control in Cooling	90
4.17 Compressor System Sensor Abnormality	92
4.18 Position Sensor Abnormality	93
4.19 Thermistor or Related Abnormality (Outdoor Unit).....	95
4.20 Electrical Box Temperature Rise.....	97
4.21 Radiation Fin Temperature Rise	98
4.22 Output Overcurrent Detection	99
5. Check	101
5.1 Thermistor Resistance Check	101
5.2 Indoor Fan Motor Connector Output Check	102
5.3 Power Supply Waveforms Check.....	103
5.4 Electronic Expansion Valve Check.....	103
5.5 Four Way Valve Performance Check.....	104
5.6 Inverter Unit Refrigerant System Check.....	104
5.7 Inverter Analyzer Check.....	105
5.8 Rotation Pulse Check on the Outdoor Unit PCB.....	107
5.9 Installation Condition Check.....	108
5.10 Discharge Pressure Check.....	108

5.11 Outdoor Fan System Check.....	109
5.12 Main Circuit Short Check.....	109
5.13 Power Module Check.....	111

1. General Problem Symptoms and Check Items

Symptom	Check Item	Details	Reference Page
The unit does not operate.	Check the power supply.	Check if the rated voltage is supplied.	—
	Check the type of the indoor unit.	Check if the indoor unit type is compatible with the outdoor unit.	—
	Check the outdoor temperature.	Heating operation is not available when the outdoor temperature is -25°CWB (-13°F WB) or higher, and cooling operation is not available when the outdoor temperature is below 10°CDB (50°F DB).	—
	Diagnose with remote controller indication.	—	69
	Check the remote controller addresses.	Check if address settings for the remote controller and indoor unit are correct.	119
Operation sometimes stops.	Check the power supply.	A power failure of 2 to 10 cycles stops air conditioner operation. (Operation lamp OFF)	—
	Check the outdoor temperature.	Heating operation is not available when the outdoor temperature is -25°CWB (-13°F WB) or higher, and cooling operation is not available when the outdoor temperature is below 10°CDB (50°F DB).	—
	Diagnose with remote controller indication.	—	69
The unit operates but does not cool, or does not heat.	Check for wiring and piping errors in the connection between the indoor unit and outdoor unit.	—	—
	Check for thermistor detection errors.	Check if the thermistor is mounted securely.	—
	Check for faulty operation of the electronic expansion valve.	Set the unit to cooling operation, and check the temperature of the liquid pipe to see if the electronic expansion valve works.	—
	Diagnose with remote controller indication.	—	69
	Diagnose by service port pressure and operating current.	Check for refrigerant shortage.	—
Large operating noise and vibrations	Check the output voltage of the power module.	—	111
	Check the power module.	—	—
	Check the installation condition.	Check if the required spaces for installation (specified in the installation manual) are provided.	—

2. Troubleshooting with LED

2.1 Indoor Unit

Operation Lamp

The operation lamp blinks when any of the following errors is detected.

1. When a protection device of the indoor or outdoor unit is activated, or when the thermistor malfunctions.
 2. When a signal transmission error occurs between the indoor and outdoor units.
- In either case, conduct the diagnostic procedure described in the following pages.

FTX Series

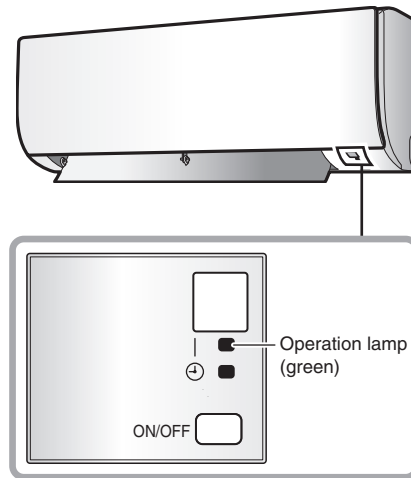

(R21056)

FVXS Series

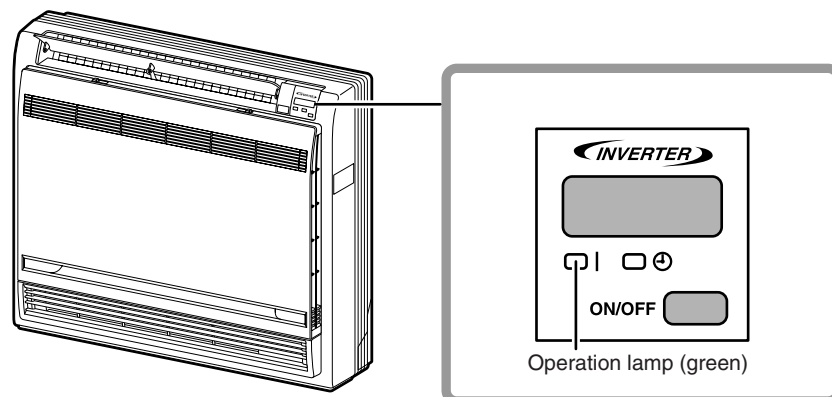

(R21930)

2.2 Outdoor Unit

The outdoor unit has one green LED (LED A) on the PCB. When the microcomputer works in order, the LED A blinks. However, the LED A turns OFF while the standby electricity saving function is activated and the power supply is OFF. (Refer to page 16, 17, 18 for the location of LED A.)

3. Service Diagnosis

3.1 ARC480 Series

Method 1

1. When **TIMER CANCEL** button is held down for 5 seconds, **00** is displayed on the temperature display screen.



<ARC480 Series>

(R21665)

2. Press **TIMER CANCEL** button repeatedly until a long beep sounds.
 - The code indication changes in the sequence shown below.

No.	Code	No.	Code	No.	Code
1	00	16	R3	31	UF
2	R5	17	KB	32	UH
3	E7	18	KS	33	PY
4	F3	19	CS	34	KT
5	F6	20	CC	35	U2
6	L3	21	CY	36	ER
7	L4	22	CS	37	RR
8	L5	23	J3	38	FR
9	U4	24	JB	39	EB
10	E6	25	JB	40	CH
11	KE	26	ES	41	JS
12	KD	27	R1	42	E3
13	RE	28	E1	43	K3
14	UD	29	UR		
15	C7	30	U3		



Note:

1. A short beep and two consecutive beeps indicate non-corresponding codes.
2. To return to the normal mode, hold **TIMER CANCEL** button down for 5 seconds. When the remote controller is left untouched for 60 seconds, it also returns to the normal mode.
3. Not all the error codes are displayed. When you cannot find the error code, try method 2. (→ Refer to page 64.)

Method 2

1. Press the center of **TEMP** button and **OFF** button at the same time.

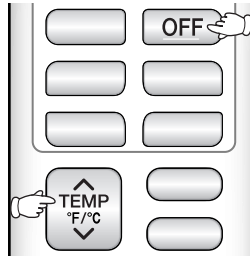

(R21666)

5ℓ is displayed on the LCD.

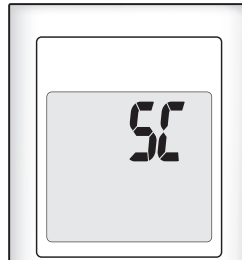

(R21059)

2. Select 5ℓ (service check) with **TEMP** ^ or **TEMP** v button.
3. Press **FAN** button to enter the service check mode.

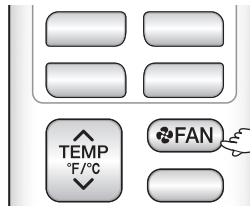

(R21667)

00 is displayed and the left-side number blinks.

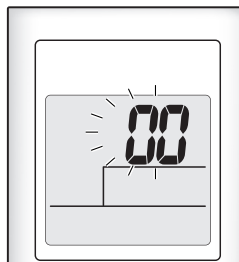

(R21061)

4. Press **TEMP** ^ or **TEMP** v button and change the number until you hear the two consecutive beeps or the long beep.

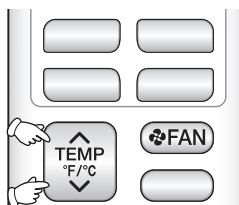

(R21668)

5. Diagnose by the sound.
 - ★ beep: The left-side number does not correspond with the error code.
 - ★ two consecutive beeps: The left-side number corresponds with the error code but the right-side number does not.
 - ★ long beep: Both the left-side and right-side numbers correspond with the error code.
(The numbers indicated when you hear the long beep are the error code.
→ Refer to page 69.)

6. Press **FAN** button.

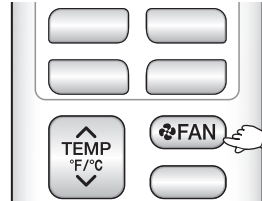

(R21667)

The right-side number blinks.

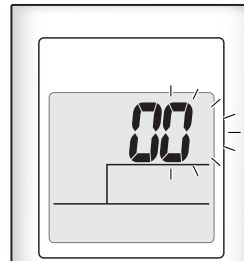

(R21063)

7. Press **TEMP** \wedge or **TEMP** \vee button and change the number until you hear the long beep.

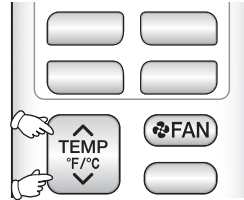

(R21668)

8. Diagnose by the sound.
 - ★ beep: The left-side number does not correspond with the error code.
 - ★ two consecutive beeps: The left-side number corresponds with the error code but the right-side number does not.
 - ★ long beep: Both the left-side and right-side numbers correspond with the error code.
9. Determine the error code.
The numbers indicated when you hear the long beep are the error code.
Error codes and description → Refer to page 69.

10. Press **FAN** button for 5 seconds to exit from the service check mode.
(When the remote controller is left untouched for 60 seconds, it returns to the normal mode also.)

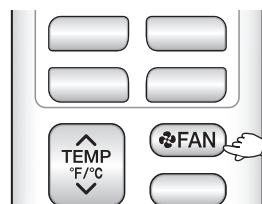

(R21667)

3.2 ARC466 Series

Method 1

1. When **Timer Cancel** button is held down for 5 seconds, **00** is displayed on the temperature display screen.

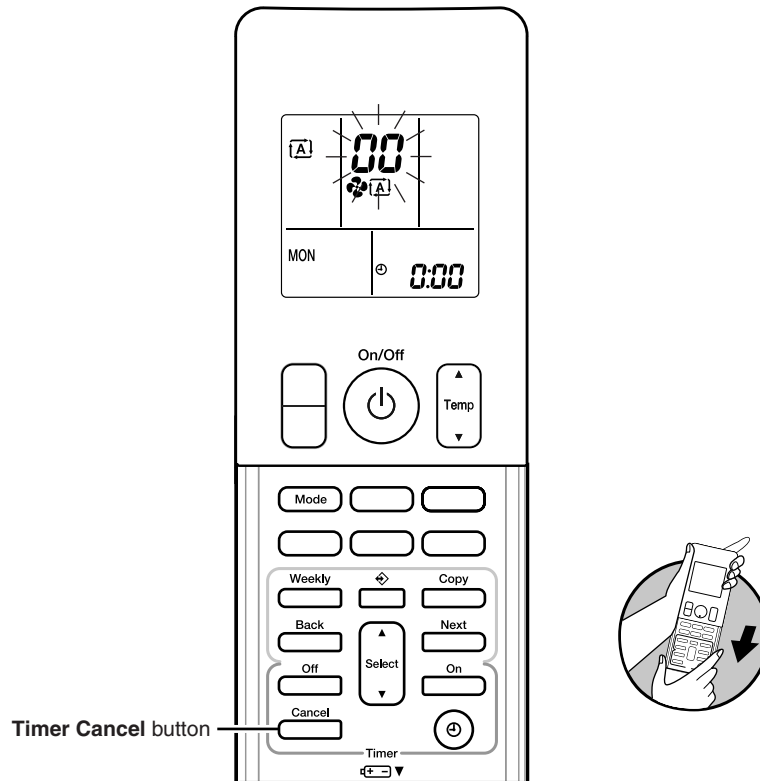

< ARC466 Series >

(R23004)

2. Press **Timer Cancel** button repeatedly until a long beep sounds.
 - The code indication changes in the sequence shown below.

No.	Code	No.	Code	No.	Code
1	00	14	U0	27	UR
2	R5	15	E7	28	UH
3	E7	16	R3	29	P4
4	F3	17	H8	30	H7
5	F6	18	H9	31	U2
6	L3	19	E9	32	ER
7	L4	20	E4	33	RR
8	L5	21	E5	34	FR
9	U4	22	J3	35	H1
10	E6	23	U6	36	P9
11	H6	24	E5	37	E3
12	H0	25	R1	38	H3
13	R6	26	E1		



Note:

1. A short beep or two consecutive beeps indicate non-corresponding codes.
2. To return to the normal mode, hold **Timer Cancel** button down for 5 seconds. When the remote controller is left untouched for 60 seconds, it also returns to the normal mode.
3. Not all the error codes are displayed. When you cannot find the error code, try method 2. (→ Refer to page 67.)

Method 2

1. Press the center of **Temp** button and **Mode** button at the same time.

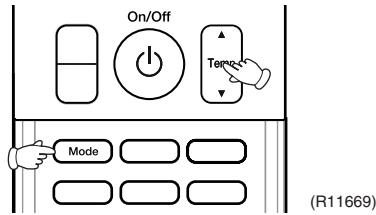

5C is displayed on the LCD.

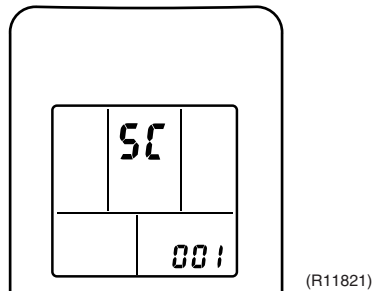

2. Select 5C (service check) with **Temp ▲** or **Temp ▼** button.
3. Press **Mode** button to enter the service check mode.

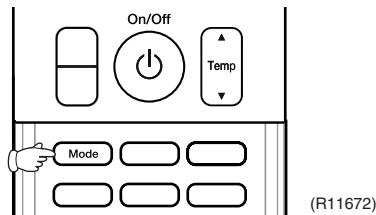

The left-side number blinks.

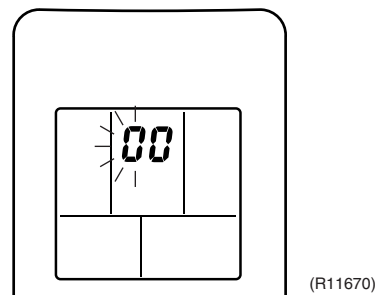

4. Press **Temp ▲** or **Temp ▼** button and change the number until you hear the two consecutive beeps or the long beep.

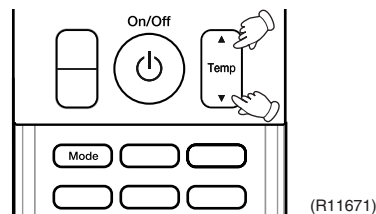

5. Diagnose by the sound.
 - ★ beep: The left-side number does not correspond with the error code.
 - ★ two consecutive beeps: The left-side number corresponds with the error code but the right-side number does not.
 - ★ long beep: Both the left-side and right-side numbers correspond with the error code.
The numbers indicated when you hear the long beep are the error code.
Refer to page 69.

6. Press **Mode** button.

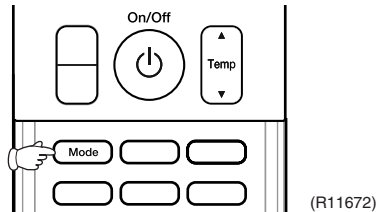

The right-side number blinks.

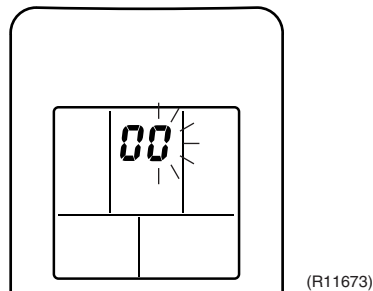

7. Press **Temp ▲** or **Temp ▼** button and change the number until you hear the long beep.

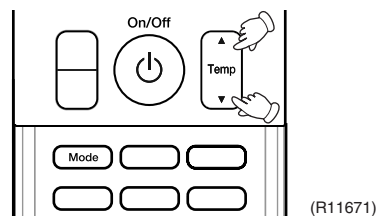

8. Diagnose by the sound.
 - ★ beep: The left-side number does not correspond with the error code.
 - ★ two consecutive beeps: The left-side number corresponds with the error code but the right-side number does not.
 - ★ long beep: Both the left-side and right-side numbers correspond with the error code.

9. Determine the error code.
The numbers indicated when you hear the long beep are the error code.
Refer to page 69.

10. Press **Mode** button for 5 seconds to exit from the service check mode.
(When the remote controller is left untouched for 60 seconds, it returns to the normal mode also.)

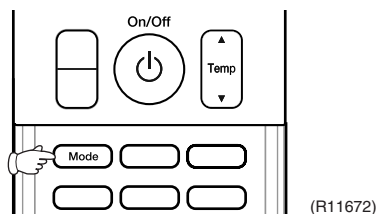

4. Troubleshooting

4.1 Error Codes and Description

	Error Codes	Description	Reference Page
System	00	Normal	—
	U2	Low-voltage detection or over-voltage detection	76
	U4	Signal transmission error (between indoor unit and outdoor unit)	78
	UR	Unspecified voltage (between indoor unit and outdoor unit)	80
Indoor Unit	R1	Indoor unit PCB abnormality	70
	RS	Freeze-up protection control / heating peak-cut control	71
	RE	Fan motor (DC motor) or related abnormality	72
	C4	Indoor heat exchanger thermistor or related abnormality	75
	C9	Room temperature thermistor or related abnormality	75
Outdoor Unit	E1	Outdoor unit PCB abnormality	81
	E5★	OL activation (compressor overload)	82
	E6★	Compressor lock	84
	E7★	DC fan lock	85
	E8	Input overcurrent detection	86
	E9	Four way valve abnormality	87
	F3	Discharge pipe temperature control	89
	F6	High pressure control in cooling	90
	H0	Compressor system sensor abnormality	92
	H6	Position sensor abnormality	93
	H9	Outdoor temperature thermistor or related abnormality	95
	J3★	Discharge pipe thermistor or related abnormality	95
	J6	Outdoor heat exchanger thermistor or related abnormality	95
	L3	Electrical box temperature rise	97
	L4	Radiation fin temperature rise	98
	L5★	Output overcurrent detection	99
	P4	Radiation fin thermistor or related abnormality	95

★: Displayed only when system-down occurs.

4.2 Indoor Unit PCB Abnormality

Error Code	A1
Method of Error Detection	The system checks if the circuit works properly within the microcomputer of the indoor unit.
Error Decision Conditions	The system cannot set the internal settings.
Supposed Causes	<ul style="list-style-type: none"> ■ Wrong models interconnected ■ Defective indoor unit PCB ■ Disconnection of connector ■ Reduction of power supply voltage

Troubleshooting

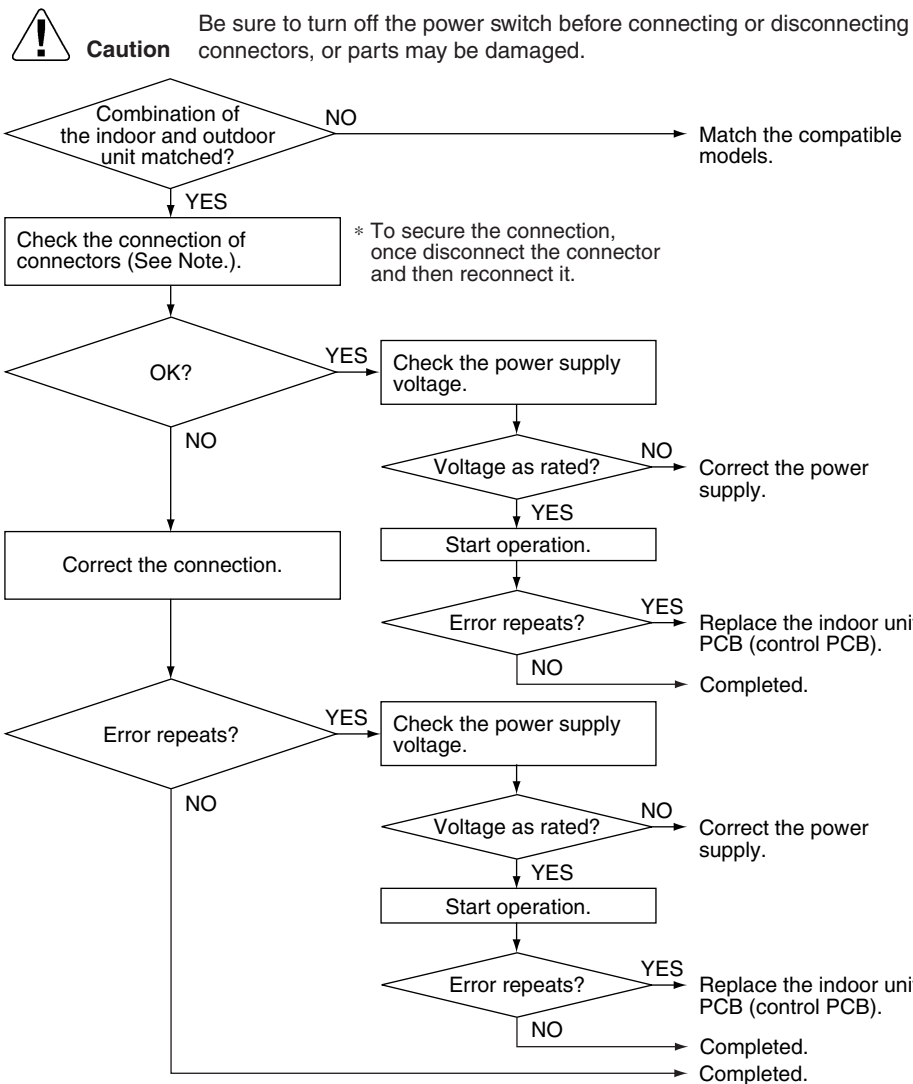

Note: Check the following connector.

(R20486)

Model Type	Connector
09/12 class	Terminal board ~ Control PCB (H1, H2, H3)
15 class	Terminal board ~ Filter PCB (S100)

4.3 Freeze-up Protection Control / Heating Peak-cut Control

Error Code	A5
Method of Error Detection	<ul style="list-style-type: none"> ■ Freeze-up protection control During cooling operation, the freeze-up protection control (operation halt) is activated according to the temperature detected by the indoor heat exchanger thermistor. ■ Heating peak-cut control During heating operation, the temperature detected by the indoor heat exchanger thermistor is used for the heating peak-cut control (operation halt, outdoor fan stop, etc.)
Error Decision Conditions	<ul style="list-style-type: none"> ■ Freeze-up protection control During cooling operation, the indoor heat exchanger temperature is below 0°C (32°F). ■ Heating peak-cut control During heating operation, the indoor heat exchanger temperature is above about 60°C (140°F) (depending on the model).
Supposed Causes	<ul style="list-style-type: none"> ■ Short-circuited air ■ Clogged air filter of the indoor unit ■ Dust accumulation on the indoor heat exchanger ■ Defective indoor heat exchanger thermistor ■ Defective indoor unit PCB

Troubleshooting



Check No.01
Refer to P.101



Caution

Be sure to turn off the power switch before connecting or disconnecting connectors, or parts may be damaged.

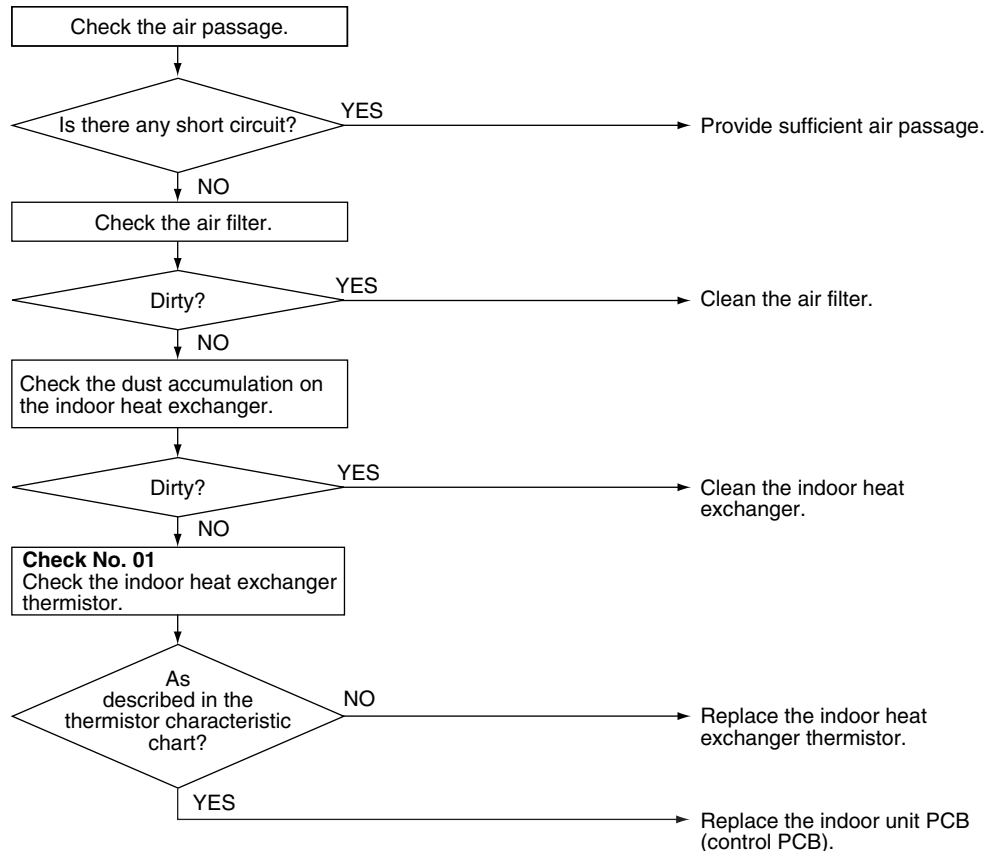

(R21064)

4.4 Fan Motor (DC Motor) or Related Abnormality

Error Code	R6
Method of Error Detection	The rotation speed detected by the Hall IC during fan motor operation is used to determine abnormal fan motor operation.
Error Decision Conditions	The detected rotation speed does not reach the demanded rotation speed of the target tap, and is less than 50% of the maximum fan motor rotation speed.
Supposed Causes	<ul style="list-style-type: none">■ Remarkable decrease in power supply voltage■ Layer short inside the fan motor winding■ Breaking of wire inside the fan motor■ Breaking of the fan motor lead wires■ Defective capacitor of the fan motor■ Defective indoor unit PCB

Troubleshooting



Check No.03
Refer to P.102

FTX Series



Caution

Be sure to turn off the power switch before connecting or disconnecting connectors, or parts may be damaged.

Turn off the power supply.
(Unplug the power cable or turn the breaker off.)

Note: The motor may break when the motor connector is disconnected with the power supply on.
(Turn off the power supply before connecting the connector also.)

Check the connector for connection.

* To secure the connection, once disconnect the connector and then reconnect it.

OK?

NO → Correct the connection.

Foreign matters in or around the fan?

YES → Remove the foreign matters.

Rotate the fan by hand.

Fan rotates smoothly?

Abnormal sound occurs?

Check No. 03
Check the fan motor for breakdown or short circuit.

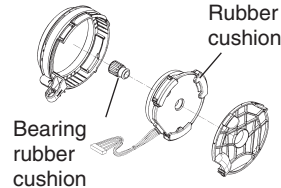

Is the rubber cushion properly fitted?

NO → Correct the position of rubber cushion or replace the rubber cushion.
YES → Replace the bearing rubber cushion.

Resistance OK?

NO → Replace the indoor fan motor.

Turn the power on again.

Check No. 03
Check the motor control voltage.

Is the motor control voltage 15 VDC generated?

NO → Replace the indoor unit PCB (control PCB).

Check No. 03
Check the indoor unit PCB for rotation pulse.

Is the rotation pulse generated?

NO → Replace the indoor fan motor.

YES → Replace the indoor unit PCB (control PCB). (R20165)

Troubleshooting



Check No.02
Refer to P.102

FVXS Series



Caution

Be sure to turn off the power switch before connecting or disconnecting connectors, or parts may be damaged.

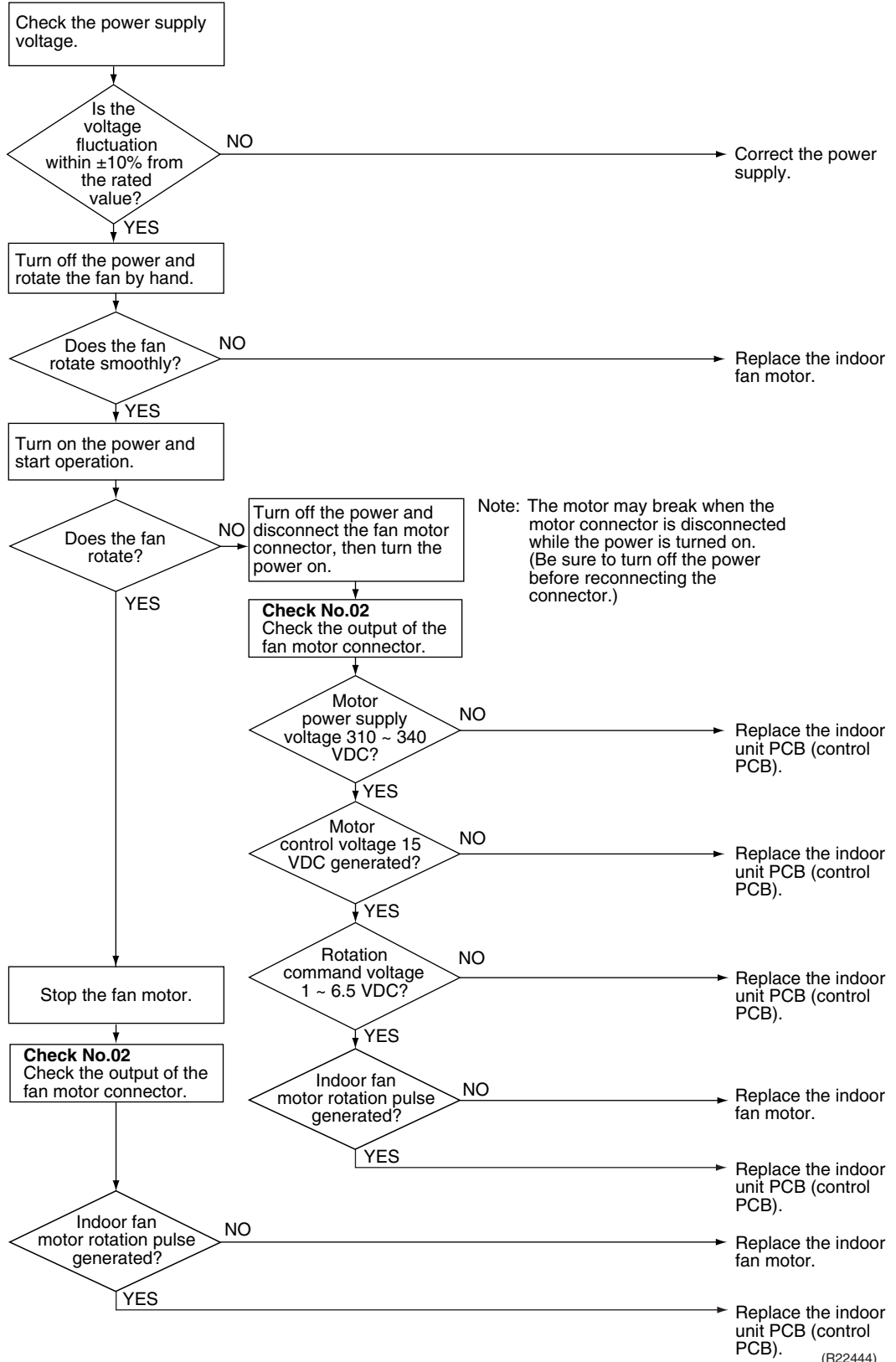

Note: The rotation pulse is the feedback signal from the indoor fan motor.

4.5 Thermistor or Related Abnormality (Indoor Unit)

Error Code	Ⓛ4, Ⓛ9
Method of Error Detection	The temperatures detected by the thermistors determine thermistor errors.
Error Decision Conditions	The voltage between the both ends of the thermistor is 4.96 V and more or 0.04 V and less during compressor operation.
Supposed Causes	<ul style="list-style-type: none"> ■ Disconnection of connector ■ Thermistor corresponding to the error code is defective. ■ Defective indoor unit PCB

Troubleshooting

 **Check No.01**
Refer to P.101

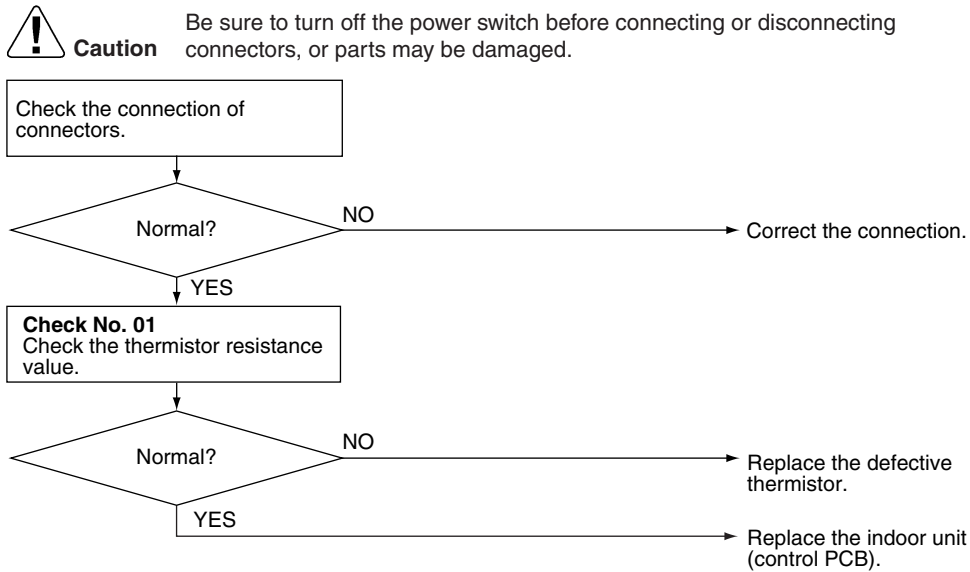

(R21870)

Ⓛ4 : Indoor heat exchanger thermistor
Ⓛ9 : Room temperature thermistor

4.6 Low-voltage Detection or Over-voltage Detection

Error Code	U2
Method of Error Detection	<p>Low-voltage detection: An abnormal voltage drop is detected by the DC voltage detection circuit.</p> <p>Over-voltage detection: An abnormal voltage rise is detected by the over-voltage detection circuit.</p>
Error Decision Conditions	<p>Low-voltage detection:</p> <ul style="list-style-type: none"> ■ The voltage detected by the DC voltage detection circuit is below 180 ~ 196 V (depending on the model). ■ The compressor stops if the error occurs, and restarts automatically after 3-minute standby. <p>Over-voltage detection:</p> <ul style="list-style-type: none"> ■ An over-voltage signal is fed from the over-voltage detection circuit to the microcomputer (over 458 ~ 500 V, depending on the model). ■ The compressor stops if the error occurs, and restarts automatically after 3-minute standby.
Supposed Causes	<ul style="list-style-type: none"> ■ Power supply voltage is not as specified. ■ Defective DC voltage detection circuit ■ Defective over-voltage detection circuit ■ Defective PAM control part ■ Disconnection of compressor harness ■ Short circuit inside the fan motor winding ■ Noise ■ Momentary drop of voltage ■ Momentary power failure ■ Defective outdoor unit PCB

Troubleshooting



Caution Be sure to turn off the power switch before connecting or disconnecting connectors, or parts may be damaged.

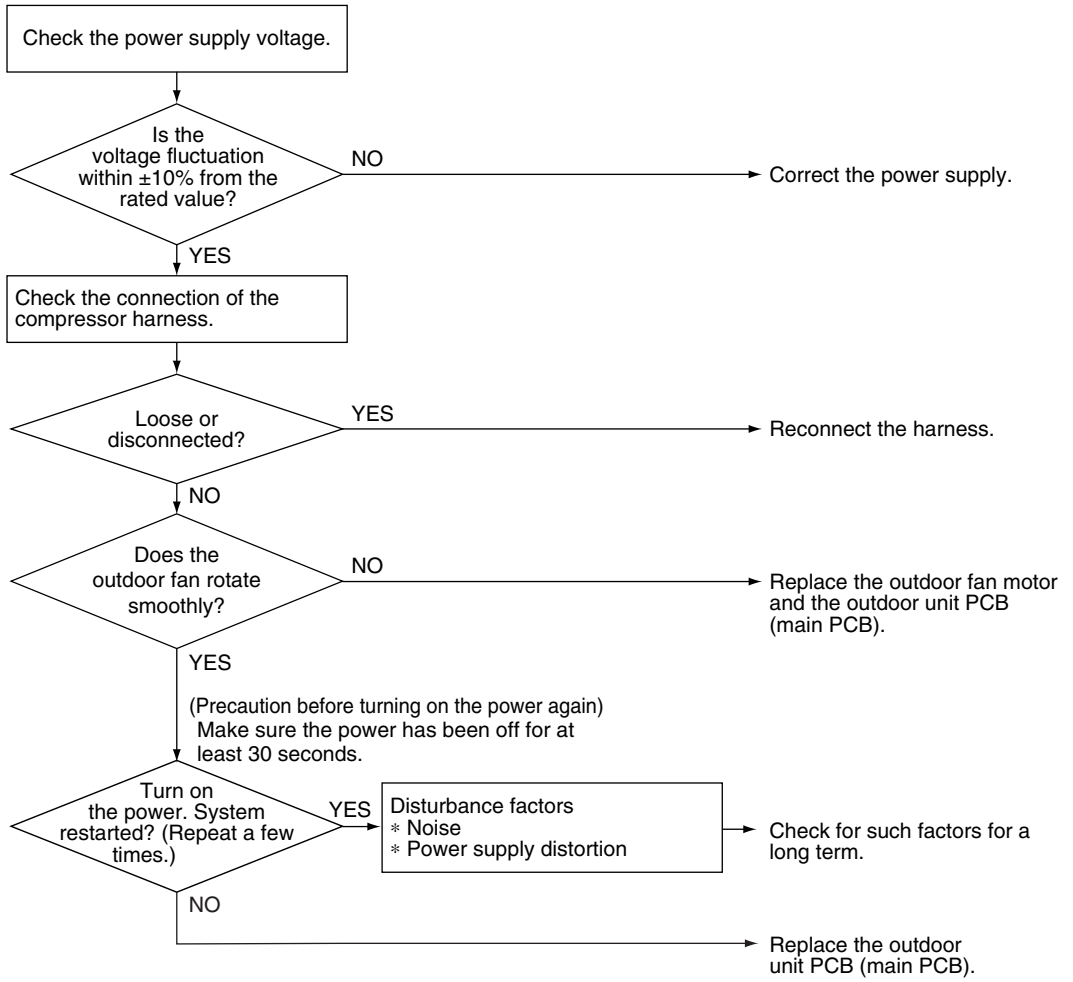

(R22445)

4.7 Signal Transmission Error (Between Indoor Unit and Outdoor Unit)

Error Code	U4
Method of Error Detection	The data received from the outdoor unit in signal transmission is checked whether it is normal.
Error Decision Conditions	The data sent from the outdoor unit cannot be received normally, or the content of the data is abnormal.
Supposed Causes	<ul style="list-style-type: none">■ Power supply voltage is not as specified.■ Reduction of power supply voltage■ Wiring error■ Breaking of the connecting wires between the indoor and outdoor units (wire No. 3)■ Defective outdoor unit PCB■ Short circuit inside the fan motor winding■ Defective indoor unit PCB■ Disturbed power supply waveform

Troubleshooting



Check No.11
Refer to P.103



Caution

Be sure to turn off the power switch before connecting or disconnecting connectors, or parts may be damaged.

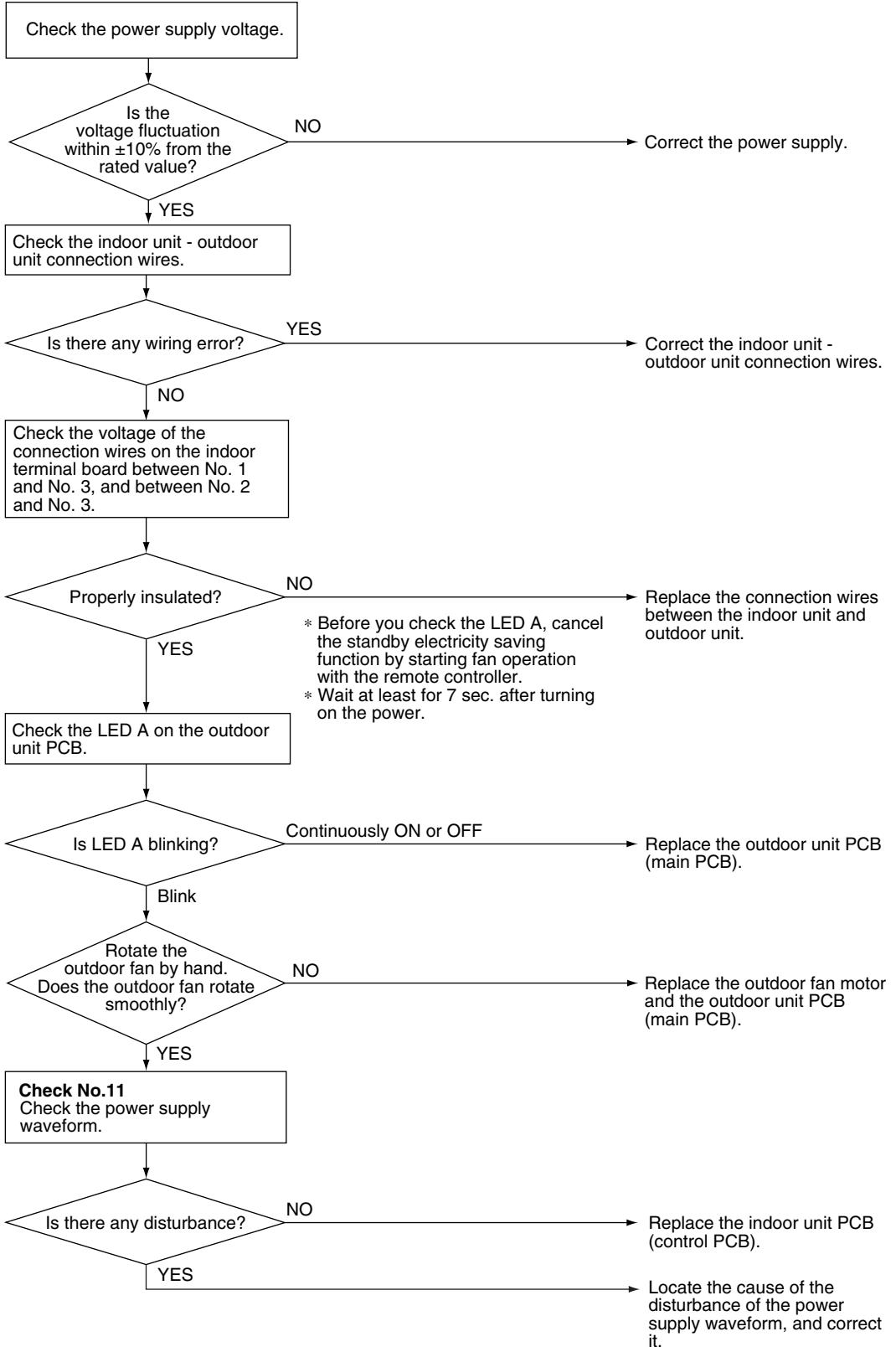

(R21189)

4.8 Unspecified Voltage (Between Indoor Unit and Outdoor Unit)

Error Code	UR
Method of Error Detection	The supply power is detected for its requirements (pair type is different from multi type) by the indoor / outdoor transmission signal.
Error Decision Conditions	The pair type and multi type are interconnected.
Supposed Causes	<ul style="list-style-type: none"> ■ Wrong models interconnected ■ Wrong wiring of connecting wires ■ Wrong indoor unit PCB or outdoor unit PCB mounted ■ Defective indoor unit PCB ■ Defective outdoor unit PCB

Troubleshooting

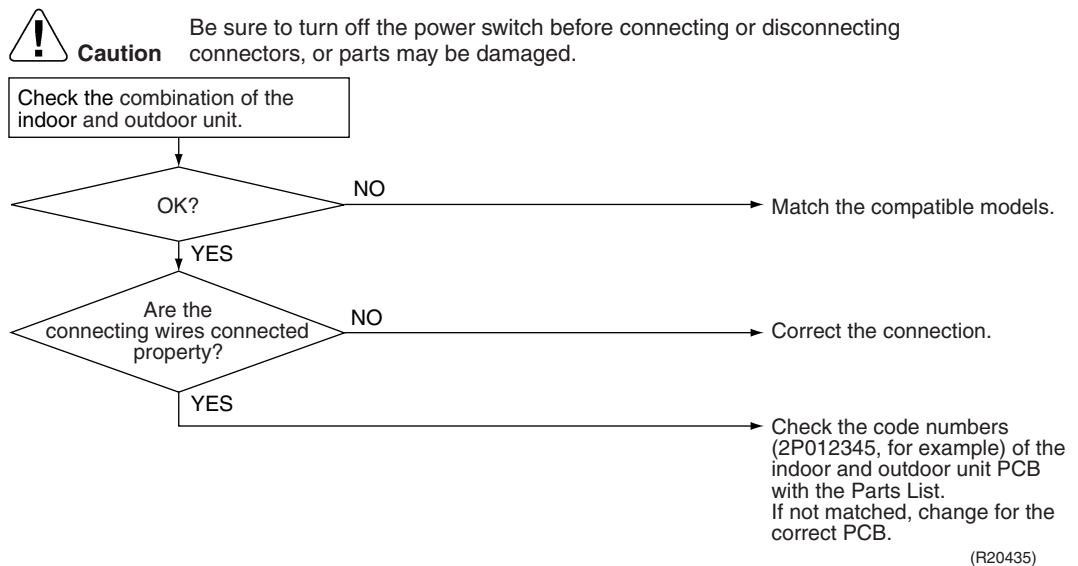

4.9 Outdoor Unit PCB Abnormality

Error Code	E1
Method of Error Detection	<ul style="list-style-type: none"> ■ The system checks if the microprocessor is working in order. ■ The system checks if the zero-cross signal comes in properly.
Error Decision Conditions	<ul style="list-style-type: none"> ■ The microprocessor program runs out of control. ■ The zero-cross signal is not detected.
Supposed Causes	<ul style="list-style-type: none"> ■ Defective outdoor unit PCB ■ Noise ■ Momentary drop of voltage ■ Momentary power failure

Troubleshooting

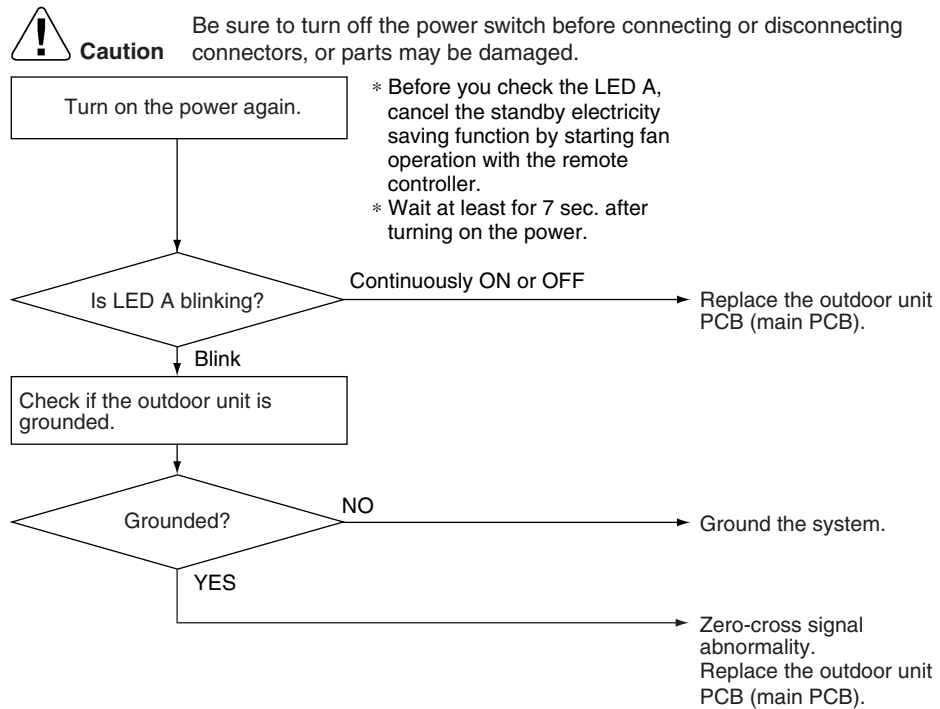

(R21201)

4.10 OL Activation (Compressor Overload)

Error Code	E5
Method of Error Detection	A compressor overload is detected through compressor OL.
Error Decision Conditions	<ul style="list-style-type: none"> ■ If the error repeats, the system is shut down. ■ Reset condition: Continuous run for about 60 minutes without any other error
Supposed Causes	<ul style="list-style-type: none"> ■ Disconnection of discharge pipe thermistor ■ Defective discharge pipe thermistor ■ Disconnection of connector S40 ■ Disconnection of 2 terminals of OL (Q1L) ■ Defective OL (Q1L) ■ Broken OL harness ■ Defective electronic expansion valve or coil ■ Defective four way valve or coil ■ Defective outdoor unit PCB ■ Refrigerant shortage ■ Water mixed in refrigerant ■ Defective stop valve

Troubleshooting



Check No.01
Refer to P.101



Check No.12
Refer to P.103



Check No.13
Refer to P.104



Check No.14
Refer to P.104



Caution Be sure to turn off the power switch before connecting or disconnecting connectors, or parts may be damaged.

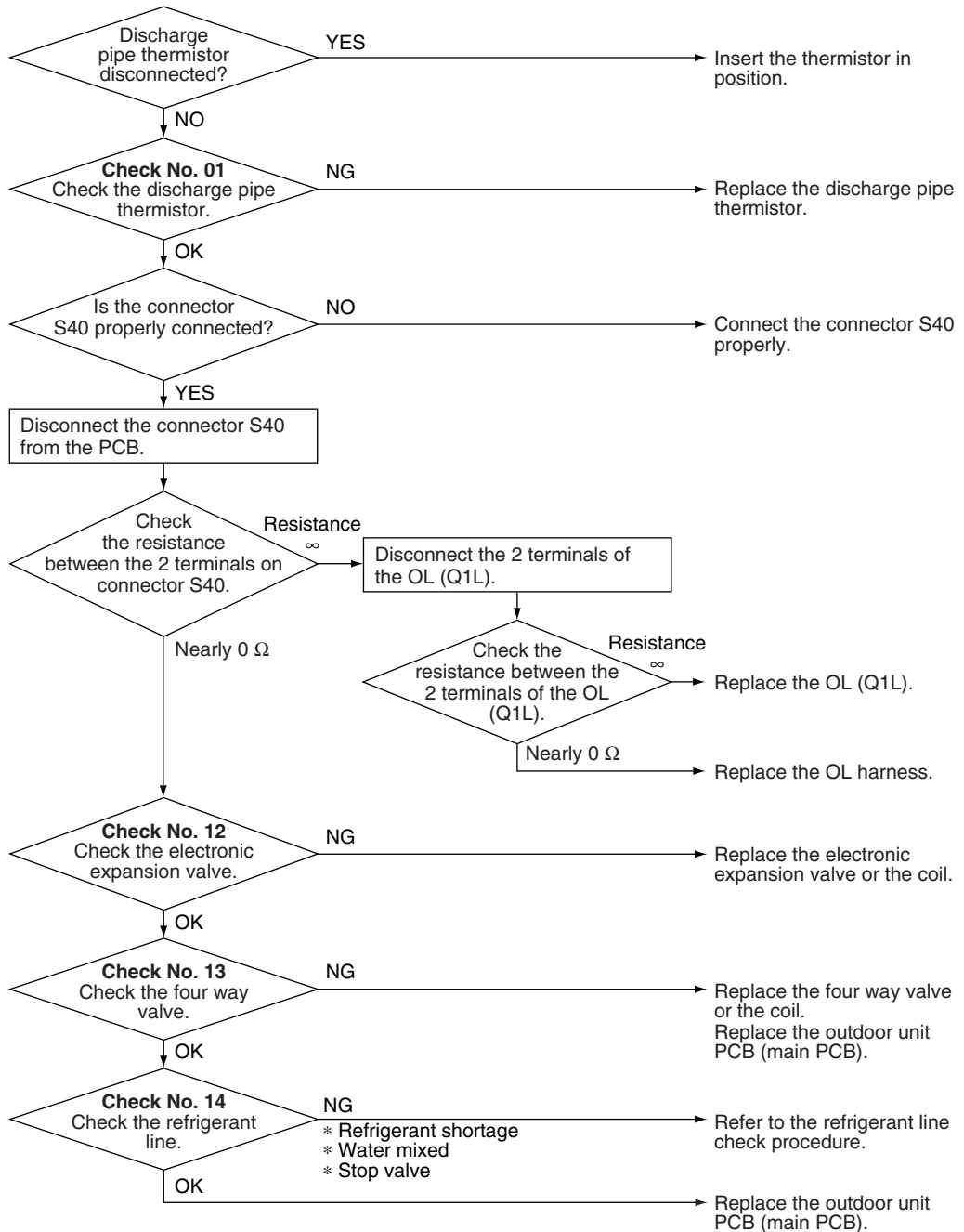

(R22997)



Note: OL (Q1L) activating temperature: 120 ~ 130°C (248 ~ 266°F)
OL (Q1L) recovery temperature: 95°C (203°F)

4.11 Compressor Lock

Error Code	E6
Method of Error Detection	A compressor lock is detected by the current waveform generated when applying high-frequency voltage to the motor.
Error Decision Conditions	<ul style="list-style-type: none"> ■ If the error repeats, the system is shut down. ■ Reset condition: Continuous run for about 11 minutes without any other error
Supposed Causes	<ul style="list-style-type: none"> ■ Closed stop valve ■ Compressor locked ■ Disconnection of compressor harness

Troubleshooting



Check No.12
Refer to P.103



Check No.15
Refer to P.105



Caution

Be sure to turn off the power switch before connecting or disconnecting connectors, or parts may be damaged.
(Precaution before turning on the power again)
Make sure the power has been off for at least 30 seconds.

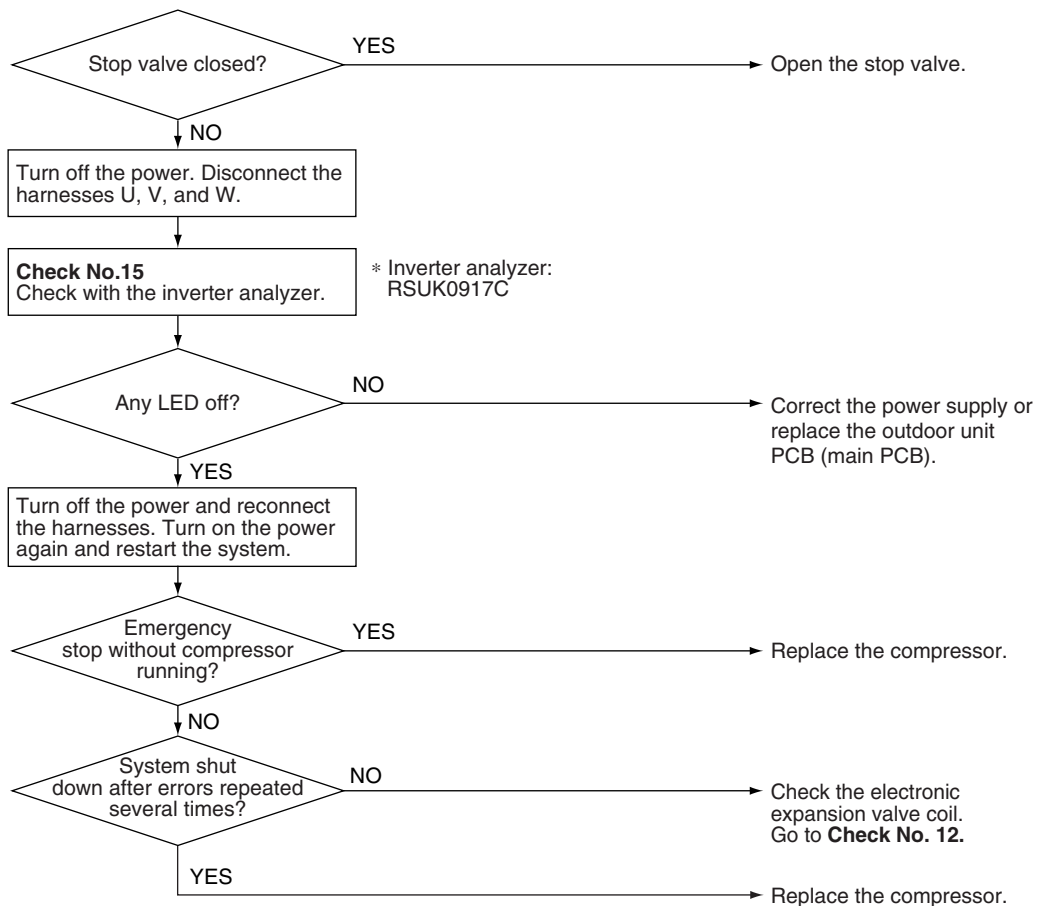

(R21067)

4.12 DC Fan Lock

Error Code	E7
Method of Error Detection	An error is determined with the high-voltage fan motor rotation speed detected by the Hall IC.
Error Decision Conditions	<ul style="list-style-type: none"> ■ The fan does not start in 15 ~ 30 seconds even when the fan motor is running. ■ If the error repeats, the system is shut down. ■ Reset condition: Continuous run for about 11 minutes without any other error
Supposed Causes	<ul style="list-style-type: none"> ■ Disconnection of the fan motor ■ Foreign matter stuck in the fan ■ Defective fan motor ■ Defective outdoor unit PCB

Troubleshooting

Check No.16
Refer to P.107

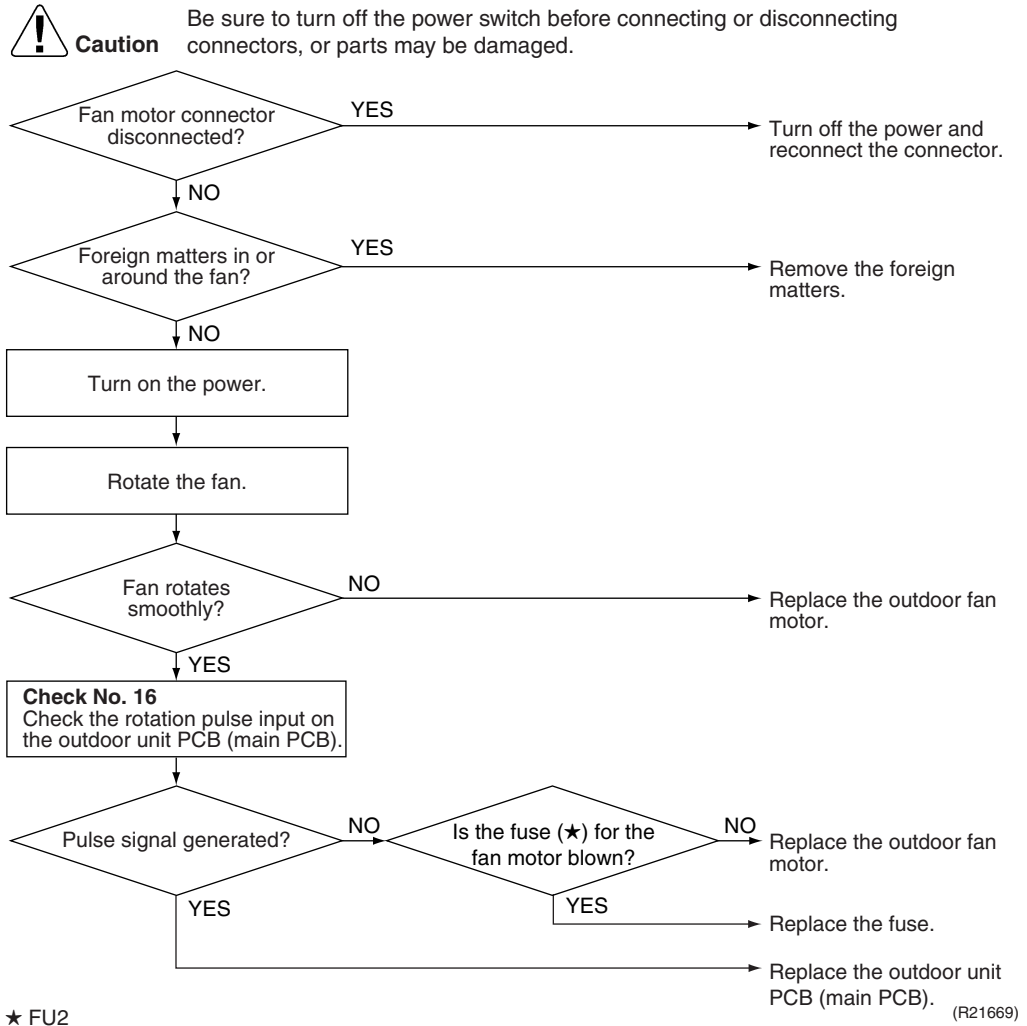

4.13 Input Overcurrent Detection

Error Code

E8

Method of Error Detection

An input overcurrent is detected by checking the input current value with the compressor running.

Error Decision Conditions

The current exceeds about 12.0 ~ 18.0 A (depending on the model and operation mode) for 2.5 seconds with the compressor running.
(The upper limit of the current decreases when the outdoor temperature exceeds a certain level.)

Supposed Causes

- Outdoor temperature is out of operation range.
- Defective compressor
- Defective power module
- Defective outdoor unit PCB
- Short circuit

Troubleshooting



Check No.15
Refer to P.105



Check No.17
Refer to P.108



Check No.18
Refer to P.108



Caution Be sure to turn off the power switch before connecting or disconnecting connectors, or parts may be damaged.

* An input overcurrent may result from wrong internal wiring. If the system is interrupted by an input overcurrent after the wires have been disconnected and reconnected for part replacement, check the wiring again.

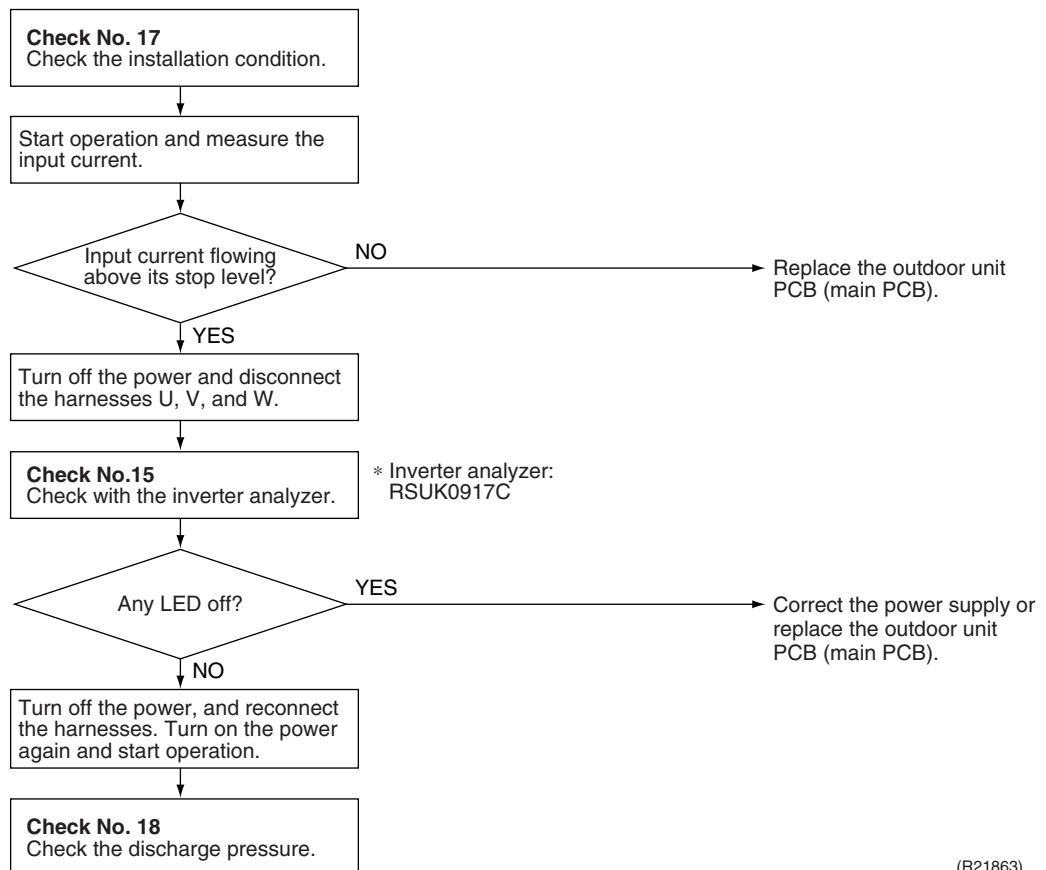

(R21863)

4.14 Four Way Valve Abnormality

Error Code	E8																	
Method of Error Detection	The room temperature thermistor and the indoor heat exchanger thermistor are checked if they function within their normal ranges in each operation mode.																	
Error Decision Conditions	<p>A following condition continues over 10 minutes after operating for 5 minutes.</p> <ul style="list-style-type: none"> ■ Cooling / Dry $A - B < -5^{\circ}\text{C}$ ($A - B < -9^{\circ}\text{F}$) ■ Heating $B - A < -5^{\circ}\text{C}$ ($B - A < -9^{\circ}\text{F}$) <p style="margin-left: 40px;"> A: Room thermistor temperature B: Indoor heat exchanger temperature </p> <table border="1" style="margin-left: 40px;"> <thead> <tr> <th rowspan="3"></th> <th colspan="2">C (seconds)</th> </tr> <tr> <th colspan="2">Outdoor temperature</th> </tr> <tr> <th>-15°C(5°F) or higher</th> <th>Lower than -15°C(5°F)</th> </tr> </thead> <tbody> <tr> <td>09 class</td> <td>600 ★</td> <td>600 ★</td> </tr> <tr> <td>12 class</td> <td>600 ★</td> <td>300</td> </tr> <tr> <td>15 class</td> <td>600 ★</td> <td>1400</td> </tr> </tbody> </table> <p>★: The same value continues.</p> <ul style="list-style-type: none"> ■ If the error repeats, the system is shut down. ■ Reset condition: Continuous run for about 60 minutes without any other error 			C (seconds)		Outdoor temperature		-15°C(5°F) or higher	Lower than -15°C(5°F)	09 class	600 ★	600 ★	12 class	600 ★	300	15 class	600 ★	1400
	C (seconds)																	
	Outdoor temperature																	
	-15°C(5°F) or higher	Lower than -15°C(5°F)																
09 class	600 ★	600 ★																
12 class	600 ★	300																
15 class	600 ★	1400																
Supposed Causes	<ul style="list-style-type: none"> ■ Disconnection of four way valve coil ■ Defective four way valve, coil, or harness ■ Defective outdoor unit PCB ■ Defective thermistor ■ Refrigerant shortage ■ Water mixed in refrigerant ■ Defective stop valve 																	

Troubleshooting



Check No.01
Refer to P.101



Check No.13
Refer to P.104



Check No.14
Refer to P.104



Caution Be sure to turn off the power switch before connecting or disconnecting connectors, or parts may be damaged.

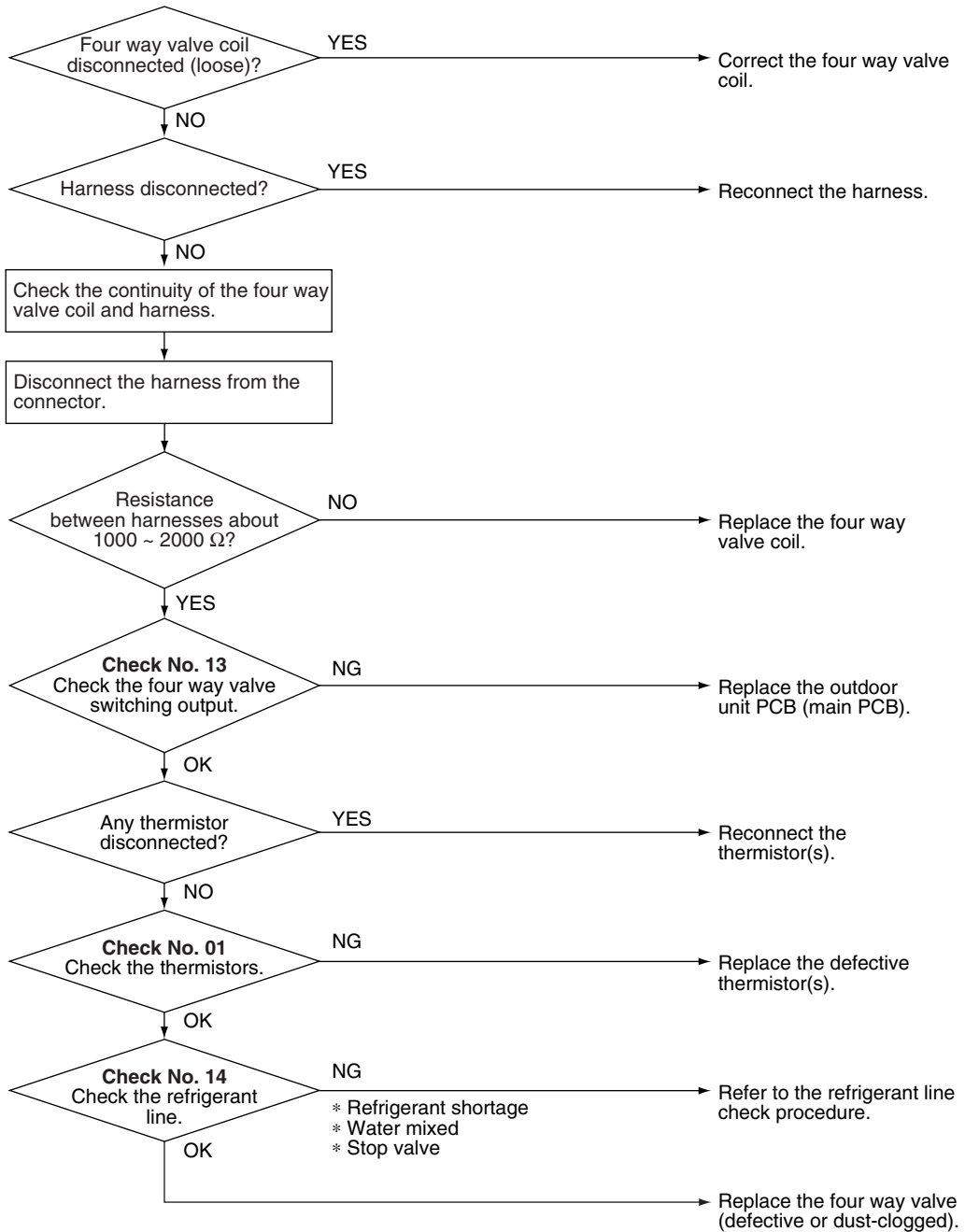

(R20405)

4.15 Discharge Pipe Temperature Control

Error Code F3

Method of Error Detection An error is determined with the temperature detected by the discharge pipe thermistor.

Error Decision Conditions

- If the temperature detected by the discharge pipe thermistor rises above **A**, the compressor stops.
- The error is cleared when the discharge pipe temperature has dropped below **B**.

09 class

A		B	
°C	°F	°C	°F
110	230	88	190.4

★ If the frequency drops, the temperature is lowered in compensation.

12/15 class



A		B	
°C	°F	°C	°F
110	230	95	203

- If the error repeats, the system is shut down.
- Reset condition: Continuous run for about 60 minutes without any other error

Supposed Causes

- Defective discharge pipe thermistor (Defective outdoor heat exchanger thermistor or outdoor temperature thermistor)
- Defective electronic expansion valve or coil
- Refrigerant shortage
- Defective four way valve
- Water mixed in refrigerant
- Defective stop valve
- Defective outdoor unit PCB

Troubleshooting

-  **Check No.01**
Refer to P.101
-  **Check No.12**
Refer to P.103
-  **Check No.14**
Refer to P.104

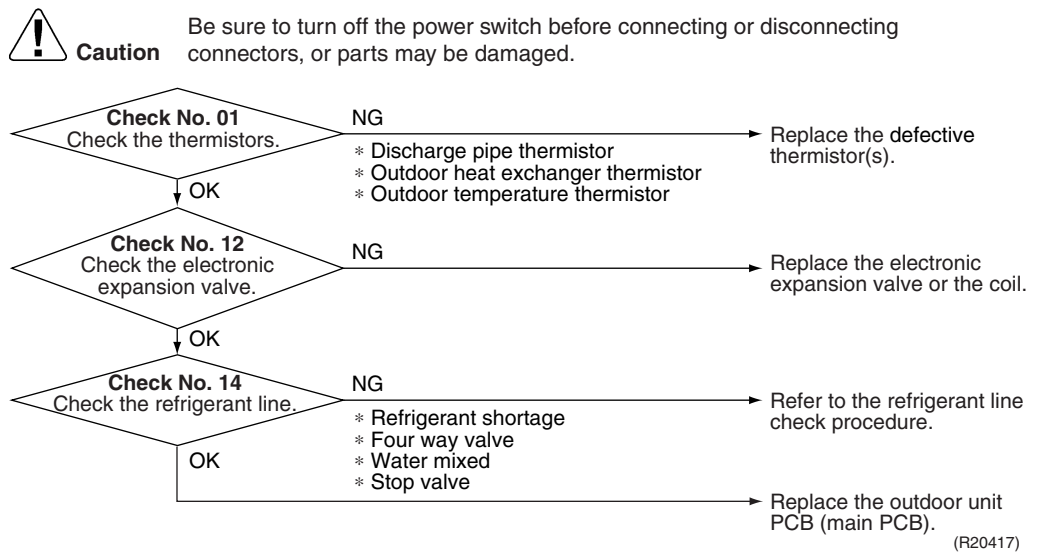

(R20417)

4.16 High Pressure Control in Cooling

Error Code	F6
Method of Error Detection	High-pressure control (operation halt, frequency drop, etc.) is activated in cooling operation if the temperature sensed by the outdoor heat exchanger thermistor exceeds the limit.
Error Decision Conditions	<ul style="list-style-type: none">■ The temperature sensed by the outdoor heat exchanger thermistor rise above 59 ~ 61°C (138.2 ~ 141.8°F) (depending on the model).■ The error is cleared when the temperature drops below 51 ~ 52°C (123.8 ~ 125.6°F) (depending on the model).
Supposed Causes	<ul style="list-style-type: none">■ The installation space is not large enough.■ Dirty outdoor heat exchanger■ Defective outdoor fan motor■ Defective stop valve■ Defective electronic expansion valve or coil■ Defective outdoor heat exchanger thermistor■ Defective outdoor unit PCB

Troubleshooting



Check No.01
Refer to P.101



Check No.12
Refer to P.103



Check No.17
Refer to P.108



Check No.18
Refer to P.108



Check No.19
Refer to P.109



Caution

Be sure to turn off the power switch before connecting or disconnecting connectors, or parts may be damaged.

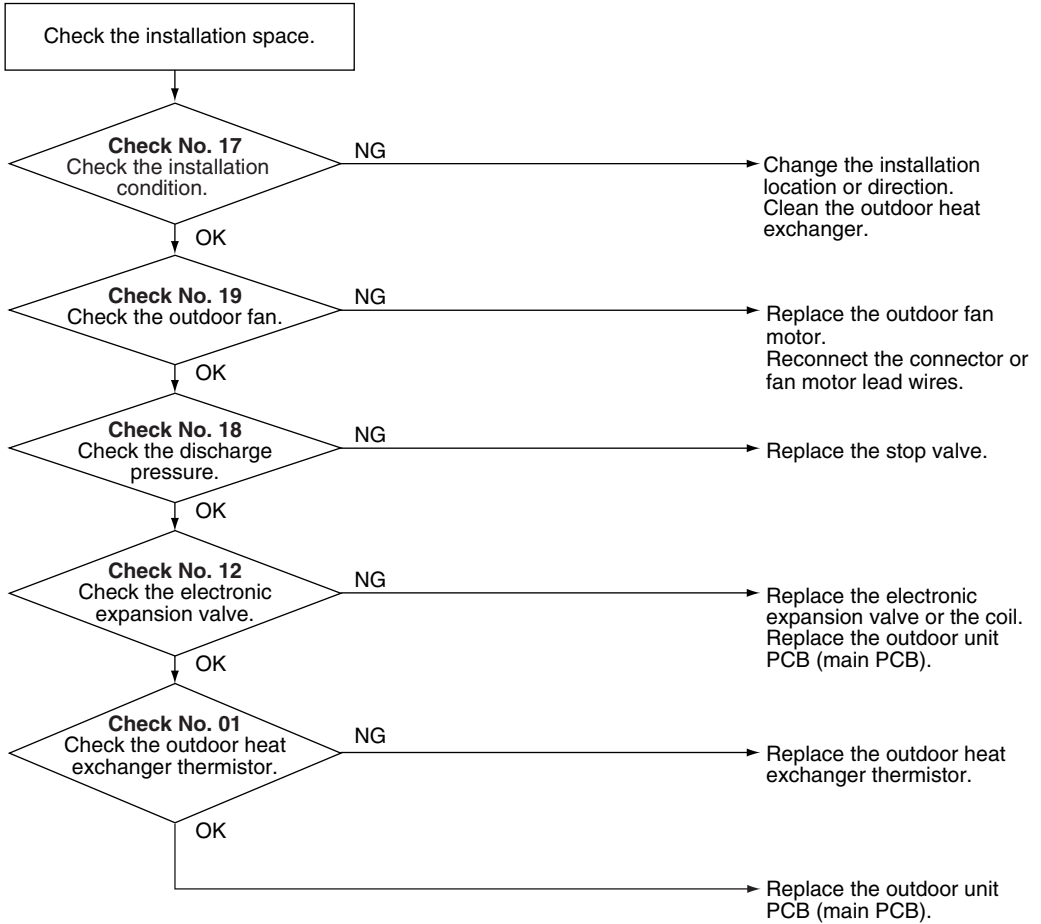

(R20418)

4.17 Compressor System Sensor Abnormality

Error Code	H0
Method of Error Detection	The system checks the DC current before the compressor starts.
Error Decision Conditions	<ul style="list-style-type: none"> ■ The voltage converted from the DC current before compressor start-up is out of the range 0.5 ~ 4.5 V. ■ The DC voltage before compressor start-up is below 50 V.
Supposed Causes	<ul style="list-style-type: none"> ■ Broken or disconnected harness ■ Defective outdoor unit PCB

Troubleshooting

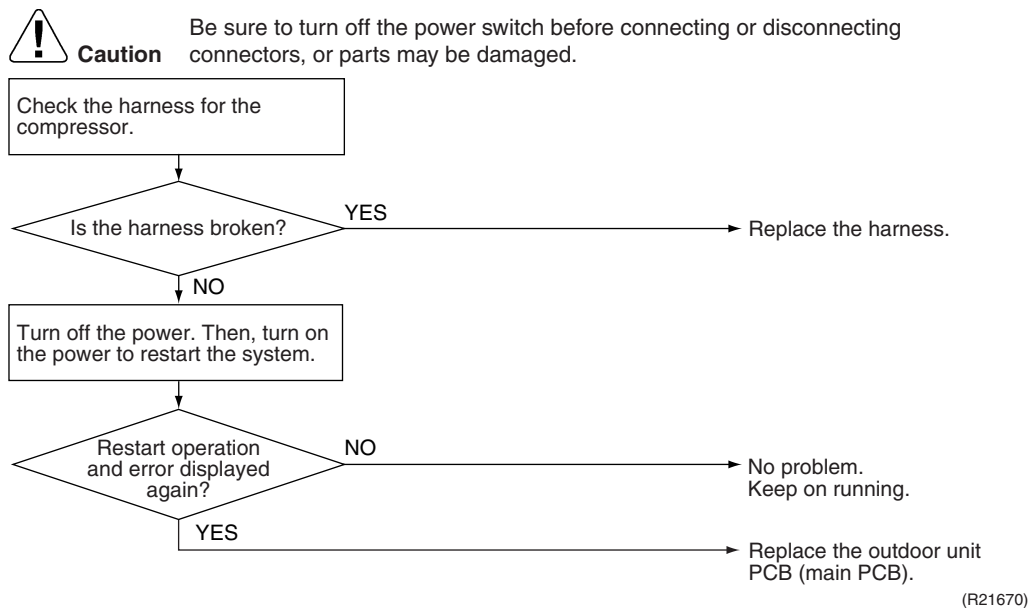

4.18 Position Sensor Abnormality

Error Code	H6
Method of Error Detection	A compressor start-up failure is detected by checking the compressor running condition through the position detection circuit.
Error Decision Conditions	<ul style="list-style-type: none">■ If the error repeats, the system is shut down.■ Reset condition: Continuous run for about 11 minutes without any other error
Supposed Causes	<ul style="list-style-type: none">■ Power supply voltage is not as specified.■ Disconnection of the compressor harness■ Defective compressor■ Defective outdoor unit PCB■ Start-up failure caused by the closed stop valve■ Input voltage is outside the specified range.

Troubleshooting



Check No.15
Refer to P.105



Check No.18
Refer to P.108



Check No.20
Refer to P.109



Caution Be sure to turn off the power switch before connecting or disconnecting connectors, or parts may be damaged.

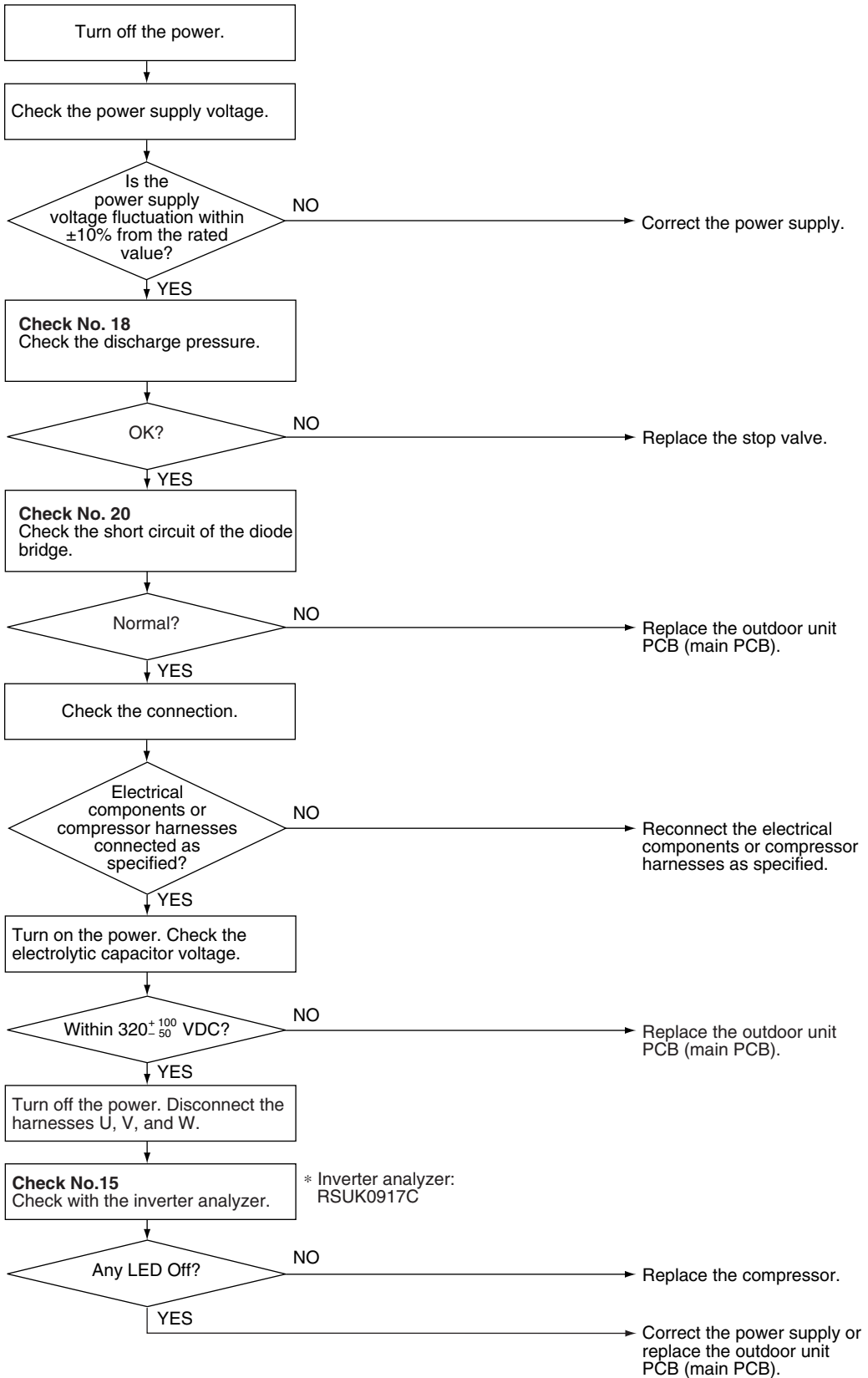

(R22764)

4.19 Thermistor or Related Abnormality (Outdoor Unit)

Error Code	<i>H9, U3, U5, P4</i>
Method of Error Detection	This fault is identified based on the thermistor input voltage to the microcomputer. A thermistor fault is identified based on the temperature sensed by each thermistor.
Error Decision Conditions	<ul style="list-style-type: none"> ■ The voltage between the both ends of the thermistor is above 4.96 V or below 0.04 V with the power on. ■ U3 error is judged if the discharge pipe temperature is lower than the heat exchanger temperature.
Supposed Causes	<ul style="list-style-type: none"> ■ Disconnection of the connector for the thermistor ■ Thermistor corresponding to the error code is defective. ■ Defective heat exchanger thermistor in the case of U3 error (outdoor heat exchanger thermistor in cooling operation, or indoor heat exchanger thermistor in heating operation) ■ Defective outdoor unit PCB
Troubleshooting	<p>In case of P4</p> <p> Caution Be sure to turn off the power switch before connecting or disconnecting connectors, or parts may be damaged.</p> <p>Replace the outdoor unit PCB (main PCB).</p> <p>P4 : Radiation fin thermistor</p>

Troubleshooting



Check No.01
Refer to P.101

In case of H9, J3, J6



Caution

Be sure to turn off the power switch before connecting or disconnecting connectors, or parts may be damaged.

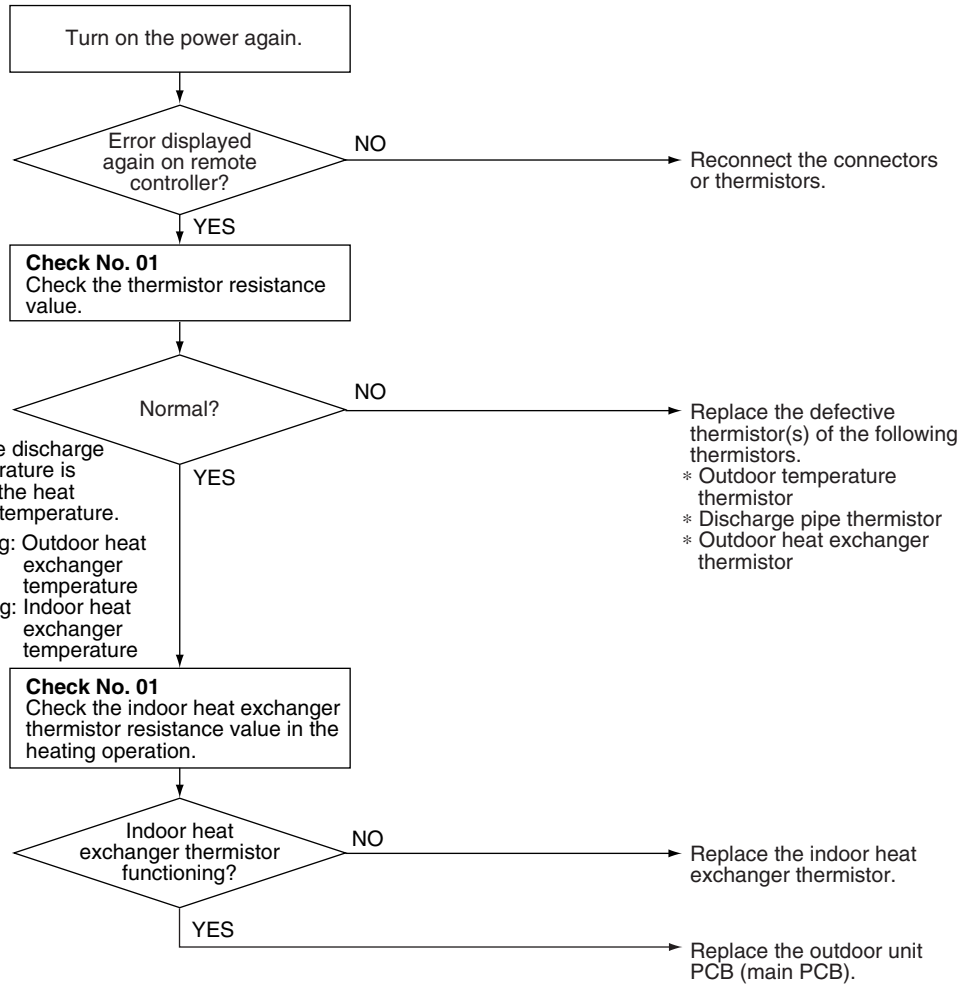

J3 error: the discharge pipe temperature is lower than the heat exchanger temperature.

Cooling: Outdoor heat exchanger temperature
Heating: Indoor heat exchanger temperature

(R20406)

- H9 : Outdoor temperature thermistor
- J3 : Discharge pipe thermistor
- J6 : Outdoor heat exchanger thermistor

4.20 Electrical Box Temperature Rise

Error Code **L3**

Method of Error Detection An electrical box temperature rise is detected by checking the radiation fin thermistor with the compressor off.

- Error Decision Conditions**
- With the compressor off, the radiation fin temperature is above **A**.
 - The error is cleared when the radiation fin temperature drops below **B**.
 - To cool the electrical components, the outdoor fan starts when the radiation fin temperature rises above **C** and stops when the radiation fin temperature drops below **B**.

	A		B		C	
	°C	°F	°C	°F	°C	°F
09 class	82	179.6	65	149	70	158
12 class	90 ★	194 ★	75	167	81 ★	177.8 ★
15 class	90 ★	194 ★	64	147.2	81 ★	177.8 ★

★: The same value continues.

- Supposed Causes**
- Defective outdoor fan motor
 - Short circuit
 - Defective radiation fin thermistor
 - Disconnection of connector
 - Defective outdoor unit PCB

Troubleshooting

 **Check No.17**
Refer to P.108

 **Check No.19**
Refer to P.109

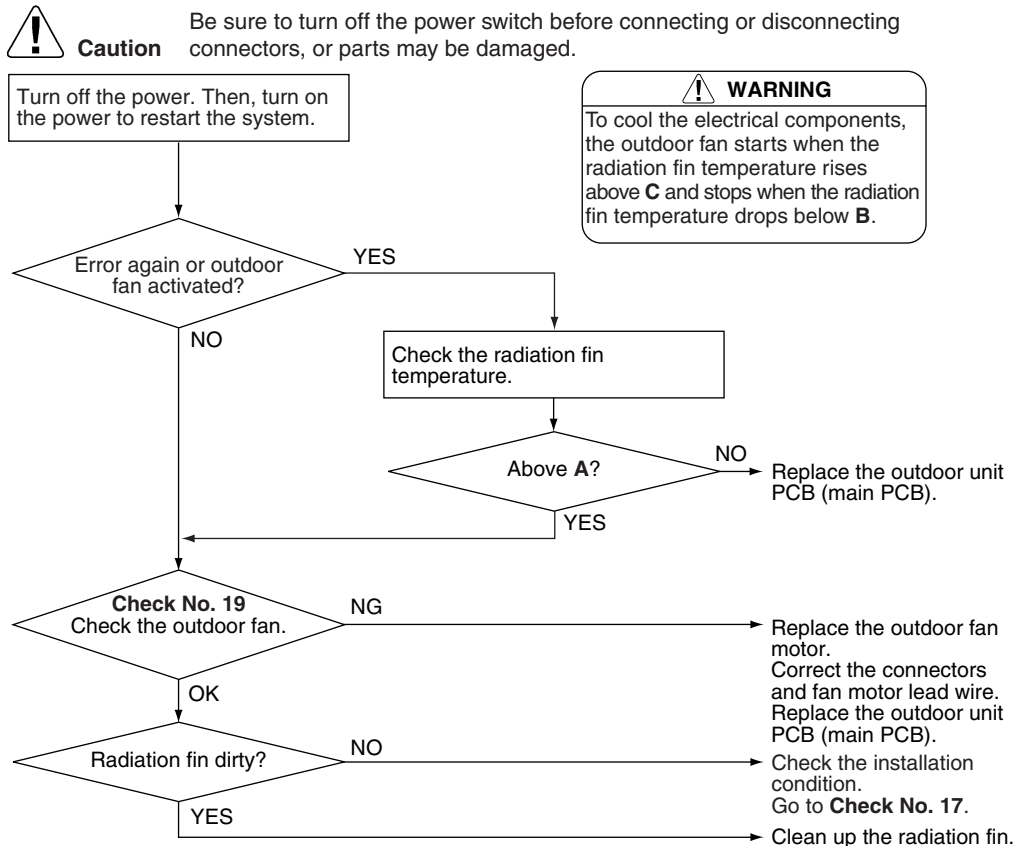

(R22998)

4.21 Radiation Fin Temperature Rise

Error Code **L4**

Method of Error Detection A radiation fin temperature rise is detected by checking the radiation fin thermistor with the compressor on.

Error Decision Conditions

- If the radiation fin temperature with the compressor on is above **A**.
- The error is cleared when the radiation fin temperature drops below **B**.
- If the error repeats, the system is shut down.
- Reset condition: Continuous run for about 60 minutes without any other error

	A		B	
	°C	°F	°C	°F
09 class	99	210.2	70	158
12 class	90	194	84	183.2
15 class	100	212	57	134.6

Supposed Causes

- Defective outdoor fan motor
- Short circuit
- Defective radiation fin thermistor
- Disconnection of connector
- Defective outdoor unit PCB
- Silicone grease is not applied properly on the radiation fin after replacing the outdoor unit PCB.

Troubleshooting



Check No.17
Refer to P.108



Check No.19
Refer to P.109



Caution

Be sure to turn off the power switch before connecting or disconnecting connectors, or parts may be damaged.

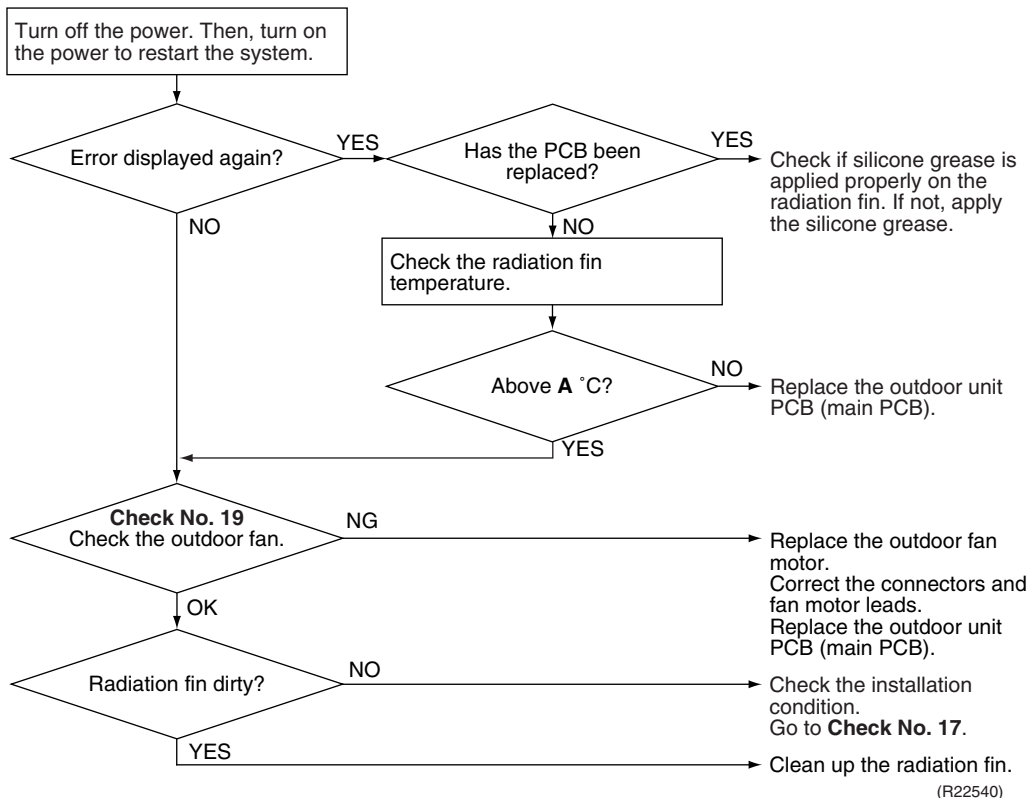

Note: Refer to Silicone Grease on Power Transistor / Diode Bridge on page 122 for details.

4.22 Output Overcurrent Detection

Error Code	U5
Method of Error Detection	An output overcurrent is detected by checking the current that flows in the inverter DC section.
Error Decision Conditions	<ul style="list-style-type: none"> ■ A position signal error occurs while the compressor is running. ■ A rotation speed error occurs while the compressor is running. ■ An output overcurrent signal is fed from the output overcurrent detection circuit to the microcomputer. ■ If the error repeats, the system is shut down. ■ Reset condition: Continuous run for about 11 minutes without any other error
Supposed Causes	<ul style="list-style-type: none"> ■ Poor installation condition ■ Closed stop valve ■ Defective power module ■ Wrong internal wiring ■ Abnormal power supply voltage ■ Defective outdoor unit PCB ■ Power supply voltage is not as specified. ■ Defective compressor

Troubleshooting



Check No.15
Refer to P.105



Check No.17
Refer to P.108



Check No.18
Refer to P.108



Check No.22
Refer to P.111



Caution Be sure to turn off the power switch before connecting or disconnecting connectors, or parts may be damaged.

* An output overcurrent may result from wrong internal wiring. If the system is interrupted by an output overcurrent after the wires have been disconnected and reconnected for part replacement, check the wiring again.

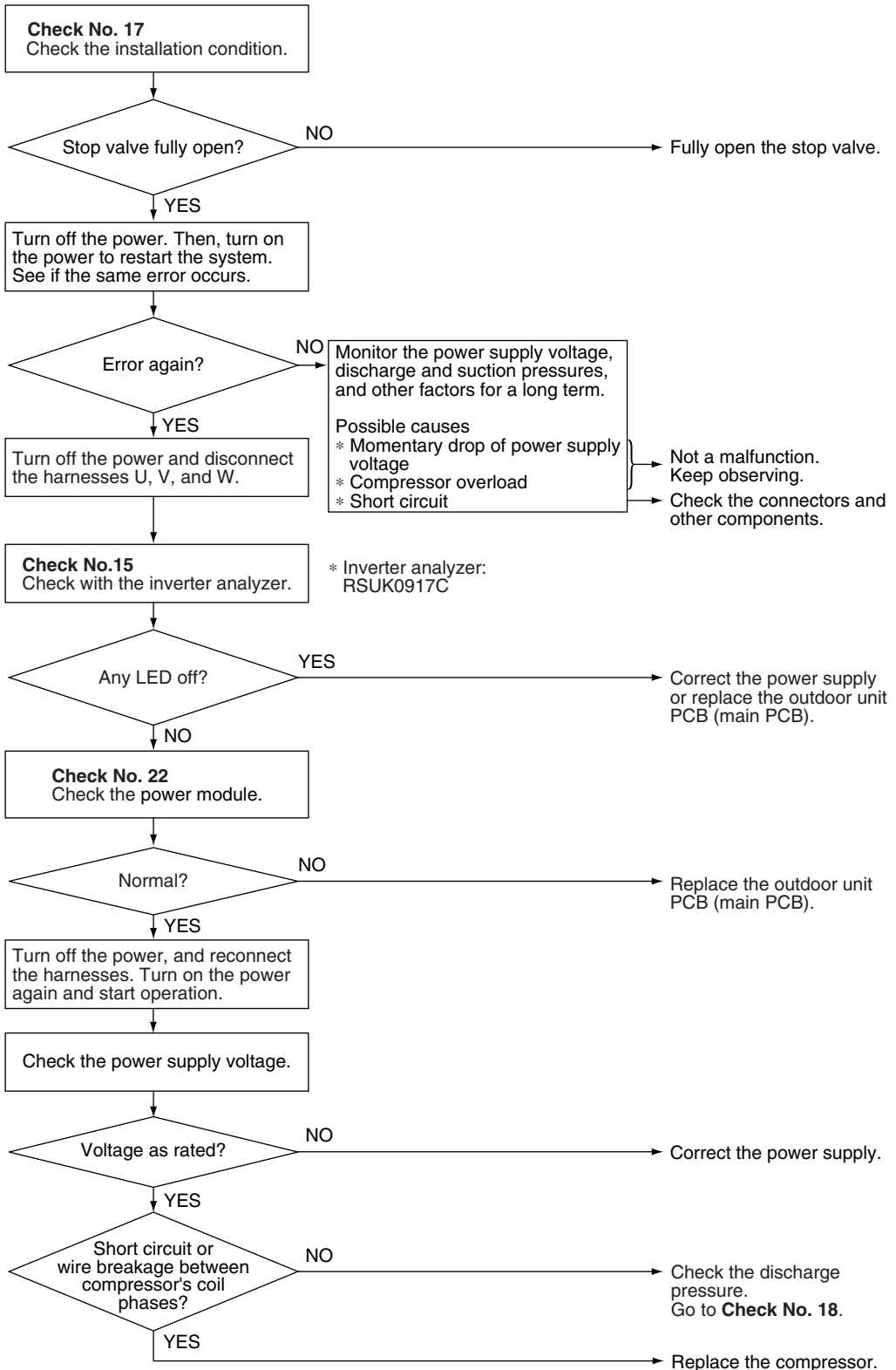

(R21438)

5. Check

5.1 Thermistor Resistance Check

Check No.01

Disconnect the connectors of the thermistors from the PCB, and measure the resistance of each thermistor using multimeter.

Thermistor temperature		Resistance (kΩ)	
°C	°F	Room temperature thermistor	Other thermistors
-20	-4	73.4	197.8
-15	5	57.0	148.2
-10	14	44.7	112.1
-5	23	35.3	85.60
0	32	28.2	65.93
5	41	22.6	51.14
10	50	18.3	39.99
15	59	14.8	31.52
20	68	12.1	25.02
25	77	10.0	20.00
30	86	8.2	16.10
35	95	6.9	13.04
40	104	5.8	10.62
45	113	4.9	8.707
50	122	4.1	7.176

(R25°C (77°F) = 10 kΩ, B = 3435 K) (R25°C (77°F) = 20 kΩ, B = 3950 K)

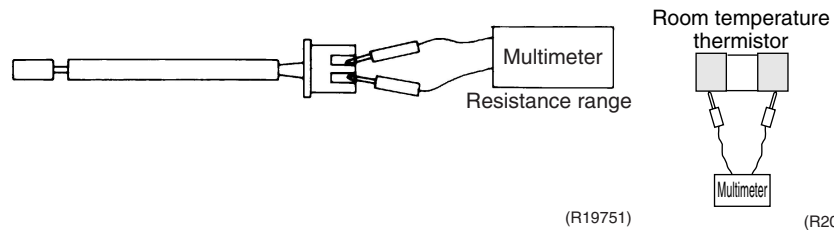
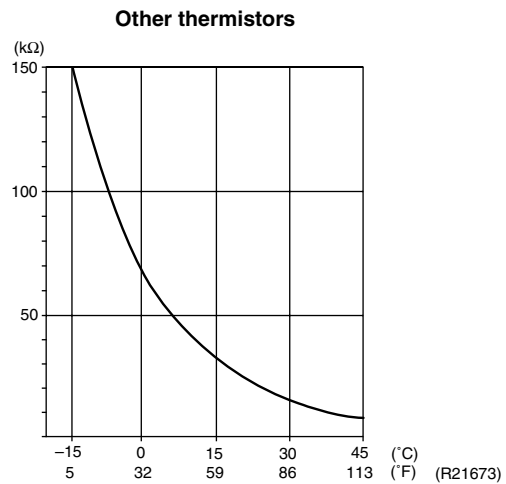
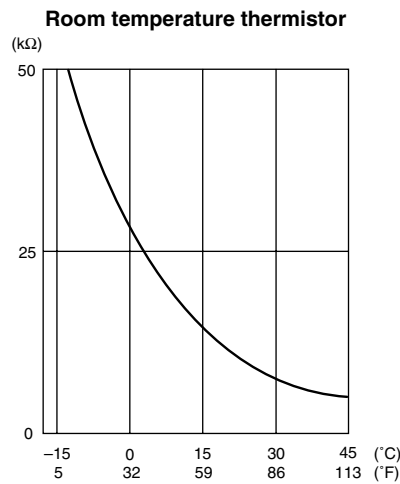

- When the room temperature thermistor is soldered on a PCB, remove the PCB from the control PCB to measure the resistance.
- When the connector of indoor heat exchanger thermistor is soldered on a PCB, remove the thermistor and measure the resistance.

5.2 Indoor Fan Motor Connector Output Check

Check No.03

FTX Series

- ◆ Fan motor wire breakdown / short circuit check
 1. Check the connector for connection.
 2. Turn the power off.
 3. Check if each resistance at the phases U - V and V - W is $90 \Omega \sim 100 \Omega$ (between the pins 12 - 9, and between 9 - 6).
- ◆ Motor control voltage check
 1. Check the connector for connection.
 2. Check the motor control voltage is generated (between the pins 2 - 3).
- ◆ Rotation pulse check
 1. Check the connector for connection.
 2. Turn the power on and stop the operation.
 3. Check if the Hall IC generates the rotation pulse 4 times when the fan motor is manually rotated once (between the pins 1 - 3).

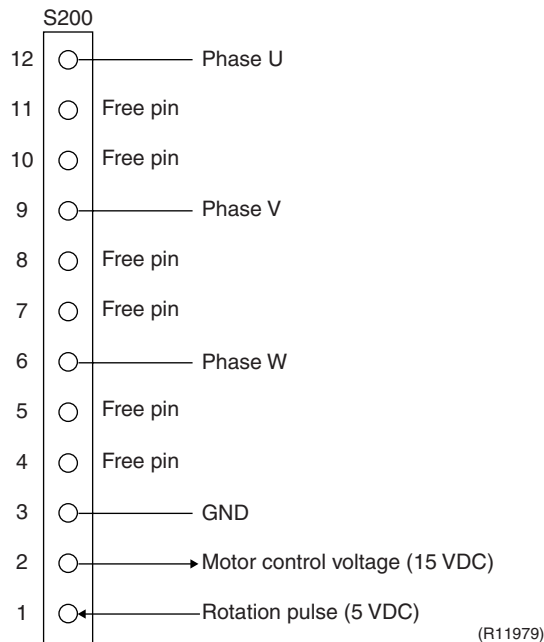

Check No.02

FVXS Series

1. Check the connection of connector.
2. Check motor power supply voltage output (pins 4 - 7).
3. Check motor control voltage (pins 4 - 3).
4. Check rotation command voltage output (pins 4 - 2).
5. Check rotation pulse input (pins 4 - 1).

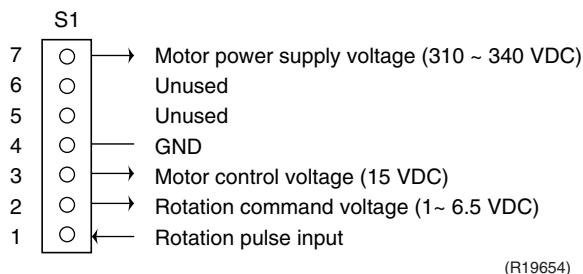

5.3 Power Supply Waveforms Check

Check No.11

Measure the power supply waveform between No. 1 and No. 2 on the terminal board, and check the waveform disturbance.

- Check if the power supply waveform is a sine wave (Fig.1).
- Check if there is waveform disturbance near the zero-cross (sections circled in Fig.2).

Fig.1

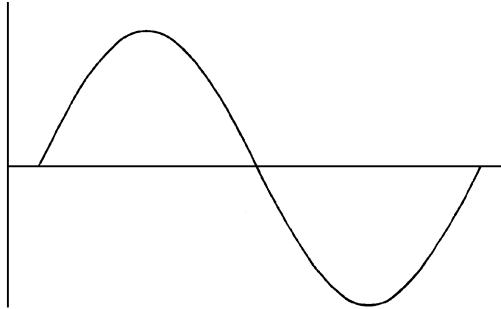
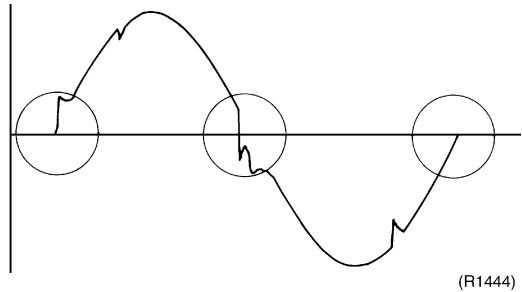

Fig.2



(R1736)

(R1444)

5.4 Electronic Expansion Valve Check

Check No.12

Conduct the followings to check the electronic expansion valve (EV).

1. Check if the EV connector is correctly connected to the PCB.
2. Turn the power off and on again, and check to see if the EV generates a latching sound.
3. If the EV does not generate a latching sound in the above step 2, disconnect the connector and check the continuity using a multimeter.
4. Check the continuity between the pins 1 - 6, 2 - 6, 3 - 6, and 4 - 6 (between the pins 1 - 5, 2 - 5, 3 - 5, 4 - 5 for the 5P connector models). If there is no continuity between the pins, the EV coil is faulty.
5. If the continuity is confirmed in step 3, the outdoor unit PCB (main PCB) is faulty.

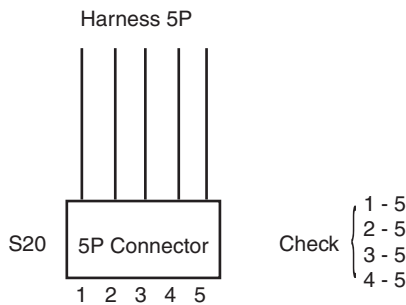

(R20506)

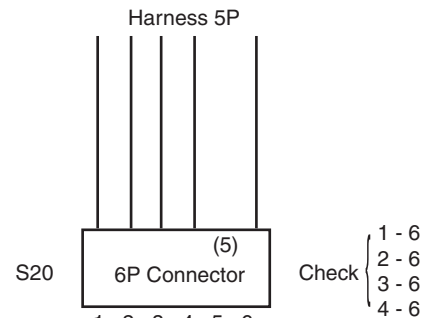

(R16386)

5.5 Four Way Valve Performance Check

Check No.13

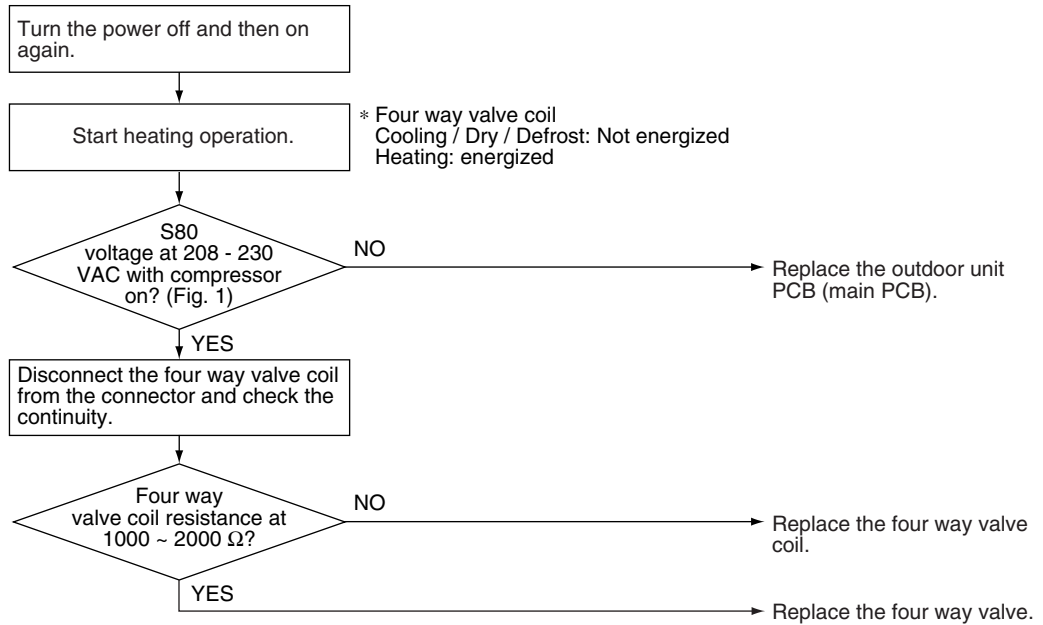

(R21674)

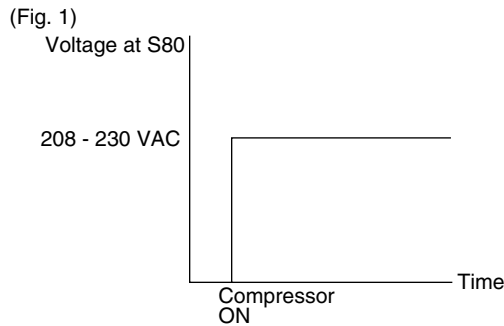

(R14674)

5.6 Inverter Unit Refrigerant System Check

Check No.14

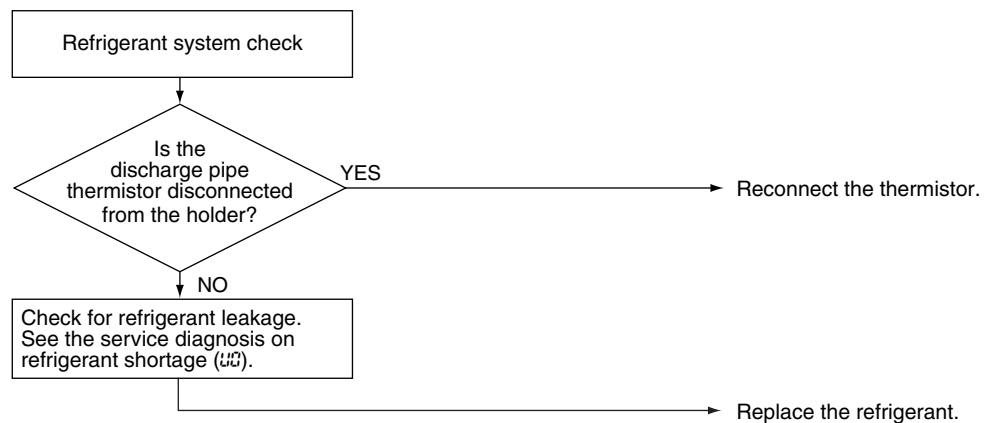

(R15833)

5.7 Inverter Analyzer Check

Check No.15

■ Characteristics

Inverter analyzer: RSUK0917C

If an abnormal stop occurs due to compressor startup failure or overcurrent output when using an inverter unit, it is difficult to judge whether the stop is caused by the compressor failure or some other failure (main PCB, power module, etc.). The inverter analyzer makes it possible to judge the cause of trouble easily and securely. (Connect an inverter analyzer as a quasi-compressor instead of compressor and check the output of the inverter.)

■ Operation Method

Step 1

Be sure to turn off the power.

Step 2

Install an inverter analyzer instead of a compressor.

Note:

Make sure the charged voltage of the built-in smoothing electrolytic capacitor drops to 10 VDC or below before carrying out the service work.

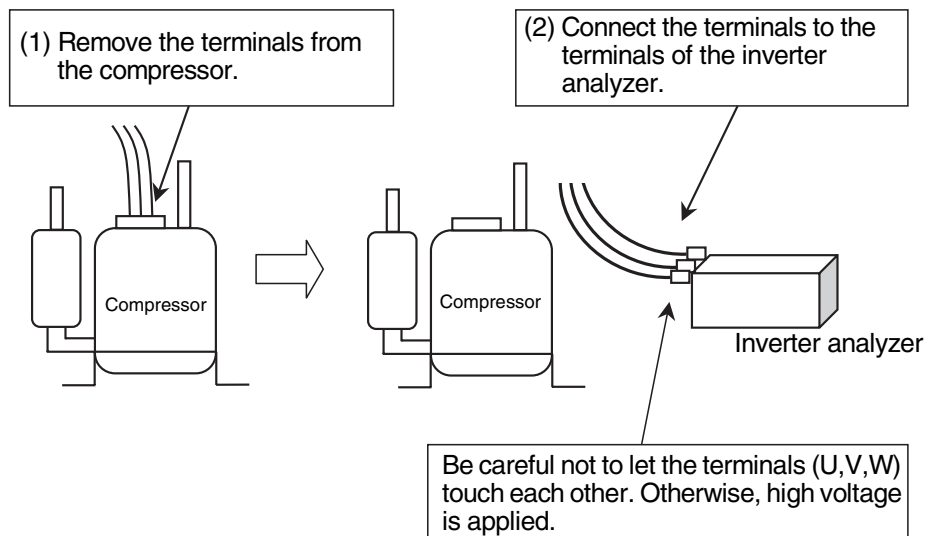

(R22731)

Reference:

If the terminals of the compressor are not FASTON terminals (difficult to remove the wire on the terminals), it is possible to connect wires available on site to the outdoor unit from output side of PCB. (Do not connect them to the compressor at the same time, otherwise it may result in incorrect detection.)

Step 3

Activate power transistor test operation from the indoor unit.

- (1) Turn the power on.
- (2) Press the center of **TEMP** button and **OFF** button on the remote controller at the same time.
- (3) Select ? with **TEMP** ^ or **TEMP** v button.
- (4) Press **FAN** button.
- (5) Press **FAN ONLY** button to start the power transistor test operation.

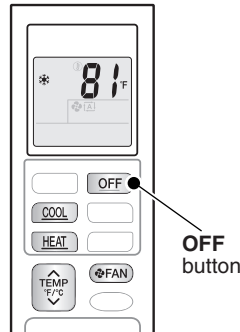

(R23157)

■ **Diagnose method (Diagnose according to 6 LEDs lighting status.)**

- (1) If all the LEDs are lit uniformly, the compressor is defective.
→ Replace the compressor.
- (2) If the LEDs are not lit uniformly, check the power module.
→ Refer to **Check No.22**.
- (3) If NG in **Check No.22**, replace the power module.
(Replace the main PCB. The power module is united with the main PCB.)
If OK in **Check No.22**, check if there is any solder cracking on the PCB.
- (4) If any solder cracking is found, replace the PCB or repair the soldered section.
If there is no solder cracking, replace the PCB.

**Caution**

- (1) When the output frequency is low, the LEDs blink slowly. As the output frequency increases, the LEDs blink quicker. (The LEDs look like they are lit.)
- (2) On completion of the inverter analyzer diagnosis, be sure to re-crimp the FASTON terminals. Otherwise, the terminals may be burned due to loosening.

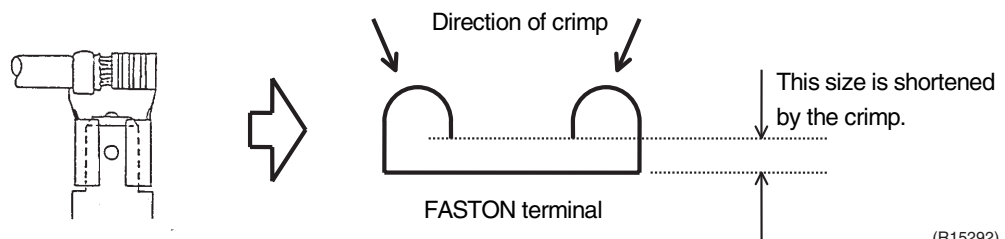

(R15292)

5.8 Rotation Pulse Check on the Outdoor Unit PCB

Check No.16

Make sure that the voltage of 320 + 100 V ~ 320 - 50 V is applied.

1. Set operation off and power off. Disconnect the connector S70 or S71.
2. Check that the voltage between the pins 4 - 7 is 320 VDC.
3. Check that the control voltage between the pins 3 - 4 is 15 VDC.
4. Check that the rotation command voltage between the pins 2 - 4 is 0 ~ 6.5 VDC.
5. Keep operation off and power off. Connect the connector S70 or S71.
6. Check whether 4 rotation pulses (0 ~ 15 VDC) are input at the pins 1 - 4 when the fan motor is rotated 1 turn by hand.

When the fuse is melted, check the outdoor fan motor for proper function.

If NG in step 2 → Defective PCB → Replace the outdoor unit PCB (main PCB).

If NG in step 4 → Defective Hall IC → Replace the outdoor fan motor.

If OK in both steps 2 and 4 → Replace the outdoor unit PCB (main PCB).

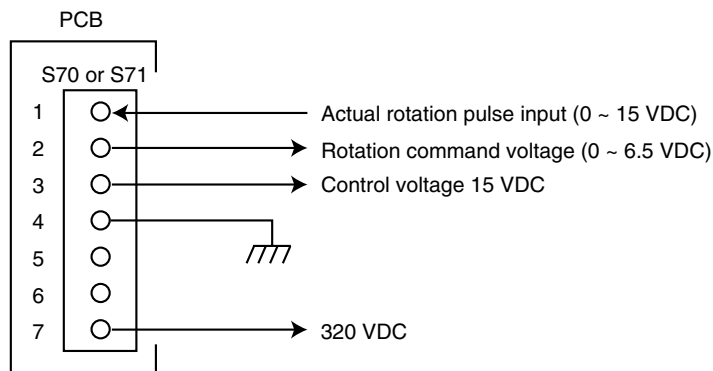

(R20507)

5.9 Installation Condition Check

Check No.17

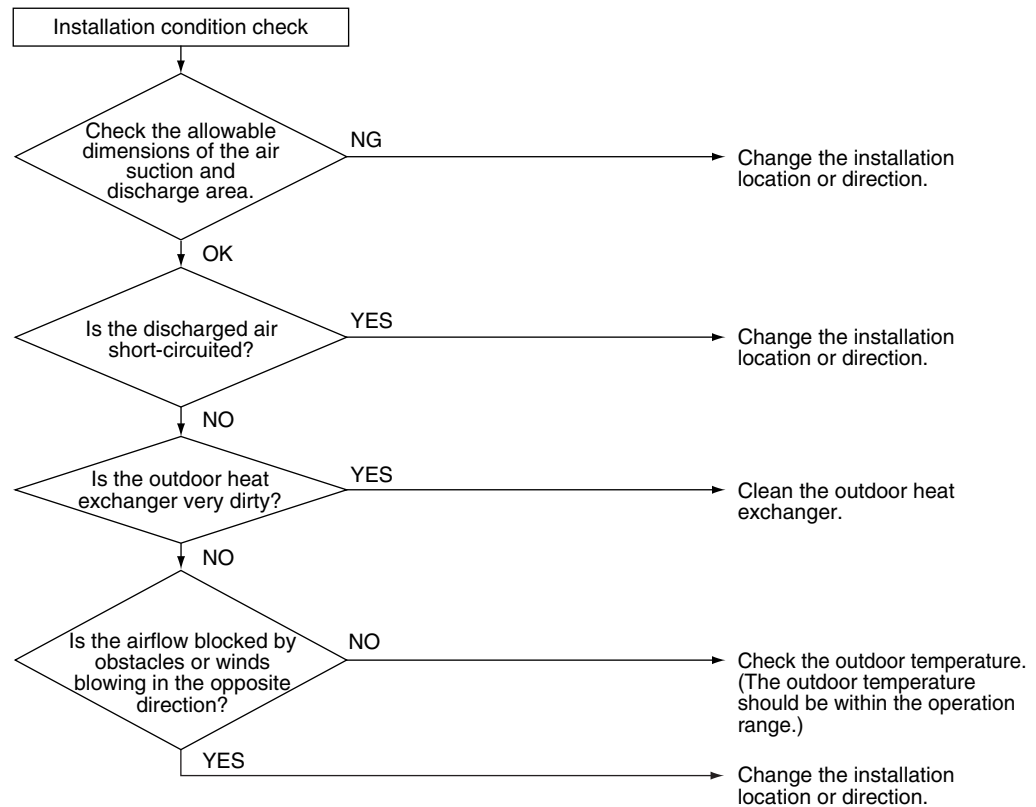

(R19394)

5.10 Discharge Pressure Check

Check No.18

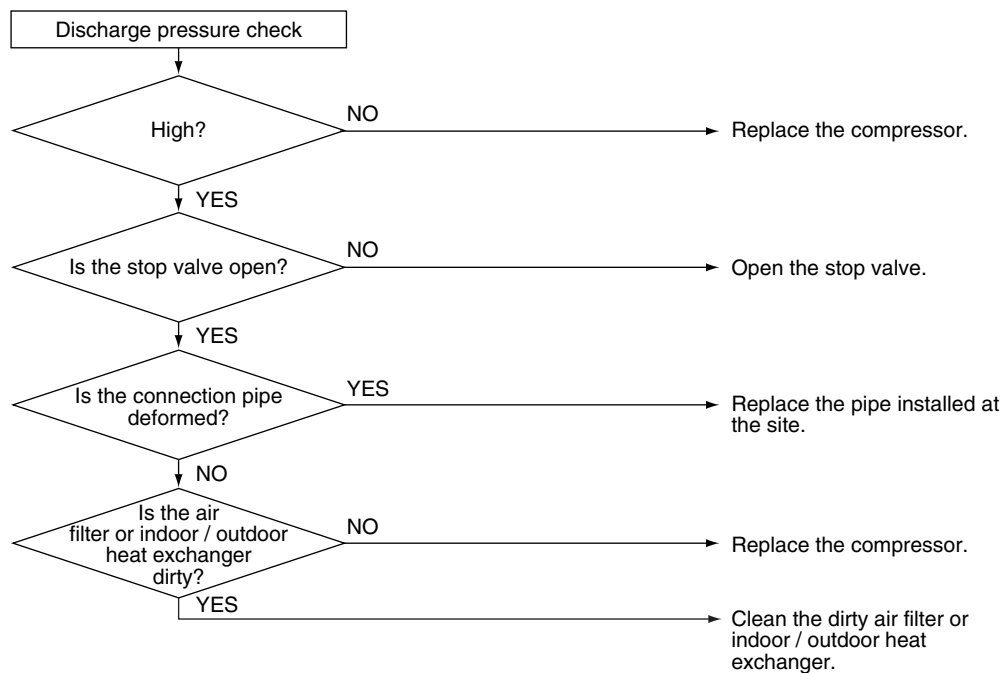

(R19385)

5.11 Outdoor Fan System Check

Check No.19

DC motor

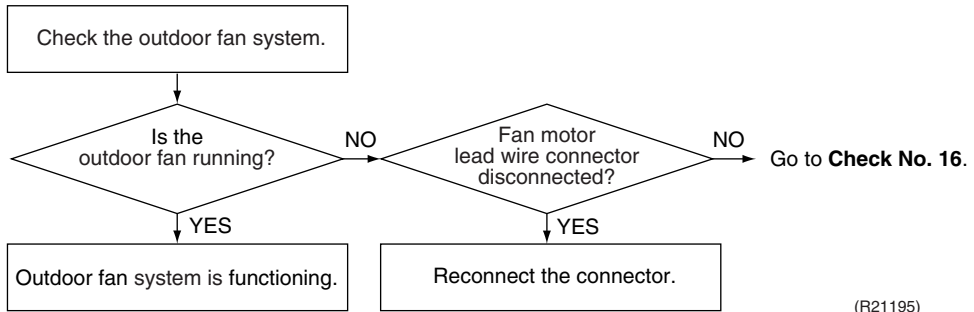

(R21195)

5.12 Main Circuit Short Check

Check No.20

Check to make sure that the voltage between (+) and (-) of the diode bridge (DB1) is approximately 0 V before checking.

- Measure the resistance between the pins of the DB1 referring to the table below.
- If the resistance is ∞ or less than 1 k Ω , short circuit occurs on the main circuit.

Positive terminal (+) of digital multimeter	~ (2, 3)	+ (4)	~ (2, 3)	- (1)
Negative terminal (-) of digital multimeter	+ (4)	~ (2, 3)	- (1)	~ (2, 3)
Resistance is OK.	several k Ω ~ several M Ω			
Resistance is NG.	0 Ω or ∞			

09 class

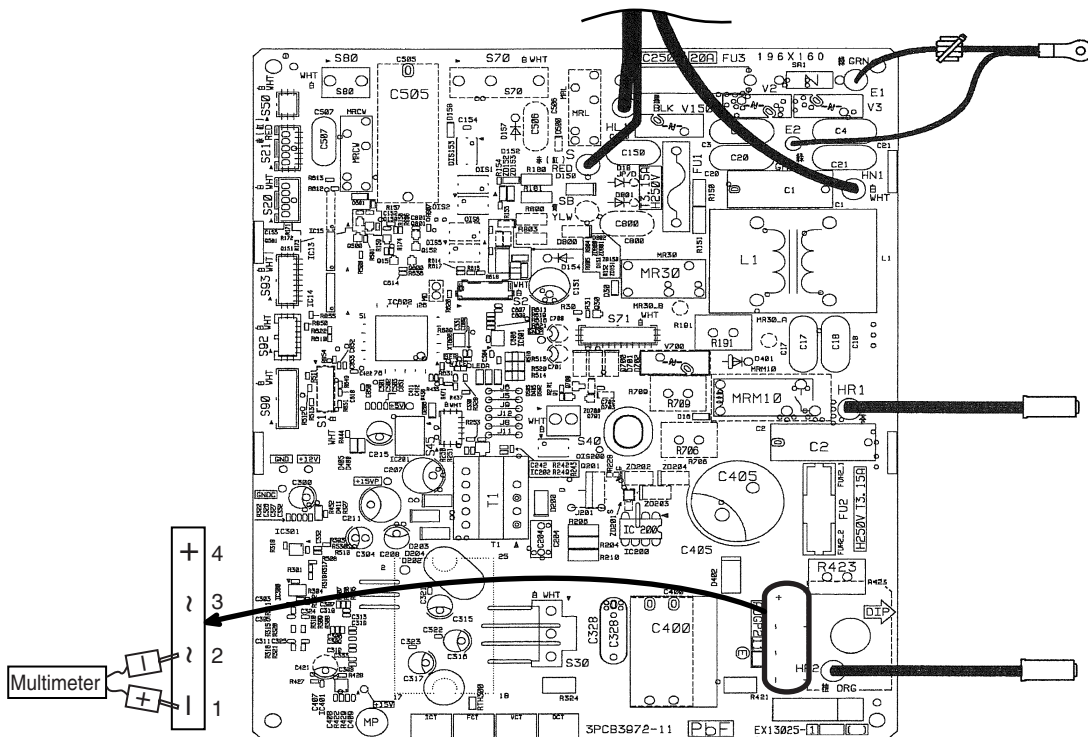

(R20698)

12 class

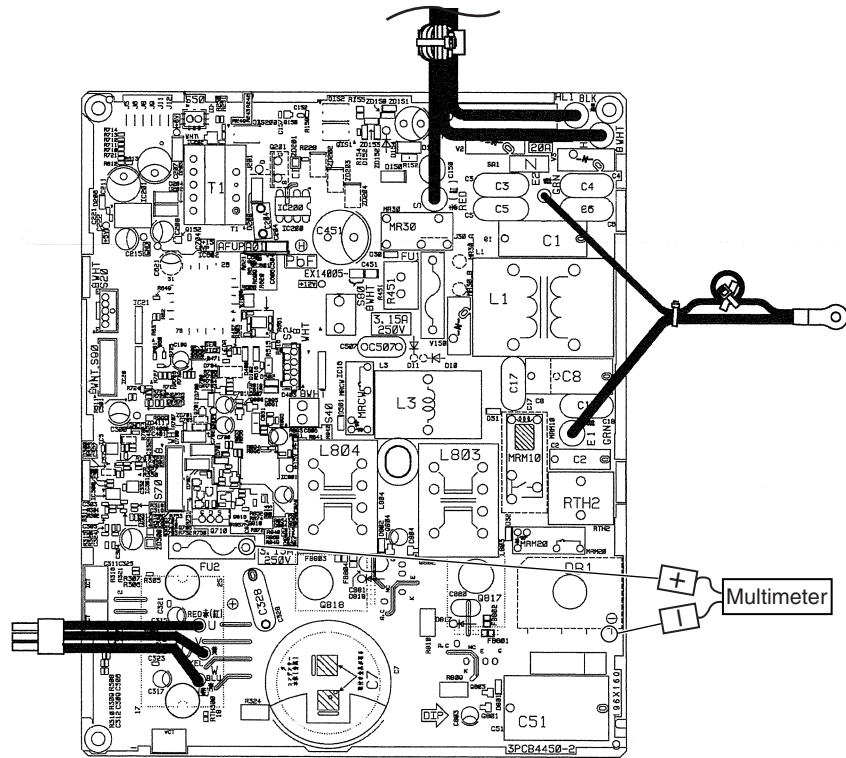

(R23024)

15 class

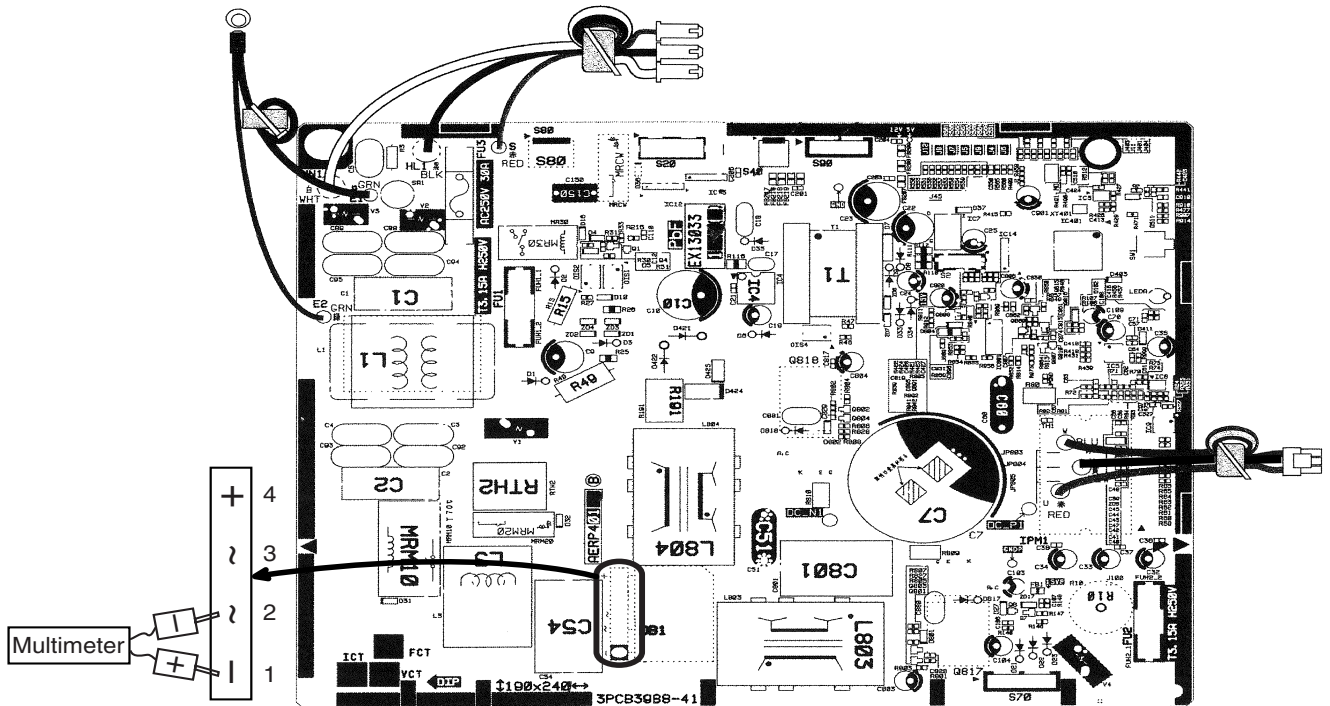

(R20701)

5.13 Power Module Check

Check No.22

Check to make sure that the voltage between (+) and (-) of the power module is approximately 0 V before checking.

- Disconnect the compressor harness connector from the outdoor unit PCB. To disengage the connector, press the protrusion on the connector.
- Follow the procedure below to measure resistance between the terminals of the power module and the terminals of the compressor with a multimeter. Evaluate the measurement results referring to the following table.

Positive terminal (+) of digital multimeter	Power module (+)	UVW	Power module (-)	UVW
Negative terminal (-) of digital multimeter	UVW	Power module (+)	UVW	Power module (-)
Resistance is OK.	several kΩ ~ several MΩ			
Resistance is NG.	0 Ω or ∞			

09 class

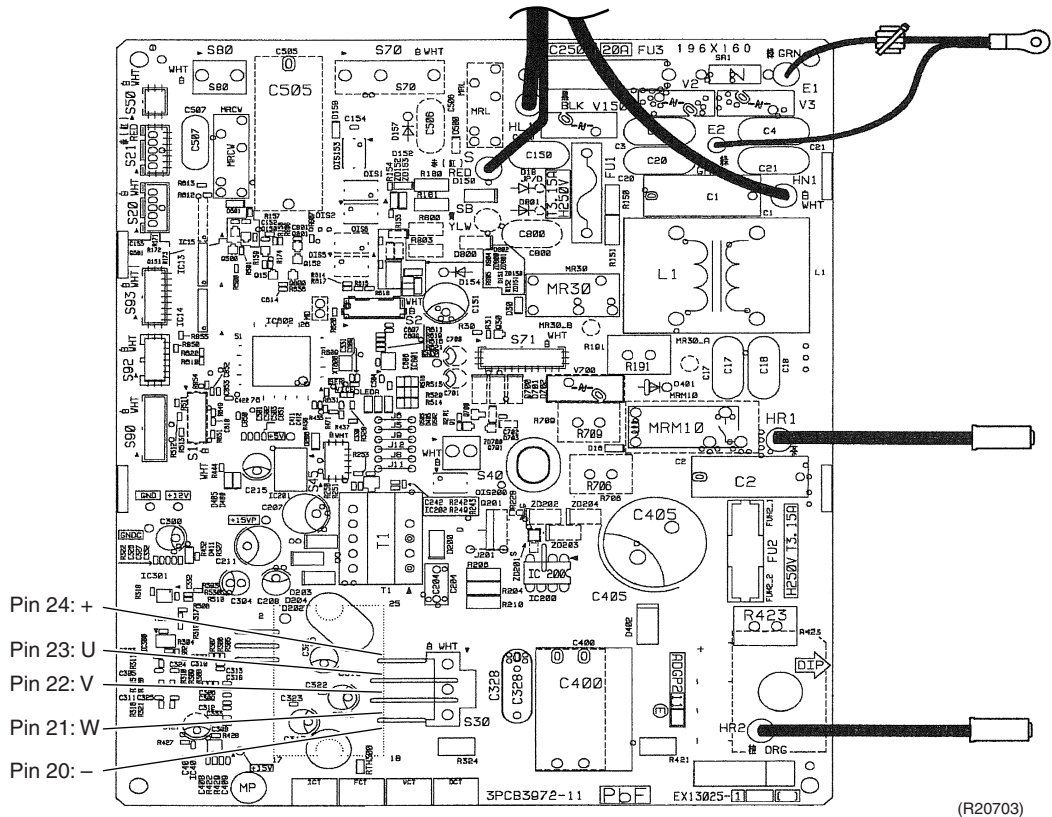

12 class

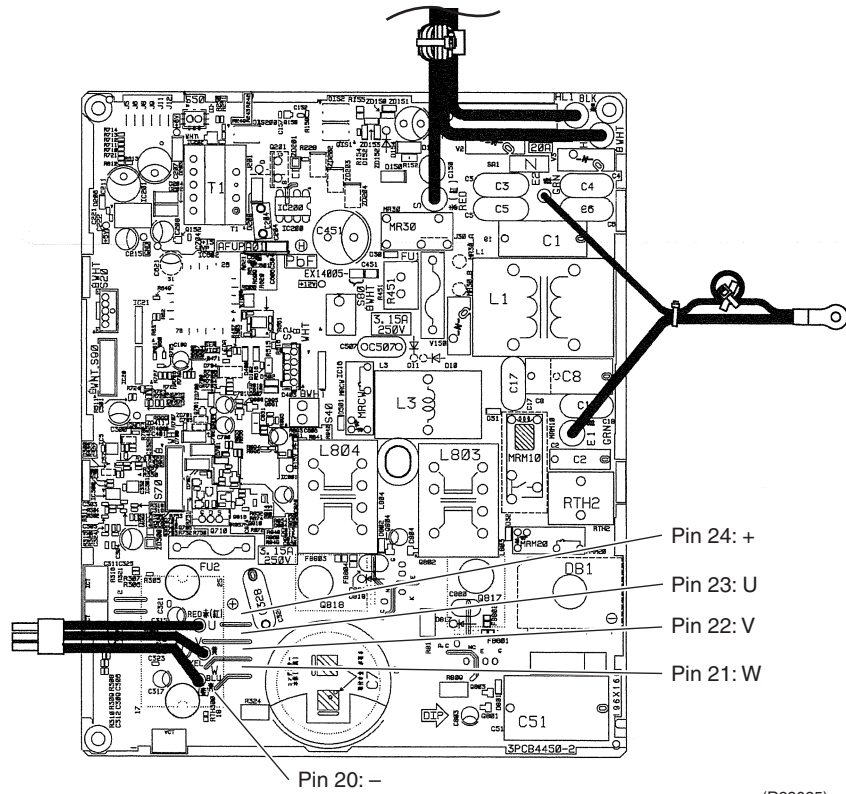

(R23025)

15 class

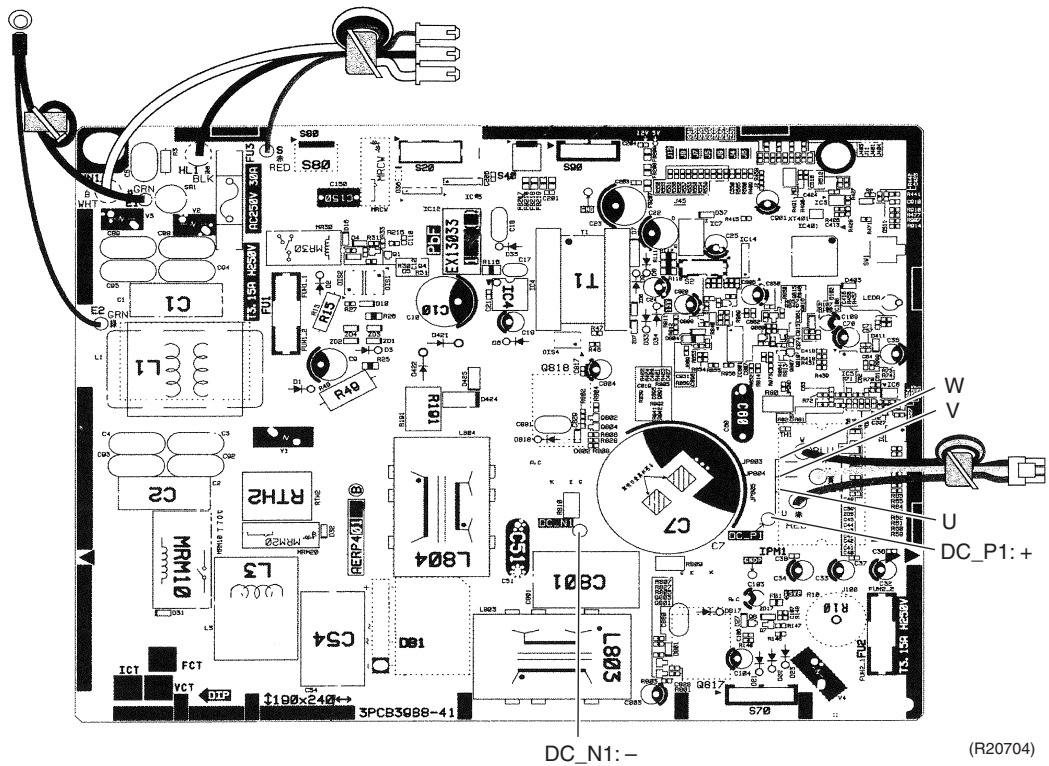

(R20704)

Part 7

Trial Operation and Field Settings

1. Pump Down Operation	114
2. Forced Cooling Operation	115
3. Trial Operation	116
4. Field Settings	118
4.1 Temperature Display Switch	118
4.2 When 2 Units are Installed in 1 Room.....	119
4.3 Jumper and Switch Settings.....	121
4.4 Facility Setting Switch (cooling at low outdoor temperature).....	121
5. Silicone Grease on Power Transistor / Diode Bridge.....	122

1. Pump Down Operation

Outline

In order to protect the environment, be sure to conduct pump down operation when relocating or disposing of the unit.

Detail

1. Remove the valve caps from the liquid stop valve and the gas stop valve.
2. Carry out forced cooling operation.
3. After 5 to 10 minutes, close the liquid stop valve with a hexagonal wrench.
4. After 2 to 3 minutes, close the gas stop valve and stop the forced cooling operation.

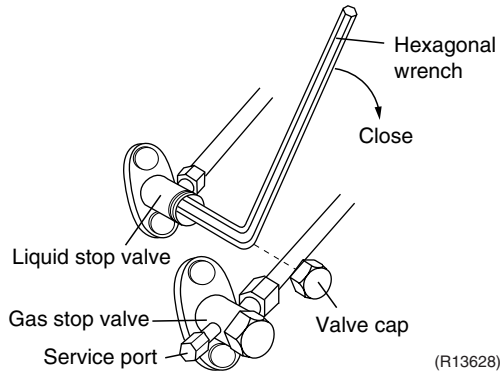

Refer to Forced Cooling Operation on page 115 for details.

2. Forced Cooling Operation

Item	Forced Cooling
Conditions	The forced cooling operation is allowed when both the following conditions are met. 1) The outdoor unit is not abnormal and not in the 3-minute standby mode. 2) The outdoor unit is not operating.
Start	Press the forced cooling operation ON/OFF button (SW1) on the indoor unit for 5 seconds.
Command frequency	09 class: 58 Hz 12/15 class: 30 Hz
End	The forced cooling operation ends when any of the following conditions is fulfilled. 1) The operation ends automatically after 15 minutes. 2) Press the forced cooling operation ON/OFF button (SW1) on the indoor unit again. 3) Press ON/OFF button on the remote controller.
Others	Protection functions have priority over all other functions during forced cooling operation.

Indoor Unit FTX Series

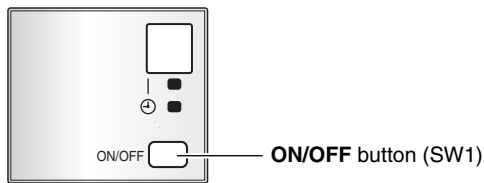

(R21069)

FTXV Series

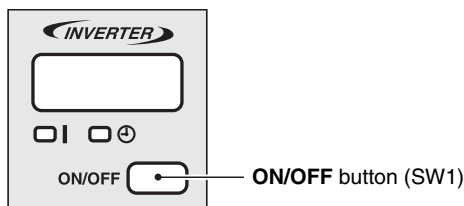

(R23005)

3. Trial Operation

Outline

Carry out the trial operation in accordance with the operation manual to ensure that all functions and parts, such as flap movement, are working properly.

Trial operation should be carried out in either cooling or heating operation.

Detail

1. Measure the power supply voltage and make sure that it falls within the specified range.
2. In cooling operation, select the lowest programmable temperature (18°C, 64°F); in heating operation, select the highest programmable temperature (30°C, 86°F).
 - ◆ Trial operation may be disabled in either operation mode depending on the room temperature.
 - ◆ After trial operation is complete, set the temperature to a normal level (26 ~ 28°C, 78 ~ 82°F in cooling, 20 ~ 24°C, 68 ~ 75°F in heating operation).
 - ◆ For protection, the system does not start for 3 minutes after it is turned off.

ARC480 Series

- (1) Press the center of **TEMP** button and **OFF** button on the remote controller at the same time.
- (2) Select ? (trial operation) with **TEMP** ^ or **TEMP** v button.
- (3) Press **FAN** button to enter the trial operation mode.
- (4) Press **COOL** or **HEAT** button to start trial operation.
- (5) Trial operation terminates in about 30 minutes and switches into the normal mode. To quit trial operation, press **OFF** button.

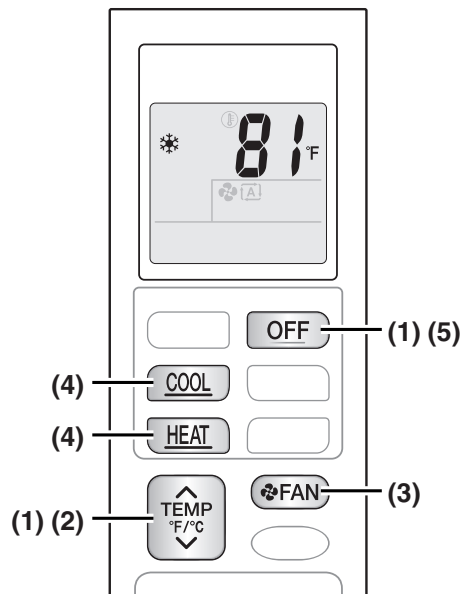

(R22999)

ARC466 Series

- (1) Press **On/Off** button to turn on the system.
- (2) Press the center of **Temp** button and **Mode** button at the same time.
- (3) Select 7[°] (trial operation) with **Temp ▲** or **Temp ▼** button.
- (4) Press **Mode** button to start the trial operation.
- (5) Press **Mode** button and select operation mode.
- (6) Trial operation terminates in about 30 minutes and switches into normal mode. To quit trial operation, press **On/Off** button.

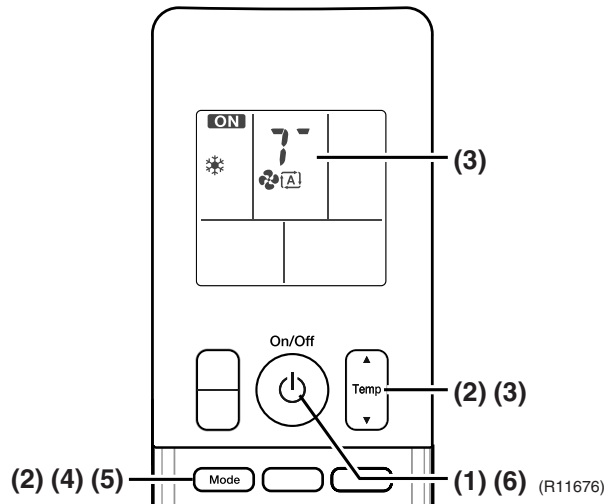

4. Field Settings

4.1 Temperature Display Switch

ARC480A8

- You can select Fahrenheit or Celsius for temperature display.
- Press **TEMP▲** and **ON TIMER** buttons simultaneously for 5 seconds to change the unit of temperature display.
- You can also change the unit of temperature display by pressing **TEMP▲** and **▼** buttons simultaneously for 5 seconds.

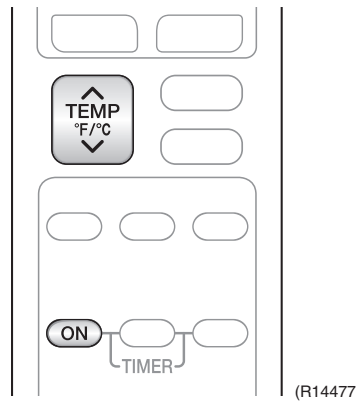

ARC466A21

- Press the upper side of **Temp** button and **On** button at the same time for 5 seconds to change the unit of temperature display.

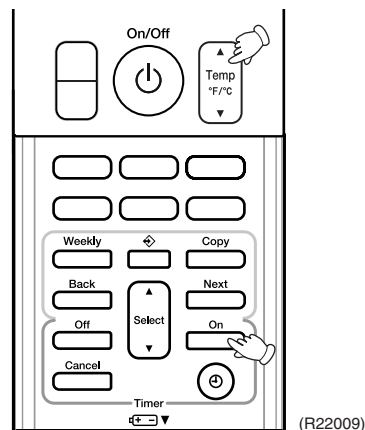

4.2 When 2 Units are Installed in 1 Room

Outline

When 2 indoor units are installed in 1 room, 1 of the 2 indoor units and the corresponding wireless remote controller can be set for different addresses.

FTX Series

- (1) Remove the battery cover of the remote controller.
- (2) Cut the address jumper.
- (3) Press the center of **TEMP** button and **OFF** button on the remote controller at the same time.
- (4) Select # (address setting) with **TEMP** ^ or **TEMP** v button.
- (5) Press **FAN** button to enter the address setting mode.
→ The indoor unit operation lamp blinks for 1 minute.
- (6) Press indoor unit **ON/OFF** button while the operation lamp is blinking.
- (7) Press **FAN** button on the remote controller for 5 seconds to return to the normal mode.

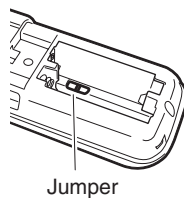

Jumper	Address
EXIST	1
CUT	2

Jumper

(R21071)

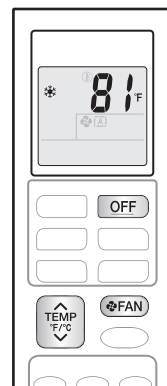

(R21822)

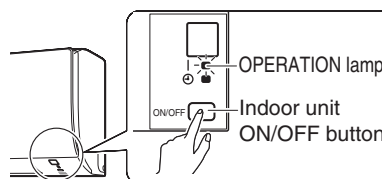

(R21072)



Caution

Replace the remote controller if you accidentally cut a wrong jumper.

Jumpers are necessary for electronic circuit. Improper operation may occur if you cut any of them.

FVXS Series

- (1) Remove the front grille.
- (2) Lift the sensor PCB fixing plate and remove the front shield plate.
- (3) Disconnect the connectors S1, S41, S42.
- (4) Remove the electric box (1 screw).
- (5) Pull out the indoor heat exchanger thermistor.
- (6) Remove the shield plate (8 tabs).
- (7) Cut the address setting jumper JA on the indoor unit PCB.

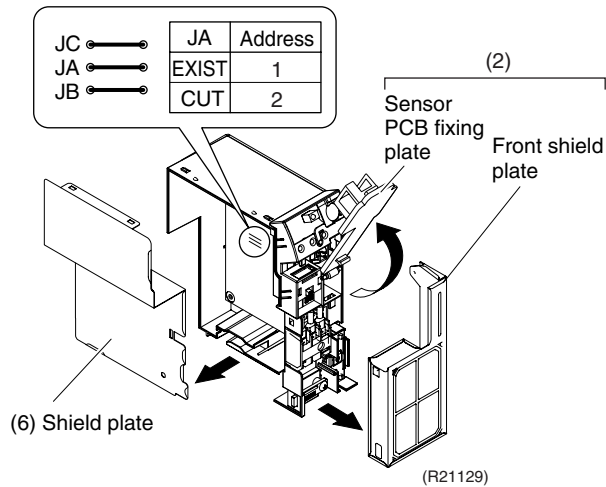
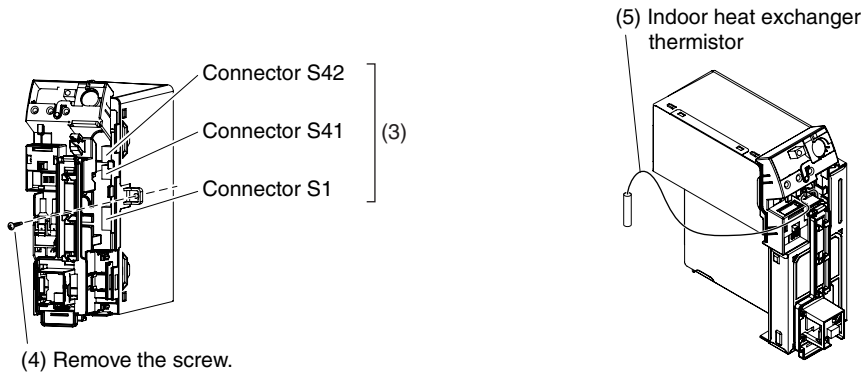
**Caution**

Replace the PCB if you accidentally cut a wrong jumper.

Jumpers are necessary for electronic circuit. Improper operation may occur if you cut any of them.

4.3 Jumper and Switch Settings

FVXS Series Jumper

Jumper (on indoor unit PCB)	Function	When connected (factory setting)	When cut
JB	Fan speed setting when compressor stops for thermostat OFF. (effective only at cooling operation)	Fan speed setting; Remote controller setting	The fan stops.
JC	Power failure recovery function	Auto-restart	The unit does not resume operation after recovering from a power failure. Timer settings are cleared.

FVXS Series Switch

Switch (on indoor unit PCB)	Function	OFF (factory setting)	ON
SW2-4	Upward airflow limit setting	Exposed or half embedded installation	Set the switch to ON position when you install the indoor unit embedded in the wall to avoid condensation.



For the location of the jumper and the switch, refer to page 14.

4.4 Facility Setting Switch (cooling at low outdoor temperature)

Outline

This function is limited to use for facilities (where the target of air conditioning is equipment, such as in a server room). Never use it in a residence or office where there are people present.

Detail

You can expand the operation range to -15°C (5°F) by cutting the jumper on the outdoor unit PCB. Note that the operation may stop if the outdoor temperature drops below -15°C (5°F). If the outdoor temperature rises, the operation starts again.



For the location of the jumper, refer to page 16, 17, 18.



Caution

Replace the PCB if you accidentally cut a wrong jumper.

Jumpers are necessary for electronic circuit. Improper operation may occur if you cut any of them.



Caution

1. If the outdoor unit is installed where the outdoor heat exchanger of the unit is exposed to direct wind, provide a windbreak wall.
2. Intermittent noises may be produced by the indoor unit due to the outdoor fan turning on and off when using facility settings.
3. Do not place humidifiers or other items which might raise the humidity in rooms where facility settings are being used.
A humidifier might cause dew jumping from the indoor unit outlet vent.
4. Cutting jumper sets the indoor fan tap to the highest position.

5. Silicone Grease on Power Transistor / Diode Bridge

Outline

Apply the specified silicone grease to the heat radiation part of a power transistor / diode bridge when you replace an outdoor unit PCB. The silicone grease encourages the heat radiation of a power transistor / diode bridge.

Detail

1. Wipe off the old silicone grease completely.
2. Apply the silicone grease evenly. See the illustrations below for examples of application.
3. Tighten the screws of the power transistor / diode bridge.
4. Make sure that the heat radiation parts are firmly contacted to the radiation fin.

Note: Smoke emission may be caused by bad heat radiation when the silicone grease is not appropriately applied.

- OK: Evenly applied

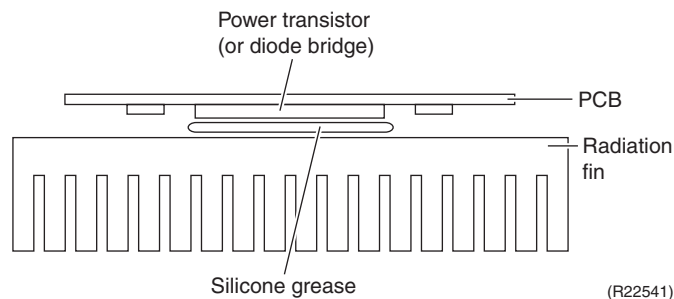

- NG: Not evenly applied

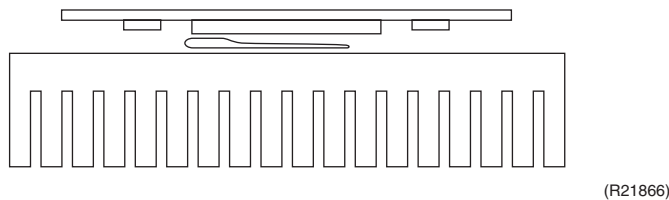

- NG: Foreign matter is stuck.

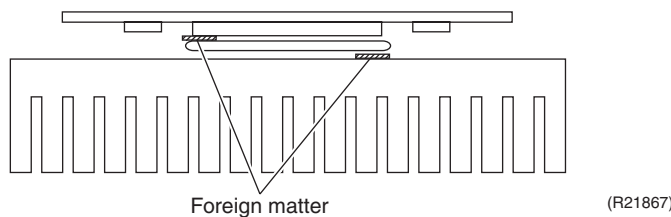

Part 8

Appendix

1. Piping Diagrams.....	124
1.1 Indoor unit	124
1.2 Outdoor Unit.....	125
2. Wiring Diagrams.....	127
2.1 Indoor Unit.....	127
2.2 Outdoor Unit.....	130

1. Piping Diagrams

1.1 Indoor unit

1.1.1 Heat Pump

FTX09/12NMVJU

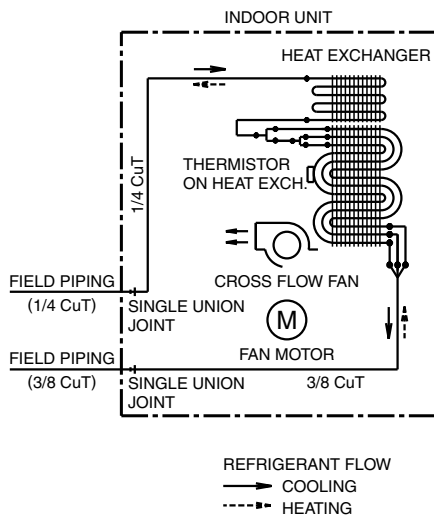

4D091708A

FTX15NMVJU

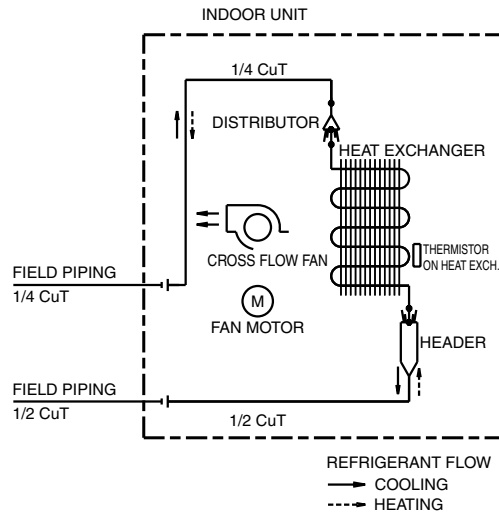

4D091769C

FVXS09/12NVJU

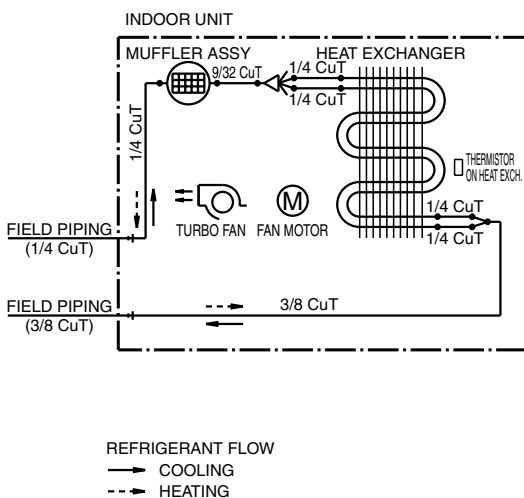

4D091794

FVXS15NVJU

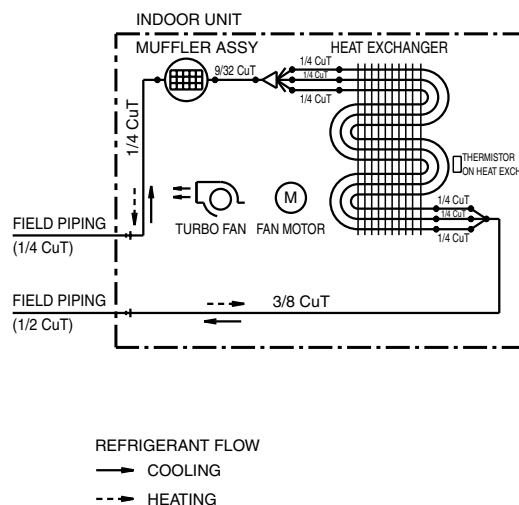

4D091795A

RXL15QMVJU

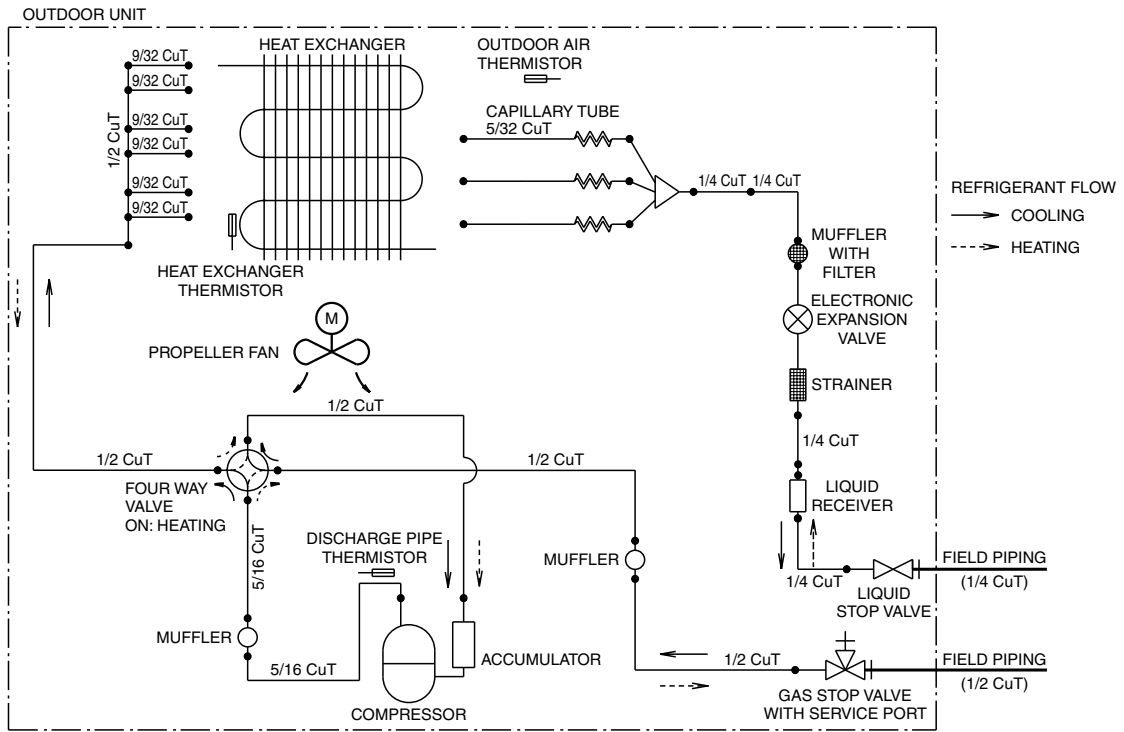

3D100007

2. Wiring Diagrams

2.1 Indoor Unit

FTX09/12NMVJU

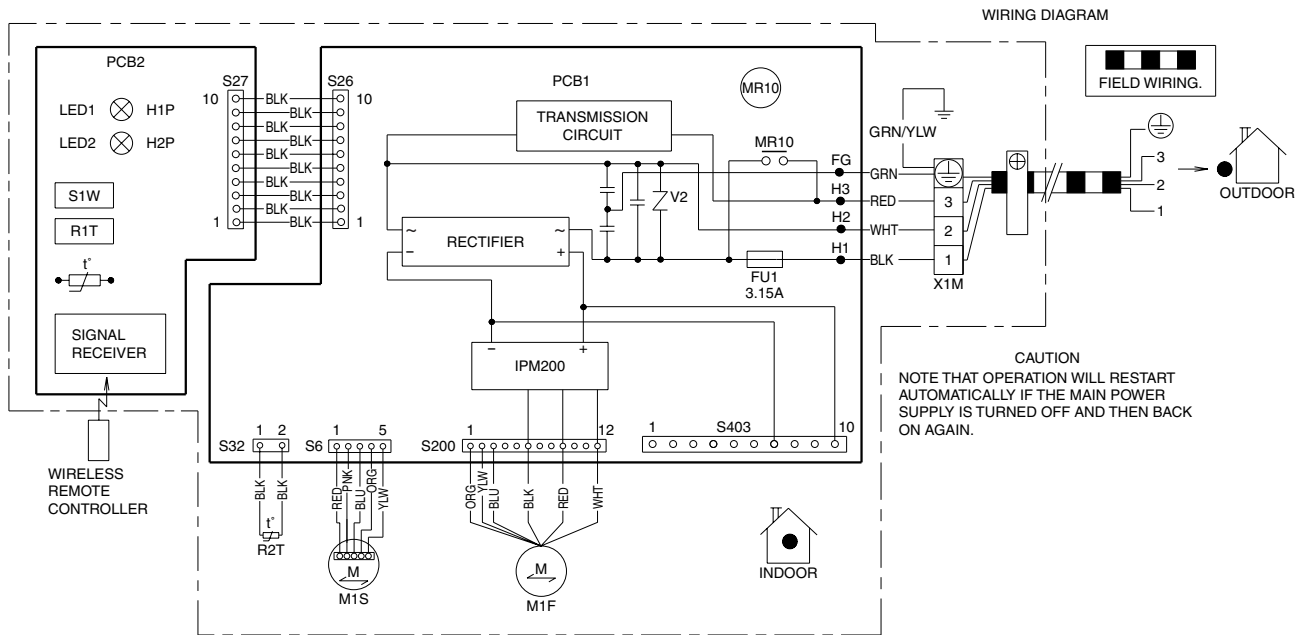

- | | | | | | | | |
|-------|----------------|------------|-------------------------|------|--------------------|---|---------------------|
| FG | : FRAME GROUND | M1S | : SWING MOTOR | S1W | : OPERATION SWITCH | ⊕ | : PROTECTIVE GROUND |
| FU1 | : FUSE | PCB1, PCB2 | : PRINTED CIRCUIT BOARD | X1M | : TERMINAL STRIP | | |
| H1-H3 | : HARNESS | R1T, R2T | : THERMISTOR | V2 | : VARISTOR | | |
| M1F | : FAN MOTOR | S6-S403 | : CONNECTOR | MR10 | : RELAY | | |

C: 3D086429C



Note: PCB1: Control PCB
 PCB2: Display PCB
 Refer to Part 3 for Printed Circuit Board Connector Wiring Diagram.

FTX15NMVJU

WIRING DIAGRAM

CAUTION
NOTE THAT OPERATION WILL RESTART AUTOMATICALLY IF THE MAIN POWER SUPPLY IS TURNED OFF AND THEN BACK ON AGAIN.

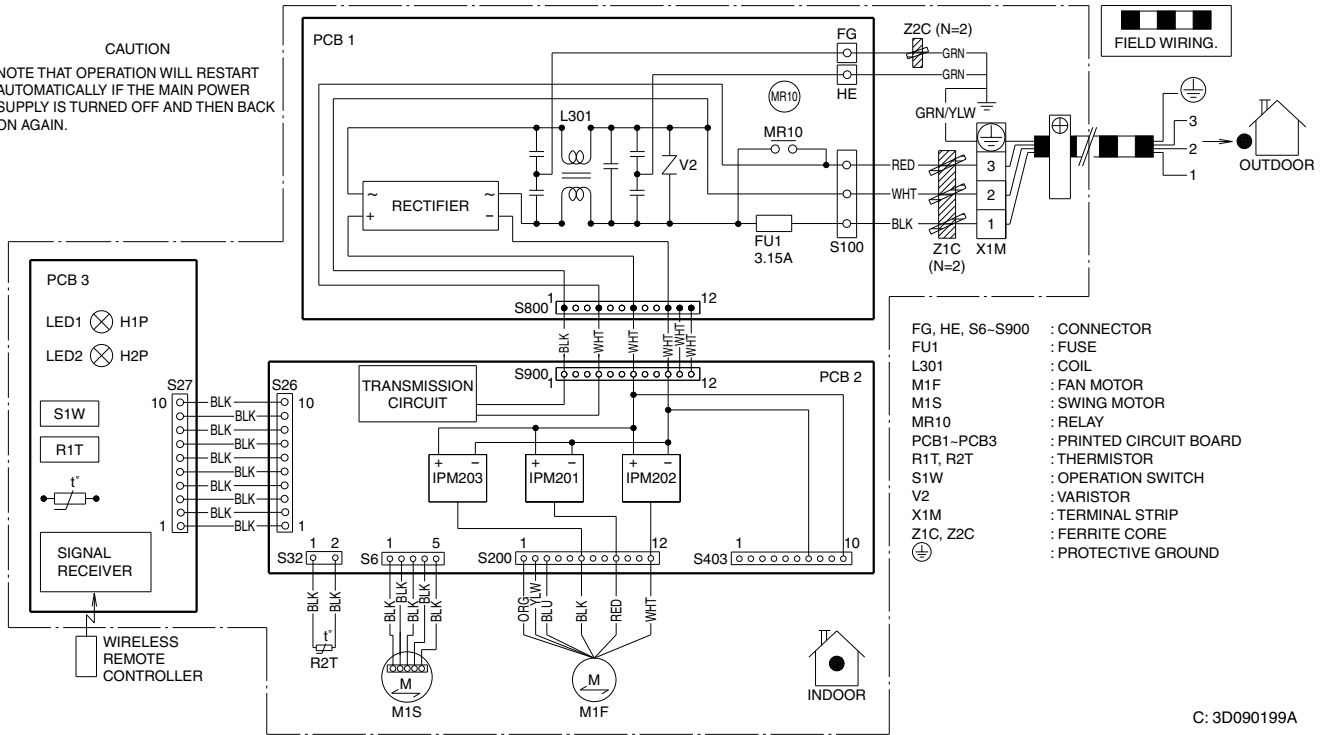

C: 3D090199A



Note: PCB1: Filter PCB
PCB2: Control PCB
PCB3: Display PCB
Refer to Part 3 for Printed Circuit Board Connector Wiring Diagram.

FVXS09/12/15NVJU

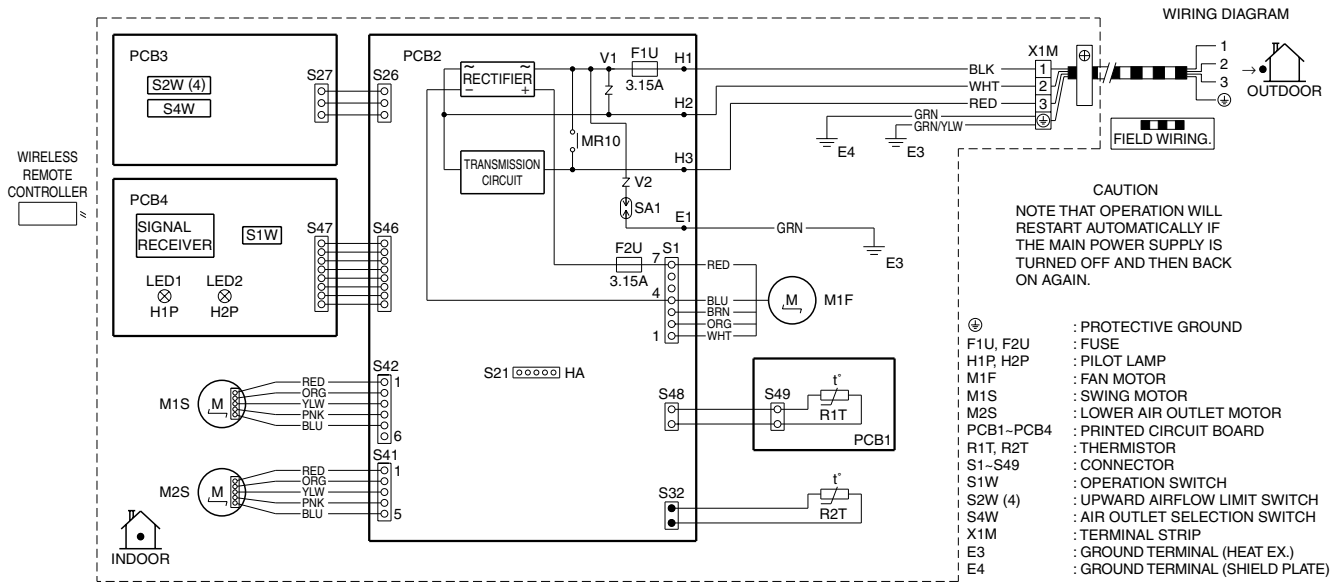

C: 3D090604A



Note: PCB1: Sensor PCB
 PCB2: Control PCB
 PCB3: Service PCB
 PCB4: Display PCB
 Refer to Part 3 for Printed Circuit Board Connector Wiring Diagram.

2.2 Outdoor Unit

RXL09QMJVJU

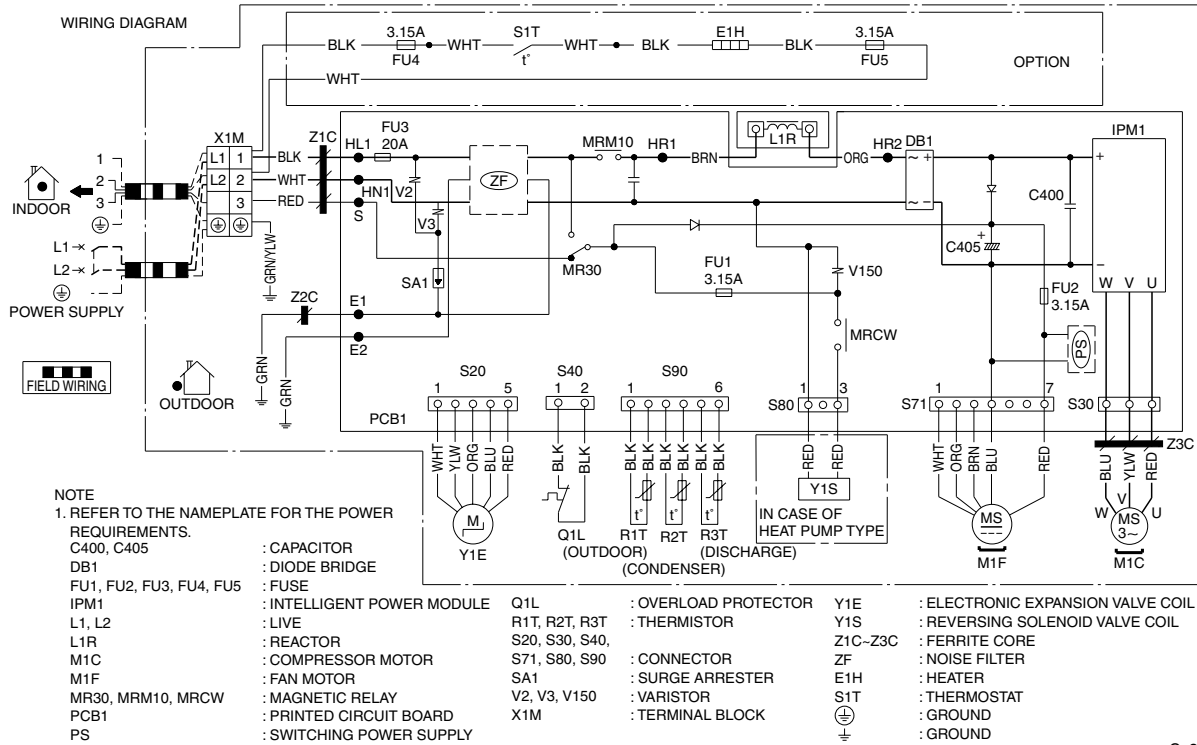

C: 3D099947



Note: PCB1: Main PCB
Refer to Part 3 for Printed Circuit Board Connector Wiring Diagram.

RXL12QMVJU

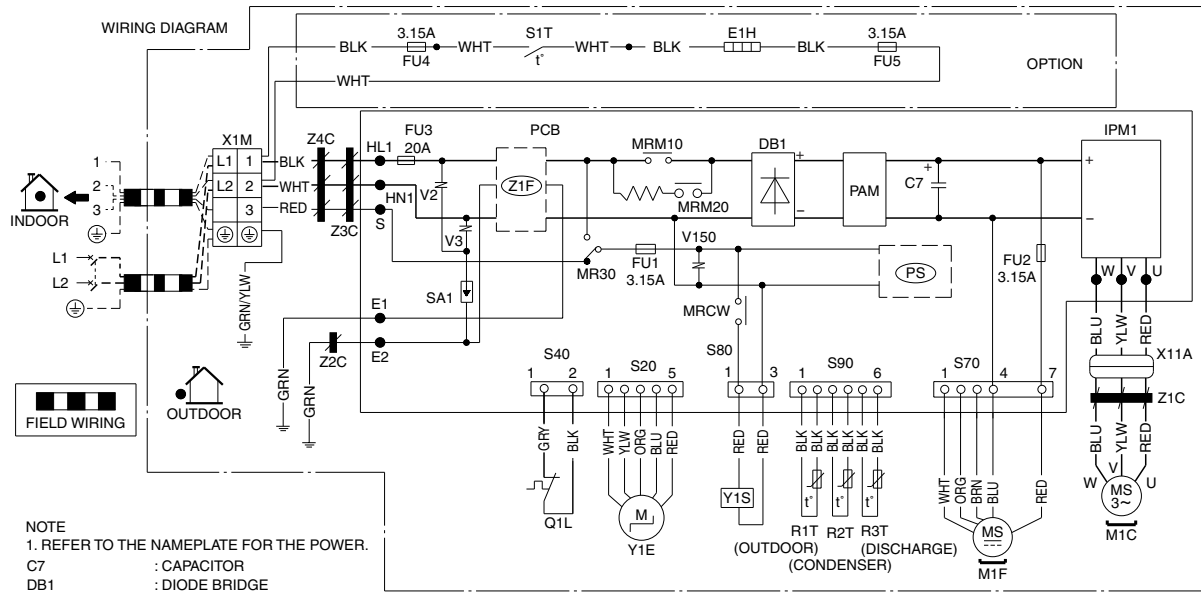

NOTE

1. REFER TO THE NAMEPLATE FOR THE POWER.

- C7 : CAPACITOR
- DB1 : DIODE BRIDGE
- FU1, FU2, FU3, FU4, FU5 : FUSE
- IPM1 : INTELLIGENT POWER MODULE
- L1, L2 : LIVE
- M1C : COMPRESSOR MOTOR
- M1F : FAN MOTOR
- MR30, MRM10, MRM20, MRCW : MAGNETIC RELAY
- PAM : PULSE AMPLITUDE MODULATION

- PCB : PRINTED CIRCUIT BOARD
- PS : SWITCHING POWER SUPPLY
- Q1L : OVERLOAD PROTECTOR
- R1T, R2T, R3T : THERMISTOR
- SA1 : SURGE ARRESTER
- S20, S40, S70, S80, S90, X11A : CONNECTOR
- V2, V3, V150 : VARISTOR

- X1M : TERMINAL BLOCK
- Y1E : ELECTRONIC EXPANSION VALVE COIL
- Y1S : REVERSING SOLENOID VALVE COIL
- Z1C-Z4C : FERRITE CORE
- Z1F : NOISE FILTER

- E1H : HEATER
- S1T : THERMOSTAT
- ⊕ : GROUND
- ⊖ : GROUND

C: 3D099948



Note: PCB: Main PCB
Refer to Part 3 for Printed Circuit Board Connector Wiring Diagram.

RXL15QMVJU

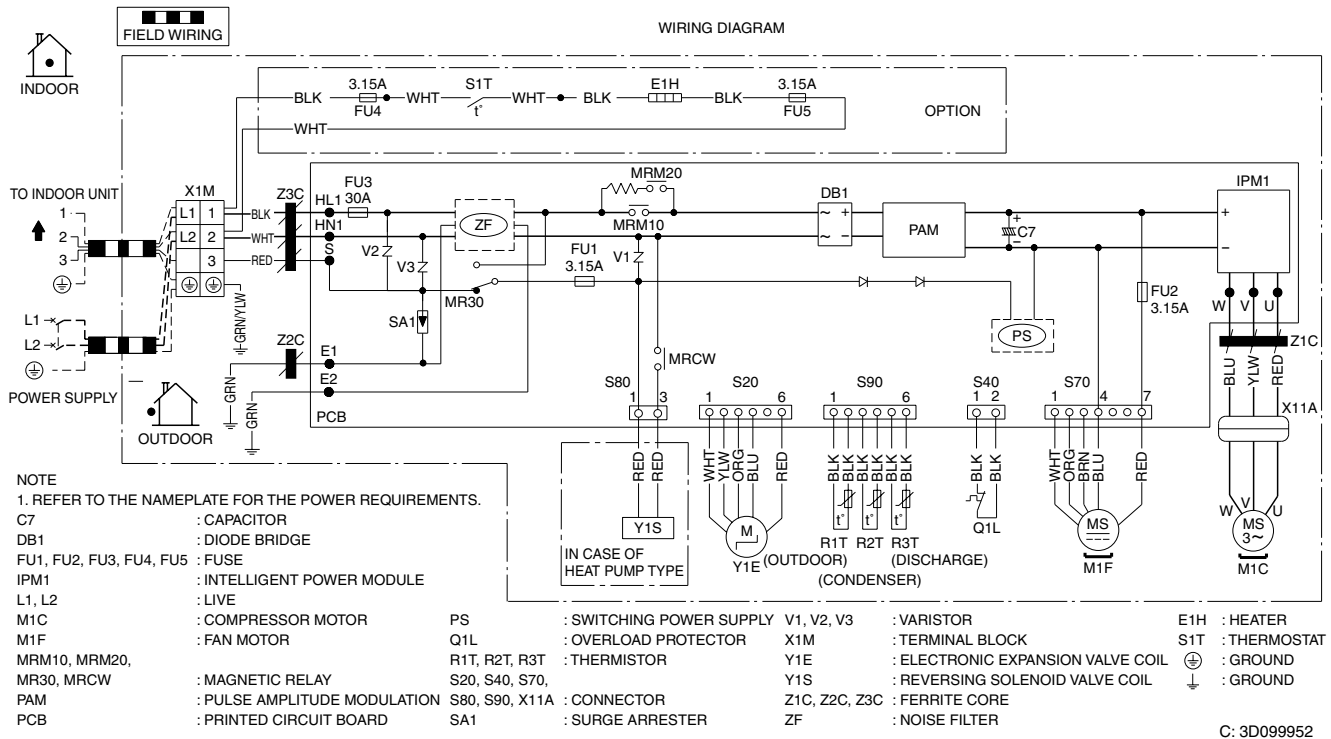

Note: PCB: Main PCB
 Refer to Part 3 for Printed Circuit Board Connector Wiring Diagram.

Revision History

Month / Year	Version	Revised contents
02 / 2016	SiUS091601E	First edition

Warning



- Daikin products are manufactured for export to numerous countries throughout the world. Prior to purchase, please confirm with your local authorized importer, distributor and/or retailer whether this product conforms to the applicable standards, and is suitable for use, in the region where the product will be used. This statement does not purport to exclude, restrict or modify the application of any local legislation.
- Ask a qualified installer or contractor to install this product. Do not try to install the product yourself. Improper installation can result in water or refrigerant leakage, electrical shock, fire or explosion.
- Use only those parts and accessories supplied or specified by Daikin. Ask a qualified installer or contractor to install those parts and accessories. Use of unauthorized parts and accessories or improper installation of parts and accessories can result in water or refrigerant leakage, electrical shock, fire or explosion.
- Read the user's manual carefully before using this product. The user's manual provides important safety instructions and warnings. Be sure to follow these instructions and warnings.

If you have any inquiries, please contact your local importer, distributor and/or retailer.

Cautions on product corrosion

1. Air conditioners should not be installed in areas where corrosive gases, such as acid gas or alkaline gas, are produced.
2. If the outdoor unit is to be installed close to the sea shore, direct exposure to the sea breeze should be avoided. If you need to install the outdoor unit close to the sea shore, contact your local distributor.

Dealer

© All rights reserved

● Specifications, designs and other content appearing in this brochure are current as of February 2016 but subject to change without notice.