

kränzle

MADE IN GERMANY



PRODUCT CATALOG

PRESSURE WASHERS | VACUUM CLEANERS | SWEEPERS



TABLE OF CONTENTS

Kränzle product innovations	4-5
Kränzle in-line RP pump	6-7
Kränzle new products	8-11
Key industries	12-13
Digital Product Advisor	14-15
Quality in every detail.....	16-17

COLD WATER PRESSURE WASHERS

COLD WATER - COMPACT

HD-Series	20-23
K 1154-Series	24-25
X-Series	26-27
K 2000-Series	28-29
Profi-Series	30-31

COLD WATER - POWERFUL

medium quadro-Series	34-35
large quadro-Series	36-37
Primus-Series	38-39
RP Primus-RP-Series	40-41
RP WS-RP-Series WSC-RP-Series	42-45
RP LX-RP-Series	46-47

PRESSURE WASHERS WITH COMBUSTION ENGINE

Profi-Jet-Series	50-53
B-Series	54-55

HOT WATER PRESSURE WASHERS

HOT WATER - OIL HEATED

RP therm-RP-Series	58-61
RP therm-RP-Series - black edition	62-63
therm 1017-Series	64-65
therm-C-Series	66-67
therm-CA-Series	68-69

PRESSURE WASHERS - ELECTRICALLY HEATED

i e-therm-Series	72-73
-------------------------------	-------

ACCESSORIES FOR PRESSURE WASHERS

i Accessories for plug-in system D12 - Complete	74-96
--	-------

PRESSURE WASHERS FOR PRIVATE USERS

Quickly-Series	100-101
K 1050-Series	102-103
Accessories for plug-in system D10	106

VACUUM CLEANERS

Ventos L-Series	110-111
Accessories for Ventos L-Series	112-113
Ventos 12-Series	114-115
Accessories for Ventos 12-Series	115

SWEEPERS

Colly 800	118-119
Kränzle 1+1	120-121

BETTER PERFECT

THAN CHEAP!

OUR CORPORATE VALUES

■ QUALITY

"Our goal is to consistently meet or exceed clearly defined standards in all areas of the company in order to provide our customers with consistently high quality."

■ FLEXIBILITY

"We are not closed to the challenges of the market and our customers. This openness allows us to respond flexibly and early to new requirements and to meet them within the limits of our resources."

■ INNOVATION

"To stand still is to go backwards. Through our own research and development, we want to continuously offer users added value in terms of performance, safety, handling and cost-effectiveness."

■ ENVIRONMENTAL AWARENESS

"From production to product. Through modern production, well thought-out logistics and sophisticated, durable products, we contribute to a conscious approach to the environment."

SALES AND SERVICE POINTS

In addition to first-class product quality, we also provide professional advice and offer a dedicated service, through our Kränzle partners worldwide.

GENERAL GUIDELINES

This product catalog is valid from 1st October 2025. All previous product catalogs are no longer valid. Technical changes and errors reserved. The general terms and conditions of **Josef Kränzle GmbH & Co. KG** apply.

kränzle

Josef Kränzle GmbH & Co. KG

Rudolf-Diesel-Straße 20
89257 Illertissen (Germany)
www.kraenzle.com

SALES

phone sales: +49 (0) 7303 96 05-250
fax: +49 (0) 7303 96 05-670
mail: sales@kraenzle.com

 [youtube.com/kraenzleDE](https://www.youtube.com/kraenzleDE)



K 1154 TST

The popular K 1152 has a worthy successor: with an operating pressure of 140 bar and its robust design, the new Kränzle K 1154 sets new standards in performance and durability. Whether for demanding private users or daily use in the craft, the K 1154 masters every cleaning task with flying colours. Compact, mobile and equipped with all the proven Kränzle features, it is your reliable partner for thorough cleanliness. Discover the next generation now!

page 24-25

Lance with pendulum nozzle

Discover our new pendulum nozzles in sizes 03 and 042. These complement our existing range (05, 07, 08 and 11). Thanks to the Coandă effect, the nozzle generates an oscillating spot jet that increases cleaning power. Pendulum nozzles work with a similar spray pattern to flat-jet nozzles, but offer a higher impact force that loosens and removes dirt in a single pass.

page 78-79



Stainless steel table

The stainless steel table was specially designed for the WS/WSC-RP-Series and is characterised by its high stability and durability. A particularly practical feature is that no holes need to be drilled in the wall, making installation quick and easy. Thanks to its rustproof stainless steel, the table is ideal for use in wet areas.

page 90-91



Ventos 12

For professional cleaning in hotels, offices, retail outlets or building cleaning: discover the new Ventos 12-Series! With the commercial dry vacuum cleaners in the Ventos 12-Series, you decide what is more important to you: uncompromising power or maximum efficiency. The Ventos 12 impresses with a powerful 900 W motor for maximum suction power, while the Ventos 12 HE with a 650 W motor offers impressive performance with lower power consumption.

page 114-115

Optimised for greater flexibility: therm-RP, LX-RP, WS-RP und WSC-RP

We have optimised our therm-RP, LX-RP, WS-RP and WSC-RP-Series high-pressure cleaners in the RP-1000 and RP-1200 performance classes. Thanks to a reduction in motor power from 6.3 kW to 5.5 kW, these models can now be operated with a 16A plug. As 16A connections are much more common than 32A connections, you can now use these devices more flexibly. Best of all, despite the lower motor power, the operating pressure and water volume remain unchanged.

page 42-45 (WS-RP, WSC-RP), 46-47 (LX-RP), 58-61 (therm-RP)



IN-LINE RP PUMPS

MAXIMUM PERFORMANCE AND RELIABILITY FOR PROFESSIONAL USE – MADE IN GERMANY

When it comes to professional high-pressure cleaning in agriculture, logistics, industry and construction, reliability is paramount. Our crankshaft pumps are the answer to the most demanding requirements. Developed and manufactured in Illertissen, they combine over 50 years of experience, expertise and innovative strength.

Every component is the result of our uncompromising quality standards, from the selection of first-class materials to sophisticated technology. Our pumps not only guarantee maximum efficiency and durability, but also the reliability you expect from a genuine quality product 'Made in Germany'.



DURABLE:

The pump head made of special brass and the robust ceramic plungers are wear-resistant and guarantee an exceptionally long service life even under extreme conditions. The generous oil housing ensures optimum lubrication and heat dissipation, which further increases the efficiency and reliability of the pump.

POWERFUL:

With a flow rate of 1000–1600 l/min, a Kränzle in-line RP pump enables fast and effective cleaning. Professional users benefit from shorter working times and first-class cleaning results.

FLEXIBLE:

The integrated pressure regulation allows for continuous adjustment of the operating pressure and water volume. This gives you full control over the cleaning process and allows for optimal adaptation to any surface and degree of soiling.

ECONOMICAL:

Time is money – especially in professional applications. Our pump is designed so that all wear parts are quickly and easily accessible. This significantly minimises maintenance time and reduces ongoing operating costs by keeping downtime to a minimum.

TECHNICAL SPECIFICATIONS:

MODEL		RP 1000	RP 1200	RP 1400	RP 1600
Operating pressure	bar MPa	30-200 3-20	30-190 3-19	30-170 3-17	30-150 3-15
Water output	l/min l/h	16.6 1000	20 1200	23.3 1400	26.7 1600
Admissible overpressure	bar MPa	220 22	210 21	190 19	170 17
Motor speed	Rpm	1400	1400	1400	1400

IN-LINE RP PUMPS ARE USED IN THE FOLLOWING SERIES:

- **WS-RP | WSC-RP** page 42-45
- **LX-RP** page 46-47
- **THERM-RP** page 58-61

QUALITY HAS A NAME – AND MANY FACES



For more than 50 years, Kränzle has stood for quality "Made in Germany". To achieve this, we combine our expertise and have always manufactured our high-pressure cleaners at our Illertissen site. We rely exclusively on high-quality materials, sophisticated technology and years of know-how.

And our values have not changed in 50 years. We are proud to say that Kränzle has stood for the highest quality, flexibility, innovation and environmental responsibility since the company was founded.

Committed to these values, our entire team, from the engineers in research and development to our employees in production and our specialists in logistics, sales and service, work together every day to meet the diverse requirements of the cleaning industry worldwide with innovations of the highest quality.

Over the past 50 years, the commitment of each and every team member to make our corporate philosophy a reality has made Kränzle one of the world's quality leaders for cleaning machines.



Kränzle can look back on a successful history that began long before the company was founded. It all began on the day in 1958 when company founder Josef Kränzle started his first job at the Wieland Werke in Vöhringen as a "Vesperholer" (He was responsible for lunch). After this probationary period, Kränzle began his apprenticeship as a lathe operator (today's cutting machine operator) and, after receiving his master's certificate, worked his way up to master craftsman before leaving the company in 1974.

During this time, as an apprentice, Josef Kränzle came into contact with the first steam cleaner, which was introduced into the company and subsequently improved by Oskar Ehrle. Josef Kränzle was responsible for the turned and milled parts, which allowed him to discover the secrets of the pump and combustion chamber functions at a very early stage and to develop his passion for this technology.

It is therefore not surprising that Josef Kränzle founded his first own company, Josef Kränzle Armaturenbau in Illertissen, on September 1, 1974, after leaving Wieland Werke. This was the beginning of a success story.



MILESTONES:

1974 Foundation of Josef Kränzle Armaturenbau e.K.



In 1974, Josef Kränzle founded Kränzle Armaturenbau e.K. in his own garage with the aim of manufacturing high-quality high-pressure cleaners for the cleaning market. The idea for this was born during his time at Wieland. Here he saw the first steam cleaner in action and was involved in the development of spray guns.

1978 New production facility at Rudolf-Diesel-Strasse in Illertissen



Due to the high quality accessory products such as spray guns and lances, the company quickly outgrew the garage and a new production facility was considered shortly after the company was founded. In 1978, the company moved to Rudolf-Diesel-Strasse in Illertissen. At this time, Kränzle was not yet producing under its own name, but was manufacturing for established companies in the industry.

1981 Production of the first own high-pressure pump



Kränzle is now known in the industry as a specialist for cold and hot water high pressure cleaners and offers a wide range of accessories.

In the same year, Kränzle manufactures its first own high-pressure pump. This was an important step towards the company's own high-pressure cleaner.

1984 Production of the first Kränzle mobile pressure washer and foundation of I. Kränzle GmbH



In 1984, the time had finally come. Kränzle produces the first mobile pressure washer and in the same year founds the sales company Ingrid Kränzle GmbH in Bielefeld. Two years later, the pressure washer was ready for series production. The first Kränzle high pressure cleaner is launched.

2001 Expansion with a new production and logistics site in Illertissen



After many successful years, numerous patents and new products such as the Kränzle therm hot water high-pressure cleaner, Kränzle expands and increases its capacities with the new production and logistics site in Siemensstraße in Illertissen.

2010 Change of name to Josef Kränzle GmbH & Co. KG and expansion of the management team



Kränzle Armaturenbau e.K. is renamed to Josef Kränzle GmbH & Co KG, as it is still known today. Ludwig Kränzle joins the management team and runs the company together with his father Josef Kränzle.

2013 New sites in Poland and Switzerland



In the course of internationalization and in order to be able to implement the brand strategy even more efficiently, Kränzle expands its locations. Kränzle opens its first international subsidiaries in Poland (Warsaw) and Switzerland (Bremgarten).

2017 Consolidation of production and sales at headquarters in Illertissen



In order to improve internal processes, efficiency and customer focus, the headquarters of Ingrid Kränzle GmbH will be relocated from Bielefeld to Illertissen in 2017. From now on, production and sales will be located at the same site.

2024 50th anniversary



The success story of Josef Kränzle GmbH & Co. KG now spans more than 50 years. During this time, the company has grown from its beginnings in a garage to become an international industry leader. Innovative ideas as well as wise investments and decisions have set the course for further successful years.

THE RIGHT KRÄNZLE FOR EVERY APPLICATION

The requirements for high-pressure cleaners, industrial hoovers and manual sweepers vary greatly from one industry to another. This is why Kränzle has developed a product range which, due to its breadth and depth, meets all requirements with ease.

Quality "Made in Germany". This is the claim and commitment for each of our product lines - from portable pressure washers, mobile pressure washers, pressure washers in cold and hot water versions and to stationary units.

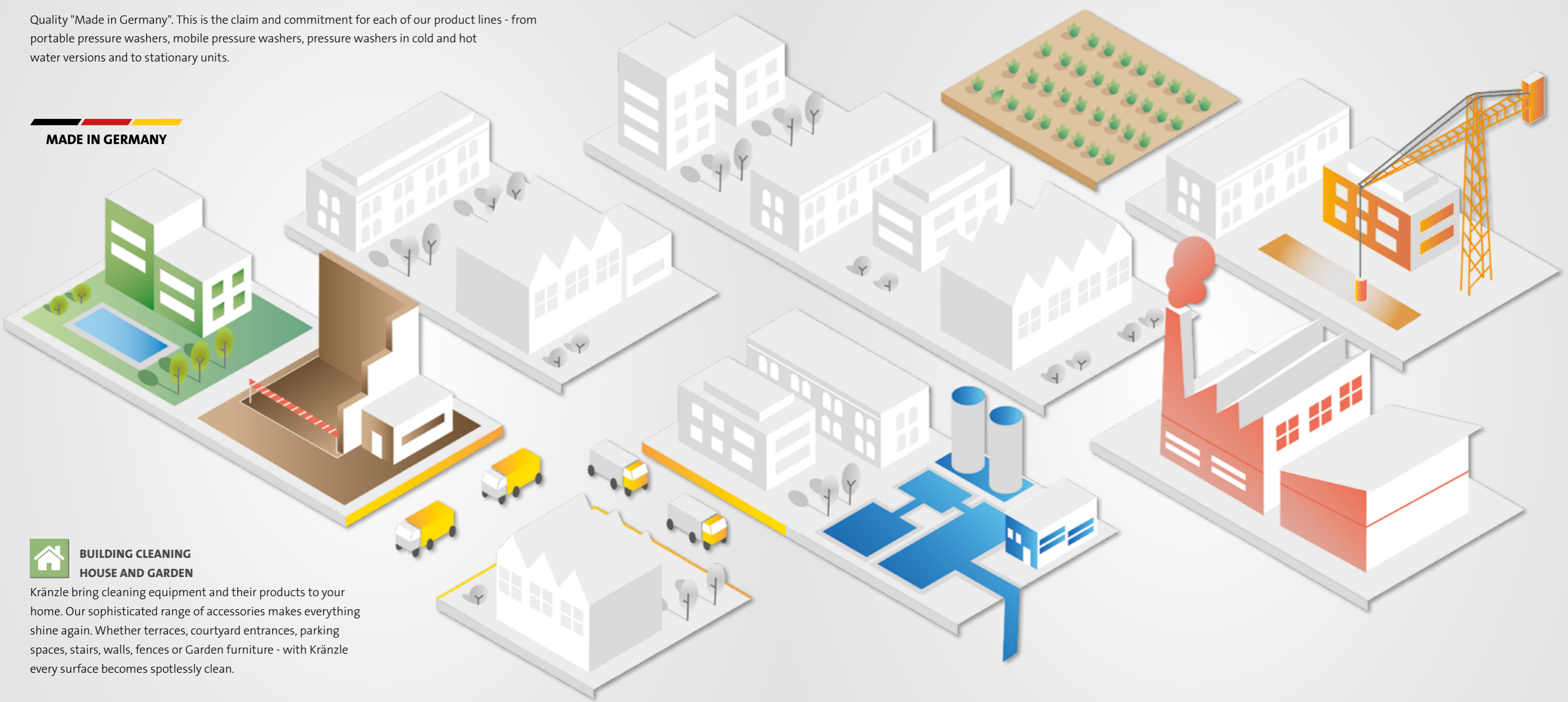

**AGRICULTURE
LIVESTOCK FARMING**

Cleanliness in agriculture and animal husbandry is a fundamental requirement for health, hygiene and good working conditions. Whether for the care of tractors and machines or for cleaning the stables and yards - a Kränzle pressure washer may be used.

**PUBLIC SERVICE
CONSTRUCTION**

The cleaning operations in the public service require professional non-compromising equipment. Kränzle high-pressure cleaners give the solution for the cleaning of construction vehicles, vans, public places or the Removal of graffiti on facades.

**BUILDING CLEANING
HOUSE AND GARDEN**

Kränzle bring cleaning equipment and their products to your home. Our sophisticated range of accessories makes everything shine again. Whether terraces, courtyard entrances, parking spaces, stairs, walls, fences or Garden furniture - with Kränzle every surface becomes spotlessly clean.

CRAFT

Craftspeople work in difficult and challenging conditions. Kränzle works continuously to develop and improve its products to meet these challenges.

**AUTOMOTIVE INDUSTRY
HAULAGE FIRMS**

Make your business shine! Whether your business is a car dealership, garage, valeting company, haulage or bus company, making a good first impression is important. Kränzle have an effective cleaning solution for whatever business requires.

**SANITARY
FOOD**

The Kränzle NoM versions (non-marking) are particularly suitable for use in hygiene and sanitary areas. White solid rubber tyres and grey high-pressure hoses leave no signs of abrasion, as required for these areas.

INDUSTRY

Premises and machines must be regularly inspected and dust, dirt and oil contamination removed. Kränzle offers high-quality cleaning machines with sophisticated accessories, which meet all the requirements of industrial companies.

WITH JUST A FEW CLICKS TO THE DESIRED PRODUCT

DIGITAL PRODUCT SELECTOR

Which pressure washer is best suited to the task at hand is often not obvious at first glance. Kränzle's newly developed digital product selector helps to determine one's own requirements such as intended use, frequency of use or desired cleaning power. A few details and you quickly and easily receive a product recommendation tailored to your individual needs.

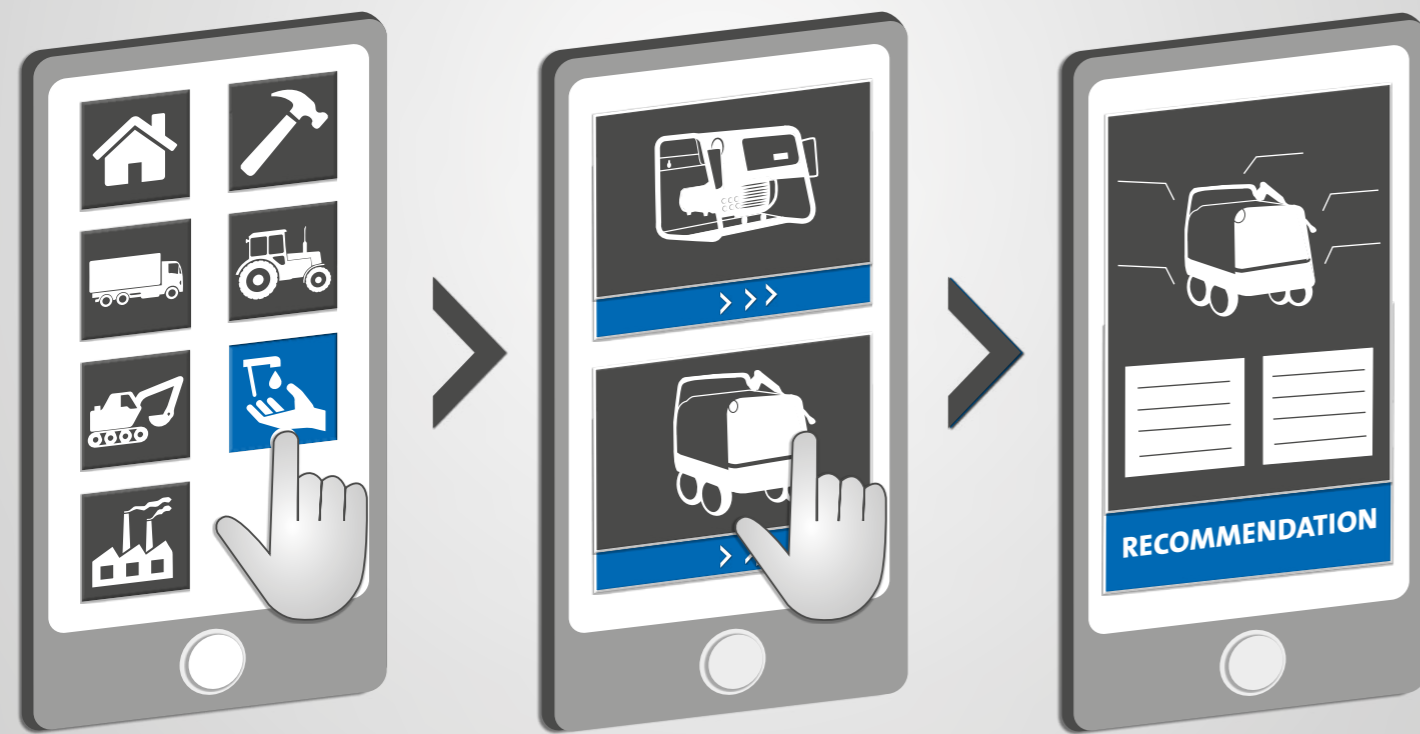

WITH JUST A FEW CLICKS

Intuitive and self-explanatory menu navigation saves time during the search.

AND QUESTIONS

Intended use, performance requirements and frequency of use determine product selection.

TO THE PERFECT RESULT

The right device and all the important technical data.



**FIND YOUR DESIRED
PRODUCT NOW**

Scan QR code

ADVANTAGES PRODUCT SELECTOR

- can also be used on smartphone and tablet
- no app download necessary
- smart and free product recommendation
- individual needs analysis
- technical data and product information included



**READY FOR
TOP PERFORMANCE
AT ANY TIME**

PRESSURE WASHERS - PROFESSIONAL

YOU CAN RELY ON KRÄNZLE

When you choose the Kränzle brand, you always get well-engineered high-pressure cleaners that convince all along the line. At our production site in Illertissen, southern Germany, every pressure washer is checked by hand before it leaves the factory. In this way, we guarantee users the highest quality, superior cleaning power and a particularly long service life.

THE KRÄNZLE PRODUCT ADVANTAGES

- high-quality materials and workmanship
- innovative design
- user-friendly handling
- environmentally conscious consumption
- extreme durability

MADE IN GERMANY

QUALITY "MADE IN GERMANY"

For us, quality already begins with product development, which is located at the Illertissen site. The production and quality control of almost all components also take place there.



QUICK RELEASE PLUG-IN SYSTEM

Sophisticated, fast and reliable: the quick release plug-in system with hardened stainless steel components ensures simple and always safe connection of the safety shut-off gun with the lance.



HEXAGONAL ANTI-ROTATION LOCK

Cleaning lances and accessories equipped with a hexagonal coupling can be locked against rotation in six different positions. This prevents the accessories from twisting unintentionally and allows them to be guided by moving the gun.



PRESSURE REGULATION | STAINLESS STEEL PRESSURE GAUGE

With all high-pressure cleaners (except the K 1050-Series), the working pressure and water quantity can be individually adjusted to the respective application. The large stainless steel pressure gauge provides a clear reading of the set working pressure. It contains a glycerine liquid that dampens possible fluctuations of the pointer.



SLOW RUNNING ELECTRIC MOTOR

Economical, quiet and durable: The particularly powerful high-pressure cleaners for continuous operation are equipped with a 4-pole electric motor. Its low speed of 1400 rpm reduces the starting current, thus ensuring less wear and noise.



TOTALSTOP SYSTEM | SAFETY SHUTDOWN

Energy consumption is reduced, service life increased: when closing off the high pressure gun, the motor switches off automatically, relieves the high-pressure pump and drive and reduces the noise level. If the pressure washer is accidentally not switched off, after 20 minutes it automatically goes into the safety shutdown by deactivating it.



HOSE REEL | TWIST-STOP SCREW CONNECTION

Models with hose reel allow for neat storage of the high-pressure hose. Prevents the high-pressure hose from twisting and tangling. Making operation much more user friendly.



ROTO-MOULD CHASSIS

The practically indestructible plastic housing gives the pressure washer additional stability. Motor and pump are well protected in the frame, securely shielded from external influences. The robust chassis ensures easy transport and high stability.



AXIAL PUMP | IN-LINE RP PUMP

The heart of every Kränzle pressure washer is the solid pump head made of forged special brass. Both tried and tested axial pump, which has been installed for decades, and the in-line RP pump introduced in 2018 for higher flushing performance, guarantee a long service life due to low-wear components.



WATER TANK

Always on the safe side: A float regulates the water inflow and prevents damage to the pump due to a lack of water.



DIRECT SUCTION WATER INLET

No water connection - no problem: high-pressure cleaners with a motor output of 1400 rpm offer the possibility of sucking water from separate containers or ponds due to the suction power of the high-pressure pumps.

INDESTRUCTIBLE, MOBILE & FAST TO HAND

'Can't be done? Not with us!' These cold water high-pressure cleaners impress with their versatility, long service life and practical mobility. Whether compact and portable (HD-Series) or space-saving with two wheels (K 1154-Series, X-Series, K 2000-Series, Profi-Series) – they inspire professionals and delight DIY enthusiasts in professional and semi-professional use. Kränzle provides a reliable, high-quality tool for every application.



TABLE OF CONTENTS

HD-Series	20-23
K 1154-Series	24-25
X-Series	26-27
K 2000-Series	28-29
Profi-Series	30-31
 Accessories for plug-in system D12	74-96

KEY INDUSTRIES



TECHNICAL HIGHLIGHTS



QUICK RELEASE PLUG-IN SYSTEM

Sophisticated, fast and reliable: the quick release plug-in system with hardened stainless steel components ensures simple and always safe connection of the safety shut-off gun with the lance.



TWIST-STOP SCREW CONNECTION

Go along with everything: provided with all machines: A special screw connection prevents the Twisting of the high-pressure hose during work and ensures so for consistent cleaning results in every situation.



PRESSURE REGULATION

Working pressure and water flow can be fully adjusted to suit the in all all high-pressure cleaners (with the exception of the K 1050-Series and Quickly).



TOTALSTOP SYSTEM

Energy consumption is reduced, service life is increased: when closing off the high pressure gun, the motor switches off automatically, relieves the high-pressure pump and drive and reduces the noise level.



COMPACT DESIGN

The perfect combination of form and function: the unique housing design of the Kränzle devices facilitates transport, and saves space.



OFF-ROAD CAPABILITY AND STABILITY

Goes over rough and smooth: the robust chassis makes it easier to transport and ensures high stability during use. Small Obstacles can be avoided thanks to the large wheels without any problems.

HD-Series

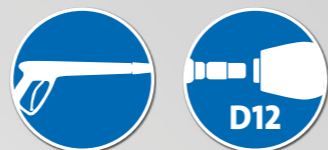

HD 7/122 TS | 600030

► **ACCESSORIES** | page 74-96



- Quick release plug-in system D12
- Kränzle axial pump
- Total-Stop system
- Stepless pressure regulation
- Direct suction: Suction height HD 7/122 TS: 1.5 m
- High-pressure hose with Twist-Stop screw connection



MODEL	HD 7/122 TS	HD 10/122 TS
Ord.no.	600030	600080

TECHNICAL SPECIFICATIONS

Operating pressure	bar MPa	30-120 3-12	30-120 3-12
Water output	l/min l/h	7 420	10 600
Admissible overpressure	bar MPa	135 13.5	135 13.5
Motor speed	Rpm	1400	2800
Connection	V ~ Hz A	230 1 50 7.5	230 1 50 11
Power intake Power output	kW	1.6 1.0	2.5 1.8
Power supply cable	m	5	5
Plug		Schuko	Schuko
Dimensions L x W x H	mm	440 200 330	440 200 330
Weight	kg	23	23

EQUIPMENT

High-pressure hose	m Ord.no.	10 (DN6) 43416	10 (DN6) 43416
Trigger gun with safety catch	Model Ord.no.	Starlet 4 12525	Starlet 4 12525
Lance with flat jet nozzle	Nozzle Ord.no.	● 028 12435-M20028	● 042 12435-M20042
Lance with Dirtkiller	Nozzle Ord.no.	● 028 12438-028	● 042 12438-042



HD-Series

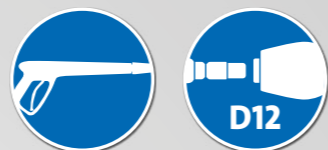

MODEL	HD 9/80 TS	HD 12/130 TS
Ord.no.	600130	600180

TECHNICAL SPECIFICATIONS

Operating pressure	bar MPa	30-80 3-8	30-130 3-13
Water output	l/min l/h	9 540	11 660
Admissible overpressure	bar MPa	90 9	145 14.5
Motor speed	Rpm	1400	1400
Connection	V ~ Hz A	230 1 50 7.5	230 1 50 13.5
Power intake Power output	kW	1.6 1.0	2.9 2.2
Power supply cable	m	5	5
Plug		Schuko	Schuko
Dimensions L x W x H	mm	470 230 320	500 240 320
Weight	kg	24	31

EQUIPMENT

High-pressure hose	m Ord.no.	10 (DN6) 43416	10 (DN6) 43416
Trigger gun with safety catch	Model Ord.no.	Starlet 4 12525	Starlet 4 12525
Lance with flat jet nozzle	Nozzle Ord.no.	● 042 12435-M20042	● 042 12435-M20042
Lance with Dirtkiller	Nozzle Ord.no.	● 042 12438-042	● 042 12438-042

► ACCESSORIES | page 74-96



EQUIPMENT

- Quick release plug-in system D12
- Kränzle axial pump
- Total-Stop system
- Stepless pressure regulation
- Direct suction: Suction height HD 9/80 TS: 1.5 m | HD 12/130 TS: 2.5 m
- High-pressure hose with Twist-Stop screw connection



K 1154-Series

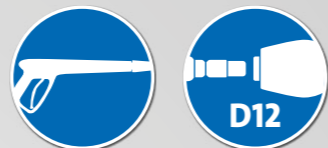

NEW

CONVENIENT INTEGRATED HOSE REEL (TST)

space-saving storage of the high-pressure hose with twist stop screw connection

NON-SLIP RUBBER GRIP
for a secure hold

ROBUST CHASSIS
practically indestructible plastic housing

STAINLESS STEEL PRESSURE GAUGE
easy reading of the working pressure

OFF-ROAD CAPABILITY AND STABILITY
robust chassis for easy transport and high stability

ACCESSORY STORAGE

neat storage for high pressure gun and lances



K 1154 TST | 602050

► **ACCESSORIES** | page 74-96



EQUIPMENT

- Quick release plug-in system D12
- Kränzle axial pump
- Total-Stop system
- Stepless pressure regulation
- High-pressure hose with Twist-Stop screw connection



VARIANT - NON-MARKING

NOM conversion kit Ord.no. **42251**

For further information on NON-Marking please refer to page 75

MODEL	K 1154 TST	NEW
Ord.no. TST incl. hose drum	602050	

TECHNICAL SPECIFICATIONS

Operating pressure	bar MPa	30-140 3-14
Water output	l/min l/h	10 600
Admissible overpressure	bar MPa	160 16
Motor speed	Rpm	2800
Connection	V ~ Hz A	230 1 50 12.8
Power intake Power output	kW	2.95 2.2
Power supply cable	m	5
Plug		Schuko
Dimensions L x W x H	mm	470 360 875
Weight	kg	33

EQUIPMENT

High-pressure hose	m Ord.no.	15 (DN6) 48015
Trigger gun with safety catch	Model Ord.no.	Starlet 4 12525
Lance with flat jet nozzle	Nozzle Ord.no.	● 042 12435-M20042
Lance with Dirtkiller	Nozzle Ord.no.	● 042 12438-042

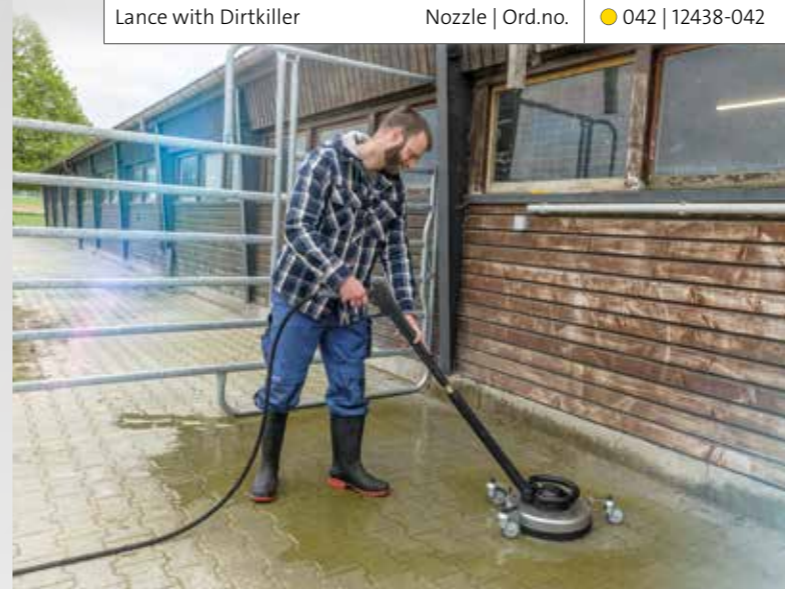

X-Series

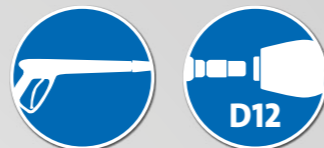

ACCESSORY BOX
integrated holder for practical storage of Kränzle foam lances

CONVENIENT INTEGRATED HOSE REEL (TST)
space-saving storage of the high-pressure hose with twist stop screw connection

STAINLESS STEEL PRESSURE GAUGE
easy reading of the working pressure

OFF-ROAD CAPABILITY AND STABILITY
robust chassis for easy transport and high stability

ACCESSORY STORAGE
neat storage for high pressure gun and lances

ELECTRIC MOTOR - 1400 RPM, 4-POLE
slower motor RPMs last longer, run quieter and allow for better in-let suction capabilities (X 8/150 TST)

X 8/150 TST | 603600

► **ACCESSORIES** | page 74-96



EQUIPMENT

- Quick release plug-in system D12
- Kränzle axial pump
- Total-Stop system
- Stepless pressure regulation
- High-pressure hose with Twist-Stop screw connection



MODEL	X 8/150 TST	X 10/140 TST
Ord.no. TST incl. hose drum	603600	603610

TECHNICAL SPECIFICATIONS

Operating pressure	bar MPa	30-150 3-15	30-140 3-14
Water output	l/min l/h	8 480	10 600
Admissible overpressure	bar MPa	170 17	160 16
Motor speed	Rpm	1400	2800
Connection	V ~ Hz A	230 1 50 9.8	230 1 50 12.8
Power intake Power output	kW	2.25 1.7	2.95 2.2
Power supply cable	m	5	5
Plug		Schuko	Schuko
Dimensions L x W x H	mm	470 360 875	470 360 875
Weight	kg	33	33

EQUIPMENT

High-pressure hose	m Ord.no.	15 (DN6) 498000	15 (DN6) 498000
Trigger gun with safety catch	Model Ord.no.	Starlet 4 12525	Starlet 4 12525
Lance with flat jet nozzle	Nozzle Ord.no.	○ 03 12435-M2003	● 042 12435-M20042
Lance with Dirtkiller	Nozzle Ord.no.	○ 03 12438-03	● 042 12438-042



K 2000-Series

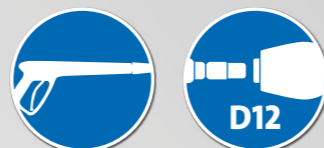

CONVENIENT INTEGRATED HOSE REEL (TST)
space-saving storage of the high-pressure hose with twist stop screw connection

ROTO-MOULD CHASSIS
practically indestructible plastic housing

STAINLESS STEEL PRESSURE GAUGE
easy reading of the working pressure

ACCESSORY STORAGE
neat storage for high pressure gun and lances

OFF-ROAD CAPABILITY AND STABILITY
robust chassis for easy transport and high stability

K 2160 TST | 604020

► **ACCESSORIES** | page 74-96



EQUIPMENT

- Quick release plug-in system D12
- Kränzle axial pump
- Total-Stop system
- Stepless pressure regulation
- Direct suction: Suction height 2.5 m
- High-pressure hose with Twist-Stop screw connection



42251

VARIANT - NON-MARKING

NOM conversion kit Version without drum	Ord.no.	42250
NOM conversion kit Version with drum	Ord.no.	42251
K 2160 TST NOM ex works	Ord.no.	604030

For further information on NON-Marking please refer to page 75

MODEL	K 2160 TS K 2160 TST	K 2195 TS K 2195 TST	K 2175 TS K 2175 TST
Ord.no. TS without hose drum	604010	604050	604110
Ord.no. TST incl. hose drum	604020	604060	604120

TECHNICAL SPECIFICATIONS

Operating pressure	bar MPa	30-140 3-14	30-170 3-17	30-160 3-16
Water output	l/min l/h	11 660	8 480	12 720
Admissible overpressure	bar MPa	160 16	195 19.5	175 17.5
Motor speed	Rpm	1400	1400	1400
Connection	V ~ Hz A	230 1 50 14	230 1 50 14	400 3 50 6.7
Power intake Power output	kW	3.2 2.4	3.2 2.4	3.3 2.6
Power supply cable	m	5	5	5
Plug		Schuko	Schuko	CEE 16 A
Dimensions L x W x H	mm	375 360 900	375 360 900	375 360 900
Weight without incl. hose drum	kg	39 40	39 40	39 40

EQUIPMENT

High-pressure hose TS without hose drum	m Ord.no.	10 (DN6) 43416	10 (DN6) 43416	10 (DN6) 43416
High-pressure hose TST incl. hose drum	m Ord.no.	15 (DN6) 48015	15 (DN6) 48015	15 (DN6) 48015
Trigger gun with safety catch	Model Ord.no.	Starlet 4 12525	Starlet 4 12525	Starlet 4 12525
Lance with Vario-Jet Duo	Nozzle Ord.no.	● 042 12433-042	○ 03 12433-03	● 042 12433-042
Lance with Dirtkiller	Nozzle Ord.no.	● 042 12438-042	○ 03 12438-03	● 042 12438-042



Profi-Series

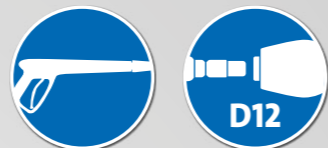

ROTO-MOULD CHASSIS
practically indestructible plastic housing

CONVENIENT INTEGRATED HOSE REEL (TST)
space-saving storage of the high-pressure hose with twist stop screw connection

ELECTRIC MOTOR - 1400 RPM, 4-POLE
slower motor RPMs last longer, run quieter and allow for better in-let suction capabilities

STAINLESS STEEL PRESSURE GAUGE
easy reading of the working pressure

ACCESSORY STORAGE
neat storage for high pressure gun and lances

OFF-ROAD CAPABILITY AND STABILITY
robust chassis for easy transport and high stability



Profi 160 TST | 606000

► **ACCESSORIES** | page 74-96



EQUIPMENT

- Quick release plug-in system D12
- Kränzle axial pump
- Total-Stop system
- Stepless pressure regulation

- Optional: Internal Water Tank can be supplied upon request
- Direct suction: Suction height 2.5 m
- High-pressure hose with Twist-Stop screw connection



VARIANT - NON-MARKING

NOM conversion kit Ord.no. **42260**

For further information on NON-Marking please refer to page 75

MODEL	Profi 160 TST	Profi 195 TST	Profi 175 TST
Ord.no. TST incl. hose drum	606000	606010	606100

TECHNICAL SPECIFICATIONS

Operating pressure	bar MPa	30-140 3-14	30-170 3-17	30-150 3-15
Water output	l/min l/h	11 660	8 480	12 720
Admissible overpressure	bar MPa	160 16	195 19.5	175 17.5
Motor speed	Rpm	1400	1400	1400
Connection	V ~ Hz A	230 1 50 14.3	230 1 50 14.3	400 3 50 7.2
Power intake Power output	kW	3.2 2.5	3.2 2.5	3.8 3.0
Power supply cable	m	5	5	5
Plug		Schuko	Schuko	CEE 16 A
Dimensions L x W x H	mm	355 375 980	355 375 980	355 375 980
Weight	kg	45	45	45

EQUIPMENT

High-pressure hose	m Ord.no.	15 (DN6) 43829	15 (DN6) 43829	15 (DN6) 43829
Trigger gun with safety catch	Model Ord.no.	Starlet 4 12525	Starlet 4 12525	Starlet 4 12525
Lance with flat-jet nozzle	Nozzle Ord.no.	● 042 12435-M20042	○ 03 12435-M2003	● 042 12435-M20042
Lance with Dirtkiller	Nozzle Ord.no.	● 042 12438-042	○ 03 12438-03	● 042 12438-042



Water tank

EXPERT TIP

Prevents damage to the high-pressure pump in case of water shortage

- Volume 1.3 liters
- Simple, tool-free assembly

Ord.no. **43860**

COLD WATER PRESSURE WASHERS - ESPECIALLY POWERFUL DEVICES

SOVEREIGN HIGH-PERFORMANCE MACHINES WITH INNOVATIVE TECHNOLOGY



They take on any challenge: In agriculture or animal husbandry, on the construction site or in industry: with up to 250 bar working pressure, these professional machines get to work powerfully everywhere, even in continuous use. In daily use, they quickly prove to be indispensable tools.

RP Pressure washers with in-line RP pump:

To achieve perfect cleanliness, a particularly high flushing effect is often required. The Kränzle high-pressure cleaners with innovative in-line RP pump achieve a water output of up to 1600 l/h and meet even the highest demands efficiently and effortlessly. Even the most stubborn dirt is removed in no time at all.

TABLE OF CONTENTS

medium quadro-Series	34-35
large quadro-Series	36-37
Primus-Series	38-39
RP Primus-RP-Series	40-41
RP WS-RP-Series WSC-RP-Series	42-45
RP LX-RP-Series	46-47
RP Accessories for plug-in system D12	74-96

KEY INDUSTRIES



TECHNICAL HIGHLIGHTS



QUICK RELEASE PLUG-IN SYSTEM

Sophisticated, fast and reliable: the quick release plug-in system with hardened stainless steel components ensures simple and always safe connection of the safety shut-off gun with the lance.



OFF-ROAD CAPABILITY AND STABILITY

Goes over rough and smooth: the robust chassis makes it easier to transport and ensures high stability during use. Small obstacles can be avoided thanks to the large wheels without any problems.



INTEGRATED HOSE REEL

Space-saving and convenient: with a folding crank handle for practical, neat storage of the high-pressure hose. A special locking device holds the reel in the desired position.



WATER TANK

Always on the safe side: A float regulates the water inflow and prevents damage to the pump due to a lack of water.



INNOVATIVE IN-LINE RP PUMP

Proven technology convincingly enhanced: a Crankshaft moves the plungers in line via connecting rods the in-line pump. This special design enables even greater water flow with significantly higher washing effect than conventional pumps and ensures impressive properties:

- Power transmission as with a car engine via stable crankshaft, connecting rod and plunger
- extremely long service life
- integrated unloader valve
- Total-stop system with delayed engine shutdown

medium quadro-Series



WATER TANK
helps prevent damage to the device in case of water shortage

ROTO-MOULD CHASSIS
practically indestructible plastic housing

CONVENIENT INTEGRATED HOSE REEL (TST)
space-saving storage of the high-pressure hose with twist stop screw connection

ACCESSORY STORAGE
neat storage for high pressure gun and lances

STAINLESS STEEL PRESSURE GAUGE
easy reading of the working pressure

IMPACT PROTECTION
reduces accidental damage to the high-pressure pump

quadro 899 TST | 610120

► **ACCESSORIES** | page 74-96



EQUIPMENT

Quick release plug-in system D12

- Kränzle axial pump
- Total-stop system with delayed motor cut-off
- Safety shutdown
- Stepless pressure regulation

- High-pressure hose with Twist-Stop screw connection
- Cleaning Agent Intake
- Locking brake
- Water tank: Volume 10 liters



VARIANT - NON-MARKING

42272

NOM conversion kit	Ord.no.	42272
NOM conversion kit quadro 899 TST	Ord.no.	42271
quadro 799 TST NOM ex works	Ord.no.	610110

For further information on NON-Marking please refer to page 75

MODEL	quadro 599 TST	quadro 799 TST	quadro 899 TST
Ord.no. TST incl. hose drum	610000	610100	610120

TECHNICAL SPECIFICATIONS

Operating pressure	bar MPa	30-150 3-15	30-180 3-18	30-150 3-15
Water output	l/min l/h	10 600	13 780	15 900
Admissible overpressure	bar MPa	165 16.5	200 20	170 17
Motor speed	Rpm	1400	1400	1400
Connection	V ~ Hz A	230 1 50 14	400 3 50 8.5	400 3 50 8.5
Power intake Power output	kW	3.3 2.4	5.5 4.0	5.5 4.0
Power supply cable	m	5	7.5	7.5
Plug		Schuko	CEE 16 A	CEE 16 A
Dimensions L x W x H	mm	780 395 870	780 395 870	780 395 870
Weight	kg	63	63	63

EQUIPMENT

High-pressure hose	m Ord.no.	20 (DN6) 434161	20 (DN6) 434161	15 (DN8) 44879
Trigger gun with safety catch	Model Ord.no.	Starlet 3 12500	Starlet 3 12500	Starlet 3 12500
Lance with flat-jet nozzle	Nozzle Ord.no.	● 035 12420-D25035	● 045 12420-D25045	● 06 12420-D2506
Lance with Dirtkiller	Nozzle Ord.no.	● 035 12425-035	● 045 12425-045	● 06 12425-06



large quadro-Series



CONVENIENT INTEGRATED HOSE REEL (TST)
space-saving storage of the high-pressure hose with twist stop screw connection

ACCESSORY STORAGE
neat storage for high pressure gun and lances

STAINLESS STEEL PRESSURE GAUGE
easy reading of the working pressure

WATER TANK
helps prevent damage to the device in case of water shortage

STAINLESS STEEL CHASSIS
durable and corrosion resistant

IMPACT PROTECTION
reduces accidental damage to the high-pressure pump

quadro 1200 TST | 612120

► **ACCESSORIES** | page 74-96



EQUIPMENT

- Quick release plug-in system D12
- Kränzle axial pump
- Total-stop system with delayed motor cut-off
- Safety shutdown
- Stepless pressure regulation

- High-pressure hose with Twist-Stop screw connection
- Cleaning Agent Intake
- Stainless steel undercarriage
- Locking brake
- Water tank: Volume 12 liters



VARIANT - NON-MARKING

42280

NOM conversion kit Version without drum	Ord.no.	42280
NOM conversion kit Version with drum	Ord.no.	42282
quadro 1200 TST NOM ex works	Ord.no.	612130

For further information on NON-Marking please refer to page 75

MODEL	quadro 800 TST	quadro 1000 TS quadro 1000 TST	quadro 1200 TS quadro 1200 TST
Ord.no. TS without hose drum	–	612080	612110
Ord.no. TST incl. hose drum	612060	612090	612120

TECHNICAL SPECIFICATIONS

Operating pressure	bar MPa	30-250 3-25	30-220 3-22	30-180 3-18
Water output	l/min l/h	13.3 800	16 960	19 1140
Admissible overpressure	bar MPa	270 27	250 25	200 20
Motor speed	Rpm	1400	1400	1400
Connection	V ~ Hz A	400 3 50 12	400 3 50 12	400 3 50 12
Power intake Power output	kW	7.5 5.5	7.5 5.5	7.5 5.5
Power supply cable	m	7.5	7.5	7.5
Plug		CEE 16 A	CEE 16 A	CEE 16 A
Dimensions L x W x H	mm	770 570 990	770 570 990	770 570 990
Weight without incl. hose drum	kg	– 89	83 89	83 89

EQUIPMENT

High-pressure hose TS without hose drum	m Ord.no.	–	10 (DN8) 41081	10 (DN8) 41081
High-pressure hose TST incl. hose drum	m Ord.no.	20 (DN8) 41083	20 (DN8) 41083	20 (DN8) 41083
Trigger gun with safety catch	Model Ord.no.	Starlet 3 12500	Starlet 3 12500	Starlet 3 12500
Lance with flat-jet nozzle	Nozzle Ord.no.	● 04 12420-D2504	● 05 12420-D2505	● 07 12420-D2507
Lance with Turbokiller (**for TST series only)	Nozzle Ord.no.	● 04 12430-04 **	● 05 12430-05 **	● 07 12430-07 **



Primus-Series



ACCESSORY STORAGE
neat storage for high pressure gun and lances

ROLL-ON AND ROLL-OFF AID
Enables effortless rolling up and unrolling of the high-pressure hose

STAINLESS STEEL PRESSURE GAUGE
easy reading of the working pressure

IMPACT PROTECTION
reduces accidental damage to the high-pressure pump

CONVENIENT INTEGRATED HOSE REEL (TST)
space-saving storage of the high-pressure hose with twist stop screw connection

ROTO-MOULD CHASSIS
practically indestructible plastic housing

Primus 1000 TST | 614150

► **ACCESSORIES** | page 74-96



- EQUIPMENT**
- Quick release plug-in system D12
 - Kränzle axial pump
 - Total-stop system with delayed motor cut-off
 - Safety shutdown
 - Stepless pressure regulation
 - High-pressure hose with Twist-Stop screw connection



AUTOMATIC HOSE REEL
automatic hose retraction with Twist-Stop screw connection (Primus 1000 TS AT + Primus 1200 TS AT)



VARIANT - NON-MARKING

NOM conversion kit	Ord.no.	42284
---------------------------	---------	--------------

For further information on NON-Marking please refer to page 75

MODEL	Primus 1000 TST	Primus 1000 TS AT	Primus 1200 TST	Primus 1200 TS AT
Ord.no. TST incl. hose drum	614150	–	614160	–
Ord.no. TST incl. automatic hose reel	–	614155	–	614165

TECHNICAL SPECIFICATIONS

Operating pressure	bar MPa	30-220 3-22	30-220 3-22	30-180 3-18	30-180 3-18
Water output	l/min l/h	16.6 1000	16.6 1000	20 1200	20 1200
Admissible overpressure	bar MPa	250 25	250 25	200 20	200 20
Motor speed	Rpm	1400	1400	1400	1400
Connection	V ~ Hz A	400 3 50 11.4	400 3 50 11.4	400 3 50 11.4	400 3 50 11.4
Power intake Power output	kW	7.5 5.5	7.5 5.5	7.5 5.5	7.5 5.5
Power supply cable	m	7.5	7.5	7.5	7.5
Plug		CEE 16 A	CEE 16 A	CEE 16 A	CEE 16 A
Dimensions L x W x H	mm	640 515 985	640 515 1100	640 515 985	640 515 1100
Weight	kg	75	88	75	88

EQUIPMENT

High-pressure hose	m Ord.no.	20 (DN8) 443812	20 (DN8) 410832	20 (DN8) 443812	20 (DN8) 410832
Trigger gun with safety catch	Model Ord.no.	Starlet 3 12500	Starlet 3 12500	Starlet 3 12500	Starlet 3 12500
Lance with flat-jet nozzle	Nozzle Ord.no.	● 05 12420-D2505	● 05 12420-D2505	● 07 12420-D2507	● 07 12420-D2507



Primus-RP-Series



NEW

ACCESSORY STORAGE

neat storage for high pressure gun and lances

CONVENIENT INTEGRATED HOSE REEL (TST)

space-saving storage of the high-pressure hose with twist stop screw connection

ROLL-ON AND ROLL-OFF AID

Enables effortless rolling up and unrolling of the high-pressure hose

ROTO-MOULD CHASSIS
practically indestructible plastic housing

STAINLESS STEEL PRESSURE GAUGE
easy reading of the working pressure

IMPACT PROTECTION
reduces accidental damage to the high-pressure pump



Primus-RP 900 TST | 614140

► **ACCESSORIES** | page 74-96



EQUIPMENT

- Quick release plug-in system D12
- Kränzle in-line RP pump
 - Total-stop system with delayed motor cut-off
 - Safety shutdown
 - Stepless pressure regulation
 - High-pressure hose with Twist-Stop screw connection



MODEL	Primus-RP 900 TST	NEW
Ord.no. TST incl. hose drum	614140	

TECHNICAL SPECIFICATIONS

Operating pressure	bar MPa	30-170 3-17
Water output	l/min l/h	15 900
Admissible overpressure	bar MPa	190 19
Motor speed	Rpm	1400
Connection	V ~ Hz A	400 3 50 9.4
Power intake Power output	kW	5.5 4.0
Power supply cable	m	7.5
Plug		CEE 16 A
Dimensions L x W x H	mm	600 465 995
Weight	kg	59

EQUIPMENT

High-pressure hose	m Ord.no.	20 (DN8) 443812
Trigger gun with safety catch	Model Ord.no.	Starlet 3 12500
Lance with flat-jet nozzle	Nozzle Ord.no.	● 055 12420-D25055



WS-RP-Series | WSC-RP-Series



WS-RP 1200 TS | 622120
WSC-RP 1200 TS | 622130

► **ACCESSORIES** | page 74-96



EQUIPMENT

- Quick release plug-in system D12
- Kränzle in-line RP pump
- Standing device and wall unit
- Total-stop system with delayed motor cut-off

- Safety shutdown
- Stepless pressure regulation
- Stainless-steel housing (WSC-RP)
- High-pressure hose with Twist-Stop screw connection



Conversion kit - flow monitor

For leakage protection in the pipe network. Suitable for non-monitored areas.

Ord.no.	126342
Flow rate	l/min 4



MODEL	WS-RP 1000 TS WSC-RP 1000 TS	WS-RP 1200 TS WSC-RP 1200 TS	WS-RP 1400 TS WSC-RP 1400 TS	WS-RP 1600 TS WSC-RP 1600 TS
Ord.no. <u>WS</u> without cover	622102	622122	622140	622160
Ord.no. <u>WSC</u> with cover	622112	622132	622150	622170

TECHNICAL SPECIFICATIONS

Operating pressure	bar MPa	30-200 3-20	30-190 3-19	30-170 3-17	30-150 3-15
Water output	l/min l/h	16.6 1000	20 1200	23.3 1400	26.7 1600
Admissible overpressure	bar MPa	220 22	210 21	190 19	170 17
Motor speed	Rpm	1400	1400	1400	1400
Connection	V ~ Hz A	400 3 50 13.5	400 3 50 14.3	400 3 50 14.3	400 3 50 14.3
Power intake Power output	kW	7.5 5.5	7.5 5.5	8.0 6.3	8.0 6.3
Power supply cable	m	7.5	7.5	7.5	7.5
Plug		NEW CEE 16 A	NEW CEE 16 A	CEE 32 A	CEE 32 A
Dimensions L x W x H	mm	670 430 510	670 430 510	670 430 510	670 430 510
Weight without with cover	kg	62 65	62 65	62 65	62 65

EQUIPMENT

High-pressure hose	m Ord.no.	10 (DN8) 41081	10 (DN8) 41081	10 (DN8) 41081	10 (DN8) 41081
Trigger gun with safety catch	Model Ord.no.	Starlet 3 12500	Starlet 3 12500	Starlet 3 12500	Starlet 3 12500
Lance with flat-jet nozzle	Nozzle Ord.no.	05 12420-D2505	065 12420-D25065	08 12420-D2508	11 12420-D2511

NEW **EXPERT TIP**



Wall holder-WS/WSC **EXPERT TIP**

Ord.no.	483006
----------------	---------------

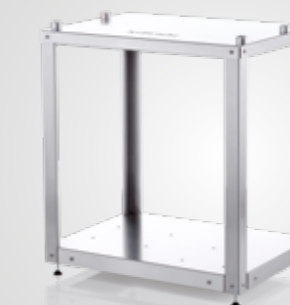

STAINLESS STEEL TABLE

The stainless steel table was specially developed for our WS/WSC-RP devices. It offers high stability, comfort and flexibility without the need for time-consuming drilling into the wall.

Ord.no.: 16206

More information on page 90-91

WS-RP-Series | WSC-RP-Series

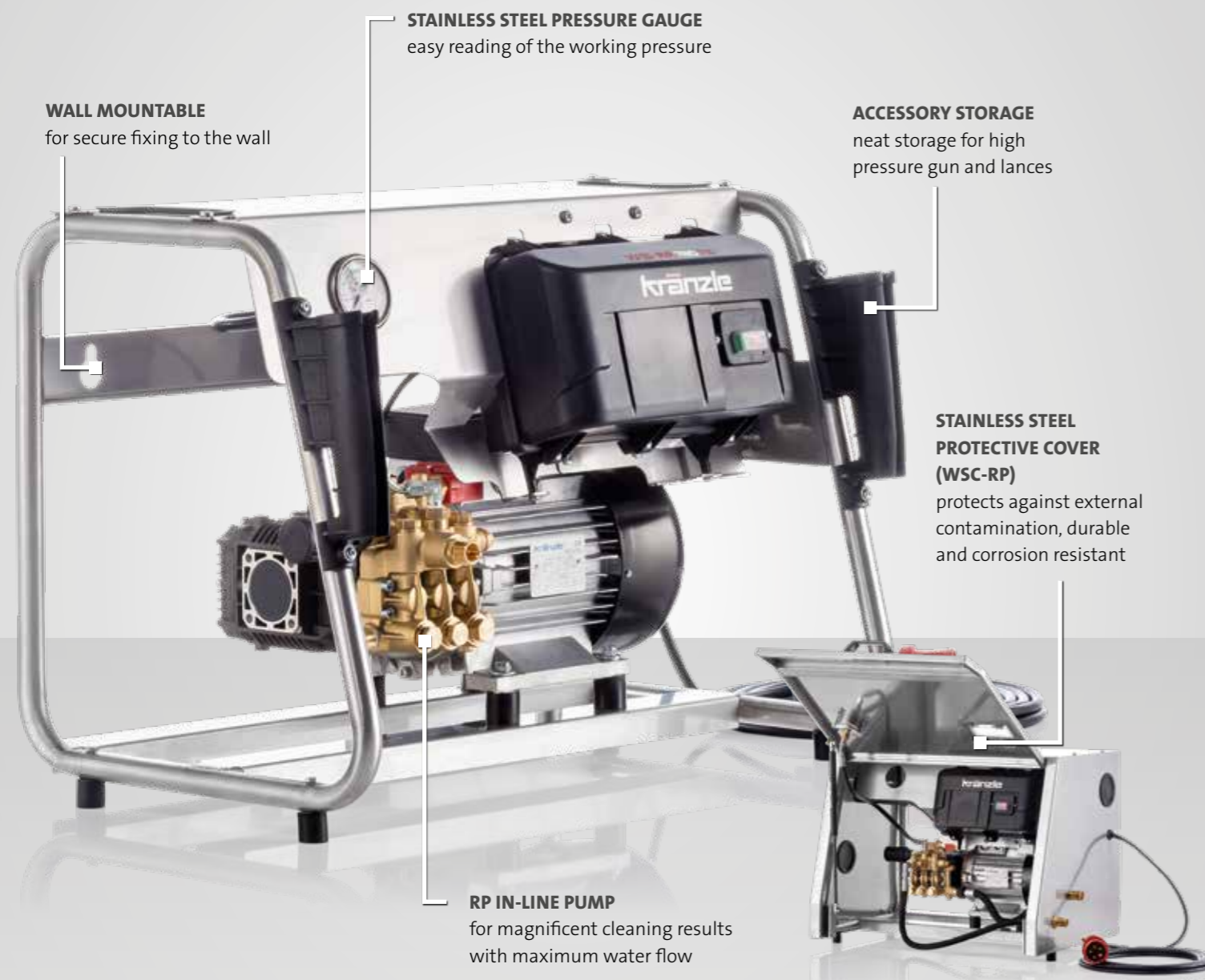

WS-RP 780 TS | 622060
WSC-RP 780 TS | 622070

► **ACCESSORIES** | page 74-96



EQUIPMENT

- Quick release plug-in system D12
- Kränzle in-line RP pump
- Standing device and wall unit
- Total-stop system with delayed motor cut-off

- Safety shutdown
- Stepless pressure regulation
- Stainless-steel housing (WSC-RP)
- High-pressure hose with Twist-Stop screw connection



Conversion kit - flow monitor

For leakage protection in the pipe network. Suitable for non-monitored areas.

Ord.no.	126342
Flow rate	l/min 4



MODEL	WS-RP 780 TS WSC-RP 780 TS	WS-RP 900 TS WSC-RP 900 TS
Ord.no. <u>WS</u> without cover	622060	622080
Ord.no. <u>WSC</u> with cover	622070	622090

TECHNICAL SPECIFICATIONS

Operating pressure	bar MPa	30-150 3-15	30-180 3-18
Water output	l/min l/h	13 780	15 900
Admissible overpressure	bar MPa	170 17	200 20
Motor speed	Rpm	1400	1400
Connection	V ~ Hz A	400 3 50 8.0	400 3 50 9.4
Power intake Power output	kW	5.5 4.0	5.5 4.0
Power supply cable	m	7.5	7.5
Plug		CEE 16 A	CEE 16 A
Dimensions L x W x H	mm	670 430 510	670 430 510
Weight without with cover	kg	52 55	52 55

EQUIPMENT

High-pressure hose	m Ord.no.	10 (DN8) 41081	10 (DN8) 41081
Trigger gun with safety catch	Model Ord.no.	Starlet 3 12500	Starlet 3 12500
Lance with flat-jet nozzle	Nozzle Ord.no.	● 05 12420-D2505	● 05 12420-D2505

NEW EXPERT TIP



Wall holder-WS/WSC EXPERT TIP

Ord.no.	483006
----------------	---------------

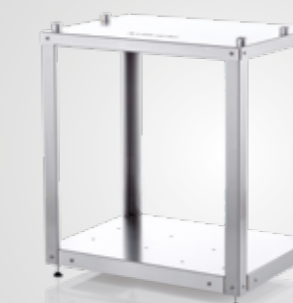

STAINLESS STEEL TABLE

The stainless steel table was specially developed for our WS/WSC-RP devices. It offers high stability, comfort and flexibility without the need for time-consuming drilling into the wall.

Ord.no.: 16206

More information on page 90-91

LX-RP-Series



STAINLESS STEEL PRESSURE GAUGE
easy reading of the working pressure

RP IN-LINE PUMP
for magnificent cleaning results with maximum water flow

CONVENIENT INTEGRATED HOSE REEL
space-saving storage of the high-pressure hose with twist stop screw connection

ACCESSORY STORAGE
neat storage for high pressure gun and lances

STAINLESS STEEL PROTECTIVE COVER
durable and corrosion resistant

IMPACT PROTECTION
reduces accidental damage to the high-pressure pump

LX-RP 1600 TST | 616080

► **ACCESSORIES** | page 74-96



EQUIPMENT

- Quick release plug-in system D12
- Kränzle in-line RP pump
- Total-stop system with delayed motor cut-off
- Safety shutdown

- Stepless pressure regulation
- High-pressure hose with Twist-Stop screw connection
- Locking brake
- Direct suction: Suction height 2.5 m



VARIANT - NON-MARKING

NOM conversion kit Ord.no. **42283**

For further information on NON-Marking please refer to page 75

MODEL	LX-RP 1000 TST	LX-RP 1200 TST	LX-RP 1400 TST	LX-RP 1600 TST
Ord.no. TST incl. hose drum	616052	616062	616070	616080

TECHNICAL SPECIFICATIONS

Operating pressure	bar MPa	30-200 3-20	30-190 3-19	30-170 3-17	30-150 3-15
Water output	l/min l/h	16.6 1000	20 1200	23.3 1400	26.7 1600
Admissible overpressure	bar MPa	220 22	210 21	190 19	170 17
Motor speed	Rpm	1400	1400	1400	1400
Connection	V ~ Hz A	400 3 50 13.5	400 3 50 14.3	400 3 50 14.3	400 3 50 14.3
Power intake Power output	kW	7.5 5.5	7.5 5.5	8.0 6.3	8.0 6.3
Power supply cable	m	7.5	7.5	7.5	7.5
Plug		NEW CEE 16 A	NEW CEE 16 A	CEE 32 A	CEE 32 A
Dimensions L x W x H	mm	735 580 1020	735 580 1020	735 580 1020	735 580 1020
Weight	kg	94	94	94	94

EQUIPMENT

High-pressure hose	m Ord.no.	20 (DN8) 443812	20 (DN8) 443812	20 (DN8) 443812	20 (DN8) 443812
Trigger gun with safety catch	Model Ord.no.	Starlet 3 12500	Starlet 3 12500	Starlet 3 12500	Starlet 3 12500
Lance with flat-jet nozzle	Nozzle Ord.no.	05 12420-D2505	065 12420-D40065	08 12420-D4008	11 12420-D4011





TECHNICAL HIGHLIGHTS

PRESSURE WASHERS WITH INTERNAL COMBUSTION ENGINE

EXCEPTIONAL CLEANING RESULTS, ANYWHERE, EVERY TIME

For these machines nowhere is too far: Kränzle pressure washers with petrol engines allow an almost unlimited radius of action. The reliable and maintenance-friendly Machines are reliable in every situation. Even a water connection is not absolutely necessary. Thanks to the suction hose the appliance can take water from pools, lakes or rivers, with a prefilter to protect against contamination. Highest cleaning power for convincing results are thus available everywhere.

TABLE OF CONTENTS

Profi-Jet-Series	50-53
B-Series	54-55
Accessories for plug-in system D12	74-96

KEY INDUSTRIES



PROVEN ENGINES

Service-friendly and economical: the reliable Honda Motors with low oil protection. Fuel consumption and noise development can be reduced via the optional speed regulation.



OPERATION WITHOUT POWER/WATER CONNECTION

No electricity - no problem: petrol-powered engines are devices independent of the power supply, the Suction hose with suction filter for water basins or lakes do not require a mains water connection.

Profi-Jet-Series

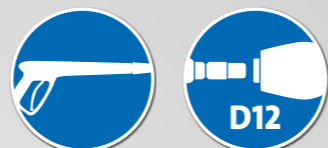

CARRY HANDLE
portable and space-saving compact design

STAINLESS STEEL PROTECTIVE COVER
protects against external contamination,
durable and corrosion resistant



HONDA PETROL ENGINE
reliable, service-friendly, L-type
reduction version for optimum pair-
ing, and with low oil protection

STAINLESS STEEL PRESSURE GAUGE
easy reading of the working pressure

Profi-Jet B 13/150 | 618001

► **ACCESSORIES** | page 74-96



EQUIPMENT

- Quick release plug-in system D12
- Kränzle axial pump
- Combustion engine Honda
- Stepless pressure regulation
- High-pressure hose with Twist-Stop screw connection
- Direct suction: Suction height 2.5 m



MODEL	Profi-Jet B 13/150	Profi-Jet B 10/200
Ord.no.	618001	618021

TECHNICAL SPECIFICATIONS

Operating pressure	bar MPa	30-150 3-15	30-200 3-20
Water output	l/min l/h	13 780	10 600
Admissible overpressure	bar MPa	170 17	220 22
Engine		Honda GX160 LX	Honda GX200 LX
Engine power	kW hp	3.6 4.9	4.3 5.8
Dimensions L x W x H	mm	520 360 420	520 360 420
Weight	kg	35	35

EQUIPMENT

High-pressure hose	m Ord.no.	10 (DN8) 44878	10 (DN8) 41081
Trigger gun with safety catch	Model Ord.no.	Starlet 4 12525	Starlet 4 12525
Lance with regulating nozzle	Nozzle Ord.no.	● 05 12439-D2505	○ 03 12439-D2503
Lance with Dirtkiller	Nozzle Ord.no.	● 05 12438-05	○ 03 12438-03
Water inlet filter	Ord.no.	13310	13310



Profi-Jet-Series



STAINLESS STEEL CHASSIS
durable and corrosion resistant

CONVENIENT INTEGRATED HOSE REEL (VARIANT)
space-saving storage of the high-pressure hose with twist stop screw connection

ACCESSORY STORAGE
neat storage for high pressure gun and lances

STAINLESS STEEL PRESSURE GAUGE
easy reading of the working pressure

HONDA PETROL ENGINE
reliable, service-friendly, L-type reduction version for optimum pairing, and with low oil protection

AUTOMATIC SPEED REGULATION
reduces fuel consumption and noise levels (from model Profi-Jet B 16/220)

Profi-Jet B 16/220 T | 618049

► **ACCESSORIES** | page 74-96

EQUIPMENT

- Quick release plug-in system D12
- Kränzle axial pump
- Combustion engine Honda
- Stepless pressure regulation
- High-pressure hose with Twist-Stop screw connection
- Direct suction: Suction height 2.5 m



MODEL	Profi-Jet B 13/150	Profi-Jet B 10/200	Profi-Jet B 16/220	Profi-Jet B 20/200	Profi-Jet B 16/250
Ord.no. without hose drum	618003	618023	618045	618065	618085
Ord.no. incl. hose drum	618007	618027	618049	618069	618089

TECHNICAL SPECIFICATIONS

Operating pressure	bar MPa	30-150 3-15	30-200 3-20	30-220 3-22	30-200 3-20	30-250 3-25
Water output	l/min l/h	13 780	10 600	16 960	20 1200	16 960
Admissible overpressure	bar MPa	170 17	220 22	240 24	220 22	270 27
Engine		Honda GX160 LX	Honda GX200 LX	Honda GX340 LX	Honda GX390 LX	Honda GX390 LX
Engine power	kW hp	3.6 4.9	4.3 5.8	8 10.9	8.7 11.8	8.7 11.8
Speed adjustment		—	—	●	●	●
Dimensions L x W x H without hose drum	mm	770 570 990	770 570 990	770 570 990	770 570 990	770 570 990
Dimensions L x W x H incl. hose drum	mm	770 570 1005	770 570 1005	785 570 1005	785 570 1005	785 570 1005
Weight without incl. hose drum	kg	42 50	42 50	65 73	65 73	65 73

EQUIPMENT

High-pressure hose without hose drum	m Ord.no.	10 (DN8) 44878	10 (DN8) 41081	10 (DN8) 41081	10 (DN8) 41081	10 (DN8) 41081
High-pressure hose incl. hose drum	m Ord.no.	20 (DN8) 41083	20 (DN8) 41083	20 (DN8) 41083	20 (DN8) 41083	20 (DN8) 41083
Trigger gun with safety catch	Model Ord.no.	Starlet 3 12500	Starlet 3 12500	Starlet 3 12500	Starlet 3 12500	Starlet 3 12500
Lance with regulating nozzle	Nozzle Ord.no.	● 05 12431-D2505	○ 03 12431-D2503	● 05 12431-D2505	● 07 12431-D2507	● 045 12431-D25045
Lance with Dirtkiller	Nozzle Ord.no.	● 05 12425-05	○ 03 12425-03	—	—	—
Lance with Turbokiller	Nozzle Ord.no.	—	—	● 05 12430-05	● 07 12430-07	● 045 12430-045
Water inlet filter	Ord.no.	13310	13310	13310	13310	13310



Suction hose with suction filter

EXPERT TIP

For sucking in water from external sources
■ Hose length 3 m

Ord.no.	150383
---------	--------

B-Series



CONVENIENT INTEGRATED HOSE REEL
space-saving storage of the high-pressure hose with twist stop screw connection

ACCESSORY STORAGE
neat storage for high pressure gun and lances

STAINLESS STEEL PRESSURE GAUGE
easy reading of the working pressure

HONDA PETROL ENGINE
reliable, service-friendly, L-type reduction version for optimum pairing, and with low oil protection

AUTOMATIC SPEED REGULATION
reduces fuel consumption and noise levels (from model B 230 T)

IMPACT PROTECTION
reduces accidental damage to the high-pressure pump

B 240 T | 620023

► **ACCESSORIES** | page 74-96



EQUIPMENT

- Quick release plug-in system D12
- Kränzle axial pump
- Combustion engine Honda
- Stepless pressure regulation
- High-pressure hose with Twist-Stop screw connection

- Locking brake
- Direct suction: Suction height 2.5 m



MODEL	B 170 T	B 230 T	B 240 T	B 270 T
Ord.no. incl. hose drum	620001	620013	620023	620033

TECHNICAL SPECIFICATIONS

		B 170 T	B 230 T	B 240 T	B 270 T
Operating pressure	bar MPa	30-150 3-15	30-200 3-20	30-220 3-22	30-250 3-25
Water output	l/min l/h	12.5 750	20 1200	16 960	16 960
Admissible overpressure	bar MPa	170 17	230 23	240 24	270 27
Engine		Honda GX160 LX	Honda GX390 LX	Honda GX340 LX	Honda GX390 LX
Engine power	kW hp	3.6 4.9	8.7 11.8	8 10.9	8.7 11.8
Speed adjustment		–	●	●	●
Dimensions L x W x H	mm	720 570 960	720 570 960	720 570 960	720 570 960
Weight	kg	67	92	92	92

EQUIPMENT

		B 170 T	B 230 T	B 240 T	B 270 T
High-pressure hose	m Ord.no.	20 (DN8) 41083	20 (DN8) 41083	20 (DN8) 41083	20 (DN8) 41083
Trigger gun with safety catch	Model Ord.no.	Starlet 3 12500	Starlet 3 12500	Starlet 3 12500	Starlet 3 12500
Lance with regulating nozzle	Nozzle Ord.no.	● 05 12431-D2505	● 07 12431-D2507	● 05 12431-D2505	● 045 12431-D25045
Lance with Dirtkiller	Nozzle Ord.no.	● 05 12425-05	–	–	–
Lance with Turbokiller	Nozzle Ord.no.	–	● 07 12430-07	● 05 12430-05	● 045 12430-045
Water inlet filter	Ord.no.	13310	13310	13310	13310



Suction hose with suction filter

EXPERT TIP

For sucking in water from external sources
■ Hose length 3 m

Ord.no.	150383
---------	--------

MAXIMUM CLEANING EFFICIENCY WITH HOT WATER



Dirt, bacteria and viruses make a big fuss: some contaminants, such as grease or oil, are difficult to remove. But it is easier with hot water. This is where Kränzle hot water pressure washers come into play. Their high water temperatures of up to 155 °C in the steam stage increase the cleaning power and also have a disinfecting effect.

RP Pressure washers with in-line RP pump:

Our flagship for the very highest applications: The Kränzle therm-RP-Series with innovative in-line RP pump delivers hot water at high pressure and is particularly suitable for applications where an above-average flushing effect at high working pressure is required. With a water output of up to 1600 l/h, even the most stubborn dirt does not stand a chance.

TABLE OF CONTENTS

RP therm-RP-Series	58-61
RP therm-RP-Series - black edition	62-63
therm 1017-Series	64-65
therm-C-Series	66-67
therm-CA-Series	68-69
Accessories for plug-in system D12	74-96

KEY INDUSTRIES



TECHNICAL HIGHLIGHTS



TWIST-STOP SCREW CONNECTION

Go along with everything: provided with all machines: A special screw connection prevents the Twisting of the high-pressure hose during work and ensures so for consistent cleaning results in every situation.



DIGITAL CONTROL PANEL

With the digital temperature control, the water temperature and the heat output can be measured exactly and can be controlled via two operating modes. This gives the ability to work precisely even with partial water quantities and low temperatures.



SAFETY DEVICES

Protection at every aspect: features such as a safety valve, flow monitor, optical flame monitoring, overcurrent release, pressure switch and low fuel cut-off switch ensure for absolute safe operation.



OPTICAL FLAME MONITORING AND THERMAL OVERLOAD PROTECTION

Electronic monitoring of combustion: Kränzle therm devices have a photocell to monitor the burner flame. This ensures safe operation at all times, even if the user is not near. Additionally, an overheating protection sensor measures the temperature at the exhaust; switching off heating automatically if more than 260 °C is detected. (Exception: entry-level model therm-CA)



TOTAL-STOP SYSTEM WITH DELAYED MOTOR SHUTDOWN

Energy consumption is reduced, longer life: when closing the high pressure gun the motor switches off automatically, relieves the high-pressure pump and drive and reduces noise. Thanks to a small time-delay when switching off machines means that with very short work breaks the full working pressure is immediately restored.

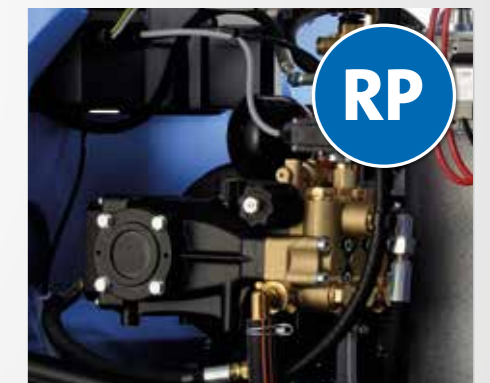

INNOVATIVE IN-LINE RP PUMP

Proven technology convincingly enhanced: a Crankshaft moves the plungers in line via connecting rods the in-line RP pump. This special design enables even greater water flow with significantly higher washing effect than conventional pumps and ensures impressive properties:

- Power transmission as with a car engine
- extremely long service life
- integrated unloader valve
- Total-stop system

therm-RP-Series



ACCESSORY STORAGE
neat storage for high pressure gun and lances

CONVENIENT INTEGRATED HOSE REEL (VARIANT)
space-saving storage of the high-pressure hose with twist stop screw connection

DIGITAL CONTROL PANEL
digital temperature regulation with 2 different operation modes

REMOVABLE COVERS
convenient and easy service access

VISUAL FLAME MONITORING AND OVERHEATING PROTECTION
(on page 57)

therm-RP 1000 | 638210

► **ACCESSORIES** | page 74-96



EQUIPMENT

- Quick release plug-in system D12
- Kränzle in-line RP pump
- Total-stop system with delayed motor cut-off
- Safety shutdown
- Pressure regulation
- Cleaning Agent Intake
- Locking brake
- Water tank: Volume 12 liters
- Optional: Stainless steel heating coil

EQUIPMENT HOT WATER

- Digital thermostat
- Flow monitor
- Combustion chamber pre-ventilation
- Visual flame monitoring
- Overheating protection (exhaust temperature in excess of 260 °C)
- Burner stops when there is a lack of heating oil
- Operating hours meter
- Fuel tank: 35 liters



VARIANT - NON-MARKING

NOM conversion kit Version without drum	Ord.no.	42280
NOM conversion kit Version with drum	Ord.no.	42281

For further information on NON-Marking please refer to page 75

MODEL	therm-RP 1000 therm-RP 1000 T	therm-RP 1200 therm-RP 1200 T	therm-RP 1400 therm-RP 1400 T	therm-RP 1600 therm-RP 1600 T
Ord.no. without hose drum	638202	638402	638600	638800
Ord.no. T incl. hose drum	638212	638412	638610	638810
Ord.no. without hose drum ► with stainless steel heating coil	638252	638452	638650	638850
Ord.no. incl. hose drum ► with stainless steel heating coil	638262	638462	638660	638860

TECHNICAL SPECIFICATIONS

Operating pressure	bar MPa	70-200 7-20	70-190 7-19	70-170 7-17	70-150 7-15
Water output	l/min l/h	16.6 1000	20 1200	23.3 1400	26.7 1600
Admissible overpressure	bar MPa	220 22	210 21	190 19	170 17
Motor speed	Rpm	1400	1400	1400	1400
Connection	V ~ Hz A	400 3 50 12.5	400 3 50 13.5	400 3 50 14.3	400 3 50 14.3
Power intake Power output	kW	7.5 5.5	7.5 5.5	8.0 6.3	8.0 6.3
Power supply cable	m	7.5	7.5	7.5	7.5
Plug		NEW CEE 16 A	NEW CEE 16 A	CEE 32 A	CEE 32 A
Dimensions L x W x H without hose drum	mm	1050 800 1015	1050 800 1015	1050 800 1015	1050 800 1015
Dimensions L x W x H incl. hose drum	mm	1050 800 1300	1050 800 1300	1050 800 1300	1050 800 1300
Weight without incl. hose drum	kg	210 218	210 218	210 218	210 218

TECHNICAL DATA HOT WATER

Hot water output (at 12 °C inlet)	°C	80	80	80	80
Steam level	°C	140	140	140	140
Oil consumption at max. heating output	kg/h l/h	6.0 7.0	7.7 9.2	7.7 9.2	7.7 9.2
Heating oil consumption ΔT 45°	kg/h l/h	5.6 6.6	5.6 6.6	5.6 6.6	5.6 6.6
Heating output	kW	65	84	84	84

EQUIPMENT

High-pressure hose without hose drum	m Ord.no.	10 (DN8) 41081	10 (DN8) 41081	10 (DN8) 41081	10 (DN8) 41081
High-pressure hose incl. hose drum	m Ord.no.	20 (DN8) 443812	20 (DN8) 443812	20 (DN8) 443812	20 (DN8) 443812
Trigger gun with safety catch	Model Ord.no.	Starlet 3 12500	Starlet 3 12500	Starlet 3 12500	Starlet 3 12500
Lance with flat-jet nozzle	Nozzle Ord.no.	05 12420-D2505	065 12420-D25065	08 12420-D2508	11 12420-D2511
Water inlet filter	Ord.no.	13310	13310	13310	13310

therm-RP-Series



REMOVABLE COVERS
convenient and easy service access

DIGITAL CONTROL PANEL
digital temperature regulation
with 2 different operation modes

ACCESSORY STORAGE
neat storage for high
pressure gun and lances

AUTOMATIC HOSE REEL
automatic hose retraction with
Twist-Stop screw connection

**VISUAL FLAME MONITORING AND
OVERHEATING PROTECTION**
(on page 59)

therm-RP 1400 AT | 638620

► **ACCESSORIES** | page 74-96



EQUIPMENT

- Quick release plug-in system D12
- Kränzle in-line RP pump
- Automatic hose reel
- Total-stop system with delayed motor cut-off
- Safety shutdown
- Pressure regulation
- Cleaning Agent Intake
- Locking brake
- Water tank: Volume 12 liters

EQUIPMENT HOT WATER

- Digital thermostat
- Flow monitor
- Combustion chamber pre-ventilation
- Visual flame monitoring
- Overheating protection (exhaust temperature in excess of 260 °C)
- Burner stops when there is a lack of heating oil
- Operating hours meter
- Fuel tank: 35 liters

AUTOMATIC HOSE REEL

By means of a return spring inside the drum the high pressure hose is automatically rolled up. Guide rollers enable flexible rolling up in all directions.



MODEL	therm-RP 1000 AT	therm-RP 1200 AT	therm-RP 1400 AT	therm-RP 1600 AT
Ord.no. AT incl. automatic hose reel	638222	638422	638620	638820

TECHNICAL SPECIFICATIONS

Operating pressure	bar MPa	70-200 7-20	70-190 7-19	70-170 7-17	70-150 7-15
Water output	l/min l/h	16.6 1000	20 1200	23.3 1400	26.7 1600
Admissible overpressure	bar MPa	220 22	210 21	190 19	170 17
Motor speed	Rpm	1400	1400	1400	1400
Connection	V ~ Hz A	400 3 50 12.5	400 3 50 13.5	400 3 50 14.3	400 3 50 14.3
Power intake Power output	kW	7.5 5.5	7.5 5.5	8.0 6.3	8.0 6.3
Power supply cable	m	7.5	7.5	7.5	7.5
Plug		NEW CEE 16 A	NEW CEE 16 A	CEE 32 A	CEE 32 A
Dimensions L x W x H	mm	1300 800 1015	1300 800 1015	1300 800 1015	1300 800 1015
Weight	kg	240	240	240	240

TECHNICAL DATA HOT WATER

Hot water output (at 12 °C inlet)	°C	80	80	80	80
Steam level	°C	140	140	140	140
Oil consumption at max. heating output	kg/h l/h	6.0 7.0	7.7 9.2	7.7 9.2	7.7 9.2
Heating oil consumption ΔT 45°	kg/h l/h	5.6 6.6	5.6 6.6	5.6 6.6	5.6 6.6
Heating output	kW	65	84	84	84

EQUIPMENT

High-pressure hose	m Ord.no.	20 (DN8) 41083	20 (DN8) 41083	20 (DN8) 41083	20 (DN8) 41083
Trigger gun with safety catch	Model Ord.no.	Starlet 3 12500	Starlet 3 12500	Starlet 3 12500	Starlet 3 12500
Lance with flat-jet nozzle	Nozzle Ord.no.	05 12420-D2505	065 12420-D25065	08 12420-D2508	11 12420-D2511
Water inlet filter	Ord.no.	13310	13310	13310	13310

therm-RP-Series - black edition



NEW

ACCESSORY STORAGE
neat storage for high pressure gun and lances

REMOVABLE COVERS
convenient and easy service access

CONVENIENT INTEGRATED HOSE REEL (VARIANT)
space-saving storage of the high-pressure hose with twist stop screw connection

DIGITAL CONTROL PANEL
digital temperature regulation with 2 different operation modes

VISUAL FLAME MONITORING AND OVERHEATING PROTECTION
(on page 57)



therm-RP 900 T | 638110

► **ACCESSORIES** | page 74-96



EQUIPMENT

- Quick release plug-in system D12
- Kränzle in-line RP pump
- Total-stop system with delayed motor cut-off
- Safety shutdown
- Pressure regulation
- Cleaning Agent Intake
- Locking brake
- Water tank: Volume 12 liters

EQUIPMENT HOT WATER

- Digital thermostat
- Flow monitor
- Combustion chamber pre-ventilation
- Visual flame monitoring
- Overheating protection (exhaust temperature in excess of 260 °C)
- Burner stops when there is a lack of heating oil
- Operating hours meter
- Fuel tank: 35 liters

INTEGRATED AUTOMATIC HOSE REEL (VARIANT)
automatic hose retraction with Twist-Stop screw connection (therm-RP 900 AT)



MODEL	therm-RP 900	NEW	therm-RP 900 T	therm-RP 900 AT
Ord.no. without hose drum	638100			
Ord.no. T incl. hose drum			638110	
Ord.no. AT incl. automatic hose reel				638120

TECHNICAL SPECIFICATIONS

Operating pressure	bar MPa	70-170 7-17	70-170 7-17	70-170 7-17
Water output	l/min l/h	15 900	15 900	15 900
Admissible overpressure	bar MPa	190 19	190 19	190 19
Motor speed	Rpm	1400	1400	1400
Connection	V ~ Hz A	400 3 50 9.4	400 3 50 9.4	400 3 50 9.4
Power intake Power output	kW	5.5 4.0	5.5 4.0	5.5 4.0
Power supply cable	m	7.5	7.5	7.5
Plug		CEE 16 A	CEE 16 A	CEE 16 A
Dimensions L x W x H	mm	1050 800 1015	1050 800 1300	1050 800 1015
Weight	kg	197	205	210

TECHNICAL DATA HOT WATER

Hot water output (at 12 °C inlet)	°C	85	85	85
Steam level	°C	155	155	155
Oil consumption at max. heating output	kg/h l/h	5.8 6.8	5.8 6.8	5.8 6.8
Heating oil consumption ΔT 45°	kg/h l/h	4.2 5.0	4.2 5.0	4.2 5.0
Heating output	kW	60	60	60

EQUIPMENT

High-pressure hose	m Ord.no.	10 (DN8) 41081	20 (DN8) 443812	15 (DN8) 44879
Trigger gun with safety catch	Model Ord.no.	Starlet 3 12500	Starlet 3 12500	Starlet 3 12500
Lance with flat-jet nozzle	Nozzle Ord.no.	● 055 12420-D25055	● 055 12420-D25055	● 055 12420-D25055
Water inlet filter	Ord.no.	13310	13310	13310

therm 1017-Series



ACCESSORY STORAGE
neat storage for high pressure gun and lances

CONVENIENT INTEGRATED HOSE REEL (VARIANT)
space-saving storage of the high-pressure hose with twist stop screw connection

CONTROL PANEL
analogue temperature regulation

REMOVABLE COVERS
convenient and easy service access

VISUAL FLAME MONITORING AND OVERHEATING PROTECTION
(on page 57)

therm 1017 | 632210



MODEL	therm 1017 therm 1017 T
Ord.no. without hose drum	632200
Ord.no. incl. hose drum	632210

TECHNICAL SPECIFICATIONS

Operating pressure	bar MPa	30-150 3-15
Water output	l/min l/h	16.7 1000
Admissible overpressure	bar MPa	170 17
Motor speed	Rpm	1400
Connection	V ~ Hz A	400 3 50 8.5
Power intake Power output	kW	5.5 4.0
Power supply cable	m	7.5
Plug		CEE 16 A
Dimensions L x W x H without hose drum	mm	1050 800 1015
Dimensions L x W x H incl. hose drum	mm	1050 800 1300
Weight without incl. hose drum	kg	193 198

TECHNICAL DATA HOT WATER

Hot water output (at 12 °C inlet)	°C	80
Steam level	°C	140
Oil consumption at max. heating output	kg/h l/h	6.2 7.4 ▶ eco: 4.8 6.3
Heating oil consumption ΔT 45°	kg/h l/h	5.6 6.6
Heating output	kW	68

EQUIPMENT

High-pressure hose without hose drum	m Ord.no.	10 (DN8) 44878
High-pressure hose incl. hose drum	m Ord.no.	20 (DN8) 44877
Trigger gun with safety catch	Model Ord.no.	Starlet 3 12500
Lance with flat-jet nozzle	Nozzle Ord.no.	● 06 12420-D2506
Water inlet filter	Ord.no.	13310

► **ACCESSORIES** | page 74-96



EQUIPMENT

- Quick release plug-in system D12
- Kränzle axial pump
- Total-stop system with delayed motor cut-off
- Safety shutdown
- Pressure regulation
- Cleaning Agent Intake
- Locking brake
- Direct suction: Suction height 2.5 m
- Water tank: Volume 12 liters

EQUIPMENT HOT WATER

- Eco mode
- Flow monitor
- Combustion chamber pre-ventilation
- Visual flame monitoring
- Overheating protection (exhaust temperature in excess of 260 °C)
- Burner stops when there is a lack of heating oil
- Fuel tank: 35 liters

therm-C-Series



CONTROL PANEL
analogue temperature regulation

CONVENIENT INTEGRATED HOSE REEL (VARIANT)
space-saving storage of the high-pressure hose with twist stop screw connection

ACCESSORY STORAGE
neat storage for high pressure gun and lances

REMOVABLE COVERS
convenient and easy service access

VISUAL FLAME MONITORING AND OVERHEATING PROTECTION
(on page 57)



therm-C 13/180 | 628210

► **ACCESSORIES** | page 74-96



EQUIPMENT

- Quick release plug-in system D12
- Kränzle axial pump
- Total-stop system with delayed motor cut-off
- Safety shutdown
- Pressure regulation
- Cleaning Agent Intake
- Locking brake
- Water tank: Volume 3 liters

EQUIPMENT HOT WATER

- Flow monitor
- Combustion chamber pre-ventilation
- Visual flame monitoring
- Overheating protection (exhaust temperature in excess of 260 °C)
- Burner stops when there is a lack of heating oil
- Fuel tank: 25 liters



VARIANT - NON-MARKING

NOM conversion kit Version without drum	Ord.no.	42270
NOM conversion kit Version with drum	Ord.no.	42271

For further information on NON-Marking please refer to page 75

MODEL	therm C 11/130 therm C 11/130 T	therm C 13/180 therm C 13/180 T	therm C 15/150 therm C 15/150 T
Ord.no. without hose drum	628000	628200	628350
Ord.no. incl. hose drum	628010	628210	628360

TECHNICAL SPECIFICATIONS

Operating pressure	bar MPa	30-130 3-13	30-180 3-18	30-150 3-15
Water output	l/min l/h	11 660	13 780	15 900
Admissible overpressure	bar MPa	145 14.5	200 20	170 17
Motor speed	Rpm	1400	1400	1400
Connection	V ~ Hz A	230 1 50 15	400 3 50 8.7	400 3 50 8.7
Power intake Power output	kW	3.4 2.3	4.8 4.0	4.8 4.0
Power supply cable	m	5	7.5	7.5
Plug		Schuko	CEE 16 A	CEE 16 A
Dimensions L x W x H without hose drum	mm	860 580 970	860 580 970	860 580 970
Dimensions L x W x H incl. hose drum	mm	860 580 1220	860 580 1220	860 580 1220
Weight without incl. hose drum	kg	164 169	164 169	164 169

TECHNICAL DATA HOT WATER

Hot water output (at 12 °C inlet)	°C	80	80	80
Steam level	°C	140	150	150
Oil consumption at max. heating output	kg/h l/h	5.1 6.1	5.8 6.8	6.0 7.1
Heating oil consumption ΔT 45°	kg/h l/h	3.2 3.8	3.8 4.5	4.3 5.1
Heating output	kW	55	60	65

EQUIPMENT

High-pressure hose without hose drum	m Ord.no.	10 (DN8) 44878	10 (DN8) 44878	10 (DN8) 44878
High-pressure hose incl. hose drum	m Ord.no.	15 (DN8) 44879	15 (DN8) 44879	15 (DN8) 44879
Trigger gun with safety catch	Model Ord.no.	Starlet 3 12500	Starlet 3 12500	Starlet 3 12500
Lance with flat-jet nozzle	Nozzle Ord.no.	● 045 12420-D25045	● 045 12420-D25045	● 055 12420-D25055
Water inlet filter	Ord.no.	13310	13310	13310

therm-CA-Series



ACCESSORY STORAGE
neat storage for high pressure gun and lances

REMOVABLE COVERS
convenient and easy service access

CONVENIENT INTEGRATED HOSE REEL (VARIANT)
space-saving storage of the high-pressure hose with twist stop screw connection

CONTROL PANEL
analogue temperature regulation

POWERFUL ENTRY MODEL
with all important basic functions



therm-CA 12/150 | 626210

► **ACCESSORIES** | page 74-96



EQUIPMENT

- Quick release plug-in system D12
- Kränzle axial pump
- Total-Stop system
- Pressure regulation
- Cleaning Agent Intake
- Locking brake
- Water tank: Volume 3 liters

EQUIPMENT HOT WATER

- Flow monitor
- Combustion chamber pre-ventilation
- Fuel tank: 25 liters



MODEL	therm CA 11/130 therm CA 11/130 T	therm CA 12/150 therm CA 12/150 T
Ord.no. without hose drum	626000	626200
Ord.no. incl. hose drum	626010	626210

TECHNICAL SPECIFICATIONS

Operating pressure	bar MPa	30-130 3-13	30-150 3-15
Water output	l/min l/h	11 660	12 720
Admissible overpressure	bar MPa	145 14.5	165 16.5
Motor speed	Rpm	1400	1400
Connection	V ~ Hz A	230 1 50 15	400 3 50 7.2
Power intake Power output	kW	3.4 2.3	3.8 3.0
Power supply cable	m	5	7.5
Plug		Schuko	CEE 16 A
Dimensions L x W x H without hose drum	mm	860 580 970	860 580 970
Dimensions L x W x H incl. hose drum	mm	860 580 1220	860 580 1220
Weight without incl. hose drum	kg	159 164	159 164

TECHNICAL DATA HOT WATER

Hot water output (at 12 °C inlet)	°C	80	80
Steam level	°C	140	140
Oil consumption at max. heating output	kg/h l/h	5.1 6.1	5.4 6.4
Heating oil consumption ΔT 45°	kg/h l/h	3.2 3.8	3.5 4.1
Heating output	kW	55	58

EQUIPMENT

High-pressure hose without hose drum	m Ord.no.	10 (DN8) 44878	10 (DN8) 44878
High-pressure hose incl. hose drum	m Ord.no.	15 (DN8) 44879	15 (DN8) 44879
Trigger gun with safety catch	Model Ord.no.	Starlet 3 12500	Starlet 3 12500
Lance with flat-jet nozzle	Nozzle Ord.no.	● 045 12420-D25045	● 045 12420-D25045
Water inlet filter	Ord.no.	13310	13310



ELECTRICALLY HEATED HOT WATER PRESSURE WASHERS
**EMISSION-FREE, INSTANT HOT WATER
 AND IMPRESSIVELY THOROUGH CLEANING**

Clean air, clean room: Our electrically heated pressure washers are especially suitable for use in closed rooms without exhaust air, in clean rooms or in health and hygiene sensitive areas. Temperatures of up to 80 °C increase the cleaning effect for stubborn dirt and the electrically operated instantaneous water heater enables emission-free working.

TABLE OF CONTENTS

e-therm-Series	72-73
Accessories for plug-in system D12	74-96

KEY INDUSTRIES



TECHNICAL HIGHLIGHTS



ELECTRICALLY HEATED INSTANTANEOUS WATER HEATER
 Stable heat: the instantaneous water heater can be operated with up to 48 KW and enables even in continuous operation Temperatures up to 80 °C. It ensures a uniform water temperature and is therefore ideally suited for cleaning of fats and oils.



DIGITAL THERMOSTAT
 The temperature is controlled via the digital thermostat. This allows the water temperature to be maintained at a constant level. An integrated operating hours counter determines the required service intervals.



INTEGRATED HOSE REEL
 Space-saving and convenient: with a folding crank handle for practical, neat storage of the high-pressure hose. A special locking device holds the reel in the desired position.



ECO-MODE
 On a small "flame": with the Eco level, the user can keep the maximum working temperature at 55 °C and thus Reduce electricity consumption up to 50%.
 (for e-therm 603 M 36, e-therm 873 M 36 and e-therm 873 M 48)

e-therm-Series



ACCESSORY STORAGE
neat storage for high pressure gun and lances

CONVENIENT INTEGRATED HOSE REEL (VARIANT)
space-saving storage of the high-pressure hose with twist stop screw connection

DIGITAL CONTROL PANEL
digital temperature regulation with 2 different operation modes

ECO LEVEL
for energy-saving use (e-therm 603 M 36, e-therm 873 M 36, e-therm 873 M 48)

e-therm 603 M 36 | 642260

► **ACCESSORIES** | page 74-96

EQUIPMENT

Quick release plug-in system D12

- Kränzle axial pump
- Total-stop system with delayed motor cut-off
- Safety shutdown
- Pressure regulation
- Locking brake
- Water tank: Volume 12 liters (e-therm 603 M 36, e-therm 873 M 36, e-therm 873 M 48)

EQUIPMENT HOT WATER ELECTRICALLY HEATED

- Digital thermostat
- Flow monitor
- Overheating protection
- Operating hours meter



VARIANT - NON-MARKING

NOM conversion kit Version without drum	Ord.no.	42280
NOM conversion kit Version with drum	Ord.no.	42281



42280

For further information on NON-Marking please refer to page 75

MODEL	e-therm 500 M 18 e-therm 500 M 18 T	e-therm 500 M 24 e-therm 500 M 24 T	e-therm 603 M 36 e-therm 603 M 36 T	e-therm 873 M 36 e-therm 873 M 36 T	e-therm 873 M 48 e-therm 873 M 48 T
Ord.no. without hose drum	642050	642150	642250	642300	642350
Ord.no. incl. hose drum	642060	642160	642260	642310	642360

TECHNICAL SPECIFICATIONS

		e-therm 500 M 18 e-therm 500 M 18 T	e-therm 500 M 24 e-therm 500 M 24 T	e-therm 603 M 36 e-therm 603 M 36 T	e-therm 873 M 36 e-therm 873 M 36 T	e-therm 873 M 48 e-therm 873 M 48 T
Operating pressure	bar MPa	30-130 3-13	30-130 3-13	30-150 3-15	30-150 3-15	30-150 3-15
Water output	l/min l/h	8 480	8 480	10 600	13 780	13 780
Admissible overpressure	bar MPa	150 15	150 15	170 17	170 17	170 17
Motor speed	U/min	1400	1400	1400	1400	1400
Connection	V ~ Hz A	400 3 50 29	400 3 50 39	400 3 50 55	400 3 50 59	400 3 50 76
Power intake	kW	20	27	38	40	52
Power supply cable	m	5	5	5	5	5
Plug		CEE 32 A	CEE 63 A	CEE 63 A	CEE 63 A	CEE 125 A
Eco level		—	—	●	●	●
Dimensions L x W x H without hose drum	mm	1050 800 1015	1050 800 1015	1050 800 1015	1050 800 1015	1050 800 1015
Dimensions L x W x H incl. hose drum	mm	1050 800 1450	1050 800 1450	1050 800 1450	1050 800 1450	1050 800 1450
Weight without incl. hose drum	kg	128 136	128 136	160 168	160 168	160 168

TECHNICAL DATA HOT WATER

		e-therm 500 M 18 e-therm 500 M 18 T	e-therm 500 M 24 e-therm 500 M 24 T	e-therm 603 M 36 e-therm 603 M 36 T	e-therm 873 M 36 e-therm 873 M 36 T	e-therm 873 M 48 e-therm 873 M 48 T
Hot water output (at 12 °C inlet)	°C	48	60	75	68	80
Heating output	kW	18	24	36	36	48

EQUIPMENT

		e-therm 500 M 18 e-therm 500 M 18 T	e-therm 500 M 24 e-therm 500 M 24 T	e-therm 603 M 36 e-therm 603 M 36 T	e-therm 873 M 36 e-therm 873 M 36 T	e-therm 873 M 48 e-therm 873 M 48 T
High-pressure hose without hose drum	m Ord.no.	10 (DN8) 41081	10 (DN8) 41081	10 (DN8) 41081	10 (DN8) 41081	10 (DN8) 41081
High-pressure hose incl. hose drum	m Ord.no.	20 (DN8) 443812	20 (DN8) 443812	20 (DN8) 443812	20 (DN8) 443812	20 (DN8) 443812
Trigger gun with safety catch	Model Ord.no.	Starlet 3 12500	Starlet 3 12500	Starlet 3 12500	Starlet 3 12500	Starlet 3 12500
Lance with flat-jet nozzle	Nozzle Ord.no.	○ 03 12420-D2503	○ 03 12420-D2503	● 035 12420-D25035	● 05 12420-D2505	● 05 12420-D2505
Water inlet filter	Ord.no.	13310	13310	13310	13310	13310

WITH THE RIGHT TOOLS EVERYTHING IS ALWAYS UNDER CONTROL



Ready for use with one click: Our versatile range of accessories turns every Kränzle into an all-rounder for numerous areas of application. Whether surface or pipe cleaning, sandblasting work or particularly thorough cleaning with foam to loosen coarse dirt. All accessories are equipped with our quick-change plug-in system, which ensures the quick, easy and safe connection of cleaning lances and accessories.



TABLE OF CONTENTS

Trigger guns with safety catch	76-77
Cleaning lances	78-83
Floor cleaners	84
Foam cleaning Additive	85
Telescopic Lance	86-87
Special accessories	88
Intake / extraction Filter	89
Stainless steel table	90-91
Wall holders	92
Lance holder Hose reels	93
Adapter	93
Conversion to plug-in system D12	94-95
High-pressure hoses	96



TECHNICAL HIGHLIGHTS



QUICK RELEASE PLUG-IN SYSTEM

Sophisticated, fast and reliable: the quick release plug-in system with hardened stainless steel components ensures simple and always safe connection of the safety shut-off gun with the lance.



HEXAGONAL ANTI-ROTATION LOCK

Cleaning lances and accessories equipped with a hexagonal coupling can be locked against rotation in six different positions. This prevents the accessories from twisting unintentionally and allows them to be guided by moving the gun.



NON-MARKING EXECUTION (NOM)

Particularly suitable for use in hygiene and sanitary areas: The Kränzle NoM versions leave no traces or stripes, their abrasion resistance also ensures a longer service life of hoses and wheels.



TWIST-STOP SCREW CONNECTION

Go along with everything: provided with all machines: A special screw connection prevents the Twisting of the high-pressure hose during work and ensures so for consistent cleaning results in every situation.

WORKS AS WELL AS IT LOOKS

STARLET 3

The Starlet 3 combines function and design for precise, smooth operation. The lightweight design of the safety shut-off gun makes it comfortable to hold for long periods of time and allows you to work comfortably in pressure ranges up to 270 bar and water flow rates up to 40 l/min.



TECHNICAL HIGHLIGHTS

- **COMPACT DESIGN**
with modern design for comfortable handling
- **ERGONOMIC HANDLE**
Conforms to the natural shape of your hand for fatigue-free use
- **SMOOTH-RUNNING TRIGGER**
for easier water flow control
- **HEXAGONAL ANTI-TWIST LOCK**
Allows anti-twist accessories to be locked in six different positions

TECHNICAL DATA

Outlet plug-in system D12
 Operating pressure max. 270 bar | 27 MPa
 Water output max. 40 l/min
 Temperature max. 150 °C
Ord.no. 12500

COMFORT AND DURABILITY FOR THE PERFECT CLEANING EXPERIENCE

STARLET 4

The Starlet 4 gun combines quality and reliability for professional cleaning. The pressure washer offers comfortable handling and and comfort in operation control of the water flow thanks to its lightweight and robust design. Whatever your cleaning requirements may be the Starlet 4 is designed for a working pressure of 210 bar and a water flow of 20 l/min, making it the ideal choice for most cleaning tasks.



TECHNICAL HIGHLIGHTS

- **ERGONOMIC DESIGN**
for a secure and comfortable grip during the cleaning process
- **HEXAGONAL ANTI-TWIST LOCK**
for locking accessories in six different positions
- **ERGONOMIC HANDLE**
for fatigue-free operation
- **SMOOTH TRIGGER ACTION**
Requires less effort

TECHNICAL DATA

Outlet plug-in system D12
 Operating pressure max. 210 bar | 21 MPa
 Water output max. 20 l/min
 Temperature max. 100 °C
Ord.no. 12525



CLEVER NOZZLE TECHNOLOGY

FOR MAXIMUM CLEANING POWER



LANCE WITH PENDULUM NOZZLE

Convinces even under the toughest conditions: The new cleaning lance with pendulum nozzle made of wear-free stainless steel removes the most stubborn dirt and at the same time ensures area-wide cleaning. Its intelligent design combines the advantages of a flat jet lance with the power of a spot jet. An oscillating water jet delivers excellent cleaning results with significantly increased rinsing/spraying performance.

- produces a unique fluid jet (Coandă effect)
- without moving parts, thus robust and durable
- saves energy and water due to faster cleaning
- low vibrations and noise development

PRACTICALLY INDESTRUCTIBLE
made of stainless steel



INTELLIGENT FLOW GUIDANCE
the oscillating point jet increases the cleaning power

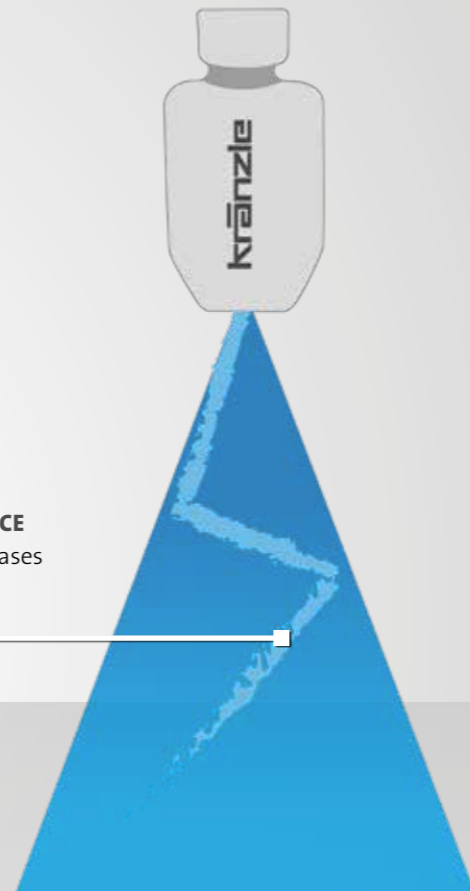

CLEANING LANCES



12434-PD4503

Lanze mit Pendeldüse				NEW
Length	mm	Nozzle size	Spraying angle	Ord.no.
500		○ 03	45°	12434-PD4503
500		● 042	45°	12434-PD45042



12424-PD3008

Lance with pendulum nozzle				
■ grip plates				
Length	mm	Nozzle size	Spraying angle	Ord.no.
1000		● 05	30°	12424-PD3005
1000		● 07	30°	12424-PD3007
1000		● 08	30°	12424-PD3008
1000		● 11	30°	12424-PD3011



CLEANING LANCES



12435-M20028

Lance with flat jet nozzle				
Length	mm	Nozzle size	Spraying angle	Ord.no.
500		○ 028	20°	12435-M20028
500		○ 03	20°	12435-M2003
500		● 042	20°	12435-M20042
500		● 045	20°	12435-M20045
500		1/4" female, without nozzle **	without nozzle **	12435-XXX



12420-D2503

Lance with flat jet nozzle

■ grip plates

Length	mm	Nozzle size	Spraying angle	Ord.no.
1000		○ 03	25°	12420-D2503
1000		● 035	25°	12420-D25035
1000		● 04	25°	12420-D2504
1000		● 045	25°	12420-D25045
1000		● 05	25°	12420-D2505
1000		● 055	25°	12420-D25055
1000		● 06	25°	12420-D2506
1000		● 065	25°	12420-D25065
1000		● 07	25°	12420-D2507
1000		● 075	25°	12420-D25075
1000		● 08	25°	12420-D2508
1000		● 085	25°	12420-D25085
1000		● 11	25°	12420-D2511
1000		● 125	25°	12420-D25125
1000		● 05	40°	12420-D4005
1000		● 06	40°	12420-D4006
1000		● 065	40°	12420-D40065
1000		● 08	40°	12420-D4008
1000		● 085	40°	12420-D40085
1000		● 11	40°	12420-D4011
1000		● 125	40°	12420-D40125
1000		15	40°	12420-D4015
1000		175	40°	12420-D40175
1000		20	40°	12420-D4020
1000		1/4" female, without nozzle **	without nozzle **	12420-XXX
1250		1/4" female, without nozzle **	without nozzle **	124220-XXX
1500		1/4" female, without nozzle **	without nozzle **	124210-XXX

FLAT JET NOZZLE

Our recommendation for cleaning sensitive surfaces. The flat spray nozzle with its conical jet (spraying angle: 20 - 40°) works particularly well and even produces a sweeping effect to push dirt and debris away from the cleaning area.



- 20° SPRAYING ANGLE**
Knife nozzle
Material: Brass
- 25° SPRAYING ANGLE**
Flat-jet nozzle
Material: Stainless steel
- 40° SPRAYING ANGLE**
Flat-jet nozzle
Material: Stainless steel

**Please order high-pressure nozzle separately.

CLEANING LANCES



VARIO-JET

The spray pattern can be adjusted from pointed jet to a wide spray fan. In addition, for high-pressure cleaners with an integrated chemical injector, the Vario-jet lance has an adjustable nozzle that allows the user switch from spraying water to spraying detergent. As such, cleaning foam or detergent can be applied without the need to change accessories.



VARIO-JET DUO

The spray pattern can be adjusted from pointed jet to a wide spray fan.

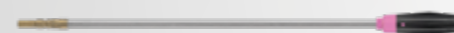

Lance with Vario-Jet

■ with anti-twist protection

Length	mm	Nozzle size	Ord.no.
500		● 028	12437-028
500		○ 03	12437-03
500		● 042	12437-042

Lance with Vario-Jet Duo

Length	mm	Nozzle size	Ord.no.
500		● 028	12433-028
500		○ 03	12433-03
500		● 042	12433-042

12436-M20042

Stainless steel lance with regulating nozzle

■ max. 250 bar | 25 MPa ■ max. 150 °C ■ with anti-twist protection

Length	mm	Nozzle size	Spraying angle	Ord.no.
500		● 042	20°	12436-M20042
500		○ 03	20°	12439-D2503
500		● 05	20°	12439-D2505

12431-D2503

Stainless steel lance with regulating nozzle

■ max. 250 bar | 25 MPa ■ max. 150 °C ■ with grip plates

Length	mm	Nozzle size	Spraying angle	Ord.no.
1000		○ 03	25°	12431-D2503
1000		● 045	25°	12431-D25045
1000		● 05	25°	12431-D2505
1000		● 07	25°	12431-D2507
1000		R 1/4" IG, without nozzle **	without nozzle **	132061
1500		R 1/4" IG, without nozzle **	without nozzle **	132062

132051

Short regulating nozzle

Length	mm	anti-twist protection	Nozzle size	Ord.no.
180		●	R 1/4" IG, without nozzle **	132051
340		grip plates	R 1/4" IG, without nozzle **	132060

LANCE WITH CONTROL NOZZLE

The working pressure can be set directly on the lance and for different tasks settings, for example more powerful flat jet with high pressure or more practical rinsing jet in low pressure operation.



**Please order high-pressure nozzle separately.

CLEANING LANCES



12438-028



Lance with Dirtkiller			
■ Water output max. 15 l/min			
■ Operating pressure max. 180 bar 18 MPa			
Length	mm	Nozzle size	Ord.no.
500		028	12438-028
500		03	12438-03
500		042	12438-042
500		045	12438-045
500		05	12438-05
500		055	12438-055

12425-042



Lance with Dirtkiller			
■ Water output max. 15 l/min		■ grip plates	
■ Operating pressure max. 180 bar 18 MPa			
Length	mm	Nozzle size	Ord.no.
1000		03	12425-03
1000		035	12425-035
1000		042	12425-042
1000		045	12425-045
1000		05	12425-05
1000		055	12425-055
1000		06	12425-06
1000		07	12425-07
1000		075	12425-075

DIRTKILLER AND TURBOKILLER

On insensitive surfaces the high pressure nozzle of the dirt killer with its rotating ceramic ball, removes even the most stubborn stains without residue. The turbokiller comes into its own when in most challenging cleaning assignments.



Figure: Dirtkiller

Figure: Turbokiller

12430-045



Lance with Turbokiller			
■ Water output max. 40 l/min		■ grip plates	
■ Operating pressure max. 250 bar 25 MPa			
Length	mm	Nozzle size	Ord.no.
1000		035	12430-035
1000		04	12430-04
1000		045	12430-045
1000		05	12430-05
1000		055	12430-055
1000		07	12430-07
1000		08	12430-08
1000		09	12430-09
1000		10	12430-10
1000		11	12430-11
1000		12	12430-12



CLEANING LANCES



410756

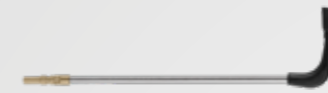

Underbody lance			
For hard-to-reach areas			
■ with anti-twist protection			
Length	mm	Nozzle size	Ord.no.
500		07	410756



Toilet lance			
■ with anti-twist protection		■ with regulating nozzle	
Ord.no.	12540		
Length	mm 500		
Nozzle size	D25055		

121332



Double lance with turning hand-grip			
Infinite variable control of working pressure			
■ with anti-twist protection			
Length	mm	Nozzle size	Ord.no.
660		D3035 **	121332

125301



Double lance with turning knob			
Infinite variable control of working pressure			
■ with anti-twist protection			
Length	mm	Nozzle size	Ord.no.
660		D3035 **	125301

411545



Lance extension			
■ with anti-twist protection			
Length	mm	Inlet/Outlet	Ord.no.
342		Plug-in system D12	411544
500		Plug-in system D12	411545

410755

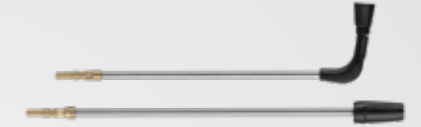

Underbody lance			
For hard-to-reach areas			
■ with anti-twist protection			
Length	mm	Nozzle size	Ord.no.
1000		07	410755



Bend lance with handgrip			
Infinite adjustment of bending angle from 20° to 140°			
Ord.no.	121801-XXX		
Length	mm 1100		
Outlet	R 1/4" IG, without nozzle **		

12133



Double lance with turning hand-grip			
Infinite variable control of working pressure			
Length	mm	Nozzle size	Ord.no.
1000		D3035 **	12133

125302



Double lance with turning knob			
Infinite variable control of working pressure			
Length	mm	Nozzle size	Ord.no.
1000		D3035 **	125302

411547



Lance extension			
■ grip plates			
Length	mm	Inlet/Outlet	Ord.no.
1000		Plug-in system D12	411546
1250		Plug-in system D12	411547
1500		Plug-in system D12	411548

** Low-pressure nozzle serially included. Order high-pressure nozzle separately.

FLOOR CLEANERS



Round Cleaner UFO short

for small to medium-sized surfaces

Ord.no.	41855
+ Adapter D12	12441
Inlet	M22x1.5 AG
Ø	mm 300
Operating pressure	bar MPa 180 18
Water output max.	l/min 12
Weight	kg 1.9
Nozzle size	045



Round Cleaner UFO long stainless steel

for small to medium-sized surfaces

Ord.no. Nozzle size 045	41891
Ord.no. Nozzle size 055	41890
Ø	mm 350
Operating pressure	bar MPa 210 21
Water output max.	l/min 15
Weight	kg 5.5



Round Cleaner INOX 410

for large to very large surfaces

Ord.no.	41814
Ø	mm 410
Operating pressure	bar MPa 180 18.0
Water output max.	l/min 14
Weight	kg 3.6
Nozzle size	045

** When used with Starlet 3, the lance extension Ord.no. 411544 is required.

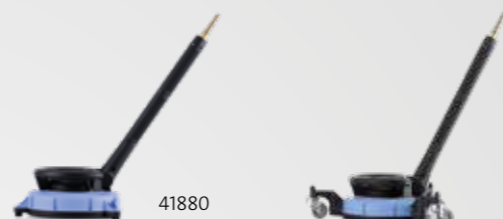

Round Cleaner UFO long

for small to medium-sized surfaces

Ord.no. without wheels	41880
Ord.no. with wheels	41881
Ø	mm 300
Operating pressure	bar MPa 180 18
Water output max.	l/min 12
Weight without wheels	kg 2.4
Weight with wheels	kg 3.1
Nozzle size	045



Round Cleaner INOX 300

for medium-sized to large surfaces

Ord.no.	41813
Ø	mm 300
Operating pressure	bar MPa 160 16.0
Water output max.	l/min 12
Weight	kg 2.9
Nozzle size	045



Round Cleaner INOX 520

for large to very large surfaces

Ord.no.	41812
Ø	mm 520
Operating pressure	bar MPa 220 22.0
Water output max.	l/min 26
Weight	kg 11.4
Nozzle size	06

FOAM CLEANING | ADDITIVE



135303



135313

Foam lance

Production of highly effective foam
 ■ adjustable spraying angle (spot jet - flat-jet)
 ■ incl. screw cap

Container	Liter	Ord.no.
1		135303
2		135313



SPOT JET



FLAT-JET

1 Liter



2 Liter

Spare container foam lance

For changing and storing cleaning agents

Container without lid	Ord.no.
1 Liter	135320
2 Liter	135321
Screw cap	135336

412710



412711

412721



412731



Kränzle Neutral

Universal cleaner for removal of strong contaminations
 ■ pH value**: 8.5
 ■ Mixing ratio: 1:3

Container	Liter	Ord.no.
1		412710
5		412711
25		412712
950		412718 NEW

Kränzle Plus

Special cleaner to degrease and clean
 ■ pH value**: 10.5
 ■ Mixing ratio: 1:3

Container	Liter	Ord.no.
5		412721
25		412722

Kränzle Marine

Highly alkaline intensive cleaner dissolves soot, oil and grease stains
 ■ pH value**: 11.0
 ■ Mixing ratio: 1:3

Container	Liter	Ord.no.
5		412731
25		412732



Special Descaler

Descaling concentrate for the heating coil of hot water pressure washers
 ■ pH value**: 0.5

Container	Liter	Ord.no.
1		412580



High-performance transmission oil

For all Kränzle high pressure pumps

Container	Liter	Ord.no.
0.25		400931
1		400932
5		400933
20		400934



Important note:

When using chemical cleaning agents, observe the respective regulations, provisions, safety notes and safety data sheets. Safety data sheets under: www.kraenzle.com/sda

**pH value: Undiluted

We recommend testing the cleaning agent on the surface to be cleaned before starting.

POWERFUL TOOL FOR PROFESSIONAL CLEANING WORK

TELESCOPIC LANCE

The telescope lance offers a convenient and effective solution for cleaning hard-to-reach places at great heights. With this telescope lance, you can work without scaffolding or a lifting platform and safely clean various surfaces from the ground, including facades, ceilings, glass surfaces and solar installations.



INTERNAL HIGH PRESSURE HOSE
ensures a reliable and safe water supply during the the cleaning process



CARRYING STRAP

As an option, the telescopic lance can be supplied with a carrying or shoulder strap to make transport and handling even more repeated comfortable.

Ord.no. 122100



Telescopic lance

For easy cleaning of hard-to-reach places at great heights. Clean without scaffolding or lifting platform - safely from the ground.

Ord.no.	121900	
Inlet/Outlet	M22x1.5 AG	
Length min. max.	m	2.4 5.4
Operating pressure with cleaning brush max.	bar MPa	40 4
Water output max.	l/min	30



Nozzle holder with pressure adjustment

NEW

Ord.no. without nozzle**	122110-XXX
--------------------------	------------



Cleaning brush transverse

EXPERT TIP

- Natural bristles
- Connection M22x1.5 AG

Ord.no.	410500
---------	--------

** High-pressure nozzle must be ordered separately.



SPECIAL ACCESSORIES



128060

Cleaning brush transverse

- Natural bristles
- Brush head LxW: 240x90 mm
- with anti-twist protection (500 mm)

Pipe length	mm	Ord.no.
500		128060
750		128061



128062

Cleaning brush transverse

- Natural bristles
- Brush head LxW: 240x90 mm
- with grip plates

Pipe length	mm	Ord.no.
1000		128062
1250		128063
1500		128064



optional

Cleaning brush flat

- Plastic bristles

Ord.no.	41073
+ Adapter D12	12441
Inlet	M22x1.5 AG
Dimensions LxW	mm 180x65



Sludge sucker

- Extraction of mud from pools and ponds
- For high-pressure cleaners from 10 l/min

Ord.no.	41791
Inlet	M22x1.5 AG
Length	m 2
Operating pressure max.	bar MPa 250 25
Water output max.	l/min 20
Suction height max.	m 3
Suction power at 130 bar / 220 bar	l/h 10000 17500
Nozzle size (factory fitted)	● 055



Sludge sucker

- Extraction of mud from pools and ponds
- For high-pressure cleaners from 10 l/min
- hose diameter 1 1/2"

Ord.no.	41104
Inlet	M22x1.5 AG
Hose length	m 3.8
Operating pressure max.	bar MPa 250 25
Water output max.	l/min 20
Suction height max.	m 3
Suction power at 130 bar / 220 bar	l/h 10000 17500
Nozzle size (factory fitted)	● 055



410506

Rotating washing brush

- Natural bristles
- Brush head Ø: 180 mm
- with anti-twist protection

Pipe length	mm	Ord.no.
342		410506



410507

Rotating washing brush

- Natural bristles
- Brush head Ø: 180 mm
- with grip plates

Pipe length	mm	Ord.no.
1000		410507
1250		410508
1500		410509



optional

Spray guard

- For cleaning surfaces without splashing water
- Applicable for all washing lances

Ord.no.	132600
Dimensions LxW	mm 285x190

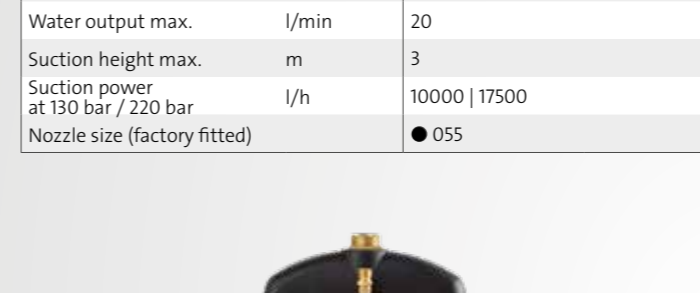

Pool cleaner attachment

- Attachment for stainless steel mud extractor

Ord.no.	418030
Inlet	M22x1.5 AG
Dimensions L	mm 320
Operating pressure max.	bar MPa 250 25
Water output max.	l/min 20
Suction height max.	m 3
Suction power at 130 bar / 220 bar	l/h 10000 17500
Nozzle size as standard	● 055

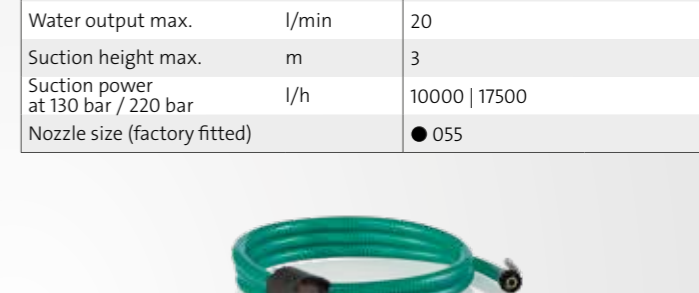

Suction hose with suction filter

- For high-pressure cleaners with a motor speed of 1400 rpm and a water output of at least 10 l/min
- with return valve

Ord.no.	150383
Inlet	3/4" IG
Hose length	m 3



Sandblaster set (wet blasting)

- for blasting sandstone and facades
- with hose and intake lance

Ord.no.	41068
+ Adapter D12	12441
Inlet	M22x1.5 AG
Operating pressure min.	bar MPa 130 13
Water output min.	l/min 10
for blasting material	mm 0.2 - 2.0
Nozzle size	● 055



Pipe cleaning hose with nozzle

- Operating pressure max.: 200 bar | 20 MPa
- Nozzle size without front bore: KN 055
- other nozzles on request**
- Nozzle size with front bore: KNF 055

Length	m	Ord.no. without front bore	Ord.no. with front bore
10		12550	12550-F
15		125501	125501-F
20		125502	125502-F
25		125503	125503-F
30		125504	125504-F

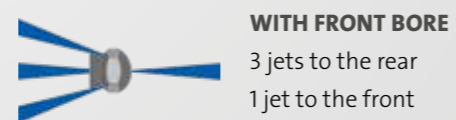
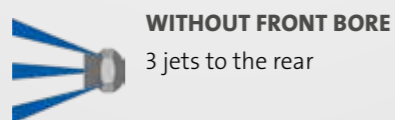

Water inlet filter

- Inlet and outlet in brass execution, except article: 13310

Inlet	Outlet	Ord.no.
3/4" AG (Plastic connection)	3/4" IG (Screw connection)	13310
3/4" AG	3/4" IG (Screw connection)	133003
Quick release coupling with claws (GEKA)	Quick release coupling with claws (GEKA)	133005
3/4" AG	3/4" IG (Screw connection)	133201



STAINLESS STEEL TABLE - PERFECT FOR WS/WSC-RP PRESSURE WASHERS

NEW

The stainless steel table has been specially designed for WS/WSC-RP devices and is characterised by its high stability, comfort and flexibility. A particularly practical feature is that no complex drilling in the wall is required, enabling simple and quick installation. Thanks to the rustproof stainless steel, the table is ideal for use in wet areas.

BRACKETS FOR RUBBER BUFFERS

Serve to secure the pressure washers easily and safely. At the same time, they dampen vibrations.



MOUNTING HOLES

specially designed for automatic hose reel and lance quiver bottom



ADJUSTABLE FEET

Height-adjustable, compensate for uneven surfaces and ensure a secure footing

STAINLESS STEEL TABLE

Material	Stainless steel
Dimensions L x W x H	77 58 73
Ord.no.	16206



EVERYTHING IN PLACE

ACCESSORIES ORGANISER

The search is over: with the correct accessories, Kränzle gives you the versatility to clean even the most difficult jobs. To ensure that all utensils are always within reach and that you don't lose track of them, Kränzle offers a variety of practical storage solutions. These are compatible with the complete range of Kränzle accessories - also for accessories with M22 threaded screw connection.

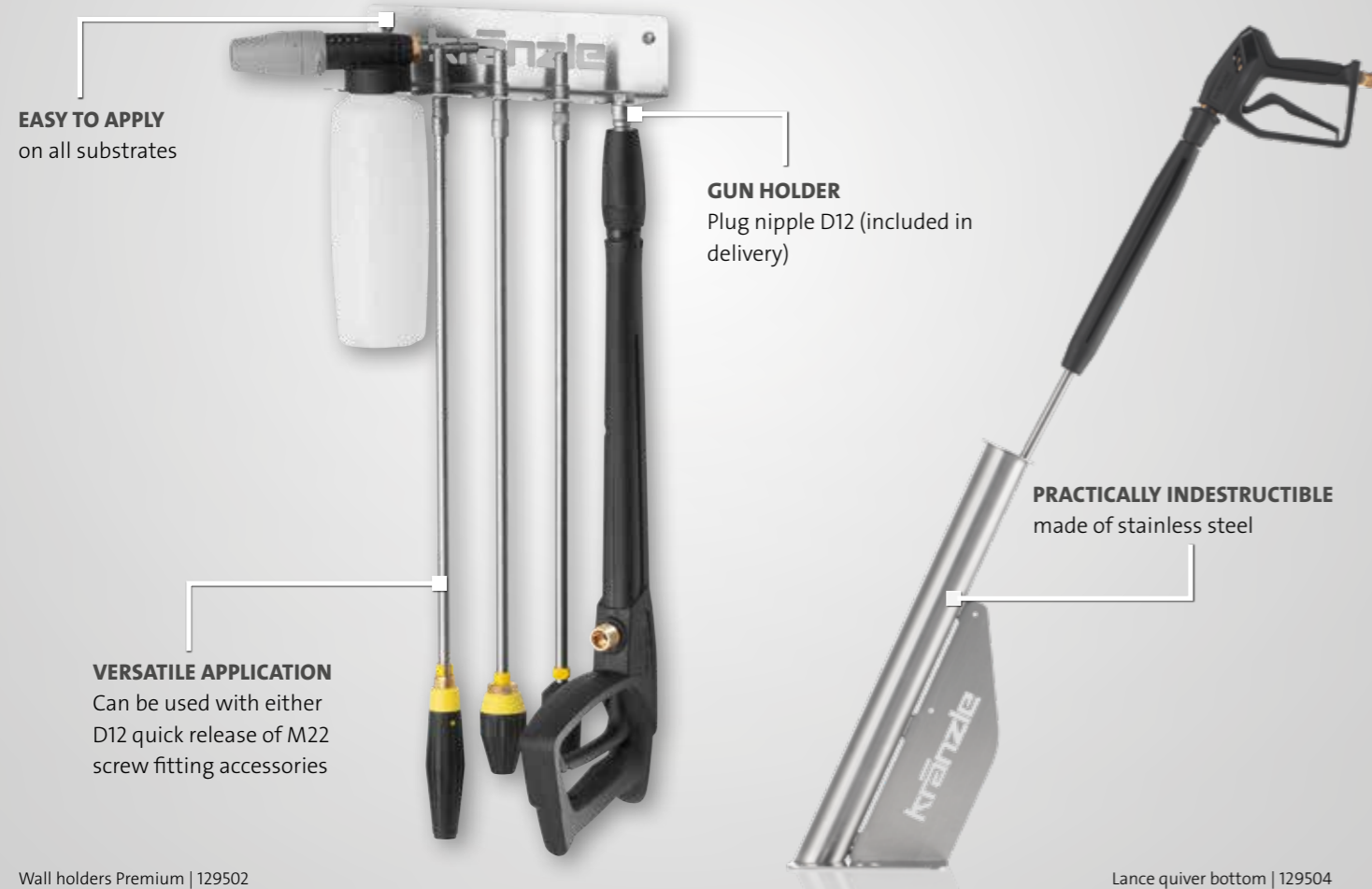

Wall holders Premium | 129502

Lance quiver bottom | 129504

ACCESSORIES

LANCE HOLDER | HOSE REELS



Lance quiver bottom

For floor mounting, with leakage connection
 ■ Suitable for stowing 2 lances

Ord.no.	129504
Pipe length	mm 590
Ø	mm 55



Lance quiver wall

For wall mounting
 ■ not suitable for lances with turbo killer

Ord.no.	129505
Pipe length	mm 590
Ø	mm 55



Retrofit parts for automatic hose reel

■ therm-RP, therm-1, therm 1017

Ord.no.	48950
HP hose	m 20 (DN8)



Automatic hose reel

■ incl. connection hose 2 m

Ord.no.	43855
HP hose	m 20 (DN8)



Automatic hose reel stainless steel

■ incl. connection hose 2 m

incl. HP hose	m	Ord.no.
20 (DN8)		412681
30 (DN8)		412691

WALL HOLDERS



Wall holders Lances

Space-saving storage of up to seven lances and washing brushes
 ■ incl. gun holder D12

Ord.no.	129500
Dimensions LxWxH mm	300x50x70



Wall holders Foam lance

Large trough for practical attachment of the Foam lance

Ord.no.	129501
Dimensions LxWxH mm	80x70x70



Wall holders Premium

For the storage of up to four cleaning lances and one foam lance
 ■ incl. gun holder D12

Ord.no.	129502
Dimensions LxWxH mm	300x70x70

ADAPTER



Conversion kit - flow monitor

For leakage protection in the pipe network. Suitable for non-monitored areas

Ord.no.	126342
Flow rate	l/min 4



Pipe ventilation with non-return valve

Installation between device and drinking water pipe
 ■ with return valve

Ord.no.	410164
Inlet	3/4" IG
Outlet	3/4" AG



44192

Chimney adapter

For indoor installations
 ■ for all oil-heated therm-Series
 ■ Ø 200 mm

Length	mm	Ord.no.
200		44192
385		441921

AS SAFE AS EVER, AS FAST AS NEVER BEFORE



CONVERSION TO PLUG-IN SYSTEM D12

The threaded connection has always been a guarantee for the reliable connection between safety shut-off gun and lances. With the innovative quick-change plug-in system D12, we have further developed this proven technology: The plug-in coupling combines the usual safety with additional comfort. By simply plugging in, the lances can be changed more conveniently and quickly than ever before.

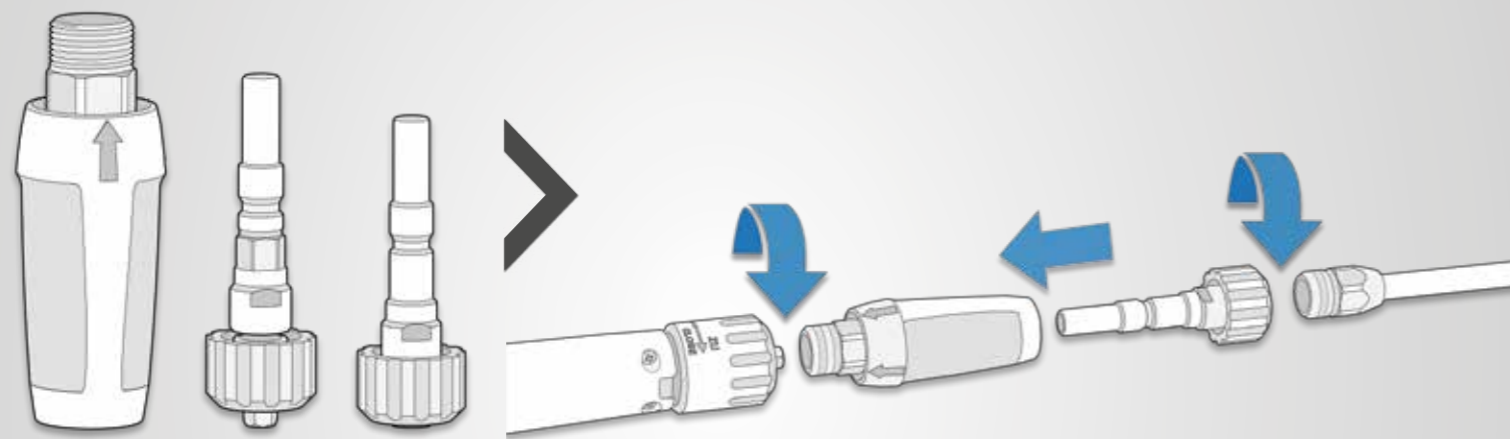

CONVERSION KIT | Ord.no. 13455

- Attachment plug-in system D12
- Plug nipple D12 with anti-twist protection
- Plug nipple D12 without anti-twist protection

CONVERSION MADE EASY

- Screw the attachment plug-in system onto the trigger gun M22
- Screw the accessories with the M22 threaded screw onto the plug nipple
- Snap the plug nipple into the attachment plug-in system

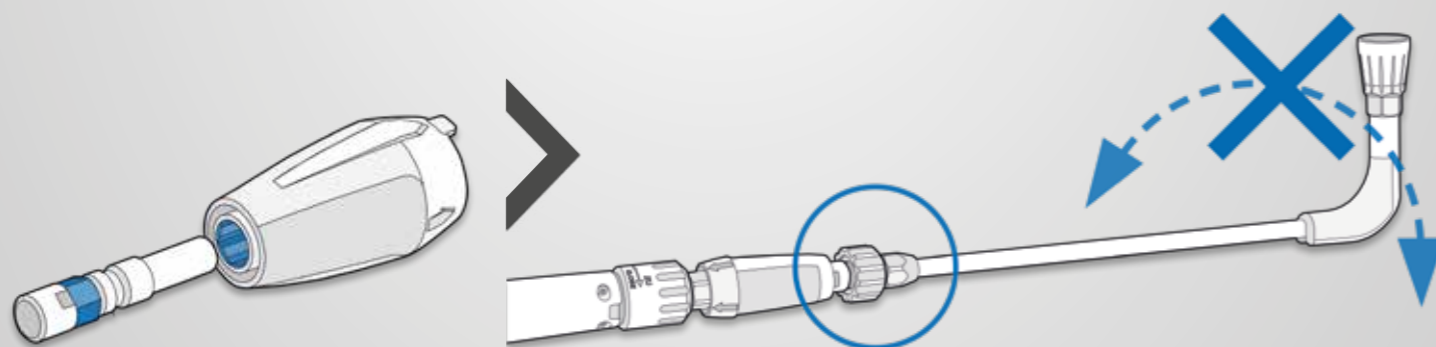

HEXAGONAL COUPLING

The external hexagon of the plug nipple with anti-twist protection fits perfectly into the internal hexagon of the Attachment plug-in system D12.

SECURED AGAINST TWISTING

Thanks to the plug-in nipple with hexagonal coupling, lances and accessories can be locked in six different positions. This makes unintentionally twisted accessories a thing of the past.

ACCESSORIES | QUICK RELEASE PLUG-IN SYSTEM D12

CONVERSION TO PLUG-IN SYSTEM D12



Conversion kit plug-in system D12

For converting trigger gun with safety catch and accessories with thread screw M22 to quick-change plug-in system D12.

Attachment plug-in system	Adapter 1	Adapter 2	Ord.no.
M22x1,5 AG ▶ D12	Plug nipple D12 without anti-twist protection	Plug nipple D12 with anti-twist protection	13455



124415



12440

Adapter Thread screw M22 ▶ plug-in system D12

For use of the accessories with thread screw M22 for trigger gun with safety catch with plug-in system D12

Inlet	Outlet	Anti-twist protection	Length mm	Ord.no.
Plug nipple D12	M22x1,5 IG	–	100	12441
Plug nipple D12	M22x1,5 IG	●	100	124415
Plug nipple D12	M22x1,5 IG	–	400 grip plates	12440



Attachment plug-in system D12

For converting trigger gun with safety catch to quick-change plug-in system D12.

Ord.no.	12443
Outlet	D12

ACCESSORIES THREAD SCREW M22

FOR DEVICES PRODUCED BEFORE 2020

Since 2020, all high-pressure cleaners will be equipped exclusively with the innovative quick-change plug-in system D12. The previous cleaning accessories with threaded fittings for existing Kränzle units are of course still available.

► **DOWNLOAD: ACCESSORIES CATALOGUE M22**
Scan QR code



HIGH PRESSURE HOSES



Standard

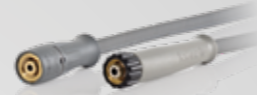

NoM

Steel braided high-pressure hose

Inlet Outlet: M22x1.5 IG		Rotating screw connection		Bend protection		Other versions on request			
Length	m	Steel braided layers	SN	Operating pressure	bar MPa	Temperature max.	°C	Ord.no. Standard	Ord.no. NoM
10 (DN6)	1			210 21		100		43416	434162
20 (DN6)	1			210 21		100		434161	434163
10 (DN8)	1			230 23		150		44878	–
10 (DN8)	2			400 40		150		41081	410811
15 (DN8)	1			230 23		150		44879	–
15 (DN8)	2			400 40		150		–	410821
25 (DN8)	2			400 40		150		41084	410841
30 (DN8)	2			400 40		150		41080	410801



Standard

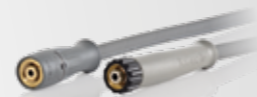

NoM

Replacement hose - for pressure washers with hose reel

Outlet: M22x1.5 IG		Rotating screw connection		Bend protection		Other versions on request				
Device series	Length	m	Steel braided layers	SN	Operating pressure	bar MPa	Temperature max.	°C	Ord.no. Standard	Ord.no. NoM
K 1050	12 (DN6)		1		210 21		100		49116	–
X-Series	15 (DN6)		1		210 21		100		498000	480151
K 1154, K 1152, K 2000	15 (DN6)		1		210 21		100		48015	480151
Profi	15 (DN6)		1		210 21		100		43829	438291
small quadro	15 (DN6)		1		210 21		100		40170	401701
quadro 599/799	20 (DN6)		1		210 21		100		434161	434163
quadro 899	15 (DN8)		1		210 21		100		44879	410821
large quadro, Profi-Jet, B, Primus AT	20 (DN8)		2		400 40		150		41083	410831
therm C, therm CA	15 (DN8)		1 / NoM: 2		210 21 / NoM: 400 40		150		44879	410821
LX-RP, therm-RP, therm 1, e-therm, Primus, Primus-RP	20 (DN8)		2		400 40		150		443812	443813
therm-RP 900 AT	15 (DN8)		2		400 40		150		44876	–



Connecting hose

Inlet Outlet: M22x1.5 IG		Steel braided layers		Operating pressure		Ord.no.	
Length	m		SN	bar MPa			
1 (DN8)	2			400 40			41265
2 (DN8)	2			400 40			412651



Hose connector / joining piece

Ord.no.	13286
Inlet	M22x1.5 AG
Outlet	M22x1.5 AG



**THEY BELONG
IN EVERY HOME**

PRESSURE WASHERS FOR PRIVATE USERS

EXCEPTIONAL QUALITY FOR YOUR HOME

High-quality technology attractively packaged: Kränzle offers the Quickly and the K 1050-Series for demanding domestic tasks. The devices are characterised on the outside by a shapely and compact housing, in the inside are the sophisticated features and quality materials of our professional cleaning equipment. A well thought out range of accessories makes the cleaners real all-rounders.



TECHNICAL HIGHLIGHTS



QUICK RELEASE PLUG-IN SYSTEM D10

Sophisticated, fast and reliable: The quick release plug-in system D10 with hardened stainless steel components ensures simple and safe connection of the safety shut-off gun with the lance.



INTELLIGENT SOLUTIONS FOR DOMESTIC USERS

First-class and functional: Kränzle pressure washers can also be used for private users who expect only the best. Many of the components from the professional range for example the Brass pump head, stainless-steel plungers and roto-moulded chassis are used in the K 1050 range.



TOTAL-STOP SYSTEM

Full control: The Total stop system turns the motor on when the trigger gun is engaged and off when the trigger is released. This makes the machine more efficient and economical with less noise and reduced wear.



HOSE REEL

Practical and comfortable: After washing, the high-pressure hose can neatly and safely stored away thanks to the heavy-duty hose drum and crank handle.



COMPACT DESIGN

The ideal union of form and function: Not only for the performance features, but also in terms of mobility Kränzle has thought about the handling. The devices are easy to transport and thanks to the compact Housing shape it is neat and space-saving.



MANY POSSIBILITIES OF USE

No application without a Kränzle: Thanks to a wide range of accessories the powerful pressure washers are equipped in such a way that they will be available for almost every Cleaning task in and around the house.

Quickly



ACCESSORIES STORAGE
for convenient stowage of the accessories and the power cable

TRAY FOR WORK BREAKS
clever holder for the high-pressure gun during work breaks

PRACTICAL HOSE HOLDER
for tidy storage of the high-pressure hose

**INCLUDING FLOOR CLEANER
ROUND CLEANER UFO**
for simple and efficient cleaning of driveways, terraces and co

**OFF-ROAD CAPABILITY
AND STABILITY**
robust chassis for easy transport and high stability

TOTALSTOP-SYSTEM
switches off the pump if the high-pressure gun is not operated during work breaks

MODEL	Quickly
Ord.no.	497500

TECHNICAL SPECIFICATIONS		
Operating pressure	bar MPa	130 13
Water output	l/min l/h	6.3 380
Admissible overpressure	bar MPa	145 14.5
Motor speed	Rpm	2800
Connection	V ~ Hz A	230 1 50 7.9
Power intake Power output	kW	1.8 1.35
Power supply cable	m	5
Plug		Schuko
Dimensions L x W x H	mm	420 285 900
Weight	kg	20

EQUIPMENT		
High-pressure hose	m Ord.no.	8 (DN6) 497070
Trigger gun with safety catch	Model Ord.no.	Starlet 4 12520
Lance with flat-jet nozzle	Nozzle Ord.no.	● 028 12900-028
Lance with Dirtkiller	Nozzle Ord.no.	● 028 42403-028
Round Cleaner UFO	Ø mm Ord.no.	260 41870
Water inlet filter	Ord.no.	13311

► ACCESSORIES | page 106

EQUIPMENT

-  Quick release plug-in system D10
- Kränzle axial pump
- Total-stop system
- Water inlet filter
- High-pressure hose



K 1050-Series



ROTO-MOULD CHASSIS
practically indestructible plastic housing

CONVENIENT INTEGRATED HOSE REEL (TST)
space-saving storage of the high-pressure hose - with foldable crank

ACCESSORY STORAGE
neat storage for high pressure gun and lances

CARRY HANDLE
portable and space-saving compact design

OFF-ROAD CAPABILITY AND STABILITY
robust chassis for easy transport and high stability



K 1050 TST | 495101
K 1050 P | 49501



MODEL	K 1050 P	K 1050 TS	K 1050 TST
Ord.no.	49501	495051	495101

TECHNICAL SPECIFICATIONS

		K 1050 P	K 1050 TS	K 1050 TST
Model		portable	with hose holder	with hose drum
Operating pressure	bar MPa	130 13	130 13	130 13
Water output	l/min l/h	7.5 450	7.5 450	7.5 450
Admissible overpressure	bar MPa	160 16	160 16	160 16
Motor speed	Rpm	2800	2800	2800
Connection	V ~ Hz A	230 1 50 9.6	230 1 50 9.6	230 1 50 9.6
Power intake Power output	kW	2.2 1.65	2.2 1.65	2.2 1.65
Power supply cable	m	5	5	5
Plug		Schuko	Schuko	Schuko
Dimensions L x W x H	mm	390 290 370	340 350 860	340 350 860
Weight	kg	21	23	26

EQUIPMENT

		K 1050 P	K 1050 TS	K 1050 TST
High-pressure hose	m Ord.no.	8 (DN6) 410541	8 (DN6) 410541	12 (DN6) 49116
Trigger gun with safety catch	Model Ord.no.	Starlet 4 12520	Starlet 4 12520	Starlet 4 12520
Lance with flat-jet nozzle	Nozzle Ord.no.	○ 03 12900-03	○ 03 12900-03	○ 03 12900-03
Lance with Dirtkiller	Nozzle Ord.no.	optional	○ 03 42403-03	○ 03 42403-03
Water inlet filter	Ord.no.	13311	13311	13311

► ACCESSORIES | page 106



EQUIPMENT

- Quick release plug-in system D10
- Kränzle axial pump
- Total-stop system
- Water inlet filter

MODELS

- K 1050 P - portable
- K 1050 TS - mobile with hose support
- K 1050 TST - mobile with hose drum



OPTIMALLY EQUIPPED FOR EVERY TASK

House, yard and garden always tip-top: a pressure washer is suitable for many jobs where thorough cleaning is required. With the versatile Kränzle accessories programme, users can extend the range of applications even further - whether leaves from the gutter or the moss in the driveway has to be removed, the bicycle needs a wash or the clogged drain causing problems.

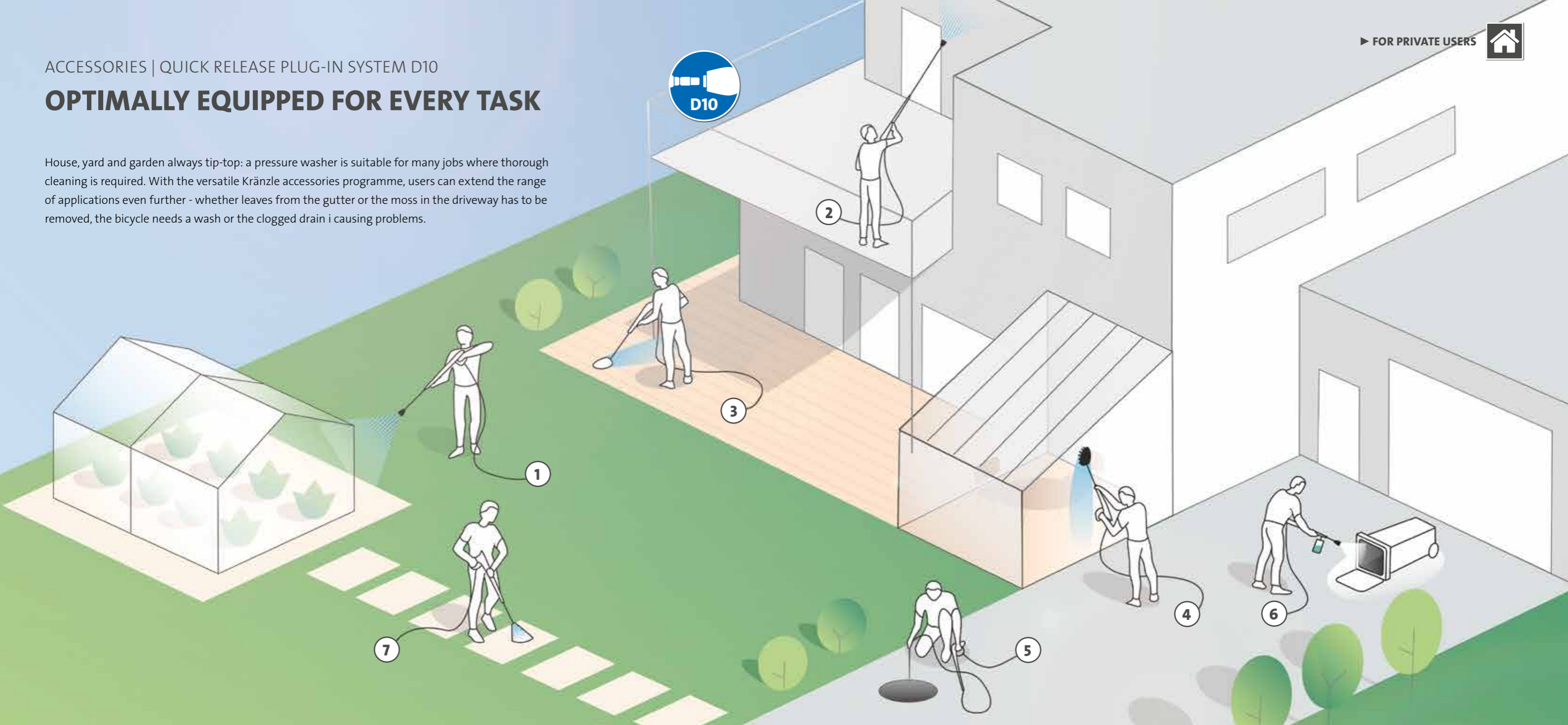

TECHNICAL HIGHLIGHTS

QUICK RELEASE PLUG-IN SYSTEM D10

Sophisticated, fast and reliable: The quick release plug-in system D10 with hardened stainless steel components ensures simple and safe connection of the safety shut-off gun with the lance.

ANTI-TWIST PROTECTION

Accessories equipped with an anti-rotation device can be locked in different positions. This prevents the accessories from twisting unintentionally and allows them to be guided by moving the gun.



1. ROTATING DIRTKILLER NOZZLE:

Generates a rotating spot jet that removes even the most stubborn dirt

2. LANCE EXTENSION:

Makes ladder and co. unnecessary. For easy access to hard-to-reach places

3. ROUND CLEANER UFO:

With two rotating high-pressure nozzles for easy and efficient cleaning of larger areas such as driveways or patios lub tarasy

4. ROTATING WASHING BRUSH:

The soft bristles of the washing brush allow for a gentle cleaning of sensitive surfaces

5. PIPE CLEANING HOSE:

Hose with 10 metre length for easy access to and effective removal of blockages in pipes and drains

6. FOAM LANCE:

Produces effective foam to dissolve coarse soiling (combined with Kränzle Neutral)

7. SPLASH GUARD:

Transparent attachment that encloses the high-pressure jet and protects the surroundings from splashing water

FOR K 1050-SERIES AND QUICKLY



Starlet 4

For K 1050-Serie and Quickly
 ■ Inlet: M22x1.5 AG
 ■ Outlet: Plug-in connection D10

Ord.no.	12520
----------------	--------------



12900-03

Lance with flat jet nozzle

■ For normal dirt

Length	mm	Nozzle size	Ord.no.
400		● 028	12900-028
400		○ 03	12900-03



42403-03

Dirtkiller lance

■ For stubborn dirt

Length	mm	Nozzle size	Ord.no.
400		● 028	42403-028
400		○ 03	42403-03

12905-M2003

Lance with regulating nozzle NEW

Adjustable working pressure, high- and low-pressure

Length	mm	Nozzle size	Ord.no.
400		● 028	12905-M20028
400		○ 03	12905-M2003



Lance extension

■ Anti-twist protection

Ord.no.	12870
Length	mm 400



Round Cleaner UFO

Floor Cleaner for small and medium-sized surfaces

Ord.no.	41870
∅	mm 260



Rotating washing brush

■ Anti-twist protection

Ord.no.	12800
Brush head ∅	mm 180
Pipe length	mm 210



Spray guard

■ Applicable for all washing lances

Ord.no.	132600
Dimensions LxW	mm 285x190



Pipe cleaning hose

■ Removes stubborn pipe blockages

Ord.no.	12850
Length	m 10



412710

412711

Kränzle Neutral

Universal cleaner for removal of strong contaminations
 ■ pH value**: 8.5
 ■ Mixing ratio: 1:3

Container	Liter	Ord.no.
1		412710
5		412711



SPOT JET



FLAT-JET



135312

Foam lance

■ Produces dense, long-lasting foam

Ord.no. 1 Liter	135302
Ord.no. 2 Liter	135312



BRILLIANT RESULTS

EVEN WITHOUT

WATERPOWER

VACUUM CLEANERS | SWEEPERS

**pH value: undiluted. It is recommended to test the cleaning agent on the surface to be cleaned before starting.

VACUUM CLEANERS

**VERSATILE, POWERFUL
AND COMFORTABLE**

From the construction site to the salesroom to the workshop. The Ventos wet and dry vacuum cleaner, with integrated tool socket, is ideally equipped for all cleaning tasks. An automatic start-up, an automatic switchoff in case of the suction of liquids and the large drain plug ensure safe operation. The extra-long power cable and the suction hose offer a large action radius, and a wide range of accessories enables a thorough work.



TABLE OF CONTENTS

Ventos L-Series	110-111
Accessories Ventos L-Series	112-113
Ventos 12-Series	114-115
Accessories Ventos 12-Series	115

KEY INDUSTRIES



THE FILTER CLEANING MAKES THE DIFFERENCE



MANUAL FILTER CLEANING – VENTOS PC-MODELS

The manual Push-Clean feature of the Ventos PC ensures constant suction power and optimum cleaning performance. After pressing the push button, the airflow is diverted through the dust filter and it is cleaned in no time. The dirt simply falls into the collection container or the inserted dust bag, and the Ventos regains its full suction power.



AUTOMATIC FILTER CLEANING – VENTOS AC-MODELS

The Automatic-Clean filter cleaning function of the Ventos AC offers added convenience. Thanks to an additional rotary knob, it is possible to set the intervals at which an automatically triggered air blast cleans the flat pleated filter. This enables long filter service life and ensures uninterrupted and continuous operation at full suction power.

TECHNICAL HIGHLIGHTS



CONTROL PANEL

With the Ventos series, the user always has all functions in view. The control panel allows infinitely variable regulation of the suction power. In the case of the Ventos AC, the control panel also allows to set the interval for automatic filter cleaning.



AUTOMATIC START-UP

An integrated socket allows the connection of power tools (max. 2200 W). The automatic start-up function switches the vacuum cleaner on when the tool is switched on, and the run-on function ensures that the suction hose is completely emptied after the tool is switched off.



PRINCIPLE OF ARRANGEMENT

This means that the accessories are always within reach. Power cable and suction hose can be spooled and stowed easily. A semicircular holder on the top, into which the suction tube can be inserted, allows the industrial vacuum cleaner to be carried comfortably by holding the suction tube securely in the recessed grip.

Ventos L-Series



PRACTICAL

Handle with a holder for the suction tube for safe transport

COMFORTABLE

Socket outlet for power tools, with automatic start-up, automatic switch-off and overrun function

TIDY

Space-saving stowage of pipes, hose, cable and accessories

ROBUST

All-terrain chassis for mobility and high stability

SIMPLE

Drain screw for a problem-free draining of liquids after the sucking up of liquids

AS STANDARD

Extensive accessories to accomplish different cleaning tasks



Ventos 32 L/AC | 580020

► **ACCESSORIES** | page 112-113



EQUIPMENT

- Ventos PC: Push-Clean filter cleaning | Ventos AC: Automatic-Clean filter cleaning
- Wet and dry vacuuming
- integrated automatic on/off switch
- Mains connection of power tool (max. 2200 W)
- Container/filter bag volume sensor with LED display
- Storage space – for storing tools or work materials



CHOOSE FROM TWO DIFFERENT CONTAINER SIZES

MODEL	Ventos 32 L/PC	Ventos 42 L/PC	Ventos 32 L/AC	Ventos 42 L/AC
Ord.no.	580000	580040	580020	580060

TECHNICAL SPECIFICATIONS

	Ventos 32 L/PC	Ventos 42 L/PC	Ventos 32 L/AC	Ventos 42 L/AC
Dust class	L	L	L	L
Filter cleaning	Manual	Manual	Automatic	Automatic
Volumetric flow rate turbine max	l/min	4500	4500	4500
Depression turbine max	kPa mbar	25 250	25 250	25 250
Connection	V ~ Hz A	230 1 50 16	230 1 50 16	230 1 50 16
Power consumption	W	1200	1200	1200
Container volume	l	30	40	30
Filling volume water intake	l	30	40	40
Sound pressure level at workplace	db (A)	68.3	68.3	68.3
Protection class	IPx4	IPx4	IPx4	IPx4
Power supply cable	m	7.5	7.5	7.5
Plug	Schuko	Schuko	Schuko	Schuko
Dimensions L x W x H	mm	590 365 565	590 365 645	590 365 645
Weight	kg	18.5	19	19.3

EQUIPMENT

	Quantity Ord.no.	Ventos 32 L/PC	Ventos 42 L/PC	Ventos 32 L/AC	Ventos 42 L/AC
Dust bag	Quantity Ord.no.	5 454511	5 454521	5 454511	5 454521
Disposal bag	Quantity Ord.no.	1 454551	1 454561	1 454551	1 454561
Folded filter	Dust class Ord.no.	L 457079	L 457079	L 457079	L 457079
Suction hose antistatic	m Ord.no.	4 (DN 32) 452825	4 (DN 32) 452825	4 (DN 32) 452825	4 (DN 32) 452825
Hand tube	Ord.no.	584031	584031	584031	584031
Extension tube	Quantity Ord.no.	2 584032	2 584032	2 584032	2 584032
Floor nozzle	Ord.no.	584035	584035	584035	584035
Brush nozzle	Ord.no.	584008	584008	584008	584008
Joint nozzle	Ord.no.	584023	584023	584023	584023
Tool adapter	Ord.no.	584112	584112	584112	584112



THE RIGHT EQUIPMENT FOR EVERY REQUIREMENT

Whether you need to clean hard-to-reach areas or use it on large surfaces: With the accessories included as standard, the Ventos-Series is already optimally equipped for the most common cleaning tasks. Our optionally available range of special accessories also meets the highest requirements and particularly demanding tasks. **Accessories with a connection diameter of 35 are compatible with all Ventos 32 and Ventos 42 models.**



Dust bag

■ tear-resistant fleece filter bag for dry vacuuming

Ord.no.	454511	454521
Quantity	5	5
Filling volume Litres	30	40



Disposal bag

■ for Ventos PC and Ventos AC

Ord.no.	454551	454561
Quantity	5	5
Filling volume Litres	30	40



Folded filter

■ for Ventos PC and Ventos AC

Ord.no.	457079
Dust class	L
Dimensions L x W mm	240 140



Suction hose

■ antistatic

Ord.no.	452825
Dimensions L m	4 (DN32)
Connection Ø mm	45



Hand tube

■ with air slide

Ord.no.	584031
Dimensions L mm	320
Connection Ø mm	45 35



Extension tube

■ Galvanised steel

Ord.no.	584032
Dimensions L mm	2 x 500
Connection Ø mm	35



Floor nozzle

for wet and dry vacuuming

Ord.no.	584035
Dimensions L mm	360
Connection Ø mm	35



Brush nozzle

for simultaneous vacuuming and brushing

Ord.no.	584008
Brush Ø mm	70
Connection Ø mm	35

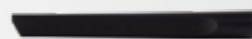

Joint nozzle

for use in narrow places

Ord.no.	584023
Dimensions L mm	300
Connection Ø mm	35



Tool adapter

for suction of power tools

Ord.no.	584112
Dimensions L mm	120
Connection Ø mm	45 35

USE OF POWER TOOLS

The tool adapter or the optionally available tool suction hose are compatible with almost all common power tool brands. Dust and flying chips are effectively extracted, which guarantees comfortable as well as dust-free working.

Tool connection: Ø 25 mm



Floor nozzle

■ made of aluminium, light and robust
■ with integrated brush and rubber strips

Ord.no.	584028
Dimensions L mm	450
Connection Ø mm	35



Turbo brush

for the thorough cleaning of carpets
■ with driven brush roller

Ord.no.	584024
Dimensions L mm	280
Connection Ø mm	35



Carpet nozzle

for carpets and smooth surfaces
■ Adaptable to the respective surface

Ord.no.	584018
Dimensions L mm	295
Connection Ø mm	35



Tool-Suction hose

for suction of power tools

Ord.no.	452828
Dimensions L m	4 (DN32)
Connection Ø mm	45 35



Upholstery nozzle

for cleaning textile surfaces

Ord.no.	584009
Dimensions L mm	145
Connection Ø mm	35



Wide nozzle

for use in narrow places

Ord.no.	584012
Dimensions L mm	250
Connection Ø mm	45



Universal brush nozzle

for simultaneous vacuuming and brushing

Ord.no.	584017
Dimensions L mm	230
Connection Ø mm	35



Suction brush

gentle pet care without tiresome shedding

Ord.no.	584020
Dimensions L mm	235
Connection Ø mm	35



Suction currycomb

removes gross impurities from animal skins

Ord.no.	584019
Dimensions L mm	240
Connection Ø mm	35



Folded filter Wet + Dry

■ for Ventos PC and Ventos AC

Ord.no.	457120
Dust class	M, L
Dimensions L x W mm	240 140

ACCESSORIES FOR OLDER VENTOS MODELS



Dust bag

■ for Ventos 20 E/L

Ord.no.	454400
Quantity	5
Filling volume Litres	20



Dust bag

■ for Ventos 30 E/L

Ord.no.	454401
Quantity	5
Filling volume Litres	30



Filter

■ for Ventos 20 E/L, Ventos 30 E/L

Ord.no.	454403
Dust class	L
Ø mm	280

Ventos 12-Series



NEW



HANDGRIP
for comfortable and save transport

TIDY
Space-saving stowage of pipes, hose, cable and accessories

CASTOR WHEELS
make the vacuum cleaner easier to manoeuvre

TELESCOPIC SUCTION TUBE
adjustable between 59 and 97 cm working length

IMPACT PROTECTION
protects against damage

Ventos 12 | 570000

► **ACCESSORIES** | page 115

EQUIPMENT

- Compact, light and manoeuvrable
- Dust bag full indicator
- Large dust collection container
- Pluggable power cord
- Optional: HEPA cartridge filter (Ventos 12 HE)



MODEL	Ventos 12	Ventos 12 HE
Ord.no.	570000	570010
	NEW	NEW

TECHNICAL SPECIFICATIONS

Volumetric flow rate turbine max	l/min	3400	2800
Depression turbine max	kPa mbar	25 250	21.5 215
Connection	V ~ Hz A	230 1 50 4	230 1 50 4
Power consumption	W	900	650
Container volume	l	12	12
Filter		cartridge filter	HEPA cartridge filter
Sound pressure level at workplace	db (A)	59	65
Power supply cable	m	15	15
Plug		Schuko	Schuko
Dimensions L x W x H	mm	350 450 375	350 450 375
Weight (without accessories)	kg	7	7

EQUIPMENT

Fleece filter bag	Quantity Ord.no.	2 571003	2 571003
Cartridge filter	Ord.no.	571001	571002 HEPA
Suction hose	m Ord.no.	2.5 571004	2.5 571004
Aluminium telescopic tube	Ord.no.	571005	571005
Floor nozzle	Ord.no.	571006	571006
Combination floor nozzle	Ord.no.	571007	571007
Suction brush	Ord.no.	571008	571008
Joint nozzle	Ord.no.	571009	571009
Upholstery nozzle	Ord.no.	571010	571010

ACCESSORIES FOR VENTOS 12 MODELS



Power brush			
Quantity	1 piece	Order no.	571012
The motorised brush roller removes even the most stubborn dirt from carpets			



Paper filter bag			
Quantity	10 pieces	Order no.	571000

Fleece filter bag			
Quantity	10 pieces	Order no.	571003



Telescopic tube Plus			
Quantity	1 piece	Order no.	571011
Extendable up to 1.35 m, for hard-to-reach places			



Cartridge filter			
Quantity	1 piece	Order no.	571001

HEPA-Cartridge filter			
Quantity	1 piece	Order no.	571002



KRÄNZLE SWEEPERS

BEST SWEEP-ACTION CLEANING RESULTS INSIDE AND OUT

Clean in passing: Kränzle's manual sweepers ensure that cleanliness is easily maintained in both indoor and outdoor areas - e.g. on paths, driveways or terraces - resulting in clean floor surfaces. Also for commercial use, on farms or in workshops as well as in the craft sector or for cleaning buildings, there are multiple applications for these devices.

TECHNICAL HIGHLIGHTS



LONG CLEANING BRISTLES

Outside, the long bristles of smooth-running manual sweepers collect debris such as leaves, litter and other materials in the collection box. Indoors, they thoroughly remove dust and other particles.

INTEGRATED FREEWHEEL

Thanks to the integrated freewheel, the sweeping roller and side broom will turn sweeping material into the container.

EASY EMPTYING

The hopper made of impact resistant plastic can be used for emptying easily with the help of a practical handle and on the basis of its well thought-out construction.

TABLE OF CONTENTS

Colly 800	118-119
Kränzle 1+1	120-121

KEY INDUSTRIES



SWEEPERS

Colly 800



Colly 800 | 50079

EQUIPMENT

- Integrated free-wheel
- Dustpan principle
- Large waste bin, volume 30 liters
- 2 infinitely height-adjustable side brushes



MODEL	Colly 800
Ord.no.	50079

TECHNICAL SPECIFICATIONS

Drive		Manual
Area sweeping capacity at 2.5 km/h	m ² /h	2000
Waste bin volume	l	30
Exhaust air filter	mm ²	2 x 6000
Dimensions/standing position	mm	750 400
Working width (with 2 side brushes)	mm	800
Drive wheels Ø	mm	300
Sweeper roller Ø	mm	254
Dimensions L x W x H	mm	980 850 390
Weight	kg	19



Kränzle 1+1



EQUIPMENT

- Integrated free-wheel
- Dustpan principle
- large waste bin, volume 30 liters
- 1 infinitely height-adjustable side brush
- Height-adjustable main broom



MODEL	Kränzle 1+1
Ord.no.	50077

TECHNICAL SPECIFICATIONS

Drive		Manual
Area sweeping capacity at 2.5 km/h	m ² /h	1675
Waste bin volume	l	30
Dimensions/standing position	mm	1300 800
Working width (with 1 side brush)	mm	670
Drive wheels Ø	mm	285
Sweeper roller Ø	mm	250
Dimensions L x W x H	mm	1300 800 2060
Weight	kg	24



NOZZLE TABLE FLOW VOLUME

Nozzle-size	∅	20 / 2	30 / 3	40 / 4	50 / 5	60 / 6	70 / 7	80 / 8	90 / 9	100 / 10	110 / 11	120 / 12	130 / 13	140 / 14	150 / 15
0002 1502 2502	0.91	2.0	2.5	2.8	3.2	3.5	3.7	4.0	4.2	4.5	4.7	4.9	5.1	5.3	5.5
15025 25025	0.98	2.5	3.1	3.6	4.0	4.4	4.8	5.1	5.4	5.7	6.0	6.2	6.5	6.7	7.0
0003 1503 2503 4003	1.09	3.1	3.7	4.3	4.8	5.3	5.7	6.1	6.3	6.8	7.1	7.4	7.7	8.0	8.3
15035 25035	1.15	3.6	4.4	5.0	5.6	6.2	6.7	7.1	7.6	8.0	8.4	8.7	9.1	9.4	9.8
0004 1504 2504 4004	1.19	4.2	5.2	5.9	6.6	7.3	7.8	8.4	8.9	9.4	9.8	10.3	10.7	11.0	11.5
00045 15045 25045 40045	1.27	4.5	5.5	6.4	7.1	7.8	8.4	9.0	9.6	10.2	10.6	11.0	11.4	11.8	12.2
0005 1505 2505 4005	1.35	5.0	6.2	7.1	8.0	8.7	9.4	10.0	10.7	11.3	11.9	12.4	12.9	13.4	13.9
00055 15055 25055 40055	1.4	5.6	6.8	7.8	8.7	9.6	10.3	11.1	11.8	12.4	13.0	13.6	14.2	14.8	15.3
0006 1506 2506 4006	1.47	6.0	7.4	8.6	9.6	10.4	11.3	12.1	12.8	13.6	14.2	14.8	15.4	16.0	16.6
00065 15065 25065 40065	1.52	6.6	8.0	9.3	10.4	11.3	12.3	13.2	14.0	14.7	15.4	16.1	16.8	17.4	18.0
0007 1507 2507 4007	1.6	7.1	8.6	10.0	11.2	12.2	13.2	14.1	15.0	15.3	16.6	17.3	18.0	18.7	19.4
00075 15075 25075 40075	1.65	7.6	9.3	10.7	12.0	13.1	14.2	15.2	16.1	16.9	17.8	18.6	19.3	20.1	20.8
0008 1508 2508 4008	1.7	8.0	9.8	11.3	12.7	14.0	15.1	16.1	17.1	18.0	18.8	19.6	20.4	21.2	22.0
00085 15085 25085 40085	1.75	8.5	10.4	12.1	13.5	14.8	16.0	17.1	18.1	19.1	20.0	20.9	21.8	22.6	23.4
0009 1509 2509 4009	1.8	9.1	11.1	12.8	14.3	15.7	17.0	18.0	19.2	20.2	21.2	22.1	23.0	23.9	24.7
0010 1510 2510 4010	1.9	10.0	12.3	14.2	16.0	17.4	18.9	20.1	21.4	22.5	23.6	24.6	25.6	26.6	27.6
2511	2.6	11.2	13.7	15.9	17.7	19.4	21.0	22.4	23.8	25.1	26.3	27.5	28.6	29.7	30.7
2512	2.16	12.2	15.0	17.3	19.3	21.2	22.9	24.5	25.9	27.4	28.7	30.0	31.2	32.4	33.5

160 / 16	170 / 17	180 / 18	190 / 19	200 / 20	210 / 21	220 / 22	230 / 23	240 / 24	250 / 25	260 / 26	270 / 27	280 / 28	290 / 29	300 / 30	bar / MPa
5.7	5.9	6.0	6.2	6.4	6.6	6.7	6.8	6.9	7.0	7.1	7.3	7.4	7.5	7.6	l/min
7.2	7.4	7.6	7.9	8.1	8.3	8.5	8.6	8.8	9.0	9.2	9.4	9.5	9.7	9.9	l/min
8.6	8.9	9.1	9.3	9.5	9.7	9.9	10.1	10.3	10.5	10.6	11.2	11.4	11.6	11.8	l/min
10.1	10.4	10.7	11.0	11.3	11.6	11.8	12.1	12.4	12.6	12.9	13.1	13.3	13.6	13.8	l/min
11.9	12.2	12.6	12.9	13.3	13.6	13.9	14.2	14.5	14.8	15.1	15.4	15.7	16.0	16.3	l/min
12.6	13.0	13.4	13.8	14.2	14.6	15.0	15.3	15.6	15.9	16.2	16.7	17.1	17.4	17.7	l/min
14.3	14.7	15.1	15.5	15.9	16.3	16.7	17.1	17.5	17.9	18.2	18.6	18.9	19.2	19.6	l/min
15.8	16.3	16.7	17.1	17.5	17.9	18.3	18.7	19.1	19.5	19.9	20.4	20.7	21.1	21.5	l/min
17.1	17.6	18.1	18.6	19.1	19.6	20.1	20.5	20.9	21.3	21.7	22.3	22.7	23.1	23.5	l/min
18.7	19.4	19.9	20.4	20.9	21.4	21.9	22.4	22.9	23.4	23.8	24.1	24.6	25.0	25.5	l/min
20.0	20.6	21.2	21.8	22.4	22.9	23.4	23.9	24.4	24.9	25.4	25.9	26.4	26.8	27.3	l/min
21.5	22.2	22.8	23.4	24.0	24.6	25.2	25.8	26.3	26.8	27.3	27.9	28.4	28.9	29.4	l/min
22.8	23.5	24.2	24.8	25.4	26.0	26.6	27.2	27.8	28.4	29.0	29.5	30.1	30.6	31.1	l/min
24.1	24.9	25.6	26.3	27.0	27.7	28.3	28.9	29.5	30.1	30.7	31.4	31.9	32.5	33.1	l/min
25.5	26.3	27.1	27.8	28.5	29.2	29.9	30.6	31.3	31.9	32.5	33.2	33.8	34.4	35.0	l/min
28.5	29.4	30.2	31.0	31.8	32.6	33.4	34.1	34.9	35.6	36.3	36.9	37.6	38.3	38.9	l/min
31.7	32.7	33.6	34.6	35.5	36.3	37.2	38.0	38.8	39.6	40.4	41.2	42.0	42.7	43.4	l/min
34.6	35.7	36.7	37.7	38.7	39.6	40.6	41.5	42.4	43.2	44.1	44.9	45.8	46.6	47.4	l/min

Josef Kränzle GmbH & Co. KG

Rudolf-Diesel-Straße 20
89257 Illertissen (Germany)

phone: +49 (0) 7303 96 05-0

mail: sales@kraenzle.com

www.kraenzle.com

 [youtube.com/kraenzleDE](https://www.youtube.com/kraenzleDE)



Presented by your authorized Kränzle partner: