

Dell EMC PowerEdge R6515

Technical Guide

Notes, cautions, and warnings

 **NOTE:** A NOTE indicates important information that helps you make better use of your product.

 **CAUTION:** A CAUTION indicates either potential damage to hardware or loss of data and tells you how to avoid the problem.

 **WARNING:** A WARNING indicates a potential for property damage, personal injury, or death.

Chapter 1: Product overview	5
Introduction.....	5
Featured technologies.....	5
Chapter 2: System features	7
Product comparison.....	7
Chapter 3: Chassis views and features	8
Front view of the system.....	8
Rear view of the system.....	9
Inside the system.....	10
Quick Resource Locator fo Dell EMC PowerEdge R6515 system	11
Chapter 4: Processor	12
Processor features.....	12
Supported processors.....	12
Chapter 5: Memory	14
Supported memory.....	14
Memory speed.....	15
Chapter 6: Storage	16
Supported drives.....	16
Storage controllers.....	17
Optical drives.....	17
External Storage.....	17
Chapter 7: Networking and PCIe	19
Expansion card installation guidelines.....	19
Chapter 8: Power, thermal, and acoustics	23
Power.....	23
Thermal	24
Acoustics	24
Acoustics design.....	24
PowerEdge R6515 acoustics.....	25
Acoustical performance.....	29
PowerEdge acoustical dependencies.....	31
Methods to reduce acoustical output.....	31
Chapter 9: Supported operating systems	32
Chapter 10: Dell EMC OpenManage systems management	33

iDRAC9 with Lifecycle Controller.....	34
Agent-free management.....	37
Agent-based management.....	37
Dell EMC consoles.....	37
Dell EMC OpenManage systems management tools, utilities, and protocols.....	39
Integration with third-party consoles.....	40
OpenManage connections with third-party consoles.....	40
Chapter 11: Appendix A. Additional specifications.....	42
Chassis dimensions.....	42
Chassis weight.....	43
Video.....	43
USB.....	44
Environmental specifications.....	44
Thermal restrictions.....	46
Chapter 12: Appendix B. Standards compliance.....	48
Chapter 13: Appendix C Additional resources.....	49
Chapter 14: Dell Technologies Services	50
Dell EMC ProDeploy Enterprise Suite	50
Dell EMC ProDeploy Plus.....	51
Dell EMC ProDeploy.....	51
Dell EMC Basic Deployment.....	51
Dell EMC Server Configuration Services.....	51
Dell EMC Residency Services.....	51
Dell EMC Remote Consulting Services.....	51
Dell EMC Data Migration Service.....	51
ProSupport Enterprise Suite.....	51
Dell EMC ProSupport Plus for Enterprise.....	52
Dell EMC ProSupport for Enterprise.....	52
Dell EMC ProSupport One for Data Center.....	53
Support Technologies.....	53
Dell Technologies Education Services.....	54
Dell Technologies Consulting Services.....	54
Dell EMC Managed Services.....	55

Product overview

Topics:

- [Introduction](#)
- [Featured technologies](#)

Introduction

The Dell EMC PowerEdge R6515 (1U rack system) is a 1-socket, 1U server designed to run complex workloads, using highly scalable memory, I/O, and network configurations. The system is based on the AMD EPYC Generation 2 and Generation 3 processors, up to 16 DIMMs, PCI Express-enabled expansion slots, and a choice of LOM riser technologies.

The R6515 is a general-purpose platform capable of handling demanding workloads and applications, such as data warehouses, ecommerce, databases, and high-performance computing (HPC). Also, the server provides extraordinary storage capacity options, making it well-suited for data-intensive applications without sacrificing I/O performance.

Featured technologies

Table 1. PowerEdge R6515 featured technologies

Technology	Detailed Description
AMD EPYC Generation 2 and Generation 3 Based Server SOCs	<ul style="list-style-type: none"> • A highly scalable, 64-core System on Chip, design with support for two high-performance threads per core • 7nm process technology • Industry-leading memory bandwidth, with 8 channels of memory per device. In a 1-socket server, support for up to 16 DIMMS of DDR4 on 8 memory channels, delivering up to 2 terabytes of total memory capacity • The processor is a complete SoC with fully integrated, high-speed I/O supporting 128 lanes of PCIe Gen3, negating the need for a separate chipset • A highly-optimized cache structure for high-performance, energy efficient compute • Dedicated security hardware
DDR4 Memory	<ul style="list-style-type: none"> • Up to 3200 MT/s for 1 DIMM per channel • Two DIMMs per channel up to 2933 MT/s with these processors • 8x DDR4 channels per socket, 2 DIMMs per channel (2DPC) • RDIMMs up to 64 GB and LRDIMMs up to 128 GB
iDRAC9 w/ Lifecycle Controller	The embedded systems management solution for Dell servers features hardware and firmware inventory and alerting, in-depth memory alerting, faster performance, a dedicated gigabit port and many more features.
Wireless Management	<p>The Quick Sync feature is an extension of the NFC based low bandwidth interface. Quick Sync 2.0 offers feature parity with previous versions of the NFC interface.</p> <p>Since the introduction of iDRAC in PowerEdge Servers, the server management system has been improved by adding different local and remote user interfaces (Web GUI, RACADM, WSMAN, BIOS F2 Setup, and LCD) to iDRAC. Quick Sync 1.0 (NFC) interface was added to</p>

Table 1. PowerEdge R6515 featured technologies (continued)

Technology	Detailed Description
	<p>hand held devices (mobile, tablet) through the Dell OMM Android application. Quick Sync 2.0 replaces previous generations of the NFC technology to extend the feature to a wider variety of mobile operating systems with higher data throughput.</p> <p>The AMD EPYC Generation 2 and Generation 3 processors provide several SKUs, ranging from 16 cores to 64 cores variants to support workloads for data warehouses, e-commerce, high-performance computing, and storage for data centers.</p>

System features

Topics:

- [Product comparison](#)

Product comparison

The following table shows the comparison between the PowerEdge R6515 with the R6415:

Table 2. Product comparison

Feature	PowerEdge R6515	PowerEdge R6415
Processor	AMD EPYC Generation 2 and Generation 3	AMD Naples SP3
Memory	16x DDR4 RDIMM, LRDIMM, 3DS	16x DDR4 RDIMM, LRDIMM
Disk Drives	3.5-inch and 2.5-inch: <ul style="list-style-type: none"> • 12 G SAS • 6 G SATA HDD/SSD 	3.5-inch and 2.5-inch: <ul style="list-style-type: none"> • 12 G SAS • 6 G SATA HDD/SSD
Storage Controllers	<ul style="list-style-type: none"> • Mini PERC: HBA330, H330, H730P, H740P, H840, HBA355e • SW RAID: S150 	<ul style="list-style-type: none"> • Mini PERC: HBA330, H330, H730P, H740P, H840 • SW RAID: S140
PCIe SSD	Up to 10x PCIe SSD (Gen3)	Up to 10x PCIe SSD (Gen3)
PCIe Slots	Up to 2: <ul style="list-style-type: none"> • 1 x Gen3 slot (x16) • 1 x Gen4 slot (x16)–Slot3 	Up to 2 <ul style="list-style-type: none"> • 2 x Gen3 slot (x16)
OCP 2.0	OCP Type 1: (Connector A)	OCP Type 1: (Connector A)
USB Ports	<ul style="list-style-type: none"> • Front: 1 x USB 2.0 port, 1 x iDRAC USB(Micro USB) port • Rear: 2 x USB 3.1_Gen1 port • Internal: 1 x USB 3.0 port 	<ul style="list-style-type: none"> • Front: 1 x USB 2.0 port, 1 x iDRAC USB(Micro USB) port • Rear: 2 x USB 3.1_Gen1 port • Internal: 1 x USB 3.0 port
Rack Height	1U	1U
Power Supplies	<ul style="list-style-type: none"> • 550 W AC Platinum • 700 W 100-240 Vac Platinum 	<ul style="list-style-type: none"> • 450 W AC Gold (cabled) • 550 W AC Platinum
System Management	<ul style="list-style-type: none"> • Lifecycle Controller 3.x • OpenManage • Quick Sync2.0 • OpenManage Enterprise Power Manager • Digital License Key • iDRAC Direct (dedicated micro-USB port) • Easy Restore 	<ul style="list-style-type: none"> • Lifecycle Controller 3.x • OpenManage • Quick Sync2.0 • OMPC3 • Digital License Key • iDRAC Direct (dedicated micro-USB port) • Easy Restore • vFlash
Availability	<ul style="list-style-type: none"> • Hot-plug drives • Hot-plug redundant power supplies • BOSS • IDSMD 	<ul style="list-style-type: none"> • Hot-plug drives • Hot-plug redundant power supplies • BOSS • IDSMD

Chassis views and features

Topics:

- Front view of the system
- Rear view of the system
- Inside the system
- [Quick Resource Locator for Dell EMC PowerEdge R6515 system](#)

Front view of the system

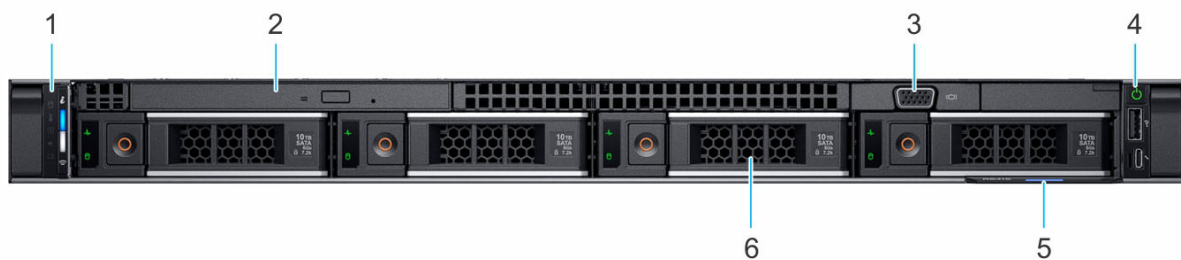

Figure 1. Front view of 4 x 3.5-inch drive system

- | | |
|-----------------------|-----------------------------|
| 1. Left control panel | 2. Optical drive (optional) |
| 3. VGA port | 4. Right control panel |
| 5. Information tag | 6. Drive (4) |

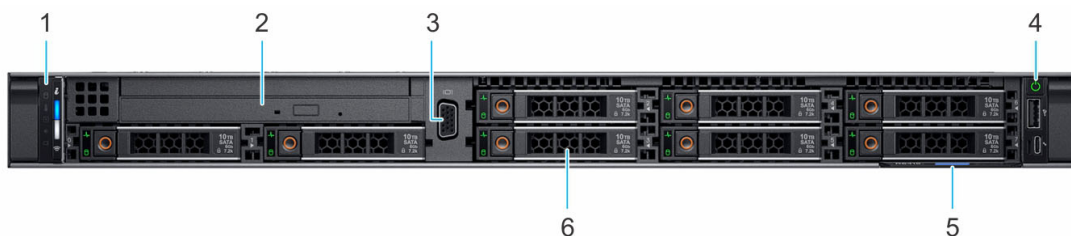

Figure 2. Front view of 8 x 2.5-inch drive system

- | | |
|-----------------------|-----------------------------|
| 1. Left control panel | 2. Optical drive (optional) |
| 3. VGA port | 4. Right control panel |
| 5. Information tag | 6. Drive (8) |

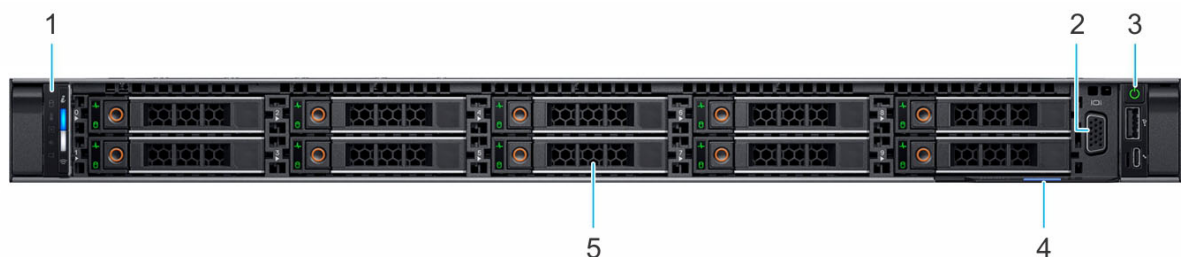

Figure 3. Front view of 10 x 2.5-inch drive system

- | | |
|-----------------------|-------------|
| 1. Left control panel | 2. VGA port |
|-----------------------|-------------|

- 3. Right control panel
- 5. Drive (10)

- 4. Information tag

Rear view of the system

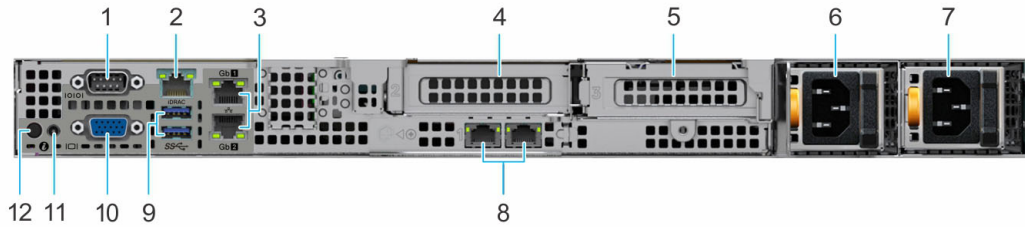

Figure 4. Rear view of the system

- 1. Serial port
- 2. iDRAC9 dedicated network port
i **NOTE:** Enables you to remotely access iDRAC.
- 3. Ethernet ports (2)
- 5. PCIe expansion card riser 2 (slot 3)
- 7. Power supply unit (PSU 2)
- 9. USB 3.0 port (2)
- 11. System status indicator cable port
- 4. PCIe expansion card riser 1A (slot 2)
- 6. Power supply unit (PSU 1)
- 8. LOM Riser Ethernet port (2) (Optional)
- 10. VGA port
- 12. System identification button

Inside the system

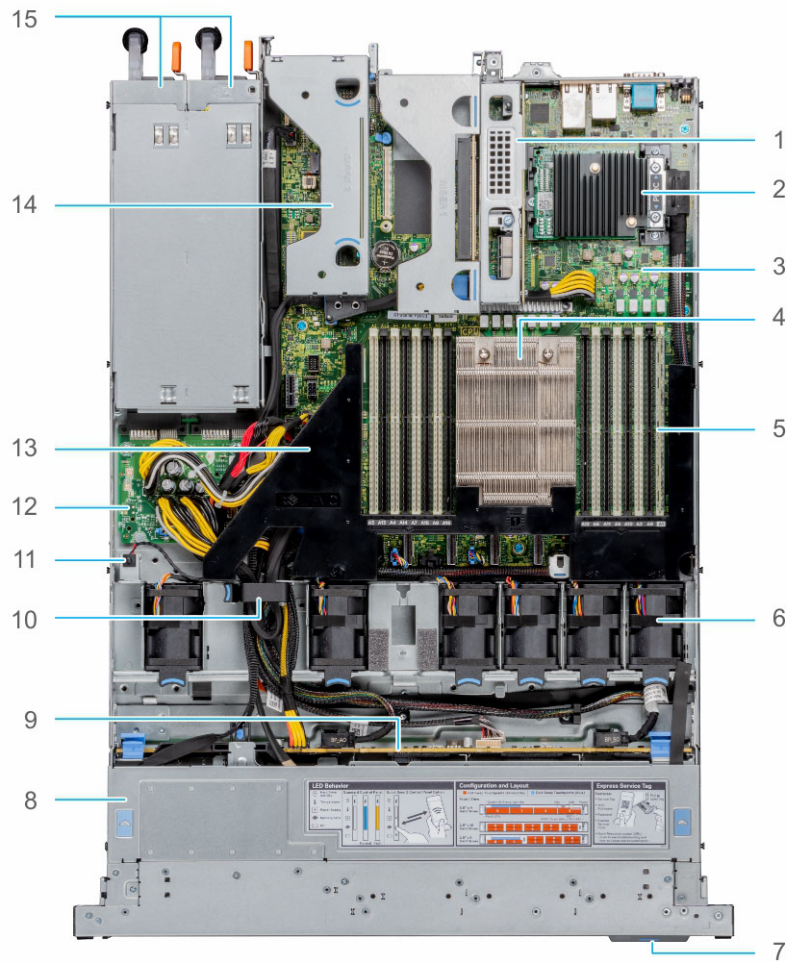

Figure 5. Inside the system

- 1. riser 1A
- 2. mini PERC card
- 3. system board
- 4. processor
- 5. memory module slots
- 6. fan
- 7. information tag
- 8. backplane cover
- 9. backplane
- 10. cable retention latch
- 11. intrusion switch
- 12. power interposer board
- 13. air shroud
- 14. riser 2
- 15. PSU 1 and PSU 2

Quick Resource Locator fo Dell EMC PowerEdge R6515 system



Figure 6. Quick Resource Locator for PowerEdge R6515 system

Processor



The AMD EPYC Generation 2 and Generation 3 processors have several SKUs ranging from 16 cores and up to 64 cores.

Topics:

- [Processor features](#)
- [Supported processors](#)

Processor features

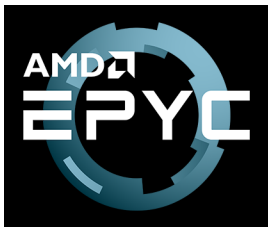

The key features of the AMD EPYC Generation 2 and Generation 3 processors, are as follows:

- A highly scalable, 64-core System on Chip design, with support for two high-performance threads per core
- Industry-leading memory bandwidth, with 8-channels of memory per device. The single socket system supports up to 16 DIMMs of DDR4, delivering up to 2TB of total memory capacity
- The processor is a complete SoC with fully integrated, high-speed I/O supporting 128 lanes of PCIe, negating the need for a separate chip-set
- A highly-optimized cache structure for high-performance and energy efficient compute
- Dedicated security hardware

Supported processors

Table 3. Supported Processors for R6515

Processor	Frequency (GHz)	Cores/Threads	Cache (MB)	Max Memory Speed (MT/s)	Turbo	TDP (W)
7773X	3.50	64/128	768	3200	Yes	280
7573X	3.60	32/64	768	3200	Yes	280
7473X	3.70	24/48	768	3200	Yes	240
7373X	3.80	16/32	768	3200	Yes	240
7713P	2.0	64/128	256	3200	Yes	225
7513	2.6	32/64	128	3200	Yes	200
7543P	2.8	32/64	256	3200	Yes	225
7443P	2.85	24/48	128	3200	Yes	200
73F3	3.5	16/32	256	3200	Yes	240

Table 3. Supported Processors for R6515 (continued)

Processor	Frequency (GHz)	Cores/Threads	Cache (MB)	Max Memory Speed (MT/s)	Turbo	TDP (W)
7313P	3.0	16/32	128	3200	Yes	155
7413	2.65	24/48	128	3200	Yes	180
75F3	2.95	32/64	256	3200	Yes	280
7763	2.6	64/128	256	3200	Yes	256
7742	2.25	64/128	256	3200	Yes	225
7702P	2	64/128	256	3200	Yes	200
7662	2	64/128	256	3200	Yes	225
7642	2.3	48/96	256	3200	Yes	225
7552	2.2	48/96	192	3200	Yes	200
7542	2.9	32/64	128	3200	Yes	225
7532	2.4	32/64	256	3200	Yes	200
7502P	2.5	32/64	128	3200	Yes	180
7452	2.35	32/64	128	3200	Yes	155
7402P	2.8	24/48	128	3200	Yes	180
7352	2.3	24/48	128	3200	Yes	155
7302P	3	16/32	128	3200	Yes	155
7282	2.8	16/32	64	3200	Yes	120
7272	2.9	12/24	64	3200	Yes	120
7262	3.2	8/16	128	3200	Yes	155
7232	3.1	8/16	32	3200	Yes	120
7H12	2.6	64/128	256	3200	Yes	280
7F72	3.2	24/48	192	3200	Yes	240
7F52	3.5	16/32	256	3200	Yes	240
7F32	3.7	8/16	128	3200	Yes	180

Memory

The PowerEdge R6515 system supports up to 16 DIMMS, 2 TB of memory, and speeds up to 3200MT/s

The Socket SP3 processor contains eight 64-bit (64 DATA bits plus 8 CHECK bits) DDR4 SDRAM memory controllers operating in ungangned mode. The maximum capacity is 16 DDR4 SDRAM DIMMs, two per memory controller. The memory channels are organized as 4 channels per processor side, with memory channels A,B, C and D on one side and memory channels E, F, G and H on the other side.

Support registered (RDIMMs), load reduced DIMMs (LRDIMMs), and 3-Dimensional Stack DIMMs (3-DS DIMMs) use a buffer to reduce memory loading and provide greater density, allowing for the maximum platform memory capacity. Unbuffered DIMMs (UDIMMs) are not supported.

Topics:

- [Supported memory](#)
- [Memory speed](#)

Supported memory

Routing is daisy-chain 2-RDIMM per channel, therefore back-to-front population of RDIMM is preferred. Quad-rank and octal-rank are supported for LRDIMMs.

The table below lists the memory technologies supported by the R6515 in comparison to the R6415:

Table 4. Memory technology comparison

Feature	R6515(DDR4)	R6415(DDR4)
DIMM type	RDIMM	RDIMM
	LRDIMM	LRDIMM
	3DS	N/A
Transfer speed	3200 MT/s	2667 MT/s
	2933 MT/s	2400 MT/s
	2666 MT/s	2133 MT/s
	N/A	1866 MT/s
Voltage	1.2V	1.2V

The following table shows the supported DIMMs for the PowerEdge R6515:

Table 5. Supported DIMMs

DIMM Speed (MT/s)	DIMM Type	DIMM Capacity (GB)	Ranks per DIMM	Data Width	DIMM Volts
3200	RDIMM	8	1	8	1.2
3200	RDIMM	16	2	8	1.2
3200	RDIMM	32	2	4	1.2
3200	RDIMM	64	2	4	1.2
2666	LRDIMM	128	8	4	1.2

Memory speed

The table below lists the memory configuration and performance details for the PowerEdge R6515 based on the quantity and type of DIMMs per memory channel.

Table 6. DIMM performance details

DIMM type	DIMM ranking	Capacity	DIMM rated voltage, Speed	1DPC	2DPC
RDIMM	1R	8 GB	DDR4 (1.2V), 3200 MT/s	3200 MT/s	2933 MT/s
	2R	16 GB, 32 GB, 64 GB	DDR4 (1.2V), 3200 MT/s	3200 MT/s	2933 MT/s
LRDIMM	8R	128 GB	DDR4 (1.2V), 2666 MT/s	2666 MT/s	2666 MT/s

NOTE: The older 32 GB capacity RDIMM memory with x4 data width and 8Gb DRAM density cannot be mixed with the newer 32 GB capacity RDIMM memory with x8 data width and 16Gb DRAM density in the same AMD EPYC™ processor unit.

NOTE: The older 128 GB capacity LRDIMM memory at 2666 MT/s speed cannot be mixed with the new 128 GB capacity LRDIMM memory at 3200 MT/s speed.

Storage

The PowerEdge R6515 supports the following drive configurations.

Table 7. Hard drive configurations

R6515 Configuration details	Storage module	Rear storage module	Controllers
4 x 3.5-inch, SAS or SATA only	4 x 3.5-inch	None	CPU direct SATA, SWRAID SATA, Mini PERC (H330, H730P, H740P, HBA330)
8 x 2.5-inch, SAS	8 x 2.5-inch	None	Mini PERC (H330, H730P, H740P, HBA330)
10 x 2.5-inch, 8 universal and 2 NVMe	10 x 2.5-inch Passive	None	CPU direct NVMe; SWRAID NVMe, Mini PERC (H740P, HBA330)
10 x 2.5-inch, NVMe	10 x 2.5-inch Passive	None	Not applicable

NOTE: SAS represents SAS/SATA capable backplane.

NOTE: Universal represents SAS/SATA/NVMe capable slots.

Topics:

- [Supported drives](#)
- [Storage controllers](#)
- [Optical drives](#)
- [External Storage](#)

Supported drives

The PowerEdge R6515 system supports SAS, SATA, Nearline SAS drives/SSD drives.

Table 8. Supported drives - SAS, SATA and NVMe SSD

Form Factor	Interface	RPM	Sector Format	Capacities
2.5-inch	SAS	15 K	512n	900 GB
		10 K	512e	2.4 TB, 2.4 TB FIPS SED
			512n	600 GB, 1.2 TB / 1.2 TB FIPS SED
3.5-inch	SAS	7.2 K	512e	8 TB / 8 TB FIPS SED, 12 TB / 12 TB FIPS SED, 16 TB / 16 TB FIPS SED
			512n	2 TB, 4 TB / 4 TB FIPS SED
	SATA	7.2 K	512e	8 TB, 12 TB, 16 TB
			512n	2 TB, 4 TB
2.5-inch	NVMe	N/A	512e	960 GB, 1.6TB, 1.92TB, 3.2TB, 3.84TB, 6.4TB, 7.68TB, 12.8TB, 15.36TB

Storage controllers

Dell EMC RAID controller options offer performance improvements, including the Mini PERC solution. The Mini PERC provides a base RAID hardware controller without consuming a PCIe slot by using a small form factor and a high density connector to the base planar.

The following table shows the supported storage controllers for the PowerEdge R6515:

Table 9. Supported storage controllers

Performance level	Controller description
Entry	<ul style="list-style-type: none"> ● S150 (SATA, NVMe) ● SW RAID SATA
Value	<ul style="list-style-type: none"> ● HBA330 (internal), 12 Gbps SAS HBA (external) <ul style="list-style-type: none"> ○ Fury IOC ○ Memory: None ○ x8 12 Gb SAS ○ x8 PCIe 3.0 ● HBA355e (external) <ul style="list-style-type: none"> ○ x8 PCIe 4.0 ● H330, 12 Gbps SAS HBA (external) <ul style="list-style-type: none"> ○ Fury IOC ○ Memory: None ○ x8 12 Gb SAS ○ x8 PCIe 3.0
Value performance	<ul style="list-style-type: none"> ● H730P <ul style="list-style-type: none"> ○ Invader ROC ○ Memory: 2 GB, NV 72-bit, 866MHz ○ x8 12 Gb SAS ○ x8 PCIe 3.0
Premium performance	<ul style="list-style-type: none"> ● H740P, H840(UI) <ul style="list-style-type: none"> ○ Harpoon 8x8 ROC ○ Memory: 4/8 GB, NV 72-bit

Optical drives

The PowerEdge R6515 supports the following internal optical drive options:

- DVD-ROM, 9.5 mm, SATA, HLDS (internal)
- DVDRW, 9.5 mm, SATA, HLDS (internal)
- DVD-ROM, 9.5 mm, SATA, PLDS (internal)
- DVDRW, 9.5 mm, SATA, PLDS (internal)
- DVD-ROM, USB, HLDS, (external storage)

External Storage

The following table shows the supported external storage for the PowerEdge R6515:

Table 10. Supported external storage

Device Type	Description
External Tape	Connection to external USB tape products
NAS/IDM appliance software	NAS software stack

Table 10. Supported external storage (continued)

Device Type	Description
JBOD	Connection to 12Gb MD-series JBODs

Networking and PCIe

The PowerEdge R6515 system offers balanced, scalable I/O capabilities, including integrated PCIe 3.0-capable expansion slots. Dell's LOM riser card and Dell Select Network Adapters let you choose the right network fabric without using up a valuable PCI slot. Pick the speed, technology, vendor, and other options, such as switch-independent partitioning to share and manage bandwidth on 10 GbE connections.

The PowerEdge R6515 system supports up to two 10/100/1000 Mbps Network Interface Controller (NIC) ports that are located on the back panel. The system also supports LAN on Motherboard (LOM) on an optional riser card. You can install one LOM riser card. The supported LOM riser options are:

- 2 x 1 GbE
- 2 x 10 GbE
- 2 x 10Gb SFP+
- 2 x 25Gb SFP+

i NOTE:

- You can install up to two PCIe add-on NIC cards.
- For information about Linux network performance settings, see the *Linux Network Tuning Guide for AMD EPYC Processor Based Servers* white paper at [AMD.com](https://www.amd.com)

Topics:

- [Expansion card installation guidelines](#)

Expansion card installation guidelines

The following table describes the supported expansion cards:

Table 11. Expansion card riser configurations

Expansion card riser	PCIe slots on the riser	Processor connection	Height	Length	Slot width
No riser	Slot 1	Processor 1	NA	NA	x8
Riser 1A	Slot 2	Processor 1	Low Profile	Half Length	x16
Riser 2	Slot 3	Processor 1	Low Profile	Half Length	x16

i NOTE: The expansion-card slots are not hot-swappable.

The following table provides guidelines for installing expansion cards to ensure proper cooling and mechanical fit. The expansion cards with the highest priority should be installed first using the slot priority indicated. All the other expansion cards should be installed in the card priority and slot priority order.

Table 12. No riser configuration (Slot 1)

Card type	Slot priority	Maximum number of cards
PERC 9: Mini mono (H730P/H330)	Integrated slot	1
PERC 10: Mini mono (H740P)	Integrated slot	1
PERC 11: Mini mono (H350)	Integrated slot	1
PERC 11: Mini mono (HBA350i)	Integrated slot	1
HBA: Mini mono (HBA330)	Integrated slot	1

Table 12. No riser configuration (Slot 1) (continued)

Card type	Slot priority	Maximum number of cards
LOM riser (2x1 G)/(2x10 G)/(2x25 G)	1	1

Table 13. Riser configuration (include slots 1 and 3)

Card type	Slot priority	Maximum number of cards
PERC 9: Mini mono (H730P/H330)	Integrated slot	1
PERC 10: Mini mono (H740P)	Integrated slot	1
PERC 11: Mini mono (H350)	Integrated slot	1
PERC 11: Mini mono (HBA350i)	Integrated slot	1
PERC 10: External adapter (H840)	3	1
PERC 10: External adapter (H840) (FH or LP)	3	1
PERC 11: External adapter (HBA355E)	3	1
HBA: External adapter	3	1
NVME PCIE SSD	3	1
Broadcom (1 G QP)	3	1
Broadcom (10 G DP)	3	1
Broadcom (25 G DP)	3	1
Intel 10 G (BaseT DP)	3	1
Intel 10 G (SFP+ DP)	3	1
Intel 1 G (QP)	3	1
Intel 25 G (SFP DP)	3	1
Emulex (HBA: FC64 LP)	3	1
Emulex (FC32 2P/1P)	3	1
Emulex (FC16 1P)/(FC16 2P)	3	1
Emulex (HBA FC32 1P S28)	3	1
Mellanox 100 G (CX5/CX6 H100)	3	1
Mellanox 25 G (CX4LX DP/CX5 DP)	3	1
Qlogic (HBA FC32 SP/DP)	3	1
Qlogic (HBA FC16 SP/DP)	3	1
HBA: CRD,CT,MRVL,LP,FC32,1P,S28,F1	3	1
Qlogic 10 G (SFP DP)	3	1
Qlogic 25 G (BaseT DP)	3	1
Internal storage (BOSS)	3	1
Nvidia T4 GPU (LP)	3	1
Solarflare 25 G (SFP DP)	3	1
LOM Riser (2x1 G)/(2x10 G)/(2x25 G)	1	1
NIC: 100Gb, CRD,NTWK,INTL,LP,100G,2P,Q29	3	1

Table 13. Riser configuration (include slots 1 and 3) (continued)

Card type	Slot priority	Maximum number of cards
NIC: 25Gb, CRD,NTWK,INTL,LP,25G,2P,S28	3	1
NIC: 100Gb, CRD,NTWK,BCME,LP,100G,2P,QSF	3	1
HBA: FC32, CRD,CTL,FC32,2P,LPE35002,EMX,L	3	1
HBA: FC32, CRD,CTL,EMLX,LP,1P,S28	3	1
NIC: 10Gb, CRD,NTWK,BCME,LP,10G,4P,BT	3	1
HBA: External Adapter, KIT,CRD,CTL,HBA,12GBPS-SAS	3	1

Table 14. Riser configuration (include slots 1, 2, and 3)

Card type	Slot priority	Maximum number of cards
PERC 9: Mini mono (H730P/H330)	Integrated slot	1
PERC 10: Mini mono (H740P)	Integrated slot	1
PERC 11: Mini mono (H350)	Integrated slot	1
PERC 11: Mini mono (HBA350i)	Integrated slot	1
HBA: Mini mono (HBA330)	Integrated slot	1
PERC 10: External adapter (H840)	3, 2	2
PERC 10: External adapter (H840) (FH or LP)	3, 2	2
PERC 11: External adapter (HBA355E)	3, 2	2
HBA: External adapter	3, 2	2
NVME PCIE SSD	3, 2	2
Broadcom (1 G DP/1G QP)	3, 2	2
Broadcom (10 G DP)	3, 2	2
Broadcom (25 G DP)	3, 2	2
Intel 10 G (BaseT DP)	3, 2	2
Intel 10 G (SFP+ DP)	3, 2	2
Intel 1 G (QP)	3, 2	2
Intel 25 G (SFP DP)	3, 2	2
Emulex (HBA: FC64 LP)	3, 2	2
Emulex (FC32 2P)	3, 2	2
Emulex (FC32 1P)	2, 3	2
Emulex (FC16 1P)/(FC16 2P)	3, 2	2
Mellanox 100 G (CX5/CX6 H100)	3, 2	2
Mellanox 25 G (CX4LX DP/CX5 DP)	3, 2	2
Qlogic (HBA FC32 SP/DP)	3, 2	2
Qlogic (HBA FC16 SP/DP)	3, 2	2

Table 14. Riser configuration (include slots 1, 2, and 3) (continued)

Card type	Slot priority	Maximum number of cards
HBA: CRD,CTL,MRVL,FH,FC32,1P,S28	3, 2	2
Qlogic 10 G (SFP DP)	3, 2	2
Qlogic 25 G (BaseT DP)	3, 2	2
Internal Storage (BOSS)	3, 2	1
Nvidia T4 GPU	3, 2	2
Solarflare 25 G (SFP DP)	3, 2	2
CRD,NTWK,INTL,LP,100G,2P,Q28,Intel, NIC: 100Gb	3,2	2
CRD,NTWK,INTL,LP,25G,2P,S28,F1	3, 2	2
CRD,CTL,FC32,2P,LPE35002,EMX,L,Em ulex, HBA: FC32	3,2	2
HBA: CRD,CTL,EMLX,LP,FC32,1P,S28	3, 2	2
CRD,NTWK,BCME,LP,10G,4P,BT,Broadc om,NIC: 10Gb	2,3	2
KIT,CRD,CTL,HBA,12GBPS- SAS,Dell,HBA: External Adapter	3,2	2
LOM riser (2x1 G)/(2x10 G)/(2x25 G)	1	1

Power, thermal, and acoustics

Topics:

- Power
- Thermal
- Acoustics

Power

PowerEdge R6515 has an extensive collection of sensors that automatically track thermal activity, and helps to regulate temperature and reduce server noise and power consumption.

Table 15. Power tools and technologies

Feature	Description
PSU portfolio	Dell EMC's PSU portfolio includes intelligent features such as dynamically optimizing power usage while maintaining availability and redundancy. Find additional information in the Power supply units section.
Tools for right sizing	Energy Smart Solution Advisor (ESSA) is a tool that can help determine the most efficient hardware configuration possible. ESSA can calculate the power consumption of hardware, power infrastructure, and storage. ESSA can help to determine exactly how much power a server will use on a given workload, and the PSU Advisor can help to choose the best, most efficient PSU. See Dell.com/calc . Energy Smart Data Center Assessment is a Dell Services offering that uses infrastructure and thermal analysis to help maximize system efficiency. See Dell.com/EnergySmart .
Industry compliance	Dell EMC servers are compliant with all relevant industry certifications and guidelines, including 80 PLUS, Climate Savers, and ENERGY STAR.
Power monitoring accuracy	PSU power monitoring improvements include: <ul style="list-style-type: none"> • Power monitoring accuracy of 1%, lower than the industry standard is 5% • Higher power reporting accuracy • Better performance under a power cap
Power capping	Use Dell EMC's systems management software to set your system power cap to limit the output of a PSU and reduce system power consumption.
Systems management	iDRAC Enterprise provides server-level management that monitors, reports, and controls power consumption at the processor, memory, and system level. Dell OpenManage Power Center delivers group power management at the rack, row, and data center level for servers, power distribution units, and uninterruptible power supplies.
Active power management	Node Manager is an embedded technology that provides individual server-level power reporting and power limiting functionality. Hot spare technology reduces consumption of redundant power supplies.
Fresh air cooling	See Dell.com/fresh-air-cooling
Rack infrastructure	Dell EMC offers some of the industry's highest- efficiency power infrastructure solutions, including: <ul style="list-style-type: none"> • Power distribution units (PDUs) • Uninterruptible power supplies (UPSs) • Energy Smart containment rack

Table 15. Power tools and technologies (continued)

Feature	Description
	For additional information see: http://content.dell.com/us/en/enterprise/power-and-cooling-technologies-components-rack-infrastructure.aspx .

Thermal

The thermal design of the PowerEdge R6515 reflect the following:

- Optimized thermal design: The system layout is architected for optimum thermal design.
- System component placement and layout are designed to provide maximum airflow coverage to critical components with minimum expense of fan power.
- Comprehensive thermal management: The thermal control system regulates the fan speed based on several different responses from all system- component temperature sensors, as well as inventory for system configurations. Temperature monitoring includes components such as processors, DIMMs, chipset, the inlet air ambient, hard disk drives, and LOM Riser.
- Open and closed loop thermal fan speed control: Open loop thermal control uses system configuration to determine fan speed based on inlet air ambient temperature. Closed loop thermal control method uses feedback temperatures to dynamically determine proper fan speeds.
- User-configurable settings: With the understanding and realization that every customer has unique set of circumstances or expectations from the system, in this generation of servers, we have introduced limited user- configurable settings residing in the iDRAC9 BIOS setup screen.

Cooling redundancy: The R6515 allow N+1 fan redundancy, allowing continuous operation with one fan failure in the system.

Acoustics

Acoustics design

Dell EMC PowerEdge delivers sound quality and smooth transient response in addition to sound power levels and sound pressure levels oriented to deployment environments. Sound quality describes how disturbing or pleasing a person finds a sound, as a function of a variety of psycho-acoustical metrics and thresholds. Tone prominence is one such metric. Transient response refers to how sound changes with time. Sound power level, sound pressure level and loudness refer to amplitude of sound. A reference for comparison to sound pressure levels and loudness for familiar noise sources is given in the table below.

Table 16. Acoustical Reference Points and Output Comparisons

Value measured at your ears		Equivalent familiar noise experience
LpA, dBA, re 20µPa	Loudness, sones	
90	80	Loud concert
75	40	Data center, vacuum cleaner, voice must be elevated to be heard
60	10	Conversation levels
45	4	Whispering, open office layout, normal living room
35	2	Quiet office
30	1	Quiet library
20	0	Recording studio

A more extensive description of Dell EMC PowerEdge acoustical design and metrics is available in the <https://www.dell.com/downloads/global/products/pedge/en/acoustical-education-dell-enterprise-white-paper.pdf>.

The acoustical design of the PowerEdge R6515 reflects the following:

- Versatility: The R6515 saves you power draw in the data center but are also quiet enough for office environment in typical and minimum configurations. You may find that the system is sufficiently quiet where the sound it emits blends into the environment.
- Adherence to Dell's high sound quality standards: Sound quality is different from sound power level and sound pressure level in that it describes how humans respond to annoyances in sound, like whistles and hums. One of the sound quality metrics in the Dell specification is prominence ratio of a tone.
- Noise ramp and descent at boot-up from power off: Fan speeds and noise levels ramp during the boot process (from power-off to power-on) in order to add a layer of protection for component cooling in the event that the system were not to boot properly. In order to keep the boot-up process as quiet as possible, the fan speed reached during boot-up is limited to about half of full speed.
- Noise level dependencies: If acoustics is important to you, several configuration choices and settings are important to consider:
 - For lower acoustical output, use a small number of lower rotational-speed SATA hard drives, nearline SAS hard drives, or non-rotational devices like SSDs. 15k hard drives generate more acoustic noise than that of lower rotational-speed hard drives, and noise increases with number of hard drives.
 - Fan speeds and noise may increase from baseline factory configurations if certain profiles are changed by the user or the system configurations are updated. The following is a list of items that impact fan speeds and acoustical output:
 - iDRAC9 BIOS settings: Performance Per Watt (DAPC or OS) may be quieter than Performance or Dense Configuration (iDRAC Settings > Thermal > Max. Exhaust Temperature or Fan speed offset).
 - The quantity and type of PCIe cards installed: This affects overall system acoustics. Installation of more than two PCIe cards results in an increase in overall system acoustics.
 - Using a GPU card: This results in an increase in overall system acoustics.
 - PCIe controller-based SSD drives: Drives such as Express flash drives and Fusion-IO cards require greater airflow for cooling, and result in significantly higher noise levels.
 - Systems with an H330 PERC: This configuration may be quieter than those with an H740P PERC with battery backup. However, higher noise levels result when a system is configured as non-RAID.
 - Hot spare feature of power supply unit: In the system default setting, the Hot Spare Feature is disabled; acoustical output from the power supplies is lowest in this setting.

PowerEdge R6515 acoustics

Dell EMC PowerEdge R6515 is a rack-mount server appropriate for attended data center environment. However, lower acoustical output is attainable with proper hardware or software configurations. For example, the minimum configuration of R6515 is quiet enough for typical office environment.

Acoustical reference points and output comparisons shows the acoustical categories (refer to Table A ~ Table C for category definitions) of each configuration in a $23\pm 2^{\circ}\text{C}$ environment.

Dell typically categorizes servers in five categories of acoustically acceptable usage:

- Category 1: Table-top in Office Environment
- Category 2: Floor-standing in Office Environment
- Category 3: General Use Space
- Category 4: Attended Data Center
- Category 5: Unattended Data Center

Category 3: General Use Space

When Dell determines that a specific Enterprise product is to be predominantly used in a general use space, then the acoustical specification of Table 3 applies. These products could be found in laboratories, schools, restaurants, open office space layouts, small ventilated closets, etc., though not in close proximity to any particular person nor in quantities greater than a few in any location. People within proximity of a few of these products should not experience any impact to speech intelligibility or annoyance from the noise of the product. A rack product sitting on a table in a common area is an example.

Table 17. Dell Enterprise Category 3, “General Use” acoustical specification category

Measurement Position re AC0158	Metric, re AC0159	Test Modes, re AC0159 (note must be in steady state, see AC0159, except where noted below)			
		Standby in 23±2° C Ambient	Idle in 23±2° C Ambient	Operating in 23±2° C Ambient – if not otherwise specified in the program’s configuration document, then processor and hard drive operating modes are required	Simulate (i.e., set air mover speeds representative) for Idle at 28 & 35° C Ambient and for 100% loading and maximum configuration, at 35° C Ambient
Sound Power	LWA,m, B	≤ 5.2	≤ 5.5	≤ 5.8	Report
Sound Quality (both positions must meet limits): Front Binaural HEAD and Rear Microphone	Tones, Hz, dB	No prominent tones per criteria D.10.6 and D.10.8 of ECMA-74			Report tones
	Tonality, tu	≤ 0.35	≤ 0.35	≤ 0.35	Report
	Dell Modulation, %	≤ 40	≤ 40	≤ 40	Report
	Loudness, sones	Report	Report	Report	Report
	LpA-single point, dBA	Report	Report	Report	Report
Front Binaural HEAD	Transients	<ul style="list-style-type: none"> ● Oscillation (see AC0159), if observed, during 20-minute steady-state observation, must adhere to the following two criteria: <ul style="list-style-type: none"> ○ Max. {ΔLpA} < 3.0 dB ○ Event count < 3 for “1.5 dB < ΔLpA < 3.0 dB” ● Report Acoustical Jump (see AC0159) during air mover speed transition from Idle to Operating Mode. ● Startup behavior <ul style="list-style-type: none"> ○ Report Startup behavior re. AC0159 ○ Startup must proceed smoothly, i.e., no sudden or large jumps, and air mover speed during startup must not exceed 50% of its maximum ● Transient inputs: Report time-history sound pressure levels re AC0159 “Train of Step Functions on Processor” 			N/A
Any	Other	<p>No rattles, squeaks, or unexpected noises</p> <p>Sound should be “even” around the EUT (one side should not be dramatically louder than another)</p> <p>Unless otherwise specified, the “default” thermal-related settings shall be selected for BIOS and iDRAC.</p> <p>Specific operating conditions will be defined in “Configurations & Configuration Dependencies” for each platform.</p>			
Sound Pressure	LpA-reported, dBA, re AC0158 and program configuration document	Report for all mics	Report for all mics	Report for all mics	Report for all mics

Category 4: Attended Data Center

When Dell determines that a specific Enterprise product is to be predominantly used in an attended data center, then the acoustical specification of Table 38 applies. The phrase “attended data center” is used to mean a space in which many (from tens to 1000s) of Enterprise products are deployed in proximity (i.e., in the same room) to personnel whose speech (perhaps with raised voices) is expected to be intelligible over the data center noise. Hearing protection or hearing monitoring programs are not expected in these areas. Examples in this category include monolithic rack products. When Dell determines that a specific Enterprise product is to be predominantly used in a general use space, then the acoustical specification of Table 37 applies. These products could be found in laboratories, schools, restaurants, open office space layouts, small ventilated closets, etc., though not in close proximity to any particular person nor in quantities greater than a few in any location. People within proximity of a few of these products should not experience any impact to speech intelligibility or annoyance from the noise of the product. A rack product sitting on a table in a common area is an example.

Table 18. Dell Enterprise Category 4, “Attended Data Center” acoustical specification category.

Measurement Position re AC0158	Metric, re AC0159	Test Modes, re AC0159 (note must be in steady state, see AC0159, except where noted below)				Simulate (i.e., set fan speeds representative) for 100% loading and maximum configuration, at 35° C Ambient
		Standby in 23±2° C Ambient	Idle in 23±2° C Ambient	Operating in 23±2° C Ambient – if not otherwise specified in the program’s configuration document, then processor and hard drive operating modes are required	Simulate (i.e., set fan speeds representative) for Idle at 28 & 35° C Ambient	
Sound Power	LWA,m, B	Report	≤ 6.9	≤ 7.1	Report	≤ 8.5
Front Binaural HEAD	Tones, Hz, dB	Report	< 15 dB	< 15 dB	Report	< 20 dB
	Tonality, tu	Report	Report	Report	Report	Report
	Dell Modulation, %	Report	Report	Report	Report	Report
	Loudness, sones	Report	Report	Report	Report	Report
	LpA-single point, dBA	Report	Report	Report	Report	Report
	Transients	<ul style="list-style-type: none"> ● Oscillation (see AC0159), if observed, during 20-minute steady-state observation, must adhere to the following two criteria: <ul style="list-style-type: none"> ○ Max. {ΔLpA} < 3.0 dB ○ Event count < 3 for “1.5 dB < ΔLpA < 3.0 dB” ○ Acoustical Jump (see AC0159), during air mover speed transition from Idle to Operating Mode must be ≤ 15dB. ○ Startup behavior <ul style="list-style-type: none"> ■ Report Startup behavior re. AC0159 ■ Startup must proceed smoothly, i.e., no sudden or large jumps, and fan speed during startup must not exceed 50% of its maximum ∞ Transient inputs: Report time-history sound pressure levels re AC0159 “Train of Step Functions on Processor” 	N/A			
Any	Other	No rattles, squeaks, or unexpected noises Sound should be “even” around the EUT (one side should not be dramatically louder than another)				

Table 18. Dell Enterprise Category 4, “Attended Data Center” acoustical specification category. (continued)

		Unless otherwise specified, the “default” thermal-related settings shall be selected for BIOS and iDRAC. Specific operating conditions will be defined in “Configurations & Configuration Dependencies” for each platform.				
Sound Pressure	LpA-reported, dBA	Report for all mics	Report for all mics	Report for all mics	Report for all mics	Report for all mics

Category 5: Unattended Data Center

When Dell determines that a specific Enterprise product is to be predominantly used in an unattended data center (and not blades or blade enclosures; these have their own category), then the acoustical specification in the table below applies. The phrase “unattended data center” is used to mean a space in which many (from tens to 1000s) of Enterprise products are deployed together, its own heating and cooling systems condition the space, and operators or servicers of equipment enter generally only to deploy, service, or decommission equipment. Hearing protection or hearing monitoring programs may be expected (per government or company guidelines) in these areas. Examples in this category include monolithic rack products.

Table 19. Dell Enterprise Category 5, “Unattended Data Center” acoustical specification category

Measurement Position re AC0158	Metric, re AC0159	Test Modes, re AC0159 (note must be in steady state, see AC0159, except where noted below)				Simulate (i.e., set air mover speeds representative) for 100% loading and maximum configuration, at 35° C Ambient
		Standby in 23±2° C Ambient	Idle in 23±2° C Ambient	Operating in 23±2° C Ambient – if not otherwise specified in the program’s configuration document, then processor and hard drive operating modes are required	Simulate (i.e., set air mover speeds representative) for Idle at 28 & 35° C Ambient	
Sound Power	LWA,m, B	Report	≤ 7.5	≤ 7.7	Report	≤ 8.7
Front Binaural HEAD	Tones, Hz, dB	Report	< 15 dB	< 15 dB	Report	< 20 dB
	Tonality, tu	Report	Report	Report	Report	Report
	Dell Modulation, %	Report	Report	Report	Report	Report
	Loudness, sones	Report	Report	Report	Report	Report
	LpA-single point, dBA	Report	Report	Report	Report	Report
Front Binaural HEAD	Transients	<ul style="list-style-type: none"> Oscillation (see AC0159), if observed, during 20-minute steady-state observation, must adhere to the following two criteria: <ul style="list-style-type: none"> Max. {ΔLpA} < 3.0 dB Event count < 3 for “1.5 dB < ΔLpA < 3.0 dB” Report Acoustical Jump (see AC0159) during air mover speed transition from Idle to Operating Mode. 			N/A	

Table 19. Dell Enterprise Category 5, “Unattended Data Center” acoustical specification category (continued)

Measurement Position re AC0158	Metric, re AC0159	Test Modes, re AC0159 (note must be in steady state, see AC0159, except where noted below)				Simulate (i.e., set air mover speeds representative) for 100% loading and maximum configuration, at 35° C Ambient
		Standby in 23±2° C Ambient	Idle in 23±2° C Ambient	Operating in 23±2° C Ambient – if not otherwise specified in the program’s configuration document, then processor and hard drive operating modes are required	Simulate (i.e., set air mover speeds representative) for Idle at 28 & 35° C Ambient	
		<ul style="list-style-type: none"> • Startup behavior <ul style="list-style-type: none"> ○ Report Startup behavior re. AC0159 ○ Startup must proceed smoothly, i.e., no sudden or large jumps, and air mover speed during startup must not exceed 50% of its maximum • Transient inputs: Report time-history sound pressure levels re AC0159 “Train of Step Functions on Processor” 				
Any	Other	<p>No rattles, squeaks, or unexpected noises</p> <p>Sound should be “even” around the EUT (one side should not be dramatically louder than another)</p> <p>Unless otherwise specified, the “default” thermal-related settings shall be selected for BIOS and iDRAC.</p> <p>Specific operating conditions will be defined in “Configurations & Configuration Dependencies” for each platform.</p>				
Sound Pressure	LpA-reported, dBA, re AC0158 and program configuration document	Report for all mics	Report for all mics	Report for all mics	Report for all mics	

Acoustical performance

Table 20. Acoustical configurations of R6515

Configuration	Minimum	Typical	Feature rich
Acoustical Category	Category 3	Category 4	Category 5
Processor Type	AMD Rome	AMD Rome	AMD Rome
Processor TDP	120 W (8 cores)	180 W (32 cores)	200 W (64 cores)
Processor Quantity	1	1	1
Memory Type	32 GB DDR4 RDIMM	32 GB DDR4 RDIMM	32 GB DDR4 RDIMM
DIMM Quantity	8	8	8

Table 20. Acoustical configurations of R6515 (continued)

Configuration	Minimum	Typical	Feature rich
Backplane Type	4x 3.5-inch	10x 2.5-inch	10x 2.5-inch
HDD Type	3.5-inch 7.2K RPM	2.5-inch SAS SSD	2.5-inch SSD NVMe
M.2	No	Yes	Yes
HDD Quantity	2	4 Front, 2 Rear	10
PSU Type	550 W	550 W	550 W
PSU Quantity	2	2	2
PCI 1	—	—	FC16 Single Port
PCI 2	—	—	—
Front PERC	—	mini HBA 330	PERC H740 P
OCP	Dual Port 10 GbE	Dual Port 25 GbE	Dual Port 25 GbE
BOSS	—	BOSS S1	BOSS S1

Table 21. Acoustical performance of R6515 acoustical configurations

Configuration	Minimum	Typical	Feature rich	
Acoustical Performance: Idle/ Operating at 25°C Ambient				
L _{wA,m} (B)	Idle	5.5	6.0	6.0
	Operating	5.5	6.0	6.0
K _v (B)	Idle	0.4	0.4	0.4
	Operating	0.4	0.4	0.4
L _{pA,m} (dB)	Idle	37	44	45
	Operating	37	44	45
Prominent tones	No prominent tones in Idle and Operating			
Acoustical Performance: Idle at 28°C Ambient				
L _{wA,m} (B)	5.7	6.2	6.2	
K _v (B)	0.4	0.4	0.4	
L _{pA,m} (dB)	39	45	45	
Acoustical Performance: Max. Loading at 30°C / 35°C Ambient				
L _{wA,m} (B)	8.1 at 35°C	7.1 at 30°C	7.1 at 30°C	
K _v (B)	0.4	0.4	0.4	
L _{pA,m} (dB)	61 at 35°C	53 at 30°C	53 at 30°C	

L_{wA,m}: The declared mean A-weighted sound power level (L_{wA}) is calculated per section 5.2 of ISO 9296 (2017) with data collected using the methods described in ISO 7779 (2010). Data presented here may not be fully compliant with ISO 7779.

L_{pA,m}: The declared mean A-weighted emission sound pressure level is at the bystander position per section 5.3 of ISO 9296 (2017) and measured using methods described in ISO 7779 (2010). The system is placed in a 24U rack enclosure, 25cm above a reflective floor. Data presented here may not be fully compliant with ISO 7779.

Prominent tones: Criteria of D.6 and D.11 of ECMA-74 (17th ed., Dec. 2019) are followed to determine if discrete tones are prominent and to report them, if so.

Idle mode: The steady-state condition in which the server is energized but not operating any intended function.

Operating mode: The maximum of the steady state acoustical output at 50% of CPU TDP or active HDDs per C.9.3.2 in ECMA-74 (17th ed., Dec. 2019).

PowerEdge acoustical dependencies

The following features are considered strong drivers of acoustical response, thus configurations, or operating conditions that include these features may increase air mover speed and acoustical output of the server:

- Ambient temperature: Dell EMC evaluates the acoustical performance of servers in a $23 \pm 2^{\circ}\text{C}$ environment. Ambient temperatures more than 25°C will have higher acoustical output and may experience larger fluctuations between state changes.
- Processor thermal design power (TDP): Higher wattage processors may require more airflow to cool under load and thus increase the potential acoustical output of the system.
- Storage type: NVME SSD consumes more power than SAS/SATA drive technologies and therefore demands more airflow to achieve system cooling targets.
- System thermal profile selection in BIOS or iDRAC GUI:
 - *Default Thermal Profile*, generally provides a lower air mover speed thus lower acoustical output than those of other thermal profiles.
 - *Maximum Performance (Performance Optimized)*, will result in higher acoustical output.
 - *Sound Cap* for products that support the feature, will limit the maximum acoustical output of the system by sacrificing some processor performance.
- GPU/FPGA/Acceleration Cards: When installed, the system acoustical output may be significantly higher than configurations without acceleration cards.
- GPU, FPGA, or other accelerator cards often push the limits of power and cooling requirements in the PCI form factor. To accommodate the increased power, system configurations that include accelerator cards may be significantly louder, due to higher fan speeds, than systems without these specialized adapters. The increased acoustical output of these systems may be particularly noticeable during system bootup where fan speeds may reach 100% of fan speed capability to guarantee cards remain within their thermal limits while thermal telemetry is established on bootup.
- BOSS module: If any BOSS module is installed and “Maximum Performance (Performance Optimized)” is selected, fan speed and acoustical noise may significantly increase at IDLE condition.

Methods to reduce acoustical output

NOTE: In most cases, the idle air mover speed of the system cannot be lowered without changing the configuration of the system, and in some cases, even a configuration change may not reduce idle air mover speeds.

- Enable sound cap in iDRAC GUI: Sound cap, a setting in the BIOS, can be toggled on/off during boot up. When enabled, sound cap reduces the acoustics of the system at the expense of some performance.
- Reduce ambient temperature: Lowering the ambient temperature allows the system to cool components more efficiently than at higher ambient temperatures.
- Set target in Third-party PCIe card options: Dell EMC provides airflow customization for third-party PCIe adapters that are installed in PowerEdge platforms. If automatic cooling response is above desired levels (LFM) based on the card specifications, a different LFM target can be set using PCIe Airflow Settings options in iDRAC GUI.
- Replace third-party PCI cards with similar Dell supported temperature-controlled cards, if available. Dell EMC works diligently with card vendors to validate and develop PCI cards to meet Dell EMC’s exacting standards for thermal performance.

Supported operating systems

The PowerEdge R6515 supports the following operating systems:

- Canonical Ubuntu Server LTS
- Citrix Xen Hypervisor
- Microsoft Windows Server with Hyper-V
- Red Hat Enterprise Linux
- SUSE Linux Enterprise Server
- VMware vSAN/ESXi

For more information, see www.dell.com/ossupport.

Dell EMC OpenManage systems management

Whether your IT environment consists of a few servers or a few thousand servers, Dell EMC OpenManage systems management solutions provide comprehensive management features for evolving IT environments. OpenManage is based on open standards, and provides both agent-based and agent-free server life-cycle management functionality for Dell EMC PowerEdge servers. OpenManage solutions help you automate and streamline essential hardware management tasks.

Start with a firm foundation for efficient hardware management using OpenManage tools, utilities, and management consoles. OpenManage systems management solutions consist of a combination of embedded management features and software products that help you automate and simplify the entire server life cycle: deploy, update, monitor, and maintain. OpenManage solutions are innovatively designed for simplicity and ease of use to help you reduce complexity, save time, achieve efficiency, control costs, and empower productivity. OpenManage centers on efficient management of server life cycle.

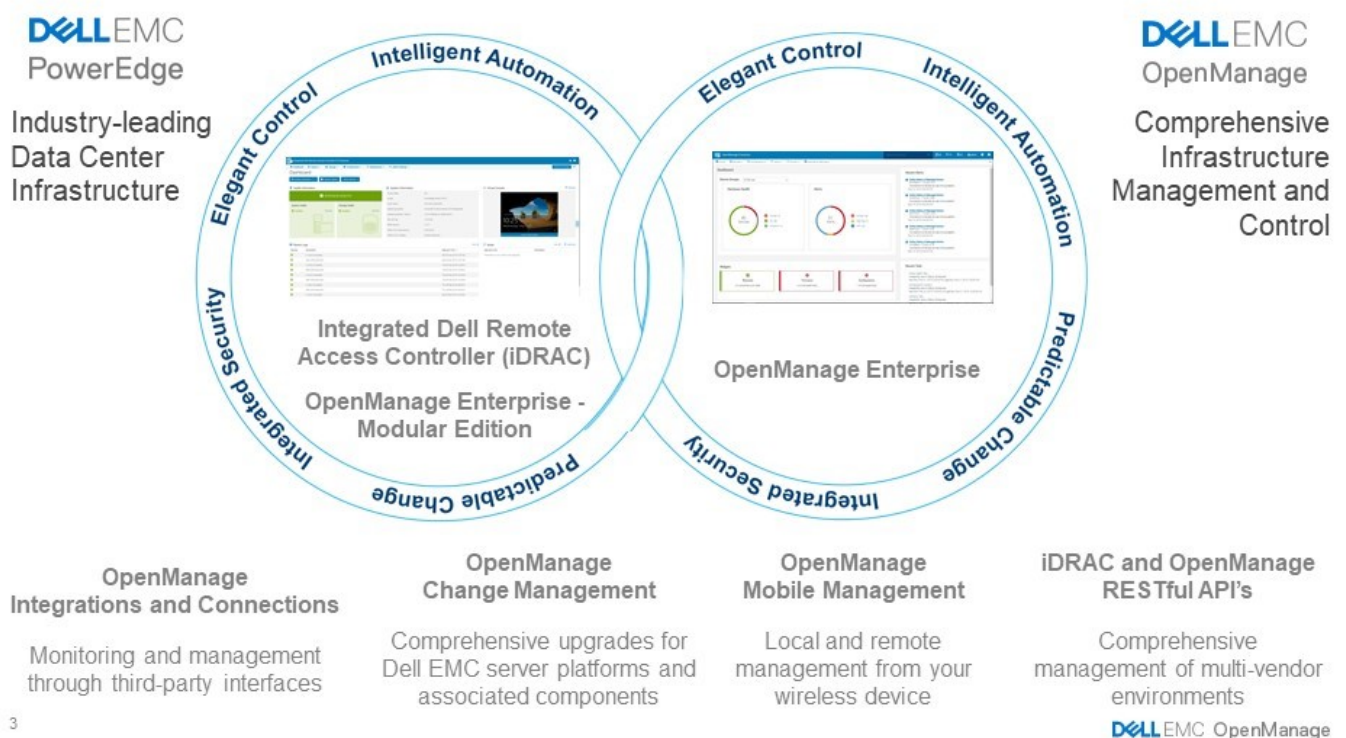

Figure 7. Server lifecycle management operations

Topics:

- iDRAC9 with Lifecycle Controller
- Agent-free management
- Agent-based management
- Dell EMC consoles
- Dell EMC OpenManage systems management tools, utilities, and protocols
- Integration with third-party consoles
- OpenManage connections with third-party consoles

iDRAC9 with Lifecycle Controller

The Integrated Dell Remote Access Controller 9 (iDRAC9) with Lifecycle Controller, the embedded intelligence of every Dell EMC PowerEdge new generation server, helps you manage Dell EMC servers agent-free or with a systems management agent, within physical, virtual, local, and remote environments. iDRAC9 alerts you of server issues, enables remote server management, and reduces the need to physically go to the server. iDRAC9 with Lifecycle Controller is part of Dell EMC comprehensive OpenManage portfolio and works as a stand-alone or with other components such as OpenManage Essentials, OpenManage Mobile, OpenManage Power Center, Chassis Management Controller, and OpenManage Integrations for Microsoft, VMware, and BMC consoles to simplify, automate, and streamline IT operations.

Dell EMC BMC and iDRAC9 feature comparison

iDRAC9 Enterprise is available for the system. Dell EMC also offers BMC. A detailed feature comparison for Dell EMC BMC and iDRAC9 Enterprise is shown in the following table.

Table 22. Feature comparison for Dell EMC BMC and iDRAC9 Enterprise

Feature	Dell EMC BMC	iDRAC9 Enterprise
Interfaces/Standards		
IPMI 2.0	Yes	Yes
DCMI 1.5	Yes	Yes
Web-based UI	Yes	Yes
Racadm command line (local and remote)	Yes	Yes
SMASH-CLP (SSH-only)	Yes	Yes
Telnet	Yes	Yes
SSH	Yes	Yes
WSMAN	Yes	Yes
RedFish API	Yes	Yes
Network Time Protocol	Yes	Yes
Connectivity		
Shared NIC	Yes	Yes
Dedicated NIC (with Ports card)	Yes	Yes
VLAN tagging	Yes	Yes
IPv4	Yes	Yes
IPv6	Yes	Yes
DHCP	Yes	Yes
Dynamic DNS	Yes	Yes
Operating system pass-through	Yes	Yes
Security		
Role-based authority	Yes	Yes
Local users	Yes	Yes
SSL encryption	Yes	Yes
IP blocking	Yes	Yes
Directory services (AD and LDAP)	No	Yes
Two-factor authentication	No	Yes

Table 22. Feature comparison for Dell EMC BMC and iDRAC9 Enterprise (continued)

Feature	Dell EMC BMC	iDRAC9 Enterprise
Single sign-on	No	Yes
PK authentication	Yes	Yes
New generation: Configuration Lockdown	No	Yes
New generation: System Erase of internal storage devices	Yes	Yes
Remote presence		
Power control	Yes	Yes
Boot control	Yes	Yes
Serial-over-LAN	Yes	Yes
Virtual media	Yes	Yes
Virtual folders	No	Yes
Remote file share	No	Yes
Virtual console	Yes for single user	Yes
VNC connection to operating system	No	Yes
Quality/bandwidth control	No	Yes
Virtual console collaboration (6 users)	No	Yes
Virtual console chat	No	Yes
Power and thermal		
Real-time power meter	Yes	Yes
Power thresholds and alerts	Yes	Yes
Real-time power graphing	Yes	Yes
Historical power counters	Yes	Yes
Power capping	Yes	Yes
Power Center integration	Yes	Yes
Temperature monitoring	Yes	Yes
Temperature graphing	Yes	Yes
Health monitoring		
Full agent-free monitoring	Yes	Yes
Predictive failure monitoring	Yes	Yes
SNMPv1, v2, and v3 traps and gets	Yes	Yes
Email Alerting	Yes	Yes
Configurable thresholds	Yes	Yes
Fan monitoring	Yes	Yes
Power supply monitoring	Yes	Yes
Memory monitoring	Yes	Yes
CPU monitoring	Yes	Yes
RAID monitoring for PERC	Yes	Yes

Table 22. Feature comparison for Dell EMC BMC and iDRAC9 Enterprise (continued)

Feature	Dell EMC BMC	iDRAC9 Enterprise
NIC monitoring	Yes	Yes
HD monitoring including JBOD enclosure	Yes	Yes
Out of band performance monitoring	No	Yes
Update		
Remote agent-free update	Yes	Yes
Embedded update tools	No	Yes
Sync with repository for scheduled updates	No	Yes
Autoupdate	No	Yes
Deployment and configuration		
Embedded operating deployment tools	No	Yes
Embedded configuration tools	No	Yes
AutoDiscovery	No	Yes
Remote operating system deployment for vMedia	No	Yes
Embedded driver pack	Yes	Yes
Full configuration inventory	Yes	Yes
Inventory export	Yes	Yes
Remote configuration	Yes	Yes
Zero touch configuration	No	Yes
System retire and repurpose	Yes	Yes
New generation: iDRAC Connection View	No	Yes
New generation: BIOS configuration page in iDRAC UI	Yes	Yes
Diagnostics, service, and logging		
Embedded diagnostic tools	Yes	Yes
Part replacement	No	Yes
Server configuration backup	Yes	Yes
Server configuration restore	Yes	Yes
Easy restore for system configuration, including USB and rSPI	Yes	Yes
Health LED only	Yes	Yes
New generation: Quick Sync 2.0	No	NA
New generation: iDRAC Direct 2.0 with micro USB port on rear	Yes	Yes
iDRAC Service Module (iSM)	Yes	Yes
Embedded Tech Support Report	Yes	Yes
Crash screen capture	No	Yes
Crash video capture, requires iSM or OMSA	No	Yes

Table 22. Feature comparison for Dell EMC BMC and iDRAC9 Enterprise (continued)

Feature	Dell EMC BMC	iDRAC9 Enterprise
Boot capture	No	Yes
Manual reset for iDRAC	Yes	Yes
Virtual NMI	Yes	Yes
Operating system watchdog (requires iSM or OMSA)	Yes	Yes
System event log	Yes	Yes
Lifecycle log	Yes	Yes
Work notes	Yes	Yes
Remote syslog	No	Yes
License management	Yes	Yes

Agent-free management

As Dell EMC PowerEdge servers have embedded server life-cycle management, often, there is no need to install an OpenManage systems management software agent into the operating system of a Dell EMC PowerEdge server. This greatly simplifies and streamlines the management footprint.

Agent-based management

Most systems management solutions require pieces of software, called agents, to be installed on each node to be managed within the IT environment. Also, the same agent is often used as a local interface into hardware health. It may be accessed remotely as a management interface, typically referred to as a one-to-one interface. For customers that continue to use agent-based solutions, Dell EMC provides OpenManage Server Administrator.

Dell EMC consoles

The central console in a systems management solution is often referred to as the one-to-many console. The central console provides a rapid view and insight into the overall health of all systems in the IT environment. The Dell EMC systems management portfolio includes several powerful consoles from which to choose depending on your requirements, including the following:

Dell EMC OpenManage Enterprise

Dell EMC OpenManage Enterprise is an intuitive infrastructure management console. Designed to take the complexity out of IT infrastructure management, it delivers better results with less time and fewer steps. OpenManage Enterprise helps IT professionals balance time and energy between complex IT infrastructure and business goals.

Simplify

- Robust, intuitive management capabilities regardless of form factor
- OpenManage Enterprise reduces learning time with a HTML5 UI that includes an elastic search engine. It goes to critical information and tasks easier and quicker. The automatable processes, templates, and policies can be created and edited using a simple menu-driven interface.

Unify

- One-to-many management from a single console—Built for scale
- OpenManage Enterprise supports up to 8,000 devices regardless of form factors. It supports Dell EMC PowerEdge racks, towers, and modular servers. It also monitors and creates alerts for third-party devices or PowerVault MD and ME Storage systems.

Automated

- Automated IT processes for greater efficiency

- From discovery to retirement, activities can be managed in the same console. In minutes, devices can be deployed automatically with templates based on service tags or node IDs.

Secure

- Designed for security throughout the infrastructure life cycle
- Security is always the top priority. To protect your infrastructure, OpenManage Enterprise detects drift from a user-defined configuration template, alerts users, and remediates misconfigurations based on presetup policies.

For more information, see the [Dell OpenManage Enterprise page](#).

OpenManage Mobile

OpenManage Mobile (OMM) is a software application that enables secure monitoring and management of PowerEdge servers remotely or at-the-server. With OpenManage Mobile, IT Administrators can securely perform several data center monitoring and remediation tasks using an Android or iOS mobile device. The OpenManage Mobile app is available as a free software download from the Apple Store and the Google Play Store.

OMM can also monitor and manage PowerEdge servers through an OpenManage Essentials console or by directly accessing the server's iDRAC.

The OpenManage Essentials console can be accessed through OpenManage Mobile over a secure IP network. This allows you to monitor all devices that are managed by OpenManage Essentials such as Dell EMC servers, storage, networking, firewall, and supported third party devices.

Key features of OpenManage Mobile when connected through OpenManage Essentials console:

- Connect to multiple servers which have OME installed, from a single mobile device.
- Connect to multiple servers individually through the iDRAC interface.
- Receive critical alert notifications on your mobile device as they arrive into your OpenManage Essentials management console.
- Acknowledge, forward, and delete alerts from your mobile device.
- Browse through device details, firmware inventory, and event logs of individual systems.
- Perform several server management functions such as power-on, power cycle, reboot, and shutdown from the mobile application.

Key Features of OpenManage Mobile when connected through iDRAC:

- Connect to any previous generation PowerEdge servers remotely.
- Assign IP address, change credentials, and update common BIOS attributes for bare metal configuration.
- Configure one server manually, or multiple servers simultaneously through a template.
- Browse server details, health status, hardware and firmware inventory, networking details, and system event or LC logs. Share this information easily with other IT Administrators.
- Access SupportAssist reports, Last Crash screen and video for both previous and current generation PowerEdge servers.
- Access virtual console and reduce the need for crash carts.
- Power on, shut down, or reboot your server from anywhere.
- Run any RACADM command.

OpenManage Enterprise Power Manager

OpenManage Enterprise Power Manager is a plugin for OpenManage Enterprise V3.2 and later. Power Manager provides monitoring and management at a one to many levels of server power and thermal. The features of Power Manager are:

- Measure and manage power consumption and monitors thermal readings—OME Power Manager provides greater insight into a data center's energy usage through detailed measurement of energy consumption throughout a data center. Power Manager gives administrators the ability to measure and manage the power consumption of up to 3,000 servers and track both short-term and long-term historical data.
- Create and implement multiple usage policies—Power Managers simplifies implementation of power policies across a data center. When it is used with the previous generation or later versions of the PowerEdge servers, OpenManage Enterprise Advanced license, and an iDRAC Enterprise license, administrators can control power consumption to each row, rack, or group of PE servers. Also, administrators can create reports on energy usage and thermal readings on a group-by-group basis.
- Reduce consumption during low-load hours—Power Manager helps administrators to save power by allowing management of a server room according to business needs. Power Manager allows administrators to implement policies that reduce the power consumption when the demand on the systems is lower. It can also assign maximum power to the servers that run the most important applications.

For more information, see [OpenManage Enterprise Power Manager User's Guide](#).

Dell EMC OpenManage systems management tools, utilities, and protocols

Dell EMC OpenManage systems management tools and utilities consist of the following:

Dell EMC Repository Manager

Dell EMC Repository Manager (DRM) is an application that helps you to:

- Identify the updates that are relevant to the systems in your data center
- Identify and notify you when updates are available
- Package the updates into different deployment formats

To automate the creation of baseline repositories, DRM provides advanced integration capabilities with iDRAC/Lifecycle controller, OpenManage Essentials, Chassis Management Controller, OpenManage Integration for VMware vCenter and OpenManage Integration for Microsoft System Center (OMIMSSC). Also, DRM packages updates into custom catalogs that can be used for deployment.

Dell EMC Repository Manager can create the following deployment tools:

- Custom catalogs
- Lightweight deployment pack
- Bootable Linux ISO
- Custom Server Update Utility (SUU)

For more information, see Dell EMC Repository Manager user's guide available at Dell.com/support/manuals.

Dell Update Packages

Dell Update Packages (DUPs) are self-contained executables supported by Microsoft Windows or Linux that update a component on a server and applications like OMSA, iSM, and DSET.

DUPs can be executed in UI or in CLI mode.

For more information, see the Dell EMC Update Packages user's guide available at www.delltechcenter.com/DSU.

Dell Remote Access Controller Administration (RACADM) CLI

The RACADM command-line utility provides a scriptable interface to perform inventory, configuration, update, and health status check of PowerEdge servers. RACADM operates in multiple modes.

- Local—supports running RACADM commands from the managed server's operating system
- SSH or Telnet—known as Firmware RACADM; is accessible by logging in to iDRAC using SSH or Telnet
- Remote—supports running RACADM commands from a remote management station such as a laptop or desktop

RACADM is supported by the iDRAC with Lifecycle Controller and by the Chassis Management Controller of the M1000e, VRTX and FX2 modular systems. Local and Remote RACADM is supported on Windows Server, Windows clients, and on Red Hat, SuSe, and Ubuntu Linux.

For more information, see the RACADM Command Line reference guide for iDRAC and CMC available at Dell.com/support/manuals.

iDRAC with Lifecycle Controller Embedded Management APIs

iDRAC with Lifecycle Controller provides a range of standards-based applications programming interfaces (APIs) that enable scalable and automated management of PowerEdge servers. Standard systems management APIs have been developed by organizations such as the Institute of Electrical and Electronics Engineers (IEEE) and Distributed Management Task Force (DMTF). These APIs are widely used by commercial systems management products and by custom programs and scripts developed by IT staff to automate management functions such as discovery, inventory, health status checking, configuration, update, and power management. The APIs supported by iDRAC with Lifecycle Controller include:

- **Redfish**—In 2015, the DMTF Scalable Platforms Management Forum (SPMF) published Redfish, an open industry-standard specification and schema designed to meet the needs of IT administrators for simple, modern, and secure management of scalable platform hardware. Dell is a key contributor to the Redfish standard, acting as co-chair of the SPMF, promoting the benefits of Redfish, and working to deliver those benefits within industry-leading systems management solutions. Redfish is a next-generation management standard using a data model representation inside a hypermedia RESTful interface. The data model is defined in terms of a standard, machine-readable schema, with the payload of the messages expressed in JSON and the OData v4 protocol.
- **WSMan**—The Web Services For Management (WSMan) API, first published by the DMTF in 2008, is the most mature and robust API provided by iDRAC with Lifecycle Controller. WSMan uses a Simple Object Access Protocol (SOAP) with

data modeled using the Common Information Model. WSMAN provides interoperability between management applications and managed resources, and identifies a core set of web service specifications and usage requirements that expose a common set of operations central to all systems management.

- **IPMI**—The Intelligent Platform Management Interface (IPMI) is a message-based, hardware-level interface specification that can operate over both LAN and serial interfaces. IPMI is supported broadly by server vendors, systems management solutions, and open source software.
- **SNMP**—The Simple Network Management Protocol (SNMP) helps in standardizing the management of network devices. SNMP allows commercial management consoles created for monitoring network switches and routers to also monitor X86 servers. SNMP is primarily used to deliver event messages to alert administrators of problems on their systems but can also be used to discover, inventory and configure servers.

To assist automating system management tasks and simplify API integration, Dell provides PowerShell and Python libraries and script examples using the WSMAN interface. The iDRAC with Lifecycle Controller pages of Dell Techcenter offer a library of technical white papers detailing the use of the embedded management APIs. For more information, see delltechcenter.com/iDRAC and delltechcenter.com/LC.

Integration with third-party consoles

Dell EMC OpenManage provides integration with several leading third-party consoles, including:

OpenManage Integration Suite for Microsoft System Center

The combination of Dell OpenManage Integration Suite and Microsoft System Center simplifies and enhances deployment, configuration, monitoring and updating of Dell servers and storage in physical and virtual environments. Our agent-free and agent-based plug-ins deliver a unique level of integration and efficiency when managing Dell hardware within a System Center environment.

The OpenManage Integration Suite for Microsoft System Center includes: Dell Server and Storage Management Packs for System Center Operations Manager (SCOM), Dell Server Deployment Packs and Update Catalogs for System Center Configuration Manager (SCCM), and tools for optimizing management of Dell PowerEdge servers in virtual environments using System Center Virtual Machine Manager (SCVMM).

OpenManage Integration for VMware vCenter

The OpenManage Integration for VMware vCenter (OMIVV) allows you to monitor, provision, and manage PowerEdge server hardware and firmware. You can perform these tasks through a dedicated Dell menu that can be accessed directly through the VMware vCenter console. OMIVV also allows granular control and reporting for the hardware environment using the same role-based access control model as vCenter. The OpenManage Management Pack for vRealize Operations Manager is available with OMIVV version 4.0 and later. This helps to checking hardware health and alerting into vRealize operations, which also includes dashboard and reporting on the server environment.

Use the following features to manage and monitor Dell hardware within the virtualized environment:

- Alerting and monitoring environment for servers and chassis
- Monitoring and reporting for servers and chassis
- Updating firmware on servers
- Deploying enhanced options

For more information, see delltechcenter.com/omivv.

 **NOTE:** The Dell EMC Repository Manager integrates with OpenManage Integration for VMware vCenter. The Dell EMC Repository Manager provides advanced functionality, simplifies the discovery, and deployment of new updates.

BMC Software

Dell EMC and BMC Software work together to simplify IT by ensuring tight integration between Dell EMC server, storage, and network management functionality and the BMC Software process and data center automation products.

OpenManage connections with third-party consoles

Dell EMC OpenManage Connections simplifies adding support for third-party devices, so you can continue to use your existing management tools while easily adding Dell EMC server systems to your IT environment. Integrate new systems at your own pace. Manage new Dell EMC servers and storage with your legacy management tools, while extending the useful life of your existing resources. With OpenManage Connections you can add monitoring and troubleshooting of Dell EMC assets to your IT infrastructure.

- OpenManage Connection for Nagios Core and Nagios XI

- OpenManage Connection for HPE Operations Manager i (OMi)

For more information on these OpenManage Connections, visit Dell.com/openmanage.

Appendix A. Additional specifications

Topics:

- Chassis dimensions
- Chassis weight
- Video
- USB
- Environmental specifications

Chassis dimensions

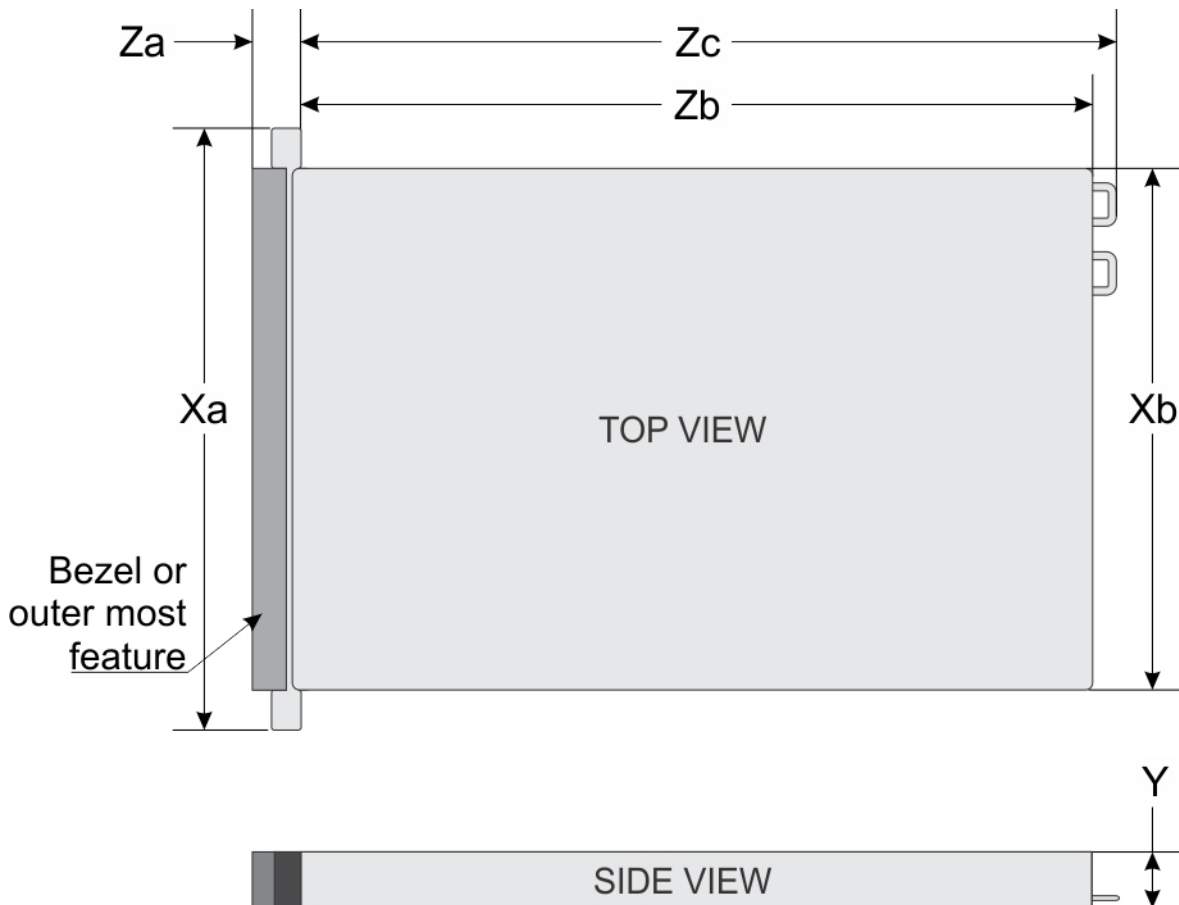

Figure 8. Chassis dimensions

Table 23. PowerEdge R6515 chassis dimensions

System configurations	Xa	Xb	Y	Za	Zb*	Zc
4 x 3.5-inches or 10 x 2.5-inches	482.0 mm (18.97 inches)	434.0 mm (17.08 inches)	42.8 mm (1.68 inches)	With bezel: 35.84 mm (1.4 inches)	657.25 mm (25.87 inches)	692.62 mm (27.26 inches)

Table 23. PowerEdge R6515 chassis dimensions (continued)

System configurations	Xa	Xb	Y	Za	Zb*	Zc
				Without bezel: 22.0 mm (0.87 inches)		
8 x 2.5-inches	482.0 mm (18.97 inches)	434.0 mm (17.08 inches)	42.8 mm (1.68 inches)	With bezel: 35.84 mm (1.4 inches) Without bezel: 22.0 mm (0.87 inches)	606.47 mm (23.87 inches)	641.85 mm (25.26 inches)

i | **NOTE:** Zb goes to the nominal rear wall external surface where the motherboard I/O connectors reside.

Chassis weight

Table 24. PowerEdge R6515 system weight

System configuration	Maximum weight (with all drives/SSDs)
4 x 3.5-inch configuration	16.75 kg (36.92 lb)
8 x 2.5-inch configuration	15.6 kg (34.39 lb)
10 x 2.5-inch configuration	15.8 kg (34.83 lb)

Video

The PowerEdge R6515 system supports integrated Matrox G200eR2 graphics controller with 16 MB of video frame buffer.

Table 25. Supported front video resolution options

Resolution	Refresh rate (Hz)	Color depth (bits)
1024 x 768	60	8, 16, 32
1280 x 800	60	8, 16, 32
1280 x 1024	60	8, 16, 32
1360 x 768	60	8, 16, 32
1440 x 900	60	8, 16, 32

Table 26. Supported rear video resolution options

Resolution	Refresh rate (Hz)	Color depth (bits)
1024 x 768	60	8, 16, 32
1280 x 800	60	8, 16, 32
1280 x 1024	60	8, 16, 32
1360 x 768	60	8, 16, 32
1440 x 900	60	8, 16, 32
1600 x 900	60	8, 16, 32

Table 26. Supported rear video resolution options (continued)

Resolution	Refresh rate (Hz)	Color depth (bits)
1600 x 1200	60	8, 16, 32
1680 x 1050	60	8, 16, 32
1920 x 1080	60	8, 16, 32
1920 x 1200	60	8, 16, 32

USB

Front, rear, and internal USB ports are included in the base system for R6515. Rear ports support up to USB 3.1 Gen1, internal port supports up to USB 3.1 Gen1, and front ports support USB 2.0.

Environmental specifications

The following tables illustrates the environmental specifications for the PowerEdge R6515:

Table 27. Temperature specifications

Temperature	Specifications
Storage	-40°C to 65°C (-40°F to 149°F)
Continuous operation (for altitude less than 950m or 3117ft)	10°C to 35°C (50°F to 95°F) with no direct sunlight on the equipment <i>i</i> NOTE: Certain system configurations may require reductions in the upper temperature limits. <i>i</i> NOTE: The performance of the system may be impacted when operating above the upper temperature limit or with a faulty fan.
Fresh air	For information about Fresh Air see Expanded operating temperature table
Maximum temperature gradient (operating and storage)	20°C/h (68°F/h)

Table 28. Relative humidity specifications

Relative Humidity	Specifications
Storage	5% to 95% RH with 33°C (91°F) maximum dew point. Atmosphere must be non-condensing at all times.
Operating	10% to 80% relative humidity with 29°C (84.2°F) maximum dew point.

Table 29. Maximum vibration specifications

Maximum vibration	Specifications
Operating	0.26Grms at 5Hz to 350Hz (x, y, and z axes)
Storage	1.88Grms at 10Hz to 500Hz for 15min (all six sides tested)

Table 30. Maximum shock specifications

Maximum shock	Specifications
Operating	Six consecutively executed shock pulses in the positive and negative x, y, and z axes of 6G for up to 11ms

Table 30. Maximum shock specifications (continued)

Maximum shock	Specifications
Storage	Six consecutively executed shock pulses in the positive and negative x, y, and z axes (one pulse on each side of the system) of 71 G for up to 2 ms.

Table 31. Maximum altitude specifications

Maximum altitude	Specifications
Operating	3048m (10,000 ft)
Storage	12,000m (39,370 ft)

Table 32. Operating temperature de-rating specifications

Operating temperature de-rating	Specifications
Up to 35°C (95°F)	Maximum temperature is reduced by 1°C/300 m (1°F/547 ft) above 950 m (3,117 ft).
35°C to 40°C (95°F to 104°F)	Maximum temperature is reduced by 1°C/175 m (1°F/319 ft) above 950 m (3,117 ft).
40°C to 45°C (104°F to 113°F)	Maximum temperature is reduced by 1°C/125 m (1°F/228 ft) above 950 m (3,117 ft).

Table 33. Standard operating temperature

Standard operating temperature	Specifications
Continuous operation (for altitude less than 950m or 3117ft)	10°C to 35°C (50°F to 95°F) with no direct sunlight on the equipment.

Table 34. Expanded operating temperature

Expanded operating temperature	Specifications
Continuous operation	<p>5°C to 40°C at 5% to 85% RH with 29°C dew point.</p> <p>NOTE: Outside the standard operating temperature (10°C to 35°C), the system can operate continuously in temperatures as low as 5°C and as high as 40°C.</p> <p>For temperatures between 35°C and 40°C, de-rate maximum allowable temperature by 1°C per 175 m above 950 m (1°F per 319 ft).</p>
1% of annual operating hours	<p>-5°C to 45°C at 5% to 90% RH with 29°C dew point.</p> <p>NOTE: Outside the standard operating temperature (10°C to 35°C), the system can operate down to -5°C or up to 45°C for a maximum of 1% of its annual operating hours.</p> <p>For temperatures between 40°C and 45°C, de-rate maximum allowable temperature by 1°C per 125 m above 950 m (1°F per 228 ft).</p>

NOTE: When operating in the expanded temperature range, system performance may be impacted.

NOTE: When operating in the expanded temperature range, ambient temperature warnings maybe reported on the LCD panel and in the System Event Log.

Thermal restrictions

Table 35. Thermal restriction matrix for processor and fans

Configuration	4 x 3.5-inch	8 x 2.5-inch	10 x 2.5-inch drives (NVMe)
Processor TDP			
120 W	STD fan STD HSK	STD fan STD HSK	HPR fan* STD HSK
155 W	STD fan STD HSK	STD fan STD HSK	HPR fan* STD HSK
180 W	STD fan HPR HSK	STD fan HPR HSK	HPR fan* HPR HSK
200 W	STD fan HPR HSK	STD fan HPR HSK	HPR fan* HPR HSK
225 W	HPR fan HPR HSK	HPR fan HPR HSK	HPR fan* HPR HSK
240 W	HPR fan HPR HSK	HPR fan HPR HSK	HPR fan* HPR HSK
280 W	HPR fan HPR HSK with DIMM Blank	HPR fan HPR HSK with DIMM Blank	Not supported
280 W - 64C/32C	HPR fan HPR HSK with DIMM Blank	HPR fan HPR HSK with DIMM Blank	Not supported

NOTE: * Supported ambient temperature is 30°C.

NOTE: To ensure proper cooling in the system with 280 W processor, memory module blank should be installed in the memory sockets that are not populated.

NOTE: For 280 W processor, maximum supported ambient temperature is 35°C.

NOTE: For 10 x 2.5-inch drives (NVMe), maximum supported ambient temperature is 30°C.

Table 36. Thermal restriction matrix for T4 GPGPU

Riser configurations	Configuration type and ambient temperature support		
	4 x 3.5-inch drives	8 x 2.5-inch drives	10 x 2.5-inch drives (NVMe)
	2 LP	2 LP	2 LP
	Ambient = 30°C		
Slot 2	HPR fan	HPR fan	NA
Slot 3	HPR fan	HPR fan	HPR fan + NVMe drives from slot 6-9 + SAS or SATA drives from slot 0-5

Table 37. Label reference

Label	Description
STD	Standard
HPR	High performance
HSK	Heat sink
LP	Low profile

Thermal restriction for ASHRAE A3/Fresh air environment

- Processor TDP equal or greater than 180 W are not supported.
- 128 GB or greater capacity LRDIMMs are not supported.
- Redundant power supply configuration is required, but PSU failure is not supported
- Non-Dell qualified peripheral cards greater than 25 W are not supported.
- GPU card is not supported.
- PCIe SSD is not supported.

Thermal restriction for ASHRAE A4/Fresh air environment

- Processor TDP equal or greater than 155 W are not supported within A4.
- 128 GB or greater capacity LRDIMMs are not supported within A4.
- Two PSUs are required in redundant mode, but PSU failure is not supported.
- Non Dell qualified peripheral cards and/or peripheral cards greater than 25W are not supported.
- GPU is not supported within A4.
- PCIeSSD is not supported within A4.
- 25G OCP is not supported within A4.

Other thermal restrictions

1. SolarFlare, Mellanox CX4/CX5/CX6, P4800 AIC can only support up to 35°C ambient.
2. Mellanox CX6 on 10x2.5-inch configuration can only support on slot 3.
3. 25G OCP card does not support with 128 GB LRDIMM on 10 x 2.5-inch configuration.
4. HPR fan is required with 128 GB LRDIMM.
5. T4 GPGPU is not supported with 128 GB LRDIMM.
6. T4 GPGPU supports up to 30°C ambient temperature with HPR fans and 4 x 3.5-inch or 8 x 2.5-inch configurations.
7. T4 GPGPU supports up to 30°C ambient temperature with HPR fan and 10 x 2.5-inch configuration (NVMe(slot 6-9) and SAS or SATA drives (slot 0-5)) on slot 3 only.

Appendix B. Standards compliance

The system conforms to the following industry standards.

Table 38. Industry standard documents

Standard	URL for information and specifications
ACPI Advance Configuration and Power Interface Specification, v2.0c	https://uefi.org/specsandtesttools
Ethernet IEEE 802.3-2005	https://standards.ieee.org/
HDG Hardware Design Guide Version 3.0 for Microsoft Windows Server	microsoft.com/whdc/system/platform/pcdesign/desguide/serverdg.mspx
IPMI Intelligent Platform Management Interface, v2.0	intel.com/design/servers/ipmi
DDR4 Memory DDR4 SDRAM Specification	jedec.org/standards-documents/docs/jesd79-4.pdf
PCI Express PCI Express Base Specification Rev. 2.0 and 3.0	pcisig.com/specifications/pciexpress
PMBus Power System Management Protocol Specification, v1.2	http://pmbus.org/Assets/PDFS/Public/PMBus_Specification_Part_1_Rev_1-1_20070205.pdf
SAS Serial Attached SCSI, v1.1	http://www.t10.org/
SATA Serial ATA Rev. 2.6; SATA II, SATA 1.0a Extensions, Rev. 1.2	sata-io.org
SMBIOS System Management BIOS Reference Specification, v2.7	dmtf.org/standards/smbios
TPM Trusted Platform Module Specification, v1.2 and v2.0	trustedcomputinggroup.org
UEFI Unified Extensible Firmware Interface Specification, v2.1	uefi.org/specifications
USB Universal Serial Bus Specification, Rev. 2.7	usb.org/developers/docs

Appendix C Additional resources

Table 39. Additional resources

Resource	Description of contents	Location
Installation and Service Manual	This manual, available in PDF format, provides the following information: <ul style="list-style-type: none"> • Chassis features • System Setup program • System messages • System codes and indicators • System BIOS • Remove and replace procedures • Troubleshooting • Diagnostics • Jumpers and connectors 	Dell.com/Support/Manuals
Getting Started Guide	This guide ships with the system, and is also available in PDF format. This guide provides the following information: <ul style="list-style-type: none"> • Initial setup steps • Key system features • Technical specifications 	Dell.com/Support/Manuals
Rack Installation Instructions	This document ships with the rack kits, and provides instructions for installing a server in a rack.	Dell.com/Support/Manuals
Information Update	This document ships with the system, is also available in PDF format online, and provides information on system updates.	Dell.com/Support/Manuals
System Information Label	The system information label documents the system board layout and system jumper settings. Text is minimized due to space limitations and translation considerations. The label size is standardized across platforms.	Inside the system chassis cover
Quick Resource Locator (QRL)	This code on the chassis can be scanned by a phone application to access additional information and resources for the server, including videos, reference materials, service tag information, and Dell EMC contact information.	Inside the system chassis cover
Energy Smart Solution Advisor (ESSA)	The Dell EMC online ESSA enables easier and more meaningful estimates to help you determine the most efficient configuration possible. Use ESSA to calculate the power consumption of your hardware, power infrastructure, and storage.	Dell.com/calc

Dell Technologies Services

Dell Technologies Services include a wide, customizable range of service choices to simplify the assessment, design, implementation, management and maintenance of IT environments and to help you transition from platform to platform. Depending on your current business requirements and the level of service right for you, we provide factory, on-site, remote, modular, and specialized services that fit your needs and budget. We'll help with a little or a lot—your choice—and provide access to our global resources.

For more information, see DellEMC.com/Services.

Topics:

- [Dell EMC ProDeploy Enterprise Suite](#)
- [Dell EMC Remote Consulting Services](#)
- [Dell EMC Data Migration Service](#)
- [ProSupport Enterprise Suite](#)
- [Dell EMC ProSupport Plus for Enterprise](#)
- [Dell EMC ProSupport for Enterprise](#)
- [Dell EMC ProSupport One for Data Center](#)
- [Support Technologies](#)
- [Dell Technologies Education Services](#)
- [Dell Technologies Consulting Services](#)
- [Dell EMC Managed Services](#)

Dell EMC ProDeploy Enterprise Suite

ProDeploy Enterprise Suite gets your server out of the box and into optimized production—fast. Our elite deployment engineers with broad and deep experience utilizing best-in-class processes along with our established global scale can help you around the clock and around the globe. From simple to the most complex server installations and software integration, we take the guess work and risk out of deploying your new server technology.

		Basic Deployment	ProDeploy	ProDeploy Plus
Pre-deployment	Single point of contact for project management	-	●	In-region
	Site readiness review	-	●	●
	Implementation planning	-	●	●
	SAM engagement for ProSupport Plus entitled devices	-	-	●
Deployment	Deployment service hours	Business hours	24x7	24x7
	Remote guidance for hardware installation or Onsite hardware installation and packaging material removal	Onsite	Remote or Onsite	Onsite
	Install and configure system software	-	Remote	Onsite
	Install support software and connect with Dell Technologies	-	●	●
	Project documentation with knowledge transfer	-	●	●
Post-deployment	Deployment verification	-	●	●
	Configuration data transfer to Dell EMC technical support	-	●	●
	30-days of post-deployment configuration assistance	-	-	●
	Training credits for Dell EMC Education Services	-	-	●

Figure 9. ProDeploy Enterprise Suite capabilities

 **NOTE:** Hardware installation not applicable on selected software products.

Dell EMC ProDeploy Plus

From beginning to end, ProDeploy Plus provides the skill and scale needed to successfully execute demanding deployments in today's complex IT environments. Certified Dell EMC experts start with extensive environmental assessments and detailed migration planning and recommendations. Software installation includes set up of most versions of Dell EMC SupportAssist and OpenManage system management utilities. Post-deployment configuration assistance, testing, and product orientation services are also available.

Dell EMC ProDeploy

ProDeploy provides full service installation and configuration of both server hardware and system software by certified deployment engineers including set up of leading operating systems and hypervisors as well as most versions of Dell EMC SupportAssist and OpenManage system management utilities. To prepare for the deployment, we conduct a site readiness review and implementation planning exercise. System testing, validation, and full project documentation with knowledge transfer complete the process.

Dell EMC Basic Deployment

Basic Deployment delivers worry-free professional installation by experienced technicians who know Dell EMC servers inside and out.

Dell EMC Server Configuration Services

With Dell EMC Rack Integration and other Dell EMC PowerEdge Server Configuration Services, you save time by receiving your systems racked, cabled, tested, and ready to integrate into the data center. Dell EMC staff pre-configure RAID, BIOS and iDRAC settings, install system images, and even install third-party hardware and software.

For more information, see [Server Configuration Services](#).

Dell EMC Residency Services

Residency Services helps customers transition to new capabilities quickly with the assistance of on-site or remote Dell EMC experts whose priorities and time you control. Residency experts can provide post implementation management and knowledge transfer related to a new technology acquisition or day-to-day operational management of the IT infrastructure.

Dell EMC Remote Consulting Services

When you are in the final stages of your PowerEdge server implementation, you can rely on Dell EMC Remote Consulting Services and our certified technical experts to help you optimize your configuration with best practices for your software, virtualization, server, storage, networking, and systems management.

Dell EMC Data Migration Service

Protect your business and data with our single point of contact to manage your data migration project. Your project manager will work with our experienced team of experts to create a plan using industry-leading tools and proven processes based on global best practices to migrate your existing files and data so your business system get up and running quickly and smoothly.

ProSupport Enterprise Suite

With the ProSupport Enterprise Suite, we can help you keep your operation running smoothly, so you can focus on running your business. We will help you maintain peak performance and availability of your most essential workloads. ProSupport Enterprise Suite is a suite of support services that enable you to build the solution that is right for your organization. Choose support models based on how you use technology and where you want to allocate resources. From the desktop to the data

center, address everyday IT challenges, such as unplanned downtime, mission-critical needs, data and asset protection, support planning, resource allocation, software application management and more. Optimize your IT resources by choosing the right support model.

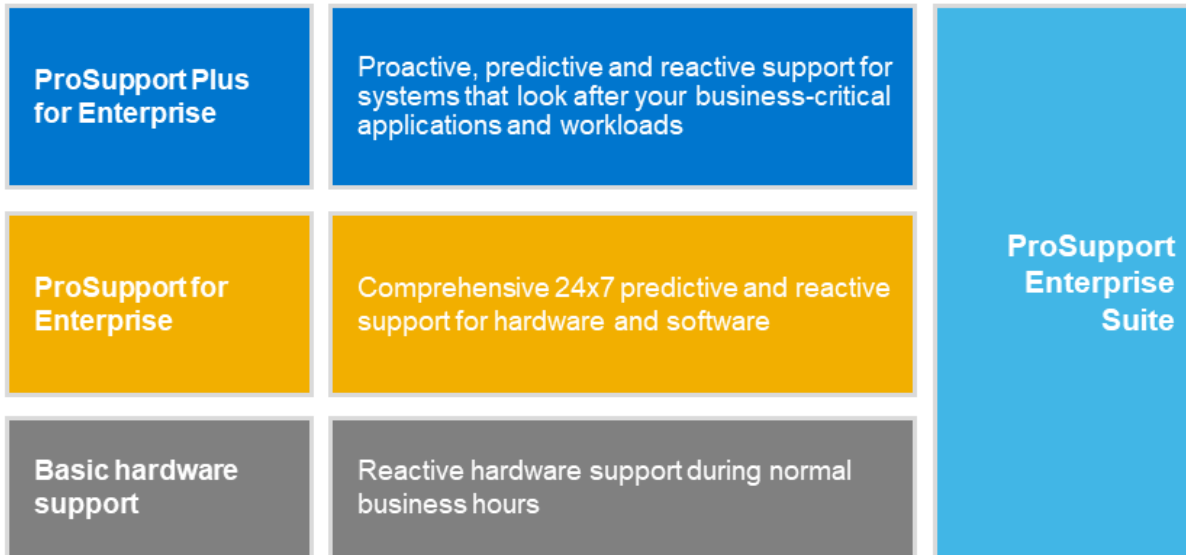

Figure 10. ProSupport Enterprise Suite

Dell EMC ProSupport Plus for Enterprise

When you purchase your PowerEdge server, we recommend ProSupport Plus, our proactive and preventative support service for your business-critical systems. ProSupport Plus provides you with all the benefits of ProSupport, plus the following:

- An assigned Services Account Manager who knows your business and your environment
- Immediate advanced troubleshooting from an engineer who understands your PowerEdge server
- Personalized, preventive recommendations based on analysis of support trends and best practices from across the Dell Technologies infrastructure solutions customer base to reduce support issues and improve performance
- Predictive analysis for issue prevention and optimization enabled by SupportAssist
- Proactive monitoring, issue detection, notification, and automated case creation for accelerated issue resolution enabled by SupportAssist
- On-demand reporting and analytics-based recommendations enabled by SupportAssist and TechDirect

Dell EMC ProSupport for Enterprise

Our ProSupport service offers highly trained experts around the clock and around the globe to address your IT needs. We help minimize disruptions and maximize availability of PowerEdge server workloads with:

- 24x7 support through phone, chat and online
- Predictive, automated tools and innovative technology
- A central point of accountability for all hardware and software issues
- Collaborative 3rd party support
- Hypervisor, operating system and application support
- Consistent experience regardless of where you are located or what language you speak
- Optional onsite parts and labor response options including next business day or four-hour mission critical

NOTE: Subject to service offer country availability.

Enterprise Support Services Feature Comparison

	Basic	ProSupport	ProSupport Plus
Remote technical support	9x5	24x7	24x7
Covered products	Hardware	Hardware Software	Hardware Software
Onsite hardware support	Next business day	Next business day or 4hr mission critical	Next business day or 4 hr mission critical
3 rd party collaborative assistance		●	●
Automated issue detection & proactive case creation		●	●
Self-service case initiation and management		●	●
Access to software updates		●	●
Priority access to specialized support experts			●
3 rd party software support			●
Assigned Services Account Manager			●
Personalized assessments and recommendations			●
Semiannual systems maintenance			●

Availability and terms of Dell Technologies services vary by region and by product. For more information, please view our Service Descriptions available on Dell.com

Figure 11. Dell EMC Enterprise Support model

Dell EMC ProSupport One for Data Center

ProSupport One for Data Center offers flexible site-wide support for large and distributed data centers with more than 1,000 assets. This offering is built on standard ProSupport components that leverage our global scale but are tailored to your company's needs. While not for everyone, this service option offers a truly unique solution for Dell Technologies largest customers with the most complex environments.

- Team of assigned Services Account Managers with remote, on-site options
- Assigned ProSupport One technical and field engineers who are trained on your environment and configurations
- On-demand reporting and analytics-based recommendations enabled by SupportAssist and TechDirect
- Flexible on-site support and parts options that fit your operational model
- A tailored support plan and training for your operations staff

Support Technologies

Powering your support experience with predictive, data-driven technologies.

Dell EMC SupportAssist

The best time to solve a problem is before it happens. The automated proactive and predictive technology SupportAssist helps reduce steps and time to resolution, often detecting issues before they become a crisis. Benefits include:

- Value—SupportAssist is available to all customers at no additional charge
- Improve productivity—replace manual, high-effort routines with automated support
- Accelerate time to resolution—receive issue alerts, automatic case creation, and proactive contact from Dell EMC experts
- Gain insight and control—optimize enterprise devices with on-demand ProSupport Plus reporting in TechDirect, and get predictive issue detection before the problem starts

NOTE: SupportAssist is included with all support plans, but features vary based on service level agreement.

	Basic Hardware Warranty	ProSupport	ProSupport Plus
Automated issue detection and system state information collection	•	•	•
Proactive, automated case creation and notification		•	•
Predictive issue detection for failure prevention			•
Recommendation reporting available on-demand in TechDirect			•

Figure 12. SupportAssist model

Get started at Dell.com/SupportAssist

Dell EMC TechDirect

Boost IT team productivity when supporting Dell EMC systems. With over 1.4 million self-dispatches processed each year, TechDirect has proven its effectiveness as a support tool. You can:

- Self-dispatch replacement parts
- Request technical support
- Integrate APIs into your help desk

Or, access all your Dell EMC certification and authorization requirements. Train your staff on Dell EMC products, as TechDirect allows you to:

- Download study guides
- Schedule certification and authorization exams
- View transcripts of completed courses and exams

Register at techdirect.dell.

Dell Technologies Education Services

Build the IT skills required to influence the transformational outcomes of the business. Enable talent and empower teams with the right skills to lead and execute transformational strategy that drives competitive advantage. Leverage the training and certification required for real transformation.

Dell Technologies Education Services offers PowerEdge server training and certifications designed to help you achieve more from your hardware investment. The curriculum delivers the information and the practical, hands-on skills that you and your team need to confidently install, configure, manage, and troubleshoot your Dell EMC servers. To learn more or register for a class today, see LearnDell.com/Server.

Dell Technologies Consulting Services

Our expert consultants help you transform faster, and quickly achieve business outcomes for the high value workloads Dell EMC PowerEdge systems can handle.

From strategy to full-scale implementation, Dell Technologies Consulting can help you determine how to execute your IT, workforce, or application transformation.

We use prescriptive approaches and proven methodologies combined with Dell Technologies' portfolio and partner ecosystem to help you achieve real business outcomes. From multi-cloud, applications, DevOps, and infrastructure transformations, to business resiliency, data center modernization, analytics, workforce collaboration, and user experiences—we're here to help.

Dell EMC Managed Services

Reduce the cost, complexity, and risk of managing IT. Focus your resources on digital innovation and transformation while our experts help optimize your IT operations and investment with managed services backed by guaranteed service levels.