



Cisco UCS C240 M4 High-Density Rack Server (Large Form Factor Disk Drive Model)

CONTENTS

OVERVIEW	5
DETAILED VIEWS	6
Chassis Front View	6
Chassis Rear View	7
BASE SERVER STANDARD CAPABILITIES and FEATURES	9
CONFIGURING the SERVER	13
STEP 1 VERIFY SERVER SKU	14
STEP 2 SELECT RISER CARDS (OPTIONAL)	15
STEP 3 SELECT CPU(s)	16
STEP 4 SELECT MEMORY	19
STEP 5 SELECT RAID CONTROLLERS	25
RAID Controller Option (internal HDD/SSD support)	25
Cisco 12G SAS Modular RAID Controller	25
SAS HBA (internal HDD/SSD/JBOD support)	25
SAS HBA (external JBOD support)	25
RAID Volumes and Groups	25
STEP 6 SELECT HARD DISK DRIVES (HDDs) or SOLID-STATE DRIVES (SSDs)	31
STEP 7 SELECT PCIe OPTION CARD(s)	34
STEP 8 ORDER OPTIONAL NETWORK CARD ACCESSORIES	39
STEP 9 ORDER GPU CARDS(OPTIONAL)	44
STEP 10 ORDER POWER SUPPLY	47
STEP 11 SELECT AC POWER CORD(s)	48
STEP 12 ORDER TOOL-LESS RAIL KIT AND OPTIONAL REVERSIBLE CABLE MANAGEMENT ARM	51
STEP 13 SELECT NIC MODE (OPTIONAL)	52
STEP 14 ORDER A TRUSTED PLATFORM MODULE (OPTIONAL)	53
STEP 15 ORDER CISCO FLEXIBLE FLASH SD CARD MODULE (OPTIONAL)	55
STEP 16 ORDER OPTIONAL USB 3.0 DRIVE	56
STEP 17 SELECT OPERATING SYSTEM AND VALUE-ADDED SOFTWARE	57
STEP 18 SELECT OPERATING SYSTEM MEDIA KIT	60
STEP 19 SELECT SERVICE and SUPPORT LEVEL	61
OPTIONAL STEP - ORDER RACK(s)	66
OPTIONAL STEP - ORDER PDU	67
SUPPLEMENTAL MATERIAL	68
CHASSIS	68
Block Diagram	70
CPUs and DIMMs	71
Physical Layout	71
Memory Population Rules	72
DIMM Population Order	73
Recommended Memory Configuration	74
Additional DIMM Populations	76
RAID Details	77
Cisco 12G SAS Modular RAID Controller (RAID Support)	77
Cisco 12 Gbps SAS HBA (JBOD Only Support)	77
RAID Option ROM (OPROM) Settings	78
Riser Card Configuration and Options	79
Serial Port Details	81
Upgrade and Servicing-Related Parts	82
Adding an Additional CPU (with CPU heat sink) or Replacing CPUs	83

Motherboard Lithium Battery	83
Thermal Grease (with syringe applicator) for CPU to Heatsink Seal	83
Air Baffle Replacement Kit	84
CPU Heat Sink Cleaning Kit	84
RACKS	85
PDUs	87
KVM CABLE	88
Motherboard USB and SD Ports, and RAID Card Backup Locations	89
TECHNICAL SPECIFICATIONS	90
Dimensions and Weight	90
Power Specifications	91
Environmental Specifications	95
Compliance Requirements	96

CONTENTS

OVERVIEW

The UCS C240 M4 LFF server is the newest 2-socket, 2U rack server from Cisco, designed for both performance and expandability over a wide range of storage-intensive infrastructure workloads from big data to collaboration.

The enterprise-class UCS C240 M4 LFF server extends the capabilities of Cisco's Unified Computing System portfolio in a 2U form factor with the addition of the Intel® Xeon E5-2600 v3 and v4 series processor family that delivers the best combination of performance, flexibility and efficiency gains. In addition, the UCS C240 M4 LFF server provides 24 DIMM slots, up to 6 PCI Express (PCIe) 3.0 slots, up to 12 front-loading LFF drives plus two (optional) internal SFF SATA boot drives for a total of 14 internal drives.

The C240 M4 server includes a modular LAN on motherboard (mLOM) slot for installation of a Cisco Virtual Interface Card (VIC) or third-party network interface card (NIC) without consuming a PCI slot in addition to 2 x 1 GbE embedded (on the motherboard) LOM ports. These features combine to provide outstanding levels of internal memory and storage expandability along with exceptional performance.

The Cisco UCS C240 M4 server can be used standalone, or as part of the Cisco Unified Computing System, which unifies computing, networking, management, virtualization, and storage access into a single integrated architecture enabling end-to-end server visibility, management, and control in both bare metal and virtualized environments.

Figure 1 Cisco UCS C240 M4 High-Density LFF Rack Server

Front View



Rear View



DETAILED VIEWS

Chassis Front View

Figure 2 shows the 12-drive Cisco UCS C240 M4 High-Density LFF Rack Server.

Figure 2 Chassis Front View

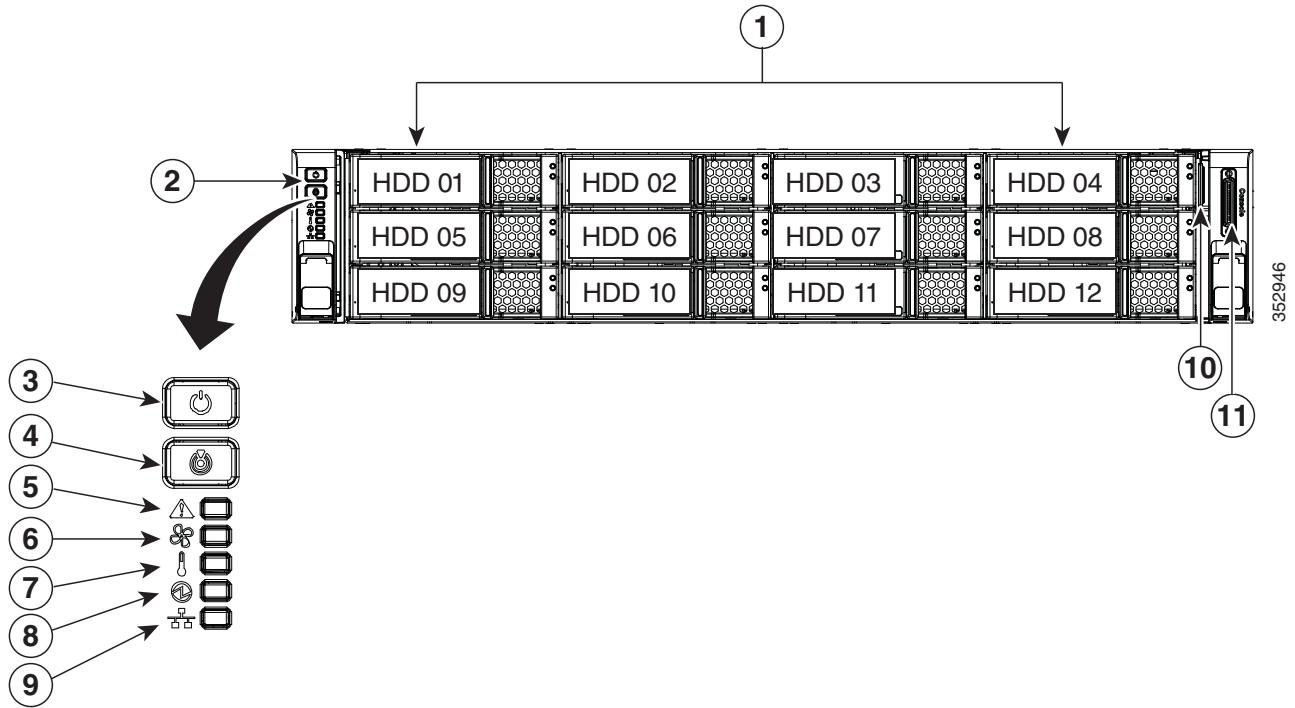

1	Drive bays 1-12 (up to 12 3.5-inch drives)	7	Temperature status LED
2	Operations panel buttons and LEDs	8	Power supply status LED
3	Power button/LED	9	Network link activity LED
4	Unit Identification button/LED	10	Pull-out asset tag
5	System status LED	11	KVM connector (used with KVM cable that provides two USB 2.0 connectors, one VGA connector, and one serial connector)
6	Fan status LED		

For more information about the KVM cable connection, see [KVM CABLE, page 88](#).

Chassis Rear View

Figure 3 shows the external features of the rear panel.

Figure 3 Chassis Rear View

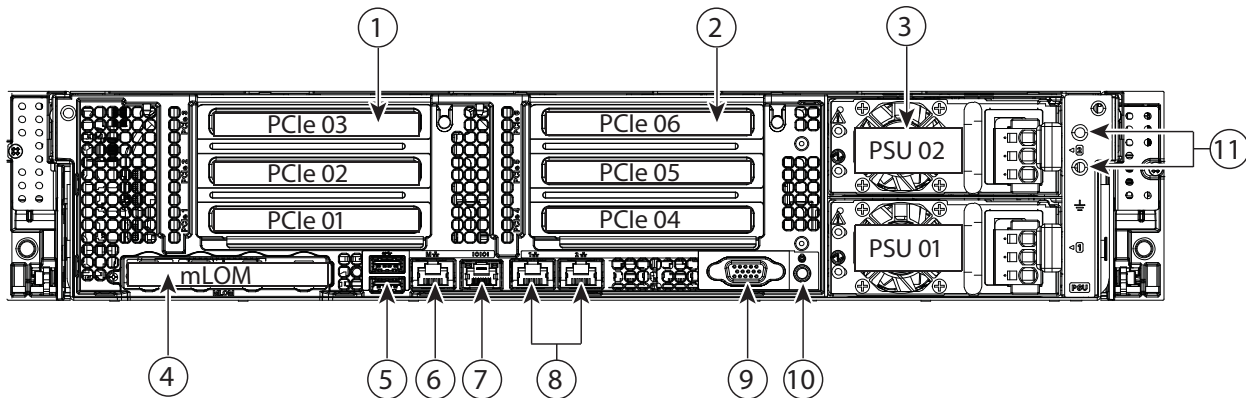

352947

1	PCIe riser 1 (slots 1, 2, 3*) *Slot 3 not present in all versions. See Riser Card Configuration and Options, page 79 for details.	7	Serial connector (RJ-45) ¹
2	PCIe riser 2 (slots 4, 5, 6), See Riser Card Configuration and Options, page 79 for details.	8	Two embedded (on the motherboard) Intel i350 GbE Ethernet controller ports LAN1 is the left connector, LAN2 is the right connector
3	Power supplies (DC power supplies shown)	9	VGA video port (DB-15 connector)
4	Modular LAN-on-motherboard (mLOM) card slot	10	Rear Unit Identification button/LED
5	USB 3.0 ports (two)	11	Grounding-lug holes (for DC power supplies)
6	1-Gb dedicated management port		—

Notes . . .

1. For serial port pinout details, see [Serial Port Details, page 81](#)

The port numbers for an mLOM VIC (for example, the VIC 1227T) and for a PCIe VIC (for example, the VIC 1225T) are shown in [Figure 4](#). In the case of both cards, the Port 1 connector is on the right and the Port 2 connector is on the left.

Figure 4 VIC Port Numbering

VIC 1227T



VIC 1225T



BASE SERVER STANDARD CAPABILITIES and FEATURES

Table 1 lists the capabilities and features of the base server. Details about how to configure the server for a particular feature or capability (for example, number of processors, disk drives, or amount of memory) are provided in *CONFIGURING the SERVER, page 13*.

Table 1 Capabilities and Features

Capability/Feature	Description
Chassis	Two rack unit (2RU) chassis
CPU	One or two Intel Xeon E5-2600 v3 or v4 series processor family CPUs
Chipset	Intel® C610 series chipset
Memory	24 slots for registered ECC DIMMs (RDIMMs) or load-reduced DIMMs (LRDIMMs)
Multi-bit Error Protection	This server supports multi-bit error protection.
Expansion slots	<p>Up to six PCIe slots (on two riser cards)</p> <ul style="list-style-type: none"> ■ Riser 1 (PCIe slots 1, 2, and 3), controlled by CPU 1. <ul style="list-style-type: none"> • Option A: Two slots available. Slot 1 = full height, 3/4 length, x8, NCSI¹. Slot 2 = full height, full length, x16, NCSI, GPU capable. NCSI is supported on only one slot at a time. • Option B: Three slots available. Slot 1 = full height, 3/4 length, x8. Slot 2 = full height, full length, x8, NCSI. Slot 3 = full height, full length, x8. • Option C: Two slots available. Slot 1 = full height, 3/4 length, x8, NCSI. Slot 2 = full height, full length, x16, NCSI. In addition, the riser contains two connectors for connecting up to two SATA boot drives. ■ Riser 2 (PCIe slots 4, 5, and 6), controlled by CPU 2. Three slots available. Slot 4 = full height, 3/4 length, x8, NCSI. Slot 5 = full height, full length, x16, NCSI, GPU capable. Slot 6 = full height, full length, x8. NCSI is supported on only one slot at a time. ■ Dedicated RAID controller slot (see <i>Figure 7 on page 68</i>) <ul style="list-style-type: none"> • An internal slot is reserved for the 12G SAS Modular RAID controller card (see <i>Figure 7 on page 68</i>). <p>For more details on riser 1 and riser 2 see <i>Riser Card Configuration and Options, page 79</i>.</p>
Video	<p>The Cisco Integrated Management Controller (CIMC) provides video using the Matrox G200e video/graphics controller:</p> <ul style="list-style-type: none"> ■ Integrated 2D graphics core with hardware acceleration ■ DDR2/3 memory interface supports up to 512 MB of addressable memory (8 MB is allocated by default to video memory) ■ Supports display resolutions up to 1920 x 1200 16bpp @ 60Hz ■ High-speed integrated 24-bit RAMDAC ■ Single lane PCI-Express host interface running at Gen 1 speed

Capability/Feature	Description
Internal storage devices	<p>Drives are installed into front-panel drive bays that provide hot-pluggable access.</p> <ul style="list-style-type: none"> ■ Large Form Factor (LFF) drives. The server can hold up to 12 3.5-inch SAS hard disk drives (HDDs). The server uses a 12-drive backplane with a SAS expander. Additionally, two optional internal 2.5 inch SATA SSDs can be installed for booting an OS. ■ The server also contains one internal USB 3.0 port on the motherboard that you can use with an optional 16 GB USB thumb drive for additional storage ■ UCS Storage Accelerators are also available. These plug-in PCIe flash storage cards provide independent high-speed storage.
Cisco Flexible Flash drives	<p>The server supports up to two internal 32 GB or two internal 64 GB Cisco Flexible Flash drives (SD cards).</p> <p>The second SD card is blank and can be used to mirror the first SD card. It can be used to protect the Hypervisor Partition with RAID1.</p>
Interfaces	<ul style="list-style-type: none"> ■ Rear panel <ul style="list-style-type: none"> • One DB15 VGA connector • One RJ45 serial port connector • Two USB 3.0 port connectors • One RJ-45 10/100/1000 Ethernet management port, using Cisco Integrated Management Controller (CIMC) firmware • Two Intel i350 embedded (on the motherboard) GbE LOM ports • One flexible modular LAN on motherboard (mLOM) slot that can accommodate various interface cards ■ Various PCIe card ports (dependent on which cards are installed) <ul style="list-style-type: none"> • Virtual Interface Card (VIC) ports • Converged Network Adapter (CNA) ports • Network Interface Card (NIC) ports • Host Bus Adapter (HBA) ports ■ Front panel <ul style="list-style-type: none"> • One KVM console connector (supplies two USB 2.0 connectors, one VGA DB15 video connector, and one serial port (RS232) RJ45 connector)
Power subsystem	<p>Up to two of the following hot-swappable power supplies:</p> <ul style="list-style-type: none"> ■ 650 W (AC) ■ 930 W (DC) ■ 1200 W (AC) ■ 1400 W (AC) <p>One power supply is mandatory; one more can be added for 1 + 1 redundancy.</p>

Capability/Feature	Description
Storage controller	<ul style="list-style-type: none"> ■ Cisco 12G SAS Modular RAID controller card with internal SAS connectivity. <ul style="list-style-type: none"> • Supports up to 24 internal drives (note however that this server can be configured with a maximum of 12 drives) • Plugs into a dedicated RAID controller slot <p>Can be purchased alone, or along with an onboard Flash-Backed Write Cache (FBWC) upgrade option, as shown in the table below</p>

RAID Card Version	Supported RAID Levels	Onboard TMM Cache
UCSC-MRAID12G ¹	JBOD, 0, 1, 10	None
UCSC-MRAID12G-1GB ²	JBOD, 0, 1, 10, 5, 6, 50, 60	1 GB
UCSC-MRAID12G-2GB ²	JBOD, 0, 1, 10, 5, 6, 50, 60	2 GB
UCSC-MRAID12G-4GB ²	JBOD, 0, 1, 10, 5, 6, 50, 60	4 GB

Notes . . .

1. Base RAID controller card (RAID 0, 1, 10 only)
2. FBWC option for base RAID controller card (adding the FBWC option extends the RAID levels)

All versions of the UCSC-MRAID12G RAID controller support up to 24 internal SAS drives (limited to 12 drives for this server).

- Cisco 12 Gbps Modular SAS HBA with internal SAS connectivity
 - Supports up to 24 internal drives (note however that this server can be configured with a maximum of 12 drives)
 - Plugs into a dedicated PCIe slot at the rear of the server (slot 1 of riser 1)
 - Supports JBOD only, not RAID, as shown in the below table.

HBA Card Version	Supported RAID Levels
UCSC-SAS12GHBA	JBOD only

- Cisco 9300-8E 12G SAS HBA with external SAS connectivity
 - Provides 8 external SAS ports
 - Plugs into a PCIe slot at the rear of the server
 - No FBWC (cache) or cache power backup
 - SAS 3.0 compliant

Capability/Feature	Description
Embedded NIC	Two embedded (on the motherboard) Intel i350 GbE ports, supporting the following: <ul style="list-style-type: none"> ■ Pre-Execution Boot (PXE boot) ■ iSCSI boot ■ Checksum and segmentation offload ■ NIC teaming
Modular LAN on Motherboard (mLOM) slot	The mLOM slot can flexibly accommodate the following cards: <ul style="list-style-type: none"> ■ Cisco Virtual Interface Cards (VIC) ■ Quad Port Intel i350 1GbE RJ45 Network Interface Card (NIC)
 <p>NOTE: The four Intel i350 ports are provided on an optional card that plugs into the mLOM slot, and are separate from the two embedded (on the motherboard) LAN ports</p>	
WoL	The 1-Gb Base-T Ethernet LAN ports support the wake-on-LAN (WoL) standard. <ul style="list-style-type: none"> ■ A front panel controller provides status indications and control buttons
Front Panel	
ACPI	This server supports the advanced configuration and power interface (ACPI) 4.0 standard.
Fans	Chassis: <ul style="list-style-type: none"> ■ Six hot-swappable fans for front-to-rear cooling
Integrated management processor	Baseboard Management Controller (BMC) running Cisco Integrated Management Controller (CIMC) firmware. Depending on your CIMC settings, the CIMC can be accessed through the 1-GbE dedicated management port, the 1-GbE LOM ports, or a Cisco virtual interface card (VIC).
Boot drives	Up to two optional SATA drives can be installed internal to the chassis on riser 1. The two SATA boot drives are managed in AHCI mode, using OS-based software RAID.

Notes . . .

1. NCSI = Network Communications Services Interface protocol. An NCSI slot is powered even when the server is in standby power mode.

CONFIGURING the SERVER

Follow these steps to configure the Cisco UCS C240 M4 High-Density LFF Rack Server:

- *STEP 1 VERIFY SERVER SKU, page 14*
- *STEP 2 SELECT RISER CARDS (OPTIONAL), page 15*
- *STEP 3 SELECT CPU(s), page 16*
- *STEP 4 SELECT MEMORY, page 19*
- *STEP 5 SELECT RAID CONTROLLERS, page 25*
- *STEP 6 SELECT HARD DISK DRIVES (HDDs) or SOLID-STATE DRIVES (SSDs), page 31*
- *STEP 7 SELECT PCIe OPTION CARD(s), page 34*
- *STEP 8 ORDER OPTIONAL NETWORK CARD ACCESSORIES, page 39*
- *STEP 9 ORDER GPU CARDS(OPTIONAL), page 44*
- *STEP 10 ORDER POWER SUPPLY, page 47*
- *STEP 11 SELECT AC POWER CORD(s), page 48*
- *STEP 12 ORDER TOOL-LESS RAIL KIT AND OPTIONAL REVERSIBLE CABLE MANAGEMENT ARM, page 51*
- *STEP 13 SELECT NIC MODE (OPTIONAL), page 52*
- *STEP 14 ORDER A TRUSTED PLATFORM MODULE (OPTIONAL), page 53*
- *STEP 15 ORDER CISCO FLEXIBLE FLASH SD CARD MODULE (OPTIONAL), page 55*
- *STEP 16 ORDER OPTIONAL USB 3.0 DRIVE, page 56*
- *STEP 17 SELECT OPERATING SYSTEM AND VALUE-ADDED SOFTWARE, page 57*
- *STEP 18 SELECT OPERATING SYSTEM MEDIA KIT, page 60*
- *STEP 19 SELECT SERVICE and SUPPORT LEVEL, page 61*
- *OPTIONAL STEP - ORDER RACK(s), page 66*
- *OPTIONAL STEP - ORDER PDU, page 67*

STEP 1 VERIFY SERVER SKU

Select one server product ID (PID) from [Table 2](#).

Table 2 PID of the C240 M4 High-Density LFF Rack Base Server

Product ID (PID)	Description
UCSC-C240-M4L	UCS C240 M4 LFF, no CPU, memory, HDD, SSD, PCIe cards, tool-less rail kit, or power supply, with 12-drive backplane with SAS expander

The Cisco UCS C240 M4 server:

- Does not include power supply, CPU, memory, hard disk drives (HDDs), solid-state drives (SSDs), boot drives, SD cards, riser 1, riser 2, tool-less rail kit, or PCIe cards.



NOTE: Use the steps on the following pages to configure the server with the components that you want to include.

STEP 2 SELECT RISER CARDS (OPTIONAL)

There are two optional riser cards, riser card 1 and 2. There are three options for riser card 1. Order one riser card 1 from [Table 2](#) and one riser 2 card from [Table 3](#). Riser card 1 is the one on the left when viewed from the back of the server and riser card 2 is on the right.

Table 3 PID of the Riser 1 Card

Product ID (PID)	Description
UCSC-PCI-1A-240M4	C240 M4 PCIe Riser 1 Assy (option A) (2 PCIe slots: 1x8 and 1x16 GPU capable)
UCSC-PCI-1B-240M4	C240 M4 PCIe Riser 1 Assy (option B) (3 PCIe slots: 3x8)
UCSC-PCI-1C-240M4	C240 M4 PCIe Riser 1 Assy (option C) (2 PCIe slots: 1x8 and 1x16 plus connectors for 2 SATA boot drives)

The selection of riser card 1 determines the number and type of PCIe cards and SATA boot drives supported in the riser.

Table 4 PID of the Riser 2 Card

Product ID (PID)	Description
UCSC-PCI-2-C240M4	Left PCIe Riser Board (Riser 2) for C240 M4 (3 slots: 2x8 and 1x16)

For additional details, see [Riser Card Configuration and Options, page 79](#).

STEP 3 SELECT CPU(s)

The standard CPU features are:

- Intel Xeon E5-2600 v3 and v4 series processor family CPUs
- Intel C610 series chipset
- Cache size of up to 55 MB

Select CPUs

The available CPUs are listed in [Table 5](#).

Table 5 Available Intel CPUs

Product ID (PID)	Intel Number	Clock Freq (GHz)	Power (W)	Cache Size (MB)	Cores	QPI	Highest DDR4 DIMM Clock Support (MHz) ¹
E5-2600 v4 Series Processor Family CPUs							
UCS-CPU-E52699E	E5-2699 v4	2.20	145	55	22	9.6 GT/s	2400
UCS-CPU-E52698E	E5-2698 v4	2.20	135	50	20	9.6 GT/s	2400
UCS-CPU-E52697AE	E5-2697A v4	2.60	145	40	16	9.6 GT/s	2400
UCS-CPU-E52697E	E5-2697 v4	2.30	145	45	18	9.6 GT/s	2400
UCS-CPU-E52695E	E5-2695 v4	2.10	120	45	18	9.6 GT/s	2400
UCS-CPU-E52690E	E5-2690 v4	2.60	135	35	14	9.6 GT/s	2400
UCS-CPU-E52683E	E5-2683 v4	2.10	120	40	16	9.6 GT/s	2400
UCS-CPU-E52680E	E5-2680 v4	2.40	120	35	14	9.6 GT/s	2400
UCS-CPU-E52667E	E5-2667 v4	3.20	135	25	8	9.6 GT/s	2400
UCS-CPU-E52660E	E5-2660 v4	2.00	105	35	14	9.6 GT/s	2400
UCS-CPU-E52650E	E5-2650 v4	2.20	105	30	12	9.6 GT/s	2400
UCS-CPU-E52650LE	E5-2650L v4	1.70	65	35	14	9.6 GT/s	2400
UCS-CPU-E52643E	E5-2643 v4	3.40	135	20	6	9.6 GT/s	2400
UCS-CPU-E52640E	E5-2640 v4	2.40	90	25	10	8.0 GT/s	2133
UCS-CPU-E52637E	E5-2637 v4	3.50	135	15	4	9.6 GT/s	2400
UCS-CPU-E52630E	E5-2630 v4	2.20	85	25	10	8.0 GT/s	2133
UCS-CPU-E52630LE	E5-2630L v4	1.80	55	25	10	8.0 GT/s	2133
UCS-CPU-E52623E	E5-2623 v4	2.60	85	10	4	8.0 GT/s	2133
UCS-CPU-E52620E	E5-2620 v4	2.10	85	20	8	8.0 GT/s	2133
UCS-CPU-E52609E	E5-2609 v4	1.70	85	20	8	6.4 GT/s	1866
UCS-CPU-E52658E	E5-2658 v4	2.30	105	35	14	9.6 GT/s	2400

Table 5 Available Intel CPUs (*continued*)

Product ID (PID)	Intel Number	Clock Freq (GHz)	Power (W)	Cache Size (MB)	Cores	QPI	Highest DDR4 DIMM Clock Support (MHz) ¹
E5-2600 v3 Series Processor Family CPUs							
UCS-CPU-E52699D	E5-2699 v3	2.30	145	45	18	9.6 GT/s	2133
UCS-CPU-E52698D	E5-2698 v3	2.30	135	40	16	9.6 GT/s	2133
UCS-CPU-E52697D	E5-2697 v3	2.60	145	35	14	9.6 GT/s	2133
UCS-CPU-E52695D	E5-2695 v3	2.30	120	35	14	9.6 GT/s	2133
UCS-CPU-E52690D	E5-2690 v3	2.60	135	30	12	9.6 GT/s	2133
UCS-CPU-E52683D	E5-2683 v3	2.00	120	35	14	9.6 GT/s	2133
UCS-CPU-E52680D	E5-2680 v3	2.50	120	30	12	9.6 GT/s	2133
UCS-CPU-E52670D	E5-2670 v3	2.30	120	30	12	9.6 GT/s	2133
UCS-CPU-E52667D	E5-2667 v3	3.20	135	20	8	9.6 GT/s	2133
UCS-CPU-E52660D	E5-2660 v3	2.60	105	25	10	9.6 GT/s	2133
UCS-CPU-E52658D	E5-2658 v3	2.20	105	30	12	9.6 GT/s	2133
UCS-CPU-E52650D	E5-2650 v3	2.30	105	25	10	9.6 GT/s	2133
UCS-CPU-E52650LD	E5-2650L v3	1.80	65	30	12	9.6 GT/s	1866
UCS-CPU-E52643D	E5-2643 v3	3.40	135	20	6	9.6 GT/s	2133
UCS-CPU-E52640D	E5-2640 v3	2.60	90	20	8	8.0 GT/s	1866
UCS-CPU-E52637D	E5-2637 v3	3.50	135	15	4	9.6 GT/s	2133
UCS-CPU-E52630D	E5-2630 v3	2.40	85	20	8	8.0 GT/s	1866
UCS-CPU-E52630LD	E5-2630L v3	1.80	55	20	8	8.0 GT/s	1866
UCS-CPU-E52623D	E5-2623 v3	3.00	105	10	4	8.0 GT/s	1866
UCS-CPU-E52620D	E5-2620 v3	2.40	85	15	6	8.0 GT/s	1866
UCS-CPU-E52609D ²	E5-2609 v3	1.90	85	15	6	6.4 GT/s	1600

Notes . . .

1. If higher or lower speed DIMMs are selected than what is shown in the table for a given CPU, the DIMMs will be clocked at the lowest common denominator of CPU clock and DIMM clock.
2. The E5-2609 v3 CPU does not support Intel Hyper-Threading or Intel Turbo Boost technologies.

Approved Configurations

(1) 1-CPU configurations:

- Select any one CPU listed in [Table 5](#).

(2) 2-CPU Configurations:

- Select two identical CPUs from any one of the rows of [Table 5 on page 16](#).

Caveats

- You can select either one processor or two identical processors.
- The selection of 1 or 2 CPUs depends on the desired server functionality. See the following sections:
 - [STEP 4 SELECT MEMORY, page 19](#) (memory mirroring section)
 - [STEP 7 SELECT PCIe OPTION CARD\(s\), page 34](#)
 - [Table 10 on page 28](#) (RAID support table)
 - [ORDER GPU CARDS\(OPTIONAL\), page 44](#)
- For optimal performance, select DIMMs with the highest clock speed for a given processor (see [Table 5 on page 16](#)). If you select DIMMs whose speeds are lower or higher than that shown in the tables, suboptimal performance will result.

STEP 4 SELECT MEMORY

The standard memory features are:

- DIMMs
 - Clock speed: 2400 or 2133 MHz
 - Ranks per DIMM: 1, 2, 4, or 8
 - Operational voltage: 1.2 V
 - Registered ECC DDR4 DIMMs (RDIMMs) or load-reduced DIMMs (LRDIMMs)
- Memory is organized with four memory channels per CPU, with up to three DIMMs per channel, as shown in [Figure 5](#).

Figure 5 C240 M4 LFF Memory Organization

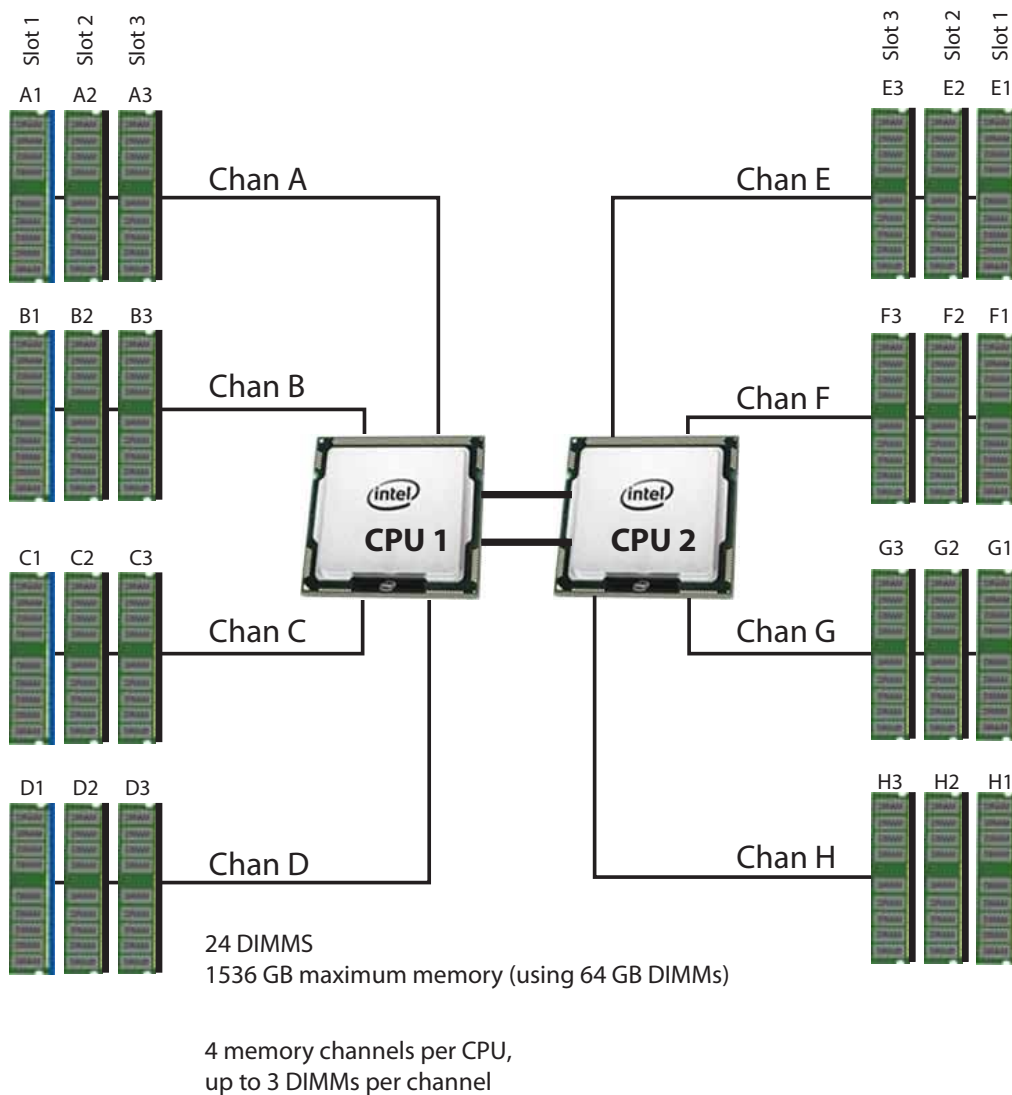

Select DIMMs and Memory Mirroring

Select the memory configuration and whether or not you want the memory mirroring option. The available memory DIMMs and mirroring option are listed in [Table 6](#).



NOTE: When memory mirroring is enabled, the memory subsystem simultaneously writes identical data to two channels. If a memory read from one of the channels returns incorrect data due to an uncorrectable memory error, the system automatically retrieves the data from the other channel. A transient or soft error in one channel does not affect the mirrored data, and operation continues unless there is a simultaneous error in exactly the same location on a DIMM and its mirrored DIMM. Memory mirroring reduces the amount of memory available to the operating system by 50% because only one of the two populated channels provides data.

Table 6 Available DDR4 DIMMs

Product ID (PID)	PID Description	Voltage	Ranks /DIMM
2400-MHz DIMM Options			
UCS-ML-1X644RV-A	64GB DDR4-2400-MHz LRDIMM/PC4-19200/quad rank/x4	1.2 V	4
UCS-ML-1X324RV-A	32GB DDR4-2400-MHz LRDIMM/PC4-19200/quad rank/x4	1.2 V	4
UCS-MR-1X322RV-A	32GB DDR4-2400-MHz RDIMM/PC4-19200/dual rank/x4	1.2 V	2
UCS-MR-1X162RV-A	16GB DDR4-2400-MHz RDIMM/PC4-19200/dual rank/x4	1.2 V	2
UCS-MR-1X161RV-A	16GB DDR4-2400-MHz RDIMM/PC4-19200/single rank/x4	1.2 V	1
UCS-MR-1X081RV-A	8 GB DDR4-2400-MHz RDIMM/PC4-19200/single rank/x4	1.2 V	1
2133-MHz DIMM Options			
UCS-MR-1X648RU-A ^{1, 2}	64GB DDR4-2133-MHz TSV-RDIMM/PC4-17000/octal rank/x4	1.2 V	8
UCS-MR-1X322RU-A	32GB DDR4-2133-MHz RDIMM/PC4-17000/dual rank/x4	1.2 V	2
UCS-ML-1X324RU-A	32GB DDR4-2133-MHz LRDIMM/PC4-17000/quad rank/x4	1.2 V	4
UCS-MR-1X162RU-A	16GB DDR4-2133-MHz RDIMM/PC4-17000/dual rank/x4	1.2 V	2
UCS-MR-1X081RU-A	8GB DDR4-2133-MHz RDIMM/PC4-17000/single rank/x4	1.2 V	1
Memory Mirroring Option			
N01-MMIRROR	Memory mirroring option		

Notes . . .

1. Power capping is not supported when using 64GB TSV-RDIMMS.
2. NVIDIA GPUs can support only less than 1 TB of total memory in the server. Do not install more than fourteen 64-GB DIMMs when using an NVIDIA GPU card in this server.

Approved Configurations

(1) 1-CPU configuration without memory mirroring:

- Select from 1 to 12 DIMMs. Refer to [Memory Population Rules, page 72](#), for more detailed information.

(2) 1-CPU configuration with memory mirroring:

- Select 2, 4, 8, or 12 identical DIMMs. The DIMMs will be placed by the factory as shown in the following table.

Total Number of DIMMs	CPU 1 DIMM Placement in Channels (for identical dual-rank DIMMs for 3DPC or identical quad-rank DIMMs for 2DPC)		
	Blue Slots	Black Slots	White Slots
2	(A1, B1)	—	—
4	(A1,B1); (C1,D1)	—	—
8	(A1,B1); (C1,D1)	(A2,B2); (C2,D2)	—
12	(A1,B1); (C1,D1)	(A2,B2); (C2,D2)	(A3,B3); (C3,D3)

- Select the memory mirroring option (N01-MMIRROR) as shown in [Table 6 on page 20](#).

(3) 2-CPU configuration without memory mirroring:

- Select from 1 to 12 DIMMs per CPU. Refer to [Memory Population Rules, page 72](#), for more detailed information.

(4) 2-CPU configuration with memory mirroring:

- Select 2, 4, 8, or 12 identical DIMMs per CPU. The DIMMs will be placed by the factory as shown in the following table.

Number of DIMMs per CPU	CPU 1 DIMM Placement in Channels (for identical dual-rank DIMMs for 3DPC or identical quad-rank DIMMs for 2DPC)			CPU 2 DIMM Placement in Channels (for identical dual-rank DIMMs for 3DPC or identical quad-rank DIMMs for 2DPC)		
	Blue Slots	Black Slots	White Slots	Blue Slots	Black Slots	White Slots
2	(A1, B1)	—	—	(E1, F1)	—	—
4	(A1,B1); (C1,D1)	—	—	(E1,F1); (G1,H1)	—	—
8	(A1,B1); (C1,D1)	(A2,B2); (C2,D2)	—	(E1,F1); (G1,H1)	(E2,F2); (G2,H2)	—
12	(A1,B1); (C1,D1)	(A2,B2); (C2,D2)	(A3, B3); (C3, D3)	(E1,F1); (G1,H1)	(E2,F2); (G2,H2)	(E3,F3); (G3,H3)

- Select the memory mirroring option (N01-MMIRROR) as shown in [Table 6 on page 20](#).



NOTE: System performance is optimized when the DIMM type and quantity are equal for both CPUs, and when all channels are filled equally across the CPUs in the server.

Caveats

- System speed is dependent on how many DIMMs are populated per channel. See [Table 7](#) for details.

Table 7 2133-MHz DIMM Memory Speeds with Different CPUs

DIMM Speed	DPC	1600-MHz Capable CPU		1866-MHz Capable CPU		2133-MHz Capable CPU	
		LRDIMM (QR)	RDIMM (DR, SR)	LRDIMM (QR)	RDIMM (DR, SR)	LRDIMM (QR)	RDIMM (DR, SR)
2133 DIMM	1DPC	1600	1600	1866	1866	2133	2133
	2DPC	1600	1600	1866	1866	2133	2133
	3DPC	1600	1600	1600	1600	1866	1866 (32 GB RDIMMs and 16 GB DIMMs) 1600 (64 GB TSV RDIMMs, 8 GB RDIMMs)

Table 8 2400-MHz DIMM Memory Speeds with Different v4 CPUs

DIMM and CPU Frequencies	DPC	LRDIMM (QRx4) - 64 GB ¹	RDIMM (2Rx4) - 32 GB	LRDIMM (QRx4) - 32 GB ¹	RDIMM (SRx4) - 16 GB	RDIMM (SRx4) - 8 GB
		1.2 V	1.2 V	1.2 V	1.2 V	1.2 V
DIMM = 2400 MHz CPU = 2400 MHz	1DPC	2400 MHz	2400 MHz	2400 MHz	2400 MHz	2400 MHz
	2DPC	2400 MHz	2400 MHz	2400 MHz	2400 MHz	2400 MHz
	3DPC	2133 MHz	1866 MHz	2133 MHz	2133 MHz	2133 MHz
DIMM = 2400 MHz CPU = 2133 MHz	1DPC	2133 MHz	2133 MHz	2133 MHz	2133 MHz	2133 MHz
	2DPC	2133 MHz	2133 MHz	2133 MHz	2133 MHz	2133 MHz
	3DPC	1866 MHz	1866 MHz	1866 MHz	1866 MHz	1600 MHz
DIMM = 2400 MHz CPU = 1866 MHz	1DPC	1866 MHz	1866 MHz	1866 MHz	1866 MHz	1866 MHz
	2DPC	1866 MHz	1866 MHz	1866 MHz	1866 MHz	1866 MHz
	3DPC	1866 MHz	1600 MHz	1866 MHz	1600 MHz	1600 MHz

Notes . . .

1. Available at a future date

- The C240 M4 server supports four different memory reliability, availability, and serviceability (RAS) modes:
 - Independent Channel Mode
 - Mirrored Channel Mode
 - Lockstep Channel Mode
- Below are the system level RAS Mode combination limitations:
 - Mixing of Independent and Lockstep channel mode is not allowed per platform.
 - Mixing of Non-Mirrored and Mirrored mode is not allowed per platform.
 - Mixing of Lockstep and Mirrored mode is not allowed per platform.
- Do not mix RDIMMs with LRDIMMs
- Do not mix 64GB DDR4-2133-MHz TSV-RDIMMs with any other DIMMs
- Single-rank DIMMs can be mixed with dual-rank DIMMs in the same channel
- Do not mix quad-rank DIMMs with single- or dual-rank DIMMs in the same channel
- For best performance, observe the following:
 - DIMMs with different timing parameters can be installed on different slots within the same channel, but only timings that support the slowest DIMM will be applied to all.

As a consequence, faster DIMMs will be operated at timings supported by the slowest DIMM populated.

- When one DIMM is used, it must be populated in DIMM slot 1 (farthest away from the CPU) of a given channel.
- When single, dual or quad rank DIMMs are populated for 2DPC or 3DPC, always populate the higher number rank DIMM first (starting from the farthest slot). For a 3DPC example, first populate with quad-rank DIMMs in the DIMM slot 1. Then dual-rank DIMMs in the DIMM 2 slot. Then single-rank DIMMs in the DIMM 3slot.
- DIMMs for CPU 1 and CPU 2 (when populated) must always be configured identically.
- When using mirroring, DIMMs must be installed in identical pairs across paired DDR4 buses. That is, mirrored pairs in channels A and B must be identical and pairs in channels C and D must be identical. However, the DIMMs used in channels A and B can be different from those in channels C and D.
- Memory mirroring reduces the amount of available memory by 50% (quantity of DIMMs must be even for mirroring).
- Non-ECC DIMMs are not supported.
- Cisco memory from previous generation servers (DDR3) is not compatible with this server

For more information regarding memory, see [CPUs and DIMMs, page 71](#).

STEP 5 SELECT RAID CONTROLLERS

RAID Controller Option (internal HDD/SSD support)

Cisco 12G SAS Modular RAID Controller

You can choose the Cisco 12G SAS RAID controller, which plugs into a dedicated RAID controller card slot. This RAID controller supports RAID 0, 1, 10 (without the FBWC option) and supports RAID 0, 1, 10, 5, 6, 50, 60 (with the FBWC option).



NOTE: The number of RAID groups (virtual drives) supported per RAID controller is as follows:

- Cisco 12G SAS Modular RAID controller = 64

SAS HBA (internal HDD/SSD/JBOD support)

Instead of a RAID controller, you can choose a SAS HBA for internal drive connectivity (non-RAID):

- Cisco 12 Gbps Modular SAS HBA, which plugs into a dedicated RAID controller slot.

SAS HBA (external JBOD support)

In addition to a RAID controller or JBOD SAS HBA for internal drives, you can choose the following SAS HBA for external drive connectivity (non-RAID):

- Cisco 9300-8e 12G SAS HBA (provides 8 SAS ports for external JBOD connectivity).

RAID Volumes and Groups

When creating each RAID volume, follow these guidelines:

- Use the same capacity for each drive in each RAID volume
- For the Cisco 12G SAS modular RAID controller upgrade:
 - Use all SAS HDDs in each RAID volume

The number of RAID groups (virtual drives) supported per RAID controller is as follows:

- Cisco 12G SAS Modular RAID controller = 64

Select Controller Options

Select as follows:

- Cisco 12G SAS modular RAID controller or Cisco 12 Gbps Modular SAS HBA (see [Table 9](#)), or
- Mixed controllers:
 - One Cisco 12G SAS modular RAID controller or Cisco 12 Gbps Modular SAS HBA and
 - One or two Cisco 9300-8E 12G SAS HBAs for external SAS JBOD/enclosure connectivity support (see [Table 9](#)), or
- Dual HBAs:
 - Two Cisco 9300-8E 12G SAS HBAs (JBOD support only for external drives) from [Table 9 on page 26](#)



NOTE: Mixing the Cisco 9300-8E 12G SAS HBA in the same server as the Cisco 12 Gbps Modular SAS HBA requires the following firmware levels:

- Cisco IMC/BIOS 2.0(8) or later
- Cisco UCS Manager 2.2(6) or later (for integrated servers only)



NOTE: The Cisco 12G SAS modular RAID controller can be ordered with or without an optional FBWC. The FBWC option backs up the RAID controller write cache. The FBWC is available in 1 GB, 2 GB, or 4 GB sizes. See [Table 9](#) for details.



NOTE: For all valid combinations of internal/external RAID controller combinations, see [RAID Details, page 77](#).

Table 9 Hardware Controller Options

Product ID (PID)	PID Description
Controllers for Internal Drives	
Note that if the following Cisco 12G SAS Modular RAID controller or Cisco 12Gbps Modular SAS HBA controller is selected, it is factory-installed in the dedicated internal slot.	
UCSC-MRAID12G	Cisco 12G SAS Modular RAID Controller <ul style="list-style-type: none"> ■ Supports up to 24 internal SAS HDDs and SAS/SATA SSDs (limited to 12 drives in this server) ■ Supports JBOD, RAID 0, 1, 10 (with no FBWC option chosen) and has the ability to also support RAID 5, 6 if a Flash-Backed Write cache upgrade is chosen (shown below in this table)

Table 9 Hardware Controller Options (*continued*)

Product ID (PID)	PID Description
UCSC-SAS12GHBA or UCSC-PSAS12GHBA	Cisco 12 Gbps Modular SAS HBA <ul style="list-style-type: none"> ■ Supports up to 24 internal SAS HDDs and SAS/SATA SSDs (limited to 12 drives in this server) ■ Supports JBOD mode only (no RAID functionality. Ideal for SDS (Software Defined Storage) applications. It is also ideal for environments demanding the highest IOPs (for external SSD attach), where a RAID controller can be an I/O bottleneck.
Flash-Backed Write Cache (FBWC) Upgrade Options for Cisco 12G SAS Modular RAID controller	
UCSC-MRAID12G-1GB	1 GB FBWC, which includes a 1 GB MB memory plus a SuperCap for write cache backup. Supports JBOD, RAID 0, 1, 10, 5, 6, 50, and 60.
UCSC-MRAID12G-2GB	2 GB FBWC, which includes a 2 GB MB memory plus a SuperCap for write cache backup. Supports JBOD, RAID 0, 1, 10, 5, 6, 50, and 60.
UCSC-MRAID12G-4GB	4 GB FBWC, which includes a 4 GB MB memory plus a SuperCap for write cache backup. Supports JBOD, RAID 0, 1, 10, 5, 6, 50, and 60.
SAS HBA for External JBOD Attach	
Two SFF8644 mini-SAS HD connectors on this card are accessible at the rear of the chassis.	
UCSC-SAS9300-8E	Cisco 9300-8e 12G SAS HBA for external JBOD attach <ul style="list-style-type: none"> ■ Supports external JBOD using X8 wide SAS ports.
	<p>NOTE: For Cisco 9300-8e 12G SAS HBA external drive enclosure support, see the enclosure section of the compatibility list at the following link:</p> <p>http://tinyurl.com/pp83xyk</p> <p>Customers should contact their storage vendor for technical support related to external JBOD enclosures.</p>
RAID Configuration Options (not available for Cisco 12 Gbps Modular SAS HBA)	
R2XX-SRAID0	Enable Single Disk Raid 0 Setting
R2XX-RAID0	Factory preconfigured RAID striping option Enable RAID 0 Setting. Requires a minimum of one hard drive.
R2XX-RAID1	Factory preconfigured RAID mirroring option Enable RAID 1 Setting. Requires exactly two drives with the same size, speed, capacity.
R2XX-RAID5	Factory preconfigured RAID option Enable RAID 5 Setting. Requires a minimum of three drives of the same size, speed, capacity.
R2XX-RAID6	Factory preconfigured RAID option Enable RAID 6 Setting. Requires a minimum of four drives of the same size, speed, capacity.



NOTE: Although RAID levels 50 and 60 are not orderable from the factory, they are supported for selected controllers as shown in [Table 9 on page 26](#).

Approved Configurations

- The Cisco 12G SAS Modular RAID controller option supports up to 12 internal SAS HDDs with up to RAID 0, 1, 10, 5, 6, 50, 60 support (with FBWC option chosen).
- The Cisco 12 Gbps Modular SAS HBA option supports up to 12 internal SAS HDDs with JBOD support.
- The Cisco 9300-8e 12G SAS HBA supports up to 8 external SAS ports with JBOD support.

See [Table 10](#) for a summary of the supported controller configuration options.

Table 10 Supported Controller Configurations

# CPUs	Cisco 12G SAS Modular RAID Controller or Cisco 12 Gbps Modular SAS HBA ¹ (only one can be installed at a time)		Cisco 9300-8E 12G SAS HBA ²	# Drives Supported	RAID Support	Internal Drive Types Allowed
	Cisco 12G SAS Modular RAID Controller	Cisco 12 Gbps Modular SAS HBA				
1	Installed in dedicated slot	Installed in dedicated slot	Card absent	12 internal	0,1,10,5,6,50,60 (for 12G SAS) or JBOD (for Modular SAS HBA)	SAS HDDs, SAS/SATA SSDs
Only one of the above can be installed at a time						
1	Card absent	Card absent	Installed slot 1, 2, or 3	0 internal 1024 external	JBOD	None
1	Installed in dedicated slot	Installed in dedicated slot	Installed slot 1, 2, or 3	12 internal 1024 external	0,1,10,5,6,50,60 (for 12G SAS) or JBOD (for Modular SAS HBA) and JBOD (for 9300)	SAS HDDs, SAS/SATA SSDs
Only one of the above can be installed at a time						

Table 10 Supported Controller Configurations (*continued*)

# CPUs	Cisco 12G SAS Modular RAID Controller or Cisco 12 Gbps Modular SAS HBA ¹ (<u>only one can be installed at a time</u>)		Cisco 9300-8E 12G SAS HBA ²	# Drives Supported	RAID Support	Internal Drive Types Allowed
	Cisco 12G SAS Modular RAID Controller	Cisco 12 Gbps Modular SAS HBA				
2	Installed in dedicated slot	Installed in dedicated slot	Card absent	12 internal	0,1,10,5,6,50,60 (for 12G SAS) or JBOD (for Modular SAS HBA)	SAS HDDs, SAS/SATA SSDs
Only one of the above can be installed at a time						
2	Card absent	Card absent	Installed any slot	0 internal 1024 external	JBOD	None
2	Installed in dedicated slot	Installed in dedicated slot	Installed any slot	12 internal 1024 external	0,1,10,5,6,50,60 (for 12G SAS) or JBOD (for Modular SAS HBA) and JBOD (for 9300)	SAS HDDs, SAS/SATA SSDs
Only one of the above can be installed at a time						

Notes . . .

1. If you want to boot from a device other than the Cisco 12G SAS Modular RAID controller or Cisco 12 Gbps Modular SAS HBA, you can leave the card installed. Just disable the OPROM for its slot, and the system will boot even with the card installed.
2. External drive PCIe controller card is the Cisco 9300-8e 12G SAS HBA and can be installed simultaneously with the Cisco 12G SAS Modular RAID controller or the Cisco 12 Gbps Modular SAS HBA.

Caveats

- A maximum of one Cisco 9300-8e 12G SAS HBA can be installed, and it can be installed in any slot (depending on the number of CPUs installed). The system can also support combinations of one Cisco 9300-8e 12G SAS HBA and a Storage Accelerator card along with either a Cisco 12G SAS Modular RAID Controller, or a Cisco 12 Gbps Modular SAS HBA.
- For the Cisco 12G SAS Modular RAID controller, you can choose an optional RAID configuration (up to RAID 0, 1, 10, 5, 6, 50, 60 if optional FBWC option is chosen), which is preconfigured at the factory. The RAID level you choose must be an available RAID choice for the controller selected. RAID levels 50 and 60 are supported, although they are not available

as configuration options. It can also be combined with AHCI support for internal SSDs (SATA Boot Drives).



NOTE: For more important information regarding RAID support, see [RAID Details, page 77](#) and [RAID Option ROM \(OPROM\) Settings, page 78](#).

STEP 6 SELECT HARD DISK DRIVES (HDDs) or SOLID-STATE DRIVES (SSDs)

The standard disk drive features are:

- 3.5-inch large form factor
- Hot-pluggable
- Sled-mounted

Select Drives

The available HDDs and SSDs are listed in [Table 11](#).

Table 11 Available Hot-Pluggable Sled-Mounted HDDs

Product ID (PID)	PID Description ¹	Drive Type	Capacity
HDDs			
UCS-HD600G15CK9	600 GB 12G SAS 15K RPM LFF HDD (SED)	SAS	600 GB
UCS-HD6T12GAK9	6 TB 7.2K RPM HDD (4K sector format, SED)	SAS	6 TB
UCS-HD4T12GK9	4 TB 7.2K RPM HDD (SED)	SAS	4 TB
UCS-HD10T7KL4K ²	10 TB 12G SAS 7.2K RPM LFF HDD (4K sector format)	SAS	10 TB
UCS-HD10T7KEM	10 TB 12G SAS 7.2K RPM LFF HDD (512e)	SAS	10 TB
UCS-HD8T7KEM	8 TB 12G SAS 7.2K RPM LFF HDD (512e)	SAS	8 TB
UCS-HD6T7KEM	6 TB 12G SAS 7.2K RPM LFF HDD (512e)	SAS	6 TB
UCS-HD1T7KL12G	1 TB 12G SAS 7.2K RPM LFF HDD	SAS	6 TB
UCS-HD4T7KL12G	4 TB 12G SAS 7.2K RPM LFF HDD	SAS	4 TB
UCS-HD2T7KL12G	2 TB 12G SAS 7.2K RPM LFF HDD	SAS	2 TB
UCS-HD8T7KL4K ²	8 TB 12G SAS 7.2K RPM LFF HDD (4K sector format)	SAS	8 TB
UCS-HD6T7KL4K ²	6 TB 12G SAS 7.2K RPM LFF HDD (4K sector format)	SAS	6 TB
UCS-HD4T7KL4K ²	4 TB 12G SAS 7.2K RPM LFF HDD (4K sector format)	SAS	4 TB
UCS-HD2T7KL4K ²	2 TB 12G SAS 7.2K RPM LFF HDD (4K sector format)	SAS	2 TB
UCS-HD12TB10KHY-E	1.2 TB 3.5 inch 12G SAS 10K RPM HDD	SAS	1.2 TB
UCS-HDD1T12F212	1 TB SAS 7.2K RPM LFF HDD	SAS	1 TB
UCS-HD600G15KHY-E	600 GB 3.5 inch Hybrid 6G SAS 15K RPM HDD	SAS	600 GB
UCS-HD300G15KHY-E	300 GB 3.5 inch Hybrid 6G SAS 15K RPM HDD	SAS	300 GB

Table 11 Available Hot-Pluggable Sled-Mounted HDDs (*continued*)

Product ID (PID)	PID Description ¹	Drive Type	Capacity
SSDs			
UCS-SD800GBCK9	800 GB 2.5" Enterprise performance SAS SSD (10X FWPD-SED)	SAS	800 GB
UCS-SD400GBCK9	400 GB 2.5" Enterprise performance SAS SSD (10X FWPF-SED)	SAS	400 GB
UCS-SD16TG0KHY-EP	1.6 TB 3.5 inch Enterprise performance 6G SATA SSD (3X FWPD, Intel 3610)	SATA	1.6 TB
UCS-SD800G0KHY-EP	800 GB 3.5 inch Hybrid Enterprise Performance 12G SSD (10X FWPD, Samsung 1635)	SAS	800 GB
UCS-SD480G0KHY-EP	480 GB 3.5 inch Enterprise Performance 6G SATA SSD (3X FWPD, Intel 3610)	SATA	480 GB
UCS-SD120G0KHY-EV	120 GB 3.5 inch Enterprise Performance 6G SATA SSD (1FWPD)	SATA	120 GB

Notes . . .

1. For all self-encrypting drives (SED), standalone Management (CIMC) is supported for configuring and managing local keys (UCSM is not supported). Also, 4K format drives do not support VMware and require UEFI boot.
2. UCS Rack Servers require minimum firmware version 2.0(4) to support 4K sector size drives. Operating Systems supported on 4k sector size drives is as follows:

- Windows: Win2012 and Win2012R2
- Linux: RHEL 6.5/6.6/6.7/7.0/7.2/SLES 11 SP3 and SLES 12
- ESXi/VMware is not supported

EFI Mode must be used when booting from 4K sector size drives, legacy mode is not supported. Ensure that 4K sector size and 512 byte sector size drives are not mixed in the same RAID volume.

The available boot drives are listed in [Table 12](#).

Table 12 Available Boot Drives (mounted inside chassis)

Product ID (PID)	PID Description	Drive Type	Capacity
Boot Drives			
UCS-SD120GBE1K9	120GB Enterprise Value SSD (SATA) (1X FWPD, SED) (boot)	SATA	120 GB
UCS-SD16TBKS4-EB	1.6 TB 2.5 inch Enterprise Value 6G SATA SSD (BOOT)	SATA	1.6 TB
UCS-SD960G0KSB-EV	960 GB 2.5 inch Enterprise Value 6G SATA SSD (BOOT)	SATA	960 GB
UCS-SD480G0KSB-EV	480 GB 2.5 inch Enterprise Value 6G SATA SSD (BOOT)	SATA	480 GB
UCS-SD480GBKS4-EB	480 GB 2.5 inch Enterprise Value 6G SATA SSD (Boot)	SATA	480 GB
UCS-SD240GBKS4-EB	240 GB 2.5 inch Enterprise Value 6G SATA SSD (boot)	SATA	240 GB
UCS-SD120GBKS4-EB	120 GB 2.5 inch Enterprise Value 6G SATA SSD (boot)	SATA	120 GB
UCS-SD120G0KSB-EV	120 GB 2.5 inch Enterprise Value 6G SATA SSD (BOOT)	SATA	120 GB

Approved Configurations

(1) Cisco 12G SAS Modular RAID Controller

- If you selected a Cisco 12G SAS Modular RAID controller you have the following options:
 - Cisco 12G SAS Modular RAID controller *with no FBWC option* (supports JBOD, RAID 0, 1, 10)
 - Cisco 12G SAS Modular RAID controller *with FBWC option* (supports JBOD, RAID 0, 1, 10, 5, 6, 50, and 60)
 - For either option, select up to 12 SAS HDDs listed in [Table 11 on page 31](#). The Cisco 12G SAS Modular RAID controller does not support SATA HDDs.

(2) Cisco 12 Gbps Modular SAS HBA

- If you selected a Cisco 12 Gbps Modular SAS HBA, select up to 12 SAS HDDs.

See [SELECT RAID CONTROLLERS, page 25](#) for more details.

(3) Systems Using Boot Drives

- If you are configuring a system that uses SATA SSD boot drives, choose up to two identical boot drives from [Table 12 on page 32](#).



NOTE: The two SATA SSD boot drives are managed in AHCI mode, using OS-based software RAID. These two drives, managed with OS software RAID, can coexist with drives managed by a Cisco 12G SAS modular RAID controller or the Cisco 12 Gbps Modular SAS HBA. The drives are plugged directly to the SATA boot drive connectors on riser card 1 (option 3) and mounted inside the chassis. The internal boot drives come mounted to their own unique internal drive sleds, which are different from the front loading hot-swappable drive sleds. See [Riser Card Configuration and Options, page 79](#).

Caveats

- You can choose only SAS HDDs when using the Cisco 12G SAS Modular RAID Controller or Cisco 12 Gbps Modular SAS HBA.
- If you order one or two boot drives, you can order a maximum of one GPU and it must be installed in Riser 2 (UCSC-PCI-2-C240M4) slot 5.
- A maximum of two of the 400 GB 3.5-inch hybrid enterprise performance 12G SSDs can be installed.

STEP 7 SELECT PCIe OPTION CARD(s)

The standard PCIe card offerings are:

- Modular LAN on Motherboard (mLOM)
- Virtual Interface Cards (VICs)
- Network Interface Cards (NICs)
- Converged Network Adapters (CNAs)
- Host Bus Adapters (HBAs)
- UCS Storage Accelerators

Select PCIe Option Cards

The available PCIe option cards are listed in [Table 13](#).

Table 13 Available PCIe Option Cards¹

Product ID (PID)	PID Description	Card Height
Modular LAN on Motherboard (mLOM)²		
UCSC-MLOM-C10T-02	Cisco UCS VIC1227T VIC MLOM - Dual Port 10GBaseT	N/A
UCSC-MLOM-CSC-02	Cisco UCS VIC1227 VIC MLOM - Dual Port 10Gb SFP+	N/A
UCSC-MLOM-IRJ45	Intel i350 quad-port MLOM NIC	N/A
UCSC-MLOM-C40Q-03	Cisco VIC 1387 Dual Port 40Gb QSFP CNA MLOM	N/A
Virtual Interface Cards (VICs)		
UCSC-PCIE-CSC-02	Cisco VIC 1225 Dual Port 10Gb SFP+ CNA	Half
UCSC-PCIE-C10T-02	Cisco VIC 1225T Dual Port 10GBaseT CNA	Half
UCSC-PCIE-C40Q-03	Cisco VIC 1385 Dual Port 40Gb QSFP+ CNA w/RDMA	Half
Network Interface Cards (NICs)		
1 Gb NICs		
N2XX-ABPCI03-M3	Broadcom 5709 Quad Port 1Gb w/TOE iSCSI for M3 Servers	Half
N2XX-ABPCI01-M3	Broadcom 5709 Dual-Port Ethernet PCIe Adapter M3 & later	Half
UCSC-PCIE-IRJ45	Intel i350 Quad Port 1Gb Adapter	Half
10 Gb NICs		
N2XX-AIPCI01	Intel X520 Dual Port 10Gb SFP+ Adapter	Half
UCSC-PCIE-ITG	Intel X540 Dual Port 10GBase-T Adapter	Half
UCSC-PCIE-QNICBT	QLogic QLE8442 dual-port 10Gbase-T NIC	Half
UCSC-PCIE-QNICSFP	QLogic QLE8442 dual-port 10G SFP+ NIC	Half
UCSC-PCIE-ID10GC	Intel X550-T2 dual-port 10GBase-T NIC	Half
UCSC-PCIE-ID10GF	Intel X710-DA2 dual-port 10G SFP+ NIC	Half
UCSC-PCIE-IQ10GF	Intel X710 quad-port 10G SFP+ NIC	Full

Table 13 Available PCIe Option Cards¹

Product ID (PID)	PID Description	Card Height
UCSC-PCIE-ID40GF	Intel XL710 dual-port 40G QSFP+ NIC	Half
10 Gb Converged Network Adapters (CNAs)		
UCSC-PCIE-E14102	Emulex OCe14102-UX dual-port 10 GbE FCoE CNA	Half
UCSC-PCIE-Q8362	Qlogic QLE8362 dual-port 10 GbE FCoE CNA	Half
UCSC-PCIE-E14102B	Emulex OCe14102B-UX dual-port 10G SFP+ with iSCSI, FCoE CNA	Half
Host Bus Adapters (HBAs)		
N2XX-AQPCI05	Qlogic QLE2562 Dual Port 8Gb Fibre Channel HBA	Half
UCSC-PCIE-Q2672	Qlogic QLE2672-CSC, 16Gb Fibre Channel HBA with SR Optics	Half
N2XX-AEPCI05	Emulex LPe 12002 Dual Port 8Gb Fibre Channel HBA	Half
UCSC-PCIE-E16002	Emulex LPe16002-M6, 16Gb Fibre Channel HBA with SR Optics	Half
UCS Storage Accelerators ³		
UCSC-F-S64002	UCS Rack PCIe Storage 6400 GB SanDisk SX350 Medium Endurance	Full
UCSC-F-S32002	UCS Rack PCIe Storage 3200 GB SanDisk SX350 Medium Endurance	Half
UCSC-F-S16002	UCS Rack PCIe Storage 1600 GB SanDisk SX350 Medium Endurance	Half
UCSC-F-S13002	UCS Rack PCIe Storage 1300 GB SanDisk SX350 Medium Endurance	Half
UCSC-F-FIO-5200PS	UCS 5200 GB Fusion ioMemory3 PX Performance line for C-Series	Full
UCSC-F-FIO-2600PS	UCS 2600 GB Fusion ioMemory3 PX Performance line for C-Series	Half
UCSC-F-FIO-1300PS	UCS 1300 GB Fusion ioMemory3 PX Performance line for C-Series	Half
UCSC-F-FIO-1000PS	UCS 1000 GB Fusion ioMemory3 PX Performance line for C-Series	Half
UCS NVMe/PCIe Add in Cards		
UCSC-F-H38001	3.8 TB NVMe/PCIe storage (HGST SN150) Read Intensive	Half
UCSC-F-I20003	2.0 TB NVMe/PCIe storage (Intel P3600) High Endurance	Half
UCSC-F-H19001	1.9 GB NVMe/PCIe storage (HGST SN150) Read Intensive	Half
UCSC-F-I160010	1.6 TB NVMe/PCIe storage (Intel P3700) High Endurance	Half
UCSC-F-I12003	1.2 GB NVMe/PCIe storage (Intel P3600) High Endurance	Half
UCSC-F-I80010	800 GB NVMe/PCIe storage (Intel P3700) High Endurance	Half

Notes . . .

1. The GPU cards (see [ORDER GPU CARDS\(OPTIONAL\), page 44](#)) must be inserted into a full length x16 (electrical) PCIe slot. See [Riser Card Configuration and Options, page 79](#) for more details. The rest of the PCIe cards are x8 (electrical) and can be plugged into any PCIe slot of riser 1 or riser 2.
2. The mLOM cards do not plug into any of the riser 1 or riser 2 card slots; instead, they plug into a connector inside the server chassis.
3. A maximum of six storage accelerator cards are supported and some are riser dependent. 1.3 TB, 2.6 TB, or 3.2 TB cards should not be installed in to slots 5 or 6 so the total number of those capacity points is four. The Cisco 9300-8e 12G SAS HBA also can only be installed in riser 1; therefore if you install a Cisco 9300-8e 12G SAS HBA, it may displace one of the storage accelerator cards.

Caveats

- If you choose an external drives controller (Cisco 9300-8e 12G SAS HBA), it will consume one PCIe slot.
- A maximum of six storage accelerator cards are supported and some are riser dependent. 1.3 TB, 2.6 TB, or 3.2 TB cards should not be installed in to slots 5 or 6 so the total number of those capacity points is four.
- For 1-CPU systems:
 - Only the PCIe slots on PCIe riser 1 are available for 1-CPU system.
 - The PCIe slots on riser 2 are not supported on 1-CPU systems. The slots are full-height PCIe slots 4, 5, and 6 (see [Figure 3 on page 7](#)). These are the slots on the right when looking at the rear of the server.
 - Only a single plug-in PCIe VIC card may be installed on a 1-CPU system, and it must be installed in slot 2 of riser 1. You can also order an mLOM VIC card to be installed in the mLOM slot internal to the chassis and thus have two VIC cards in operation at the same time. See [Table 13 on page 34](#) for the selection of plug-in and mLOM VIC cards. See also [Table 1 on page 9](#) and [Riser Card Configuration and Options, page 79](#) for the PCIe slot physical descriptions.
- For 2-CPU systems:
 - Depending on the riser 1 option chosen, up to six PCIe slots are available, three on PCIe riser 1 (PCIe slots 1, 2, and 3) and three on PCIe riser 2 (PCIe slots 4, 5, and 6).
 - All of the slots are full-height.
 - Two plug-in PCIe VIC cards can be installed in 2-CPU systems, using slots 2 and 5. In addition, you can order an mLOM VIC card, which is installed in the mLOM slot inside the chassis and thus have three VIC cards in operation at the same time. See [Table 13 on page 34](#) for the selection of plug-in and mLOM VIC cards. See also [Table 1 on page 9](#) and [Riser Card Configuration and Options, page 79](#) for the PCIe slot physical descriptions.
 - If GPUs are installed in slots 2 (Riser 1 option A) and 5 (Riser 2), the NCSI capability automatically switches over to slots 1 (Riser 1 option A) and 4 (Riser 2). Therefore, Cisco PCIe VICs can be installed in slots 1 and 4 if GPUs are installed in slots 2 and 5.



NOTE: UCSM managed servers are discoverable only if a VIC 1225 is installed in slot 2 or a VIC 1227/1227T is installed in the MLOM slot. If you install two GPUs, they must be located in slots 2 and 5. Therefore, if two GPUs are installed, UCSM managed servers are discoverable only if you install a VIC 1227/1227T in the MLOM slot.

-
- Other considerations for the Cisco VIC 1225/1225T/1227/1227T/1385 cards:
 - VIC 1225 and VIC 1227/1227T support 10G SFP+ optical and copper twinax connections
 - VIC 1225T Supports RJ45 Category 6 or better twisted pair cable connections
 - VIC 1385 supports a 4x10 Gbps QSFP to SFP breakout fiber cable.

- The 2-CPU version of the server supports installation of two PCIe Cisco VIC 1225/1225T/1385 cards and they are supported in PCIe slots 2 and 5. Slot 2 is the primary slot for UCSM integration and slots 2 and 5 are the primary slots for Cisco NIC card mode.
- The server supports up to two PCIe Cisco VICs (1225, 1225T, 1385) plus an MLOM VIC (1227, 1227T), however, single wire management is supported on only one VIC at a time. If multiple VICs are installed on a server, only one slot has NCSI enabled at a time and for single wire management, priority goes to the MLOM slot, then slot 2, then slot 5 for NCSI management traffic. When multiple cards are installed, connect the single wire management cables in the priority order mentioned above.
- Installation of the Cisco UCS VIC1225 requires that the server have CIMC firmware version 1.4(6) or later installed and VIC firmware of 2.1(0) or later. Installation of the Cisco UCS VIC1225T requires that the server have CIMC firmware version 1.5(1) or later installed and VIC firmware of 2.1(1) or later.
- The server supports installation of up to two plug-in Cisco VIC 1225/1225T/1385 cards and they are supported only in certain slots. A third simultaneously operating VIC can be the mLOM VIC 1227/1227T card, which is installed in a slot inside the chassis. See [Table 14 on page 37](#) for details.
- The VIC features mentioned in this section are supported with the following software releases: 2.0.6 (CIMC) and 2.2.5a (UCSM).

Table 14 Cisco UCS 240 M4 Requirements for Plug-in Virtual Interface Cards

VIC PID	Number of Plug-in VICs Supported in Server	Slots That Support VICs ¹	Primary Slot For UCS Integration or Cisco Card NIC Mode	Minimum Cisco IMC Firmware	Minimum VIC Firmware
Cisco UCS VIC1225 (UCSC-PCIE-CSC-02)	2	PCIe 2 PCIe 1	Riser 1: PCIe 2 Riser 2: PCIe 5	1.4(6)	2.1(0)
Cisco UCS VIC1225T (UCSC-PCIE-C10T-02)	2	PCIe 5 PCIe 4	See footnote	1.5(1)	2.1(1)
Cisco UCS VIC 1385 ³ (UCSC-PCIE-C40Q-03)	2	See footnote ²		2.0(2)	2.2(16)

Notes . . .

1. For riser PID UCSC-PCI-1B-240M4 (riser 1 option B) only: Slot 2 is the only slot that supports a VIC.
2. For riser PIDs UCSC-PCI-1A-240M4 (riser 1 option A) only: When a GPU card is present in slot 2 of riser 1 option A, NCSI support automatically shifts to slot 1, which becomes the primary slot for a VIC. When a GPU card is present in riser 2 slot 5, NCSI support automatically shifts to slot 4, which becomes the primary slot for a VIC. UCSM managed servers are discoverable only if a VIC 1225 is installed in slot 2 or a VIC 1227/1227T is installed in the MLOM slot. If you install two GPUs, they must be located in slots 2 and 5. Therefore, if two GPUs are installed, UCSM managed servers are discoverable only if you install a VIC 1227/1227T in the MLOM slot.
3. If the Cisco UCS VIC 1385 is installed with another VIC, the VIC 1385 should be installed in the primary VIC slot (an x16 slot, such as riser 1 option A slot 2 or riser 2 slot 5). If riser1 option B is installed, slot 2 is an x8 slot, in which case the VIC 1385 should be installed in slot 5.

- The quantity and type of PCIe cards that can be installed depends in the riser card options. See *Riser Card Configuration and Options, page 79* for additional details.
- To help ensure that your operating system is compatible with the card you have selected, or to see additional cards that have been qualified to work with the UCS C240 M4 server, but are not sold on the Cisco pricelist, check the Hardware Compatibility List at this URL:

http://www.cisco.com/en/US/products/ps10477/prod_technical_reference_list.html

STEP 8 ORDER OPTIONAL NETWORK CARD ACCESSORIES

Copper twinax cables and SFP optical modules may be ordered to support the two-port network cards that are available with the server.

Choose Optional Twinax Cables

Table 15 lists the copper twinax cables available for the PCIe cards. You can choose cable lengths of 1, 3, 5, 7, or 10 meters. The two longer cables (7 and 10 meters) are active, which means that they contain active components within the SFP+ housing to improve signal quality.

Table 15 Available Twinax Cables

Product ID (PID)	PID Description
SFP-H10GB-CU1M	10GBASE-CU SFP+ Cable (1 M)
SFP-H10GB-CU3M	10GBASE-CU SFP+ Cable (3 M)
SFP-H10GB-CU5M	10GBASE-CU SFP+ Cable (5 M)
SFP-H10GB-ACU7M	10GBASE-CU SFP+ Cable (7 M)
SFP-H10GB-ACU10M	10GBASE-CU SFP+ Cable (10 M)

Approved Configurations

(1) Choose Up to Two Twinax Cables for Each Network Card Ordered

- You may choose one or two twinax cables for each compatible PCIe network card ordered. The cables can be different lengths; however, you would normally order two cables of equal lengths to connect to the primary and redundant network switching equipment.

Choose Optional SFP Modules

Optical Cisco SFP+ modules are listed in *Table 16*.

Table 16 Available SFP Modules

Product ID (PID)	PID Description
SFP-10G-SR	10GBASE-SR SFP+ Module 850 nm, multimode, SR, 3.3V, LC connector, with Digital Optical Monitoring
SFP-10G-LR	10GBASE-LR SFP+ Module 1310 nm, single mode, LR, 3.3 V, with Digital Optical Monitoring
DS-SFP-FC8G-SW	8 Gbit SFP+ Module 850 nm, multimode, SR, 3.3V, LC connector, with Digital Optical Monitoring

Approved Configurations

(1) Choose Up to Two SFP+ Modules for Each Network Card Ordered

- You may choose one or two SFP+ optical modules cables for each compatible PCIe network card ordered. You would normally order two modules for connecting to the primary and redundant network switching equipment. With the SFP+ optical modules, you can use common fiber optic cables, widely available.

See the *Figure 6 on page 43* for typical SFP+ and twinax connections to the network cards.

Caveats

Check the table on the following page for compatibility between the PCIe network cards and SFPs or twinax cables.



NOTE: The table shows all PCIe network cards for all C-series servers. Not all of the cards shown in the table are supported in this server. The intent of the table is to show compatibility between cards and twinax cables or SFPs.

Table 17 PCIe Card Compatibility

PCIe Cards	Twinax Cables	Cisco SFP Modules		
		SFP-10G-SR	SFP-10G-LR	DS-SFP-FC8G-SW
Converged Network Adapters (CNAs)				
UCSC-PCIE-BSFP (Broadcom 57712 Dual Port 10Gb SFP+ w/TOE iSCSI)	Yes	Yes	No	
UCSC-PCIE-CSC-02 (Cisco VIC 1225 Dual Port 10Gb SFP+ CNA)	Yes	Yes	Yes	No
UCSC-PCIE-C10T-02 (Cisco VIC 1225T Dual Port 10GBaseT CNA)	No	No	No	No
UCSC-MLOM-CSC-02 (Cisco UCS VIC1227 VIC MLOM - Dual Port 10Gb SFP+)	Yes	Yes	Yes	No
UCSC-MLOM-C10T-02 (Cisco UCS VIC1227T VIC MLOM - Dual Port 10GBaseT)	No	No	No	No
UCSC-PCIE-C40Q-02 (Cisco VIC 1285 Dual Port 40Gb QSFP CNA)	Yes	No ¹	No	
UCSC-PCIE-C40Q-03 (Cisco VIC 1385 Dual Port 40Gb QSFP+ CNA w/RDMA)	Yes	No ¹	No	
UCSC-PCIE-ESFP (Emulex OCe11102-FX dual-port 10 GbE FCoE CNA (Gen 3 CNA))	Yes	Yes	No	
UCSC-PCIE-QSFP (QLogic QLE8242-CU dual-port 10 GbE FCoE CNA)	Yes	Use Qlogic SFP		
UCSC-PCIE-B3SFP (Broadcom 57810 10Gb A-FEX SFP+)	Yes	Yes	No	
UCSC-PCIE-Q8362 (Qlogic QLE8362 dual-port 10 GbE FCoE CNA)	Yes	Use Qlogic SFP		
UCSC-PCIE-E14102 (Emulex OCe14102-UX dual-port 10 GbE FCoE CNA)	Yes	Yes	No	
Network Interface Cards (NICs)				
N2XX-ABPCI01-M3 (Broadcom 5709 Dual-Port Ethernet PCIe Adapter for M3 Servers)	Use RJ45 Ethernet cable			
N2XX-ABPCI03-M3 (Broadcom 5709 Quad Port 10/100/1Gb NIC w/TOE iSCSI for M3 Servers)	Use RJ45 Ethernet cable			
N2XX-AIPCI01 (Intel X520 Dual Port 10Gb SFP+ Adapter)	Yes	Use Intel SFP CDE2-SFP-1WLR or CDE2-SFP-1WSR		
UCSC-PCIE-ITG (Intel X540 Dual Port 10GBase-T Adapter)	Use RJ45 Ethernet cable			
UCSC-PCIE-IRJ45 (Intel i350 Quad Port 1Gb Adapter)	Use RJ45 Ethernet cable			

Table 17 PCIe Card Compatibility (continued)

PCIe Cards	Twinax Cables	Cisco SFP Modules		
		SFP-10G-SR	SFP-10G-LR	DS-SFP-FC8G-SW
UCSC-PCIE-BTG (Broadcom 57712 Dual Port 10GBASE-T w/TOE iSCSI)	Yes	No	No	
Host Bus Adapters (HBAs)				
N2XX-AEPCI03 (Emulex LPe 11002 Dual Port 4Gb Fibre Channel HBA)	No	Preinstalled - do not change SFP		
N2XX-AEPCI05 (Emulex LPe 12002 Dual Port 8Gb Fibre Channel HBA)	No	Preinstalled - do not change SFP		
N2XX-AQPCI03 (QLogic QLE2462 Dual Port 4Gb Fibre Channel HBA)	No	Preinstalled - do not change SFP		
N2XX-AQPCI05 (QLogic QLE2562 Dual Port 8Gb Fibre Channel HBA)	No	Preinstalled - do not change SFP		
UCSC-PCIE-Q2672 (QLogic QLE2672-CSC, 16Gb Fibre Channel HBA with SR Optics)	No	Preinstalled - do not change SFP		
UCSC-PCIE-E16002 (Emulex LPe16002-M6, 16Gb Fibre Channel HBA with SR Optics)	No	Preinstalled - do not change SFP		

Notes . . .

1. This card supports a 4x10 Gbps QSFP to SFP breakout fiber cable.

Figure 6 Network Card Connections

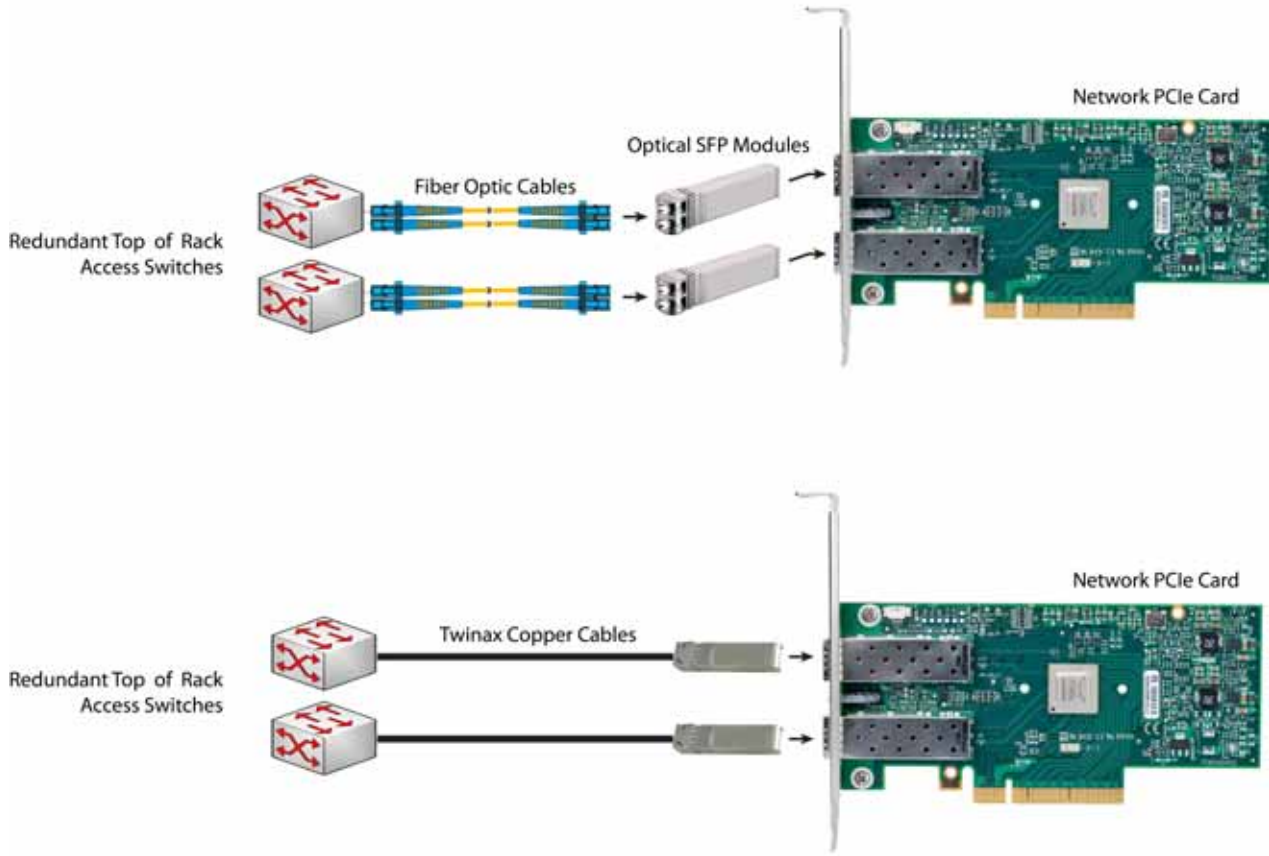

STEP 9 ORDER GPU CARDS(OPTIONAL)

Select GPU Options

The available GPU PCIe options are listed in [Table 18](#).

Table 18 Available PCIe Option Cards

Product ID (PID)	PID Description	Card Size
GPU PCIe Cards		
UCSC-GPU-VGXX1	NVIDIA GRID K1	Full-height, double wide
UCSC-GPU-VGXX2	NVIDIA GRID K2	Full-height, double wide
UCSC-GPU-K40	NVIDIA Tesla K40	Full-height, double wide
UCSC-GPU-M60 ¹	NVIDIA Tesla M60	Full-height, double wide
UCSC-GPU-K80 ¹	NVIDIA K80	Full-height, double wide

Notes . . .

1. You must order a kit with this GPU (UCS-300WKIT-240M4). It is a 300-Watt cable kit system for the UCS C240M4 rack server. Only one kit is needed for either one or two GPUs.



CAUTION: Do not operate the C240 M4 server with the 300W GPU kit installed, but no GPU card installed. The kit has been designed to provide adequate airflow for cooling only when at least one GPU card is installed.



CAUTION: When using GPU cards, the operating temperature range is 32° to 95°F (0° to 35°C).



NOTE: All GPU cards require two CPUs and a minimum of two power supplies in the server. 1400 W power supplies are recommended. Use the power calculator at the following link to determine the needed power based on the options chosen (CPUs, drives, memory, and so on):

<http://ucspowercalc.cisco.com>

Select GPU Power Cables

Whenever you select a K1/K2/K40 GPU for this server, you must also select one power cable for each GPU selected. The available GPU power cables are listed in [Table 19](#).

Table 19 Available GPU Power Cables

Product ID (PID)	PID Description
UCSC-GPUCBL-240M4	C240 M4 GPU Power Cable

Whenever you select a K80 GPU for this server, you must also select one power cable kit (for either one or two K80 GPUs). The available GPU power cables are listed in [Table 20](#).

Table 20 Available GPU Power Cables (K80 and M60 only)

Product ID (PID)	PID Description
UCS-300WKIT-240M4	300 Watt Cable and Kit for UCS C240M4 Rack Server

Caveats

- NVIDIA GPUs can support only less than 1 TB of total memory in the server. Do not install more than fourteen 64-GB DIMMs when using an NVIDIA GPU card in this server.
- NVIDIA GRID K1 and K2 GPUs can be mixed. No other GPU mixing is allowed.
- If you order a K80 GPU, note the following:
 - You cannot mix the K80 with any other GPU
 - You must select 2 CPUs for the server
 - You must select two 1400 W power supplies (see [ORDER GPU CARDS\(OPTIONAL\)](#), [page 44](#))
- Slot 5 on riser card 2 is the required slot for the first GPU.
- Slot 2 on riser card 1 is the secondary slot for a second GPU. The riser card 1 options that are compatible with GPUs are:
 - Riser card 1 option A (UCSC-PCI-1A-240M4)



NOTE: UCSM managed servers are discoverable only if a VIC 1225 is installed in slot 2 or a VIC 1227/1227T is installed in the MLOM slot. If you install two GPUs, they must be located in slots 2 and 5. Therefore, if two GPUs are installed, UCSM managed servers are discoverable only if you install a VIC 1227/1227T in the MLOM slot.



NOTE: For more information on the riser 1 card options, see [Riser Card Configuration and Options, page 79](#).

- If you order one or two boot drives, you can order a maximum of one GPU and it must be installed in Riser 2 (UCSC-PCI-2-C240M4) slot 5.
-



NOTE: See [Figure 7 on page 68](#) for the location of the 8-pin GPU power connector on the motherboard. Connect cable(s) as appropriate from this connector to the power connector on the GPU(s).



NOTE: See [Figure 7 on page 68](#) for the location of the 8-pin GPU power connector on the motherboard. Connect cable(s) as appropriate from this connector to the power connector on the GPU(s).

STEP 10 ORDER POWER SUPPLY

The C240 M4 server requires at least one power supply. A lightly loaded server may require one or two 650 W power supplies. A fully loaded server might need to be powered with two larger capacity power supplies. A server with one GPU requires at least two power supplies (1400 W power supplies are recommended). A server with two GPUs also requires at least two power supplies (1400 W power supplies are recommended). Use the power calculator at the following link to determine the needed power based on the options chosen (CPUs, drives, memory, and so on):

<http://ucspowercalc.cisco.com>

Table 21 Power Supply

Product ID (PID)	PID Description
UCSC-PSU2V2-1400W	1400 W V2 AC Power Supply (200 - 240V) 2U & 4U C Series
UCSC-PSU2V2-1200W ¹	1200 W / 800W V2 AC Power Supply for 2U C-Series Servers
UCSC-PSU-930WDC	930 W -48V DC Common Slot Power Supply for C-series servers
UCSC-PSU2V2-930DC	930 W - 48V V2 DC Power Supply for 2U C-Series Servers
UCSC-PSU2V2-650W	650W V2 AC Power Supply for C-Series Servers

Notes . . .

1. The power output is 1200W with a 200-240V input and 800W with a 100-120V input.



NOTE: In a two power supply server, both power supplies must be identical.

STEP 11 SELECT AC POWER CORD(S)

Using [Table 22](#), select the appropriate AC power cords. You can select a minimum of no power cords and a maximum of two. If you select the option R2XX-DMYMPWRCORD, no power cord is shipped with the server.

Table 22 Available Power Cords

Product ID (PID)	PID Description	Images
R2XX-DMYMPWRCORD	No power cord (dummy PID to allow for a no power cord option)	Not applicable
CAB-N5K6A-NA	Power Cord, 200/240V 6A, North America	
CAB-AC-L620-C13	AC Power Cord, NEMA L6-20 - C13, 2M/6.5ft	
CAB-C13-CBN	CABASY,WIRE,JUMPER CORD, 27" L, C13/C14, 10A/250V	
CAB-C13-C14-2M	CABASY,WIRE,JUMPER CORD, PWR, 2 Meter, C13/C14,10A/250V	
CAB-C13-C14-AC	CORD,PWR,JMP,IEC60320/C14,IEC60320/C13, 3.0M	

Table 22 Available Power Cords

Product ID (PID)	PID Description	Images
CAB-250V-10A-AR	Power Cord, 250V, 10A, Argentina	
CAB-9K10A-AU	Power Cord, 250VAC 10A 3112 Plug, Australia	
CAB-250V-10A-CN	Power Cord, SFS, 250V, 10A, China	
CAB-250V-10A-CN	AC Power Cord - 250V, 10A - PRC	
CAB-9K10A-EU	Power Cord, 250VAC 10A CEE 7/7 Plug, EU	
CAB-250V-10A-ID	Power Cord, SFS, 250V, 10A, India	
CAB-250V-10A-IS	Power Cord, SFS, 250V, 10A, Israel	

Table 22 Available Power Cords

Product ID (PID)	PID Description	Images
CAB-9K10A-IT	Power Cord, 250VAC 10A CEI 23-16/VII Plug, Italy	 <p>Plug: I/3G (CEI 23-16) Cordset rating: 10 A, 250 V Length: 8 ft 2 in (2.5 m) Connector: C15M (EN60320/C15)</p>
CAB-9K10A-SW	Power Cord, 250VAC 10A MP232 Plug, Switzerland	 <p>Plug: MP232-R Cordset rating: 10 A, 250 V Length: 8 ft 2 in (2.5 m) Connector: IEC 60320 C15</p>
CAB-9K10A-UK	Power Cord, 250VAC 10A BS1363 Plug (13 A fuse), UK	 <p>Cordset rating: 10 A, 250 V/500 V MAX Length: 2500mm Plug: EL 210 (BS 1363A) 13 AMP fuse Connector: EL 701 C (EN 60320/C15)</p>
CAB-9K12A-NA	Power Cord, 125VAC 13A NEMA 5-15 Plug, North America	 <p>Cordset rating: 13A, 125V (8.2 Nm) (2.5m) Plug: NEMA 5-15P Connector: IEC60320/C15</p>
CAB-250V-10A-BR	Power Cord - 250V, 10A - Brazil	
CAB-48DC-40A-8AWG	C-Series -48VDC PSU Power Cord, 3.5M, 3 Wire, 8AWG, 40A	Image not available
CAB-C19-C20-3M-JP	Power Cord C19-C20, 3M/10ft Japan PSE mark	Image not available

STEP 12 ORDER TOOL-LESS RAIL KIT AND OPTIONAL REVERSIBLE CABLE MANAGEMENT ARM

Select a Tool-Less Rail Kit

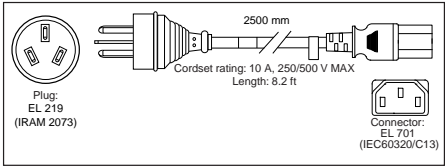
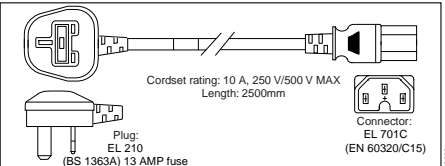
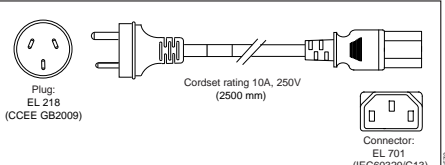
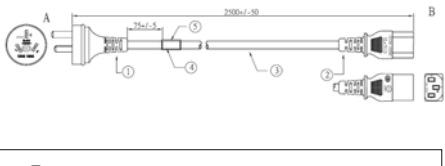
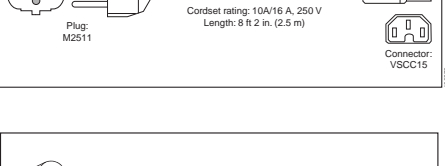
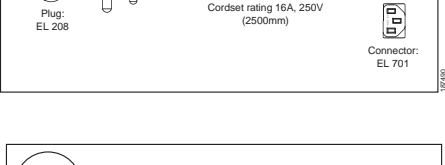
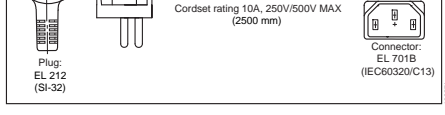
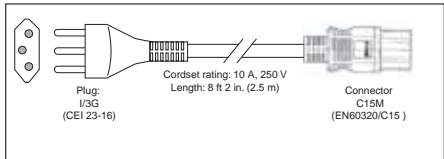
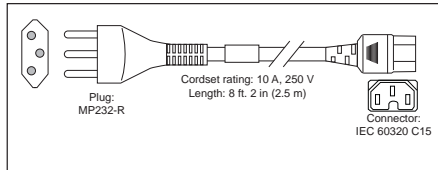
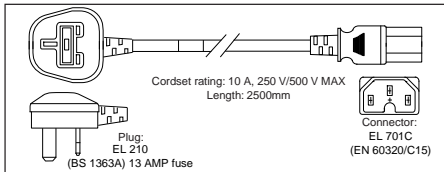
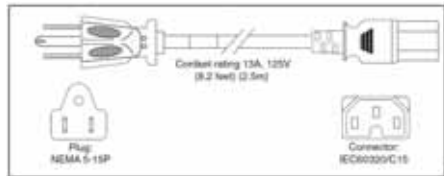
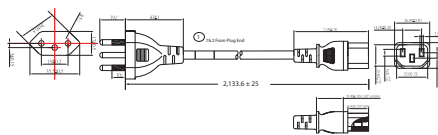
Select a tool-less rail kit from [Table 23](#).

Table 23 Tool-Less Rail Kit Options

Product ID (PID)	PID Description
UCSC-RAILB-M4	Ball Bearing Rail Kit for C220 M4 and C240 M4 Rack Servers

Select an Optional Reversible Cable Management Arm

The reversible cable management arm mounts on either the right or left slide rails at the rear of the server and is used for cable management. Use [Table 24](#) to order a cable management arm.

Table 24 Cable Management Arm

Product ID (PID)	PID Description
UCSC-CMA-M4	Reversible CMA for C240 M4 tool-less ball bearing rail kit

For more information about the tool-less rail kit and cable management arm, see the *Cisco UCS C240 M4 Installation and Service Guide* at this URL:

http://www.cisco.com/c/en/us/td/docs/unified_computing/ucs/c/hw/C240M4/install/C240M4.html



NOTE: If you plan to rackmount your UCS C240 M4 server, you must order a tool-less rail kit.

STEP 13 SELECT NIC MODE (OPTIONAL)

By default, the C240 M4 server NIC mode is configured to be Shared LOM Extended. This NIC mode allows any LOM port or adapter card port to be used to access the Cisco Integrated Management Controller (CIMC). The Cisco VIC card must be installed in a slot with NCSI support.

To change the default NIC mode to Dedicated, select the UCSC-DLOM-01 PID shown in [Table 25](#). In Dedicated NIC mode, the CIMC can be accessed only through the dedicated management port. See [Chassis Rear View, page 7](#) for the location of the management port.

To change the default NIC mode to Cisco Card Mode, select the UCSC-CCARD-01 PID shown in [Table 25](#). In this mode, you can assign an IP address to the CIMC using DHCP and from there you can fully automate your deployment.

For more details on all the NIC mode settings, see

http://www.cisco.com/c/en/us/td/docs/unified_computing/ucs/c/sw/gui/config/guide/2-0/b_Cisco_UCS_C-series_GUI_Configuration_Guide_201.pdf

Table 25 Dedicated NIC Mode Ordering Information

Product ID (PID)	PID Description
UCSC-DLOM-01	Dedicated Mode BIOS setting for C-Series Servers
UCSC-CCARD-01	Cisco Card Mode BIOS setting for C-Series Servers

STEP 14 ORDER A TRUSTED PLATFORM MODULE (OPTIONAL)

Trusted Platform Module (TPM) is a computer chip (microcontroller) that can securely store artifacts used to authenticate the platform (server). These artifacts can include passwords, certificates, or encryption keys. A TPM can also be used to store platform measurements that help ensure that the platform remains trustworthy. Authentication (ensuring that the platform can prove that it is what it claims to be) and attestation (a process helping to prove that a platform is trustworthy and has not been breached) are necessary steps to ensure safer computing in all environments.

The TPM ordering information is listed in [Table 26](#).

Table 26 Trusted Platform Module

Product ID (PID)	PID Description
UCSX-TPM2-001	Trusted Platform Module 1.2 SPI-based for UCS Servers
UCSX-TPM2-002	Trusted Platform Module 2.0 for UCS servers



NOTE: The module used in this system conforms to TPM v1.2 and 2.0, as defined by the Trusted Computing Group (TCG). It is also SPI-based.



NOTE: TPM installation is supported after-factory. However, a TPM installs with a one-way screw and cannot be replaced, upgraded, or moved to another server. If a server with a TPM is returned, the replacement server must be ordered with a new TPM. If there is no existing TPM in the server, you can install TPM 2.0. You must first upgrade to UCS firmware that supports Intel E5-2600 v4 CPUs, which is Cisco UCS Manager Release 2.2(7) and later or Release 3.1(1) and later (because Cisco aligned support for TPM 2.0 with these CPUs).



CAUTION: If the Cisco UCS server (with Intel E5-2600 v4 or v3 CPUs) is running UCS firmware that added support for Intel E5-2600 v4 CPUs, then it will work with TPM version 2.0. However, if you downgrade the firmware and BIOS to a version earlier than Release 2.2(7) or earlier than Release 3.1(1), then you are vulnerable to a potential security exposure. See the following support matrix for TPM versions.

Table 27 TPM Support Matrix by Intel CPU Version

Intel CPU	TPM Version	Minimum UCS Manager (UCSM) Version
Intel E5-2600 v3	TPM 1.2	Release 2.2(3)
	TPM 2.0	Release 2.2(7) or Release 3.1(1)
Intel E5-2600 v4	TPM 1.2	Release 2.2(7) or Release 3.1(1)
	TPM 2.0	Release 2.2(7) or Release 3.1(1)

STEP 15 ORDER CISCO FLEXIBLE FLASH SD CARD MODULE (OPTIONAL)

Order 64 GB SD cards or 32 GB SD cards. See [Figure 7 on page 68](#) for the location of the SD cards. There are two locations, SD1 and SD2.

Table 28 64 GB Secure Digital (SD) Card (blank)

Product ID (PID)	PID Description
UCS-SD-64G-S	64 GB SD Card for UCS Servers

Table 29 32 GB Secure Digital (SD) Card (blank)

Product ID (PID)	PID Description
UCS-SD-32G-S	32 GB SD Card for UCS Servers

Caveats

- Install either one or two 64 GB SD cards or one or two 32 GB SD cards
- Do not mix SD card sizes

STEP 16 ORDER OPTIONAL USB 3.0 DRIVE

You can order one optional USB 3.0 drive. The USB drive ordering information is listed in [Table 30](#).

Table 30 USB 3.0 Drive

Product ID (PID)	PID Description
UCS-USBFLSHB-16GB	UCS Servers 16 GB Flash USB Drive

See [Figure 7 on page 68](#) for the location of the USB connector

STEP 17 SELECT OPERATING SYSTEM AND VALUE-ADDED SOFTWARE

Several software programs are available. Select as desired from [Table 31](#).

Table 31 Software (for 2-CPU servers)

PID Description	Product ID (PID)
Cisco One	
C1F2PUCSK9	Cisco ONE Foundation Perpetual UCS
C1A1PUCSK9	Cisco ONE Enterprise Cloud Perpetual UCS
C1UCS-OPT-OUT	Cisco One Data Center Compute Opt Out Option
Energy Management (JouleX)	
CEM-DC-PER	Perpetual License Key for Cisco Energy Management for DC
UCS Director	
CUIC-PHY-SERV-BM-U	Cisco UCS Director Resource Lic - 1 Phy Sevr node bare metal
CUIC-PHY-SERV-U	Cisco UCS Director Resource Lic - One physical Server node
CUIC-TERM	Acceptance of Cisco UCS Director License Terms
UCS Performance Manager	
UCS-PM-IE	UCS Performance Manager
UCS-PM-EE	UCS Performance Manager Express
EVAL-UCS-PM-IE	UCS Performance Manager - 90 days evaluation
EVAL-UCS-PM-EE	UCS Performance Manager Express - 90 days evaluation
Nexus 1000V for Hyper-V and vSphere	
N1K-VSG-UCS-BUN	Nexus 1000V Adv Edition for vSphere Paper License Qty 1
IMC Supervisor	
CIMC-SUP-B10	IMC Supervisor- Branch Mgt SW for C & E-Series up to 1K Svrs
CIMC-SUP-B02	IMC Supervisor- Branch Mgt SW for C & E-Series up to 250 Svrs
UCS Multi-Domain Manager	
UCS-MDMGR-100S	UCS Multi-Domain Manager (Central) Per Server License (100+)
UCS-MDMGR-50S	UCS Multi-Domain Manager (Central) Per Server License (50+)
UCS-MDMGR-1S	UCS Multi-Domain Manager (Central) Per Server License
UCS-MDMGR-10S	UCS Multi-Domain Manager (Central) Per Server License (10+)
UCS-MDMGR-1DMN	UCS Multi-Domain Manager (Central) Per Domain License
VMware vCenter	
VMW-VCS-STD-1A	VMware vCenter 6 Server Standard, 1 yr support required
VMW-VCS-STD-3A	VMware vCenter 6 Server Standard, 3 yr support required
VMW-VCS-STD-5A	VMware vCenter 6 Server Standard, 5 yr support required
VMW-VCS-FND-1A	VMware vCenter 6 Server Foundation (3 Host), 1 yr supp reqd
VMW-VCS-FND-3A	VMware vCenter 6 Server Foundation (3 Host), 3 yr supp reqd
VMW-VCS-FND-5A	VMware vCenter 6 Server Foundation (3 Host), 5 yr supp reqd
Microsoft Windows Server	
MSWS-12R2-DC2S	Windows Server 2012 R2 Datacenter (2 CPU/Unlimited VMs)

Table 31 Software (for 2-CPU servers) (continued)

PID Description	Product ID (PID)
MSWS-12-ST2S	Windows Server 2012 Standard (2 CPU/2 VMs)
MSWS-12-DC2S	Windows Server 2012 Datacenter (2 CPU/Unlimited VMs)
MSWS-12-ST2S-NS	Windows Server 2012 Standard (2 CPU/2 VMs) No Cisco SVC
MSWS-12R2-DC2S-NS	Windows Server 2012 R2 Datacen (2 CPU/Unlim VM) No Cisco Svc
MSWS-12R2-ST2S	Windows Server 2012 R2 Standard (2 CPU/2 VMs)
MSWS-12-DC2S-NS	Windows Server 2012 Datacenter (2 CPU/Unlim VM) No Cisco Svc
MSWS-12R2-ST2S-NS	Windows Server 2012 R2 Standard (2 CPU/2 VMs) No Cisco SVC
Red Hat	
RHEL-2S2V-3A	Red Hat Enterprise Linux (1-2 CPU,1-2 VN); 3-Yr Support Req
RHEL-2S2V-1A	Red Hat Enterprise Linux (1-2 CPU,1-2 VN); 1-Yr Support Req
VMware	
VMW-VSP-EPL-5A	VMware vSphere 6 Ent Plus (1 CPU), 5-yr, Support Required
VMW-VSP-STD-1A	VMware vSphere 6 Standard (1 CPU), 1-yr, Support Required
VMW-VSP-STD-3A	VMware vSphere 6 Standard (1 CPU), 3-yr, Support Required
VMW-VSP-EPL-3A	VMware vSphere 6 Ent Plus (1 CPU), 3-yr, Support Required
VMW-VSP-EPL-1A	VMware vSphere 6 Ent Plus (1 CPU), 1-yr, Support Required
VMW-VSP-STD-5A	VMware vSphere 6 Standard (1 CPU), 5-yr, Support Required
SLES SAP	
SLES-SAP-2S2V-1S	SLES for SAP Apps (1-2 CPU, 1-2 VM); Priority 1-Yr SnS
SLES-SAP-2SUV-1S	SLES for SAP Apps (1-2 CPU, Unl VM); Priority 1-Yr SnS
SLES-SAP-2S2V-3S	SLES for SAP Apps (1-2 CPU, 1-2 VM); Priority 3-Yr SnS
SLES-SAP-2SUV-3S	SLES for SAP Apps (1-2 CPU, Unl VM); Priority 3-Yr SnS
SLES-SAP-2S2V-5S	SLES for SAP Apps (1-2 CPU, 1-2 VM); Priority 5-Yr SnS
SLES-SAP-2SUV-5S	SLES for SAP Apps (1-2 CPU, Unl VM); Priority 5-Yr SnS
SLES-SAP-2S2V-5A	SLES for SAP Apps (1-2 CPU, 1-2 VM); 5-Yr Support Reqd
SLES-SAP-2SUV-3A	SLES for SAP Apps (1-2 CPU, Unl VM); 3-Yr Support Reqd
SLES-SAP-2S2V-3A	SLES for SAP Apps (1-2 CPU, 1-2 VM); 3-Yr Support Reqd
SLES-SAP-2SUV-5A	SLES for SAP Apps (1-2 CPU, Unl VM); 5-Yr Support Reqd
SLES-SAP-2S2V-1A	SLES for SAP Apps (1-2 CPU, 1-2 VM); 1-Yr Support Reqd
SLES-SAP-2SUV-1A	SLES for SAP Apps (1-2 CPU, Unl VM); 1-Yr Support Reqd
SUSE	
SLES-2S2V-1A	SUSE Linux Enterprise Svr (1-2 CPU,1-2 VM); 1-Yr Support Req
SLES-2SUV-1A	SUSE Linux Enterprise Svr (1-2 CPU,Unl VM); 1-Yr Support Req
SLES-2S2V-3A	SUSE Linux Enterprise Svr (1-2 CPU,1-2 VM); 3-Yr Support Req
SLES-2SUV-3A	SUSE Linux Enterprise Svr (1-2 CPU,Unl VM); 3-Yr Support Req
SLES-2S2V-5A	SUSE Linux Enterprise Svr (1-2 CPU,1-2 VM); 5-Yr Support Req
SLES-2SUV-5A	SUSE Linux Enterprise Svr (1-2 CPU,Unl VM); 5-Yr Support Req
SLES-2S2V-1S	SUSE Linux Enterprise Svr (1-2 CPU,1-2 VM); Prio 1-Yr SnS

Table 31 Software (for 2-CPU servers) *(continued)*

PID Description	Product ID (PID)
SLES-2SUV-1S	SUSE Linux Enterprise Svr (1-2 CPU,Unl VM); Prio 1-Yr SnS
SLES-2S2V-3S	SUSE Linux Enterprise Svr (1-2 CPU,1-2 VM); Prio 3-Yr SnS
SLES-2SUV-3S	SUSE Linux Enterprise Svr (1-2 CPU,Unl VM); Prio 3-Yr SnS
SLES-2S2V-5S	SUSE Linux Enterprise Svr (1-2 CPU,1-2 VM); Prio 5-Yr SnS
SLES-2SUV-5S	SUSE Linux Enterprise Svr (1-2 CPU,Unl VM); Prio 5-Yr SnS
SLES-2S-HA-1S	SUSE Linux High Availability Ext (1-2 CPU); 1yr SnS
SLES-2S-HA-3S	SUSE Linux High Availability Ext (1-2 CPU); 3yr SnS
SLES-2S-HA-5S	SUSE Linux High Availability Ext (1-2 CPU); 5yr SnS
SLES-2S-GC-1S	SUSE Linux GEO Clustering for HA (1-2 CPU); 1yr SnS
SLES-2S-GC-3S	SUSE Linux GEO Clustering for HA (1-2 CPU); 3yr SnS
SLES-2S-GC-5S	SUSE Linux GEO Clustering for HA (1-2 CPU); 5yr SnS

STEP 18 SELECT OPERATING SYSTEM MEDIA KIT

Select the optional operating system media listed in [Table 32](#).

Table 32 OS Media

Product ID (PID)	PID Description
RHEL-6	RHEL 6 Recovery Media Only (Multilingual)
SLES-11	SLES 11 media only (multilingual)
MSWS-08R2-STHV-RM	Windows Svr 2008 R2 ST (1-4CPU, 5CAL), Media
MSWS-08R2-ENHV-RM	Windows Svr 2008 R2 EN (1-8CPU, 25CAL), Media
MSWS-08R2-DCHV-RM	Windows Svr 2008 R2 DC (1-8CPU, 25CAL), Media
MSWS-12-ST2S-RM	Windows Server 2012 Standard (2 CPU/2 VMs) Recovery Media
MSWS-12-DC2S-RM	Windows Server 2012 Datacenter(2 CPU/Unlimited VM) Rec Media
MSWS-12R2-ST2S-RM	Windows Server 2012 R2 Standard (2 CPU/2 VMs) Recovery Media
MSWS-12R2-DC2S-RM	Windows Server 2012 R2 Datacen(2 CPU/Unlimited VM) Rec Media

STEP 19 SELECT SERVICE and SUPPORT LEVEL

A variety of service options are available, as described in this section.

Unified Computing Warranty, No Contract

If you have noncritical implementations and choose to have no service contract, the following coverage is supplied:

- Three-year parts coverage.
- Next business day (NBD) onsite parts replacement eight hours a day, five days a week.
- 90-day software warranty on media.
- Ongoing downloads of BIOS, drivers, and firmware updates.
- UCSM updates for systems with Unified Computing System Manager. These updates include minor enhancements and bug fixes that are designed to maintain the compliance of UCSM with published specifications, release notes, and industry standards.

SMARTnet for UCS

For support of the entire Unified Computing System, Cisco offers the Cisco SMARTnet for UCS Service. This service provides expert software and hardware support to help sustain performance and high availability of the unified computing environment. Access to Cisco Technical Assistance Center (TAC) is provided around the clock, from anywhere in the world.

For UCS blade servers, there is Smart Call Home, which provides proactive, embedded diagnostics and real-time alerts. For systems that include Unified Computing System Manager, the support service includes downloads of UCSM upgrades. The Cisco SMARTnet for UCS Service includes flexible hardware replacement options, including replacement in as little as two hours. There is also access to Cisco's extensive online technical resources to help maintain optimal efficiency and uptime of the unified computing environment. You can choose a desired service listed in [Table 33](#).

Table 33 Cisco SMARTnet for UCS Service

Product ID (PID)	On Site?	Description
CON-PREM-C240M4LF	Yes	ONSITE 24X7X2 UCS C240 M4 Server - LFF
CON-OSP-C240M4LF	Yes	ONSITE 24X7X4 UCS C240 M4 Server - LFF
CON-OSE-C240M4LF	Yes	ONSITE 8X5X4 UCS C240 M4 Server - LFF
CON-OS-C240M4LF	Yes	ONSITE 8X5XNBD UCS C240 M4 Server - LFF
CON-S2P-C240M4LF	No	SMARTNET 24X7X2 UCS C240 M4 Server - LFF
CON-SNTP-C240M4LF	No	SMARTNET 24X7X4 UCS C240 M4 Server - LFF
CON-SNTE-C240M4LF	No	SMARTNET 8X5X4 UCS C240 M4 Server - LFF
CON-SNT-C240M4LF	No	SMARTNET 8X5XNBD UCS C240 M4 Server - LFF

SMARTnet for UCS Hardware Only Service

For faster parts replacement than is provided with the standard Cisco Unified Computing System warranty, Cisco offers the Cisco SMARTnet for UCS Hardware Only Service. You can choose from two levels of advanced onsite parts replacement coverage in as little as four hours. SMARTnet for UCS Hardware Only Service provides remote access any time to Cisco support professionals who can determine if a return materials authorization (RMA) is required. You can choose a service listed in [Table 34](#).

Table 34 SMARTnet for UCS Hardware Only Service

Product ID (PID)	Service Level GSP	On Site?	Description
CON-UCW7-C240M4LF	UCW7	Yes	UC PLUS 24X7X40S UCS C240 M4 Server - LFF
CON-UCW5-C240M4LF	UCW5	Yes	UC PLUS 8X5XNBDOS UCS C240 M4 Server - LFF

Unified Computing Partner Support Service

Cisco Partner Support Service (PSS) is a Cisco Collaborative Services service offering that is designed for partners to deliver their own branded support and managed services to enterprise customers. Cisco PSS provides partners with access to Cisco's support infrastructure and assets to help them:

- Expand their service portfolios to support the most complex network environments
- Lower delivery costs
- Deliver services that increase customer loyalty

Partner Unified Computing Support Options enable eligible Cisco partners to develop and consistently deliver high-value technical support that capitalizes on Cisco intellectual assets. This helps partners to realize higher margins and expand their practice.

PSS is available to all Cisco PSS partners, but requires additional specializations and requirements. For additional information, see the following URL:

www.cisco.com/go/partnerucssupport

The two Partner Unified Computing Support Options include:

- Partner Support Service for UCS
- Partner Support Service for UCS Hardware Only

Partner Support Service for UCS provides hardware and software support, including triage support for third party software, backed by Cisco technical resources and level three support.

See [Table 35](#).

Table 35 Partner Support Service for UCS

Product ID (PID)	Service Level GSP	On Site?	Description
CON-PSJ1-C240M4LF	PSJ1	No	UCS SUPP PSS 8X5XNBD UCS C240 M4 Server - LFF
CON-PSJ2-C240M4LF	PSJ2	No	UCS SUPP PSS 8X5X4 UCS C240 M4 Server - LFF
CON-PSJ3-C240M4LF	PSJ3	No	UCS SUPP PSS 24X7X4 UCS C240 M4 Server - LFF
CON-PSJ4-C240M4LF	PSJ4	No	UCS SUPP PSS 24X7X2 UCS C240 M4 Server - LFF

Partner Support Service for UCS Hardware Only provides customers with replacement parts in as little as two hours. See [Table 36](#).

Table 36 Partner Support Service for UCS (Hardware Only)

Product ID (PID)	Service Level GSP	On Site?	Description
CON-PSW2-C240M4LF	PSW2	No	UCS W PL PSS 8X5X4 UCS C240 M4 Server - LFF
CON-PSW3-C240M4LF	PSW3	No	UCS W PL PSS 24X7X4 UCS C240 M4 Server - LFF
CON-PSW4-C240M4LF	PSW4	No	UCS W PL PSS 24X7X2 UCS C240 M4 Server - LFF

Unified Computing Combined Support Service

Combined Services makes it easier to purchase and manage required services under one contract. SMARTnet services for UCS help increase the availability of your vital data center infrastructure and realize the most value from your unified computing investment. The more benefits you realize from the Cisco Unified Computing System (Cisco UCS), the more important the technology becomes to your business. These services allow you to:

- Optimize the uptime, performance, and efficiency of your UCS
- Protect your vital business applications by rapidly identifying and addressing issues
- Strengthen in-house expertise through knowledge transfer and mentoring
- Improve operational efficiency by allowing UCS experts to augment your internal staff resources
- Enhance business agility by diagnosing potential issues before they affect your operations

You can choose a service listed in [Table 37](#).

Table 37 UCS Computing Combined Support Service

Product ID (PID)	Service Level GSP	On Site?	Description
CON-NCF2-C240M4LF	NCF2	No	CMB SPT SVC 24X7X2 UCS C240 M4 Server - LFF
CON-NCF2P-C240M4LF	NCF2P	Yes	CMB SPT SVC 24X7X2OS UCS C240 M4 Server - LFF
CON-NCF4P-C240M4LF	NCF4P	Yes	CMB SPT SVC 24X7X4OS UCS C240 M4 Server - LFF
CON-NCF4S-C240M4LF	NCF4S	Yes	CMB SPT SVC 8X5X4OS UCS C240 M4 Server - LFF
CON-NCFCS-C240M4LF	NCFCS	Yes	CMB SPT SVC 8X5XNBDOS UCS C240 M4 Server - LFF
CON-NCFE-C240M4LF	NCFE	No	CMB SPT SVC 8X5X4 UCS C240 M4 Server - LFF
CON-NCFP-C240M4LF	NCFP	No	CMB SPT SVC 24X7X4 UCS C240 M4 Server - LFF
CON-NCFT-C240M4LF	NCFT	No	CMB SPT SVC 8X5XNBD UCS C240 M4 Server - LFF

Unified Computing Drive Retention Service

With the Cisco Unified Computing Drive Retention (UCDR) Service, you can obtain a new disk drive in exchange for a faulty drive without returning the faulty drive. In exchange for a Cisco replacement drive, you provide a signed Certificate of Destruction (CoD) confirming that the drive has been removed from the system listed, is no longer in service, and has been destroyed.

Sophisticated data recovery techniques have made classified, proprietary, and confidential information vulnerable, even on malfunctioning disk drives. The UCDR service enables you to retain your drives and ensures that the sensitive data on those drives is not compromised, which reduces the risk of any potential liabilities. This service also enables you to comply with regulatory, local, and federal requirements.

If your company has a need to control confidential, classified, sensitive, or proprietary data, you might want to consider one of the Drive Retention Services listed in [Table 38](#).



NOTE: Cisco does not offer a certified drive destruction service as part of this service.

Table 38 Drive Retention Service Options

Service Description	Service Program Name	Service Level GSP	Service Level	Product ID (PID)
SMARTnet for UCS Service with Drive Retention	UCS DR	UCSD7	24x7x4 Onsite	CON-UCSD7-C240M4LF
		UCSD5	8x5xNBD Onsite	CON-UCSD5-C240M4LF
SMARTnet for UCS HW ONLY+Drive Retention	UCS HW+DR	UCWD7	24x7x4 Onsite	CON-UCWD7-C240M4LF
		UCWD5	8x5xNBD Onsite	CON-UCWD5-C240M4LF

For more service and support information, see the following URL:

http://www.cisco.com/en/US/services/ps2961/ps10312/Unified_Computing_Services_Overview.pdf

For a complete listing of available services for Cisco Unified Computing System, see this URL:

http://www.cisco.com/en/US/products/ps10312/serv_group_home.html

OPTIONAL STEP - ORDER RACK(S)

The optional R42610 rack is available from Cisco for the C-Series servers, including the C240 M4 LFF server. This rack is a standard 19-inch rack and can be ordered with a variety of options, as listed in [Table 39](#). Racks are shipped separately from the C240 M4 LFF server.

Table 39 Racks and Rack Options

Product ID (PID)	PID Description
RACK-UCS ¹	Cisco R42610 expansion rack, no side panels
RACK-UCS2 ¹	Cisco R42610 standard rack, w/side panels
RACK-BLANK-001	Filler panels (qty 12), 1U, plastic, toolless
RACK-CBLMGT-001	Cable mgt D rings (qty 10), metal
RACK-CBLMGT-011	Cable mgt straps (qty 10), Velcro
RACK-FASTEN-001	Mounting screws (qty 100), M6
RACK-FASTEN-002	Cage nuts (qty 50), M6
RACK-JOIN-001	Rack joining kit

Notes . . .

1. Use these same base PIDs to order spare racks (available only as next-day replacements).

For more information about the R42610 rack, see [RACKS, page 85](#).

OPTIONAL STEP - ORDER PDU

An optional power distribution unit (PDU) is available from Cisco for the C-Series rack servers, including the C240 M4 server. This PDU is available in a zero rack unit (RU) style (see [Table 39](#)).

Table 40 PDU Options

Product ID (PID)	PID Description
RP208-30-2P-U-2	Zero RU PDU

For more information about the PDU, see [PDUs, page 87](#).

SUPPLEMENTAL MATERIAL

CHASSIS

An internal view of the C240 M4 chassis with the top cover removed is shown in *Figure 7*.

Figure 7 C240 M4 LFF With Top Cover Off

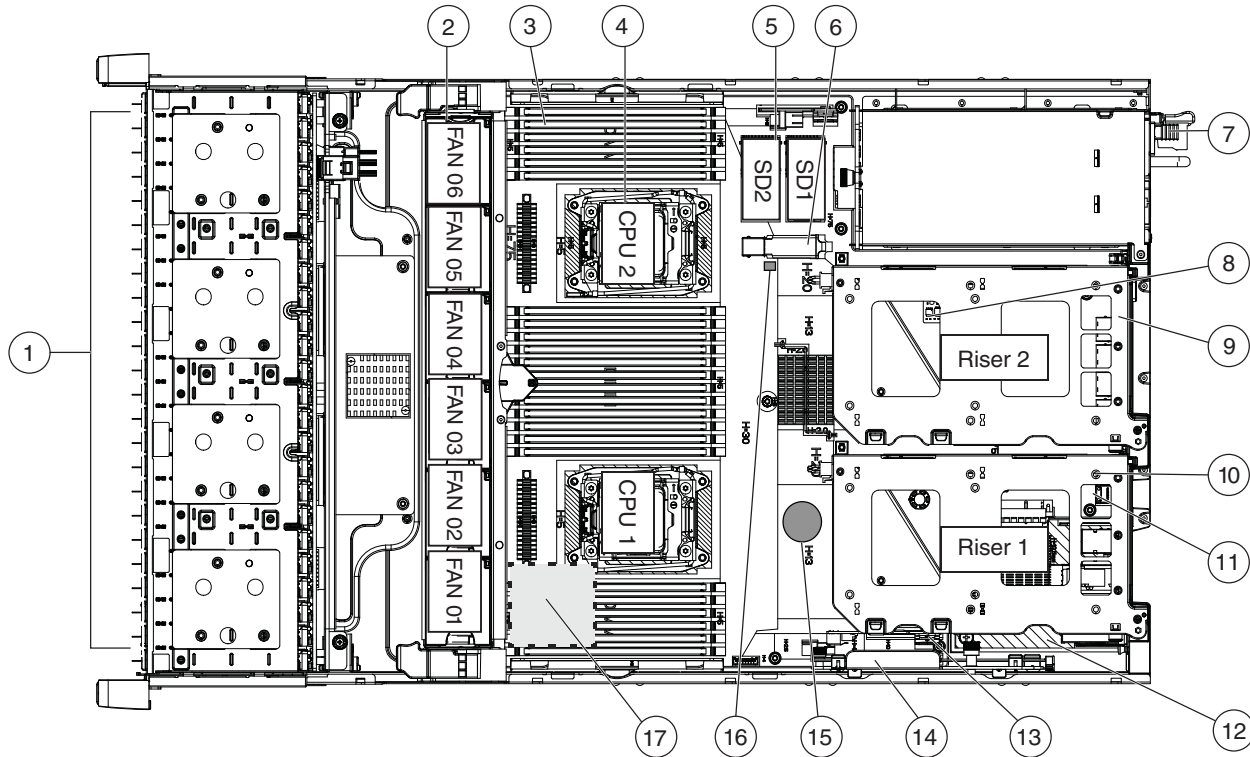

352948

1	Drives (hot-swappable, accessed through front panel)	10	PCIe riser 1 (PCIe slots 1, 2, 3*) *Slot 3 not present in all versions. See Riser Card Configuration and Options, page 79 for riser options and slot specifications.
2	Fan modules (six, hot-swappable)	11	SATA boot drives (two sockets available only on PCIe riser 1 option C)
3	DIMM sockets on motherboard (up to 24 DIMMs)	12	mLOM card socket on motherboard under PCIe riser 1
4	CPUs and heatsinks (two)	13	Socket for embedded RAID interposer board (not used in this server)
5	Cisco SD card slots on motherboard (two)	14	Cisco modular RAID controller PCIe slot (dedicated slot and bracket)

6	USB 3.0 slot on motherboard	15	RTC battery on motherboard
7	Power supplies (hot-swappable, accessed through rear panel)	16	Embedded RAID header for RAID key (not used in this server)
8	Trusted platform module (TPM) socket on motherboard, under PCIe riser 2	17	SuperCap power module (RAID backup) mounting location on air baffle (not shown)
9	PCIe riser 2 (PCIe slots 4, 5, 6)		

CPUs and DIMMs

Physical Layout

Each CPU has four DIMM channels:

- CPU1 has channels A, B, C, and D
- CPU2 has channels E, F, G, and H

Each DIMM channel has three slots: slot 1, slot 2, and slot 3. The blue-colored DIMM slots are for slot 1, the black-colored slots for slot 2, and the white slots for slot 3.

As an example, DIMM slots A1, B1, C1, and D1 belong to slot 1, while A2, B2, C2, and D2 belong to slot 2.

Figure 9 shows how slots and channels are physically laid out on the motherboard. The DIMM slots on the right half of the motherboard (channels A, B, C, and D) are associated with CPU 1, while the DIMM slots on the left half of the motherboard (channels E, F, G, and H) are associated with CPU 2. The slot 1 (blue) DIMM slots are always located farther away from a CPU than the corresponding slot 2 (black) and slot 3 (white) slots. Slot 1 slots (blue) are populated before slot 2 slots (black) and slot 3 (white) slots.

Figure 9 Physical Layout of CPU DIMM Channels and Slots



Memory Population Rules

When considering the memory configuration of your server, consider the following items:

- Each channel has three DIMM slots (for example, channel A = slots A1, A2, and A3).
 - A channel can operate with one, two, or three DIMMs installed.
 - If a channel has only one DIMM, populate slot 1 first (the blue slot).
- When both CPUs are installed, populate the DIMM slots of each CPU identically.
 - Fill blue slots in the channels first: A1, E1, B1, F1, C1, G1, D1, H1
 - Fill black slots in the channels second: A2, E2, B2, F2, C2, G2, D2, H2
 - Fill white slots in the channels third: A3, E3, B3, F3, C3, G3, D3, H3
- Any DIMM installed in a DIMM socket for which the CPU is absent is not recognized.
- Observe the DIMM mixing rules shown in [Table 41](#)

Table 41 DIMM Rules for C240 M4 Servers

DIMM Parameter	DIMMs in the Same Channel	DIMM in the Same Slot ¹
<u>DIMM Capacity</u>		
RDIMM = 8, 16, or 32 GB LRDIMM = 32 or 64 GB TSV-RDIMM = 64 GB	DIMMs in the same channel (for example, A1, A2, and A3) can have different capacities. Do not mix TSV-RDIMMS with LRDIMMs nor RDIMMs	For best performance, DIMMs in the same slot (for example, A1, B1, C1, D1) should have the same capacity. Do not mix TSV-RDIMMS with LRDIMMs nor RDIMMs
<u>DIMM Speed</u>		
2400-MHz 2133-MHz	DIMMs will run at the lowest speed of the CPU installed	DIMMs will run at the lowest speed of the CPU installed
<u>DIMM Type</u>		
TSV-RDIMMS, RDIMMs, or LRDIMMs	Do not mix DIMM types in a channel	Do not mix DIMM types in a slot
1 DPC, 2 DPC, or 3 DPC		
DIMMs per Channel (DPC)	See Table 7 on page 22 for valid LRDIMM and RDIMM 1 DPC, 2 DPC, and 3 DPC memory configurations	

Notes . . .

1. Although different DIMM capacities can exist in the same slot, this will result in less than optimal performance. For optimal performance, all DIMMs in the same slot should be identical.

DIMM Population Order

Populate the DIMMs for a CPU according to [Table 42](#).

Table 42 DIMM Population Order per CPU

DIMMs per CPU	Populate CPU 1 Slots	Populate CPU 2 Slots
1	A1	E1
2	A1, B1	E1, F1
3	A1, B1, C1	E1, F1, G1
4	A1, B1, C1, D1	E1, F1, G1, H1
8	A1, B1, C1, D1, A2, B2, C2, D2	E1, F1, G1, H1, E2, F2, G2, H2
12	A1, B1, C1, D1, A2, B2, C2, D2 A3, B3, C3, D3	E1, F1, G1, H1, E2, F2, G2, H2 E3, F3, G3, H3

Recommended Memory Configuration

This section explains the recommended DIMM population order rules for the C240 M4 server.

- All DIMMs must be DDR4 DIMMs.
- Do not mix:
 - DIMMs with different clock rates in a channel
 - RDIMMs and LRDIMMs
- There are blue, black, and white DIMM slots. Populate blue slots first.
- When DIMMs ranks are mixed in the same channel, always populate the highest rank DIMM in the blue DIMM slot and lower rank DIMM(s) in the black and white DIMM slots.

Many memory configurations are possible. For best results, follow [Table 43](#) when populating 2133-MHz DIMMs for Intel Xeon E5-2600 v3 CPUs and [Table 44](#) when populating 2400-MHz DIMMs for Intel Xeon E5-2600 v4 CPUs.



NOTE: These tables list only some recommended and suggested configurations. There are numerous other possible configurations supported by Cisco. Cisco supports all mixing and population configurations of the Cisco DIMMs as long as the mixing does not violate the few fundamental rules noted in this document.

Table 43 Recommended Memory Configurations for Intel Xeon E5-2600 v3 CPUs (with 2133-MHz DIMMs)¹

Total System Memory Size	CPU 1 DIMMs			CPU 2 DIMMs			DIMM Max Speed (MHz)	Total DIMMs
	Blue Slots Slot 1 (A1,B1, C1,D1)	Black Slots Slot 2 (A2,B2, C2,D2)	White Slots Slot 3 (A3,B3, C3,D3)	Blue Slots Slot 1 (E1,F1, G1,H1)	Black Slots Slot 2 (E2,F2, G2,H2)	White Slots Slot 3 (E3,F3, G3,H3)		
64 GB	4x8 GB	–	–	4x8 GB	–	–	2133	8
128 GB	4x8 GB	4x8 GB	–	4x8 GB	4x8 GB	–	2133	16
	4x16 GB	–	–	4x16 GB	–	–	2133	8
192 GB	4x8 GB	4x8 GB	4x8 GB	4x8 GB	4x8 GB	4x8 GB	1600	24
	4x16 GB	4x8 GB	–	4x16 GB	4x8 GB	–	2133	16
256 GB	4x16 GB	4x16 GB	–	4x16 GB	4x16 GB	–	2133	16
	4x32 GB	–	–	4x32 GB	–	–	2133	8
384 GB	4x16 GB	4x16 GB	4x16 GB	4x16 GB	4x16 GB	4x16 GB	1866	24
512 GB	4x32 GB	4x32 GB	–	4x32 GB	4x32 GB	–	2133	16
	4x64 GB	–	–	4x64 GB	–	–	2133	8
768 GB	4x32 GB	4x32 GB	4x32 GB	4x32 GB	4x32 GB	4x32 GB	1866	24
1024 GB	4x64 GB	4x64 GB	–	4x64 GB	4x64 GB	–	2133	16
1536 GB	4x64 GB	4x64 GB	4x64 GB	4x64 GB	4x64 GB	4x64 GB	1600	24

Notes . . .

1. Rows marked in yellow indicate best performance.

Table 44 Recommended Memory Configurations for Intel Xeon E5-2600 v4 CPUs (with 2400-MHz DIMMs)¹

Total System Memory Size	CPU 1 DIMMs			CPU 2 DIMMs			DIMM Max Speed (MHz)	Total DIMMs
	Blue Slots Slot 1 (A1,B1, C1,D1)	Black Slots Slot 2 (A2,B2, C2,D2)	White Slots Slot 3 (A3,B3, C3,D3)	Blue Slots Slot 1 (E1,F1, G1,H1)	Black Slots Slot 2 (E2,F2, G2,H2)	White Slots Slot 3 (E3,F3, G3,H3)		
128 GB	4x16 GB	—	—	4x16 GB	—	—	2400	8
192 GB	4x16 GB	4x8 GB	—	4x16 GB	4x8 GB	—	2400	16
256 GB	4x16 GB	4x16 GB	—	4x16 GB	4x16 GB	—	2400	16
	4x32 GB	—	—	4x32 GB	—	—	2400	8
384 GB	4x16 GB	4x16 GB	4x16 GB	4x16 GB	4x16 GB	4x16 GB	2133	24
	4x32GB	4x16GB	—	4x32GB	4x16GB	—	2400	16
512 GB	4x32 GB	4x32 GB	—	4x32 GB	4x32 GB	—	2400	16
	4x64 GB	—	—	4x64 GB	—	—	2400	8
768 GB	4x32 GB	4x32 GB	4x32 GB	4x32 GB	4x32 GB	4x32 GB	2133	24
1024 GB	4x64 GB	4x64 GB	—	4x64 GB	4x64 GB	—	2400	16
1536 GB	4x64 GB	4x64 GB	4x64 GB	4x64 GB	4x64 GB	4x64 GB	2133	24

Notes . . .

1. Rows marked in yellow indicate best performance.

Additional DIMM Populations

The list in [Table 45](#) is not a complete list of all supported DIMM populations, but highlights common configuration options.

Table 45 Supported DIMM Configurations

CPU 1 DIMMs	Total DIMMs for CPU 1	CPU 1 Capacity	CPU 2 DIMMs	Total DIMMs for CPU 2	CPU 2 Capacity	Total Capacity for 2 CPUs
1 x 8 GB	1	8 GB	1 x 8 GB	1	8 GB	16 GB
2 x 8 GB	2	16 GB	2 x 8 GB	2	16 GB	32 GB
1 x 16 GB	1	16 GB	1 x 16 GB	1	16 GB	32 GB
4 x 8 GB	4	32 GB	4 x 8 GB	4	32 GB	64 GB
2 x 16 GB	2	32 GB	2 x 16 GB	2	32 GB	64 GB
1 x 32 GB	1	32 GB	1 x 32 GB	1	32 GB	64 GB
8 x 8 GB	8	64 GB	8 x 8 GB	8	64 GB	128 GB
4 x 16 GB	4	64 GB	4 x 16 GB	4	64 GB	128 GB
2 x 32 GB	2	64 GB	2 x 32 GB	2	64 GB	128 GB
12 x 8 GB	12	96 GB	12 x 8 GB	12	96 GB	192 GB
8 x 16 GB	8	128 GB	8 x 16 GB	8	128 GB	256 GB
4 x 32 GB	4	128 GB	4 x 32 GB	4	128 GB	256 GB
12 x 16 GB	12	192 GB	12 x 16 GB	12	192 GB	384 GB
8 x 32 GB	8	256 GB	8 x 32 GB	8	256 GB	512 GB
12 x 32 GB	12	384 GB	12 x 32 GB	12	384 GB	768 GB
12 x 64 GB	12	768 GB	12 x 64 GB	12	768 GB	1536 GB

RAID Details

The available RAID configurations are shown in this section.



NOTE: You can select either a Cisco 12G Modular RAID controller or a Cisco 12 Gbps Modular SAS HBA, but not both at the same time.

Cisco 12G SAS Modular RAID Controller (RAID Support)

- Select one of the following:
 - Cisco 12G SAS Modular RAID controller from [Table 9 on page 26](#), or
 - Cisco 9300-8E 12G SAS HBA from [Table 9 on page 26](#), or
 - One Cisco 12G SAS Modular RAID controller and one or two Cisco 9300-8E 12G SAS HBAs from [Table 9 on page 26](#).

Cisco 12 Gbps SAS HBA (JBOD Only Support)

- Select one of the following:
 - Cisco 12 Gbps Modular SAS HBA from [Table 9 on page 26](#), and/or
 - One or two Cisco 9300-8E 12G SAS HBAs from [Table 9 on page 26](#), or

RAID Option ROM (OPROM) Settings

The server contains an Option ROM (OPROM) for the PCIe slots. The server has a finite amount of option ROM with which it can boot up devices. Go into the BIOS and disable the OPROM on the PCIe slots not used for booting so that resources are available for the slots that are used for booting. An example OPROM BIOS screen is shown in *Figure 10*.

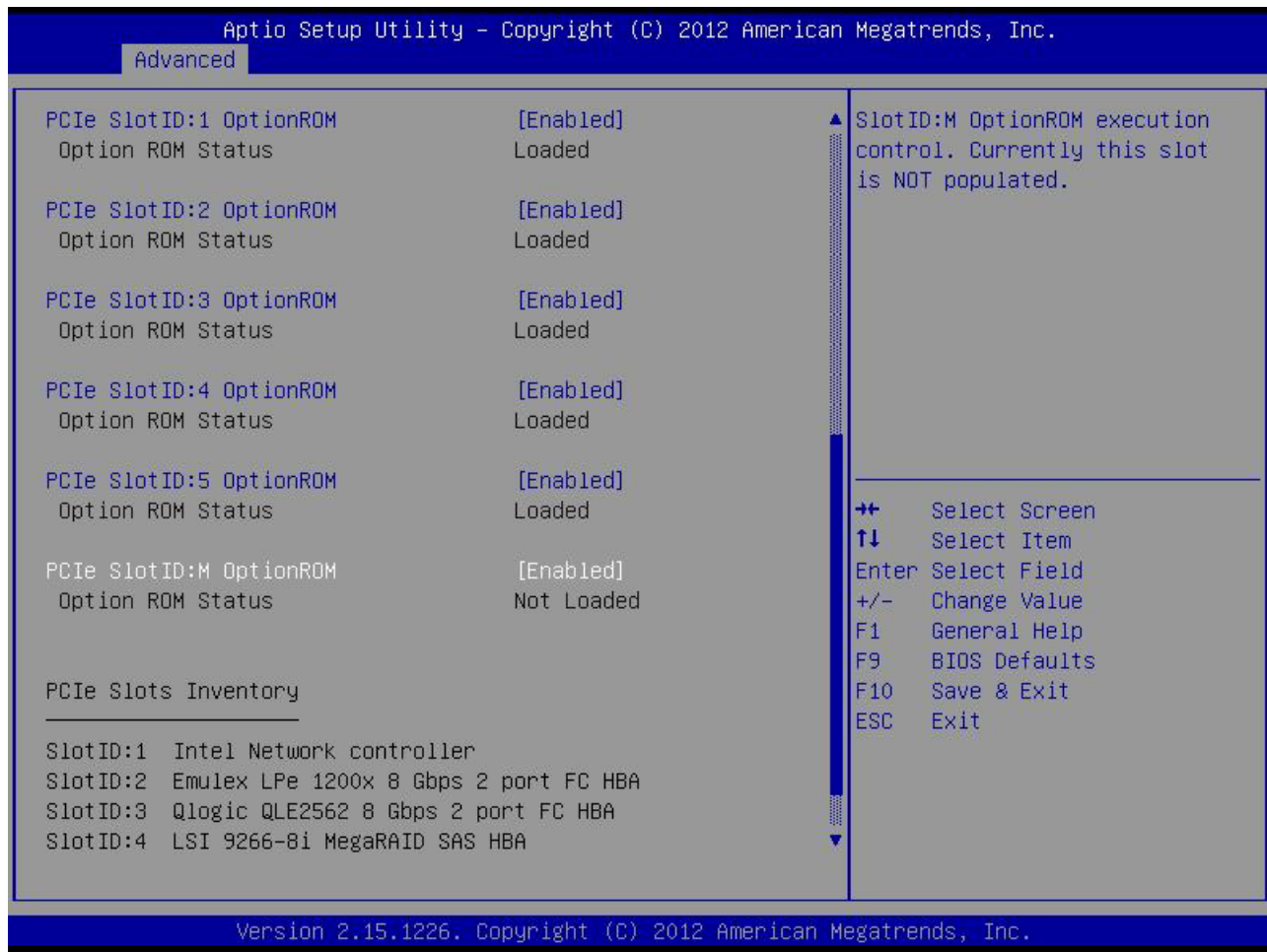
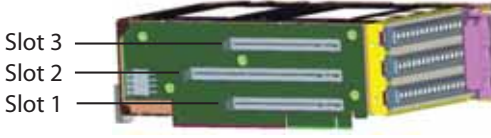

Figure 10 Example BIOS Screen for OPROM



Riser Card Configuration and Options

The three riser card 1 options are shown in [Table 46](#). The number of PCIe card slots and connectors for SATA boot drives depends on which option is selected for riser 1. The riser card 2 slot assignments are fixed and are shown in [Table 47 on page 80](#).

Table 46 Riser Card 1 Slot Options

Slot #	Height	Length	Electrical	Mechanical	NCSI	Physical
Riser Card 1 (option A, PID UCSC-PCI-1A-240M4)						
						
3	No slot available					
2	Full	Full ¹	x16	x24	Yes ²	
1	Full	3/4	x8	x24	Yes ²	
Riser Card 1 (option B, PID UCSC-PCI-1B-240M4)³						
						
3	Full	Full	x8	x16	No	
2	Full	Full	x8	x24	Yes	
1	Full	3/4	x8	x16	No	
Riser Card 1 (option C, PID UCSC-PCI-1C-240M4)						
						
3	No slot available ⁴					
2	Full	Full	x16	x24	Yes	
1	Full	3/4	x8	x24	Yes	

Notes . . .

1. GPU capable slot
2. NCSI supported in only one slot at a time (default slot 2). If a GPU card is present in slot 2, NCSI support automatically moves to slot 1.
3. No GPUs are supported on this riser. There is no GPU power connector in this version. Use riser version 1A for GPU cards.
4. There is no PCIe connector in slot 3; instead, there are two connectors available for connecting SATA boot drives.

Table 47 Riser Card 2 Slots

Slot #	Height	Length	Electrical	Mechanical	NCSI	Physical
Riser Card 2						
						
6	Full	Full	x8	x16	No	
5	Full	Full ¹	x16	x24	Yes ²	
4	Full	3/4	x8	x24	Yes ²	

Notes . . .

1. GPU capable slot
2. NCSI supported in only one slot at a time (default slot 5). If a GPU card is present in slot 5, NCSI support automatically moves to slot 4.

Serial Port Details

The pinout details of the rear RJ-45 serial port connector are shown in [Figure 11](#).

Figure 11 Serial Port (Female RJ-45 Connector) Pinout

Serial Port (RJ-45 Female Connector)

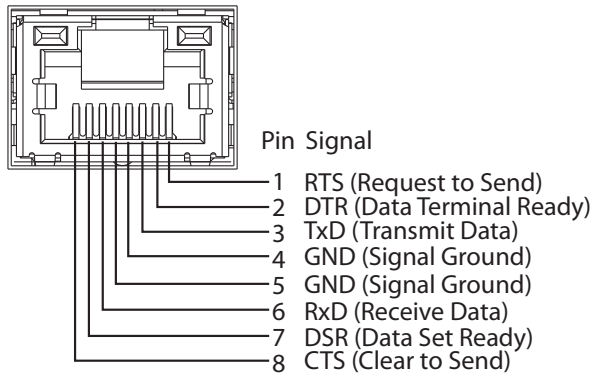

Upgrade and Servicing-Related Parts

This section lists the upgrade and servicing-related parts you may need during the life of your server. Some of these parts are configured with every server, and some may be ordered when needed or may be ordered and kept on hand as spares for future use. See [Table 48](#).

Table 48 Upgrade and Servicing-related Parts for UCS C240 M4 LFF Server

Spare Product ID (PID)	Description
UCSC-PCIF-01F=	PCIe Full Height blanking panel for UCS C-Series Server ¹
UCSC-PCIF-C240M4=	C240 M4 PCIe Riser Blanking Panel ¹
UCSC-PCI-2-C240M4=	C240 M4 PCIe Riser 2 Assembly ¹
UCSC-PCI-1A-240M4=	C240 M4 PCIe Riser 1 Assembly (x8 slot + GPU) ¹
UCSC-PCI-1B-240M4=	C240 M4 PCIe Riser 1 Assembly (3 x8 slots) ¹
UCSC-PCI-1C-240M4=	C240 M4 PCIe Riser 1 Assembly (SATA Boot + 2 PCIe slots) ¹
UCSC-IP-PCH-240M4=	Interposer board + cables for onboard PCH SATA 6G Embedded Software RAID ¹
UCSC-MLOM-BLK=	MLOM Blanking Panel
UCS-240CBLMR12=	C240 M4 set of 2 cables for 12 HDD backplane chassis ²
UCSC-HS-C240M4=	Heat Sink for UCS C240 M4 Rack Server ¹
UCS-CPU-LPCVR=	CPU load plate dust cover (for unpopulated CPU sockets)
UCS-GPUCBL-240M4=	C240 M4 GPU Power Cable (1 cable per GPU card) ¹
N20-MBLIBATT=	Replacement Lithium Battery for Server Motherboard (CR2032) ¹
UCSC-FAN-C240M4=	C240 M4 Fan Module (one)
UCSC-BAFF-C240M4=	C240 M4 Air Baffle Replacement Kit
UCSC-PSU-BLKP240=	Power Supply Blanking Panel for C240 M4 Servers ¹
UCSC-RAILB-M4=	Tool-Less Ball Bearing Rail Kit for C220 M4 and C240 M4 rack servers
UCSC-CMAB-M4	Reversible CMA for C240 M4 ball bearing rail kit
UCS-SD-32G-S=	32 GB SD Card for UCS servers ³
UCS-SD-64G-S=	64 GB SD Card for UCS servers ²
UCS-USBFLSHB-16GB=	16GB Flash USB Drive
N20-BKVM=	KVM local IO cable for UCS servers console port
UCS-CPU-GREASE3=	M4 Server CPU thermal grease syringe - needed for heatsink seal ⁴
UCSX-HSCK=	UCS Processor Heat Sink Cleaning Kit (when replacing a CPU) ³

Table 48 Upgrade and Servicing-related Parts for UCS C240 M4 LFF Server

Spare Product ID (PID)	Description
UCSC-MRAID-SC=	SuperCap for Cisco 12G SAS Modular RAID, including all cables.
UCS-300WKIT-240M4=	300 Watt Cable and Kit for UCS C240M4 Rack Server Includes two heat sinks and two power cables)

Notes . . .

1. This part is included/configured with your UCS server (in some cases, as determined by the configuration of your server).
2. Required if ordering the RAID controller as a spare or to replace damaged cables
3. This SD card is blank.
4. This part should be ordered with the purchase of each optional or spare Intel Xeon E5-2600 v3 CPU processor kit

Adding an Additional CPU (with CPU heat sink) or Replacing CPUs

All Cisco UCS two CPU socket-capable servers can be upgraded from having one to having two CPUs configured or can also support replacement of the CPUs. You will need to order and install a heat sink when adding any additional CPU to a server. Instructions for installing the new CPU or replacing CPUs and heat sink can be found at the following link:

http://www.cisco.com/c/en/us/td/docs/unified_computing/ucs/c/hw/C240M4/install/C240M4.html

See the section titled “Replacing CPUs and Heatsinks.”



NOTE: Unlike previous generation servers, the C240 M4 has tool-less CPU sockets, so no separate tools (such as “pick n place” tools) are required to add or replace CPUs.

Motherboard Lithium Battery

You can order a replacement motherboard battery. Installation instructions are found at this link:

http://www.cisco.com/c/en/us/td/docs/unified_computing/ucs/c/hw/C240M4/install/C240M4.html

See the section titled “Replacing the Motherboard RTC Battery.”

Thermal Grease (with syringe applicator) for CPU to Heatsink Seal

Thermal grease must be applied to the top of the CPU where it comes in contact with the heat sink (a grease syringe also ships with each CPU spare option kit). Instructions for applying thermal grease are found at:

http://www.cisco.com/c/en/us/td/docs/unified_computing/ucs/c/hw/C240M4/install/C240M4.html

See the section titled “Replacing CPUs and Heatsinks.”



CAUTION: Use only the thermal grease specified for this server (UCS-CPU-GREASE3=). This thermal grease comes in a white-tipped syringe and is to be used only in the C220 M4 and C240 M4 servers. Other servers use thermal grease in a blue-tipped syringe (UCS-CPU-GREASE=).

Thermal grease for other systems may have different thermal conductivity properties and may cause overheating if used in the C220 M4 or C240 M4 servers.

DO NOT use thermal grease available for purchase at any commercial electronics store. If these instructions are not followed, the CPU may overheat and be destroyed.



NOTE: When you purchase a spare CPU, the thermal grease with syringe applicator is included.

Air Baffle Replacement Kit

Air baffles are designed to direct airflow through the server to maintain server temperature at a safe operating level. These baffles must always remain installed during server operation. The Air Baffle Replacement Kit includes the air baffles needed for one UCS C220 M4 server.

CPU Heat Sink Cleaning Kit

The cleaning kit is used to remove the existing thermal compound from the bottom of the heat sink during a CPU replacement process. Instructions for cleaning are found at the following link:

http://www.cisco.com/c/en/us/td/docs/unified_computing/ucs/c/hw/C240M4/install/C240M4.html

See the section titled “Replacing CPUs and Heatsinks.”



NOTE: When you purchase a spare CPU, the CPU cleaning kit is included.

RACKS

The Cisco R42610 rack (see [Figure 12 on page 86](#)) is certified for Cisco UCS installation at customer sites and is suitable for the following equipment:

- Cisco UCS B-Series servers and fabric interconnects
- Cisco UCS C-Series and select Nexus switches

The rack is compatible with hardware designed for EIA-standard 19-inch racks. Rack specifications are listed in [Table 49](#).

Table 49 Cisco R42610 Rack Specifications

Parameter	Standard Rack	Expansion Rack
Dimensions (H x W x D)	78.74 x 24 x 43.38 in. (2000 x 610 x 1102 mm)	78.74 x 23.58 x 43.38 in. (2000 x 599 x 1102 mm)
Dimensions (H x W x D) with packaging	89 x 33 x 47 in. (2261 x 838 x 1194 mm)	89 x 33 x 47 in. (2261 x 838 x 1194 mm)
Distance from front mounting rail to rear mounting rail	29.2 in (741 mm)	29.2 in (741 mm)
Weight	299.83 lb (136 kg)	231.49 lb (105 kg)
Weight with packaging	354 lb (161 kg)	284 lb (129 kg)
Side panels included	Yes	No
Equipment mounting capacity	42RU	42RU
Static load capacity	2100 lb (954 kg)	2100 lb (954 kg)
Dynamic load capacity	Not applicable	Not applicable



NOTE: The AC input connector is an IEC 320 C-14 15 A/250 VAC power inlet.

Figure 12 Cisco R42610 Rack



Front view - door closed



Front view - door open



Front view - door removed

PDU

Cisco RP Series Power Distribution Units (PDUs) offer power distribution with branch circuit protection.

Cisco RP Series PDU models distribute power to up to 24 outlets. The architecture organizes power distribution, simplifies cable management, and enables you to move, add, and change rack equipment without an electrician.

With a Cisco RP Series PDU in the rack, you can replace up to two dozen input power cords with just one. The fixed input cord connects to the power source from overhead or under-floor distribution. Your IT equipment is then powered by PDU outlets in the rack using short, easy-to-manage power cords.

The C-series severs accept the zero-rack-unit (ORU) PDU. See [Figure 13](#).

Figure 13 Zero Rack Unit PDU (PID = RP208-30-2P-U-2)

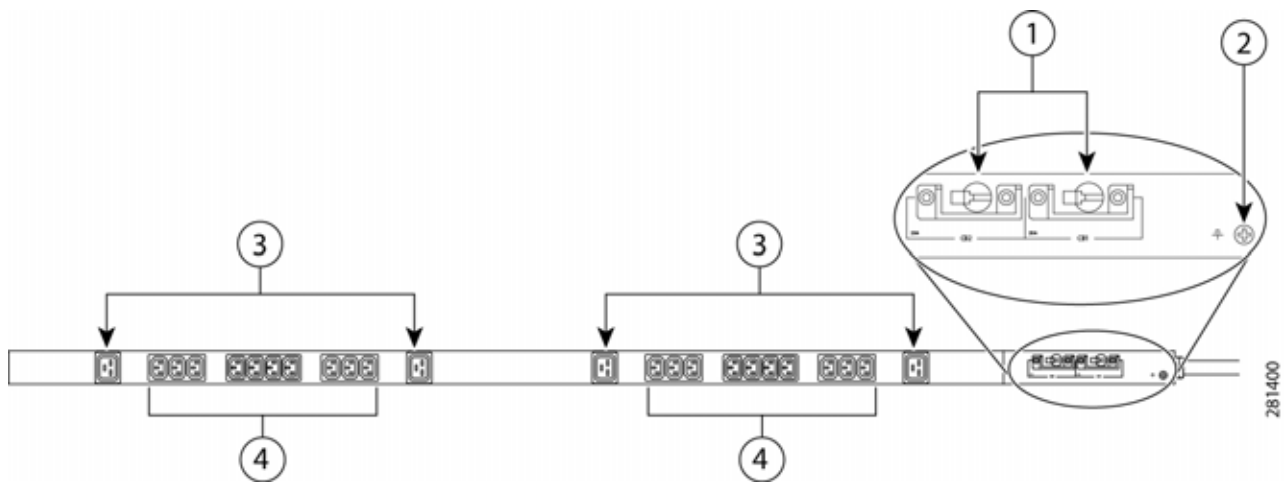

1	Breakers	3	C19 plugs
2	Ground connection	4	C13 plugs

Cisco RP Series PDU models provide two 20-ampere (A) circuit breakers for groups of receptacles. The effects of a tripped circuit are limited to a receptacle group. Simply press a button to reset that circuit.

KVM CABLE

The KVM cable provides a connection into the server, providing a DB9 serial connector, a VGA connector for a monitor, and dual USB 2.0 ports for a keyboard and mouse. With this cable, you can create a direct connection to the operating system and the BIOS running on the server.

The KVM cable ordering information is listed in [Table 50](#).

Table 50 KVM Cable

Product ID (PID)	PID Description
N20-BKVM=	KVM cable for server console port

Figure 14 KVM Cable

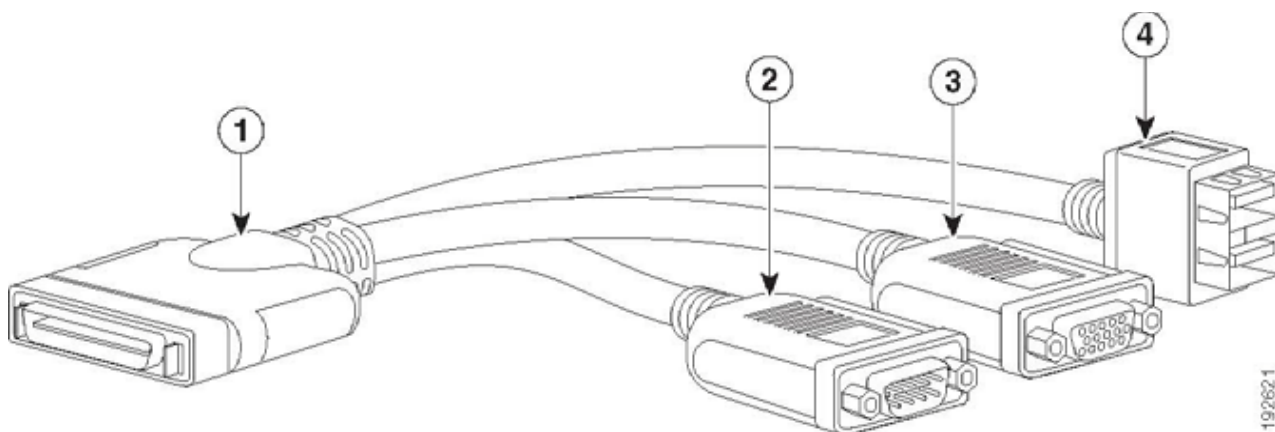

1	Connector (to server front panel)	3	VGA connector (for a monitor)
2	DB-9 serial connector	4	Two-port USB 2.0 connector (for a mouse and keyboard)

Motherboard USB and SD Ports, and RAID Card Backup Locations

The C240 M4 LFF motherboard has a general-purpose USB socket and two SD sockets, as shown in *Figure 15*. The mounting locations for RAID card backup are also shown

Figure 15 Motherboard USB and SD Ports and RAID Backup Location

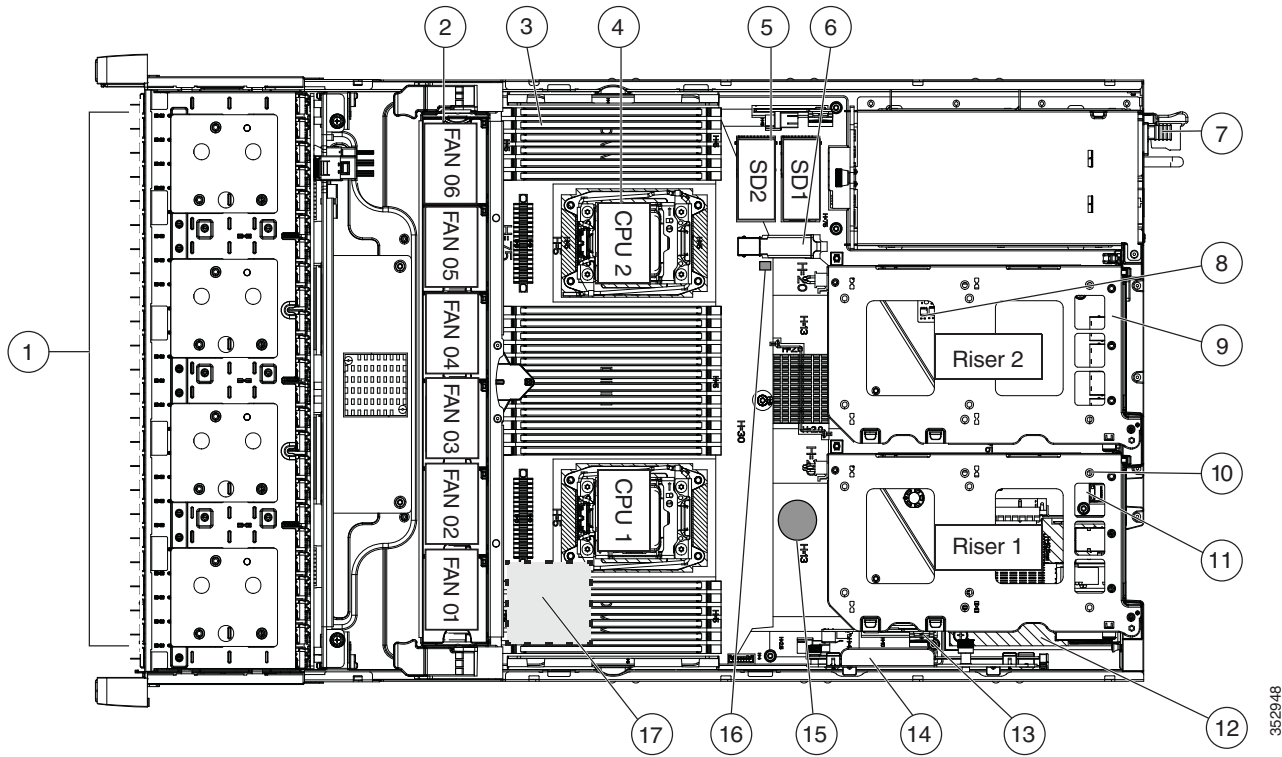

5	SD1 connector (on riser 2 board)	6	USB 3.0 connector (on motherboard)
5	SD2 connector (on riser 2 board)	16	SuperCap RAID data cache power backup unit mounting locations (two, on air baffle not shown in this view)

TECHNICAL SPECIFICATIONS

Dimensions and Weight

Table 51 UCS C240 M4 Dimensions and Weight

Parameter	Value
Height	3.43 in. (8.70 cm)
Width (including slam latches)	17.65 in. (44.8 cm) Including handles: 18.96 in (48.2 cm)
Depth	29.0 in. (73.8 cm) Including handles: 30.18 in (76.6 cm)
Front Clearance	3 in. (76 mm)
Side Clearance	1 in. (25 mm)
Rear Clearance	6 in. (152 mm)
Weight ¹	
Maximum (12 HDDs, 2 CPUs, 24 DIMMs, 2 power supplies)	67.5 lbs (30.6 kg)
Minimum (1 HDD, 1 CPU, 1 DIMM, 1 power supply)	39.2 lbs (17.8 kg)
Bare (0 HDD, 0 CPU, 0 DIMM, 1 power supply)	35.9 lbs (16.3 kg)

Notes . . .

1. Weight does not include outer rail, which is attached to the rack.

Power Specifications

The server is available with the following types of power supplies:

- 650 W (AC)
- 930 W (DC)
- 1200 W (AC)
- 1400 W (AC)

The general power specifications for the C240 M4 LFF server are listed as follows:

- 650 W (AC) power supply (see [Table 52](#)).
- 930 W (DC) power supply (see [Table 53](#)).
- 930 W V2 (DC) power supply (see [Table 54](#))
- 1200 W V2 (AC) power supply (see [Table 55 on page 93](#))
- 1400 W V2 (AC) power supply (see [Table 56 on page 94](#))

Table 52 UCS C240 M4 LFF Power Specifications (650 W AC power supply)

Description	Specification
AC input voltage range	Voltage Range 100-127 VAC, 200-240 VAC nominal (range: 90-140 VAC, 180-264 VAC)
AC input frequency	50 to 60 Hz nominal (range: 47 to 63 Hz)
Maximum AC input current	7.6 Amps maximum at 100 VAC 3.65 Amps maximum at 208 VAC
Maximum Input VA	760 VA at 100 VAC
Maximum output power for each power supply	650 W
Maximum AC inrush current	35 A (sub cycle duration)
Maximum hold up time	12 ms @ 650 W
Power supply output voltage	12 VDC
Power supply standby voltage	12 VDC
Power supply efficiency	Climate Savers Platinum Efficiency (80Plus Platinum Certified)
Form factor	RSP1
Input connector	IEC320 C14

Table 53 UCS C240 M4 LFF Power Specifications (930 W DC power supply)

Description	Specification
AC input voltage	Voltage Range: -48 to -60 VDC nominal (range: -40 to -60 VDC)
Max DC Input current	23A at -48 VDC
Maximum Input Power	1104 W at -48VDC
Maximum output power per power supply	930W
Maximum inrush current	35 A (sub cycle duration)
Maximum hold up time	4ms @ 930 W
Power supply output voltage	12 VDC
Power supply standby voltage	12 VDC
Efficiency rating	> 92% at 50% Load
Form Factor	RSP1
Input connector	3-pos euro terminal block spring cage connection connector. Plug PID UCSC-CONN-930WDC=

Table 54 UCS C240 M4 LFF Power Specifications (930 W DC V2 power supply)

Description	Specification
AC input voltage	Voltage Range: -48 to -60 VDC nominal (range: -40 to -60 VDC)
Max DC Input current	23 A at -48 VDC
Maximum Input Power	1104 W at -48 VDC
Maximum output power per power supply	930 W
Maximum inrush current	35 A (sub cycle duration)
Maximum hold up time	4 ms @ 930 W
Power supply output voltage	12 VDC

Table 54 UCS C240 M4 LFF Power Specifications (930 W DC V2 power supply) *(continued)*

Description	Specification
Power supply standby voltage	12 VDC
Efficiency rating	> 92% at 50% Load
Form Factor	RSP1
Input connector	3 wire Connector (Molex MINIFIT SR. R/A)

Table 55 UCS C240 M4 LFF Power Specifications (1200 W V2 AC power supply)

Description	Specification
AC input voltage	Voltage Range 100-127 VAC, 200-240 VAC nominal (range: 90-140 VAC, 180-264 VAC)
AC input frequency	50 to 60 Hz nominal (range: 47 to 63 Hz)
Max AC Input current	11 A at 100 VAC 7 A at 200 VAC
Maximum Input VA	1400 VA @230VAC
Maximum output power per power supply	800 W at 100 - 120 VAC 1200 W at 200 - 240 VAC 36 W on 12V DC Standby
Maximum inrush current	30 A (sub cycle duration)
Maximum hold up time	12 ms @ 1200 W
Power supply output voltage	12 VDC
Power supply standby voltage	12 VDC
Efficiency rating	Climate Savers Platinum Efficiency (80Plus Platinum Certified)
Form Factor	RSP1 (C-Series 2U and 4U Server)
Input connector	IEC320 C14

Table 56 UCS C240 M4 LFF Power Specifications (1400 W V2 AC power supply)

Description	Specification
AC input voltage	Voltage Range 200-240 VAC nominal (range:180-264 VAC)
AC input frequency	50 to 60 Hz nominal (range: 47 to 63 Hz)
Max AC Input current	8.5 A at 200 VAC
Maximum Input VA	1630 VA @230 VAC
Maximum output power per power supply	1400 W at 200-240 VAC 36 W on 12V DC Standby
Maximum inrush current	30 A (sub cycle duration)
Maximum hold up time	12 ms @ 1400 W
Power supply output voltage	12 VDC
Power supply standby voltage	12 VDC
Efficiency rating	Climate Savers Platinum Efficiency (80Plus Platinum Certified)
Form Factor	RSP1 (C-Series 2U and 4U Server)
Input connector	IEC320 C14

For configuration-specific power specifications, use the Cisco UCS Power Calculator at this URL:

<http://ucspowercalc.cisco.com>

Environmental Specifications

The power specifications for the C240 M4 server are listed in [Table 57](#).

Table 57 UCS C240 M4 LFF Environmental Specifications

Parameter	Minimum
Temperature operating	41 to 95° F (5 to 35° C) derate the maximum temperature by 1° C per every 1000 ft. (305 m) of altitude above sea level
Temperature nonoperating	-40 to 149° F (-40 to 65° C)
Humidity (RH) operating	10 to 90%, non-condensing at 82° F (28° C)
Humidity (RH) nonoperating	5 to 93% at 82° F (28° C)
Altitude operating	0 to 3,000 m (0 to 10,000 ft.)
Altitude nonoperating	0 to 12,192 m (0 to 40,000 ft.)
Sound Power level, Measure A-weighted per ISO7779 LWAd (Bels) Operation at 73° F (23° C)	5.8
Sound Pressure level, Measure A-weighted per ISO7779 LpAm (dBA) Operation at 73° F (23° C)	43

Compliance Requirements

The regulatory compliance requirements for C-Series servers are listed in [Table 58](#).

Table 58 UCS C-Series Regulatory Compliance Requirements

Parameter	Description
Regulatory Compliance	Products should comply with CE Markings per directives 2004/108/EC and 2006/95/EC
Safety	UL 60950-1 Second Edition CAN/CSA-C22.2 No. 60950-1 Second Edition EN 60950-1 Second Edition IEC 60950-1 Second Edition AS/NZS 60950-1 GB4943 2001
EMC - Emissions	47CFR Part 15 (CFR 47) Class A AS/NZS CISPR22 Class A CISPR22 Class A EN55022 Class A ICES003 Class A VCCI Class A EN61000-3-2 EN61000-3-3 KN22 Class A CNS13438 Class A
EMC - Immunity	EN55024 CISPR24 EN300386 KN24



Americas Headquarters
Cisco Systems, Inc.
San Jose, CA

Asia Pacific Headquarters
Cisco Systems (USA) Pte. Ltd.
Singapore

Europe Headquarters
Cisco Systems International BV Amsterdam,
The Netherlands

Cisco has more than 200 offices worldwide. Addresses, phone numbers, and fax numbers are listed on the Cisco Website at www.cisco.com/go/offices.

Cisco and the Cisco Logo are trademarks of Cisco Systems, Inc. and/or its affiliates in the U.S. and other countries. A listing of Cisco's trademarks can be found at www.cisco.com/go/trademarks. Third party trademarks mentioned are the property of their respective owners. The use of the word partner does not imply a partnership relationship between Cisco and any other company. (1005R)