

Brooklyn Wall Holder With Plug

Product Code: BR-WL-FLWP

H: 18 cm x W: 12 cm x D: 20 cm

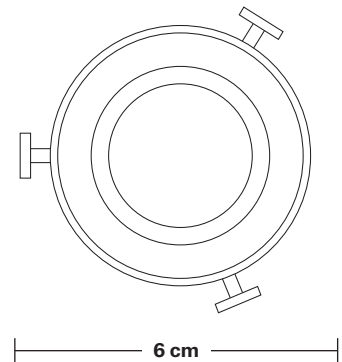
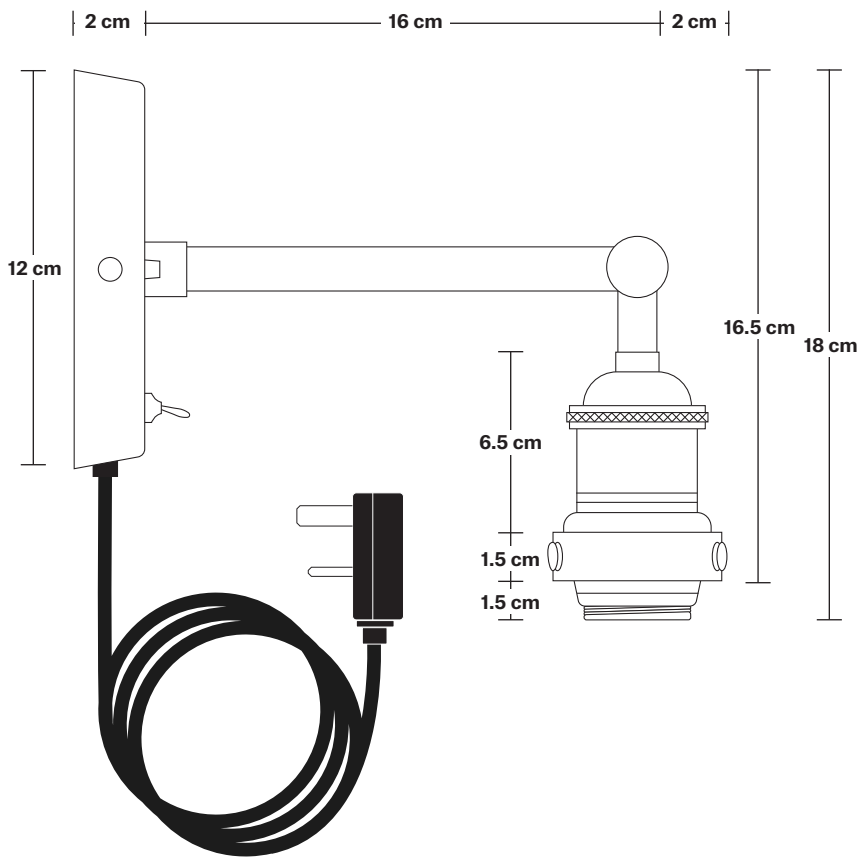

SPECIFICATIONS

We meet all UK and EU lighting and safety regulations.

Our products are hand finished to ensure an authentic vintage look and therefore they may vary slightly from those shown in the images.

Bulb required: Standard screw (E27) fitting, max 40W.

Weight: 0.7 kg

INFORMATION

Finishes: Brass, Pewter, Copper.

Wall mount screws not included.

The lights can be operated by both the flick switch or the main switch.

Wall rose: Pewter.

Flex: 1.3m Black Twisted Fabric Flex.

Plug: UK AC power plug BS1362

DIMENSIONS

Holder Diameter: 6 cm / 2.5"

Holder Height: 18 cm / 7.1"

Projection: 20 cm / 7.9"

Wall Rose Diameter: 12 cm / 4.9"

Wall Rose Depth: 2 cm / 0.8"

Brooklyn Wall Holder - With Plug

Brooklyn Wall Holder - With Plug

Brooklyn Wall Holder - Brass - With Plug

BR-WL-B-FLWP

Brooklyn Wall Holder - Pewter - With Plug

BR-WL-P-FLWP

Brooklyn Wall Holder - Copper - With Plug

BR-WL-C-FLWP
