

# CD+G Karaoke System with Bluetooth and Light Effects

## INSTRUCTION MANUAL

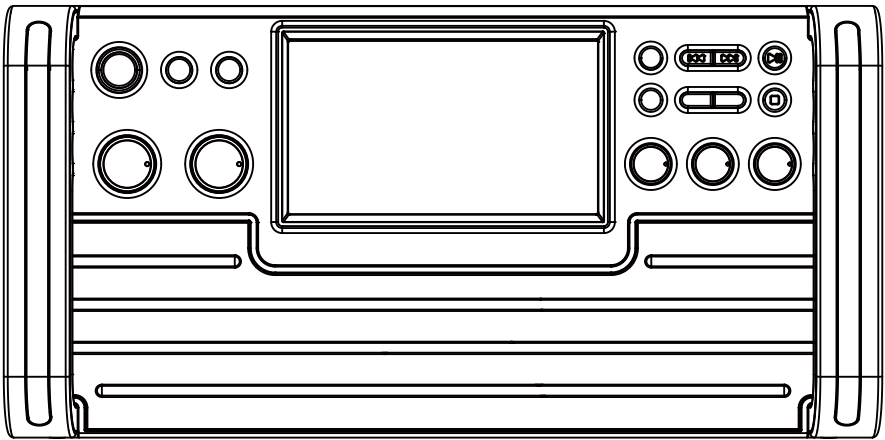







### EKS780-BT

Thank you for purchasing this Karaoke System. Please read this instruction manual carefully before using this product to ensure proper use. Keep this manual in a safe place for future reference.

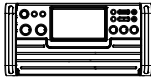

## BEFORE WE BEGIN

Thank you for purchasing the EKS780-BT Karaoke Machine. This is your assurance of quality, performance and value. This product was manufactured using the highest quality components and standards of workmanship. Our engineers have included many useful and convenient features in this product. Please be sure to read this instruction manual completely to make sure you are getting the maximum benefit from each feature.

## WHAT'S IN THE BOX

KARAOKE MACHINE	TABLET CRADLE	PRE-RECORDED KARAOKE CD+G DISC	AV CABLE
			
AC POWER ADAPTOR	DYNAMIC MICROPHONE	INSTRUCTION MANUAL	
			

## IMPORTANT SAFETY INSTRUCTION

	<b>CAUTION</b> RISK OF ELECTRIC SHOCK DO NOT OPEN		<b>LASER SAFETY:</b> This unit employs a laser. Only qualified service personnel should attempt to service this device due to possible eye injury. <b>CAUTION:</b> USE OF CONTROLS, ADJUSTMENTS OR PERFORMANCE, PROCEDURE HEREIN MAY RESULT IN HAZARDOUS RADIATION EXPOSURE.
<b>WARNING:</b> TO REDUCE THE RISK OF ELECTRIC SHOCK, DO NOT REMOVE COVER (OR BACK). NO USER-SERVICEABLE PARTS INSIDE. REFER SERVICING TO QUALIFIED SERVICE PERSONNEL.			

The **CAUTION** marking is located at the bottom of the unit.



### DAINGEROUS VOLTAGE

The lightning flash with arrowhead symbol, within an equilateral triangle, is intended to alert the user to the presence of uninsulated dangerous voltage within the product's enclosure that may be of sufficient magnitude to constitute a risk of electric shock to persons.



### ATTENTION

The exclamation point within an equilateral triangle is intended to alert the user to the presence of important operating and maintenance (servicing) instructions in the literature accompanying the appliance.

Below markings are located inside CD compartment.



### DANGER:

Invisible and hazardous laser radiation when open and interlock failed or defeated. Avoid direct exposure to beam.

**CLASS 1  
LASER PRODUCT**

This compact disc player is classified as a CLASS 1 LASER PRODUCT. The CLASS 1 LASER PRODUCT label is located inside the CD compartment.

- This unit is designed to operate on an AC 100-240V~50/60Hz supply only. Connecting it to other power sources may damage it. Ensure that the supply corresponds to the information on the rating label on the bottom of the unit.
- Under the environment with electrostatic discharge the sample may malfunction and need user reset to recover sometimes.

# **IMPORTANT SAFETY INSTRUCTION**

---

## **SAFETY CONSIDERATIONS**

1. Ensure a minimum distance of 5 cm around the apparatus for sufficient ventilation.
2. The ventilation should not be impeded by covering the ventilation openings with items, such as newspapers, tablecloth, curtains, etc.
3. No naked flame sources, such as lighted candles, should be placed on the apparatus.
4. It shall not be exposed to dripping or splashing and that no objects filled with liquids, such as vases, shall be placed on the apparatus.
5. Do not place the product in closed bookcases or racks without proper ventilation.
6. Where the mains plug or an appliance coupler is used as the disconnect device, the disconnect device shall remain readily operable.

## **WARNINGS**

1. The apparatus shall not be exposed to dripping or splashing and that no objects filled with liquids, such as vases, shall be placed on apparatus.
2. The AC/DC adaptor and apparatus shall not be exposed to dripping or splashing and that no objects filled with liquids, such as vases, shall be placed on the AC/DC adaptor and apparatus.
3. The AC/DC adaptor is used as disconnect device.  
The AC/DC adaptor of apparatus should not be obstructed OR should be easily accessed during intended used. To be completely disconnect the power input, the AC/DC adaptor of apparatus shall be disconnected from the mains.
4. An appliance with a protective earth terminal should be connected to a mains outlet with a protective earth connection.

## **POWER CONNECTION & OPERATION**

---

### **CONNECTING AC POWER**

Plug the supplied power adapter small end into DC jack located on the rear panel, plug the adapter into the standard AC wall socket.

CAUTION: The unit is designed to operate from a mains supply of AC 100-240V~50/60Hz.

If the adapter does not fit properly, turn it over and try again. Do not force it.

NOTES: When the unit is not operated by the AC power or unused for long periods of time.

Please remove the power adapter from the wall outlet and unplug from the main unit.

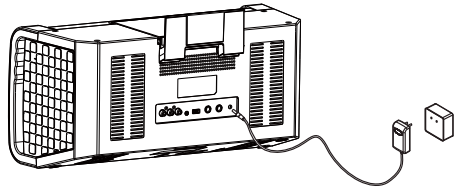

### **ESTABLISH A SAFE SOUND LEVEL**

Over time your hearing will adapt to continuous loud sounds and will give the impression that the volume has in fact been reduced. What seems normal to you may in fact be harmful. To guard against this before your hearing adapts, set the volume to a low level.

Slowly increase the level until you can hear comfortably and clearly and without distortion.

Damage to your hearing is accumulative and is irreversible. Any ringing or discomfort in the ears indicates that the volume is too loud. Once you have established a comfortable listening level, do not increase the sound level.

### **ADJUSTING THE VOLUME**

Turn the VOLUME Control knob to increase / decrease the volume.

# CONTROL LOCATION

## TOP VIEW

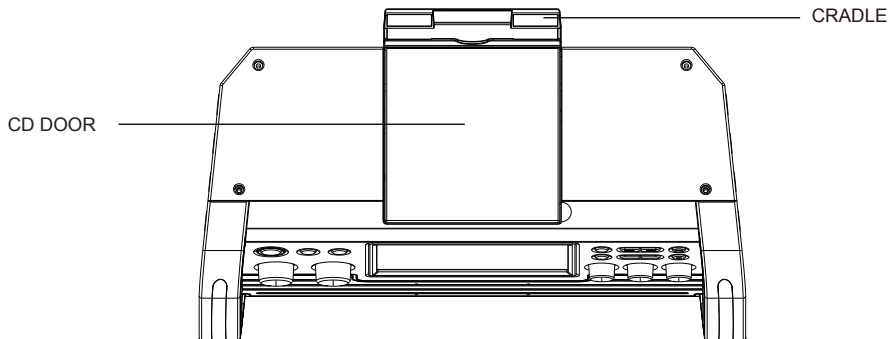

## FRONT VIEW

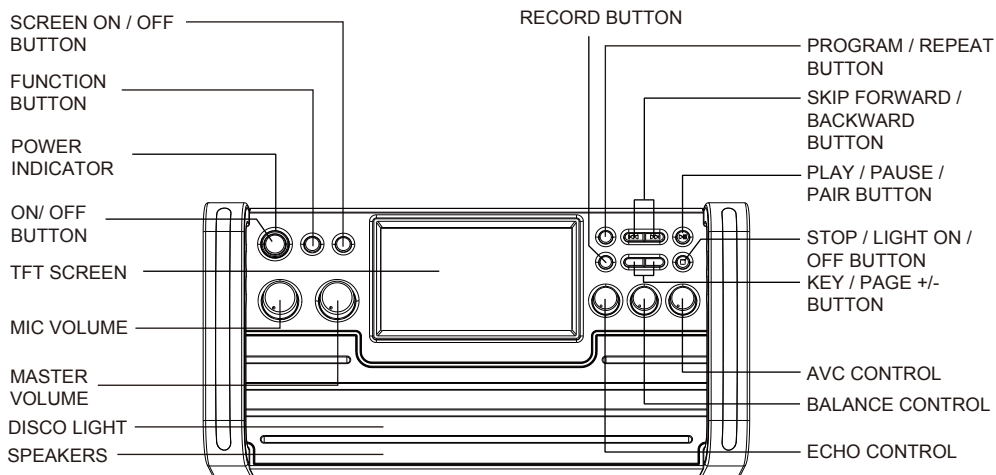

## BACK VIEW

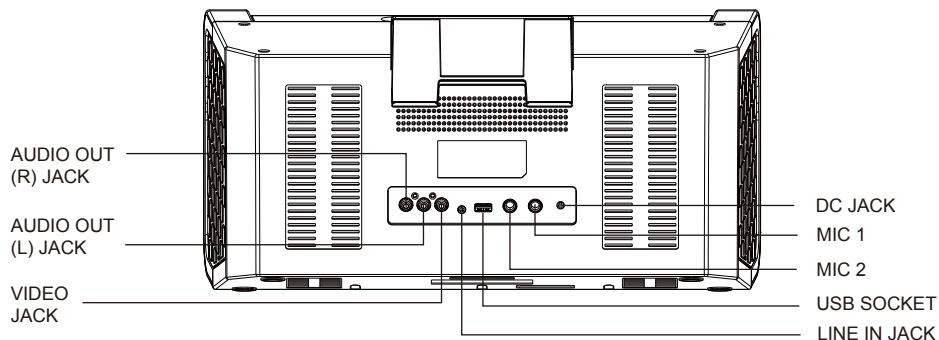

# TFT DISPLAY ICON

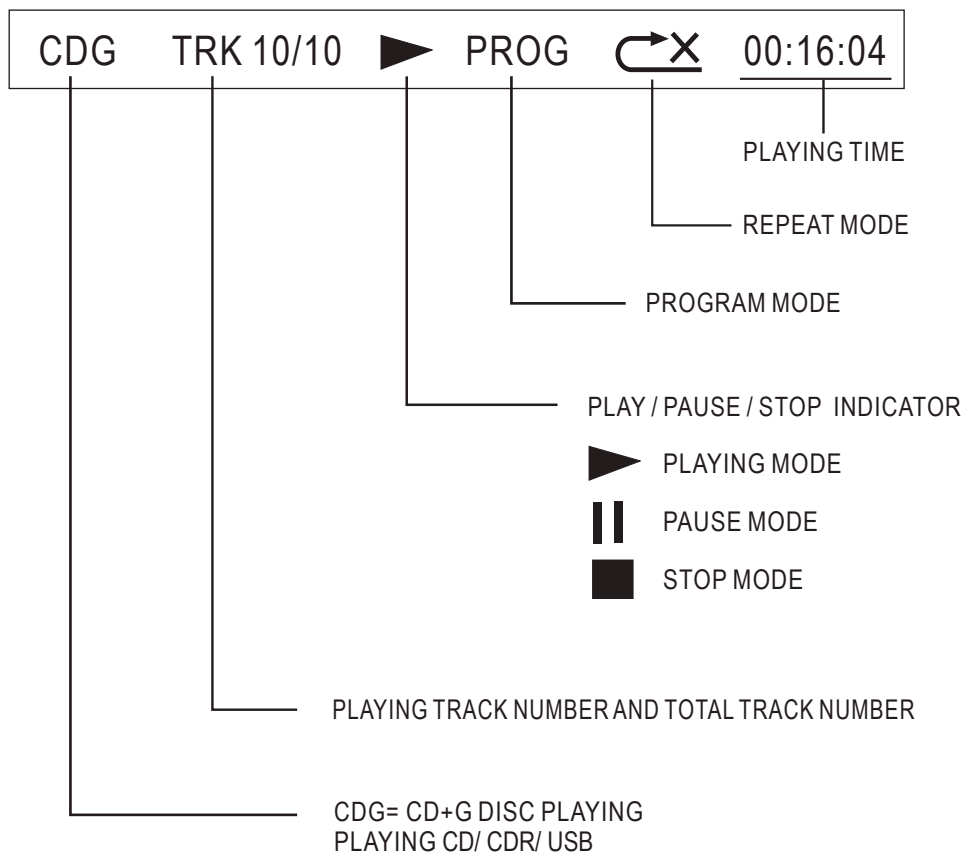

# TABLET OPERATION

- Snap the tablet cradle via two mounting holes at the back of the unit till the cradle is locked in place on both ends securely.
- Put your tablet in landscape position (Do not encourage to put in portrait position)

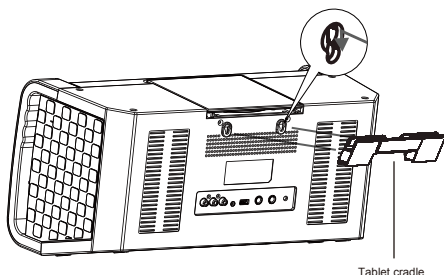

# MAKING THE CONNECTIONS

## CONNECTING TO YOUR TV OR VCR / HOME THEATER

Your Karaoke machine is designed to connect to your TV the same way you would connect most video cameras, VCR / Home theater or video games consoles. We have provided RCA cables to connect your unit to a TV, VCR / Home theater, video device or an external audio / sound system. The RCA cables have three connections at each end (white and red are for left and right audio connections and the yellow is for video connections).

## VIDEO CONNECTION

Please follow the steps below to display CD+G lyrics on the TV screen:

1. Locate the multi-colored RCA cables.
2. Connect video cable (yellow) to the Video Out of the back of the Karaoke Machine.
3. Connect the other end of the video cable (yellow) to the video input on your TV or VCR / Home theater.

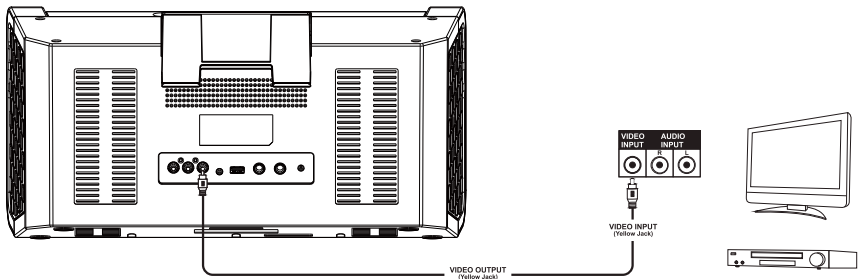

## SELECTING YOUR KARAOKE MACHINE AS YOUR SOURCE/INPUT

Selecting your Karaoke Machine as a source / input on your TV is very similar to connecting a VCR/DVD or Satellite system.

We've listed below the most common ways of selecting the source from your TV or VCR / Home Theater:

1. In the set up menu of the TV or VCR / Home theater there may be an option for "Input Select" where you can choose between "Cable/Ant., Video 1, Video 2, etc" as the input source.
2. Look for a TV channel between the highest and lowest on your TV or VCR / Home theater (i.e AUX, EXT, LINE 1 or LINE IN)
3. Your remote control for your TV or VCR / Home Theater may have source input selections as well as detailed below: "Video, Video 1, Game, AUX, EXT or LINE-IN." Choosing one of those sources in most cases should display the lyrics from your **Karaoke Machine** as well.

# MAKING THE CONNECTIONS

## AUDIO CONNECTION

Please follow the steps below to connect audio signal from the unit to your TV, VCR/Home Theater or home audio system.

### RCA connection

1. Locate the multi-colored RCA cables (White and Red)
2. Connect audio cables to the **Audio Out** of the back of your Karaoke Machine.
3. Connect the other end of the audio cables to the Audio/Auxiliary input on your TV or VCR/Home Theater or home audio system.

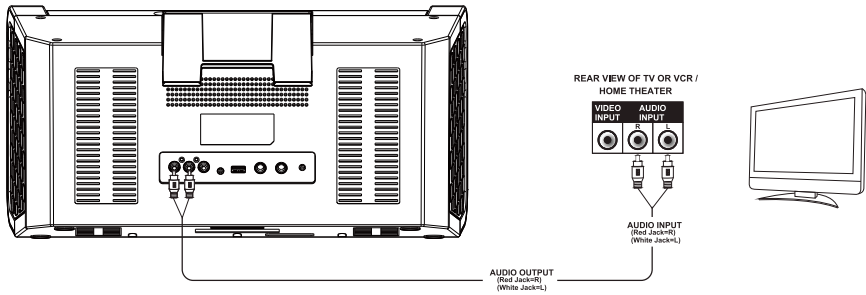

## SETTING UP LINE IN CONNECTION

The Line-in mode allows you to connect external music player or external sound source to your Karaoke Machine speakers

1. Plug a 3.5mm audio cable (not included) into your external music player and connect the other end (3.5mm jack) into the **LINE IN** jack on the front of your Karaoke Machine.
2. Make sure your external music is turned on.
3. Start music playback on your external music player.
4. Adjust MASTER VOLUME to control the sound level of the music playback from the speakers on the Karaoke machine.

### NOTE:

If the unit is in CDG / USB / Bluetooth mode, when you connect an external audio device to the LINE IN jack by an LINE-IN cable, this unit will automatically be switched to LINE IN mode. If you remove the LINE-IN cable from the LINE IN jack, the unit will resume to the previous mode.

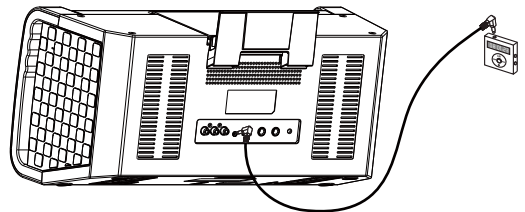

# MAKING THE CONNECTIONS

---

## SETTING UP YOUR MICROPHONE

1. Plug a microphone into the **MIC1** or **MIC2** jack at the rear of your Karaoke Machine. Their output is mixed with playback from CD/CD+G.
2. Located on the microphone, there is an ON/OFF switch.
3. Ensure you set the ON/OFF switch on the microphone to ON when required for use.

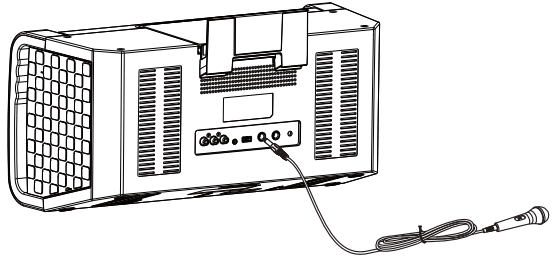

### **Warning:**

Please do not point the microphone head directly to the front of the speaker(s) on the unit when you are singing, it would cause unwanted feedback sound that may affect the performance of your unit.

Tapping or dropping the microphone while it is on can permanently damage your microphone. Resist the urge to swing the microphone around by the cord!

VHF wireless microphones are not recommended to work with this Karaoke system. Some VHF wireless microphones may cause unwanted noise and interference.





# CD OR CD+G / MP3+G OPERATION

This unit is designed to play CDs/CD+G/MP3/MP3+G disc bearing the identification logo respectively. If the disc does not conform to the standard, it may not play properly.



**NOTE:** The unit may not be able to read CDR or CDRW disc correctly. The readability depends on the quality of recording produced by CD recorder or CD writer.

## TURNING POWER ON/OFF

1. To turn on the **Karaoke Machine**, press the **POWER**  button once, the POWER indicator will light up to full brightness and TFT screen will display the OPENING SCREEN and start to read CD. (If no disc is loaded, it will display "NO DISC")
2. To turn off the system, press the **POWER**  button again. The power indicator and TFT screen will turn off.



## LOADING A DISC

1. Open the CD door, place a disc in the CD compartment with the printed side facing up.
2. Gently close the CD Door to the CD compartment. The Karaoke Machine begins to read the disc and "READ" will be displayed. After that, the operation icon will appear on the top of the TFT screen.
3. Press **PLAY/PAUSE** to play the disc. (If no disc is loaded, it will display "NO DISC")

## PLAY/PAUSE

1. To start playing, press the **PLAY/PAUSE** button once, the currently track number and PLAY indicator will appear on the screen.
2. To temporarily stop playing, press the **PLAY/PAUSE** button, the PAUSE indicator will be shown on the screen.
3. To resume play, press the PLAY/PAUSE button again, the PLAY indicator will be shown on the screen.

**NOTE:** - *Pressing pause when a CD+G/MP3+G is playing may cause distorted lyrics on the screen, any distortion will remain until the whole screen is refreshed during an instrumental break or you stop the song and start it from the beginning*

- *Never place anything except a compact disc on the disc compartment. Foreign objects can damage the unit.*
- *Do not apply excessive force to disc cover.*
- *Only place one disc on the disc compartment at a time.*
- *Do not open the disc cover of the CD compartment while it's playing.*

## STOP

If the **STOP** button is pressed in the course of playing, the disc will cease to play.

## SKIP PLAY (For both CD and CD+G/MP3+G discs)

In stop or playback mode, you can skip up or down to a specific track by pressing the forward or back SKIP Button.

# CD OR CD+G / MP3+G OPERATION

---

## SEARCH (For CD disc /MP3 disc only)

When playing a CD disc or MP3 disc, you can press and hold the **SKIP** buttons (**◀◀** or **▶▶**) to locate a specific point on a track. The system will search at high speed in the forward or reverse direction. By releasing the button, normal play will be resumed.

## REPEAT PLAY (For both CD and CD+G/MP3+G discs)

1. During playback, press **PROGRAM/REPEAT** button once, the REP ONE indicator will appear on the TFT screen, it can keep repeat the current track.
2. To repeat the Directory/Folder, press **PROGRAM/REPEAT** button twice, the REP FOLDER indicator will appear on the TFT screen.
3. To repeat all tracks in disc, press **PROGRAM/REPEAT** button again, the REP ALL indicator will appear on the TFT screen.
4. To clear the REPEAT function, press **PROGRAM/REPEAT** button again, the NO REP indicator will appear on the TFT screen.

## PROGRAMMING CD PLAYBACK

This unit can be programmed to play up to 20 tracks/files in CD mode. Load the music CD/CD+G or MP3/MP3+G disc onto the CD compartment (without pressing the **PLAY/PAUSE** button).

- 1) Press **PROGRAM/REPEAT** button once in stop mode. "PRG SET 01:XX" will be shown on the screen.
- 2) Press the **SKIP** buttons to select the desired track to be programmed.
- 3) Press **PROGRAM/REPEAT** button again to save the selected track/files.
- 4) Repeat steps 2–3 to program up to 20 tracks/files.
- 5) Press the **PLAY/PAUSE** button to play the programmed tracks after programming is completed. The "PROG" indicator will appear on screen during the programmed playback.
- 6) To clear program and resume normal playback, press the **STOP** button twice during playback, or open the CD door to clear the programmed tracks.

## REMARK:

*The unit can store up to 20 tracks/files in the programmable memories. During the programmed playback, user can still select the "repeat one/repeat all" function.*

## PAGE+ / PAGE-

During the STOP mode, press PAGE+/PAGE- to advance song selection by 10 tracks or to go to the next page of song list.

## KEY+ / KEY-

Your system includes a digital key controller to adjust the audio tone (pitch) of the music. Key control should be done in the PLAY MODE only.

Press the **KEY+** button to raise the key of the music, and press the **KEY-** button to lower the key. (max. 6 times)

# CD OR CD+G / MP3+G OPERATION

---

## ECHO

Adjust the **ECHO** control to enhance your voice for a concert hall effect.

## BALANCE

Adjust the **BALANCE** control between the pre-recorded singer's voice and the music when using a multiplex karaoke disc.

## AUTO VOICE CONTROL

AUTO VOICE CONTROL can be activated and adjusted by the **AVC** control knob. The vocals on the Multiplex recording will be muted when the singer starts to sing through the microphone. When the singer stops singing, the vocals will resume to normal.

## MASTER VOLUME

Rotate to the **MASTER VOLUME** control to obtain the desired sound level.

## MIC VOLUME

Adjust the **MIC VOLUME** control to a desired level and obtain the best performance.

## SCREEN ON/OFF

Press the **SCREEN ON/OFF** button to turn the TFT screen ON/OFF.

## SELECTING THE AUDIO SOURCE

Press **FUNCTION** button to toggle between CD, USB, Bluetooth modes.

## RECORDING AUDIO

You can record CD+G video and audio together with the singer's voice to a USB flash drive. The recording will be in MP3 format. The stored file name after recording will be "TRKXX.MP3".

- Plug a USB flash drive to USB socket.
- Start the desired track to play on CD/CD+G disc by pressing the **SKIP ►►** or **SKIP ◄◄** button.
- Press **RECORD** button to record the CD/CD+G playback together with your voice. (The percentage of completion will be displayed.)
- Press **RECORD** button again to stop recording.
- To playback the recording, it is the same as playing back the MP3 or MP3+G file on the USB flash drive, please follow instructions in USB OPERATION.

**NOTE:** *This Karaoke system can only record tracks on CD / CD+G disc.*

## LIGHT EFFECT

Press and hold the **LIGHT ON/OFF** button once to switch on LED light effect. Press and hold the button again to switch off.

# USB OPERATION

---

## INSERTING USB FLASH DRIVE

1. Insert a USB flash driver into the USB socket on the back of your karaoke system.
2. Make sure that USB is selected as the audio source.  
See "SELECTING THE AUDIO SOURCE"
3. Press PLAY/PAUSE to start playback.

## PLAY/PAUSE

1. To start playing, press the **PLAY/PAUSE** button once, the currently track number and PLAY indicator will appear on the screen.
2. To temporarily stop playing, press the **PLAY/PAUSE** button, the PAUSE indicator will be shown on the screen.
3. To resume play, press the PLAY/PAUSE button again, the PLAY indicator will be shown on the screen.

**NOTE:** - *Pressing pause when playing on the MP3+G, it may cause distorted lyrics on the screen, any distortion will remain until the whole screen is refreshed during an instrumental break or you stop the song and start it from the beginning*

## STOP

If the **STOP** button is pressed in the course of playing, the MP3+G playback will cease to play.

## SKIP PLAY

In stop or playback mode, you can skip up or down to a specific track by pressing the forward or back **SKIP** Button.

## PAGE+ / PAGE-

During the STOP mode, press PAGE+/PAGE- to advance song selection by 10 tracks or to go to the next page of song list.

## SEARCH (For MP3 file only)

When playing a MP3 file on the USB, you can press and hold the SKIP buttons (**◀◀SKIP▶▶**) to locate a specific point on a track. The system will search at high speed in the forward or reverse direction. By releasing the button, normal play will be resumed.

## REPEAT PLAY

1. During playback, press **PROGRAM/REPEAT** button once, the REP ONE indicator will appear on the TFT screen, it can keep repeat the current track.
2. To repeat the Directory/Folder, press **PROGRAM/REPEAT** button twice, the REP FOLDER indicator will appear on the TFT screen.
3. To repeat all tracks in disc, press **PROGRAM/REPEAT** button again, the REP ALL indicator will appear on the TFT screen.
4. To clear the REPEAT function, press **PROGRAM/REPEAT** button again, the NO REP indicator will appear on the TFT screen.

# USB OPERATION

---

## PROGRAMMING USB PLAYBACK

This unit can be programmed to play up to 20 tracks/files in USB mode. Plug the USB flash drive and select USB mode. (without pressing the **PLAY/PAUSE** button).

- 1) Press **PROGRAM/REPEAT** button once in stop mode. "PRG SET 01:XXX" will be shown on the screen.
- 2) Press the **SKIP** buttons to select the desired track to be programmed.
- 3) Press **PROGRAM/REPEAT** button again to save the selected track/files.
- 4) Repeat steps 2–3 to program up to 20 tracks/file.
- 5) Press the **PLAY/PAUSE** button to play the programmed tracks after programming is completed. The "PROG" indicator will appear on screen during the programmed playback.
- 6) To clear program and resume normal playback, press the **STOP** button twice during playback to clear the programmed tracks.

### REMARK:

*The unit can store up to 20 tracks/files in the programmable memories. During the programmed playback, user can still select the "repeat one/repeat all" function.*

# BLUETOOTH OPERATION

---

## BLUETOOTH SETUP

Pairing is the term used when two Bluetooth devices are connected wirelessly.

- 1 Press **FUNCTION** button to toggle to Bluetooth mode.
2. The Bluetooth indicator will flash quickly.
3. Using the native controls on your Bluetooth Device, select the "EKS780BT" in your Bluetooth setting to pair.
4. When successfully paired, the Bluetooth indicator will stop flashing.
5. To unpair, press & hold the PAIR button.

## PLAYING MUSIC VIA BLUETOOTH

1. Follow the instructions for Pairing a Bluetooth Device.
2. Use the native controls on the connected Bluetooth Device to select a track.
3. To play, pause or skip the selected track, use the native controls on the connected Bluetooth Device.
4. Audio playback from the connected Bluetooth device can now be heard through the speaker.

# CARE AND MAINTENANCE

---

## \*Carrying for Compact Discs

1. Treat the disc carefully. Handle the disc only by its edges. Never allow your fingers to come in contact with the shiny, unprinted side of the disc.
2. Do not attach adhesive tape, stickers, etc. to the disc label.

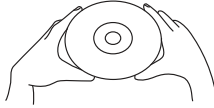

3. Clean the discs periodically with a soft, lint-free, dry cloth. Never use detergents or abrasive cleaners to clean the disc. If necessary, use a CD cleaning kit. If a disc skips or gets stuck on a section of the disc, it is probably dirty or damaged (scratched). When cleaning the disc, wipe in straight lines from the center of the disc to the outer edge of the disc. Never wipe in circular motions.

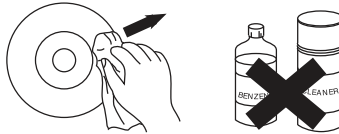

4. This unit is designed to play discs bearing the identification logo as shown here or MP3 format Disc. Other discs may not conform to the CD standard and may not play properly.
5. Discs should be stored in their cases after each use to avoid damage.
6. Do not expose discs to direct sunlight, high humidity, high temperatures, or dust, etc. Prolonged exposure or extreme temperatures can warp the disc.
7. Do not stick or write anything on either side of the disc. Sharp writing instruments or the ink may damage the surface.

## \*Care of the Cabinet

1. To prevent fire or shock hazard, disconnect your unit from the AC power source when cleaning.
2. The finish on your unit may be cleaned with a dust cloth and cared for as other furniture. Use caution when cleaning and wiping the plastic parts.
3. Mild soap and a damp cloth may be used on the front panel.

## \*To Clean the Lens

If the lens get dirty, your player may skip or may not play a CD

1. Open the CD door.
2. Use a camera lens blower/brush to blow on the lens once or twice, brush the dust or particles off the lens then blow again.
3. To remove fingerprints, use a dry cotton swab to wipe from the middle to outer edge of the lens.

# TROUBLE SHOOTING

PROBLEM	POSSIBLE CAUSE	SOLUTION
No power when POWER is on.	AC adaptor is not plugged into a wall outlet or the connector is not plugged into the power supply jack on the back of the unit.	Plug the AC adaptor into a wall outlet and plug the connector into the supply jack on the unit.
No power when plugged in.	The AC outlet may not have power.	Check the outlet with a working lamp or other electrical appliance.
No sound from TV.	TV system is set to minimum.	Turn up the volume on the TV system.
	TV system is powered Off.	Power the TV system on.
	RCA cords are not connected securely.	Ensure white and red RCA cords are securely inserted into the karaoke system and the TV system.
CD Player does not work normally.	Disc is inserted upside down.	Insert the disc correctly.
	Disc is dirty.	Wipe clean with a soft cloth.
	Disc is scratched.	Use a new disc.
	Disc is warped.	Use a new disc.
	A non standard disc is inserted.	Only use discs bearing correct identification logo.
	Moisture has formed inside the CD deck.	Wait about 20 - 30 mins to let it dry out.
No sound - If audio is going through TV or VCR.	Karaoke system needs to be reset.	Disconnect the machine from the power source for 30 seconds then reconnect.
	Source Selection on TV or VCR is not correct.	Follow directions "Making the connections".
	RCA cords are not connected securely.	Ensure white and red RCA cords are securely inserted into both the karaoke system and the home stereo system.

# TROUBLE SHOOTING

PROBLEM	POSSIBLE CAUSE	SOLUTION
No song lyrics appear on the TV screen.	Video cable is not connected properly to the TV.	Connect the video cable to the karaoke system's VIDEO OUT and to the TV VIDEO IN.
	Source selector on TV is not set to VIDEO.	Using your TV remote to select VIDEO input or select the proper VIDEO input on the TV itself.
	TV does not have video line input.	Connect from VIDEO OUT of the system to the VIDEO IN on your VCR/Home theater. Refer to "Making the Connections. Check the disc to be sure it is a CD+G.
	A CDG is loaded but the CD+G icon is not lit.	Check the disc to be sure it is clean.
No sound from mic.	Mic volume control is set to minimum.	Adjust mic volume to max, and then re-adjust to a comfortable level.
	Mic is off.	Turn on mic with the ON/OFF switch located on the microphone.
No Video is displayed on the TFT Screen.	The TFT Screen is turned OFF.	Set Screen button to turn ON.
	The disc being played is a regular music CD, in which case no image will be displayed.	Ensure you are playing a CD+Graphics or CD+G Karaoke disc.
No sound when playing audio via Bluetooth.	Your Bluetooth device hasn't been paired properly.	Pairing your Bluetooth device according to the "Bluetooth setup" section.
	The volume control of your Bluetooth device is set too low.	Increase the volume of your Bluetooth device.
	The volume control of your Bluetooth device is set too low.	Increase the volume of the unit by VOLUME control.



# SPECIFICATION

---

<b>Audio Section</b> Output power Output impedance	3 watt + 3 watt RMS 3 Ohms
<b>CD OR CD+G player</b> Frequency response Signal - to - noise ratio Number of programs	100 Hz - 20 kHz 50 dB 20 STEPS RANDOM ACCESS PROGRAMMING
<b>Microphone</b>	-73 dB 600 OHMS IMPEDANCE WITH Ø 6.3mm DYNAMIC MICROPHONE

Specifications are typical, individual units might vary. They are subject to continuous improvement without notice and without incurring any obligation.

# **THE KARAOKE MACHINE (GLOSSARY OF TERMS)**

Following are some brief descriptions of karaoke terms you may need:

## **Echo:**

By adding some minor feedback to your voice the Echo feature adds depth and resonance to a singer's voice. Echo affects only your voice and not the music. It will make you sound like you are singing in a big concert hall.

## **Multiplex:**

This karaoke system is capable of playing Multiplex CD+G Karaoke discs. Multiplex Karaoke discs feature two mono versions of the same recording on left and right channels. The right channel features a mono version of the song with the lead vocals pre-recorded. The left channel features the same song, without the lead vocals recorded.

## **Auto Voice Control (A.V.C.):**

This is short for "Automatic Vocal Control". When the AVC knob on the front panel of the player is turned clockwise, the AVC function is activated. AVC is used to eliminate the singer's vocals from specially made Multiplex CD+G karaoke discs. Once the AVC is activated, as you sing into the microphone, the pre-recorded vocals are eliminated and replaced with your singing voice. Set the AVC to a lower setting, and you'll be able to hear the pre-recorded vocals in low volume as well as your own singing voice. Set the AVC to maximum and as you sing into the microphone, the pre-recorded lead vocals will be completely eliminated, and only your own singing voice will be heard.

NOTE: The AVC controls is only functional with specific Multiplex CD+G Karaoke Discs. AVC will not eliminate the vocals from standard music CDs, and will not function when playing standard Karaoke CD+G discs, such as the disc included with this system.

## **CD+G:**

This is short for Compact Disc plus Graphics. This is a regular audio CD with the lyrics stored in a data track. While your karaoke player will play regular audio CDs they will not have the background data track that will allow the lyrics to be displayed.

# END OF LIFE DISPOSAL



**Warning!** This logo set on the product means that the recycling of this apparatus comes within the framework of the Directive 2002/96/CE of January 27, 2003 concerning the Waste of Electrical and Electronic Equipment (WEEE).  
This symbol means that used electrical and electronic products should not be mixed with general household waste. There is a separate collection system for these products.

## If you want to dispose of this equipment, please do not use the ordinary dust bin!

- The presence of dangerous substances in the electrical and electronic equipments can have potential consequences on the environment and human health in the cycle of reprocessing this product.
- Therefore, at the end of its lifetime, this product shall not be disposed with other non-recycled waste. Used electrical and electronic equipment must be treated separately and in accordance with legislation that requires proper treatment, recovery and recycling of used electrical and electronic equipment.
- Local authorities and resellers have set special procedures for the purpose of collecting and recycling this product (please contact your local authority for further details). You have the obligation to use the selective waste collection systems put in place by your local authority.
- If your used electrical or electronic equipment has batteries or accumulators, please dispose of these separately beforehand according to local requirements.
- By disposing of this product correctly you will help ensure that the waste undergoes the necessary treatment, recovery and recycling and thus prevent potential negative effects on the environment and human health which could otherwise arise due to inappropriate waste handling.



**This appliance complies with the RED Directive 2014/53/EU & the EMC Directive 2014/30/EU of the European Parliament and the Council and the mutual recognition of their conformity.**

[https://cdn.shopify.com/s/files/1/0364/6701/5819/files/EKS780-BT-RED\\_Certificate.pdf?v=1620224607](https://cdn.shopify.com/s/files/1/0364/6701/5819/files/EKS780-BT-RED_Certificate.pdf?v=1620224607)

## CONTACT DETAILS

In the event of any problems installing or using this Easy Karaoke machine, please contact your local retailer or email [help@easykaraoke.com](mailto:help@easykaraoke.com)

We will endeavour to reply to all correspondence within 24 hours of receipt

### Easy Karaoke Ltd

Graham Lloyd Building  
Midland Structures Industrial Estate  
Amphill Road  
Bedford  
MK42 9JJ

For thousands of free professional karaoke tracks go to [www.easykaraoke.com](http://www.easykaraoke.com)  
[info@easykaraoke.com](mailto:info@easykaraoke.com)