

**Rotaliana**

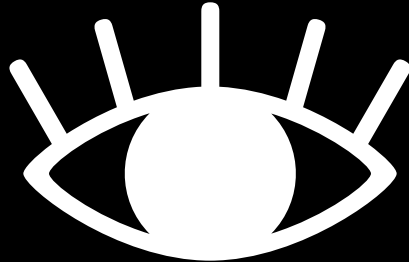

**Collection2022**

**Rotaliana**  
COLLECTION

**30 anni di luce**  
**La storia di Rotaliana**  
**è la storia di un territorio antico,**  
**ricco di tradizione, bellezza e mistero.**  
**Un territorio dove la natura e l'ingegno umano**  
**si sono incontrati e sfidati per secoli in**  
**una ricerca continua di equilibrio**  
**tra luci e ombre attraverso gole**  
**profonde e limpide acque.**

30 years of light  
The story behind Rotaliana is  
the story of an antique land abounding  
in tradition, beauty and mystery. A land  
where Nature and human ingenuity have met  
and challenged each other for centuries, in the  
continuing search for balance between  
light and shadow through deep  
gorges and crystal clear  
waters.

# Index

006	Philosophy	100	Flow Glass	220	String mini + Focus
012	The evolution of the light	106	Frame	228	String XL
014	Designer	114	Furin	232	Sunset
020	Belvedere	120	Goccia	236	Tick
026	Chiardiluna	126	InOut	240	Tide
036	Ciminiere d'Italia + Focus	132	Ipe	244	Tobu
042	CM2	140	Lightwire + Focus	254	Venere + Focus
048	Collide	144	Luxy	264	Accessories / Rosoni
054	Dina	154	Luxy Glam	274	Finiture / Finishing
060	Dina+	162	MultiPot+ + Focus	278	Abaco
066	Dresscode	170	Overlap		
072	Drink	176	Pomi		
078	Dry	182	Prince		
084	Eden Collection + Focus	186	QB		
094	Febo + Focus	190	Squiggle + Focus		
		212	String + Focus		

# Philosophy

## Il nostro modo di illuminare

### Our way of lighting

**IT** - Rotaliana è un'azienda italiana produttrice di lampade di design dal 1989. L'attenzione ai "nuovi" bisogni dei nostri tempi ha guidato la crescita e lo sviluppo aziendale permettendo a Rotaliana di creare nuovi trend e soluzioni innovative con risonanza mondiale. La ricerca di "nuovo modo di illuminare le cose" rappresenta un'attitudine aziendale che si riconosce nelle politiche di sviluppo del proprio territorio: il Trentino. Terra ricca di risorse naturali e di storia, il Trentino detiene un ruolo importante nel campo dell'innovazione coniugando la ricerca con il rispetto per l'ambiente, la tecnologia con una spiccata tutela dei diritti, il futuro con il passato. La ricerca di Rotaliana ha esplorato direzioni diverse. Con l'utilizzo di nuovi materiali, nuove tecnologie e nuove soluzioni formali sono state innovate le tipologie tradizionali di lampade, legate a precisi utilizzi negli spazi (gli **Ambienti di luce**). Tra queste **String**, la *task lamp* con i movimenti bilanciati da un cavo elastico; il globo luminoso **Flow** che, stampato in plastica, crea un effetto ottico di smaterializzazione; i *luminator* **Ciminiere d'Italia** che utilizzano una sorgente LED introducendo l'estetica nostalgica delle ciminiere industriali; **Lightwire** il *luminator* scultoreo ma smaterializzato in tondino di ferro elettrosaldato; la lampada da parete **Frame** che emette luce perfettamente per metà verso l'alto e per metà verso il basso.

#### **MICROAMBIENTI DI LUCE.**

Con la ricerca sui **Microambienti di luce**, Rotaliana ha sviluppato invece le potenzialità di lampade multifunzionali

e multisensoriali: oggetti legati al servizio del sé e dei nuovi bisogni di luce, come **MultiPot**, una lampada/multipresa/svuotatasche.

#### **LUCE E LIBERTÀ.**

Affrontando il tema **Luce e libertà**, Rotaliana ha sviluppato le lampade portatili **Dina+** e **Chiardiluna**, che non sono legate ad un utilizzo predeterminato e si adattano agli spazi interni o esterni.

#### **LUCE E BENESSERE.**

Esplorando il tema **Luce e benessere**, con la ricerca *Effective Light* sono stati sviluppati nuovi concept di apparecchi luminosi. Nata dalla collaborazione di Rotaliana con Neocogita di Rovereto, questa ricerca ha indagato gli aspetti della luce che sono responsabili del nostro benessere emotivo, intellettuale e fisico. Esisterebbe infatti una correlazione tra il funzionamento del nostro corpo e della nostra mente ed il tipo di luce a cui siamo esposti. Il "ritmo circadiano", regolato principalmente sulla luce naturale e sincronizzato dal cosiddetto "terzo occhio", scandisce e regola l'alternarsi delle nostre funzioni fisiologiche (sonno/veglia, nutrizione/digestione). E' possibile allora ottenere una luce capace di agire positivamente sull'umore e sulle capacità cognitive, favorendo il comfort visivo in diverse condizioni ambientali e individuali, offrendo la temperatura di colore della luce più adatta per ogni attività e predisponendo un'alternanza di luce e buio. Il risultato della ricerca *Effective Light* è stata la lampada sperimentale

**Smart+** in grado di ottimizzare la performance dell'utente nell'esecuzione dei diversi compiti quotidiani attraverso una luce dinamica e personalizzata, attenta ai contesti temporali e spaziali e ai dati fisici personali (fisiologici e comportamentali). Lo sviluppo dei sensori e la disponibilità di sistemi di monitoraggio corporeo sono stati utilizzati per programmare dei cicli luminosi durante le attività lavorative (di ufficio e domestiche) che richiedono concentrazione e attenzione nel tempo e in tal modo favorire una corretta gestione del proprio capitale mentale e del proprio tempo lavorativo.

La natura delle lampade di Rotaliana è multiforme e in continua

evoluzione come le specie animali e vegetali nell'albero filogenetico dell'allestimento **Naturalis historia** di EuroLuce 2019. La luce, misteriosa e razionale, scenografica e funzionale, è racchiusa dentro micro-architetture come la cupola di **Febo**; è nascosta dentro forme ispirate alla natura come i frutti metallici **Pomi**; è dinamica come la luce naturale nella **Sting DTW**.

### **BORDER LIGHT.**

**Border light** è la direzione sviluppata dai prodotti più recenti di Rotaliana, al confine tra tecnico e decorativo. Negli ultimi anni infatti anche nella casa hanno avuto sempre maggiore utilizzo le lampade cosiddette "architettoniche" (quelle che richiedono

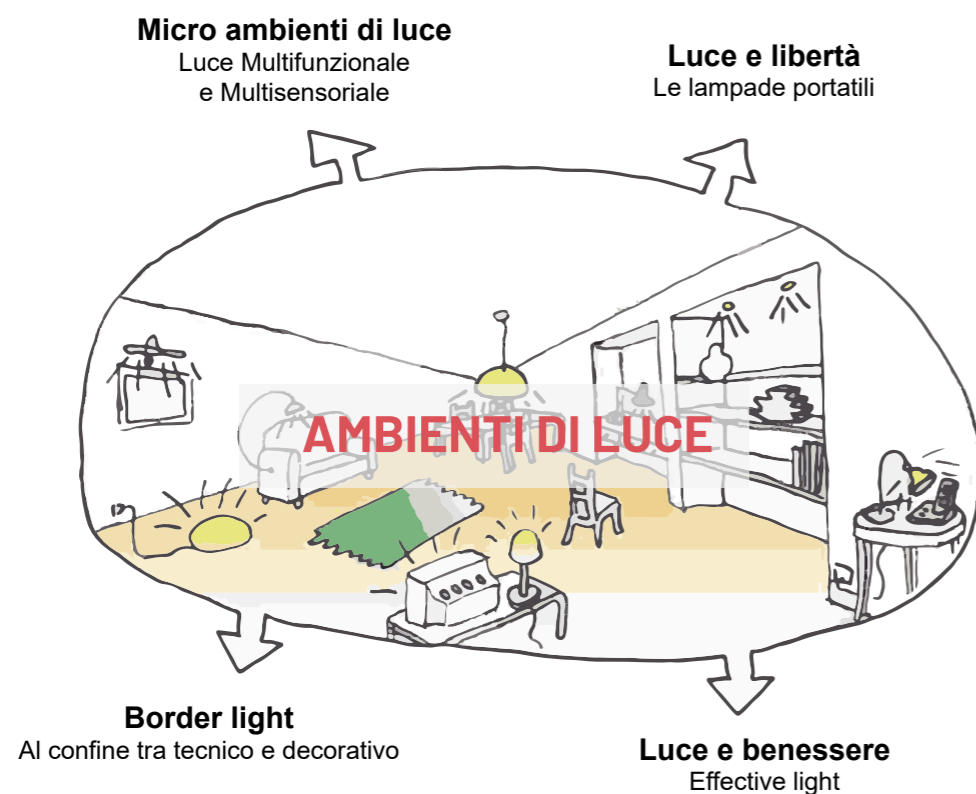

una predisposizione in fase di costruzione) mentre la diffusione dei LED ha fatto in parte svanire le differenze tecniche e prestazionali tra lampade "decorative" e lampade "architettoniche". Inoltre è sempre più richiesta la possibilità di modificare, personalizzare, gestire la luce. Quindi le definizioni decorative e tecnico non indicano più in modo univoco il campo di utilizzo (casa, ufficio, hotel, ristorante, negozio...). A posizionarsi in questo spazio di confine, tra tecnico e decorativo, sono numerosi apparecchi come la lampada fonoassorbente **Eden** che può essere utilizzata anche in casa per la sua estetica decorativa e perché non necessita una installazione a parete o soffitto; **Dresscode** che unisce performance ed estetica soft richiamando un paralume in tessuto plissettato; la lampada a luce lineare **Squiggle**, che diventa una decorazione spaziale alla Fontana; **Venere**, lampada a parete di forma tradizionale ma estremamente performativa, che permette di orientare la luce come con un faretto; **Souvlaki**, il sistema a binario elettrificato adatto per spazi domestici e spazi pubblici, estremamente flessibile, semplice e immediato da configurare, da installare e da utilizzare.

**EN** - Rotaliana is an Italian manufacturer of designer lights, established in 1989. Attention to "new" needs in recent times has guided the company's growth and development, allowing Rotaliana to create new trends and innovative solutions with worldwide success. The search for a "new way of lighting things" represents a company attitude that is reflected in the development policies in its territory: Trentino. A land rich in natural resources and history, Trentino plays an important role in innovation, combining research with respect for nature, technology with firm protection of rights, and the future with the past. The exploration for "a new way to light things up" has taken multiple paths. The traditional types of lamps, based on precise uses in space (the **Light Environments**) have been innovated through the use of new materials, new technologies and new shape solutions. Among these we find: **String**, the task lamp that features movement balanced by an elastic cable; the luminous globe called **Flow** that, being made of plastic, creates an optical effect of dematerialization; the **Ciminiere d'Italia** luminators that use a LED source to portray the nostalgic aesthetics of industrial smokestacks; **Lightwire**, the sculptural but dematerialized *luminator* made of heat-welded metal rod; the **Frame** wall lamp that precisely emits light half upwards and half downwards.

### **THE FIELD OF LIGHT MICROENVIRONMENTS.**

Through its research in **the field of Light Microenvironments**, Rotaliana

instead has developed the potential of multifunctional and multisensorial lamps, i.e. objects linked to the service of the self and of the new lighting needs, such as **MultiPot**, that is a lamp, a power multi-socket and a dresser valet at the same time.

### LIGHT AND FREEDOM.

To address the theme **Light and Freedom**, Rotaliana has developed the portable lamps called **Dina+** and **Chiardiluna**, that are designed to perform specific purposes and are suitable for both the indoors and the outdoors.

### LIGHT AND WELLBEING.

Exploring the theme **Light and Wellbeing**, new concepts for light fixtures have been developed through the *Effective Light* research. Stemming from the partnership of Rotaliana with Neocogita in Rovereto, this research has investigated the aspects of light that are responsible for our emotional, intellectual and physical well-being. It actually seems there's a link between the way our body and mind work and the type of light to which we are exposed. The 'circadian rhythm', mainly regulated by natural light and synchronised by the so-called 'third eye', sets our body's pace and regulates the alternation of its physiological functions (sleep/wake, nutrition/digestion). It is therefore possible to obtain a kind of light capable of having a positive effect on mood and on cognitive faculties, thus favouring visual comfort in diverse environmental and

individual conditions and offering the light colour temperature most suited for each kind of activity while setting an alternation between light and darkness. As a result of the *Effective Light* research, the experimental lamp called **Smart+** was designed. This lamp can optimize the user's performance while executing various daily tasks by emitting a dynamic and customized form of light that is aware of the temporal and spatial contexts and of the user's personal physical (physiological and behavioural) data. The developments in sensorial engineering and the availability of body monitoring systems have been used to program the light cycles applied during office and domestic working activities that call for concentration and attention over time in order to ensure the most efficient use of the user's mental capital and work time.

The multifaceted nature of Rotaliana lamps is in continuous evolution, such as animals and plants in the phylogenetic tree featured in the *Naturalis Historia* installation at EuroLuce 2019. Light, mysterious, and rational, scenographic and functional, it is enclosed within micro-architectures such as the dome of **Febo**; it is hidden inside shapes inspired by nature such as metallic fruits **Pomi**; it is as dynamic as natural light in the **String DTW**.

### BORDER LIGHT.

**Border light** is the path taken with the most recent products designed

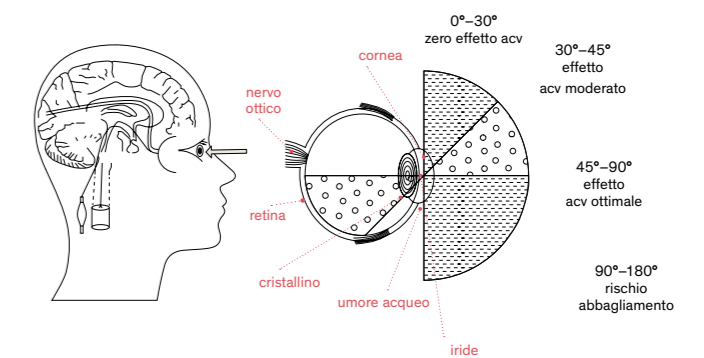
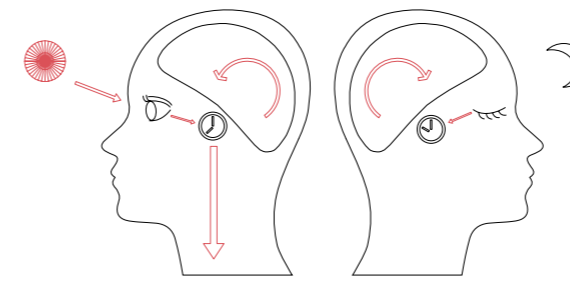

by Rotaliana. In the last few years, homes have increasingly favoured the use of so-called 'architectural' light fixtures, namely those that require pre-setting during the construction stage, while the spreading use of LED lighting has swept away the technical and performance differences between 'decorative' and 'architectural' lamps. Even at home, we are increasingly seeking the option of being able to change, customise and manage interior lighting. Therefore, the definitions 'decorative' and 'technical' no longer unambiguously indicate a given application setting (home, office, hotel, restaurant, shop, etc.). On this borderline between technical and decorative there are: the sound-absorbing lamp called **Eden** that can be used in the home, too, thanks to its domestic shape and because it does not require wall or ceiling installation; **Dresscode**, that brings together performance and soft aesthetics as its shape evokes a pleated fabric lampshade; the linear light lamp named **Squiggle**, that becomes a Fontana-style spatial decoration;

**Venere**, a traditionally shaped but highly performing wall lamp that allows to direct the light as if it were a spotlight; **Souvlaki**, the electrified track system suited for domestic as well as public spaces, extremely flexible and simple and easy to configure, install and use.

# L'evoluzione della luce

## The light evolution

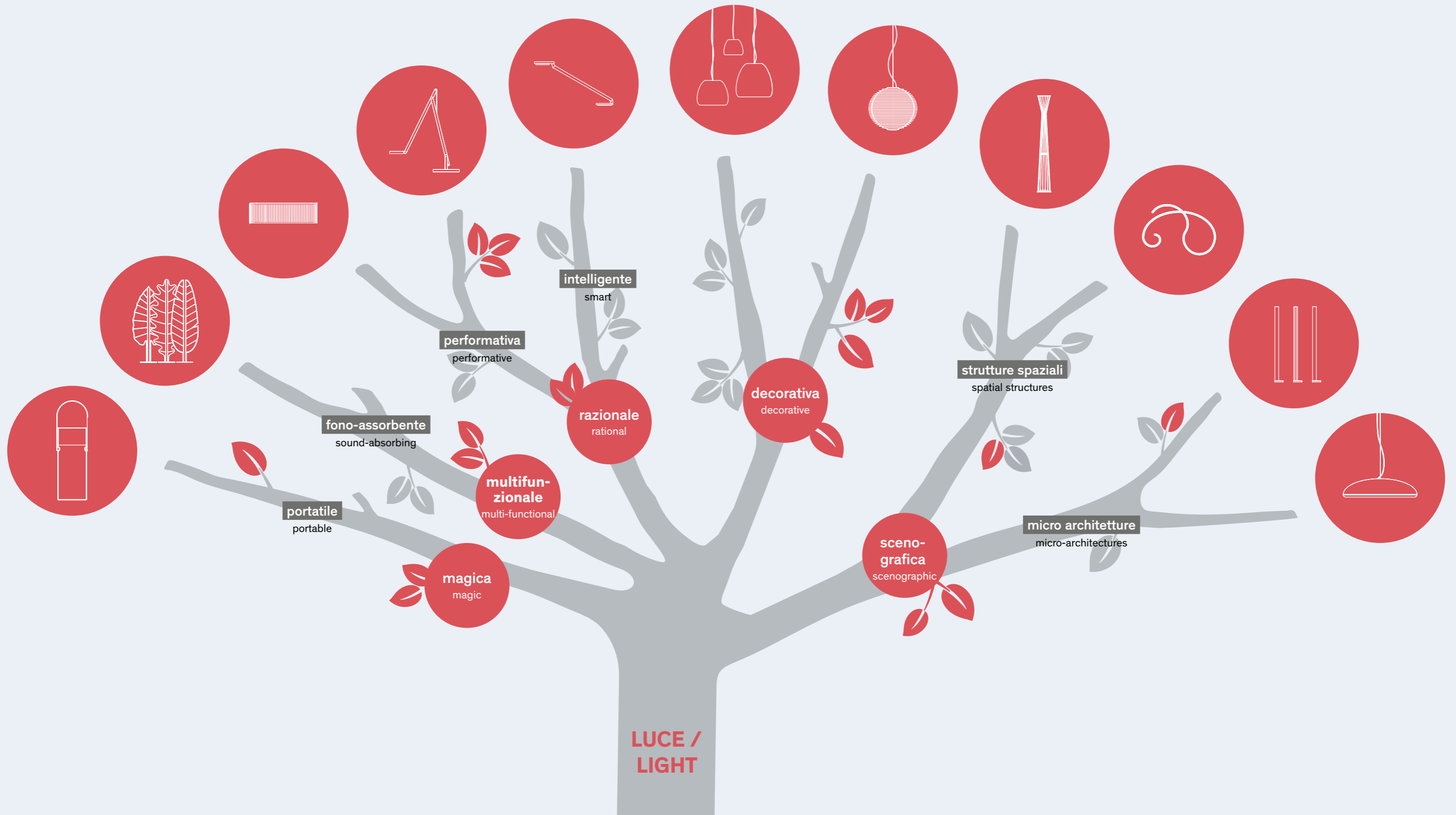



**Designer:**  
**Dante Donegani, Giovanni Lauda,**  
**Paolo Dall'Elce, Paolo Rizzatto, Andrea Branzi,**  
**Kengo Kuma, Federica Cevasco,**  
**Tommaso Tommasi**

**Dante Donegani**

020	Belvedere
026	Chiardiluna
036	Ciminiere d'Italia
050	Dina
060	Dina+
072	Drink
078	Dry
084	Eden Collection
100	Flow Glass
106	Frame
132	Ipe
140	Lightwire
144	Luxy
154	Luxy Glam
162	MultiPot+
182	Prince
212	String
220	String mini
228	String XL
236	Tick

Dante Donegani è nato a Pinzolo (Trento) nel 1957 e si è laureato in Architettura a Firenze nel 1983. Lavora dal 1987 al 1991 nella Corporate Identity Olivetti. Dal 1991 è Direttore del Master in Design di Domus Academy a Milano. Nel 1992 apre lo studio D&L con Giovanni Lauda. Disegna prodotti per varie aziende tra cui Memphis, Stildomus, Isuzu, Steel e Luceplan, Le Cose Nostre, Edra, Radice e Viceversa.

Dante Donegani was born in Pinzolo (Trento) in 1957. He earned a degree in Architecture in Florence in 1983. He worked from 1987 to 1991 for Olivetti Corporate Identity department. Since 1991 he has been the director of the master's program in design at the Domus Academy in Milan. In 1992 he opened the D&L Studio together with Giovanni Lauda. He has designed products for Luceplan, Edra, Radice, Viceversa and Rotaliana.

**Giovanni Lauda**

020	Belvedere
026	Chiardiluna
036	Ciminiere d'Italia
050	Dina
060	Dina+
066	Dresscode
072	Drink
078	Dry
084	Eden Collection
100	Flow Glass
106	Frame
132	Ipe
140	Lightwire
144	Luxy
154	Luxy Glam
162	MultiPot+
182	Prince
212	String
220	String mini
228	String XL
236	Tick
254	Venere

Giovanni Lauda è nato nel 1956 a Napoli, dove si è laureato in Architettura. Dopo aver conseguito il Master in Design alla Domus Academy di Milano, ha fatto parte dal 1988 al 1991 dello studio Morozzi & Partners. Dal 1992 al 2018 ha diretto con Dante Donegani lo studio di progettazione D&L. Ha realizzato prodotti nel settore domestico e del l'ufficio, allestimenti di mostre e allestimenti commerciali. Ha svolto attività didattica in Italia e all'estero e collaborato con numerose riviste italiane e straniere. Vive e lavora a Milano.

Giovanni Lauda was born in 1956 in Naples, Italy, where he received a degree in Architecture. After obtaining his Master in Design from the Domus Academy of Milan, he worked from 1988 to 1991 with Morozzi & Partners. From 1992 to 2018 together with Dante Donegani he directed the design firm D&L. He has created products for the home and for the office as well as exhibition and commercial installations. He has taught in Italy and abroad and has written articles for many Italian and foreign magazines. He works and lives in Milan.

**Paolo Dell'Elce**

048	Collide
170	Overlap
232	Sunset
240	Tide

Paolo Dell'Elce (1983) è un progettista specializzato in prodotto, mobile e illuminazione. Studia Disegno Industriale presso il Politecnico di Milano e la Oslo School of Architecture and Design. Il suo lavoro è stato pubblicato a livello internazionale, ha ricevuto premi e riconoscimenti tra cui un Red Dot Award: Product Design e una Menzione d'Onore al Premio Compasso d'Oro 2014, ed è stato esposto in prestigiose istituzioni come la Triennale di Milano, Museo Poldi Pezzoli di Milano, Museo dell'Ara Pacis di Roma e la Kunstraum Muenchen di Monaco. Dal 2011 al 2014 è stato responsabile del Design della storica azienda Italiana Danese Milano. Dal 2015 dirige il team di design degli arredi presso David Chipperfield Architects Milano.

Paolo Dell'Elce (1983) is an Industrial designer based in Milan, Italy specialized in furniture, lighting and product design. His work has been published internationally, has received design awards including a honorable mention for 2014 Compasso d'Oro and the Red Dot Award: Product Design, and has been exhibited in prestigious institutions as Triennale di Milano, Museo Poldi Pezzoli in Milan, Museo dell'Ara Pacis in Rome, Kunstraum Muenchen in Munich. From 2011 to 2014 he was Creative Director of historic Italian company Danese Milano. From 2015 he leads the furniture design team at David Chipperfield Architects in Milan.

## Paolo Rizzatto



094 Febo  
176 Pomi  
190 Squiggle

Paolo Rizzatto, nato a Milano nel 1941, laureato in Architettura al Politecnico di Milano nel 1965. Nel 1978 ha fondato con Riccardo Sarfatti la società Luceplan. Ha disegnato per diverse società italiane e straniere: Alias, Artemide, Cassina, Danese, Diade, Fiam, Flos, Ghidini1961, Knoll, Kartell, Lensvelt, Luceplan, Molteni, Montina, Nemo, Philips, Poltrona Frau, Segis, Serralunga, Thonet, Veneta Cucine. I suoi lavori sono stati pubblicati in riviste, cataloghi e pubblicazioni in Italia e all'estero e sono inclusi nelle collezioni permanenti di numerosi musei e fondazioni: Triennale di Milano, Museum of Modern Art a New York, Victoria and Albert Museum a Londra, Museo della Scienza e della Tecnica a Milano, Musée des Arts Decoratifs a Parigi. Ha ricevuto numerosi premi, fra cui si possono ricordare Cinque Premi "Compasso d'oro" 1981, 1989, 1995, 2008 e 2011.

Paolo Rizzatto was born in 1941 in Milan, where he took a degree at the Polytechnic in 1965. In 1978 he founded Luceplan together with Riccardo Sarfatti. In his studio he works in the fields of architecture, interior design, light and product design, collaborating with companies like Alias, Artemide, Cassina, Fiam, Ghidini1961, Lensvelt, Luceplan, Molteni, Montina, Knoll, Kartell, Philips, Poltrona Frau, Serralunga, Thonet, Veneta Cucine. His works are part of the permanent collections of many museums, including Victoria and Albert Museum (London), MOMA (New York), Centre Pompidou (Paris) and Permanent Collection of Design at Triennale (Milan). He has received many prizes and honors, among which five "Compasso d'oro" ADI / Milan 1981, 1989, 1995, 2008 and 2011.

## Andrea Branzi



120 Goccia

Andrea Branzi, architetto e designer, è nato a Firenze nel 1938, dove si è laureato nel 1967. Vive e lavora a Milano. Dal 1964 al 1974 ha fatto parte del gruppo Archizoom Associati, primo gruppo di avanguardia noto in campo internazionale, i cui progetti sono oggi conservati presso il Centro Studi e Archivio della Comunicazione dell'Università di Parma e dal CCI del Centre Georges Pompidou di Parigi. Dal 1967 si occupa di design industriale e sperimentale, architettura, progettazione urbana, didattica e promozione culturale. È Docente di Disegno Industriale al Politecnico di Milano.

Andrea Branzi, architect and designer, was born in 1938 in Florence, where he earned a degree in 1967. He currently lives and works in Milan. From 1964 to 1974, he was part of the Archizoom Associati group, the first avant-garde design studio on the international scene, whose projects are now conserved by the University of Parma at its Study and Archive Centre for Communication and by CCI at the Georges Pompidou Centre in Paris. Since 1967, Andrea Branzi has been engaged in industrial and experimental design, architecture, urban design, teaching and cultural promotion. He is a teacher of industrial design at the Polytechnic Institute of Milan.

## Kengo Kuma



114 Furin

Kengo Kuma è nato nel 1954. Si è laureato in architettura presso l'Università di Tokyo nel 1979. Dal 1985 al 1986, ha studiato alla Columbia University come Visiting Scholar. Ha fondato lo studio Kengo Kuma & Associates nel 1990. Ha insegnato presso la Keio University 2001–2008, University of Illinois at Urbana-Champaign nel 2008 e nel 2009, è stato nominato professore ordinario presso la Graduate School of Architecture, University of Tokyo. È stato premiato con l'International Spirit of Nature Wood Architecture Award nel 2002 (Finlandia), l'International Architecture Awards for the Best New Global Design per "Chokkura Plaza e Shelter" nel 2007.

Kengo Kuma was born in 1954. He completed his master's degree at the University of Tokyo in 1979. From 1985 to 1986, he studied at Columbia University as Visiting Scholar. He established Kengo Kuma & Associates in 1990. He taught at Keio University from 2001 to 2008, University of Illinois at Urbana-Champaign in 2008, and in 2009, he was installed as Professor at the Graduate School of Architecture, University of Tokyo. He was awarded the International Spirit of Nature Wood Architecture Award in 2002 (Finland), International Architecture Awards for the Best New Global Design for "Chokkura Plaza and Shelter" in 2007.

## Federica Cevasco



186 QB

Federica Cevasco è nata a Milano dove vive e lavora. Ha studiato al Politecnico di Milano e all'ENSBA, École nationale supérieure des beaux-arts di Lione. Nel 2009 si laurea in interior design. Si occupa di progettazione di architettura di interni, allestimenti, disegno industriale e grafica. Ha svolto attività didattica presso la NABA Nuova accademia di belle arti e ha collaborato alla realizzazione di eventi della rivista Domus. Dal 2014 lavora nello studio dell'architetto Michele De Lucchi come project architect.

Federica Cevasco was born in Milan, where she lives and works. She studied at Politecnico di Milano and at ENSBA, École nationale supérieure des beaux-arts in Lyon. In 2009 she graduated in interior design. She is specialized in interior, product and graphic design. She taught at NABA Nuova accademia di belle arti and she collaborated on the events of Domus magazine. From 2014 she works in Michele De Lucchi studio as project architect.

## Tommaso Tommasi



244 Tobu

L'architetto Tommaso Tommasi ha 38 anni e si è laureato in architettura presso lo IUAV nel 2012. Nel 2016 è entrato a far parte dello studio Architettura Tommasi nato alla fine degli anni '70 a Saccolongo in provincia di Padova ad opera di suo padre, l'architetto Gianni Tommasi. Oggi Architettura Tommasi vanta preziose collaborazioni e interventi che spaziano dall'ambito residenziale a quello direzionale, dal restauro di complessi monumentali al retail, dalla pianificazione territoriale allo studio dell'arredo urbano. La collaborazione con professionisti che approfondiscono gli aspetti storici-ambientali ha permesso di formare un team completo in grado di fornire progettazioni approfondite e complete in tutti i settori che interessano l'edilizia.

Tommaso Tommasi is a 38-year-old architect who graduated with an Architecture Degree from IUAV University in 2012. In 2016, he joined Architettura Tommasi, an architectural firm set up in the late 1970s in Saccolongo, Padua, by his father, architect Gianni Tommasi. At present, Architettura Tommasi boasts valuable collaborations and projects ranging from residential to executive architecture, from the restoration of monumental complexes to retail, and from regional planning to the study of street furniture. The collaboration with professionals specialising in historical and environmental architecture has made it possible to create a comprehensive team capable of providing thorough and all-embracing designs in all sectors of the construction industry.

**The Collection:  
Belvedere, Chiardiluna,  
Ciminiere d'Italia, CM2, Collide,  
Dina, Dina+, Dresscode, Drink, Dry,  
Eden Collection, Febo, Flow Glass,  
Frame, Furin, Goccia, InOut, Ipe, Lightwire,  
Luxy, MultiPot+, Overlap, Pomi,  
Prince, QB, Squiggle, String,  
Sunset, Tick, Tide,  
Tobu, Venere.**

# Belvedere

Dante Donegani & Giovanni Lauda  
2009 / 2011 / 2013

IT – Lampada da parete caratterizzata da una struttura in alluminio pressofuso. La forma, leggera ed essenziale come un anello, permette un flusso luminoso che si sviluppa sia verso l'alto che verso il basso.

EN – Wall lamp featuring a die-cast aluminium structure. Its slender and essential ring shape allows the light to flow both upwards and downwards.

DE – Wandleuchte mit Struktur aus Aluminium-Druckguss. Die Form ist so leicht und schlicht wie ein Ring und gestattet die Abstrahlung des Licht sowohl nach oben als auch nach unten.

FR – Lampe murale, caractérisée par une structure en aluminium moulé sous pression. Sa forme, légère et dépouillée, semblable à un anneau, fournit un flux lumineux qui se développe aussi bien vers le haut que vers le bas.

ES – Aplique caracterizado por una estructura de aluminio moldeado a presión. Su forma, ligera y esencial como un anillo, permite un flujo luminoso que se desarrolla tanto hacia arriba como hacia abajo.



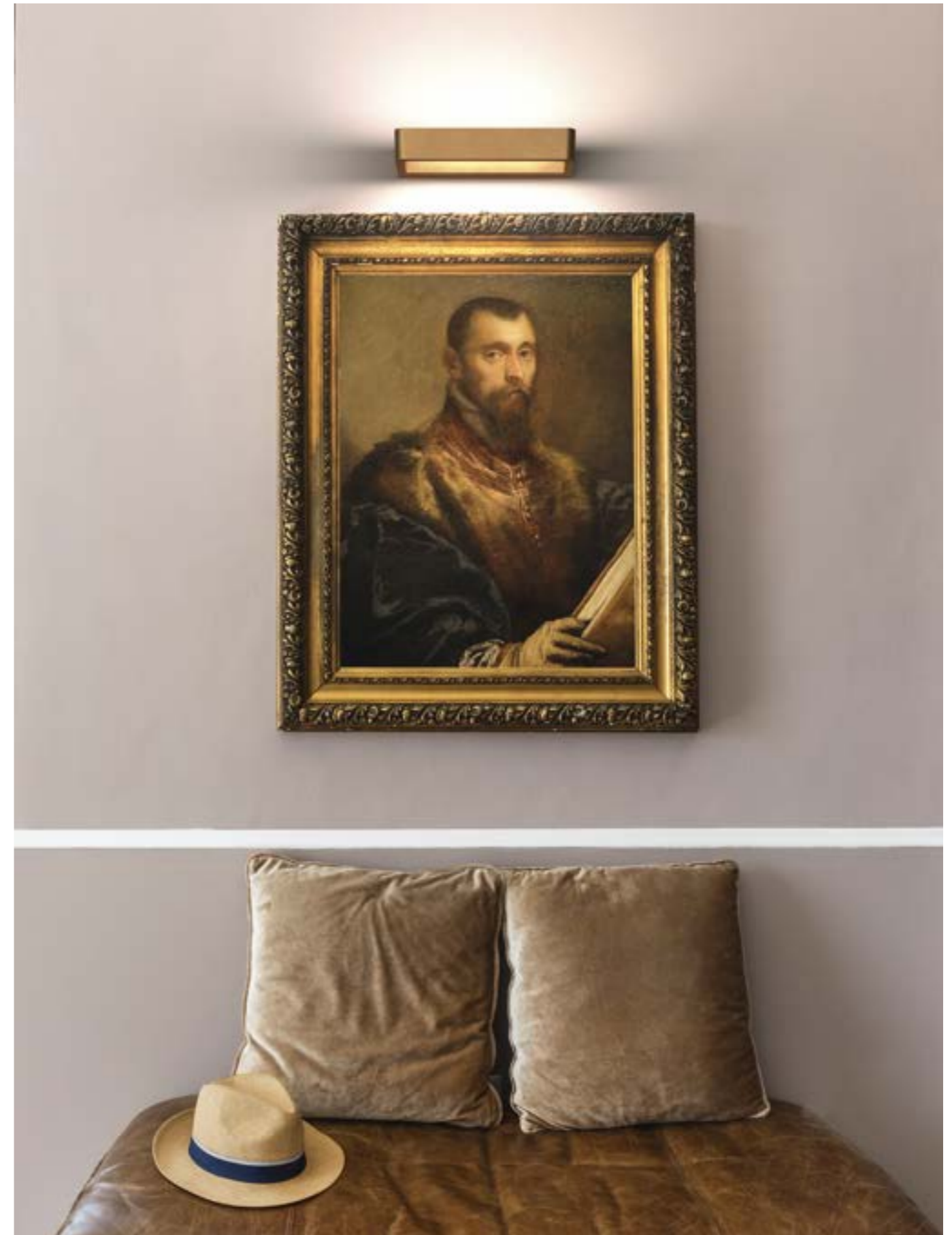

# Belvedere



Belvedere: Wall

cod: W1, W2

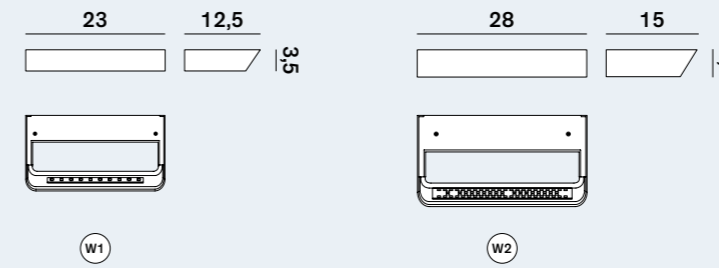

up and down

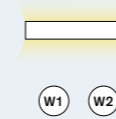

Light Source	MID POWER LED
Power (W1)	14 Watt
Power (W2)	29 Watt
Kelvin	2.700, 3.000
Dimmer (W2)	phase, dali
Lumen (W1)	1.400
Lumen (W2)	3.200
CRI	90

Catalogue

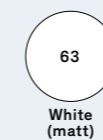

Satin Collection (upon request)



Kerakoll Warm Collection (upon request)



# Chiardiluna

Dante Donegani & Giovanni Lauda  
2019

**IT – È una lampada portatile da utilizzare in interno o all'esterno. Chiardiluna è composta da un vetro soffiato in borosilicato in cui è alloggiato un "tappo" luminoso e da un manico smontabile in acciaio e plastica. La luce LED si distribuisce delicatamente –come la luce della luna piena– sul piano di appoggio della lampada: un tavolo per una cena al ristorante, il percorso di un giardino, il pavimento di un terrazzo. Il "tappo" luminoso è rimovibile ed è alimentato da batterie ricaricabili utilizzando la basetta per la ricarica wireless; sul coperchio è inserito un interruttore / dimmer a sfioro. All'interno del contenitore in vetro è possibile inserire un piccolo oggetto personale (una conchiglia, un rametto, un sasso, ecc.).**

**EN – This is a portable lamp to be used indoors or outdoors. Chiardiluna is made of a blown borosilicate glass containing a luminous 'stopper' and has a removable steel and plastic handle. The LED light diffuses delicately – like the light of the full moon – onto the lamp's supporting surface, such as a restaurant table, the path through a garden, the floor of a terrace. The luminous 'stopper' can be removed and is powered by batteries that can be recharged using the wireless phone charging pad; the cover contains a touch-sensitive switch / dimmer. Inside the glass container it is possible to insert a small personal object (a shell, a twig, a stone, etc.).**

**DE – Es handelt sich um eine tragbare Lampe, die für den Einsatz in Innenräumen oder im Freien angeboten wird. Chiardiluna besteht aus einem Lichtschirm aus geblasenem Borosilikatglas, in dem ein leuchtender, Stöpsel untergebracht ist, und aus einem abnehmbaren Griff aus Stahl und Kunststoff. Das LED-Licht verteilt sich – wie das Licht des Vollmonds – auf der Auflagefläche der Lampe: Ein Tisch für ein Abendessen im Restaurant, der Pfad eines Gartens, der Boden einer Terrasse. Der leuchtende "Stöpsel" ist abnehmbar und wird durch Batterien gespeist, die an dem Wireless-Ladesockel wiederaufgeladen werden können. Auf dem Deckel ist ein Touch-Schalter / –Dimmer vorgesehen. Im Innern des Glasgehäuses können Sie ein kleines persönliches Objekt (eine Schale, einen Zweig, einen Stein usw.) einfügen.**

**FR – C'est une lampe portative pour l'intérieur ou l'extérieur. Chiardiluna est faite d'un verre soufflé en borosilicate, où est logé un "bouchon" lumineux, ainsi que d'un manche démontable en acier et en plastique. La lumière de la diode électroluminescente se distribue délicatement – comme la lueur de la pleine lune – sur le plan d'appui de la lampe: une table pour un dîner au restaurant, un parcours dans un jardin, le sol d'une terrasse. Le "bouchon" lumineux est amovible et s'alimente à l'aide de batteries rechargeables en utilisant la base de recharge sans fil; un interrupteur / gradateur de lumière à effleurement est placé sur le couvercle. À l'intérieur du récipient en verre, il est possible d'introduire un petit objet personnel (une coquille, un rameau, une pierre, etc.).**

**ES – Lámpara portátil para utilizar en interiores o exteriores. Chiardiluna está compuesta por un vidrio soplado de borosilicato en el cual está alojado un "tapón" luminoso y un mango desmontable de acero y plástico. La luz LED se distribuye delicadamente –como la luz de la luna llena– sobre el plano de apoyo de la lámpara: la mesa de un restaurante, el sendero de un jardín, el piso de una terraza. El "tapón" luminoso removible está alimentado con baterías que se pueden recargar en la base de recarga inalámbrica. La cubierta contiene un interruptor / dimmer táctil. Dentro del contenedor de vidrio se puede insertar un pequeño objeto personal (una conchilla, una rama pequeña, una piedra...).**









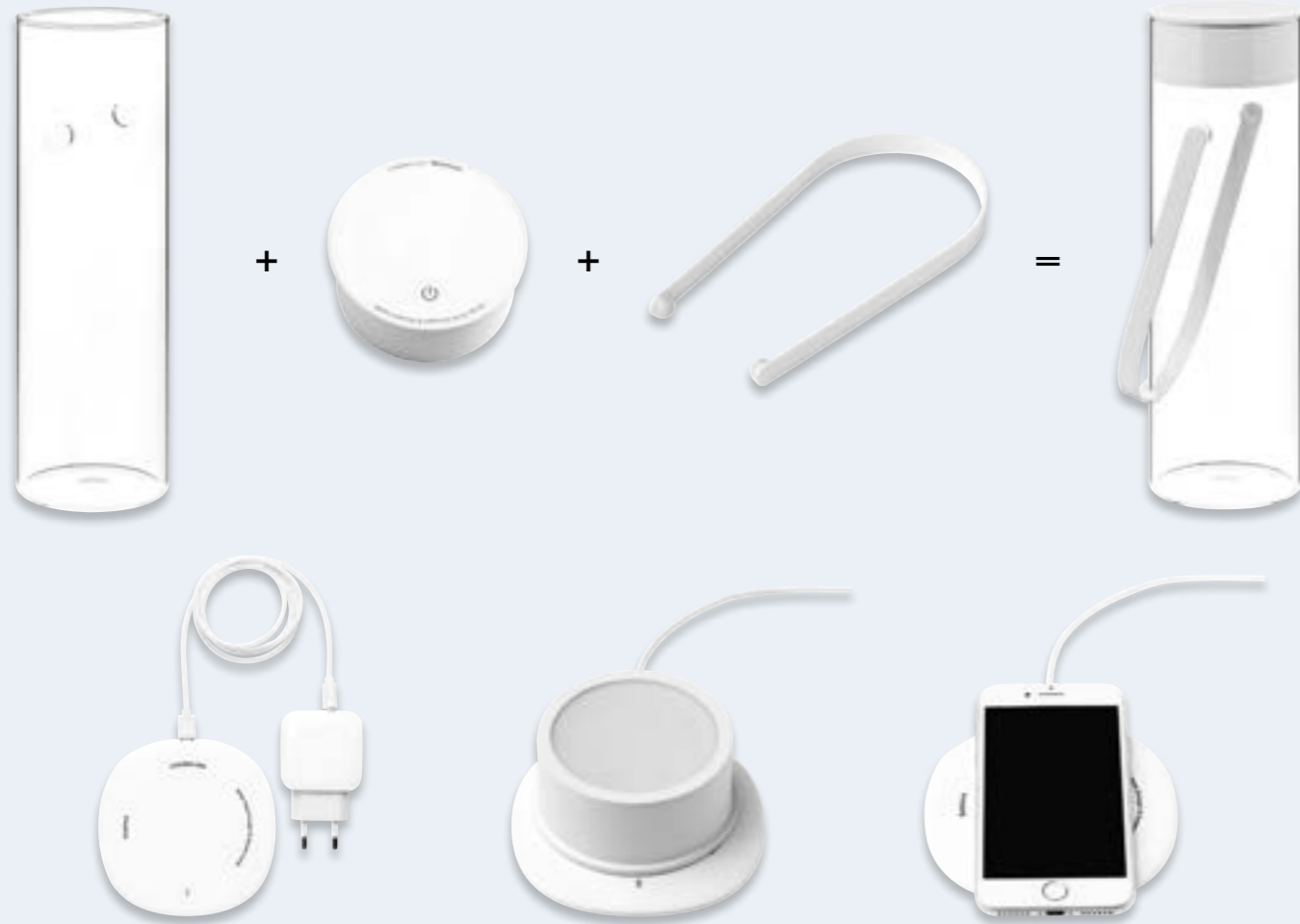

IT – La base si ricarica “wireless” ad induzione elettromagnetica può essere usata anche per la ricarica di tutti gli smartphone che utilizzano questa nuova tecnologia.

EN – The “wireless” electromagnetic induction charging base can also be used for charging all smartphones that use this new technology.

DE – Die “wireless” elektromagnetische Induktionladestation kann auch zum Laden aller Smartphones verwendet werden, die über diese neue Technologie verfügen.

FR – La base de charge à induction électromagnétique “wireless” peut également être utilisée pour charger tous les smartphones utilisant cette nouvelle technologie.

ES – La base de carga de inducción electromagnética sin cables también se puede utilizar para cargar todos los teléfonos inteligentes que utilizan esta nueva tecnología.

Design  
Donegani & Lauda

Year  
19

Category: Table

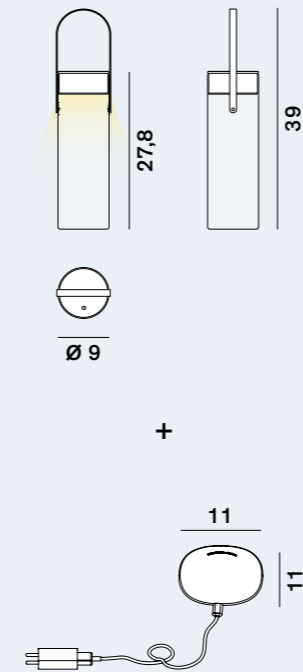

Light Source	MID POWER LED
Power max	3,3 Watt
Kelvin	2.700
Dimmer	touch 3 steps
Lumen	260/190/130
IP	44
CRI	90

Wireless charger + transformer  
included

#### Battery life

Light	100%	6 hours	3,3W
Light	70%	9 hours	2,2W
Light	40%	15 hours	1,4W

#### Lampada / Lamp

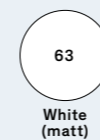

63

White  
(matt)

#### Maniglie / Handles

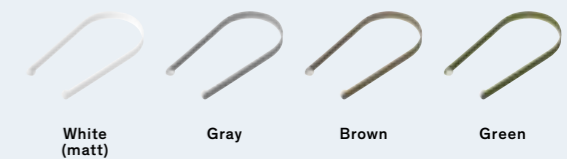
White  
(matt)

Gray

Brown

Green

# Illuminance

IT – Chiardiluna, grazie all'impiego di LED ad alta efficienza ed un pacco batterie di ben 6000mAh, garantisce (come evidenziato nel grafico e tabella della pagina a fianco), livelli di illuminamento (lux) i più performanti rispetto alle lampade da tavolo presenti sul mercato. Al 40% della sua emissione offre all'utente ancora un ottimo flusso accompagnato da una durata della batteria di ben 15 ore.

EN – Chiardiluna, thanks to the use of high-efficiency LEDs and a 6000mAh battery pack, guarantees (as shown in the graph and table on the opposite page), the highest performing lighting levels (lux) compared to the table lamps on the market. At 40% of its emission it still offers the user an excellent flow accompanied to a battery life of up to 15 hours.

DE – Dank der Verwendung von Hochleistungs-LEDs und eines 6000-mA-Akkupacks (siehe Grafik und Tabelle auf der nächsten Seite) garantiert Chiardiluna die höchste Beleuchtungsstärke (Lux) im Vergleich zu anderen Tischleuchten auf dem Markt. Auch bei 40% der Leistung bietet sie dem Benutzer eine hervorragende Lichtleistung und eine Lebensdauer der Akku bis zu 15 Stunden.

FR – Chiardiluna, grâce à l'utilisation LED à haute efficacité et à un bloc batterie 6000mAh, garantit (voir le graphique et le tableau de la page opposée) les niveaux d'éclairage les plus performants (lux) par rapport aux lampes de table du marché. À 40% de ses émissions, il offre toujours à l'utilisateur un excellent débit accompagné d'une autonomie pouvant atteindre 15 heures.

ES – Chiardiluna, gracias al uso de LED de alta eficiencia y una batería de 6000 mAh, garantiza (como se muestra en el gráfico y la tabla en la página opuesta), los niveles de iluminación (lux) de mayor rendimiento en comparación con las lámparas de mesa en el mercado. Al 40% de su emisión, todavía ofrece al usuario un flujo excelente acompañado de una duración de la batería de hasta 15 horas.

Rotaliana

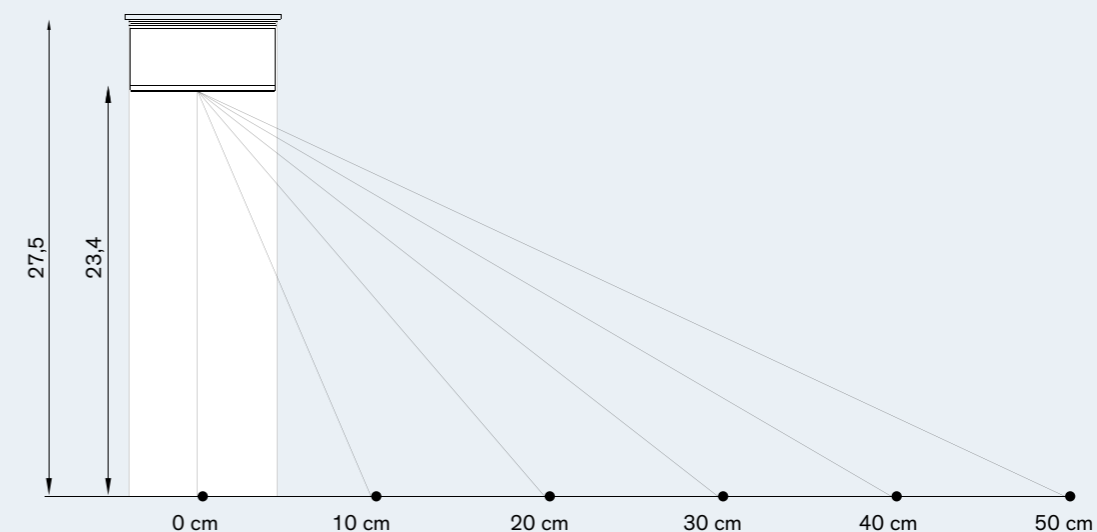

Illuminamento / Illuminance / Beleuchtungsstärke / Éclairage / Iluminancia [Lux]			
Distanza [cm] Distance [cm]	40%	70%	100%
0	1.046	1.630	2.280
10	586	921	1307
20	229	365	525
30	97	157	225
40	45	73	108
50	24	39	53

# Ciminiere d'Italia

Dante Donegani & Giovanni Lauda  
2011 / 2019

IT – È una famiglia di lampade da terra a luce indiretta. L'ingombro ridotto della sorgente LED consente di ottenere delle lampade molto sottili e slanciate che ricordano, nelle proporzioni e nelle finiture cromatiche, le ciminiere industriali. Le Ciminiere d'Italia sono proposte in tre varianti (a sezione circolare, quadrata ed ottagonale) e con differenti finiture per adattarsi a qualsiasi ambiente. Sono dotate di una nuova elegante base in pressofusione di alluminio dalle finiture bianco o ottone lucido e di una nuova elettronica LED che garantisce una maggiore intensità luminosa (4.000 lumen).

EN – It's a family of indirect light floor lamps. The small size of the LED light source allows to make very thin and svelte lamps that with their proportions and chromatic finish remind one of factory smokestacks. The Ciminiere d'Italia lamps are available in three different models (with a circular, square or hexagonal cross-section) and with various kinds of finish so as to adapt to any kind of décor. They have a new elegant base made of die-cast aluminum finished with white or polished brass, and new LED-based electronics that ensures greater light intensity (4.000 lumen).

DE – Eine Produktfamilie von Stehlampen mit indirektem Licht. Die geringe Größe des LED-Leuchtmittels ermöglicht es, sehr dünne und schlanke Lampen zu erhalten, die in ihren Proportionen und farblichen Gestaltungen an Industrieschornsteine erinnern. Die Ciminiere d'Italia ("Schornsteine Italiens") werden in drei Ausführungen (mit kreisförmigen, quadratischen und achteckigen Querschnitten) und mit verschiedenen Oberflächen angeboten, um in jedes Ambiente passen zu können. Sie sind mit einem neuen eleganten Sockel aus Aluminiumdruckguss mit poliertem Weiss- und Messingfinish sowie einer neuen LED-Elektronik ausgestattet, die eine höhere Lichtstärke (4.000 Lumen) garantiert.

FR – C'est une série de lampadaires conçus pour une lumière indirecte. L'encombrement réduit de la source à LED permet d'obtenir des lampes très minces et élancées qui rappellent des cheminées industrielles, comme proportions et finitions chromatiques. Les Ciminiere d'Italia existent en trois versions (de forme circulaire, carrée et octogonale) et avec diverses finitions permettant de les adapter à tout environnement. Elles sont munies d'une nouvelle base élégante en aluminium moulé sous pression, avec des finitions en blanche et en cuivre brillant et un nouvel équipement électronique à LED garantissant plus d'intensité lumineuse (4.000 lumens).

ES – Familia de lámparas de pie de luz indirecta. El volumen reducido de la fuente LED permite obtener lámparas muy sutiles y esbeltas que recuerdan, en las proporciones y los acabados cromáticos, a las chimeneas industriales. Las Ciminiere d'Italia se proponen en tres variantes (con sección circular, cuadrada y octogonal) y con diferentes acabados para adaptarse a cualquier ambiente. Están dotadas de una nueva y elegante base de aluminio fundido, con acabados blanco y latón bruñido, y una nueva electrónica LED que garantiza una mayor intensidad luminosa (4.000 lúmenes).

Focus  
Le Ciminiere d'Italia



A

## Le Ciminiere d'Italia

Le ciminiere fanno parte del paesaggio italiano così come i campanili, le torri, le cupole, i tetti dei casolari... Sono segni carichi di storia, ricordi di progressi civili e conquiste sociali. Alcune ciminiere sono ancora in funzione, simbolo di un made in Italy operoso e competitivo. Molte ciminiere invece sono spente, perché in conflitto con le convenienze economiche e la salvaguardia dell'ambiente. Sono le testimoni mute di un passaggio epocale che assiste alla fine della modernità, in attesa di un mondo nuovo che verrà. Un mondo che non brucia, non fuma e non inquina e sostituisce le ciminiere con le pale eoliche e le Silicon Valley. Un mondo al cui centro non c'è più la fabbrica e in cui il design non si chiama più industrial design. Dal finestrino dell'auto o del treno il nostro sguardo distratto si volge su di loro. Spente o fumanti, in mattoni o in calcestruzzo, cerchiare di rosso o decorate a scacchi bianchi e neri, svettano come colonne antiche nei paesaggi di Brescia est, Metanopoli, Taranto o Bagnoli. Sono belle anche in miniatura, archeologie o giocattoli da salotto, utilizzate come camini di luce generata da potenti LED che risparmiano energia, per rischiarare le nostre case e illuminare le nostre memorie.

Giovanni Lauda

Smokestacks are a constant of the Italian landscape as much as bell-towers, cupolas and the roofs of country houses are... They are signs steeped in history, mementoes of civil progress and of social conquest. Some smokestacks are still in operation, symbolising the busy and competitive Made in Italy spirit. Many smokestacks instead have been abandoned, because they clash with economic convenience and with environmental protection. They are the mute witnesses of an epochal passage that sees the end of modernity, waiting for the new world that will come, a world that does not burn, does not smoke and does not pollute, replacing smokestacks with wind farms and Silicone valleys. A world at the centre of which there no longer stands the factory, and in which design is no longer called industrial design. Through the windows of cars or trains, our distracted gaze turns to them. Turned off or smoking, made of bricks or of cement, ringed in red or chequered black and white, they rise like ancient columns above the scenery in Eastern Brescia, Metanopoli, Taranto or Bagnoli. They are beautiful even when miniaturised, like living room archeologies or toys, used as chimneys of light generated by powerful LEDs that save energy, to light up our homes and illuminate our memories.



DE – Die Schornsteine sind Teil der italienischen Landschaft ebenso wie die Kirchtürme, die Türme, die Kuppeln, die Dächer der Bauernhäuser... Sie sind markante historische Bauten, die auf technischen Fortschritt und soziale Errungenschaften verweisen. Einige Schornsteine sind noch in Betrieb, Symbol für ein leistungsstarkes und wettbewerbsfähiges Made in Italy. Andererseits sind viele Schornsteine stillgelegt, weil sie mit wirtschaftlichem Nutzen und Umweltschutz in Konflikt stehen. Sie sind die stummen Zeugen einer Zeitenwende, die das Ende der Moderne besiegelt und den Weg für eine neue Welt freimacht. Einer Welt, die nicht brennt, nicht raucht, nicht verschmutzt und Schornsteine durch Windkraftanlagen und Silicon Valleys ersetzt. Eine Welt, in deren Mittelpunkt sich nicht mehr die Fabrik befindet und in der Design nicht mehr für Industriedesign steht. Unser abgelenkter Blick wendet sich zu ihnen aus dem Auto- oder Zugfenster. Still oder rauchend, in Ziegeln oder Beton, rot eingekreist oder im schwarzweißen Schachbrettmuster gestaltet, heben sie sich wie antike Säulen in den Landschaften von Brescia Ost, Metanopoli, Tarant oder Bagnoli ab. Schön anzusehen sind sie auch in Miniatur, als archäologische oder spielerische Objekte für das Wohnzimmer, die als Lichtkamine mit leistungsstarken und energiesparenden LEDs unsere Häuser beleuchten und unsere Erinnerungen erhellen.

FR – Les cheminées font partie du paysage italien, tout comme les clochers, les tours, les coupoles, les toits de fermes, tous éléments imprégnés d'histoire, en tant que souvenirs du progrès civil et symboles de luttes sociales. Quelques cheminées sont encore en marche, comme représentantes d'un Made in Italy fait de travail et de compétitivité. Mais beaucoup de cheminées sont éteintes, car contraires aux intérêts économiques et à la sauvegarde de l'environnement. Ce sont des témoins muets de la fin d'une époque, de la modernité, dans l'attente de l'apparition d'un nouveau monde. Un monde qui ne brûle pas, qui ne fume pas, qui ne pollue pas et qui remplace les cheminées par des éoliennes et des Silicon Valleys. Un monde dont le centre n'est

plus l'usine et où le design ne s'appelle plus 'industrial design'. On leur accorde un regard distrait par la vitre d'une auto ou d'un train. Éteintes ou fumantes, en briques ou en béton, cerclées de rouge ou recouvertes de carreaux noirs et blancs, elles s'élèvent comme des colonnes antiques dans les paysages des alentours de Brescia, Metanopoli, Tarante ou Bagnoli. Elles sont belles également en miniature, comme éléments archéologiques ou comme jouets, à utiliser comme des cheminées de lumière venant de LED puissantes et permettant des économies de courant, en mesure d'éclairer nos maisons, et d'illuminer nos mémoires.

ES – Las chimeneas forman parte del paisaje italiano, así como los campanarios, las torres, las cúpulas, los techos de las casas de campo... Son signos cargados de historia, recuerdos de progresos civiles y conquistas sociales. Algunas chimeneas aún funcionan, como símbolo de un made in Italy laborioso y competitivo. En vez, muchas chimeneas están fuera de servicio porque entran en conflicto con conveniencias económicas y el cuidado del medio ambiente. Son testigos mudos de un cambio histórico que asiste al fin de la modernidad, a la espera de un mundo nuevo por llegar. Un mundo que no quema, no produce humo y no contamina, y sustituye las chimeneas con palas eólicas y los Silicon Valleys. Un mundo en el centro del cual ya no está la fábrica y en el cual el diseño se ha dejado de llamar industrial design. Desde la ventanilla del coche o del tren, nuestra mirada distraída se fija en ellas. Apagadas o echando humo, de ladrillos u hormigón, con franjas rojas o con decoración tipo tablero de ajedrez blanco y negro, se elevan como columnas antiguas en los paisajes de Brescia Este, Metanopoli, Taranto o Bagnoli. Son bellas incluso en miniatura, como objetos arqueológicos o juguetes de salón, utilizadas como hogares con la luz generada por potentes LEDs que ahorran energía, para iluminar nuestras casas y nuestra memoria.





# Ciminiere d'Italia

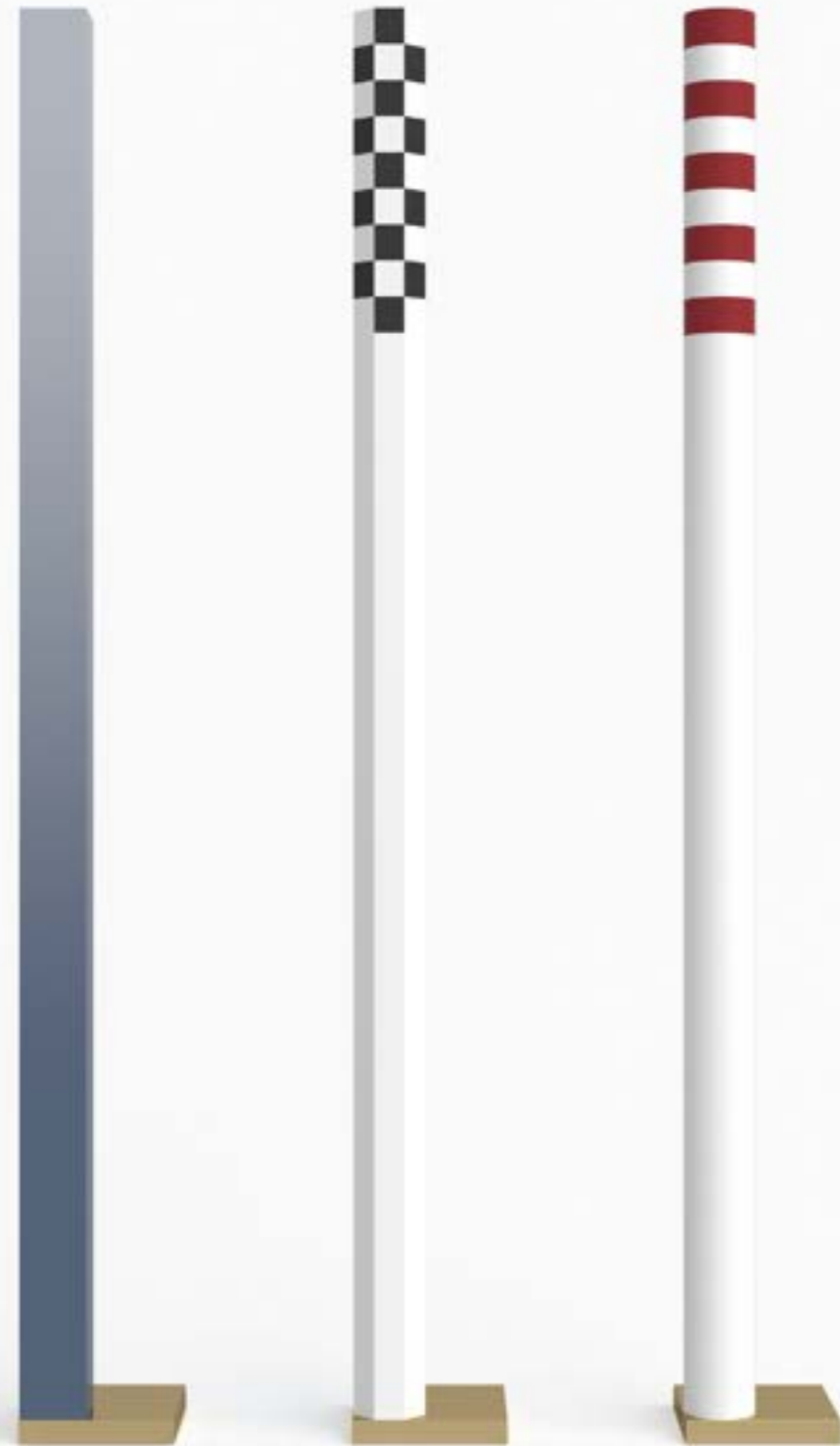

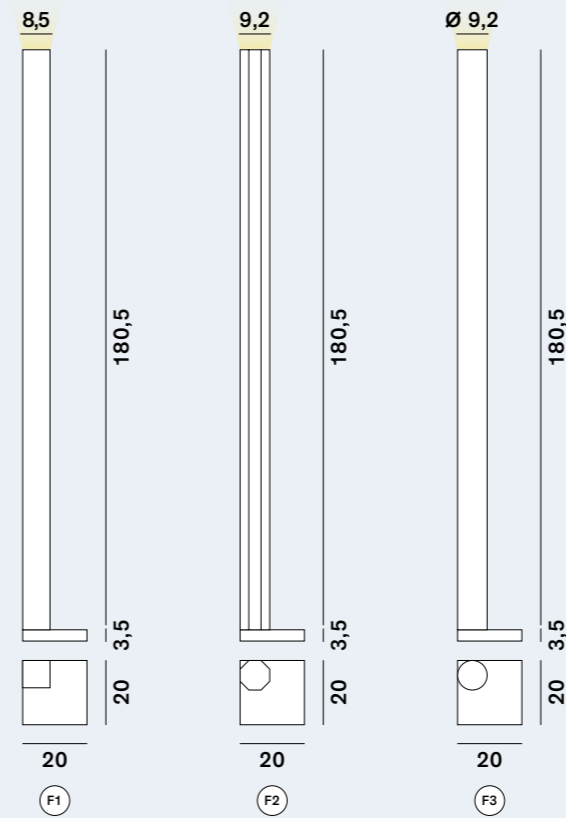

Ciminiere d'Italia: Floor

cod: F1, F2, F3



Light Source	COB LED
Power	36 Watt
Kelvin	3.000
Dimmer	foot
Lumen	4.000
CRI	90

-  Sezione quadrate / Square section
-  Sezione ottagonale / Octagonal section
-  Sezione tonda / Round section

### Catalogue

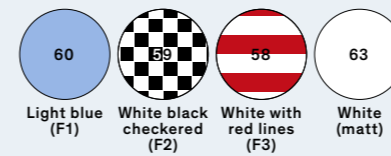

Light blue (F1)   White black checkered (F2)   White with red lines (F3)   White (matt)



# CM2

R.T.D.  
2019

IT – In uno spessore di soli 2 centimetri è contenuta un'elettronica super piatta che comanda una scheda LED (con protocollo push e dali) con 3.400 lumen di potenza.

EN – In a thickness of just 2 centimeters lies a super-flat electronic chip that commands a LED card (with dali and push protocol) with an output of 3.400 lumen.

DE – In einer Höhe von nur 2 Zentimetern ist eine superflache Elektronik enthalten, die eine LED-Platine (mit Push- und Dali-Protokoll) mit 3.400 Lumen Leistung steuert.

FR – Sur une épaisseur de 2 cm à peine, un élément électronique ultra plat commande une carte à diode électroluminescente (avec protocole 'push' et 'dali') faisant 3.400 lumens de puissance.

ES – En un espesor de solamente 2 centímetros se aloja una electrónica súper plana que controla una placa LED (con protocolos PUSH y DALI), con 3.400 lúmenes de potencia.





CM2



CM2: Wall

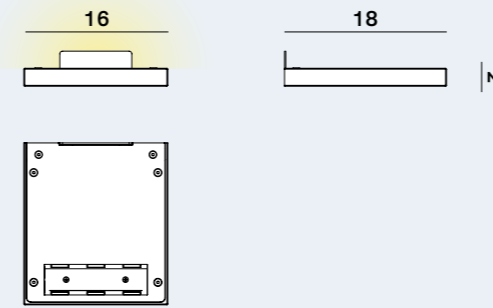

cod: W1

Light Source	MID POWER LED
Power	15 Watt
Kelvin	2.700, 3.000
Lumen	1.770
CRI	90

CM2: Wall

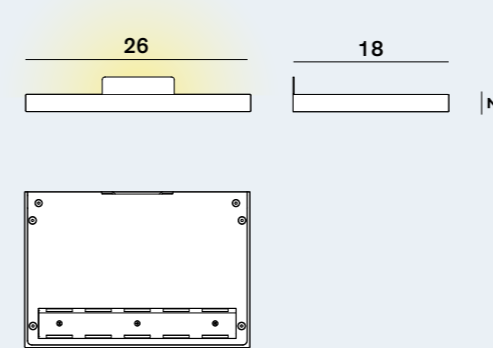

cod: W2

Light Source	MID POWER LED
Power	29 Watt
Kelvin	2.700, 3.000
Dimmer	push, dali
Lumen	3.400
CRI	90

Catalogue

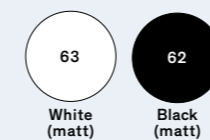

Satin Collection (upon request)



Kerakoll Warm Collection (upon request)



# Collide

Paolo Dell'Elce  
2015 / 2017

IT – Interamente realizzata in alluminio, Collide offre un'emissione di luce indiretta ed è utilizzabile sia a parete che a soffitto. La sua forma rappresenta una naturale estensione delle sorgenti luminose utilizzate: uno, due o tre circuiti LED circolari a tensione di rete.

EN – Entirely made of aluminium, Collide emits indirect light and can be mounted both on a wall and the ceiling. Its shape represents a natural extension of the light sources used: one, two or three circular LED circuits with mains voltage.

DE – Vollständig aus Aluminium realisiert, strahlt Collide indirektes Licht ab und kann sowohl an der Wand als auch an der Decke installiert werden. Ihre Form spiegelt auf natürliche Weise die verwendeten Lichtquellen wider: ein, zwei oder drei kreisrunde LED-Kreise mit Netzspannung.

FR – Entièrement en aluminium, Collide présente une émission de lumière indirecte et peut être utilisée aussi bien au plafond que sur le mur. Sa forme représente un prolongement naturel des sources lumineuses utilisées : un, deux ou trois circuits LED circulaires à la tension du réseau.

ES – Realizada totalmente de aluminio, Collide ofrece una iluminación indirecta y puede utilizarse tanto en la pared como en el techo. Su forma representa una extensión natural de las fuentes luminosas utilizadas: uno, dos o tres circuitos de LEDs circulares de tensión de red.





# Collide



Collide: Ceiling / Wall

cod: H0, H1, H2, H3

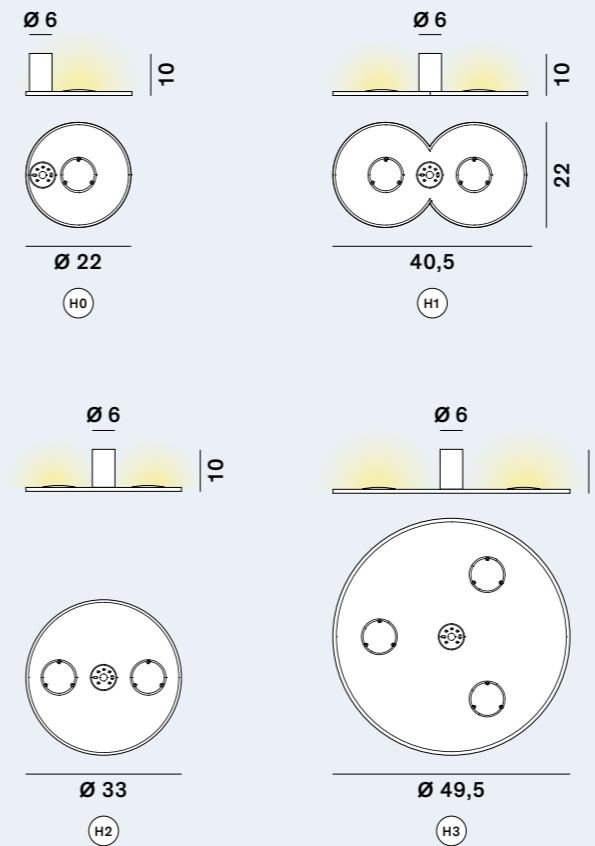

Light Source	ACRICHE HV LED
Power <sup>H0</sup>	17 Watt
Power <sup>H1</sup> <sup>H2</sup>	34 Watt
Power <sup>H3</sup>	51 Watt
Kelvin	2.700, 3.000
Dimmer	phase
Lumen <sup>H0</sup>	1.700
Lumen <sup>H1</sup> <sup>H2</sup>	3.400
Lumen <sup>H3</sup>	5.100
CRI	90

Catalogue

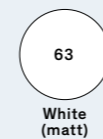

63  
White (matt)

Satin Collection (upon request)

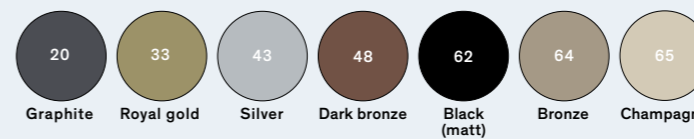

20 Graphite 33 Royal gold 43 Silver 48 Dark bronze 62 Black (matt) 64 Bronze 65 Champagne

Kerakoll Warm Collection (upon request)



W2 Sand W4 Rope color W6 Dove-gray W8 Coffee

Metallic Collection (upon request)



14 Antique brass 19 Pelter delabrè 22 Copper delabrè 23 Gold delabrè

# Dina

Donegani & Lauda  
2011 / 2019

IT – È una piccola abat jour a luce LED. Il diffusore in policarbonato è montato su una struttura in alluminio oppure è sospeso con il cavo elettrico al soffitto. La forma “normale” della lampada nasconde una sorgente LED che, una volta accesa, rivela l’assenza di una lampadina tradizionale come in un gioco di prestigio.

EN – A small LED table lamp. The polycarbonate shade is mounted on an aluminum structure or suspended from the ceiling by the electric cable. The “normal” shape of the lamp hides a LED light source that, when lit, reveals the absence of a traditional light bulb, as in a conjuror’s trick.

DE – Eine kleine LED-Nachttischlampe. Der Lichtschirm aus Polycarbonat ist auf einer Aluminiumstruktur montiert oder hängt mit dem Stromkabel an der Decke. Die “normale” Form der Lampe verbirgt ein LED-Leuchtmittel, das, wenn es einmal eingeschaltet ist, das Fehlen einer herkömmlichen Glühbirne wie mit einem Zaubertrick aufdeckt.

FR – C'est une petite lampe à abat-jour dont la lumière vient d'une LED. Le diffuseur en polycarbonate est monté sur une structure en aluminium ou bien suspendu au plafond par son câble électrique. La forme “normale” de la lampe cache une source LED qui, une fois allumée, révèle l'absence d'ampoule traditionnelle, comme dans un tour de prestidigitateur.

ES – Una pequeña lámpara con luz LED. El difusor de policarbonato está montado en una estructura de aluminio o suspendido con el cable eléctrico del cielorraso. La forma “normal” de la lámpara oculta una fuente LED que, una vez encendida, revela la ausencia de una bombilla tradicional como un truco de magia.







58

Dina



Dina: Suspension

cod: H1

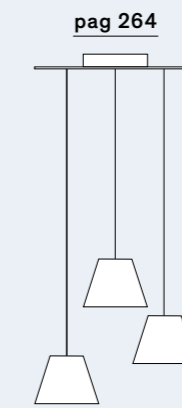
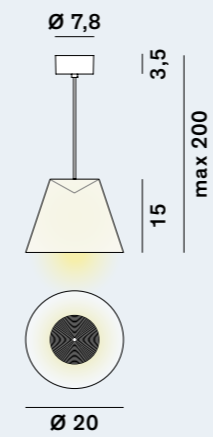

Light Source	MID POWER LED
Power	7 Watt
Kelvin	2.700
Lumen	460
CRI	90

Catalogue



Dina: Table

cod: T1

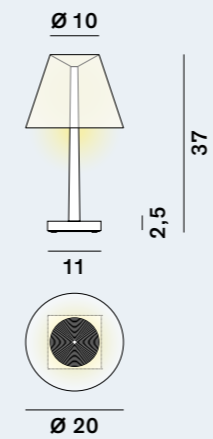

Light Source	MID POWER LED
Power	8,2 Watt
Kelvin	2.700
Dimmer	push button
Lumen	600
CRI	90

Catalogue

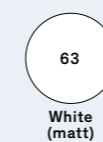

Satin Collection (upon request)



Diffuser

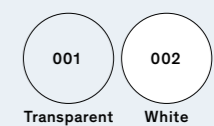

# Dina+

Donegani & Lauda  
2015 / 2017

IT – Versatile e innovativa, Dina+ è dotata di una batteria al litio (30 ore di autonomia) che l'ha trasformata in una lampada portatile, perfetta per essere utilizzata anche in terrazza o in giardino. Il nuovo dimmer a sfioro rende ancora più facile il controllo della luce, mentre la presa USB per ricaricare lo smartphone ne amplifica l'utilizzo accanto al letto, sulla scrivania o in soggiorno. Il diffusore in policarbonato è intercambiabile e la struttura in alluminio fa da supporto al LED.

EN – Versatile and innovative, Dina+ has a lithium battery (30 hours of life) that has transformed it into a portable lamp, perfect for use on terraces or in gardens. The new touch-sensitive dimmer makes it even easier to adjust the light, while the USB socket to charge a smartphone amplifies its use next to the bed, on the desk or in the living room. The polycarbonate lampshade can be changed, and the aluminum structure supports the LED.

DE – Die vielseitige und innovative Dina+ ist mit einer Lithiumbatterie (30 Stunden Betriebsdauer) ausgestattet, die es in eine tragbare Lampe verwandelt, die sich perfekt für den Einsatz auf der Terrasse oder im Garten eignet. Der neue Touch-Dimmer macht die Lichtsteuerung noch einfacher, während die USB-Buchse zum Aufladen des Smartphones erlaubt es, Dina+ neben dem Bett, auf dem Schreibtisch oder im Wohnzimmer zu verwenden. Der Lichtschirm aus Polycarbonat ist austauschbar, die Aluminiumstruktur nimmt die LED auf.

FR – Versatile et innovante, Dina+ est munie d'une batterie au lithium (30 heures d'autonomie) qui l'a transformée en lampe portative, parfaite pour être utilisée également sur une terrasse ou dans un jardin. Le nouveau gradateur de lumière à effleurement facilite encore plus le contrôle de la lumière, tandis que la prise USB pour recharger le mobile multifonction en favorise l'emploi à côté du lit, sur un bureau ou dans un séjour. Le diffuseur en polycarbonate est interchangeable et la structure en aluminium sert de support à la diode électroluminescente.

ES – Versátil e innovadora, Dina+ posee una batería de litio (30 horas de autonomía) que la ha transformado en una lámpara portátil, perfecta para ser utilizada también en terrazas o jardines. El nuevo dimmer táctil hace que el control de la luz sea aun más fácil, mientras que el conector USB para cargar el smartphone amplía el uso desde la cama, sobre el escritorio o en la sala de estar. El difusor de policarbonato es intercambiable y la estructura de aluminio actúa como soporte del LED.





64

# Dina+



65

Dina+: Table

cod: T1

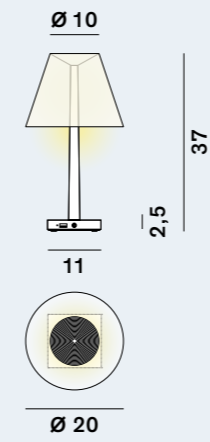

Light Source	MID POWER LED
Power	8 Watt
Kelvin	2.700
Dimmer	IR touch
Lumen	400
CRI	90

USB charger included

### Battery life

Cordless			
Light	70%	>	5 hours
Light	40%	>	10 hours
Light	5%	>	30 hours

### Catalogue



### Diffuser (included x 2)

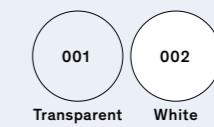

# Dresscode

Giovanni Lauda  
2019

IT – È una lampada tecnica con un “vestito” elegante. Lo schermo, che funge anche da dissipatore, è realizzato in alluminio estruso e ricorda la forma di un paralume a ventola in tessuto plissettato e bordato. La lampada, applicata alla parete, diffonde la luce in maniera simmetrica verso l’alto e verso il basso.

EN – A technical lamp with an elegant “dress”. The screen, that also works as dissipator, is made of extruded aluminum and evokes the shape of a half lampshade made of pleated and hemmed fabric. The wall-mounted lamp diffuses the light symmetrically upwards and downwards.

DE – Eine technische Lampe im eleganten “Gewand”. Der Schirm, der auch als Wärmeableiter fungiert, besteht aus extrudiertem Aluminium und gleicht in der Form einem Lampenschirm in plissiertem und gebördeltem Gewebe. Die an die Wand montierte Lampe streut das Licht symmetrisch nach oben und unten.

FR – Une lampe technique dans une “robe” élégante. L’écran, qui sert également de dissipateur, est fait d’aluminium extrudé et rappelle la forme d’un abat-jour en forme d’hélice, fait de tissu plissé et ourlé. La lampe, appliquée au mur, diffuse la lumière de manière symétrique vers le haut et vers le bas.

ES – Una lámpara técnica con un “traje” elegante. La pantalla, que actúa también como disipador, es de aluminio extruido y evoca la forma de un paraluz redondeado de tejido plisado y ribeteado. La lámpara aplicada en la pared difunde la luz en forma simétrica hacia arriba y abajo.





70

# Dresscode



71

Dresscode: Wall

cod: W1, W2

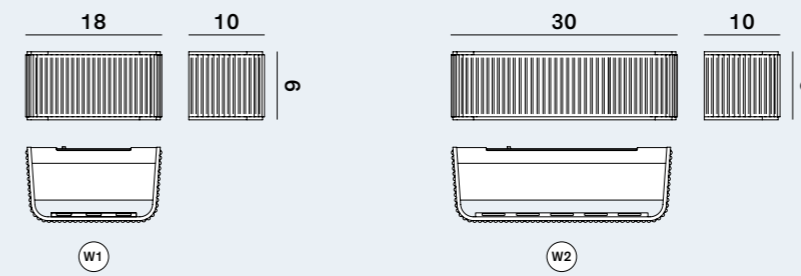

up and down

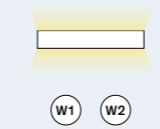

Light Source	MID POWER LED
Power (W1)	16 Watt
Power (W2)	29 Watt
Kelvin	2.700, 3.000
Dimmer (W1)	phase, dali
Dimmer (W2)	phase, dali, push
Lumen (W1)	1.250
Lumen (W2)	2.360
CRI	90

### Catalogue

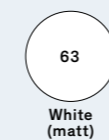

### Satin Collection (upon request)



### Kerakoll Warm Collection (upon request)



# Drink

Dante Donegani & Giovanni Lauda  
2004 / 2014

IT – Drink è una famiglia di lampade da terra e da sospensione che si distingue per il suo disegno semplice e iconico che ricorda la forma di un calice, colmo di luce. Le superfici sono caratterizzate da laccature nei colori classici o da trattamenti opachi e satinati che fanno riferimento al mondo dei metalli.

EN – Drink is a line of suspended and floor lamps featuring a simple and iconic design reminiscent of the shape of a chalice filled with light. It is available in a wide range of lacquers in the classical tones of colour or with opaque and glazed finishes that evoke the world of metals.

DE – Drink ist eine Serie von Boden- und Hängeleuchten, die sich durch schlichtes, ikonisches Design auszeichnen, dessen Form an einen mit Licht gefüllten Kelch erinnert. Die Oberflächen sind in klassischen Farben durch Mattieren und Satinieren behandelt, wobei sie an die Welt der Metalle erinnern.

FR – Drink est une famille de lampes appuyées au sol et suspendues, qui se caractérisent par un design simple et emblématique, rappelant la forme d'un calice rempli de lumière. Les surfaces sont caractérisées par des laquages dans des couleurs classiques ou par des traitements mats et satinés qui évoquent le monde des métaux.

ES – Drink es una familia de lámparas de pie y para colgar que se distinguen por un diseño sencillo e icónico que recuerda a la forma de una copa, colmada de luz. Las superficies se caracterizan por lacados en los colores clásicos o por tratamientos opacos y satinados que aluden al mundo de los metales.







76

Drink



Design Donegani & Lauda Year 04 / 14 Category: Floor / Suspension 

77

Drink: Suspension

cod: H1, H3

Light Source E27 LED

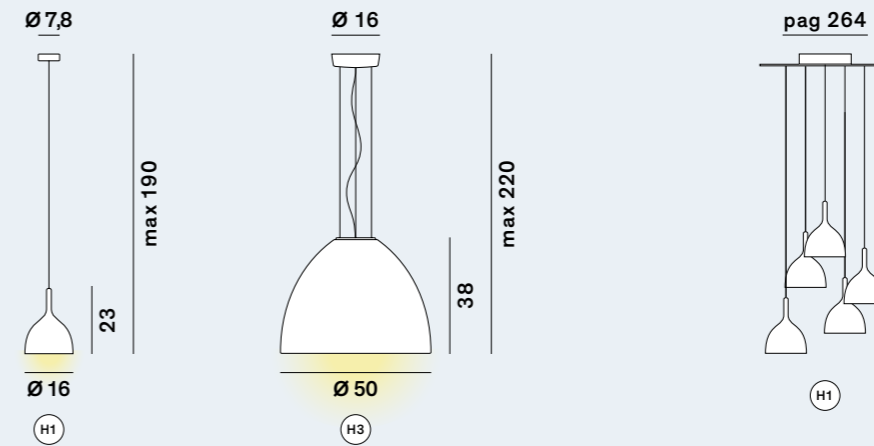

Catalogue

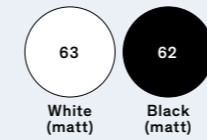

Satin Collection (upon request)



Kerakoll Warm Collection (upon request)



Drink: Floor

cod: F1

Light Source MID POWER LED



Power	36 Watt
Kelvin	2.700
Dimmer	push button
Lumen	4.000
CRI	90

Catalogue



# Dry

Dante Donegani & Giovanni Lauda  
2017

IT – Sottile ed elegante come un calice da cocktail, Dry è una lampada a LED da terra e da sospensione in acciaio verniciato, che emette un intenso fascio di luce. Sullo stelo della lampada da terra è inserito un pulsante a sfioro che ne regola l'accensione e l'intensità.

EN – Slim and sleek as a cocktail glass, Dry is a suspended and floor LED lamp in coated steel that emits an intense beam of indirect light upwards. A touch dimmer is inserted in the stem of the floor lamp to adjust the power and intensity.

DE – Schlank und elegant wie ein Sektkelch: Dry ist eine LED Boden- und Hängelampe aus lackiertem Stahl, die einen intensiven, indirekten Lichtstrahl nach oben abgibt. Am Ständer der Bodenlampe ist eine Berührungstaste eingebaut, der das Ein-/Aus-switchen und die Regelung der Lichtintensität gestattet.

FR – Fin et élégant comme un verre à cocktail, Dry est une lampe à LEDs appuyée au sol et suspendue en acier peint, qui émet un faisceau intense de lumière indirecte vers le haut. Sur la tige de la lampe appuyée au sol est inséré un bouton tactile, qui en règle l'allumage et l'intensité.

ES – Dry es una lámpara de pie y para colgar, de LED, en acero pintado, sutil y elegante como una copa de cóctel, que emite un intenso haz de luz indirecta hacia arriba. En la barra de la lámpara de pie se halla un botón que regula su encendido e intensidad.



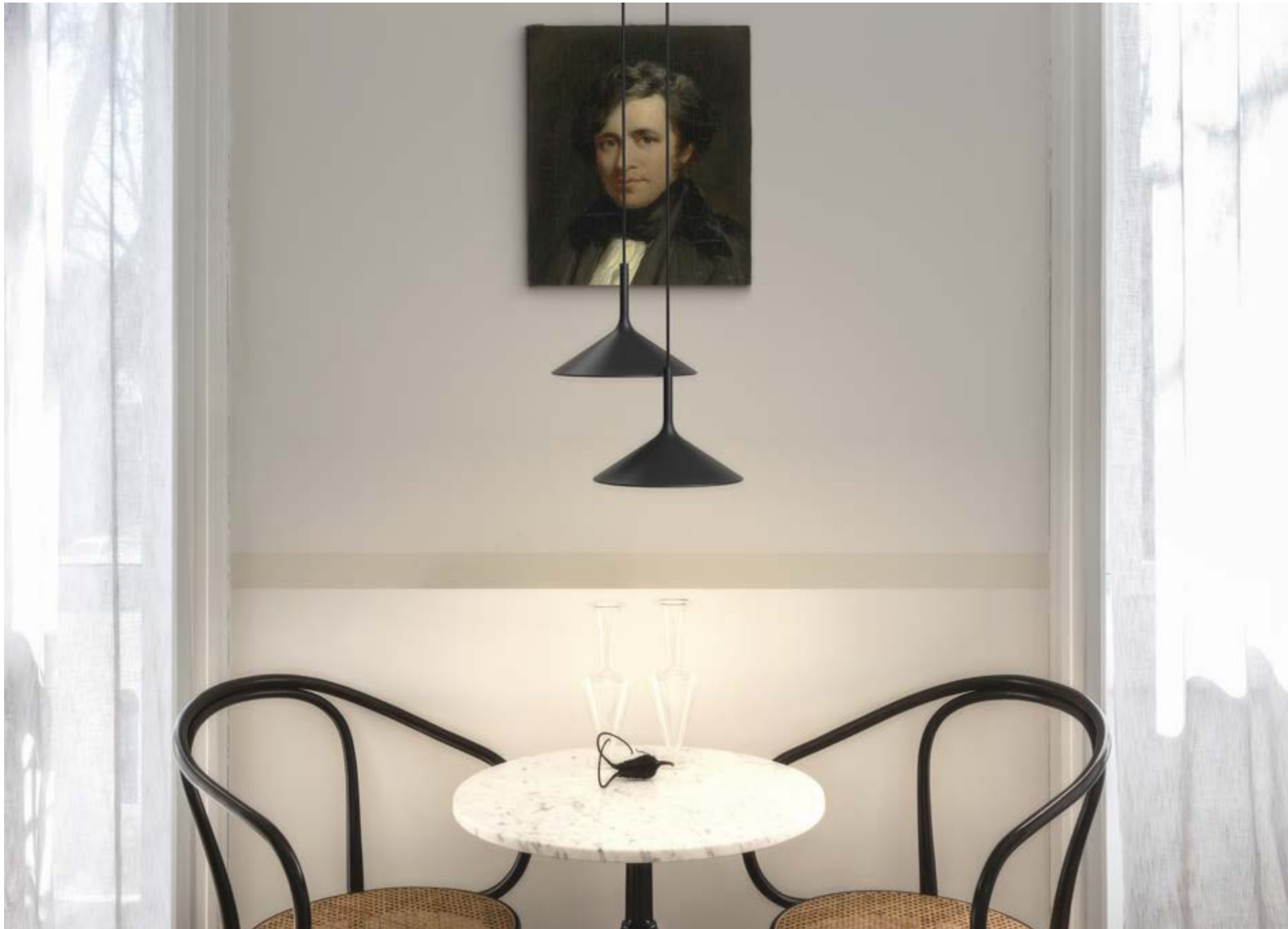

Dry



Design  
Donegani & Lauda

Year  
17

Category: Floor / Suspension 

Dry: Suspension

cod: H1, H2, H3, H4

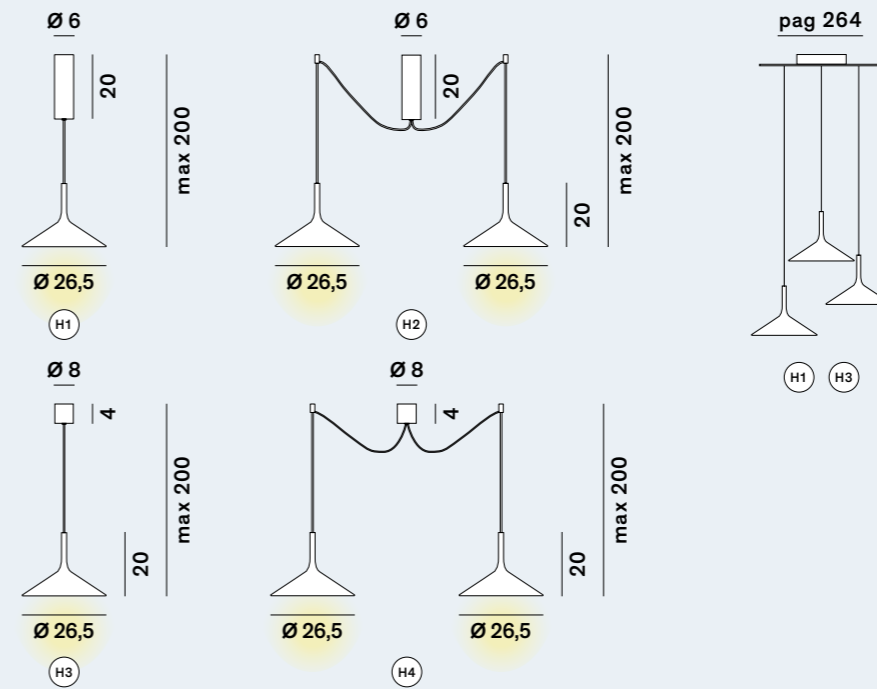

Light Source (H1, H2)	MID POWER LED
Light Source (H3, H4)	ACRICHE HV LED
Power (H1)	16 Watt
Power (H2)	32 Watt
Power (H3)	13 Watt
Power (H4)	26 Watt
Kelvin (H1, H2)	2.700
Kelvin (H3, H4)	2.700, 3.000
Dimmer (H1, H2)	phase, dali
Lumen (H1)	1.460
Lumen (H2)	2.920
Lumen (H3)	600
Lumen (H4)	1.200
CRI	90

Catalogue

Satin Collection (upon request)

Kerakoll Warm Collection (upon request)

Metallic Collection (upon request)



Dry: Floor

cod: F1



Light Source	MID POWER LED
Power	45 Watt
Kelvin	2.700
Dimmer	push button
Lumen	4.500
CRI	90

Catalogue



# Eden Collection

Dante Donegani & Giovanni Lauda  
2018

**IT – Eden è una famiglia di lampade da terra. Tre grandi foglie fonoassorbenti a cui è applicata magneticamente una lampada a LED. Grazie alla soffice imbottitura e al particolare tessuto di rivestimento, le foglie, oltre a illuminare lo spazio con luce indiretta, contribuiscono a migliorare il comfort acustico. La vivibilità di un ambiente deriva in gran parte da un elemento invisibile e forse, proprio per questo, spesso trascurato: la sua acustica. Riverberi e rumori possono disturbare la conversazione, impedire la concentrazione e il relax, suscitare sensazioni sgradevoli e perfino avere degli effetti nocivi sul benessere psicofisico.**

EN – Eden is a family of floor lamps. Three large sound-absorbent leaves to which a LED light is magnetically attached. Thanks to their soft padding and their special lining fabric, these leaves not only illuminate with indirect light but also help to improve acoustic comfort. The agreeableness of a room derives mostly from an invisible element that, perhaps because of this, is often neglected: its acoustics. Reverberation and noise can disturb a conversation or a moment of relaxation, can generate uneasiness and even have negative repercussions on our psycho-physical well-being.

DE – Eden ist eine Stehlampen-Kollektion. Drei große schalldämpfende Blätter, an denen eine LED-Lampe durch Magnetkraft appliziert wird. Dank der weichen Polsterung und des besonderen Bezugsstoffs sorgen die Blätter nicht nur für die indirekte Beleuchtung des Raums, sondern tragen auch zur Verbesserung des akustischen Komforts bei. Die Lebensqualität einer Umgebung beruht im Wesentlichen auf einem unsichtbaren Element, das genau aus diesem Grund gerne vernachlässigt wird: die Akustik. Nachhall und Geräusche können die Unterhaltung stören, Konzentration und Entspannung verhindern, unangenehme Empfindungen hervorrufen und sogar das psychophysische Wohlbefinden beeinträchtigen.

FR – Eden est une série de lampadaires faits de trois grandes feuilles insonores, auxquelles est appliquée une lampe à LED qui tient par un aimant. Grâce au rembourrage moelleux et au tissu spécial du revêtement, les feuilles permettent d'éclairer la pièce de façon indirecte, tout en contribuant à améliorer le confort sur le plan acoustique. Si un environnement est agréable à vivre, cela vient en grande partie d'un élément et qui est peut-être souvent négligé, parce qu'il est invisible: il s'agit justement de l'acoustique. Les réverbérations et les bruits peuvent déranger la conversation, empêcher la concentration et le repos, susciter des sensations désagréables et même avoir des effets nuisibles sur le bien-être psycho-physique.

ES – Eden es una familia de lámparas de pie. Compuestas por tres grandes hojas insonorizantes a las cuales está aplicada magnéticamente una lámpara LED. Gracias al suave relleno y al tejido particular del revestimiento, además de iluminar el espacio con luz indirecta, las hojas contribuyen a mejorar el confort acústico. La habitabilidad de un ambiente deriva en gran parte de un elemento invisible y, tal vez justamente por esto, con frecuencia no se lo tiene en cuenta: su acústica. Reverberaciones y ruidos pueden disturbar la conversación, impedir la concentración y el relax, causar sensaciones desagradables y, además, tener efectos nocivos en el bienestar psicofísico.

Focus  
Eden Collection



Henri Rousseau, L'incantatrice di serpenti, 1907

## Eden Collection

Eden è una vegetazione fantastica, come quella dei quadri del doganiere Rousseau. Tre grandi foglie: la musa paradisiaca – come chiamavano gli antichi il banano – albero del paradiso, fico di Adamo; la quercia, albero sacro a Zeus; l'alocasia simile ad un orecchio di elefante. Un piccolo eden domestico, un bosco che filtra luce e suoni, uno spazio di bellezza e di benessere creato dalla luce schermata e dalle qualità acustiche delle foglie. Le foreste dipinte dal pittore francese sono il frutto dell'immaginazione, il sogno di un paradiso esotico primordiale: le tigri feroci sono quelle dello zoo di Parigi e gli alberi esotici sono fili d'erba stilizzati, orchidee ingigantite, piante d'appartamento e foglie fuori scala come quelle della collezione Eden. I giardini nascosti (anche nel profondo dell'immaginazione) sono piccoli eden. Come il ninfeo della villa di Livia: un paradiso perduto e riportato 'alla luce' dopo 2000 anni dagli scavi archeologici. Il ninfeo è un ambiente sotterraneo, senza finestre, affrescato come un giardino abitato dagli uccelli, fiorito e verde tutto l'anno; uno spazio quindi senza finestre ma pieno di aria e di luce, grazie alle piante affrescate sulle pareti. Il giardino dipinto sulle pareti del ninfeo genera uno spazio ovattato come quello creato dalle lampade Eden; un luogo dove godere il silenzio nella suggestione di essere circondati dal verde e – con un po' di immaginazione – sentire il fruscio del vento e respirare il profumo dei fiori.

Giovanni Lauda

Eden is a fantasy vegetation, like that seen in Rousseau "Le Douanier"'s paintings. Three large leaves: the Musa paradisiaca – thus the name given to the banana plant by the ancients – Paradise tree, Adam's fig; the oak, the tree sacred to Zeus; the alocasia, that looks like the ear of an elephant. A small domestic Eden, a forest that filters light and sound, a space of beauty and well-being created by the filtered light and by the acoustic properties of the leaves. The forests painted by the French painter stem from imagination, from dreams of an exotic and primordial paradise where the ferocious tigers are those of the Paris zoo and the exotic trees are stylized grass blades, giant orchids, house plants and off-scale leaves just like those of the Eden collection. The hidden gardens (hidden in the depths of imagination, as well) are small Edens. Like the nymphaeum of Livia's Villa: a lost paradise brought back to light after 2000 years thanks to archeological excavation. The nymphaeum is an underground, windowless room frescoed to look like a garden inhabited by birds, and blooming and green all year round. Although lacking windows, the room is full of light and air, thanks to the plants painted on the walls. The garden painted on the walls of the nymphaeum creates a padded space, like the one generated by the Eden lamps, a place where one can enjoy the silence, fancy being immersed in a garden and – with a bit of imagination – hear the wind through the leaves and smell the fragrance of the flowers.

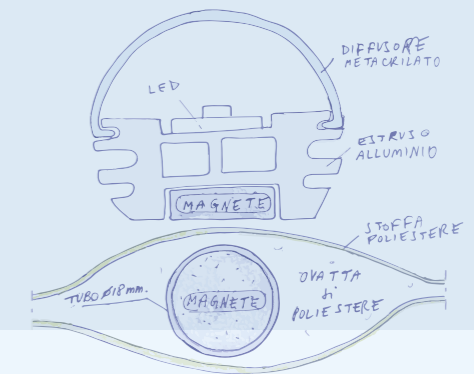

Eden, modellino in carta, ottobre 2017



Affreschi del ninfeo della Villa di Livia, Roma 40–20 a.C.

DE – Eden ist eine fantastische Pflanzenwelt, wie sie auf den Gemälden von Rousseau, Le Douanier, zu sehen ist. Drei große Blätter: die Musa paradisiaca – wie der Bananenbaum in der Antike genannt wurde – Paradiesbaum, Paradiesfeige; die Eiche, ein Baum, der Zeus heilig ist; die Alocasia – das Pfeilblatt – ähnlich einem Elefantenohr. Ein kleiner Eden-Hausgarten, ein Wald, der Licht und Klang filtert, ein Raum der Schönheit und des Wohlbefindens, der durch das abgeschirmte Licht und die akustischen Eigenschaften der Blätter geschaffen wird. Die von dem französischen Maler verewigten Wälder sind die Frucht der Phantasie, der Traum eines ursprünglichen exotischen Paradieses: Die wilden Tiger sind die des Pariser Zoos und die exotischen Bäume sind stilisierte Grashalme, vergrößerte Orchideen, Zimmerpflanzen und Blätter aus dem Maßstab wie in der Eden-Kollektion. Die (auch in den Tiefen der Vorstellungskraft) verborgenen Gärten sind kleine Eden-Gärten. Wie das Nymphäum der Villa von Livia: ein verlorenes Paradies, das nach 2000 Jahren durch archäologische Ausgrabungen wieder "ins Licht" zurückgebracht wurde. Das Nymphäum ist ein unterirdisches Ambiente ohne Fenster, der wie ein von Vögeln bewohnter, ganzjährig grüner und blumiger Garten mit Fresken geschmückt ist. Ein fensterloser Raum also, aber dank der Pflanzen an den Wänden voller Luft und Licht. Der an den Wänden des Nymphäums gemalte Garten erzeugt einen gedämpften Raum, wie er durch die Eden-Lampen geschaffen wird – einen Ort, an dem man die Stille genießen kann, indem man sich vorstellt, von Grün umgeben zu sein, und mit ein wenig Fantasie das Rascheln des Windes spürt und den Duft der Blumen einatmet.

FR – Eden est une végétation fantastique comme celle des tableaux de Rousseau « Le Douanier ». Trois grandes feuilles: la Musa paradisiaca – comme les anciens définissaient le bananier – arbre du paradis, figuier; le chêne, arbre sacré de Zeus; l'Alocasia, en forme d'oreille d'éléphant. Un petit Eden domestique, un bois filtrant lumière et sons, un lieu de beauté et de bien-être créé par de la lumière protégée derrière un écran et par les qualités acoustiques des feuilles. Les forêts du peintre français sortent de son imagination, comme rêve d'un paradis exotique primordial: les tigres féroces sont ceux du zoo de Vincennes à Paris et les arbres exotiques sont des brins d'herbe stylisés; les orchidées deviennent géantes, tandis que les plantes d'appartement et les feuilles ont des dimensions irréelles comme celles de la collection Eden. Les jardins cachés (dans la profondeur de l'imagination également) sont de petits paradis. Comme le nymphée de la villa de Livia: un paradis perdu et revenu 'à la lumière' au bout de 2000 ans de fouilles archéologiques. Le nymphée est un environnement souterrain, sans fenêtres, décoré de fresques comme un jardin peuplé d'oiseaux, fleuri et verdoyant toute l'année; un espace qui est donc sans fenêtres, mais plein d'air et de lumière, grâce aux plantes peintes sur les murs comme des fresques. Le jardin peint sur les murs du nymphée crée un espace ouaté comme celui des lampes Eden; un endroit où apprécier le silence avec l'impression d'être entouré de verdure et – avec un peu d'imagination – où entendre le bruissement du vent et respirer le parfum des fleurs.

ES – Eden es una vegetación fantástica, como la de los cuadros de El Aduanero de Rousseau. Tres grandes hojas: la musa paradisiaca – como los antiguos llamaban al plátano – árbol del paraíso, higuera de Adán; el roble, árbol sagrado de Zeus; la alocasia similar a una oreja de elefante. Un pequeño edén doméstico, un bosque que filtra luz y sonido, un espacio de belleza y bienestar creado por la luz protegida y la calidad acústica de las hojas. Los bosques que creó el pintor francés son el fruto de la imaginación, el sueño de un paraíso exótico primordial: los tigres feroces son los del zoológico de París y los árboles exóticos son hilos de hierba estilizados, orquídeas gigantes, plantas de interior y hojas enormes como las de la colección Eden. Los jardines ocultos (incluso en la profundidad de la imaginación) son pequeños Edenes. Como el ninfeo de Villa de Livia, un paraíso perdido y sacado 'a la luz' después de 2000 años con las excavaciones arqueológicas. El ninfeo es un ambiente subterráneo, sin ventanas, representado en un fresco como un jardín habitado por pájaros, florecido y verde todo el año. Un espacio sin ventanas pero lleno de aire y luz, gracias a las plantas pintadas en las paredes. El jardín de los frescos de las paredes del ninfeo genera un espacio atenuado como el que crean las lámparas Eden; un lugar donde gozar del silencio en la sugestión de estar circundados por el verde y, con un poco de imaginación, sentir el silbido del viento y respirar el perfume de las flores.







## Eden Collection

1



2



1  
IT – Interruttore / dimmer con tecnologia touch, posizionato nella zona superiore della lampada. EN – Switch / dimmer switch with touch technology, located in the upper part of the lamp. DE – Schalter / Dimmer mit Touch-Technologie, im oberen Bereich der Lampe. FR – Interrupteur / gradateur de lumière tactile, placé dans la zone supérieure de la lampe. ES – Interruptor / regulador de intensidad con tecnología touch, ubicado en la parte superior de la lámpara.

2  
IT – Sistema di fissaggio "invisibile" e riposizionabile della lampada sulla struttura, mediante tre calamite nascoste all'interno della foglia. EN – "Invisible" and movable system fastening the lamp to the structure, using three magnets hidden inside the leaf. DE – "Unsichtbares, und wiederpositionierbares System zur Befestigung der Lampe auf der Struktur, mit drei im Innern des Blattes versteckten Magneten. FR – Système de fixation de la lampe « invisible » et

susceptible d'être remis en place sur la structure, à l'aide de trois aimants cachés à l'intérieur de la feuille. ES – Sistema de fijación "invisible" y reubicable de la lámpara sobre la estructura, mediante tres imanes ocultos dentro de la hoja.

Design  
Donegani & Lauda

Year  
18

Category: Floor 

Eden Collection (Banana, Oak, Alocasia): Floor

cod: F1, F2, F3

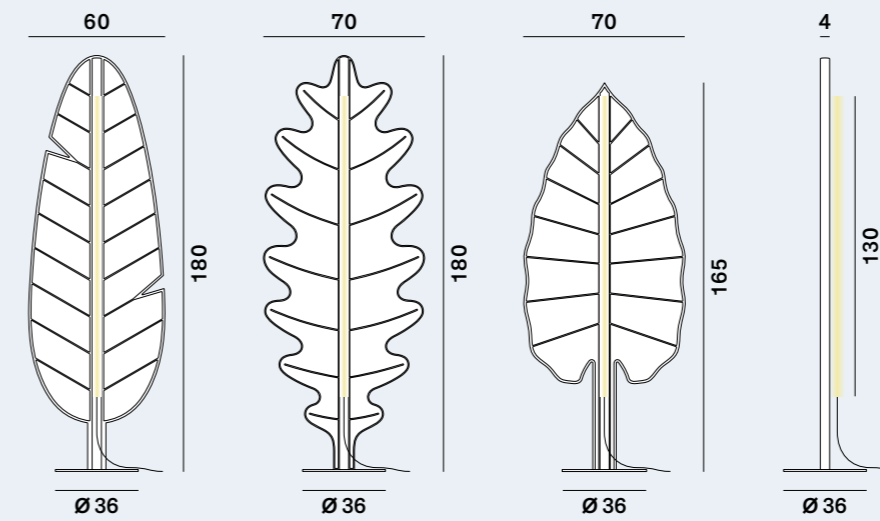

Light Source	MID POWER LED
Power	40 Watt
Kelvin	2.700
Dimmer	touch
Lumen	3.500
CRI	90
Sound absorbing	

Filling



Ovatta di poliestere  
/ Polyester fibre

Baseplate



Acciaio verniciato Antracite  
/ Anthracite painted steel

# Sound Absorbing

**IT – La vivibilità di un ambiente deriva in gran parte da un elemento invisibile e forse, proprio per questo, spesso trascurato: la sua acustica. Riverberi e rumori possono disturbare la conversazione, impedire la concentrazione e il relax, suscitare sensazioni sgradevoli e perfino avere degli effetti nocivi sul benessere psicofisico. Grazie alla sua soffice imbottitura ed al particolare tessuto di rivestimento, Eden unisce alla funzione illuminante ed arredativa, delle doti fonoassorbenti che contribuiscono a migliorare il comfort acustico, creando una piacevole sensazione: come in un bosco che filtra i suoni attraverso le foglie.**

**EN – The liveability of an environment derives in large part from an invisible element, namely its acoustics, which, perhaps because of their very nature, are often neglected. Reverberations and noises can disturb a conversation, hinder concentration and relaxation, arouse unpleasant feelings and even have harmful effects on psychophysical wellness. Thanks to its soft padding and distinctive upholstery fabric, Eden adds sound-absorbing properties to its lighting and furnishing functions, improving acoustic comfort and producing the same pleasant feeling of being in a forest that filters sounds through leaves.**

**DE – Die Wohnbarkeit einer Umgebung beruht größtenteils auf einem unsichtbaren und wahrscheinlich gerade deshalb oft vernachlässigten Element: seine Akustik. Nachhall und Geräusche können die Unterhaltung stören, die Konzentration und Entspannung verhindern, unangenehme Gefühle hervorrufen und sich sogar schädlich auf unser psychophysisches Wohlbefinden auswirken. Dank der sanften Polsterung und des besonderen Gewebes des Bezuges, verbindet Eden die Beleuchtungs- und Einrichtungsfunktion mit schallschluckenden Fähigkeiten, die dazu beitragen, den akustischen Komfort zu verbessern und ein angenehmes Gefühl zu vermitteln: Wie in einem Wald, der mit seinen Blättern den Schall filtern.**

**FR – Le confort d'un milieu ambiant naît en grande partie d'un élément invisible et qui est peut-être, justement à cause de cela, très souvent négligé: son acoustique. Les réverbérations sonores et les bruits peuvent déranger la conversation, nuire à la concentration et à la relaxation, engendrer des sensations déplaisantes et, même, avoir des effets nocifs sur le bien-être psychique et physique. Grâce à son rembourrage moelleux et aux tissus de revêtement particulier, Eden ajoute, à une fonction d'éclairage et de décoration, des capacités d'insonorisation qui contribuent à améliorer le confort acoustique général, en suscitant une plaisante sensation : comme dans un bois qui filtrerait les sons à travers ses feuilles.**

**ES – El confort de vivir un ambiente deriva en gran parte de un elemento invisible y, quizás, justamente por esto, muchas veces ignorado: su acústica. Reverberaciones y ruidos pueden interferir en la conversación, impedir la concentración y el relax, suscitar sensaciones desagradables e, incluso, tener efectos nocivos sobre el bienestar psicofísico. Gracias a su suave relleno y al particular tejido del revestimiento, Eden une a la función de iluminación y decoración, dotes de absorción de sonidos que contribuyen a mejorar el confort acústico, creando una agradable sensación: como en un bosque que filtra los sonidos a través de las hojas.**

## L'assorbimento del Suono / Sound Absorbing

① **IT – Calcolo dell'area di assorbimento acustico del singolo oggetto Aobj in camera riverberante secondo la ISO 354.**

**EN – Calculation of the sound absorption area of the individual Aobj object in the reverberating room in compliance with ISO 354.**

**DE – Berechnung des Schallabsorptionsbereichs des einzelnen Aobj-Objekts im Halbraum gemäß ISO 354.**

**FR – Calcul de la zone d'absorption acoustique de l'objet individuel Aobj dans la chambre de réverbération, conformément à la norme ISO 354.**

**ES – Cálculo del área de absorción acústica del objeto Aobj en cámara reverberante según la norma ISO 354.**

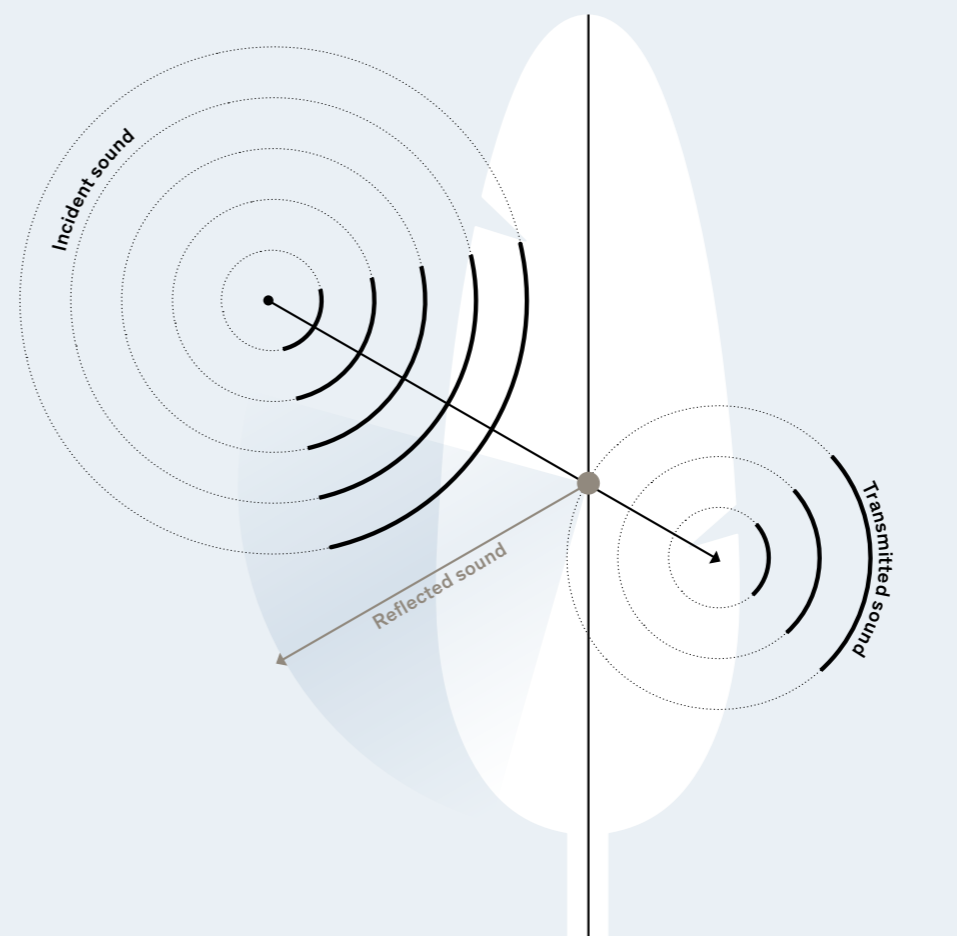
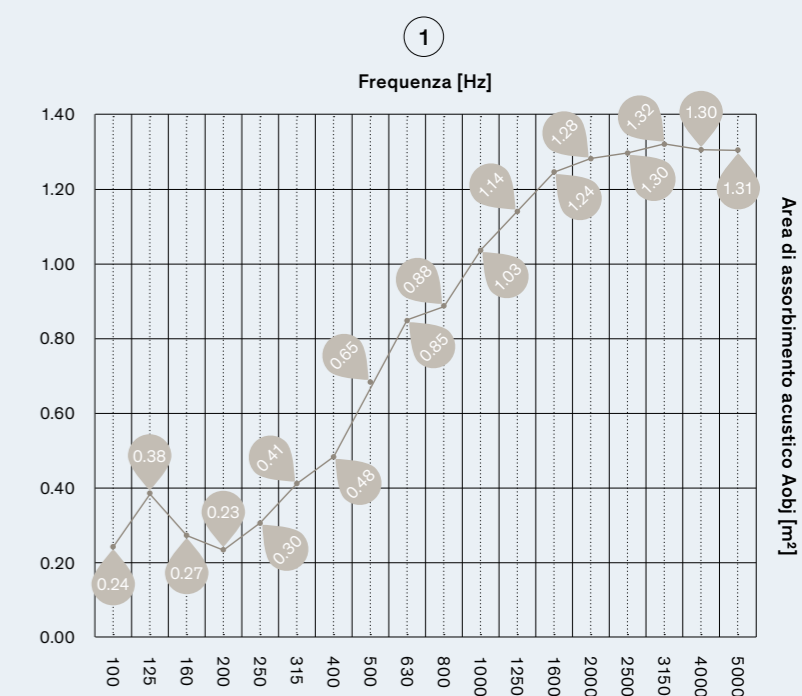

# Fabric Cover Medley by Gabriel®

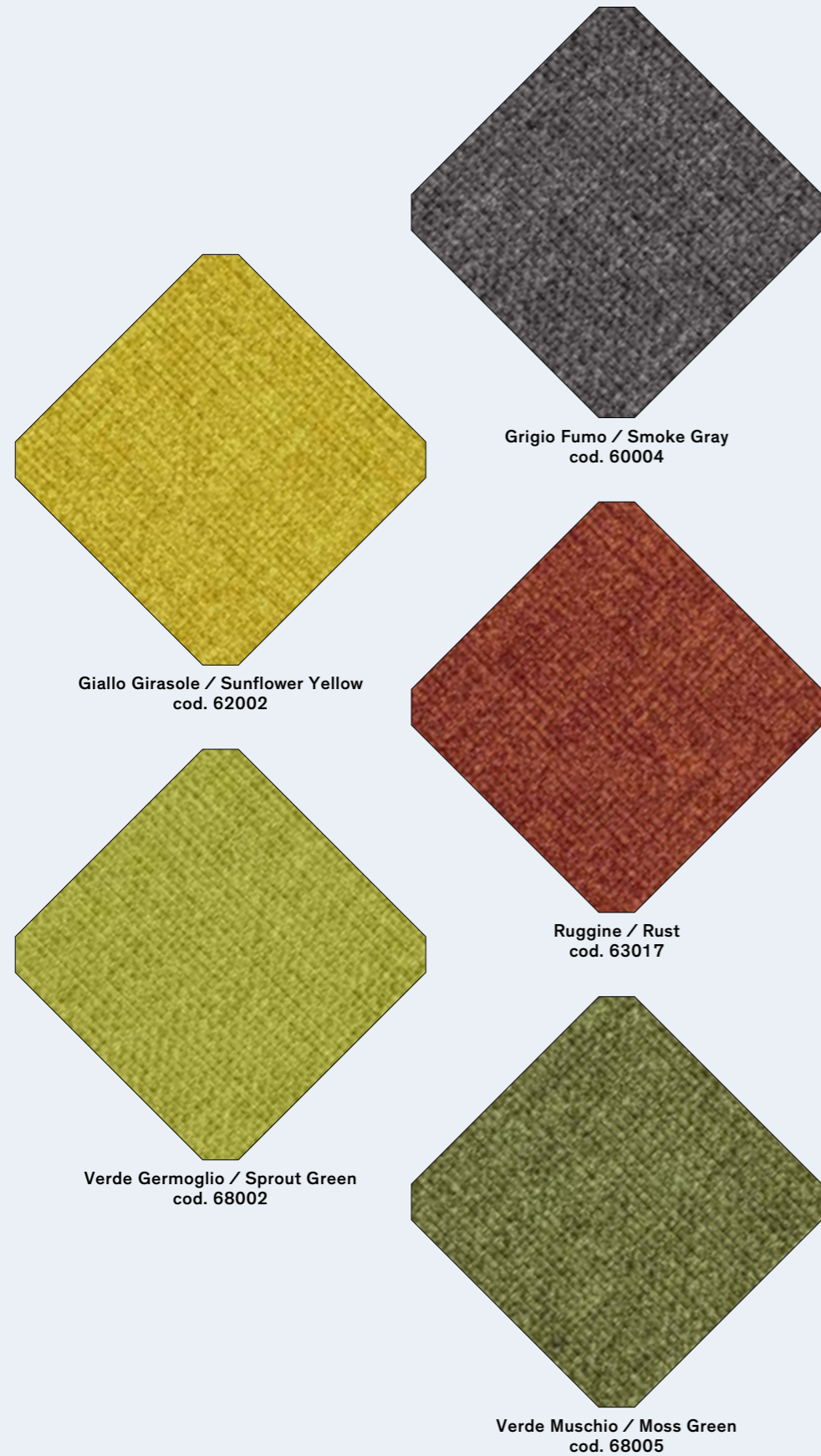

Grigio Fumo / Smoke Gray  
cod. 60004

Giallo Girasole / Sunflower Yellow  
cod. 62002

Ruggine / Rust  
cod. 63017

Verde Germoglio / Sprout Green  
cod. 68002

Verde Muschio / Moss Green  
cod. 68005

Rotaliana

Colori personalizzati su richiesta: 32 colori disponibili  
/ Custom colours on demand: 32 Color available

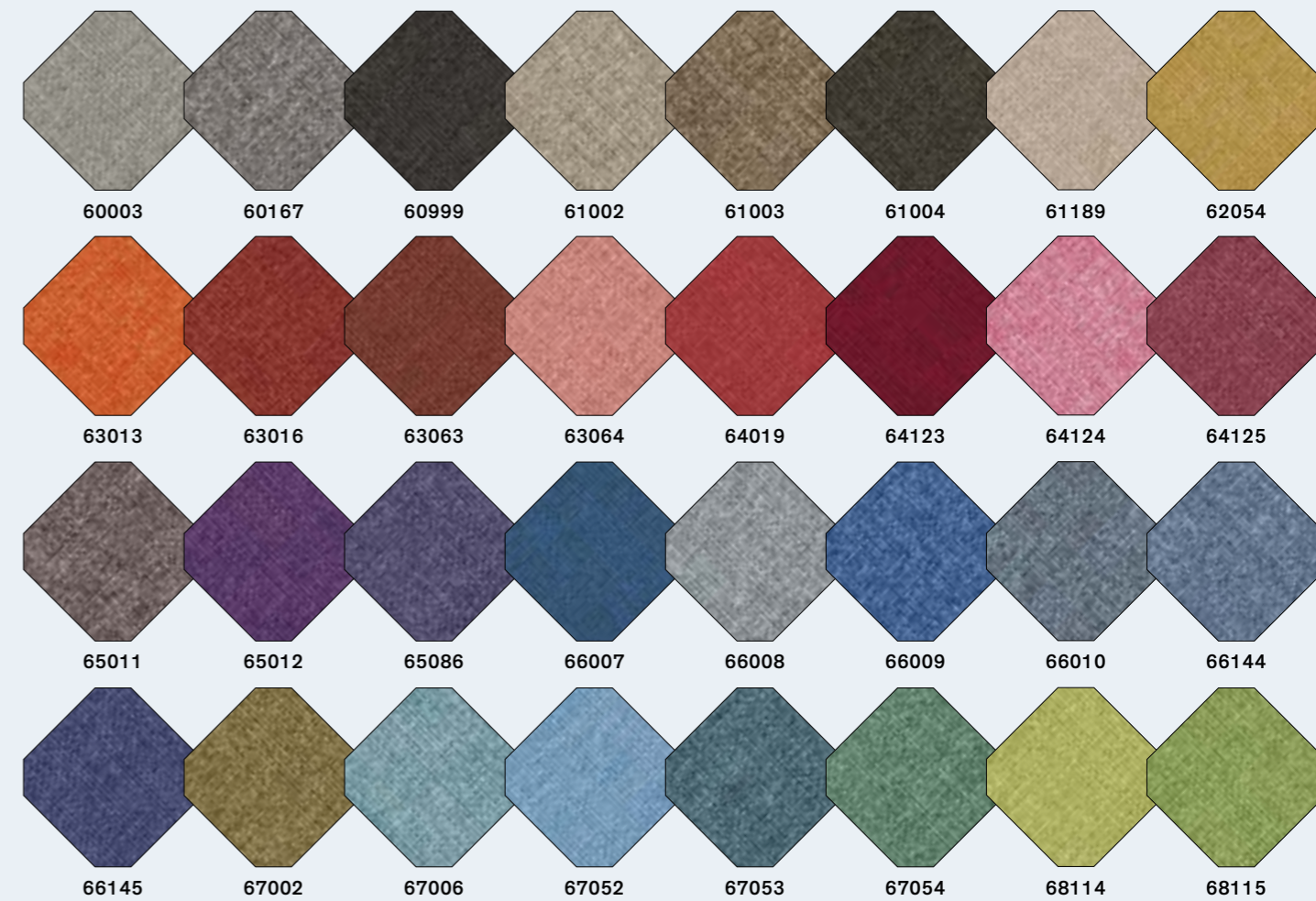

- 60003    60167    60999    61002    61003    61004    61189    62054
- 63013    63016    63063    63064    64019    64123    64124    64125
- 65011    65012    65086    66007    66008    66009    66010    66144
- 66145    67002    67006    67052    67053    67054    68114    68115

Materiale / Material	Infiammabilità / Flammability	Manutenzione / Maintenance	Ambiente / Environment
100% Poliestere Polyester	BS EN 1021 1&2 Cigarette and Match BS EN 1021-1 Cigarette BS 5852 Part 1 0,1 Cigarette & match BS 476 Part 7, class 2 Class Uno UNI 9174 – UNI 8457 ÖNORM B 3825-B2-3800-Q1 UK CA TB 117-2013 ASTM E 84	Medley è realizzato in poliestere, materiale adatto per ambienti con esigenze particolari di pulizia. Lavabile fino a 74°C (battericida).  Medley is made of polyester which is a material suited for environments with special requirements for cleaning. Washable at up to 74°C (bactericidal).	100% Poliestere riciclabile / Recyclable polyester  100% Privo di metalli pesanti / Free of heavy metals

# Febo

Paolo Rizzatto  
2019

IT – È una lampada a sospensione composta da due calotte: una esterna, semplice e compatta, che evoca una cupola ribassata e una interna sfaccettata e riflettente. Il disegno tridimensionale delle sfaccettature diamantate fa riferimento all'architettura araba e agli studi condotti da Escher sulla divisione regolare delle superfici. La luce dei LED nascosti nella cornice circolare si riflettono sulla superficie sfaccettata all'interno, generando un affascinante effetto di rifrazioni.

EN – Febo is a suspended lamp consisting of two domes: an outer one, simple and compact, that looks like a lowered cupola, and an inner one, grooved and reflective. The 3D design of the diamond-shaped grooves is a reference to Arabian architecture and to the studies conducted by Escher on the regular division of the planes. The light of the LEDs hidden in the circular frame reflects on the faceted surface of the inner dome and generates a fascinating refractive effect.

DE – Eine Hängelampe, die aus zwei Schalen besteht: einem einfachen und kompakten äußeren Teil, das an eine abgesenkte Kuppel erinnert, und einem facettenreichen und reflektierenden inneren Teil. Das dreidimensionale Design der Diamantfacetten verweist auf die arabische Architektur und auf die von Escher durchgeführten Studien zur regelmäßigen Teilung der Oberflächen. Das Licht der LEDs, die im kreisförmigen Rahmen verborgen sind, wird auf die facettierte Oberfläche im Inneren reflektiert und erzeugt einen faszinierenden Lichtbrechungseffekt.

FR – C'est un lustre fait de deux calottes: l'une à l'extérieur, simple et compacte, qui évoque une coupole rabaissée et une autre, à l'intérieur, faite de facettes pour refléter la lumière. Le dessin tridimensionnel des facettes en forme de diamant dérive de l'architecture arabe et des études d'Escher sur la division régulière des surfaces. La lumière des LED cachées dans le cadre circulaire se réfléchit sur les surfaces en facettes à l'intérieur pour provoquer un effet fascinant de réfractions.

ES – Lámpara para colgar compuesta por dos casquetes: uno externo, simple y compacto, que evoca una cúpula rebajada, y uno interno multifacético y reflectante. El diseño tridimensional del facetado a diamante se inspira en la arquitectura árabe y los estudios realizados por Escher sobre la división regular de las superficies. La luz de los LEDs ocultos en el marco circular se refleja sobre la superficie facetada interior, generando un efecto fascinante de refracciones.

Focus  
Febo

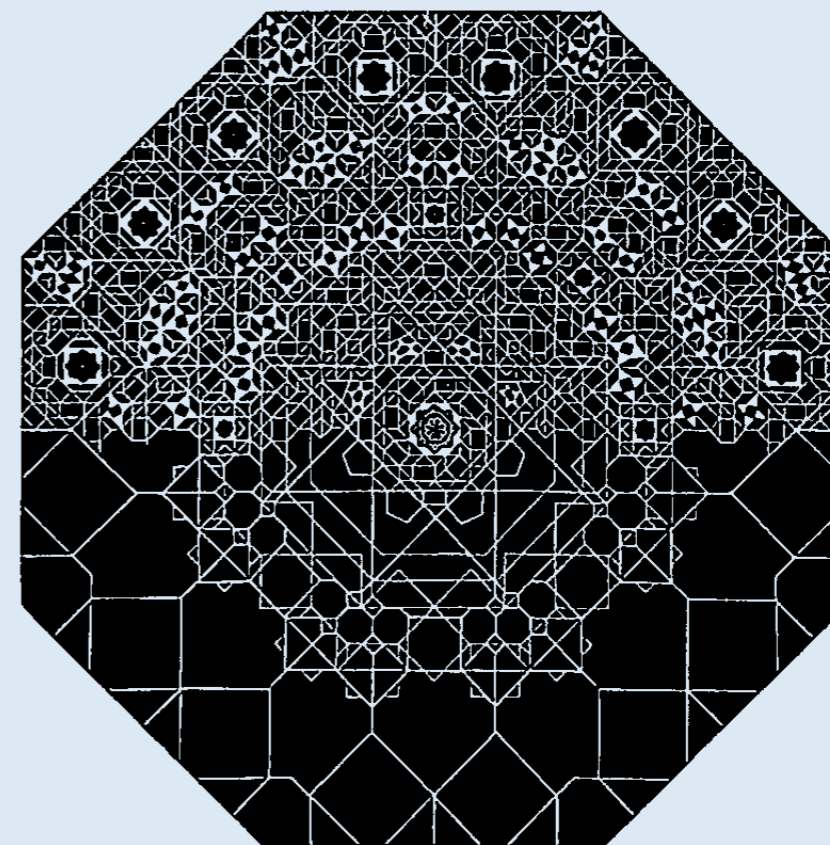
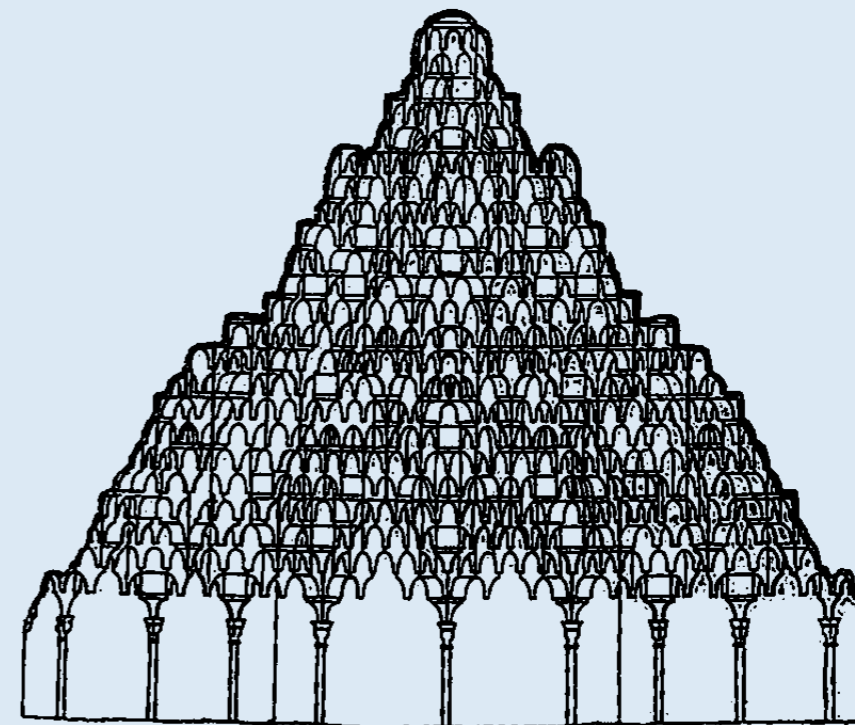

Muqarna

A

## Febo

Fin dall'Antichità Classica ed in seguito nel corso del Medioevo e del Rinascimento fino ai nostri giorni il gioco ripetitivo delle sequenze matematiche e delle composizioni geometriche è stato fonte di ispirazione per gli artisti e gli sperimentatori di tutto il mondo: i costruttori arabi con un sistema di nicchie e stalattiti a prevalente forma triangolare chiamate "Muqarnas" (dapprima usato singolarmente in grandi dimensioni in fine usato ripetuto in serie in piccole dimensioni) sono stati una fonte d'ispirazione stimolante, ma è l'affascinante e approfondito lavoro di Escher sulle combinazioni di triangoli ed esagoni che ha suggerito la forma finale. Come a Granada, Gerusalemme e Isfahan, nell'Alhambra e nelle Moschee i volumi degli esterni sono semplici e compatti, ma all'interno, grazie alla luce che filtra attraverso le finestre disposte tutt'intorno alla base delle cupole, si dilatano in modo magico e sconvolgente. Così nelle lampade a sospensione Febo la luce naturale e quella dei LED nascosti nella cornice circolare riflettendosi sulla superficie sfaccettata e specchiante della cupola ribassata ne trasformano, con un sorprendente e sempre variato gioco esponenziale di decise e brillanti rifrazioni, il tondeggiante volume semplice e liscio.

Paolo Rizzato

*"Il mondo è uno specchio dalla testa ai piedi, in ogni atomo ci sono cento soli scintillanti"*

*Mahmud Shabistari*

*"Le usanze si radicano con forza solo grazie a svariate ripetizioni e a una lunga consuetudine"*

*Ibn Khaldun*

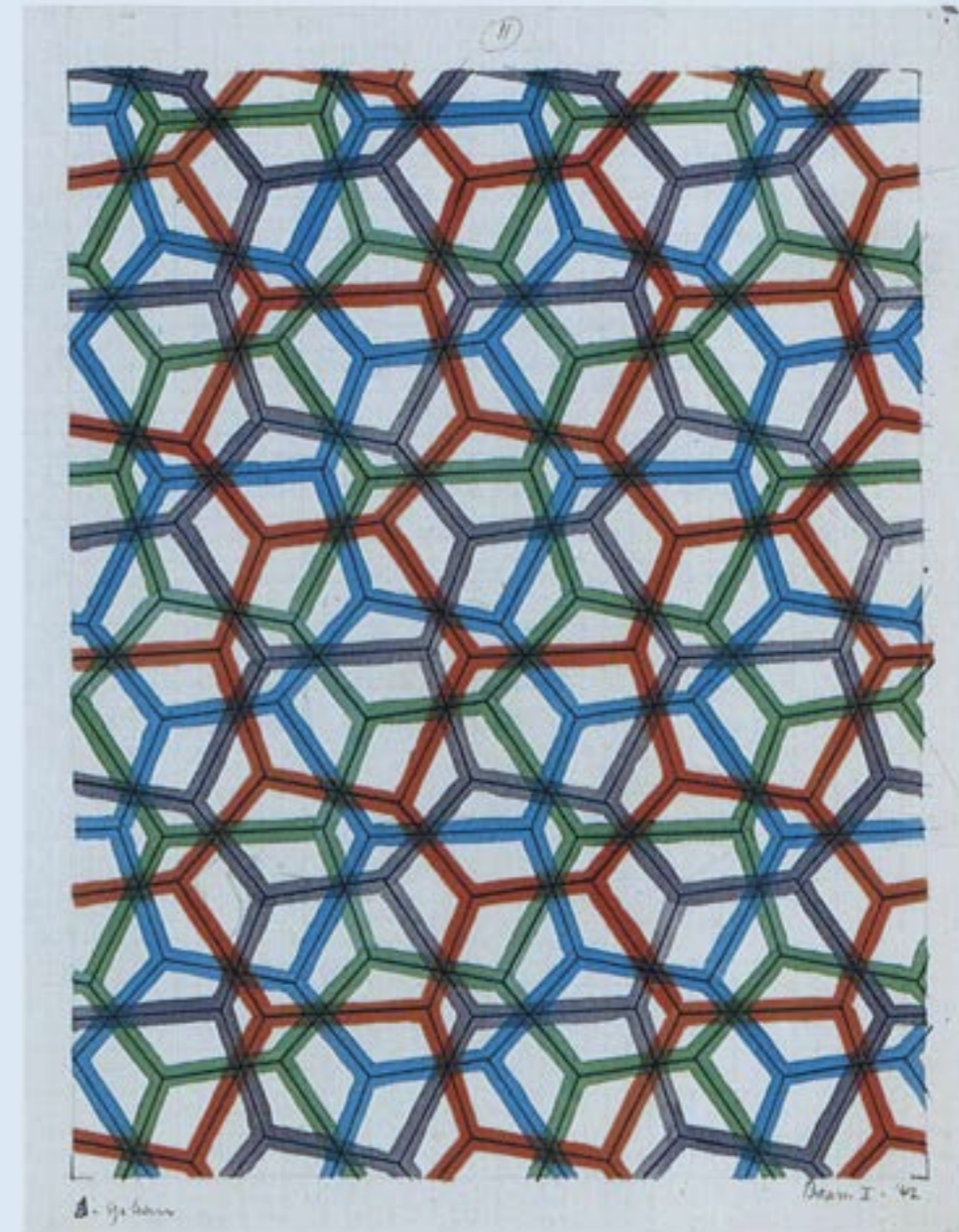

Maurits Cornelis Escher, combinazioni geometriche, 1937-'38

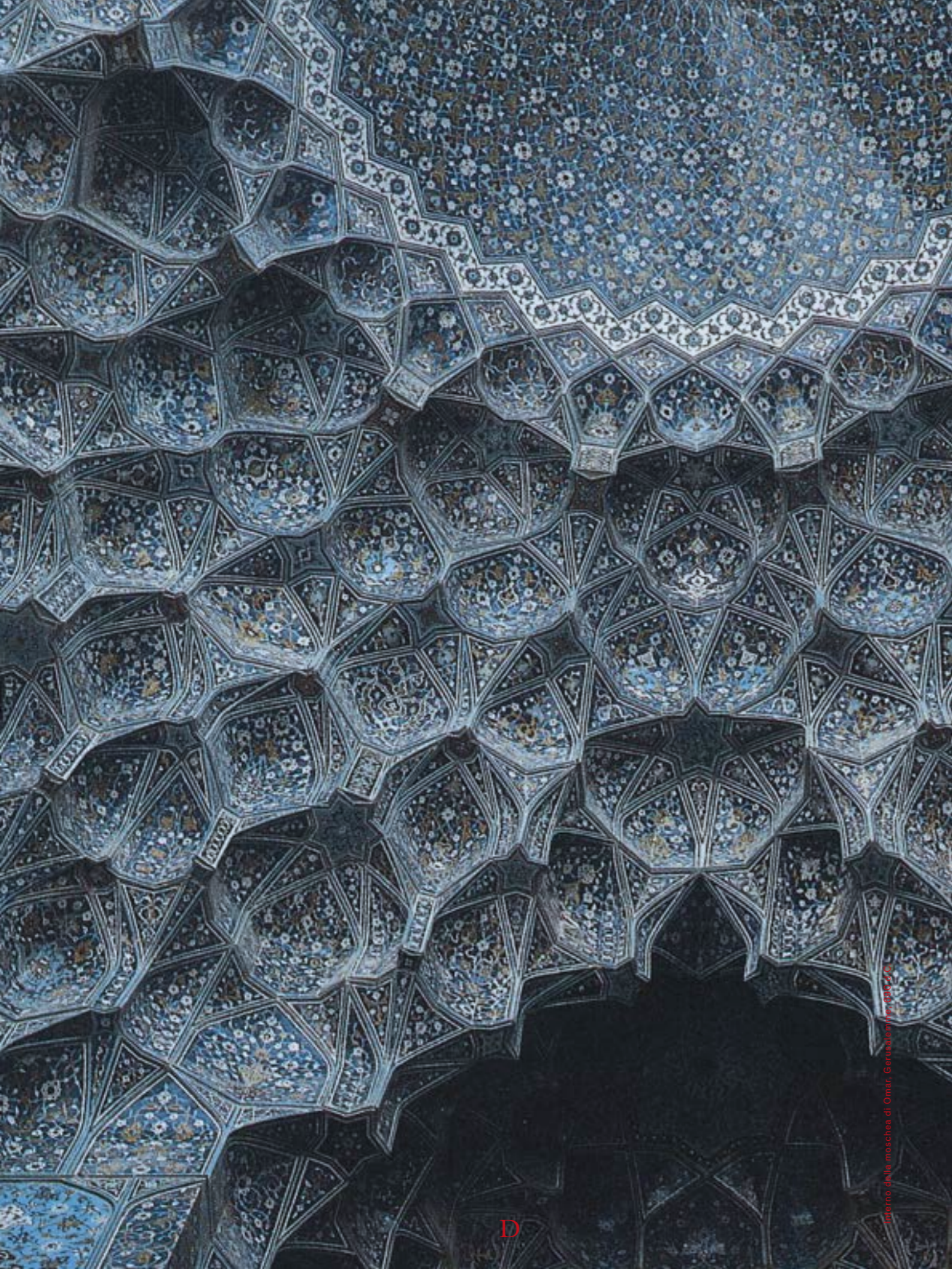

Interno della moschea di Omar, Gerusalemme, 1996/2000

D

Since ancient classical times, and later on throughout the Middle Ages and the Renaissance up to the present, the repetitive game of mathematical sequences and of geometrical compositions has inspired artists and experimenters across the world: the Arabian architects who used a system of niches and stalactites of a prevalingly triangular shape, called “Muqarnas” (initially used alone and with large dimensions, then used repeated in sets and with smaller dimensions) have been a stimulating source of inspiration, but it is the in-depth work conducted by Escher on the combinations of triangles and hexagons that has suggested Febo’s final shape. As in Granada, Jerusalem and Isfahan, in the Alhambra and in the Mosques, the outer volumes are simple and compact, while the inside volumes, thanks to the light that filters through the windows placed all around the base of the cupolas, magically and astoundingly dilate. The same happens in the Febo suspended lamp: both the natural light and the LED light hidden inside the circular frame reflect on the faceted and mirroring surface of the lowered dome and transform the smooth and simple rounded volume of the lamp into a surprising and ever-changing exponential game of defined and luminous refractions.

*“Know that the world from end to end is a mirror; in each atom a hundred suns are concealed”*

*Mahmud Shabistari*

*“Habits take hold only through continuous repetition and long custom”*

*Ibn Khaldun*

E

DE – Das sich wiederholende Spiel aus mathematischen Sequenzen und geometrischen Kompositionen ist seit der klassischen Antike und später im Mittelalter und der Renaissance bis heute eine Quelle der Inspiration für Künstler und Experimentatoren aus aller Welt: Die arabischen Bauherren lieferten mit einem System aus Nischen und Stalaktiten von überwiegend dreieckiger Form, "Muqarnas" genannt (zuerst einzeln in großen Abmessungen und später serienmäßig in kleinen Abmessungen verwendet), eine unerschöpfliche Inspirationsquelle. Erst die faszinierende und tiefgehende Arbeit von Escher an den Kombinationen aus Dreiecken und Sechsecken führte dann jedoch zur endgültigen Form. Wie in Granada, Jerusalem und Isfahan, in der Alhambra und in den Moscheen, sind die äußeren Volumen einfach und kompakt, aber dank des Lichts, das durch die Fenster rund um den Sockel der Kuppeln gefiltert wird, breiten sie sich auf magische und suggestive Weise aus. So transformieren in den Febo-Hängelampen das natürliche Licht und das im kreisförmigen Rahmen verborgene LED-Licht durch Reflexion auf die facettierte und verspiegelte Oberfläche der abgesenkten Kuppel das einfache und glatte rundliche Volumen mit einem überraschenden und stets abwechslungsreichen exponentiellen Spiel kraftvoller und strahlender Lichtbrechungen.

*"Die Welt ist ein Spiegel von Kopf bis Fuß, in jedem Atom gibt es hundert glitzernde Sonnen"*

Mahmud Shabistari

*"Die Traditionen schlagen nur dank vielfältiger Wiederholungen und einer langen Gewohnheit starke Wurzeln"*

Ibn Khaldun

FR – Depuis l'Antiquité classique et au cours du Moyen-Âge et de la Renaissance par la suite – et ceci jusqu'à nos jours – le jeu répétitif des séquences mathématiques et des compositions géométriques a été une source d'inspiration pour les artistes et les chercheurs du monde entier: les bâtisseurs arabes avec un système de niches et de stalactites, surtout de forme triangulaire, appelées "Muqarnas"

(tout d'abord de grande taille et utilisées seules, puis de petite taille servant en série) ont été une bonne source d'inspiration, mais c'est le travail d'Escher, passionnant et approfondi, sur les combinaisons de triangles et d'hexagones qui nous a donné l'idée de la forme finale. Comme à Grenade, Jérusalem et Isfahan, dans l'Alhambra et dans les Mosquées, les volumes des extérieurs sont simples et compacts, tandis qu'à l'intérieur, grâce à la lumière qui filtre à travers les fenêtres disposées tout autour de la base des coupes, ils se dilatent de façon magique et émotionnelle. C'est ainsi que dans les lustres Febo, la lumière naturelle et celle des LED cachées dans le cadre circulaire, en se réfléchissant à la surface faite de facettes et reflétant la coupole rabaissée, transforment le volume simple et lisse arrondi en un jeu surprenant de réfractations accentuées et vives qui change continuellement, de manière exponentielle.

*"Le monde est un miroir de la tête aux pieds, dans chaque atome, il y a cent soleils qui étincellent"*

Mahmud Shabistari

*"Les traditions ne s'enracinent avec force que grâce à diverses répétitions et une longue coutume"*

Ibn Khaldun

ES – Desde la Antigüedad Clásica y luego durante la Edad Media y el Renacimiento hasta nuestros días, el juego repetitivo de las secuencias matemáticas y las composiciones geométricas ha sido fuente de inspiración para los artistas y los experimentadores de todo el mundo: los constructores árabes con un sistema de nichos y estalactitas con forma principalmente triangular llamados "Muqarnas" (en un primer momento usados singularmente en grandes dimensiones y luego repetidos en series de pequeñas dimensiones) han sido una fuente de inspiración estimulante, pero el fascinante y exhaustivo trabajo de Escher sobre las combinaciones de triángulos y hexágonos ha sugerido la forma final. Como en Granada, Jerusalén e Isfahan en la Alhambra y en las mezquitas, los volúmenes de los exteriores son simples y compactos, pero

en el interior, gracias a la luz que filtra a través de las ventanas dispuestas alrededor de la base de las cúpulas, se dilatan de modo mágico e impactante. Así, en las lámparas para colgar Febo la luz natural y la de los LED ocultos en el marco circular que se reflejan sobre la superficie facetada y espejada de la cúpula rebajada, transforman el volumen redondeado simple y liso con un juego exponencial sorprendente y siempre variado de refracciones definidas y brillantes.

*"El mundo es un espejo de la cabeza a los pies, en cada átomo hay cien soles centellantes"*

Mahmud Shabistari

*"Las tradiciones se radican con fuerza solo gracias a varias repeticiones y a una larga costumbre"*

Ibn Khaldun







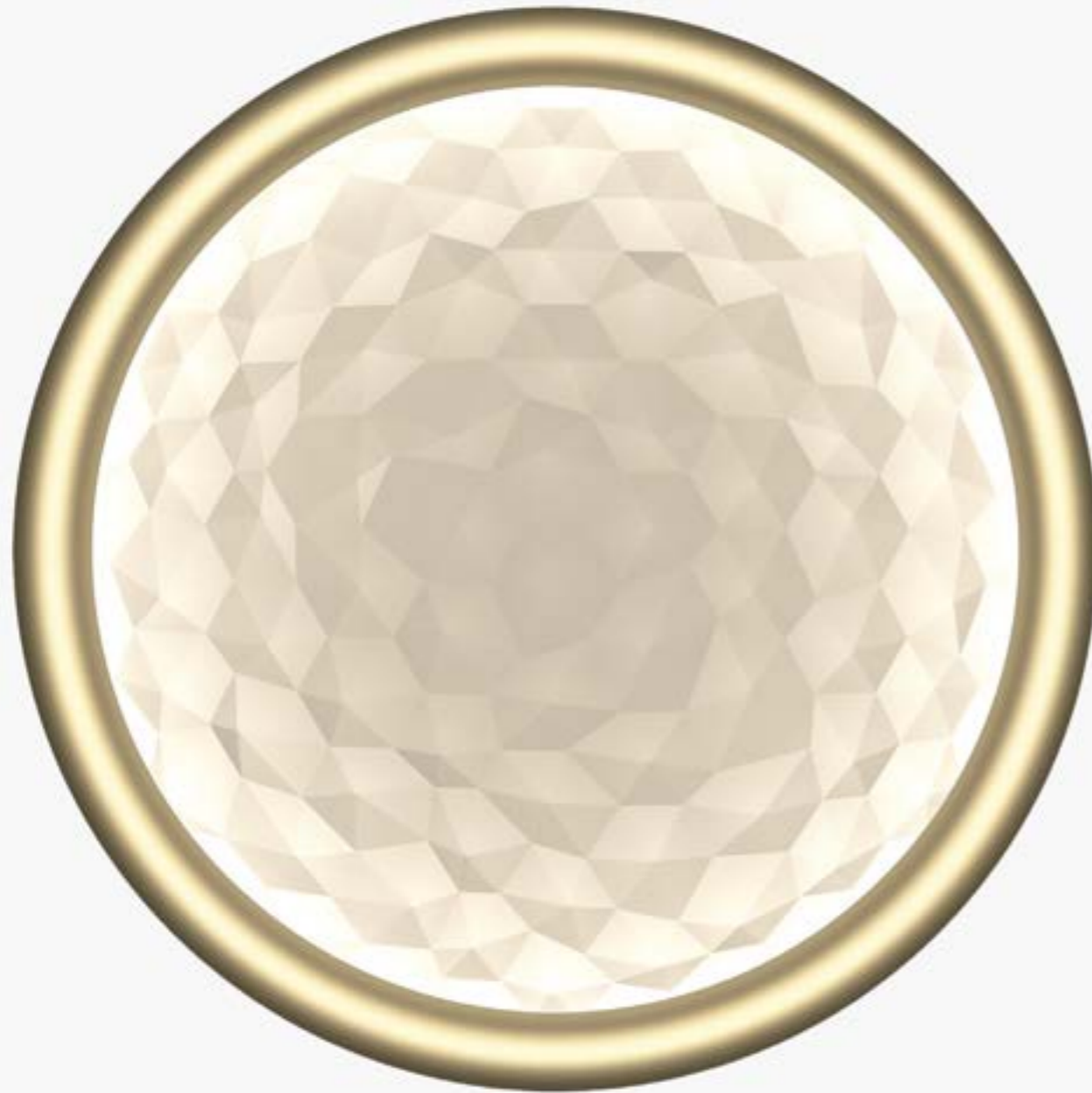

98

# Febo



Design  
Paolo Rizzato

Year  
19

Category: Suspension 

99

Febo: Suspension

cod: H1

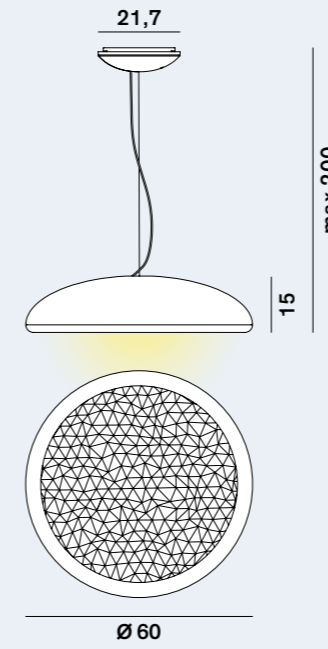

Light Source	MID POWER LED
Power	48 Watt
Kelvin	2.700
Dimmer	phase, 1-10V, dali push
Lumen	3.120
CRI	90

### Catalogue

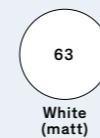

### Satin Collection (upon request)



### Kerakoll Warm Collection (upon request)



# Flow Glass

Dante Donegani & Giovanni Lauda  
2019

IT – È una famiglia di lampade a luce diffusa da tavolo, sospensione e pavimento. Il diffusore in vetro soffiato è caratterizzato da sottili anelli a rilievo. Questi anelli concentrici creano una geometria che richiama le lanterne orientali in carta e bambù, e riprende l'immagine della Flow.

EN – This is a family of table, suspension and floor diffused light lamps. The blown glass diffuser features thin rings in relief that create a geometry similar to that of oriental paper and bamboo lanterns, while repositing the Flow lamp image.

DE – Eine Lampen-Produktfamilie, die mit diffusem Licht arbeitet und in der Tisch-, Hänge- und Stehversion ausgeführt wird. Der Lichtschirm aus geblasenem Glas zeichnet sich durch dünne Reliefringe aus. Diese konzentrischen Ringe erzeugen eine Geometrie, die an orientalische Laternen aus Papier und Bambus erinnert und das Bild von Flow aufnimmt.

FR – Il s'agit d'une série de lampes a lumière diffuse, à utiliser comme lampe de bureau, ou comme lustres, ou au sol. Le diffuseur en verre soufflé est caractérisé par de minces anneaux en relief. Ces anneaux concentriques créent une forme géométrique rappelant les lanternes orientales en papier et en bambou, et reprenant l'image de la version Flow.

ES – Una familia de lámparas de luz difusa de mesa, para colgar y de pavimento. El difusor de vidrio soplado está caracterizado por anillos sutiles en relieve. Estos anillos concéntricos crean una geometría que evoca los faroles orientales de papel y bambú, y retoma la imagen de la Flow.

Focus  
Flow

Giacomo Balla, Compenetrazione iridescente N° 2, 1912



## Flow

Flow reinterpreta un archetipo della storia dell'illuminazione, il globo a luce diffusa, introducendo nuovi materiali e nuove soluzioni. L'obiettivo, presente anche nel nome della lampada è smaterializzare il diffusore tradizionale, cioè il contenitore, per liberare la luce costretta al suo interno e riportarla alla sua natura immateriale, di pura energia, dinamicità e bellezza. Già in alcune celebri lampade moderne il globo luminoso era stato scomposto in dischi di vetro o lamelle di metallo riflettenti. Nella Flow, invece, il diffusore è un unico volume, stampato in materiale plastico ma visivamente scomposto dalla geometria degli anelli concentrici che intercettano e propagano la luce creando un effetto ottico. Infatti la forma del diffusore cambia, secondo il punto di vista, da ellissoidale a sferica. Attraverso questa semplice illusione la sagoma luminosa è sfumata e indistinta; la lampada perde i propri contorni e sembra dissolversi in un flusso di energia, in una vibrazione elettrica. La lampada diventa luce, anzi pura emozione luminosa, come quella sprigionata dal lampione dipinto da Giacomo Balla, al grido di "Uccidiamo il chiar di luna". Agli occhi del pittore futurista la romantica luna piena, offuscata dall'introduzione della luce elettrica e vittima notturna del suo lampione, appariva ormai un vecchio armamentario come il globo di luce diffusa!

Giovanni Lauda

Flow is the reinterpretation of an archetypal lamp, the diffused light globe, but made with new materials and offering new solutions. The aim, also suggested in the lamp's name, is to dematerialize the traditional lampshade, namely the container, to free the light caught inside it and restore its immaterial nature of pure energy, dynamism and beauty. Already in some famous modern lamps, the luminous globe had been broken down into glass discs or reflective metal lamellae. In Flow, instead, the shade consists of a single volume, molded in plastic material but visually broken down by the geometry of the concentric rings that intercept and propagate the light, creating an optical illusion. In fact, the shape of the lampshade changes, according to the point of view, from ellipsoidal to spherical. Through this simple illusion, the luminous outline is hazy and indistinct; the lamp loses its contours and seems to dissolve in a flow of energy, into an electric vibration. The lamp becomes light, indeed, pure luminous emotion, like that released by the street lamp painted by Giacomo Balla, to the cry of "Down with moonlight!". In the eyes of the futurist painter, the romantic full moon, dimmed by the onset of electric lighting and a nocturnal victim of his street lamp, now appeared to be just an old device, like the globe of diffused light!

B



DE – Flow interpretiert einen Archetypus der Beleuchtungsgeschichte, die Kugel mit diffusem Licht, und führt neue Materialien und Lösungen ein. Das auch im Namen der Lampe übernommene Ziel ist es, den traditionellen Lichtschirm, das heißt, den Behälter, zu dematerialisieren, das darin gefangene Licht herauszulassen und es wieder zu seiner immateriellen Natur von reiner Energie, Dynamik und Schönheit zurückzuführen. In einigen berühmten modernen Lampen war die Leuchtkugel bereits in Glasscheiben oder reflektierende Metalllamellen zerlegt worden. In Flow dagegen ist der Lichtschirm ein einzelnes Volumen, das aus Kunststoff geformt ist, jedoch visuell durch die Geometrie der konzentrischen Ringe zerlegt wird, die das Licht abfangen und ausbreiten und so einen Lichteffect erzeugen. Tatsächlich ändert sich die Form des Lichtschirms je nach Standpunkt von ellipsoid zu kugelförmig. Durch diese einfache Täuschung wird die Lichtform verwischt und undeutlich. Die Lampe verliert ihre Konturen und scheint sich in einem Energiefluss, in einer elektrischen Schwingung, aufzulösen. Die Lampe wird zu Licht, oder besser noch zu einem reinen, leuchtenden Gefühl, wie es die von Giacomo Balla gemalte Straßenlampe mit dem Ruf "Lasst uns das Mondlicht töten" vermittelt. In den Augen des futuristischen Malers war der romantische Vollmond, der durch die Einführung von elektrischem Licht getrübt und so zum nächtlichen Opfer des Laternenpfahls wurde, nun ein veralteter Gebrauchsgegenstand wie die diffus strahlende Leuchtkugel.

FR – Flow réinterprète un archétype de l'histoire de l'éclairage, le globe à lumière diffuse, en introduisant de nouveaux matériels et de nouvelles solutions. Le but, s'exprimant également dans le nom de la lampe, est de dématérialiser le diffuseur traditionnel (le récipient), pour libérer la lumière contrainte à l'intérieur et la restituer à sa nature immatérielle d'énergie pure, de dynamisme et de beauté. Dans certaines lampes modernes célèbres, le globe lumineux avait déjà été décomposé en disques de verre ou lamelles de métal

réfléchissant la lumière. Dans Flow, le diffuseur ne forme par contre qu'un seul volume, moulé en matière plastique, mais se décomposant sur le plan visuel en raison de la géométrie des anneaux concentriques qui interceptent et propagent la lumière, en créant ainsi un effet optique. En effet, la forme du diffuseur change selon le point de vue, pour passer de l'ellipse à la sphère. Cette simple illusion fait que la silhouette lumineuse est nuancée et indistincte; la lampe perd ses contours et semble se fondre dans un flux d'énergie, en une vibration électrique. La lampe devient lumière, ou plutôt émotion lumineuse pure et simple, comme celle qui se dégage du réverbère peint par Giacomo Balla, à l'invocation de "Tuons le clair de lune". Aux yeux du peintre futuriste, la pleine lune romantique, éclipsée par l'introduction de la lumière électrique et victime la nuit de son réverbère, semblait appartenir au passé, comme le globe de lumière diffuse.

ES – Flow reinterpreta un arquetipo de la historia de la iluminación —el globo de luz difusa— introduciendo nuevos materiales y nuevas soluciones. El objetivo, que se refleja también en el nombre de la lámpara, es desmaterializar el difusor tradicional, es decir, el contenedor, para liberar la luz encerrada en su interior y llevarla a su naturaleza inmaterial, de pura energía, dinamismo y belleza. Ya en algunas célebres lámparas modernas, el globo luminoso había sido descompuesto en discos de vidrio o láminas de metal reflectantes. En vez, en la Flow el difusor es un volumen único, moldeado en material plástico pero visualmente descompuesto por la geometría de los anillos concéntricos que interceptan y propagan la luz creando un efecto óptico. La forma del difusor cambia, según el punto de vista, de elipsoidal a esférica. A través de esta simple ilusión, la forma luminosa es esfumada e indiferenciada. La lámpara pierde sus contornos y parece disolverse en un flujo de energía, en una vibración eléctrica. La lámpara se transforma en luz; más aún, en pura emoción luminosa, como aquella que salió de la farola pintada por Giacomo Balla, al grito de "Matemos el claro

de luna". A los ojos del pintor futurista, la romántica luna llena, ofuscada por la introducción de la luz eléctrica y víctima nocturna de su farola, parecía un viejo aparato como el globo de luz difusa!





104

# Flow Glass



105

Flow Glass: Suspension / Ceiling

cod: H1, H2, H3, H4

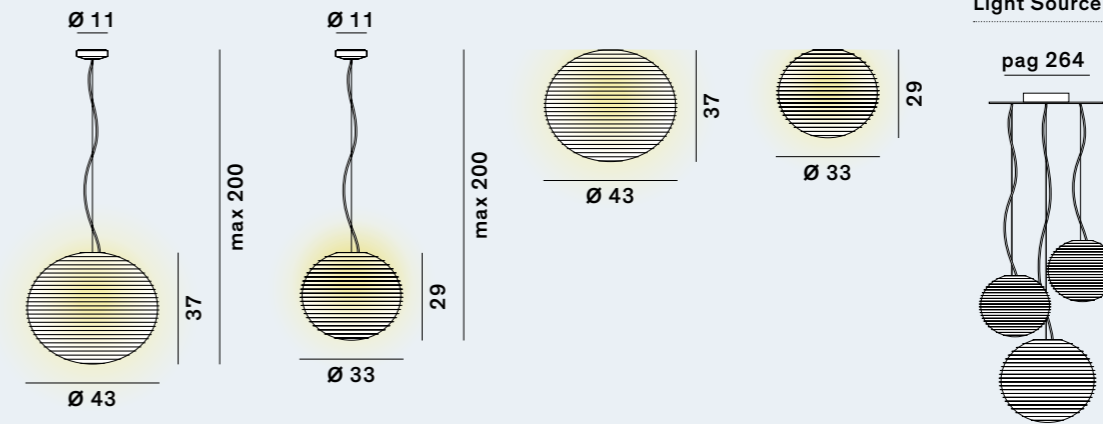

Flow: Floor / Table

cod: F1, F2, T2, T3, T4

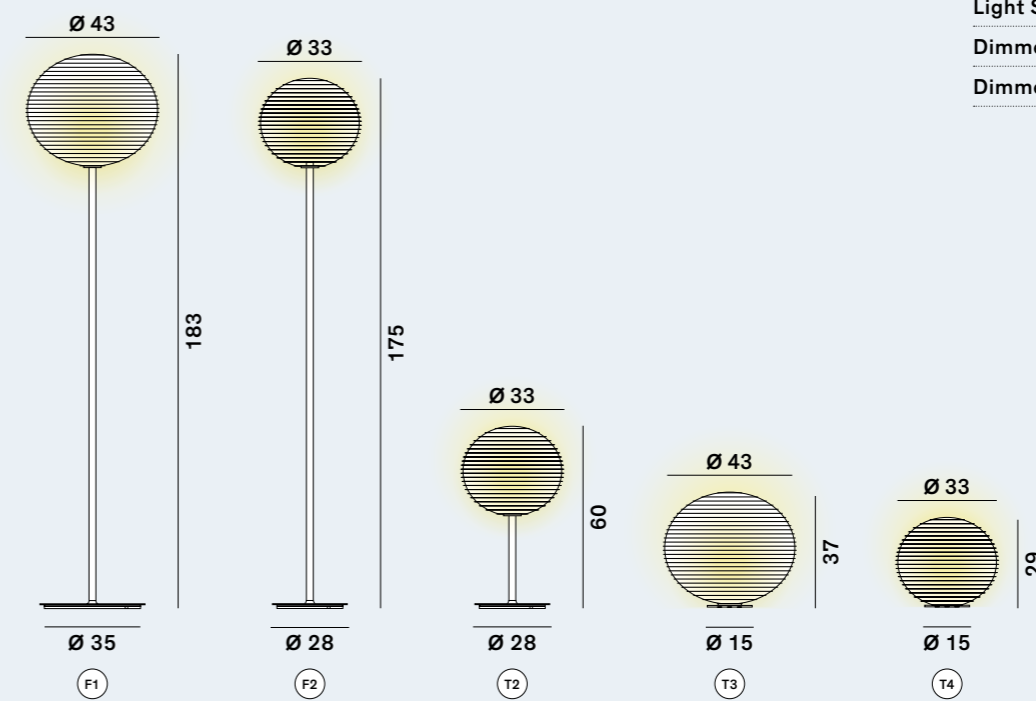

Catalogue

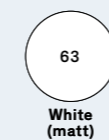

# Frame

Dante Donegani & Giovanni Lauda  
2015 / 2017

IT – La struttura è composta da due elementi in alluminio estruso: uno esterno a forma di anello e uno interno che permette la diffusione simmetrica della luce verso l'alto e verso il basso. Ispirata all'idea di una maniglia fissata a muro, Frame offre un'elevata performance luminosa.

EN – The structure consists of two extruded aluminium elements: an outer ring-shaped element and an inner one that allows the symmetrical diffusion of the light upwards and downwards. Inspired by the idea of a wall-mounted handle, Frame provides high light performance.

DE – Die Struktur besteht aus zwei stranggepressten Aluminiumelementen: einem äußeren, ringförmigen Element und einem inneren Element, das die symmetrische Abstrahlung des Lichts nach oben und unten gestattet. Frame inspiriert an einem an der Wand befestigten Griffs und bietet hohe Lichtausbeute.

FR – La structure se compose de deux éléments en aluminium extrudé: un élément externe en forme de bague et un élément interne qui permet une diffusion symétrique de la lumière vers le haut et vers le bas. Inspirée par l'idée d'une poignée fixée au mur, Frame garantit une performance lumineuse très élevée.

ES – La estructura está compuesta por dos elementos de aluminio extrudido: uno exterior con forma de anillo y otro interior que permite la difusión simétrica de la luz hacia arriba y hacia abajo. Frame, inspirada en la idea de una manija fijada en la pared, ofrece un elevado rendimiento luminoso.







110



Rotaliana

111



Donegani & Lauda

# Frame

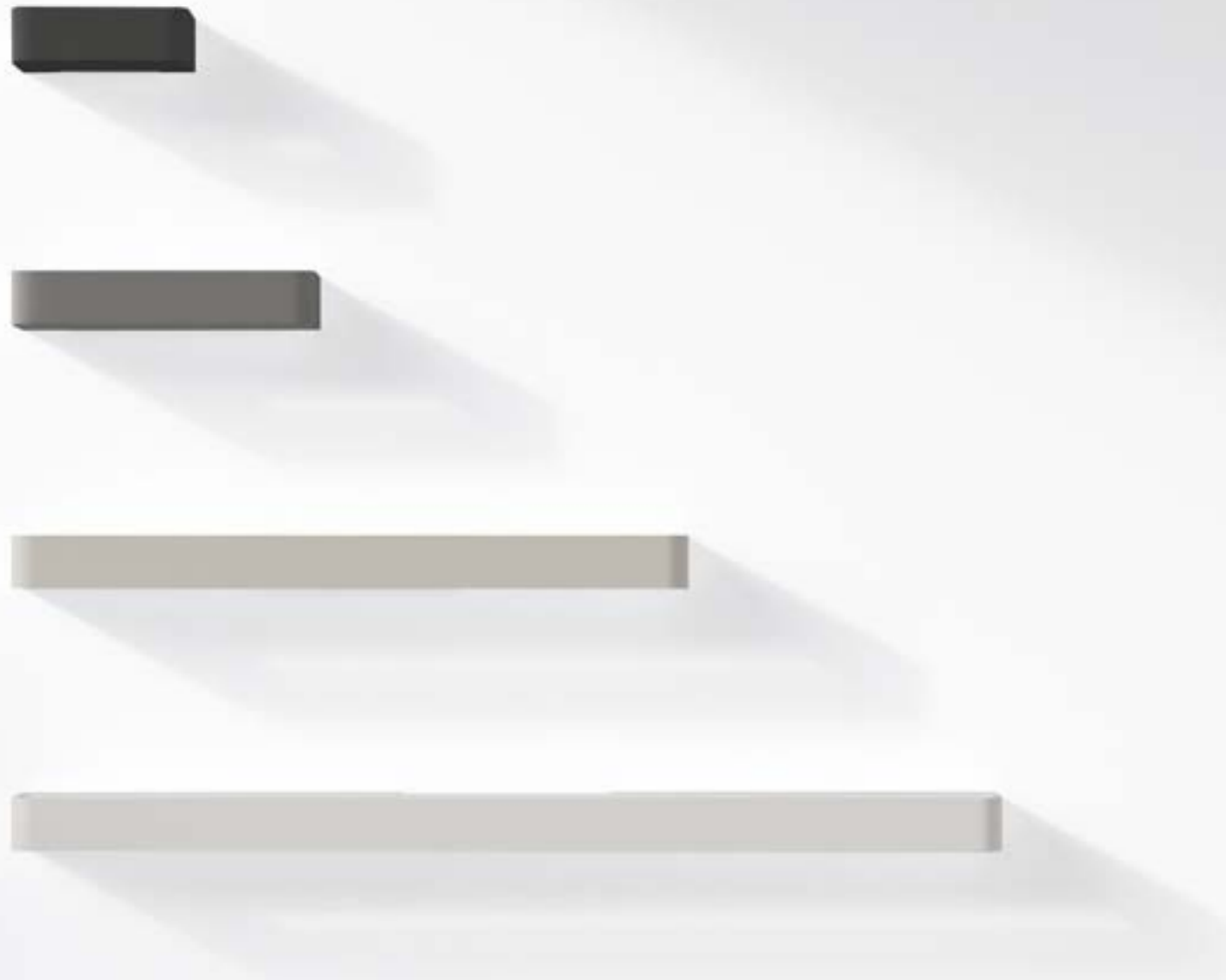

## Frame: Wall

cod: W1, W2

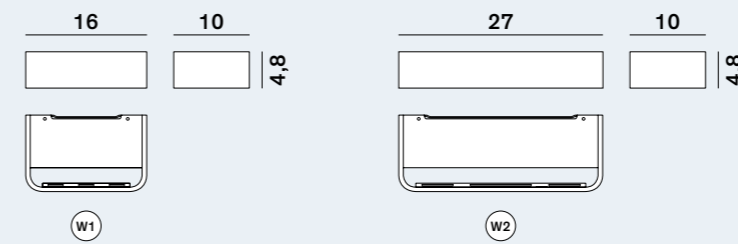

up and down

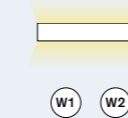

Light Source	MID POWER LED
Power (W1)	16 Watt
Power (W2)	29 Watt
Kelvin	2.700, 3.000
Dimmer (W1)	phase
Dimmer (W2)	phase, dali, push
Lumen (W1)	1.600
Lumen (W2)	3.200
CRI	90

## Frame: Wall

cod: W3, W4

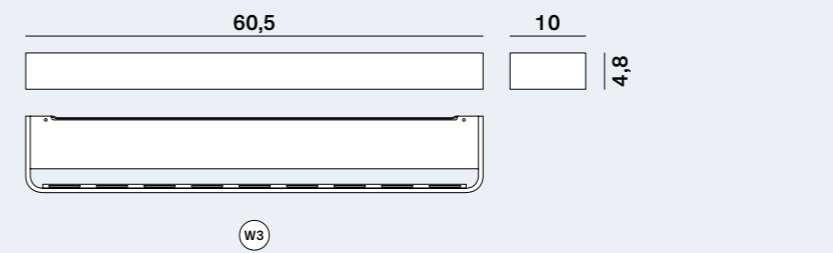

up and down



Light Source	MID POWER LED
Power (W3)	45 Watt
Power (W4)	57 Watt
Kelvin	2.700, 3.000
Dimmer (W3) (W4)	dali, push
Lumen (W3)	4.950
Lumen (W4)	6.390
CRI	90

### Catalogue

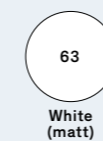

63  
White (matt)

### Satin Collection (upon request)



20 Graphite 33 Royal gold 43 Silver 48 Dark bronze 62 Black (matt) 64 Bronze 65 Champagne

### Galvanic

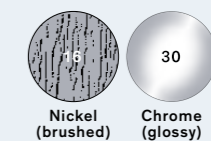

15 Nickel (brushed) 30 Chrome (glossy)

### Kerakoll Warm Collection (upon request)



W2 Sand W4 Rope color W6 Dove-gray W8 Coffee

### Metallic Collection (upon request)



14 Antique brass 19 Pelter delabrè 22 Copper delabrè 23 Gold delabrè

# Furin

Kengo Kuma  
2011

IT – Furin (in giapponese campana a vento) è un sistema a sospensione composto da elementi tubolari in alluminio, rivestiti in tessuto o verniciati, in cui è inserita una sorgente luminosa LED. Questi pendenti sono disposti linearmente lungo un binario oppure collegati a gruppi ad un rosone. Il sistema prevede l'utilizzo di tubi di lunghezza differente (da 100 cm a 300 cm) per realizzare dei lampadari oppure per ottenere, con una illuminazione a livello del pavimento, uno schermo morbido in grado di definire gli spazi con la luce.

EN – Furin (that in Japanese means 'wind chime') is a suspension system consisting of tubular aluminum elements lined with fabric or painted, in which a LED light source is inserted. These pendants can be arranged in line along a rail or attached in groups to a ceiling rose. The system envisages the use of tubes of varying length (from 100 cm to 300 cm) to create chandeliers or to obtain a soft screen that, by shedding light at floor level, defines the space with light.

DE – Furin (japanisch für Windglocke) ist ein Aufhängungssystem aus röhrenförmigen Aluminiumelementen, die mit Stoff überzogen oder lackiert sind und in das ein LED-Leuchtmittel eingesetzt wird. Diese Hängeelemente sind linear entlang einer Schiene angeordnet oder in Gruppen zu einer Deckenrosette verbunden. Das System sieht den Einsatz von Röhren unterschiedlicher Länge (von 100 cm bis 300 cm) vor, um Kronleuchter herzustellen oder mit Beleuchtung auf Bodenhöhe einen weichen Lichtschirm zu erhalten, der die Räume mit Licht definieren kann.

FR – Furin (cloche à vent en japonais) est un système de lustre fait d'éléments tubulaires en aluminium, recouverts de tissu ou peints, où se trouve une source lumineuse à LED. Ces éléments pendants sont placés de façon linéaire, le long d'une voie, ou unis en groupes à une rosace. Le système prévoit l'emploi de tuyaux de plusieurs longueurs (de 100 cm à 300 cm) pour réaliser des lampadaires ou pour obtenir, avec un éclairage au niveau du sol, un écran souple, en mesure de définir les espaces à l'aide de la lumière.

ES – Furin (en japonés, campana de viento) es un sistema colgante compuesto por elementos tubulares de aluminio, revestidos en tejido o barnizados, en el cual está insertada una fuente luminosa LED. Estos colgantes están dispuestos linealmente a lo largo de un riel o bien conectados en grupos a un rosetón. El sistema prevé el uso de tubos de largos diferentes (de 100 cm a 300 cm) para realizar arañas o para obtener, con iluminación al nivel del piso, una pantalla blanda capaz de definir los espacios con la luz.





118

Furin



119

Furin: Suspension

cod: H1

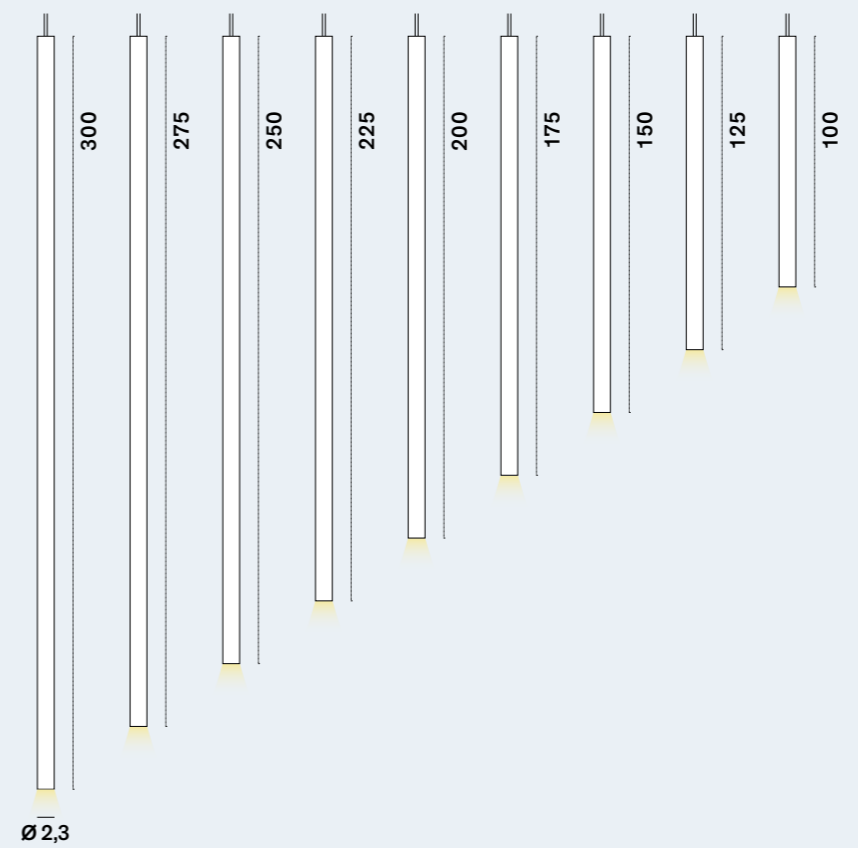

Light Source	MID POWER LED
Power	3 Watt
Kelvin	2.700
Lumen	150
CRI	90

Rosone / Ceiling roses (altre configurazioni su richiesta / other configurations on request)

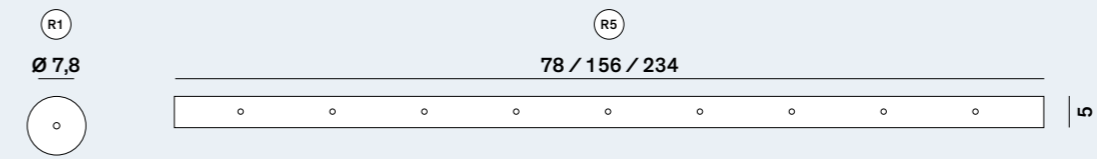

# Goccia

Andrea Branzi  
2003

IT – La sua forma richiama quella di una goccia o di un gioiello pendente originato da due elementi sovrapposti in vetro che non mostrano discontinuità nell'eleganza e compattezza del segno. La parte superiore di forma conica è riproposta nel rosone, simulando una riflessione speculare sul soffitto.

EN – Its shape evokes that of a drop of liquid or of a gem pendant, originating from two juxtaposed glass elements showing a consistently elegant and compact sign. The cone-shaped top part is inversely mirrored in that of the ceiling rose.

DE – Die Form erinnert an die eines Tropfens oder eines Schmuckanhängers, der aus zwei überlagerten Glaselementen gebildet wird, die keinerlei Unstetigkeit in der Eleganz und Kompaktheit des Zeichens aufweisen. Der obere, konische Teil findet sein Gegenstück in der Rosette, wodurch der Eindruck einer Spiegelung an der Decke entsteht.

FR – Sa forme fait penser à une goutte ou à un bijou pendentif engendré par deux éléments superposés en verre sans solution de continuité pour ce qui est de l'élégance et du caractère compact du signe. La partie supérieure en forme de cône est reprise dans la rosette, en simulant une réflexion spéculaire sur le plafond.

ES – Su forma se asemeja a una gota o un colgante y se origina en dos elementos superpuestos de vidrio que guardan armonía en la elegancia y la fluidez del diseño. La parte superior cónica se vuelve a proponer en el rosetón, simulando un reflejo especular en el cielorraso.







124

# Goccia



125

Goccia: Suspension

cod: H1, H2

Light Source

E27 LED

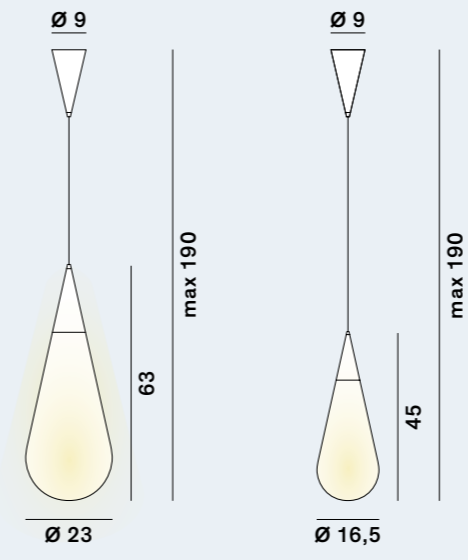

Design  
Andrea Branzi

Year  
03

Category: Suspension 

Catalogue



# InOut

R.T.D.  
2017

IT – InOut è una lampada da parete perfetta sia per l'interno che per l'esterno. Interamente realizzata in alluminio, è arricchita da due lastre di vetro che schermano la luce diretta dei LED e la propagano in modo omogeneo in tutto l'ambiente.

EN – The LED wall lamp InOut is perfect for both indoor and outdoor use. Entirely made of aluminium, it is enriched by two glass plates that shield the direct light of the LEDs and diffuse it evenly throughout the room.

DE – Die LED-Wandleuchte InOut eignet sich perfekt sowohl für Innenräume als auch fürs Freie. Sie besteht vollständig aus Aluminium und ist mit zwei Glasplatten bereichert, die das direkte LED-Licht abschirmen und ein homogenes Licht im ganzen Raum verbreiten.

FR – L'applique à LEDs InOut s'adapte aussi bien à une utilisation intérieure qu'extérieure. Entièrement réalisée en aluminium, elle est enrichie de deux plaques de verre qui filtrent la lumière directe des LEDs et la diffusent de manière uniforme dans tout le milieu ambiant.

ES – La aplique LED InOut es perfecta tanto para interior como para exterior. Realizada totalmente de aluminio, está enriquecida por dos placas de vidrio que hacen de pantalla a la luz directa de los LEDs y la propagan de manera homogénea por todo el ambiente.





130

InOut



131

InOut: Wall

cod: W1, W2 – indoor

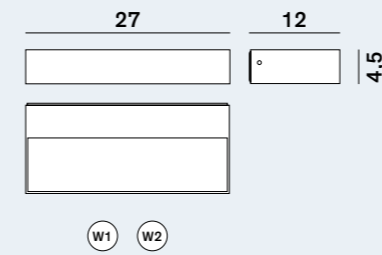

up or down

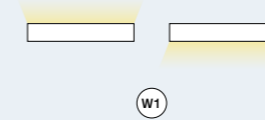

up and down

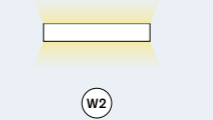

Light Source	MID POWER LED
Power	29 Watt
Kelvin	2.700, 3.000
Dimmer	phase
Lumen (W1)	2.000
Lumen (W2)	2.250
CRI	90
IP	65

Catalogue

Satin Collection (upon request)

Kerakoll Warm Collection (upon request)

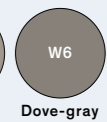
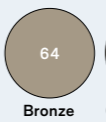
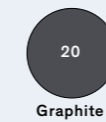

InOut: Wall

cod: W1, W2 – outdoor

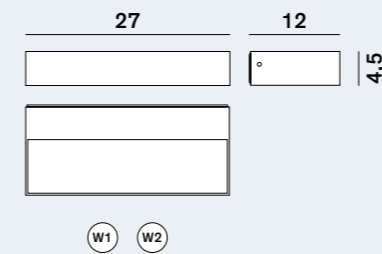

up or down

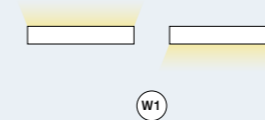

up and down

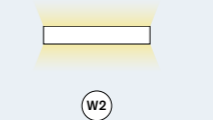

Light Source	MID POWER LED
Power	29 Watt
Kelvin	2.700, 3.000
Lumen (W1)	2.000
Lumen (W2)	2.250
CRI	90
IP	65

Catalogue



# Ipe

Dante Donegani & Giovanni Lauda  
2004 / 2021

IT – I modelli Ipe sono una famiglia di lampade da parete con emissione di luce indiretta, verso l'alto e verso il basso, che garantiscono un ottimo comfort visivo abbinato ad un'inaspettata resa luminosa. Impiegano sorgenti LED ad alto rendimento. La forma della lampada si ispira alla sezione dei profilati metallici usati in architettura, da cui il nome della lampada.

EN – Ipe W is a family of wall lamps providing indirect light both upward and downward, that guarantee an excellent visual comfort as well as an unexpected light output. They function with high-performance LED sources. The shape of the lamp draws its inspiration from the metal beams used in architecture, hence the name of the lamp.

DE – Die Modelle Ipe W sind eine Familie von Wandleuchten mit indirekter Lichtausstrahlung nach oben und nach unten, die einen ausgezeichneten Sehkomfort und eine unerwartete Lichtausbeute garantieren. Sie nutzen Hochleistungs-LED-Lichtquellen. Die Form der Leuchte inspiriert sich an den in der Architektur eingesetzten Metallprofilen, denen sie auch ihren Namen verdankt.

FR – Les modèles Ipe W constituent une série d'appliques émettant de la lumière de façon indirecte, vers le haut et vers le bas, ce qui garantit un confort visuel optimal, ainsi qu'un effet lumineux inattendu. Elles disposent de sources LED à haut rendement. La forme de la lampe a été inspirée par celle des profilés métalliques utilisés en architecture, d'où le nom de la lampe.

ES – Los modelos Ipe W son una familia de lámparas de pared con emisión de luz indirecta, hacia arriba y hacia abajo, que garantizan un óptimo confort visual y una elevada eficiencia luminosa. Utilizan luces LED de alto rendimiento. Su forma está inspirada en la sección de los perfilados metálicos utilizados en arquitectura, de los cuales la lámpara también toma su nombre.







138

Ipe



139

Ipe: Wall

cod: W1

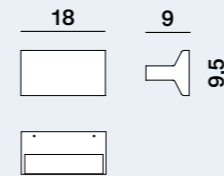

up and down

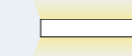

Light Source	MID POWER LED
Power	16 Watt
Kelvin	2.700, 3.000
Dimmer	phase
Lumen	1.320
CRI	90

Ipe: Wall

cod: W2

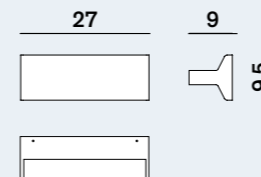

up and down



Light Source	MID POWER LED
Power	29 Watt
Kelvin	2.700, 3.000
Dimmer	phase, push, dali
Lumen	2.650
CRI	90

Ipe: Wall

cod: W3

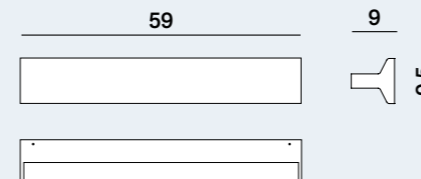

up and down



Light Source	MID POWER LED
Power	45 Watt
Kelvin	2.700, 3.000
Dimmer	push, dali
Lumen	4.250
CRI	90

Ipe: Wall

cod: W4

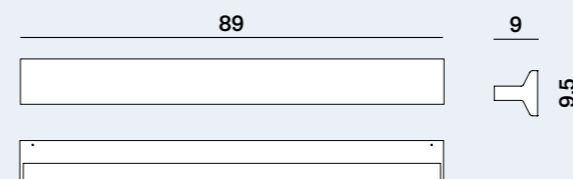

up and down

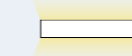

Light Source	MID POWER LED
Power	57 Watt
Kelvin	2.700, 3.000
Dimmer	push, dali
Lumen	5.380
CRI	90

Catalogue

Satin Collection (upon request)



Kerakoll Warm Collection (upon request)

Metallic Collection (upon request)





# Lightwire

Dante Donegani & Giovanni Lauda  
2003 / 2019

**IT – È una lampada da terra a luce indiretta, realizzata in tondino di ferro elettrosaldato. Nella versione attuale, nell'anello che chiude in alto la struttura metallica, è integrata una sorgente LED super piatta. Questa novità tecnica garantisce una maggiore intensità luminosa (4.570 lumen) e una ulteriore smaterializzazione del modello. Nel centro della lampada è posizionato un elemento in policarbonato trasparente e acciaio contenente il dimmer / interruttore sensoriale.**

**EN – This is an indirect light floor lamp made with electro-welded metal rods. In its current version, in the ring that binds the upper section of the structure is inserted a super-flat LED source. This technical addition provides greater light intensity (4.570 lumen) and makes the model appear even more dematerialised. At the centre of the lamp there is a clear polycarbonate and steel element that contains the dimmer / sensorial switch.**

**DE – Eine aus elektrogeschweißten Eisenstäben bestehende Stehlampe mit indirektem Licht. In der aktuellen Version ist ein extraflaches LED-Leuchtmittel in den Ring integriert, der die Metallstruktur oben abschließt. Diese technische Innovation garantiert eine höhere Lichtstärke (4.570 Lumen) und eine weitere Entmaterialisierung des Modells. Im Zentrum der Lampe befindet sich ein transparentes Element aus Polycarbonat und Stahl, das den Dimmer / Sensor-Schalter enthält.**

**FR – Il s'agit d'un lampadaire à lumière indirecte, fait d'une tige de fer électro-soudé. Dans la version actuelle, une source LED extra plate est incorporée dans l'anneau qui ferme la structure métallique dans le haut. Cette nouveauté technique garantit le maximum d'intensité lumineuse (4.570 lumens) et encore plus de dématérialisation du modèle. Un élément en polycarbonate transparent et en acier est positionné au milieu de la lampe pour loger le gradateur de lumière / interrupteur sensoriel.**

**ES – Una lámpara de pie con luz indirecta, realizada con una varilla de hierro electrosoldada. En la versión actual, el anillo que cierra en lo alto la estructura metálica contiene una fuente LED súper plana. Esta novedad técnica garantiza una mayor intensidad luminosa (4.570 lúmenes) y una ulterior desmaterialización del modelo. En el centro de la lámpara hay un elemento de policarbonato transparente y acero que contiene el dimmer / interruptor sensorial.**

Focus  
Lightwire



Luciano Baldessari, Luminator Bernocchi, 1929

## Lightwire

Lightwire è la smaterializzazione del luminator modernista, la sua rappresentazione con un programma di modellazione wire-frame di grafica computerizzata. Composta da sottili linee di metallo da cui è stata eliminata la materia in eccesso, la lampada è una scultura leggera e trasparente, priva di superfici solide che sembra un diagramma tridimensionale. La sua struttura, realizzata in tondino di ferro elettrosaldato per punti, richiama quella delle sedie di Eames e di Bertonia in cui il corpo galleggia, seduto su una scocca trasparente modellata con dei fili d'acciaio. Anche nella Lightwire gli elementi tecnici, indipendenti dalla struttura, galleggiano visivamente dentro di questa. Al centro della lampada è posizionato un elemento in policarbonato trasparente contenente il dimmer/interruttore sensoriale e un led notturno; il disco tendi-cavo, stampato anch'esso in policarbonato trasparente, è montato ad incastro nell'anello della base. In alto, il riflettore in metallo per l'emissione a luce indiretta e il vetro stampato nella versione a luce diffusa sono stati sostituiti da una scheda LED integrata nella struttura: un ulteriore passo verso la smaterializzazione del luminator.

Lightwire is the dematerialization of the modernist Luminator lamp and looks as if it were made using a computer-aided wire-frame graphic modeling program. Made using thin metal rods from which all excessive matter has been eliminated, the lamp is a light and transparent sculpture without solid surfaces that looks like a 3D diagram. Its structure, formed by electro-spot-welded metal rods, evokes the shape of the Eames and Bertonia chairs in which the body floats, placed in a transparent chassis made of steel wire. In Lightwire too, the technical elements-independent from its structure-visually float inside it. At the centre of the lamp is a clear polycarbonate element that contains the dimmer/sensorial switch and a night LED. The cable-tensioning disc, also made of moulded clear polycarbonate, is wedged into the base ring. In the upper portion, the metal reflector for indirect light emission and the moulded glass in the diffused light version have been replaced with a LED board built into the structure: this is a further step in the dematerialisation of the Luminator.

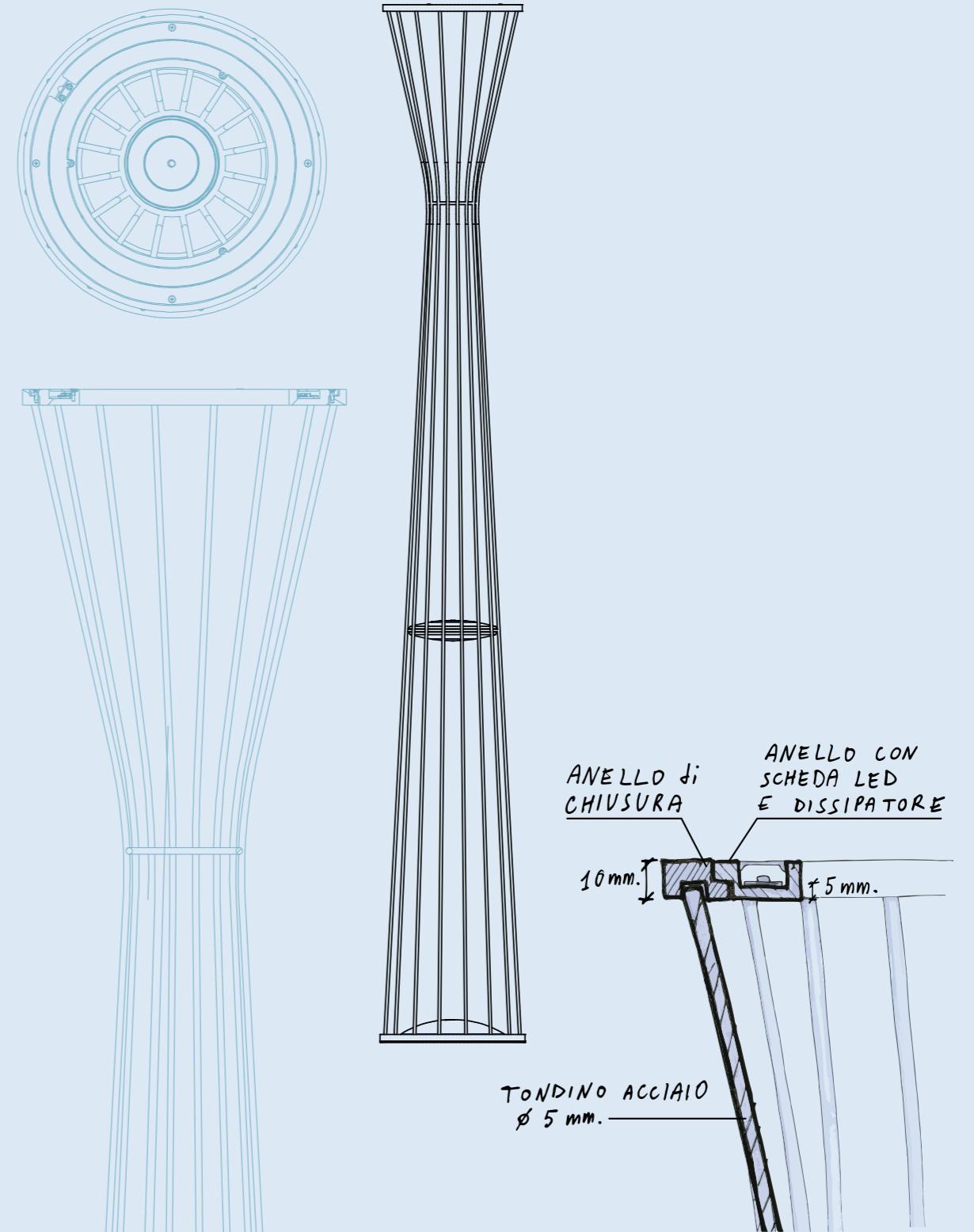

DE – Lightwire ist die Entmaterialisierung des modernistischen Luminators, seine Darstellung mit einem Computergrafik–Wireframe–Modellierungsprogramm. Die Lampe besteht aus feinen Metalllinien, aus denen der Materialüberschuss entfernt wurde. Sie ist eine leichte und transparente Skulptur ohne feste Oberflächen, die wie ein dreidimensionales Diagramm erscheint. Ihre Struktur, die aus elektro–punktgeschweißten Eisenstäben besteht, erinnert an die Stühle von Eames und Bertoia, in denen der auf einem transparenten, mit Stahldrähten modellierten Aufbau sitzende Körper quasi schwebt. Auch im Lightwire schweben die technischen Elemente, unabhängig von der Struktur, visuell darin. Im Zentrum der Lampe befindet sich ein transparentes Polycarbonat–Element, das den Dimmer/Sensor–Schalter und eine Nacht–LED enthält. Die ebenfalls aus transparentem Polycarbonat gegossene Kabelspannscheibe wird durch Verriegelung in den Sockelring eingepasst. Oben wurden der Metallreflektor für die indirekte Beleuchtung und das bedruckte Glas der Ausführung mit diffusem Licht durch eine in die Struktur integrierte LED–Platine ersetzt: ein weiterer Schritt in Richtung Entmaterialisierung des Luminators.

FR – Lightwire est la dématérialisation du luminator moderniste, sa représentation avec un logiciel de modelage d'ébauche structurelle en infographie. Composée de lignes de métal minces dont la matière en excès a été éliminée, la lampe est une sculpture légère et transparente, dépourvue de surfaces solides, qui donne l'impression d'un diagramme tridimensionnel. Sa structure, en tige de fer électro–soudée par points, rappelle celle des chaises d'Eames et de Bertoia où le corps flotte, en reposant sur une coque transparente modelée avec des fils d'acier. Dans Lightwire également, les éléments techniques sont indépendants de la structure où on les voit flotter. Un élément en polycarbonate transparent contenant le gradateur de lumière/l'interrupteur sensoriel, ainsi qu'une LED pour la nuit, est

positionné au milieu de la lampe; le disque de tension du câble, moulé lui aussi en polycarbonate transparent, est encastré dans l'anneau de la base. En haut, le réflecteur en métal pour l'émission de lumière indirecte et le verre moulé dans la version à lumière diffuse ont été remplacés par une fiche LED incorporée dans la structure: un autre pas dans la direction de la dématérialisation du luminator.

ES – Lightwire es la desmaterialización de la Luminator modernista, su representación con un programa de modelado wire–frame de gráfica computarizada. Compuesta por líneas sutiles de metal, donde se ha eliminado el material en exceso, la lámpara es una escultura ligera y transparente, sin superficies sólidas, que parece un diagrama tridimensional. Su estructura, realizada en varillas de hierro electrosoldado por puntos, se asemeja a la de las sillas Eames y Bertoia en las cuales el cuerpo flota, apoyado sobre un armazón transparente modelado con hilos de acero. También en la lámpara Lightwire, los elementos técnicos, independientes de la estructura, flotan visualmente dentro de ella. El centro de la lámpara contiene un elemento de polycarbonato transparente donde se encuentra el dimmer/interruptor sensorial y un LED nocturno. El disco pasacable, también de polycarbonato transparente, está encastrado en el anillo de la base. En lo alto, el reflector de metal para la emisión de luz indirecta y el vidrio moldeado en la versión para luz difusa, han sido sustituidos por una tarjeta LED integrada en la estructura. Un ulterior paso hacia la desmaterialización de la Luminator.



142

# Lightwire

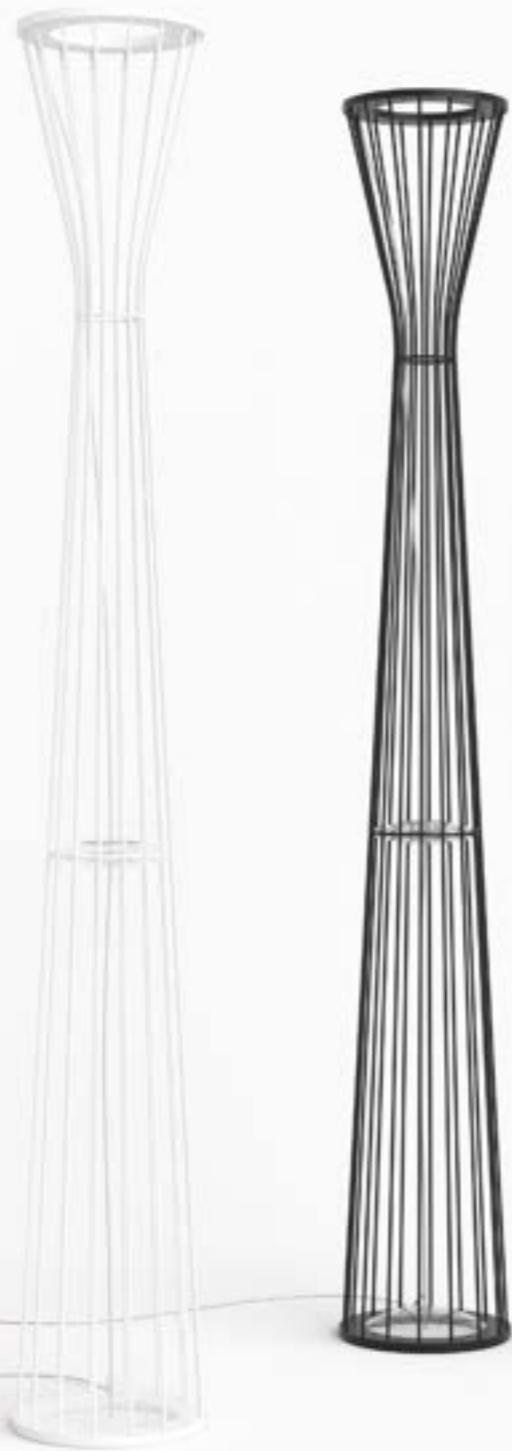

Design  
Donegani & Lauda

Year  
03 / 19

Category: Floor 

143

Lightwire: Floor

cod: F1

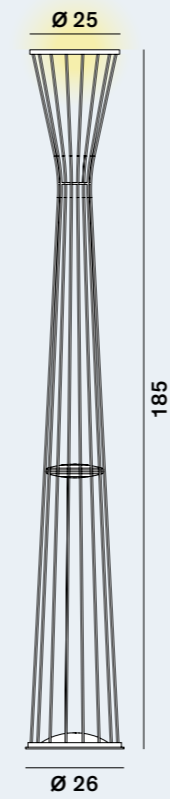

Light Source	MID POWER LED
Power	43 Watt
Kelvin	3.000
Dimmer	touch
Lumen	4.570
CRI	90

Catalogue

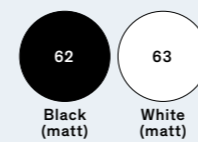

# Luxy

Dante Donegani & Giovanni Lauda  
2002

IT – Luxy è una lampada “classica”, concepita come l’evoluzione degli apparecchi tecnici a bracci snodati. L’impiego di un diffusore in vetro trattato con vernici colorate permette di ottenere un’emissione di luce diretta e diffusa, con tonalità cromatiche calde ed eleganti.

EN – Luxy is a “classical” lamp designed to be the evolution of technical fixtures with articulated arms. The use of a glass shade treated with coloured paints provides for the emission of direct and diffused light featuring warm and elegant chromatic tones.

DE – Luxy ist eine “klassische” Lampe, die als Weiterentwicklung der technischen Geräte mit Gelenkarmen konzipiert wurde. Die Verwendung eines Lampenschirms aus farbig lackiertem Glas gestattet es, eine direkte und diffuse Abstrahlung des Lichts in warmen, eleganten Farben zu erzielen

FR – Luxy est une lampe «classique», conçue comme l’évolution des appareils techniques à bras articulés. L’utilisation d’un diffuseur en verre traité avec des peintures colorées permet d’obtenir une émission de lumière directe et diffuse, avec des tons chauds et élégants.

ES – Luxy es una lámpara “clásica”, concebida como evolución de los aparatos técnicos de brazos articulados. El uso de un difusor de vidrio tratado con barnices de color permite obtener una emisión de luz directa y difusa, con tonalidades cromáticas cálidas y elegantes.











152

Luxy



Design  
Donegani & Lauda

Year  
02

Category:  
Suspension / Ceiling / Wall / Floor / Table



153

Luxy: Floor / Table

cod: F1, T1, T2

Light Source E14 LED

Ø 13,5

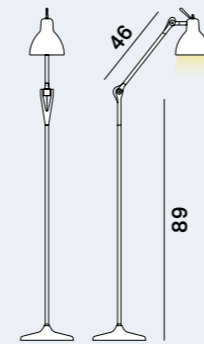

Ø 20,4

Ø 13,5

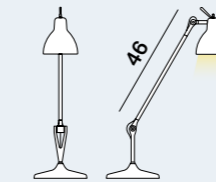

Ø 20,4

Ø 13,5

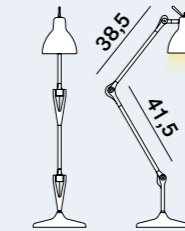

Ø 20,4

Luxy: Wall

cod: W0, W1, W2

Light Source E14 LED

Ø 13,5

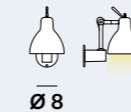

Ø 8

Ø 13,5

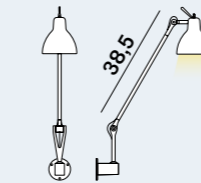

Ø 8

Ø 13,5

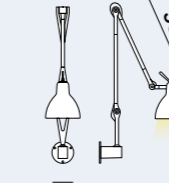

Ø 8

41,5

Luxy: Ceiling-Wall / Ceiling / Suspension

cod: H0, H1, H5

Light Source E14 LED

Ø 10



Ø 13,5

Ø 10

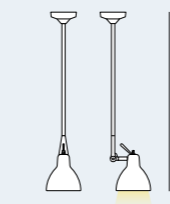

Ø 13,5

Ø 7,8



Ø 13,5

pag 264

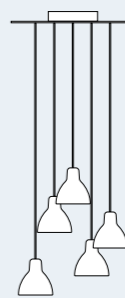

H5

Catalogue



Diffuser (glass)



Coloured cable (H5)

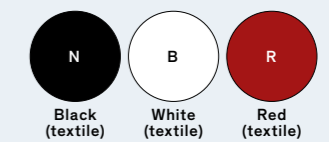

# Luxy Glam

Dante Donegani & Giovanni Lauda  
2020

IT – Luxy è stata la prima lampada del catalogo Rotaliana, disegnata nel 2002: un modello al tempo stesso originale e familiare. Introduceva elementi in materiale plastico insieme al vetro e al metallo e ricordava i modelli storici di lampade da tavolo con i movimenti bilanciati. Utilizzava sia delle molle nascoste che degli snodi frizionati e, per renderla più domestica, un cappello in vetro colorato che diffondeva in parte la luce nell'ambiente. Dopo quasi un vent'anni la famiglia Luxy si allarga: due nuovi modelli, terra e tavolo, caratterizzati da forme semplificate, ad uso prettamente domestico. Il cappello, l'elemento che maggiormente caratterizza la famiglia delle lampade Luxy, è riproposto in nuove varianti di colore: oro, rame, fumé.

EN – Luxy, designed in 2002, was the first lamp to be showcased in the Rotaliana catalogue, and was at the same time an original and yet familiar model. It introduced elements in plastic together with glass and metal, and it harked back to the historically renowned desk lamps with balanced arms. Its movement was based on hidden springs and on friction joints and, to make it more homelike, it had a coloured glass shade that partly diffused the light in the room.

After almost twenty years, the Luxy family expands with two new models, a table lamp and a floor lamp, featuring the same simple outlines and for domestic use only.

The shade, which is the most characteristic feature of the Luxy lamp family, is offered in a new range of colours: gold, copper, smoke tinted.

DE – Im Jahr 2002 wurde Luxy als erste Lampe des Rotaliana-Katalogs entworfen: Ein zugleich originelles und familiäres Modell. Es führte Kunststoffelemente zusammen mit Glas und Metall ein und erinnerte an jene historischen Tischlampenmodelle mit ausgeglichenen Bewegungen. Sie hatte sowohl verborgene Federn als auch Reibungsgelenke, sowie einen Lampenschirm aus farbigem Glas, der die Lampe noch häuslicher wirken ließ und das Licht teilweise im Raum verbreitete. Nach fast zwanzig Jahren bekommt die Luxy-Familie nun Zuwachs: Zwei neue Modelle, eine Steh- und eine Tischlampe, mit vereinfachten Formen für den rein häuslichen Gebrauch. Der Lampenschirm, der die Familie der Luxy-Lampen ganz besonders charakterisiert, wird jetzt in neuen Farbvarianten angeboten: Gold, Kupfer, Rauch.

FR – Luxy, la première lampe du catalogue Rotaliana, a été conçue en 2002 comme modèle original ayant un air familier en même temps. Elle associait des éléments en matière plastique à du verre et du métal et rappelait les modèles traditionnels de lampes de table avec des mouvements à balancier. Elle était munie de ressorts de torsion invisibles, ainsi que d'amortisseurs pour les articulations. Son abat-jour en verre coloré répandait la lumière partiellement dans la pièce en faisant un modèle indiqué pour la maison. Vingt ans après, ou presque, la famille Luxy s'agrandit avec deux nouveaux modèles (lampadaire et lampe de table) aux formes simplifiées, typiques de ce qui sert pour une maison. L'abat-jour existe toujours, comme caractéristique essentielle de la famille Luxy, mais avec des nouveautés sur le plan des couleurs: dorée, cuivrée, fumée.

ES – Luxy fue la primera lámpara del catálogo de Rotaliana, diseñada en 2002: un modelo original y familiar a la vez. Introdujo elementos de material plástico junto con vidrio y metal, y recordaba los modelos históricos de lámparas de mesa con movimientos equilibrados. Utilizaba tanto resortes ocultos como juntas de fricción y, para brindarle un aspecto más doméstico, un sombrero de vidrio de color que difundía parcialmente la luz en el ambiente. Después de casi veinte años la familia Luxy se amplía: dos nuevos modelos, de pie y para mesa, caracterizados por formas simplificadas, para uso puramente doméstico. El sombrero —el elemento que más caracteriza a la familia de lámparas Luxy— se vuelve a proponer en nuevas variantes de color: oro, cobre, fumé.







160

# Luxy Glam



Design  
Donegani & Lauda

Year  
20

Category:  
Suspension / Ceiling / Wall / Floor / Table



161

Luxy: Floor / Table

cod: F0 Glam, T0 Glam

Light Source

E14 LED

Ø 13,5

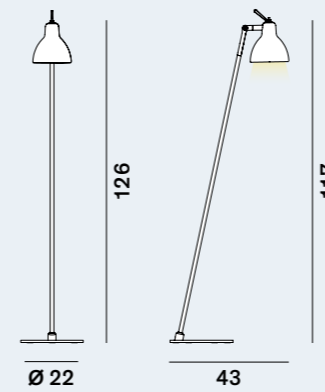

Ø 13,5

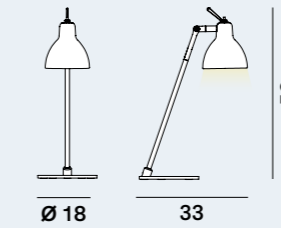

Luxy: Ceiling-Wall / Ceiling / Suspension

cod: H0 Glam, H5 Glam

Light Source

E14 LED

Ø 10

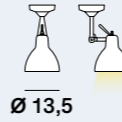

Ø 7,8

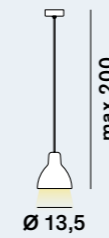

pag 264

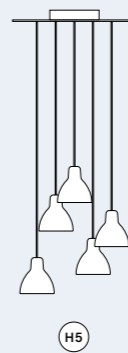

Ø 10

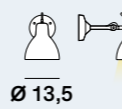

Ø 13,5

Catalogue



Diffuser (glass)

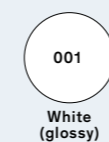

Coloured cable (H5)



# MultiPot+

Dante Donegani & Giovanni Lauda  
2005 / 2014

IT – La forma è quella di un vaso, la funzione è multipla: un vassoio porta oggetti, un hub di ricarica nascosto ed una lampada a LED RGB con interruttore touch sensitive dinamico. Nel 2008 è stato segnalato al XXI° premio Compasso d'Oro ADI.

EN – Its shape is that of a vase, its function is varied: a tray for holding objects, a hidden charging hub and a RGB LED lamp with dynamic touch switch. It received a Recommendation at the 21st edition of Compasso d'Oro ADI in 2008.

DE – Die Form ist die einer Vase, die Funktion dagegen vielfältig: ein Behälter für kleine Gegenstände, eine verborgene Auflade-Station und eine LED-RGB-Tischleuchte mit dynamischem Touch-Schalter. Im Jahr 2008 wurde diese Leuchte beim XXI Preis Compasso d'Oro ADI empfohlen.

FR – La forme est celle d'un vase, la fonction est multiple : un plateau porte-objet, un hub de recharge caché et une lampe à LED RVB avec interrupteur tactile dynamique. En 2008, elle a été signalée à l'occasion du XXIème prix Compasso d'Oro ADI.

ES – Su forma es la típica de un vaso y posee múltiples funciones: bandeja portaobjetos, Hub de recarga oculto y una lámpara de LED RGB con sensor por contacto dinámico. En 2008 fue propuesto para el XXI premio Compás de Oro ADI.

Focus  
MultiPot+

MULTIPOT  
2005



*Dante Donegani*

*Giovanni Lauda*

## MultiPot+

Negli anni che sono trascorsi dalla nascita di MultiPot (2005) abbiamo vissuto un cambiamento radicale, paradigmatico: abbiamo sostituito la Tv, scambiato opinioni e pensieri digitali, imparato a portare in tasca la potenza di un super computer, distribuito nel mondo e a costo zero le immagini della nostra esperienza. Tecnologia e innovazione sono diventati come l'aria che respiriamo. Una presenza necessaria e inevitabile, di cui le persone riconoscono l'indiscutibile utilità. MultiPot in questi anni così "diversi" ha saputo inserirsi nello spirito del tempo nuovo, diventando un vaso per coltivare le energie vitali. Un destino che accomuna i prodotti che segnano un'epoca e diventano archetipi comportamentali come l'iPhone di Apple o il click su Google, come il like di Facebook o il selfie di Instagram. Tutto solo in pochi anni, nei quali è esplosa la sfida digitale, con l'affermazione di nuovi strumenti e comportamenti. Come raccontano Dante Donegani e Giovanni Lauda, i designer che concepirono il prodotto, "Stava esplodendo l'era digitale nell'elettronica di consumo (oltre ai cellulari e ai Blackberry, erano nate le macchine fotografiche digitali e l'iPod) e non c'era una 'casa' per ospitare tutta questa elettronica mentre si ricaricava e dove ritrovarla a colpo sicuro. L'illuminazione venne da lì".

MultiPot è stato quindi un raggio di luce in un'epoca che vede ogni individuo inesorabilmente interconnesso e concentrato sulla propria individualità, ma anche sui propri amici e conoscenti. Gli oggetti tecnologici estendono il sé di ognuno di noi nel fare, nel coltivare emozioni estetiche, nel creare relazioni: compagni di vita incorporati nel nostro sentire quotidiano. Il MultiPot ha intuito tutto questo più di dieci anni fa, proponendosi come facilitatore energetico del quotidiano. Così MultiPot è diventata l'icona di un decennio, un oggetto semplice e raffinato, l'immagine semplice e avanzata del design e della coolness, campeggiando sulla scrivania della mitica direttrice di Vogue America, Anna Wintour, a cui è ispirato il libro e poi il film *Il diavolo veste Prada*. Nel 2015, MultiPot+ ha aggiunto l'esperienza della luce, del colore, dell'emozione di qualcosa sempre più legato al sé e alla sfera personale. MultiPot+ ha integrato la propria fruizione con una nuova temperatura emotiva, attraverso il gioco della luce che crea nuove atmosfere. Ciò permette intrattenimento sensoriale e semplificazione quotidiana ma anche sorpresa, gioco e innovazione. La luce e l'energia diventano, in questo modo, parte integrante della nostra vita quotidiana, senza perdere quell'aura di meraviglia innovativa che per tanti decenni ha incarnato

il sogno della modernità più avanzata. Il prossimo futuro è tutto da scoprire, ma una cosa è certa: sarà all'insegna di una felicità quotidiana resa possibile dall'affermazione di quei "nuovi illuminismi" proposti dalla campagna di lancio di MultiPot nel 2005.

Francesco Morace



## MultiPot+

## MultiPot explained through leaps in technology



2005

sfide tra sostenibilità e innovazione  
/challenge between sustainability  
and innovation.



2006

esplode the power of l'era digitale  
/the outburst of the digital era



2007

nuovi strumenti, nuovi  
comportamenti/new tools,  
new behaviour



2008

il potere dei social media  
/the power of social media



2009

progetti innovativi tra naturale  
e digitale/innovative projects  
between natural and digital.



2010

nuove visioni quotidiane  
e straordinarie/new daily and  
extraordinary visions.

2011

tempestività e trepidazione  
/rapidity and trepidation

2012

la scienza supera la fantascienza  
/science overtakes science fiction

2013

tutto in rete/everything  
on the web

2014

lo show è on-line  
/the show is on-line

2015

storia passata e futura  
/future and past history

2016

interconnessione e divisione  
/interconnection and division





## MultiPot+

In the years since the birth of MultiPot (2005) we have undergone radical, paradigmatic change: we have changed our TVs, we have exchanged opinions and thoughts digitally, we have learned to carry around the power of a super computer in our pockets, we have shared throughout the world our photos for free. Technology and innovation have become like the air we breathe, a necessary and inevitable presence, of which people acknowledge the irrefutable usefulness. During these ‘different’ years, MultiPot has skilfully adapted to the spirit of the times by becoming a vase for cultivating vital energies. This is a fate common to the products that have become benchmarks and behavioural archetypes, such as Apple’s iPhone or Google’s clicks, Facebook’s likes or Instagram’s selfies. All this has happened in just a few years, in which the digital challenge exploded and new tools and conducts took hold. As explained by Dante Donegani and Giovanni Lauda, the designers who created the product, “The digital era of consumer electronics was fully under way (when digital cameras and the iPod, as well as mobile and Blackberry phones, were all the rage) and there was the need for a ‘home’ for keeping all these devices while they recharged and where they could be found quickly. The idea sparked from

that need”. MultiPot, therefore, was a ray of light in an era in which every individual was inexorably interconnected and concentrated on his or her own individuality as well as on his or her friends and acquaintances. Technological devices extend our inner selves in what we do, in cultivating aesthetic emotions, in creating relationships: the objects become life companions incorporated into our everyday activities. MultiPot intuited all this over ten years ago, presenting itself as an energy facilitator in day to day life. This is how MultiPot became the icon of a decade, a simple and elegant object, the simple yet state-of-the-art image of design and of coolness, taking pride of place on the desk of the famous director of Vogue America, Anna Wintour, who inspired the book and film *The Devil Wears Prada*. In 2015, MultiPot+ added the experience of light and colour to the emotion for something that is even more bound to the self and to the sphere of personal experience. MultiPot+ has integrated its use with new vibes thanks to the play of lights that creates new atmospheres. This provides sensorial entertainment and daily simplification as well as surprise, fun and innovation. Light and energy, in this way, become an integral part of our daily life, but without losing that aura of innovative wonder

that for so many decades has embodied the dream of advanced modernity. The near future is yet to be discovered, but one thing is certain: it will be permeated by daily happiness, made possible by the onset of those ‘new enlightenments’ proposed by MultiPot’s launching campaign in 2005.

DE – In den Jahren, die seit der Schaffung von MultiPot (2005) vergangen sind, haben wir einen radikalen, Paradigmenwandel erlebt: Wir haben das Fernsehen ersetzt, in digitalen Medien Meinungen und Gedanken ausgetauscht, uns angewohnt, einen Superrechner in der Tasche zu tragen, zum Nulltarif die Bilder des uns Erlebten in der ganzen Welt verbreitet. Technologie und Innovation sind wie die Luft geworden, die wir atmen. Eine notwendige und unvermeidliche Präsenz, von der die Menschen den unbestreitbaren Nutzen erkennen. MultiPot hat es verstanden, sich in diesen so „anderen“ Jahren in den Geist der neuen Zeit einzugliedern und wurde zu einem Gefäß für die Kultivierung der Lebensenergien. Ein Schicksal, das die Produkte zusammenführt, die eine Ära kennzeichnen und zu Verhaltens– Archetypen wie dem Apple iPhone oder dem Klick auf Google, wie dem Facebook oder dem Instagram– Selfie, werden. All dies in nur wenigen Jahren, in denen die digitale Herausforderung explodierte, mit der Etablierung neuer Werkzeuge und Verhaltensweisen. Dante Donegani und Giovanni Lauda, die Designer, die das Produkt konzipiert haben, erzählen: „Das digitale Zeitalter explodierte in der Unterhaltungselektronik (neben Mobiltelefonen und Blackberrys kamen Digitalkameras und iPods auf), und es gab kein „Zuhause“, um all diese Elektronik während des Ladevorgangs unterzubringen und anschließend auf Anhieb wiederzufinden. Die Erleuchtung kam von dort“. MultiPot war also ein Lichtstrahl in einer Zeit, in der jeder Mensch unaufhaltsam miteinander vernetzt ist und sich auf seine Individualität, aber auch auf seine Freunde und Bekannten konzentriert. Technologische Objekte erweitern das Selbst eines jeden von uns, indem wir ästhetische Emotionen kultivieren und Beziehungen schaffen: Lebensgefährten, die in unser tägliches Gefühl integriert sind. All dies hat das MultiPot bereits vor mehr als zehn Jahren erkannt und versteht sich als energetischer Mittler für den Alltag. Und so ist MultiPot zur Ikone eines Jahrzehnts geworden, ein einfaches und raffiniertes Objekt, das einfache und fortgeschrittene Bild von Design und Coolness, nicht wegzudenken vom Schreibtisch der legendären Chefredakteurin von Vogue America, Anna Wintour, von der das Buch und später der Film Der Teufel trägt Prada handeln. Im Jahr 2015 summierte MultiPot+ das Erlebnis

des Lichts und der Farbe mit der Emotion für etwas, das immer mehr mit dem Ich und der persönlichen Sphäre verbunden ist. MultiPot+ hat die eigene Inanspruchnahme mit einer neuen Gefühlstemperatur durch das neue Atmosphären erzeugende Lichtspiel integriert. Dies ermöglicht sensorische Unterhaltung und tägliche Vereinfachung, aber auch Überraschung, Spiel und Innovation. Auf diese Weise werden Licht und Energie zu einem festen Bestandteil unseres täglichen Lebens, ohne dabei die Aura des innovativen Wunders zu verlieren, das seit Jahrzehnten den Traum der fortschrittlichsten Moderne verkörpert. Die nähere Zukunft gilt es noch in jeder Hinsicht zu entdecken, aber eines ist sicher: Sie wird durch ein tägliches Glück gekennzeichnet, das durch die Bestätigung der „neuen Erleuchtungen“ ermöglicht wird, die seit der MultiPot– Startkampagne 2005 angeboten werden.

FR – Au cours des années passées depuis l'invention de MultiPot (2005), on a vécu un changement radical, paradigmatique: la télé a changé, on échange des opinions et des réflexions numériques, on a appris à avoir en poche la puissance d'un super ordinateur, on a distribué dans le monde entier, et à un coût nul, des images de sa propre expérience. Technologie et innovation font partie de l'air que l'on respire. Une présence nécessaire et inévitable dont tout le monde reconnaît l'utilité certaine. MultiPot, au cours de ces années si „différentes“ a su s'adapter à l'air du temps en devenant un vase pour cultiver des énergies vitales. Une destinée rapprochant les produits qui sont le signe d'une époque et qui deviennent des archétypes comportementaux, tels l'iPhone d'Apple ou le click sur Google, le like de Facebook ou le selfie d'Instagram. Tout ceci en quelques années, lorsque le défi numérique a explosé avec l'affirmation de nouveaux instruments et comportements. Comme Dante Donegani et Giovanni Lauda, les designers qui ont conçu le produit, le racontent : „L'ère numérique était en train d'exploser dans l'électronique de consommation (en plus des portables et des Blackberry, les appareils photo numériques et l'iPod avaient fait leur apparition) et il y n'avait pas de 'foyer' pour recevoir tous ces éléments électroniques à recharger, et où les retrouver à coup sûr. C'est ce qui nous a illuminés.“

MultiPot a donc été un rayon de lumière à une époque où l'on voit chaque individu inexorablement interconnecté et concentré sur sa propre individualité, mais aussi sur ses amis et ses relations. Les objets technologiques poussent le soi de chacun d'entre nous à faire quelque chose, à cultiver des émotions esthétiques, à créer des relations: des camarades de vie incorporés dans nos sensations quotidiennes. MultiPot a deviné tout cela il y a plus de dix ans en se proposant comme facilitateur énergétique du quotidien. MultiPot est ainsi devenu l'icône d'une décennie, un objet simple et raffiné, l'image simple et avancée de ce qui est 'design' et 'cool', en trônant sur le bureau de la directrice mythique de Vogue Amérique, Anna Wintour qui a inspiré le livre 'Le diable s'habille en Prada', suivi du film. En 2015, MultiPot+ a additionné l'expérience de la lumière et de la couleur à l'émotion de quelque chose lié de plus en plus au soi et à la sphère personnelle. MultiPot+ a complété son utilité avec une nouvelle température émotive, à travers un jeu de lumière qui crée de nouvelles atmosphères. Ceci permet un plaisir sensoriel et une simplification quotidienne, mais aussi des surprises, du jeu et de l'innovation. La lumière et l'énergie deviennent ainsi partie intégrante de notre vie quotidienne, sans perdre son aura d'émerveillement innovant qui a incarné le rêve de la modernité la plus avancée pendant de nombreuses décennies. L'avenir reste à découvrir, mais il y a une chose qui est certaine: il sera sous le signe d'un bonheur quotidien rendu possible par l'affirmation des „nouveaux siècles des lumières“ que proposait la campagne de lancement de MultiPot en 2005.

ES – En los años transcurridos desde el nacimiento de MultiPot (2005), hemos vivido un cambio radical y paradigmático: hemos sustituido la televisión, hemos intercambiado opiniones y pensamientos digitalmente, hemos aprendido a llevar en el bolsillo la potencia de un súper ordenador, hemos distribuido en el mundo —y sin ningún costo— las imágenes de nuestra experiencia. La tecnología y la innovación hoy son como el aire que respiramos. Una presencia necesaria e inevitable, cuya utilidad indiscutible es reconocida por todos. En estos años tan „diferentes“, MultiPot ha sabido insertarse en el espíritu del tiempo nuevo y se ha transformado en una maceta para cultivar las energías vitales.

Un destino que aúna los productos que marcan una época y que se transforman en arquetipos de comportamientos, como el iPhone de Apple o el clic en Google, como el “me gusta” de Facebook o la selfie de Instagram. Todo sólo en pocos años, en los cuales estalló el desafío digital, con la afirmación de nuevas herramientas y nuevos comportamientos. Así lo relatan Dante Donegani y Giovanni Lauda, los diseñadores que concibieron el producto, “Estaba explotando la era digital en la electrónica de consumo (además de los celulares y los Blackberry, habían nacido las máquinas fotográficas digitales y los iPods) y no había una 'casa' para albergar a toda esta electrónica mientras se recargaba y estar seguros de volver a encontrarla. La iluminación viene de allí”. Por lo tanto, MultiPot ha sido un rayo de luz en una época que ve a cada individuo inexorablemente interconectado y concentrado en su propia individualidad, pero también en sus amigos y conocidos. Los objetos tecnológicos amplían el ser de cada uno de nosotros en el quehacer, en el cultivo de emociones estéticas, en el crear relaciones: compañeros de vida incorporados en nuestro sentir diario. MultiPot ha intuido todo esto hace más de diez años, y se ha propuesto como facilitador energético cotidiano. De este modo, MultiPot se ha transformado en el icono de una década, un objeto simple y refinado, la imagen sencilla y avanzada del diseño y del concepto cool, instalándose en el escritorio de la mítica directora de Vogue América, Anna Wintour, en la cual se ha inspirado el libro —y luego, la película— El diablo viste de Prada. En el 2015, MultiPot+ agregó la experiencia de la luz, del color, de la emoción de algo cada vez más ligado a uno mismo y a la esfera personal. MultiPot+ ha añadido la experiencia de la luz, del color, de la emoción, de algo cada vez más relacionado con el ser y la esfera personal. MultiPot+ ha integrado al uso de la lámpara una nueva temperatura emocional a través del juego de la luz que crea nuevas atmósferas. Esto permite entretenimiento sensorial y simplificación cotidiana, pero también sorpresa, juego e innovación. De este modo, la luz y la energía se transforman en parte integral de nuestra vida cotidiana, sin perder el aura de la maravilla innovadora que durante tantas décadas ha encarnado el sueño de la modernidad más avanzada.

El próximo futuro está aún por descubrirse, pero algo es cierto: será la representación de una felicidad cotidiana que se hace posible gracias a la afirmación de los “nuevos iluminismos” propuestos por la campaña de lanzamiento de MultiPot en el 2005.



Dante Donegani e Giovanni Lauda con il primo modello di MultiPot, foto di Emilio Tremolada, 2005





MultiPot+



167



## MultiPot+

1



2



1

IT – Il celebre aforisma di Caravaggio e la confezione simile ad un barattolo di vernice rimarcano la luce RGB del MultiPot+.  
 EN – Caravaggio's famous aphorism and the package resembling a can of paint remark the RGB light of MultiPot+.  
 DE – Der berühmte Aphorismus von Caravaggio und die einer Lackdose ähnelnde Aufmachung betonen das RGB-Licht des MultiPot+.  
 FR – Le célèbre aphorisme de Caravage et la confection ressemblant à un pot de peinture soulignent la lumière RGB du MultiPot+.  
 ES – El célebre aforismo de Caravaggio y el envase similar a una lata de pintura remarcan la luz RGB del MultiPot+.

2

IT – Il coperchio del vaso è sia una presa multipla che un vassoio su cui riporre gli apparecchi a ricaricare.  
 EN – The cover of the vase acts both as a multiple outlet and as a tray for holding the devices being recharged.  
 DE – Der Deckel der Vase ist sowohl eine Mehrfachsteckdose als auch ein Tablett zum Aufsetzen der nachzuladenden Geräte.  
 FR – Le couvercle du vase est une prise multiple, ainsi qu'un plateau sur lequel ranger les appareils à recharger.  
 ES – La cubierta del florero es un toma múltiple o una bandeja sobre la cual se pueden colocar los aparatos para cargar.

MultiPot+: Table

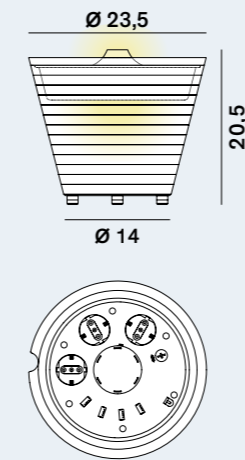

Light Source	MID POWER LED RGB
Power	3,6 Watt
Kelvin	3.000
Dimmer	touch
Lumen	280
CRI	90
USB port	4
Europlugs	3

Catalogue



White  
(glossy)

# Overlap

Paolo Dell'Elce  
2017

IT – Sospensione generata dalla sovrapposizione di elementi circolari. È interamente realizzata in alluminio e pannelli in medium-density light. Il disco centrale supporta la sorgente LED e i dischi esterni, disposti su vari piani, compongono una geometria discreta ma al contempo scenografica.

EN – The suspension-effect is produced by the overlapping of circular elements. Entirely made of aluminum and medium-density light panels. The central disk supports LED sources and external disks, which are arranged on different levels, producing an unobtrusive yet dramatic geometry.

DE – Eine Hängeleuchte, die aus überlagerten kreisförmigen Elementen gefertigt ist. Sie ist vollständig aus Aluminium und MDF-Leichtfaserplatten gefertigt. Die zentrale Scheibe trägt die LED-Lichtquellen und die äußeren Scheiben sind auf verschiedenen Niveaus angeordnet und bilden eine diskrete aber zugleich szenografisch wirkende Geometrie.

FR – Une suspension engendrée par la superposition d'éléments circulaires. Elle est entièrement constituée d'aluminium et de panneaux en medium-density light. Le disque central supporte les sources LED et les disques externes, disposés sur différents niveaux, composent une géométrie discrète mais en même temps très spectaculaire.

ES – Suspensión generada por la superposición de elementos circulares. Íntegramente realizada en aluminio y paneles con luz de densidad media. El disco central soporta la fuente de LED y los discos externos, dispuestos sobre varios planos, componen una geometría discreta, pero al mismo tiempo, escenográfica.







# Overlap

1

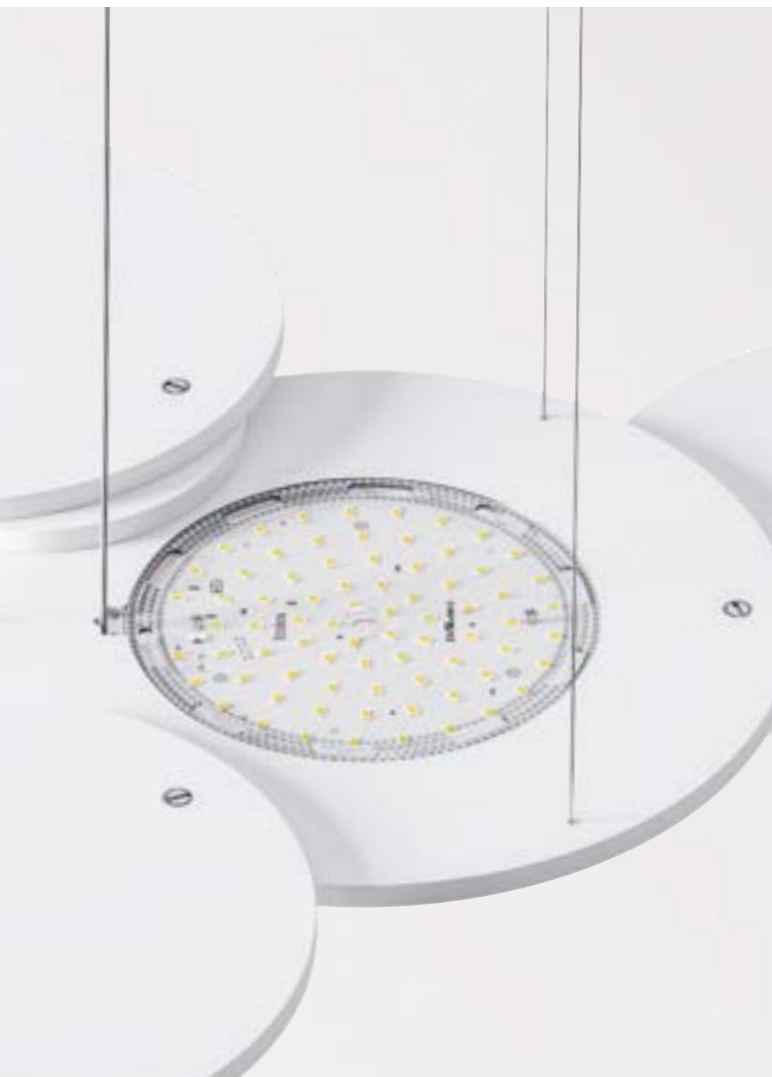

2



1  
IT – Luce con emissione indiretta e diffusa.  
EN – Indirect and soft light. DE – Licht mit indirekter und gestreuter Verteilung.  
FR – Lumière avec émission indirecte et diffuse. ES – Luz con emisión indirecta y difusa.

2  
IT – Sistema di fissaggio a soffitto con tendicavi regolabili. EN – Ceiling fastening system with adjustable cable tensioner.  
DE – Deckenbefestigungssystem mit verstellbaren Kabelspannern. FR – Système de fixation au plafond avec dispositif réglable de mise sous tension des câbles.  
ES – Sistema de fijación en el cielorraso con pasacables regulables.

Design  
Paolo Dell'Elce

Year  
17

Category: Suspension 

Overlap: Suspension

cod: H1

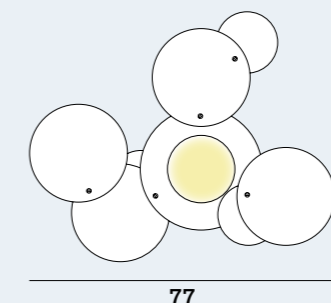
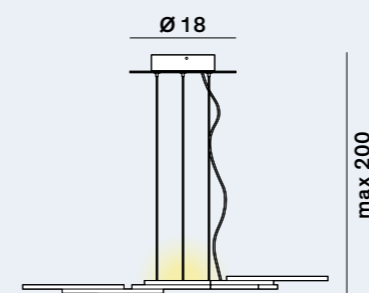

Light Source	MID POWER LED
Power	34 Watt
Kelvin	2.700, 3.000
Dimmer	phase
Lumen	4.000
CRI	90

## Examples of configuration

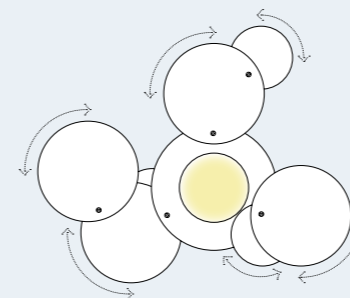

N°1

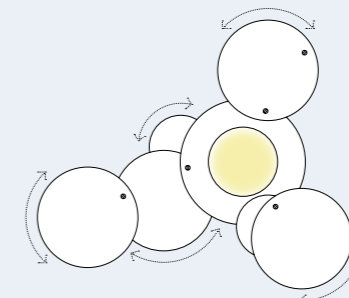

N°2

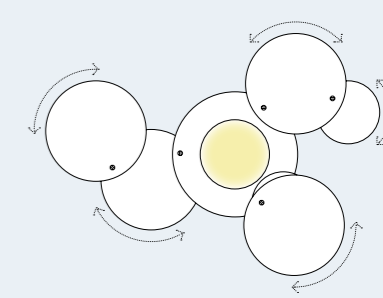

N°3

N°1, 2, 3

IT – Gli elementi che circondano il disco centrale, possono essere ruotati a piacere per creare differenti configurazioni.  
EN – The elements surrounding the central disc can be freely rotated to create different configurations. DE – Die rings um die zentrale Scheibe angeordneten Elemente können beliebig gedreht werden, um unterschiedliche Konfigurationen zu gestalten. FR – Les éléments qui entourent le disque central peuvent être tournés à volonté afin de donner naissance à différentes configurations. ES – Los elementos que rodean el disco central se pueden rotar como uno desea para crear diversas configuraciones.

## Catalogue



## Satin Collection (upon request)

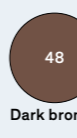
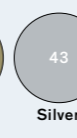
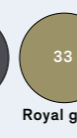

## Kerakoll Warm Collection (upon request)

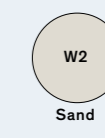

# Pomi

Paolo Rizzatto  
2019

IT – Lampade a sospensione a luce diretta e concentrata. La forma organica è realizzata a partire dalla lavorazione di una unica lastra di metallo. Le finiture interne ed esterne sono differenziate per utilizzare le qualità riflettenti delle superfici metalliche.

EN – Suspension lamps providing direct, focused light. The organic shape is achieved by processing a single metal sheet. The internal and external finishes are differentiated so as to exploit the different reflection qualities of the metal surfaces.

DE – Hängelampen mit direktem und konzentriertem Licht. Die organische Form entsteht aus der Verarbeitung einer einzelnen Metallplatte. Die Innen- und Außenfinishes werden unterschiedlich verarbeitet, um die reflektierenden Eigenschaften der Metalloberflächen zu nutzen.

FR – Lustres à lumière directe et concentrée. La forme organique est réalisée en usinant une seule plaque de métal. Les finitions à l'intérieur et à l'extérieur sont différenciées pour faire usage des propriétés réfléchissantes des surfaces métalliques.

ES – Lámparas para colgar de luz directa y concentrada. La forma orgánica está realizada a partir de la elaboración de una única lámina de metal. Los acabados internos y externos están diferenciados para utilizar las cualidades reflectantes de las superficies metálicas.





180

Pomi



181

Pomi: Suspension

cod: H1, H2, H3

Light Source

E27 LED

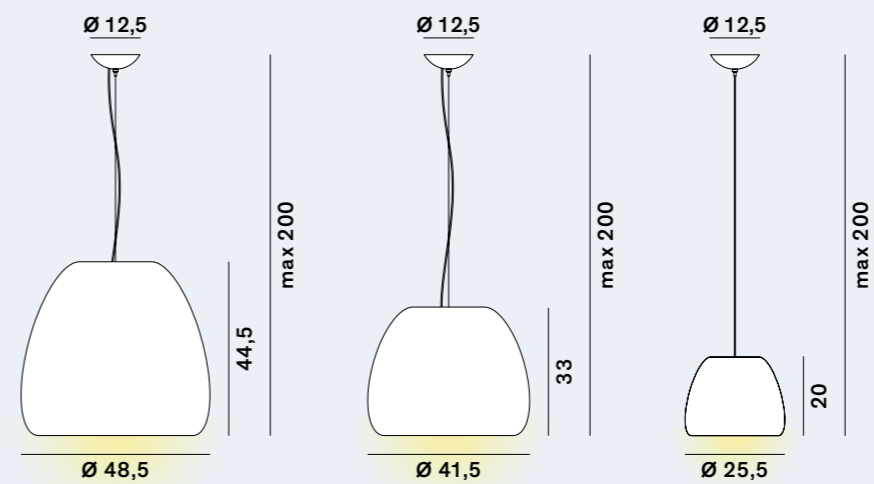

pag 264

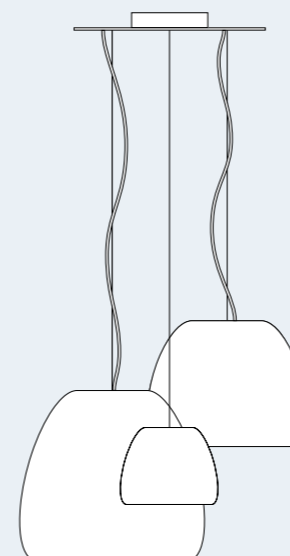

Catalogue



Metallic selection (upon request)



# Prince

Dante Donegani & Giovanni Lauda  
2013

IT – Lampada da terra a luce indiretta semplice ed elegante, Prince si sviluppa da una base circolare che prosegue con un gambo sottile sul cui è fissata una corona in pressofusione di alluminio che nasconde al suo interno una sorgente LED ad alta performance.

EN – This simple and elegant indirect-light floor lamp rises from a circular base with a thin stem on top of which an aluminium die-cast crown is attached that conceals a high performance LED source.

DE – Prince ist eine schlichte, elegante Bodenleuchte mit indirektem Licht. Vom kreisrunden Fuß erhebt sich ein dünner Schaft, auf dem ein Kranz aus Aluminium-Druckguss befestigt ist, in dessen Innerem sich eine Hochleistungs-Ledlampe verbirgt.

FR – Lampadaire à la lumière tamisée et élégante, Prince se développe depuis une base circulaire qui se poursuit par une mince tige à laquelle est fixée une couronne en aluminium moulé sous pression, qui cache en son sein une source LED à haute performance.

ES – Prince es una lámpara de pie, con luz indirecta, sencilla y elegante, que se desarrolla a partir de una base circular que continúa con una barra fina sobre la que se halla fijada una corona de aluminio moldeado a presión que oculta en su interior una fuente de LED de alto rendimiento.



184

# Prince



Design  
Donegani & Lauda

Year  
13

Category: Floor 

185

Prince: Floor

cod: F1

Ø 22,4



Ø 23

180

Light Source	MID POWER LED
Power	58 Watt
Kelvin	2.700
Dimmer	push button
Lumen	5.300
CRI	90

Catalogue



White (matt)

Satin selection (upon request)

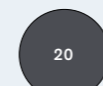

Graphite

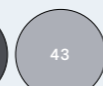

Silver



Black (matt)

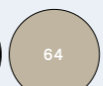

Bronze

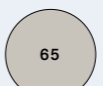

Champagne

# QB

Federica Cevasco  
2013

IT – La forma del cubo incastonato nel muro è solo un effetto prospettico. La lampada, costruita in alluminio pressofuso, sporge dalla parete solo di pochi centimetri per distribuire nell'ambiente un potente flusso di luce indiretta.

EN – The cube shape pressed into the wall is only a perspective effect. In fact, the lamp emerges from the wall by only a few centimetres to distribute a powerful flow of indirect light to the living environment.

DE – Der Eindruck eines in der Wand steckenden Würfels ist ein rein perspektivischer Effekt. Die aus Aluminium-Druckguss hergestellte Leuchte ragt nur wenige Zentimeter aus der Wand heraus und verstreut im Raum einen kraftvollen Strom indirekten Lichts.

FR – La forme d'un cube encastré dans le mur n'est qu'un effet de perspective. La lampe, formée d'aluminium moulé sous pression, ne se trouve en saillie sur la paroi que de quelques centimètres, afin de diffuser dans le milieu ambiant un puissant flux de lumière indirecte.

ES – La forma del cubo engarzado en la pared es sólo un efecto de perspectiva. La lámpara, construida con aluminio moldeado a presión, sobresale de la pared sólo unos centímetros para distribuir en el ambiente un potente flujo de luz indirecta.



188

QB



QB: Wall

cod: W0

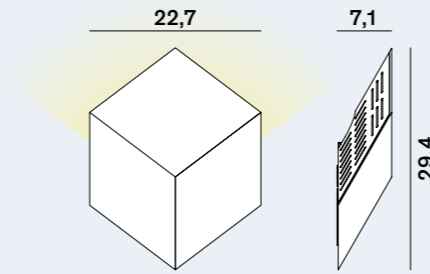

Light Source	MID POWER LED
Power	25 Watt
Kelvin	2.700
Dimmer	phase
Lumen	2.300
CRI	90

Catalogue

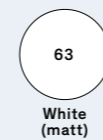

63

White (matt)

Satin Collection (upon request)

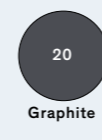

20

Graphite



33

Royal gold



43

Silver



48

Dark bronze



62

Matt black

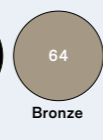

64

Bronze



65

Champagne

Metallic selection (upon request)



14

Antique brass



19

Pelter delabrè



22

Copper delabrè



23

Gold delabrè



# Squiggle

Paolo Rizzato  
2017 / 2020

IT – Ispirata alla “Struttura al neon” di Lucio Fontana per la IX Triennale di Milano, Squiggle è un esoscheletro tubolare sospeso a soffitto che nasconde una striscia LED lunga fino a 6 metri. Una sequenza di forature a forma di esagono irregolare alleggerisce la struttura metallica che genera figure geometriche molto differenti fra di loro: linee curve spezzate, l'infinito, anelli concentrici di varie dimensioni.

EN – Inspired by the “Neon structure” by Lucio Fontana for the 9th Triennale of Milan, Squiggle is a suspended tubular exoskeleton that hides a LED strip up to 6 m long. A sequence of irregular hexagon-shaped holes lightens the metal structure that generates varying geometrical shapes: broken curved lines, the infinity symbol, concentric rings of various sizes.

DE – Squiggle wurde von der “Neon-Struktur” von Lucio Fontana für die IX Triennale von Mailand inspiriert und ist ein röhrenförmiges Exoskelett, das an der Decke hängt und einen LED-Streifen mit einer Länge von bis zu 6 Metern verbirgt. Eine Abfolge von Löchern in Form eines unregelmäßigen Sechsecks hellt die Metallstruktur auf, und erzeugt sehr unterschiedliche geometrische Figuren: unterbrochene gekrümmte Linien, das Unendlichkeit-Symbol, konzentrische Ringe unterschiedlicher Größe.

FR – S'inspirant de la “Structure au néon” de Lucio Fontana pour la IX Triennale de Milan, Squiggle est un exosquelette tubulaire pendu au plafond qui cache une longue bande LED faisant jusqu'à 6 mètres. Une séquence d'ouvertures de forme d'hexagonale irrégulière allège la structure métallique en donnant lieu à des images géométriques très différentes les unes des autres: des lignes courbes cassées, le symbole de l'infini, des anneaux concentriques de plusieurs tailles.

ES – Inspirada en la “Estructura de Neón” de Lucio Fontana para la IX Trienal de Milán, Squiggle es un caparazón tubular suspendido del cielorraso que oculta una franja LED de hasta 6 metros de largo. Una secuencia de perforaciones con forma de hexágono irregular brinda liviandad a la estructura metálica que genera figuras geométricas muy diferentes entre sí: líneas curvas partidas, el infinito, anillos concéntricos de varias dimensiones.

Focus  
Squiggle

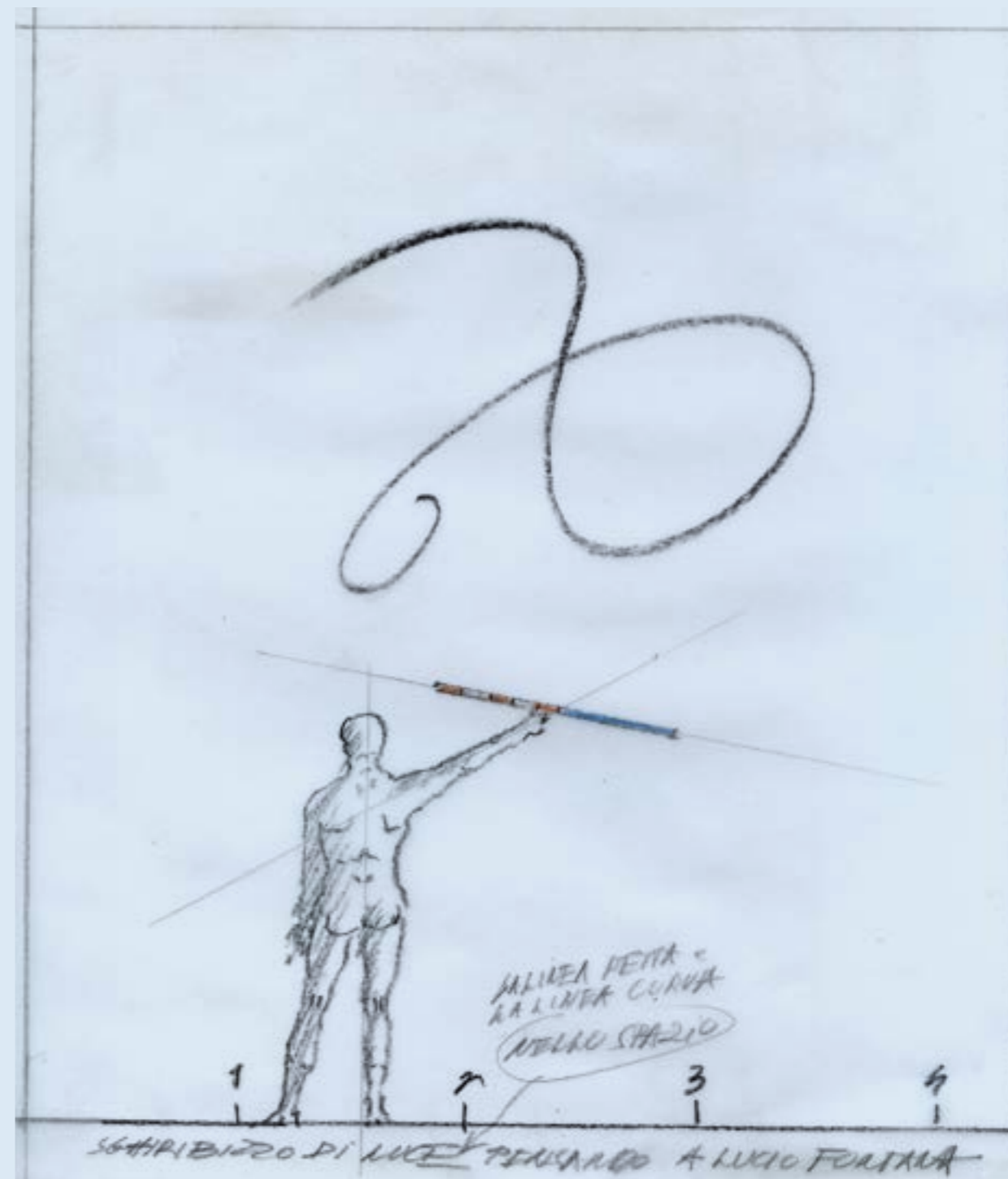

## Squiggle

Da bambino avevo visto, librato sullo scalone del Palazzo dell'Arte di Milano, un impressionante arabesco luminoso di dimensioni gigantesche. Ne rimasi folgorato. Si trattava della "Struttura al neon per la IX Triennale di Milano" realizzata da Lucio Fontana con tubi al neon curvati (2,5×7×9m). Quella immagine liberamente monumentale né pittura né scultura ha accompagnato tutta la mia vita di progettista e tornava di tanto in tanto a riaffacciarsi alla mia mente. Ecco, oggi che la tecnologia LED ci permette di realizzare una linea di luce continua libera nello spazio, il progetto molto semplicemente è consistito nel dare una forma e delle dimensioni a questa linea, in modo da renderla un manufatto, facilmente realizzabile, movimentabile, economico, vendibile, in una parola: utilizzabile.

Paolo Rizzato

As a child, I had seen, suspended above the large stairway of the Palazzo dell'Arte of Milan, an impressive, luminous arabesque of gigantic proportions. I was thrilled with it. It was the "Neon structure for the 9th Triennale of Milan" created by Lucio Fontana using bent neon tubes (2.5×7×9m). That freely monumental image, neither painting nor sculpture, accompanied me along my whole career as a designer and once upon a while would come back to my mind. So, now that the LED technology allows us to create a continuous line of light that is liberated in space, the project quite simply consisted in giving shape and size to this line, so as to make it an artefact that is easy to realise, movable, convenient and sellable. In one word: usable.

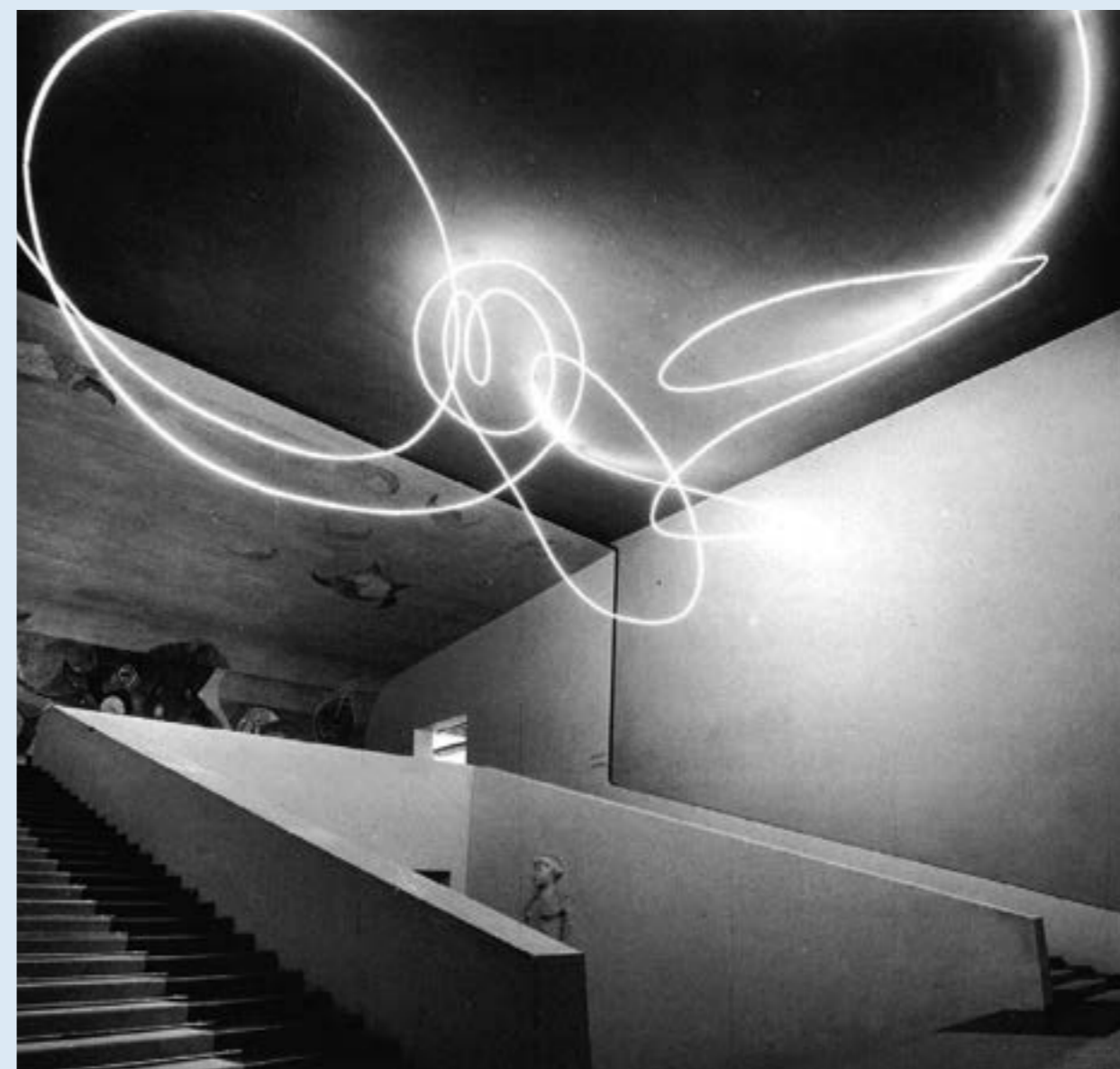

Lucio Fontana, Struttura al neon per la IX Triennale di Milano, 1951

DE – Als Kind hatte ich eine beeindruckende, schwebende Lichtarabeske von gigantischen Ausmaßen auf der Treppe des Palazzo dell'Arte in Mailand gesehen. Ich war damals wie vom Blitz getroffen. Es war die "Neonstruktur für die IX Triennale von Mailand" von Lucio Fontana, mit gekrümmten Neonröhren (2,5x7x9 m) ausgeführt. Dieses frei monumentale Bild, weder Malerei noch Skulptur, begleitete mein ganzes Leben als Designer und kehrte von Zeit zu Zeit in meine Gedankenwelt zurück. Heute ermöglicht uns diese LED-Technologie, eine kontinuierliche Lichtlinie im Raum zu erzeugen. Das Projekt bestand ganz einfach darin, dieser Linie eine Form und Abmessungen zu geben, um sie zu einem Artefakt zu machen, das leicht erreichbar, beweglich und wirtschaftlich ist, verkäuflich, in einem Wort: nutzbar.

FR – Etant enfant, j'avais vu apparaître une arabesque lumineuse impressionnante, de taille gigantesque, flottant sur le grand escalier du Palazzo dell'Arte à Milan. J'en fus foudroyé. Il s'agissait de la "Structure au néon pour la IX Triennale de Milan" réalisée par Lucio Fontana avec des tubes au néon recourbés (2,5x7x9 m). Cette image librement monumentale, ni tableau ni sculpture, a accompagné toute ma vie professionnelle et s'est représentée de temps en temps à mon esprit. Voilà qu'aujourd'hui la technologie des LED nous permet de réaliser une ligne de lumière continue évoluant librement dans l'espace, le projet ayant tout simplement été de donner une forme et des dimensions à cette ligne, de façon à en faire un objet, facile à réaliser, mobile, économique, vendable, en un mot: utilisable.

ES – De niño había visto en la escalinata del Palacio de Arte de Milán un impresionante arabesco luminoso de dimensiones gigantescas. Me quedé estupefacto. Se trataba de la "Estructura de neón para la IX Trienal de Milán" realizada por Lucio Fontana con tubos de neón curvos (2,5x7x9m.). Esa imagen libremente monumental, que no es pintura ni escultura, me ha acompañado en toda mi vida de diseñador, y cada tanto se aparecía en mi mente. Hoy, cuando la tecnología LED nos permite realizar una línea de luz continua libre en el espacio, el diseño muy simplemente ha consistido en dar una forma y las dimensiones a esta línea, de modo tal que se transforme en un objeto de fácil realización, que se pueda mover, que sea económico y vendible; en una palabra: utilizable.



Paolo Rizzatto, progetto di luminarie alla Kalsa di Palermo, 2005

D









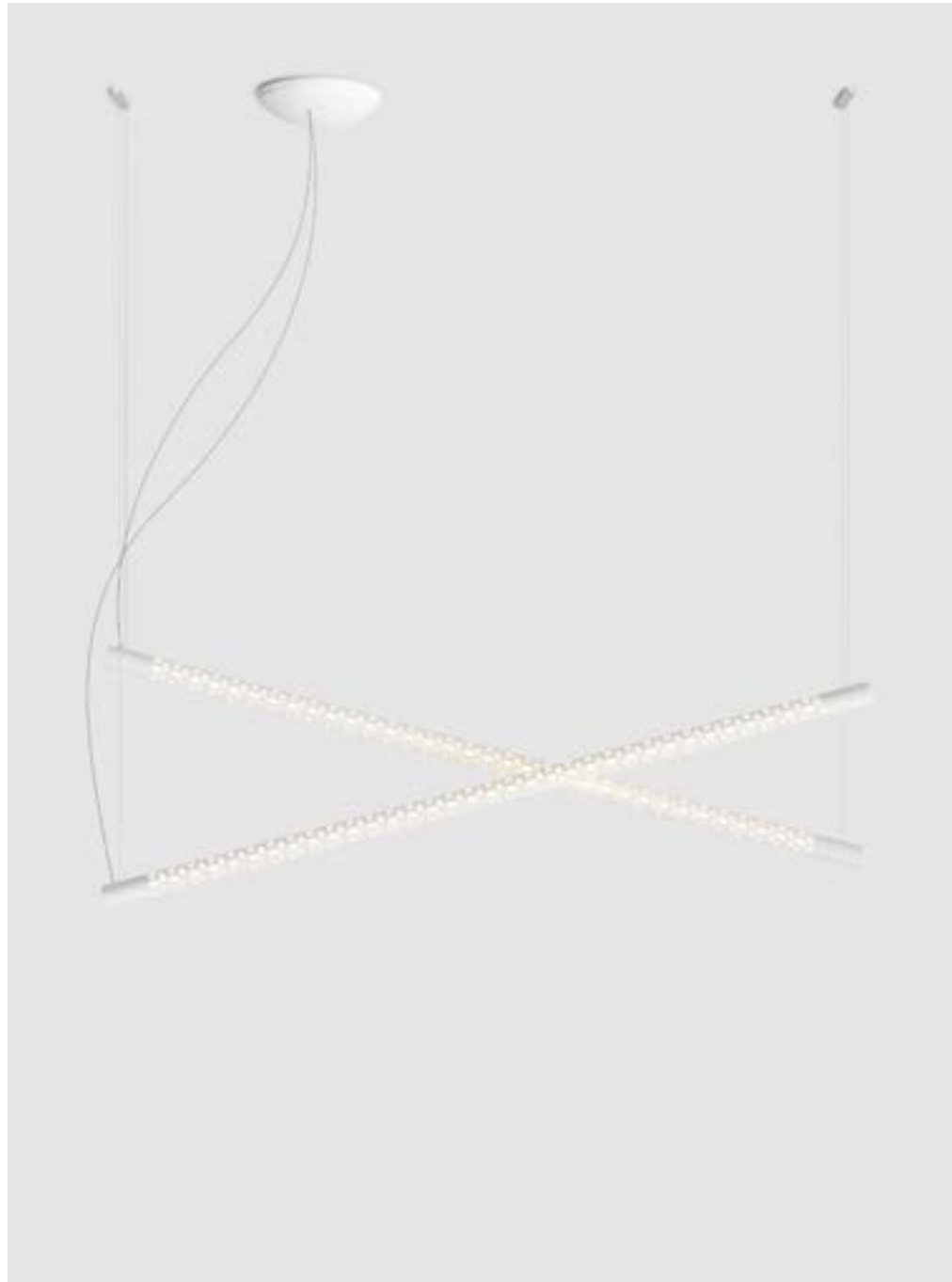









Squiggle: Suspension

cod: H1

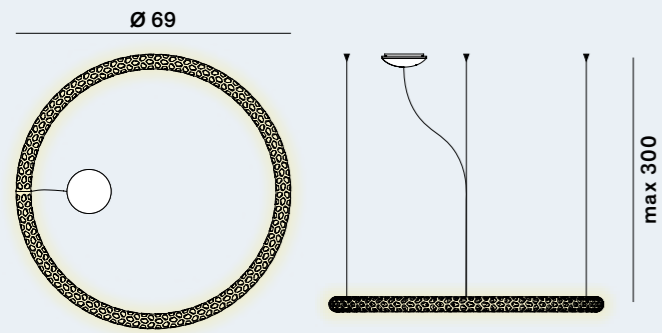

Light Source	MID POWER LED
Power	40 Watt
Kelvin	2.700, 3.000
Dimmer	push, dali, 0/1-10V, casambi
Lumen	2.800
CRI	90

Squiggle: Suspension

cod: H3

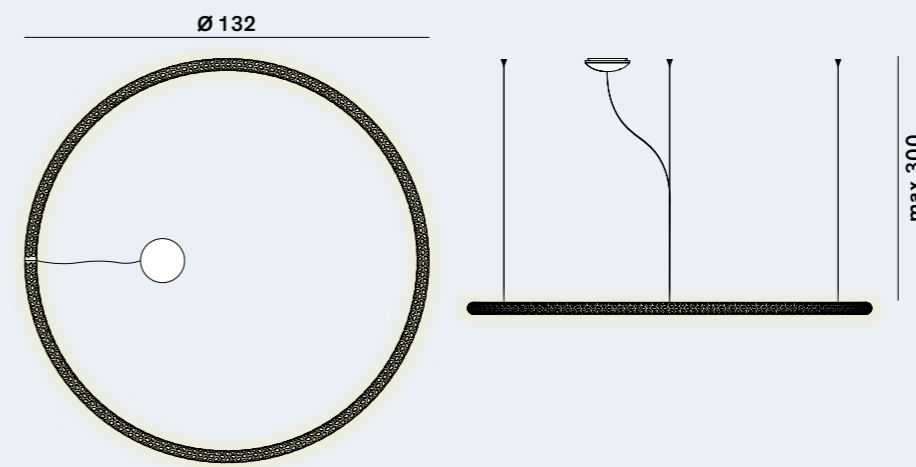

Light Source	MID POWER LED
Power	67 Watt
Kelvin	2.700, 3.000
Dimmer	push, dali, 0/1-10V, casambi
Lumen	4.600
CRI	90

Squiggle: Suspension

cod: H2

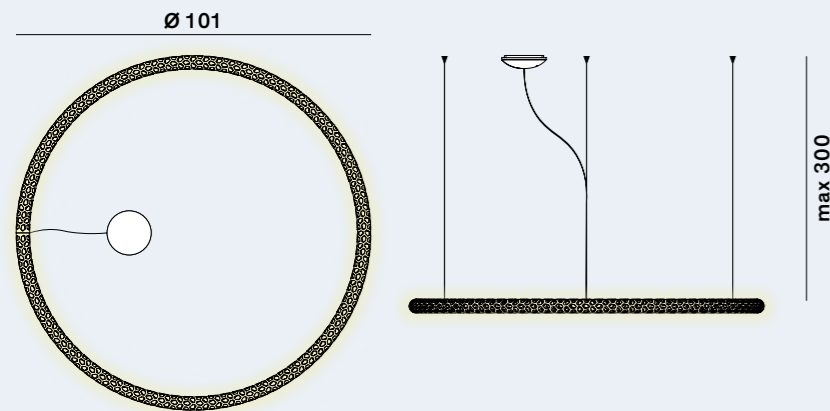

Light Source	MID POWER LED
Power	56 Watt
Kelvin	2.700, 3.000
Dimmer	push, dali, 0/1-10V, casambi
Lumen	3.900
CRI	90

Squiggle: Suspension

cod: H4

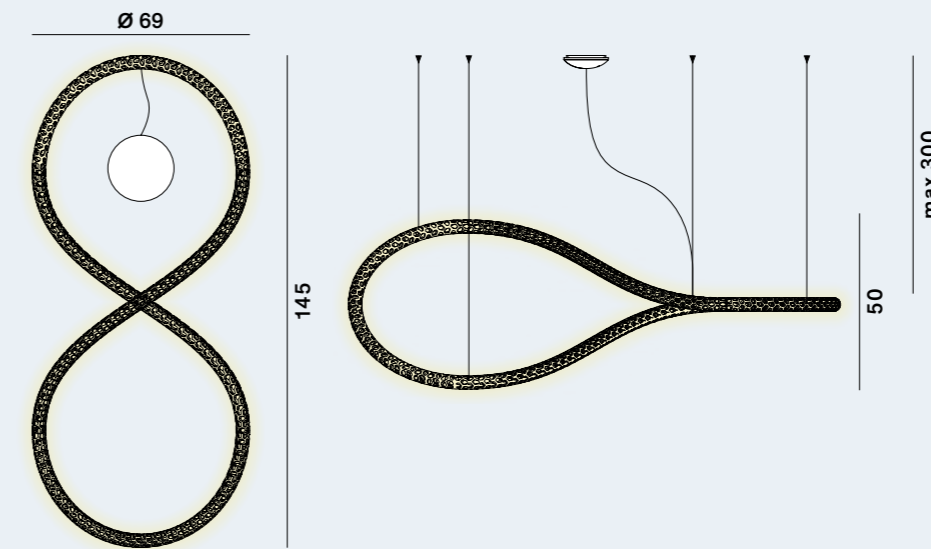

Light Source	MID POWER LED
Power	67 Watt
Kelvin	2.700, 3.000
Dimmer	push, dali, 0/1-10V, casambi
Lumen	4.600
CRI	90

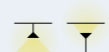

Catalogue

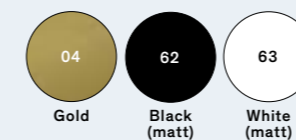

Squiggle: Suspension

cod: H5

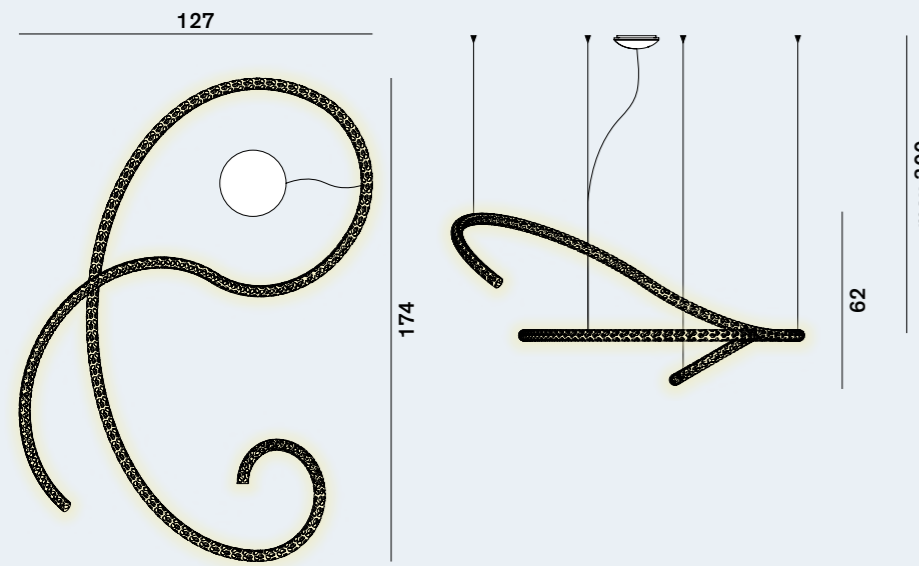

Light Source	MID POWER LED
Power	95 Watt
Kelvin	2.700, 3.000
Dimmer	push, dali, 0/1-10V, casambi
Lumen	6.500
CRI	90

Squiggle: Suspension

cod: H8

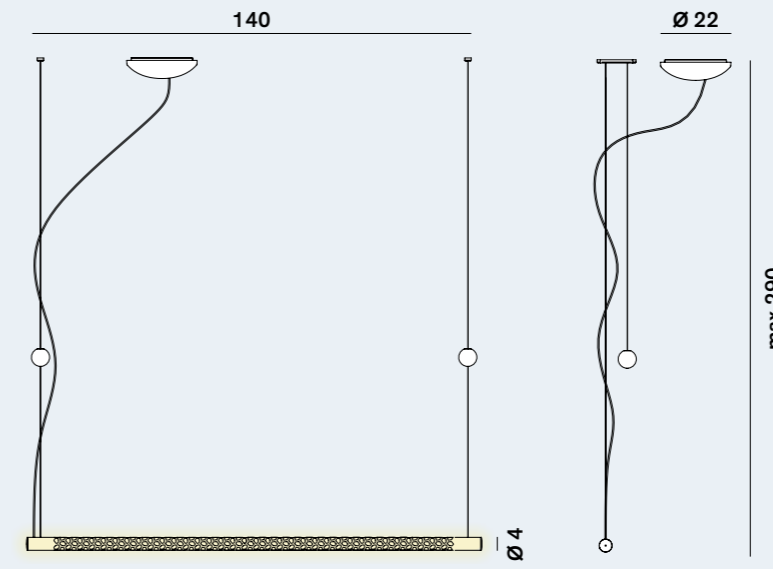

Light Source	MID POWER LED
Power	36 Watt
Kelvin	2.700, 3.000
Dimmer	push, dali, 0/1-10 V, casambi
Lumen	2.500
CRI	90

Class **A / A+ / A++**

Squiggle: Suspension

cod: H6

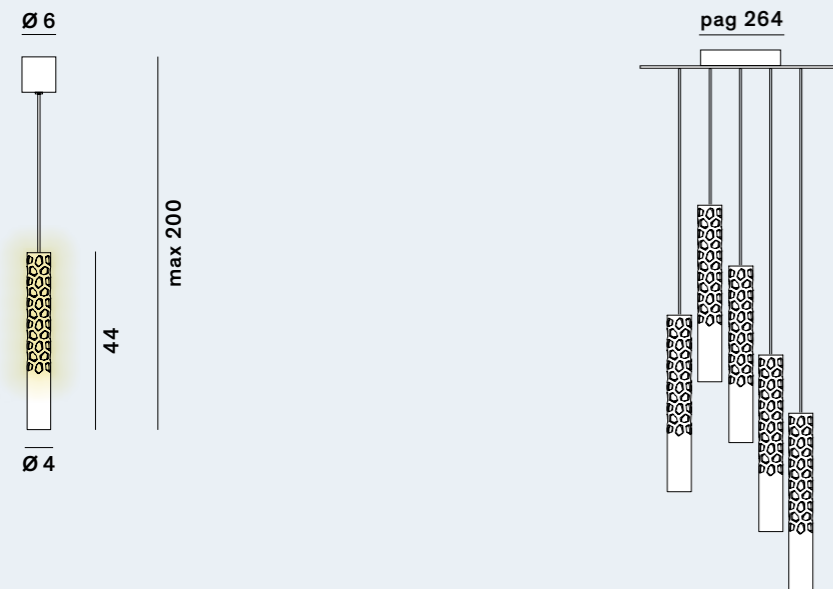

Light Source	MID POWER LED + G4 36° LED
Power	7,5 Watt
Kelvin	2.700
Lumen	480
CRI	90

Squiggle: Suspension

cod: H9

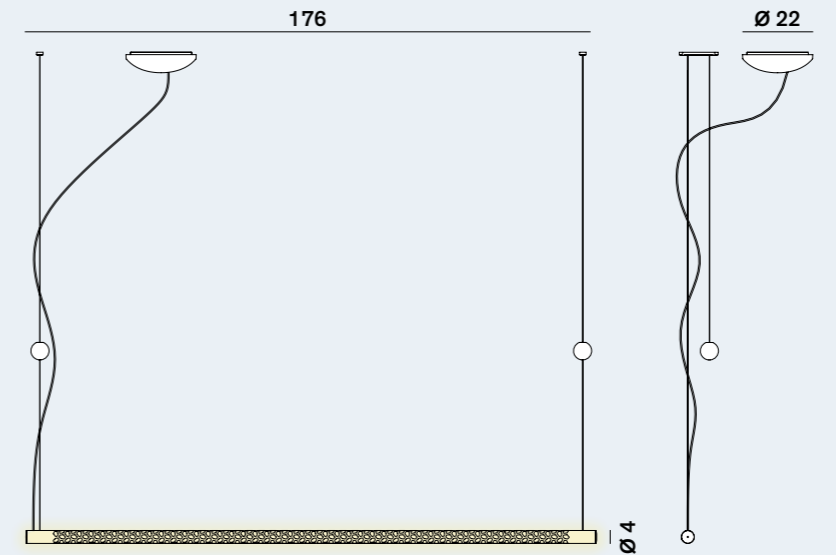

Light Source	MID POWER LED
Power	39 Watt
Kelvin	2.700, 3.000
Dimmer	push, dali, 0/1-10 V, casambi
Lumen	2.700
CRI	90

Class **A / A+ / A++**

Catalogue

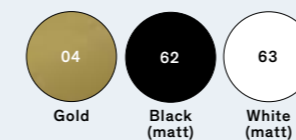

210

Squiggle: Suspension

cod: H10

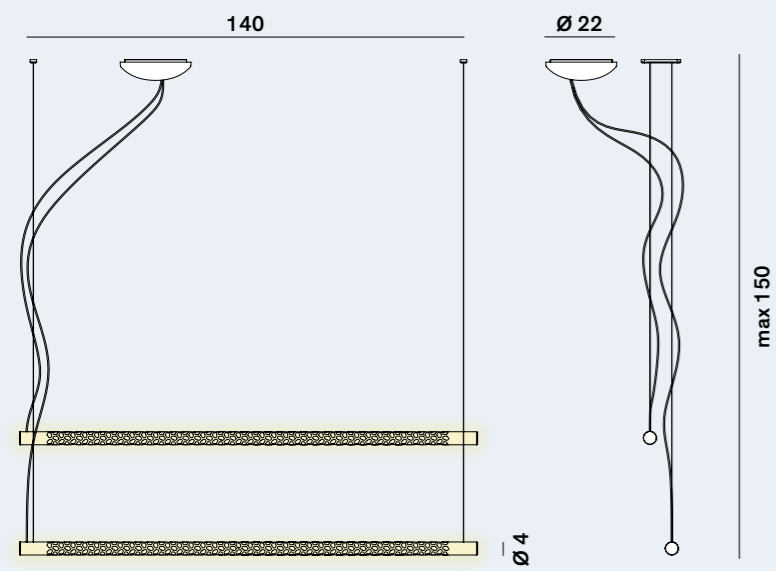

Light Source	MID POWER LED
Power	72 Watt
Kelvin	2.700, 3.000
Dimmer	push, dali, 0/1-10 V, casambi
Lumen	5.050
CRI	90

211

Squiggle: Suspension

cod: H12

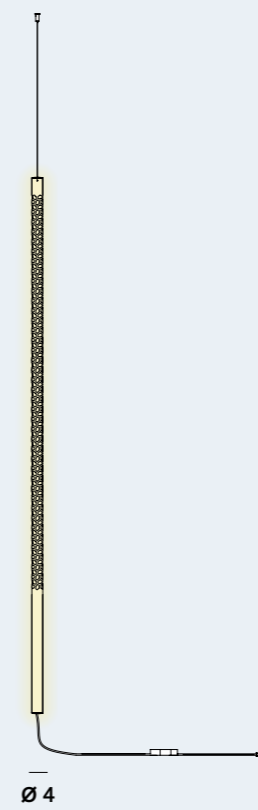

Light Source	MID POWER LED
Power	34 Watt
Kelvin	2.700, 3.000
Dimmer	foot
Lumen	2.400
CRI	90

Class **A / A+ / A++**

Squiggle: Suspension

cod: H11

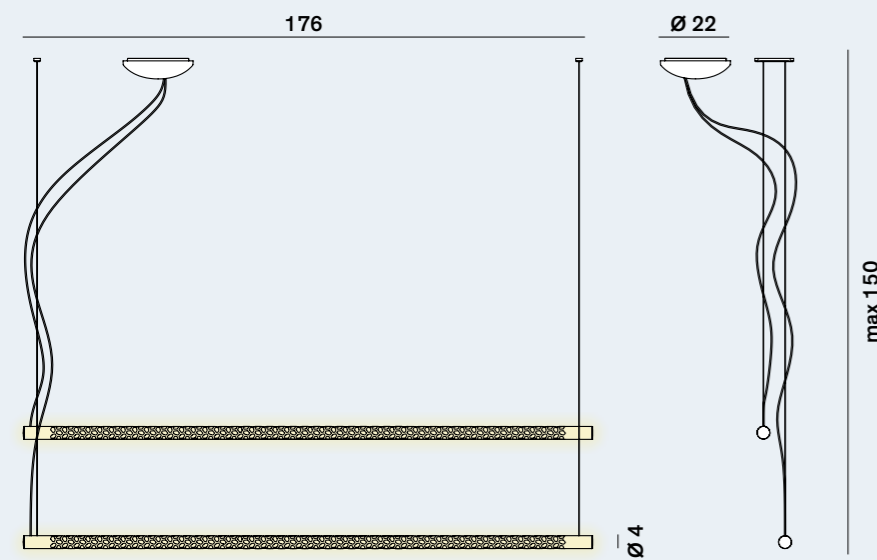

Light Source	MID POWER LED
Power	78 Watt
Kelvin	2.700, 3.000
Dimmer	push, dali, 0/1-10 V, casambi
Lumen	5.500
CRI	90

Squiggle: Floor

cod: F1

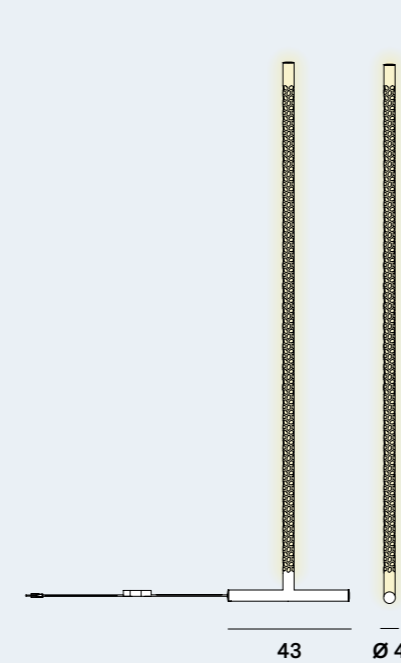

Light Source	MID POWER LED
Power	43 Watt
Kelvin	2.700, 3.000
Dimmer	foot
Lumen	3.000
CRI	90

Class **A / A+ / A++**

Design  
Paolo Rizzatto

Year  
17 / 20

Category: Suspension / Floor

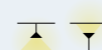

Catalogue



# String

Dante Donegani & Giovanni Lauda  
2011

**IT – È una famiglia che comprende, oltre alle versioni da scrivania e da parete, la versione da terra da utilizzare come lampada da lettura. La struttura dei due bracci è realizzata con un estruso in alluminio. Il movimento è bilanciato dal cavo elastico, rivestito in tessuto sintetico colorato. La base delle lampade da tavolo e da terra è in alluminio con zavorra in ghisa. La testa orientabile, stampata in materiale plastico, si impugna comodamente utilizzando il foro centrale. L'interruttore a sfioro comanda una sorgente LED. Nella versione String DTW è stata adottata una nuova elettronica LED dim to warm. L'interruttore inserito nella testa della lampada controlla la qualità della luce: possono essere modificate –in rapporto alle attività svolte e al momento dell'utilizzo– la luminosità e la temperatura di colore della luce, con valori variabili da 2500K (luce calda) a 4000 k (luce fredda).**

EN – This family of lamps includes the desk and wall versions as well as the floor version to be used as reading lamp. The structure of the two arms is made of extruded aluminum. The movement is balanced by the elastic cable, sheathed in synthetic coloured fabric. The base of the table and floor lamps is made of aluminium, with cast iron ballast. The adjustable head, made of moulded plastic, is easy to handle thanks to the central hole. The touch-sensitive switch controls a LED light source. In the String DTW version, a new LED dim-to-warm electronic technology has been used. The switch placed in the lamp's head controls light quality and adjusts, according to activity performed and time of use, the light's luminosity and correlated colour temperature, from 2500K (warm light) to 4000 K (cool light).

DE – Eine Produktfamilie, die neben den Tisch- und Wandversionen auch die Bodenversion als Leselampe enthält. Die Struktur der beiden Arme besteht aus einem Aluminiumprofil. Die Bewegung wird durch das mit farbigem Kunststoffgewebe überzogene elastische Kabel ausgeglichen. Der Sockel der Tisch- und Stehlampen besteht aus Aluminium mit Gusseisen-Beschwerung. Der aus Kunststoff geformte, schwenkbare Kopf kann bequem durch die zentrale Öffnung erfasst werden. Der Touch-Schalter steuert eine LED-Quelle. In der String DTW-Version wurde eine neue LED-Dim-to-Warm-Elektronik eingeführt. Der im Kopf der Lampe eingebaute Schalter steuert die Lichtqualität: Die Helligkeit und die Farbtemperatur des Lichts können in Abhängigkeit von den durchgeführten Aktivitäten und zum Zeitpunkt des Gebrauchs geändert werden, wobei die Werte von 2500 K (warmes Licht) bis 4000 k (kaltes Licht) variieren.

FR – Il s'agit d'une série qui comprend la version lampadaire pour la lecture, en plus des versions « bureau » et « applique ». La structure des deux bras est en aluminium extrudé. Le mouvement est équilibré par le câble élastique, recouvert de tissu synthétique coloré. La base des lampes de table et des lampadaires est en aluminium avec un élément de lestage en fonte. La tête orientable, en matière plastique, se saisit aisément par l'ouverture centrale. L'interrupteur à effleurement commande une source LED. La version String DTW a adopté un nouveau concept électronique à LED, dit 'dim to warm'. L'interrupteur incorporé dans la tête de la lampe contrôle la qualité de la lumière: on peut modifier la luminosité et la température de couleur de la lumière, avec des valeurs variant de 2500K (lumière chaude) à 4000 k (lumière froide), en fonction des activités à exercer et du moment de l'emploi.

ES – Familia que comprende, además de las versiones para escritorio y de pared, la versión de pie para utilizar como lámpara de lectura. La estructura de los dos brazos está realizada con aluminio extruido. El movimiento es balanceado por el cable elástico, revestido en tejido sintético de color. La base de las lámparas de mesa y de pie es de aluminio con lastre de hierro fundido. La cabeza orientable, moldeada en material plástico, se maneja cómodamente tomándola del orificio central. El interruptor táctil controla una fuente LED. En la versión String DTW se ha adoptado una nueva electrónica LED: dim to warm. El interruptor insertado en la cabeza de la lámpara controla la calidad de la luz. Según la actividad que se realice o el momento del uso, se pueden modificar la luminosidad y la temperatura de color de la luz, con valores que varían de 2500K (luz cálida) a 4000 k (luz fría).

Focus  
String



A

## String

La lampada a bracci snodati con movimenti bilanciati è una tipologia 'classica', difficile da affrontare per un progettista. Infatti i modelli che appartengono alla storia della lampada hanno introdotto soluzioni e parametri funzionali che rappresentano una sfida per ogni progetto che vuole essere innovativo e originale. La String è una novità tecnica ed estetica. La sua struttura è un sottile profilo metallico, che richiama la semplicità e la praticità di un vecchio strumento da lavoro: il metro pieghevole che si ripiega su sé stesso e si allunga diventando una unica riga. I bracci della lampada sono realizzati in estruso di alluminio con una sezione a doppia T. Il movimento è compensato dal cavo elastico, rivestito in tessuto sintetico (da cui il nome della lampada) che scorre nella sezione dell'estruso. Il cavo colorato, ripreso dell'abbigliamento sportivo, dà alla String una immagine ricercata e 'domestica', che si inserisce facilmente sia in casa che in ufficio. Con assoluta libertà di movimenti, la lampada si piega e ruota in ogni direzione

per dirigere il flusso luminoso e – come un metro pieghevole – può estendersi completamente per diventare un unico segno grafico, una struttura lineare che nasconde tutti i meccanismi (cavi, frizioni, pulegge, cerniere). La testa orientabile si impugna comodamente utilizzando il foro centrale. L'interruttore inserito nella testa controlla la luce diretta della sorgente LED oggi anche con tecnologia dim to warm. Queste caratteristiche estetiche e tecniche hanno generato una intera famiglia che comprende anche una versione extra large. La String XL è stata pensata per illuminare dall'alto un punto della casa (un angolo del divano, il tavolo da pranzo, la zona studio) con grande libertà: la luce diretta è effettivamente orientabile grazie a movimenti bilanciati e fluidi. La struttura della lampada è 'gigante' ma è rigida e leggera; è stata realizzata amplificando le dimensioni degli estrusi in alluminio della String da tavolo e utilizzando un cavo elastico, anch'esso XL, per bilanciare i movimenti.

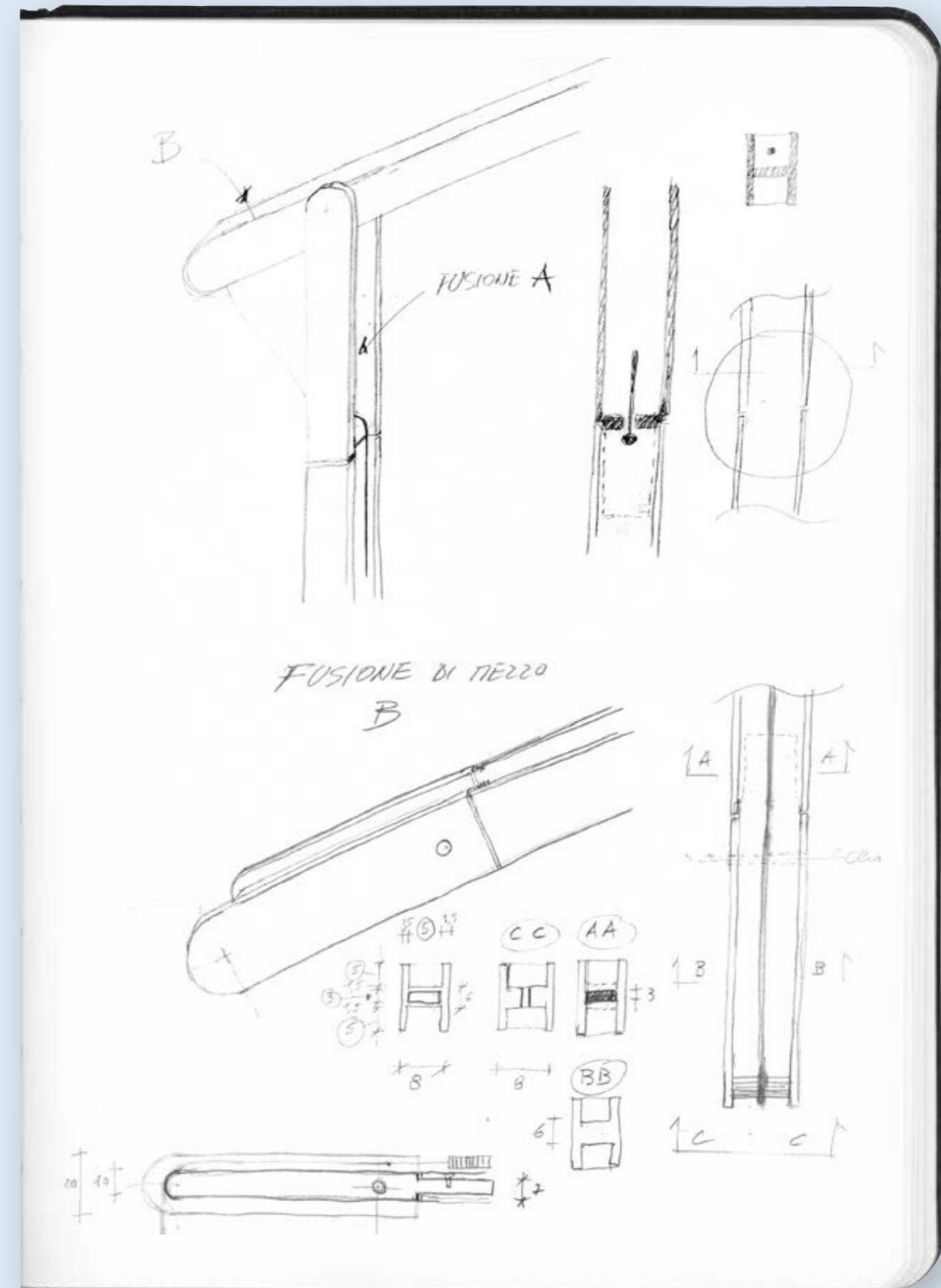

## String



D

The jointed arm lamp with balanced movement is a 'classic' type, a difficult trial for a designer. In fact, the models that belong to the history of lamps have introduced solutions and functional parameters that are a challenge for any project aiming at being original and innovative. String is both technically and esthetically new. Its structure consists of a thin metal profile that embodies the simplicity and functionality of an old work tool, the yardstick that folds together and when extended becomes one single line. The arms of the lamp are made of extruded aluminum with double-T cross-section. The movement is compensated by the elasticised cable sheathed in synthetic fabric (hence the name of the lamp) that runs inside the extruded aluminum arm's slot. The coloured cable, inspired by sportswear, gives String a sophisticated and 'domestic' air that makes it easy to be added to any home or office décor. Being absolutely free to move, the lamp folds and rotates in any direction

so as to direct the light and – just like a yardstick – can extend completely to become a single graphic sign, a linear structure that hides all of its mechanisms (cables, bearings, pulleys, hinges). The adjustable head can be easily handled thanks to the central hole. The switch located in the head controls the direct light of the LED source, today also with dim-to-warm technology. These esthetic and technical features have resulted in a whole family of lamps that also includes an extra-large version. String XL, in fact, has been designed to illuminate from above a spot of the home (a corner of the sofa, the dinner table, the study area) with the utmost liberty: the direct light is truly adjustable thanks to the lamp's balanced and fluid movement. The lamp's structure is 'gigantic' but rigid and light-weight. It has been built by expanding the size of the extruded aluminum parts of the table String version and by using an elastic XL cable to balance movement.

E



DE – Die Gelenkarmlampe mit ausbalancierten Bewegungen ist ein "klassischer" Typ, der für Designer schwer zu bewältigen ist. In der Tat haben die Modelle, die zur Geschichte der Lampe gehören, Lösungen und Funktionsparameter eingeführt, die eine Herausforderung für jedes tendenziell innovative und originelle Projekt darstellen. String ist eine technische und ästhetische Innovation. Seine Struktur ist ein dünnes metallisches Profil, das an die Einfachheit und Zweckmäßigkeit eines alten Arbeitswerkzeugs erinnert: den Zollstock, der sich um sich selbst zusammenlegt und beim Aufklappen zu einer einzigen Linie wird. Die Lampenarme bestehen aus extrudiertem Aluminium mit doppeltem T-Querschnitt. Die Bewegung wird durch das mit Kunststoffgewebe überzogene elastische Kabel (daher der Name der Lampe) kompensiert, das im extrudierten Querschnitt verläuft. Das an Sportkleidung erinnernde farbige Kabel verleiht der String-Lampe ein raffiniertes und „häusliches“ Erscheinungsbild, das sowohl zu Hause als auch im Büro gut passt. Die Lampe kann mit absoluter Bewegungsfreiheit in alle Richtungen gebogen und gedreht werden, um den Lichtfluss zu lenken. Sie kann sich wie ein Zollstock vollständig zu einem einzigen grafischen Zeichen ausdehnen, einer linearen Struktur, die alle Mechanismen (Kabel, Kupplungen, Riemenscheiben, Scharniere) verbirgt. Der schwenkbare Kopf kann bequem mit Hilfe der zentralen Öffnung erfasst werden. Der im Kopf eingebaute Schalter steuert das direkte Licht des LED-Leuchtmittels (nun auch mit Dim-to-Warm-Technologie ausgestattet). Diese ästhetischen und technischen Merkmale haben eine ganze Serie hervorgebracht, die auch eine besonders große Version enthält – String XL – die mit großer Freiheit einen bestimmten Punkt des Hauses (einer Ecke des Sofas, dem Esstisch, dem Arbeitsbereich) von oben beleuchtet: Das direkte Licht ist dank ausgeglichener und fließender Bewegungen effektiv einstellbar. Die Lampenstruktur ist "riesig", aber sie ist starr und leicht. Sie wurde ausgeführt, indem die Abmessungen der extrudierten Aluminiumprofile der String-Tischlampe verstärkt wurden und ein elastisches Kabel (ebenfalls XL) verwendet wurde, um die Bewegungen auszugleichen.

FR – La lampe à bras articulés aux mouvements équilibrés est de type 'classique', difficile à étudier pour ceux qui sont chargés d'un projet. En effet, les modèles qui ont fait l'histoire de la lampe ont introduit des solutions et des modèles fonctionnels qui représentent un défi pour chaque projet cherchant à être innovant et original. La lampe String est une nouveauté technique et esthétique. Sa structure est un profilé métallique mince, rappelant la simplicité et l'utilité pratique d'un vieux outil de travail: le mètre pliant, qui se replie et qui s'allonge pour ne former qu'une seule ligne. Les bras de la lampe sont en aluminium extrudé avec une section en double T. Le mouvement est compensé par le câble élastique, recouvert de tissu synthétique (d'où le nom de la lampe) qui se déplace dans la section de l'extrudé. Le câble coloré, s'inspirant des vêtements de sport, donne à String une image recherchée et 'de tous les jours', faisant qu'elle s'adapte facilement aussi bien à la maison qu'au bureau. En raison d'une liberté de mouvements absolue, on peut plier et tourner la lampe dans toutes les directions pour diriger le faisceau de lumière et – comme dans le cas d'un mètre pliant – on peut l'allonger complètement pour la transformer en un seul signe graphique, une structure linéaire qui cache tous les mécanismes (câbles, frictions, poulies, charnières). On saisit la tête orientable tout simplement par l'ouverture centrale. Maintenant, l'interrupteur incorporé dans la tête peut aussi contrôler la lumière directe de la source LED avec la technologie 'dim to warm'. Ces caractéristiques esthétiques et techniques ont donné lieu à toute une série de lampes comprenant également une version extra large. Le modèle String XL a été étudié pour éclairer d'en haut un certain point de la maison (un coin du divan, la table de la salle à manger, la zone du bureau), et ceci en toute liberté: la lumière directe est effectivement orientable grâce à des mouvements équilibrés et fluides. La structure de la lampe est 'géante', mais rigide et légère; elle a été réalisée en amplifiant les dimensions des éléments extrudés en aluminium de la lampe de table String et en utilisant un câble élastique, lui aussi XL, pour équilibrer les mouvements.

ES – La lámpara con brazos articulados y movimientos balanceados es un tipo 'clásico', difícil de abordar para un diseñador. En realidad, los modelos que pertenecen a la historia de la lámpara han introducido soluciones y parámetros funcionales que representan un desafío para cada diseño que desea ser innovador y original. La lámpara String es una novedad técnica y estética. Su estructura consiste en un perfil metálico sutil, que recuerda la simplicidad y la practicidad de un viejo instrumento de trabajo: el metro que se repliega sobre sí mismo y se alarga transformándose en una única línea. Los brazos de la lámpara son de aluminio extruido con una sección en doble T. El movimiento está compensado por el cable elástico, revestido en tejido sintético (de ahí el nombre de la lámpara) que se desliza en la sección del extruido. El cable de color, inspirado en la indumentaria deportiva, brinda a la String una imagen sofisticada y 'doméstica', que se incorpora fácilmente en una casa o en una oficina. Con absoluta libertad de movimiento, la lámpara se pliega y gira en cualquier dirección para dirigir el flujo luminoso y, como un metro plegable, se puede extender completamente para transformarse en un único signo gráfico, una estructura lineal que oculta todos los mecanismos (cables, fricciones, poleas, cremalleras). La cabeza orientable se sujeta cómodamente utilizando el orificio central. El interruptor insertado en la cabeza controla la luz directa de la fuente LED, que hoy también incluye la tecnología "dim to warm". Estas características estéticas y técnicas han generado toda una familia de productos que comprende también una versión extra large. La String XL ha sido pensada para iluminar desde lo alto un punto de la casa (el ángulo del diván, la mesa del comedor, la zona del escritorio) con gran libertad. La luz directa se puede orientar gracias a movimientos balanceados y fluidos. La estructura de la lámpara es 'gigante' pero rígida y ligera. Se ha realizado ampliando las dimensiones de los extruidos de aluminio de la String de mesa y utilizando un cable elástico, también XL, para balancear los movimientos.



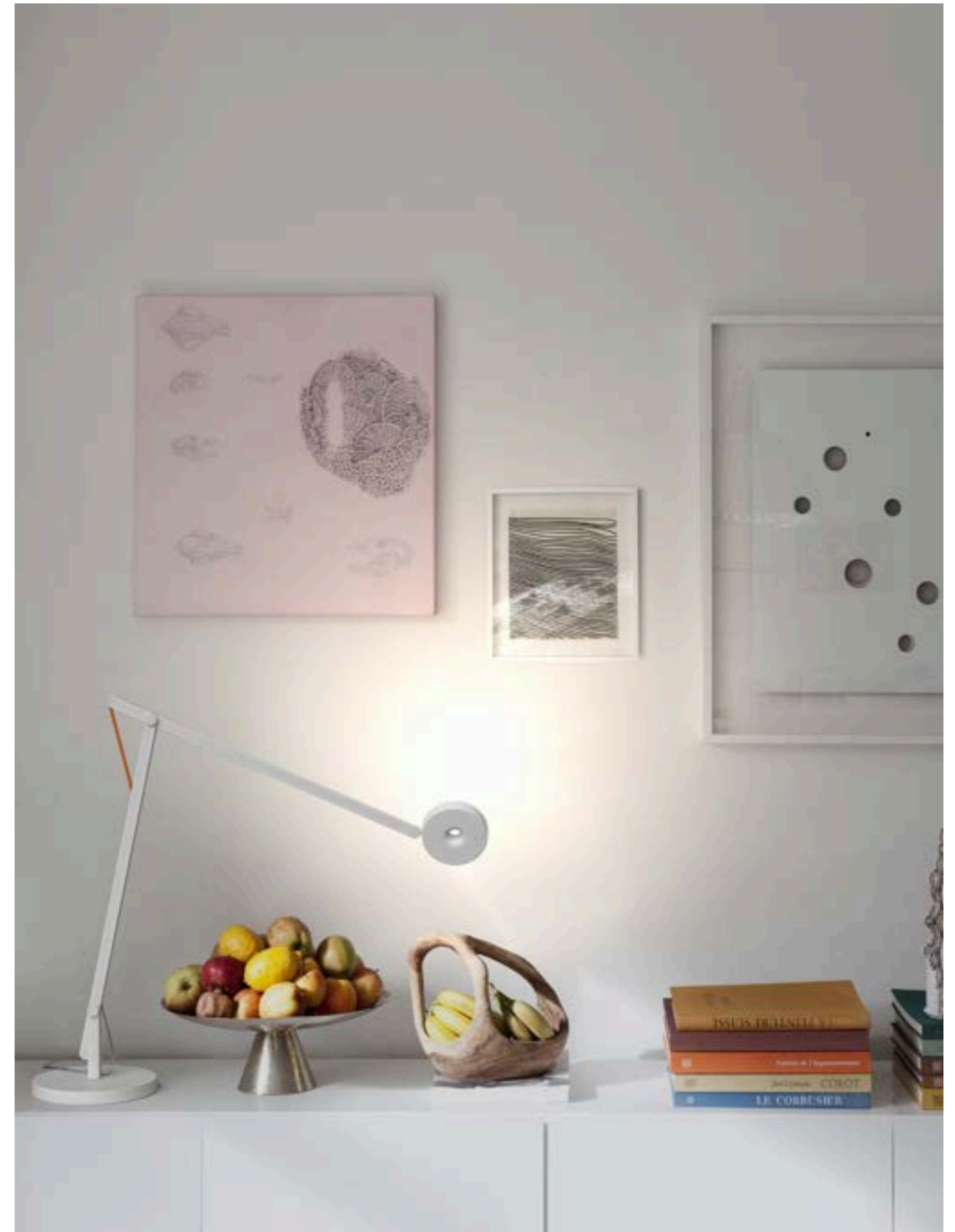



218

String



Design  
Donegani & Lauda

Year  
11

Category: Ceiling / Wall / Floor / Table



219

String: Floor / Table

cod: F1, T1

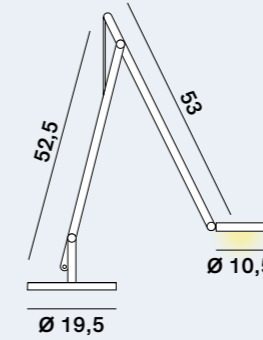
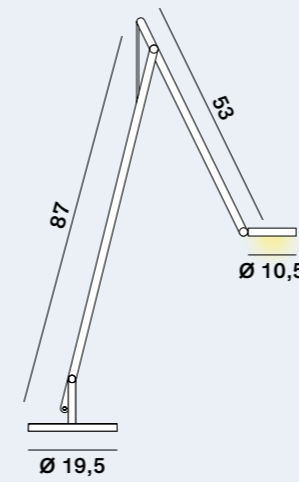

Light Source	MID POWER LED
Power	9 Watt
Kelvin	2.700
Kelvin DTW	2.500 » 4.000
Dimmer	push button
Dimmet DTW	push dim to warm
Lumen	700
Lumen DTW	100 » 600
CRI	90

String: Ceiling / Wall

cod: H0, WO, W1, W2

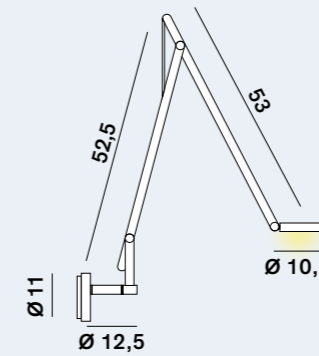
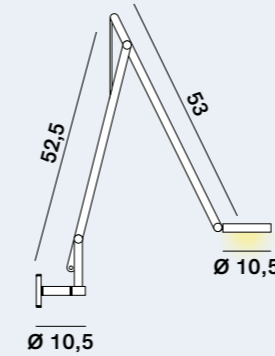
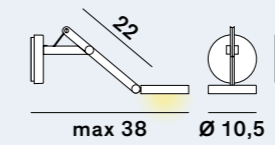
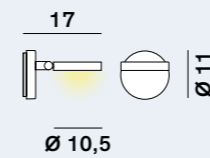

Light Source	MID POWER LED
Power	9 Watt
Kelvin	2.700
Kelvin DTW	2.500 » 4.000
Dimmer	push button
Dimmer DTW	push dim to warm
Lumen	700
Lumen DTW	100 » 600
CRI	90

Catalogue

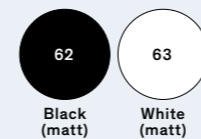

Satin Collection (upon request)



Kerakoll Warm Collection (upon request)



String colour

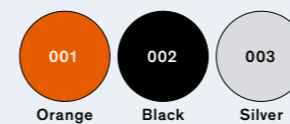

# String mini

Dante Donegani & Giovanni Lauda  
2021

IT – Rispetto alla sorella maggiore, String MINI è ridotta nelle dimensioni ma ha identiche prestazioni luminose e non perde nulla della propria funzionalità. Infatti, anche in questa versione i due bracci hanno il movimento bilanciato dal cavo elastico colorato e la tipica testa rotonda con il foro centrale per impugnarla comodamente, regolare ed orientare la luce in tutte le direzioni. Le dimensioni ridotte la rendono ancora più versatile: montata sulla base o sul supporto a muro è a suo agio negli spazi ridotti di una scrivania o accanto al letto.

EN – Compared to the original version, String MINI is smaller in size but has the same lighting performance and does not lose its functionality. Also this version has two arms with the movement balanced by the coloured elastic cable and the typical round head with a central hole to comfortably grip, adjust and direct the light in all directions.

The small size makes it even more versatile: mounted on the base or on the wall support it is perfect for small spaces on a desk or next to the bed.

DE – Im Vergleich zur originalen Version ist die neue String MINI kleiner, sie verliert jedoch nichts an Leistung und Funktionalität. Auch diese Version hat die zwei Arme, die durch das farbige elastische Kabel bewegt werden, und den typischen runden Kopf mit einem zentralen Loch, um das Licht bequem zu dimmen und in alle Richtungen orientieren.

FR – Comparée à sa grande sœur, String MINI est plus petite en taille tout en préservant ses fonctionnalités et performances d'éclairage identiques. En effet, même dans cette version, les deux bras ont un mouvement équilibré par le câble élastique coloré et la tête ronde typique avec le trou central permet de la manipuler aisément, ajuster et orienter la lumière dans toutes les directions.

ES – En comparación con su hermana mayor, String MINI es más pequeño en tamaño pero tiene un rendimiento de iluminación idéntico y no pierde su funcionalidad. De hecho, incluso esta versión tiene dos brazos con el movimiento equilibrado por el cable elástico de color y la típica cabeza redonda con un agujero central para agarrar, ajustar y dirigir la luz cómodamente en todas las direcciones.





String

String mini



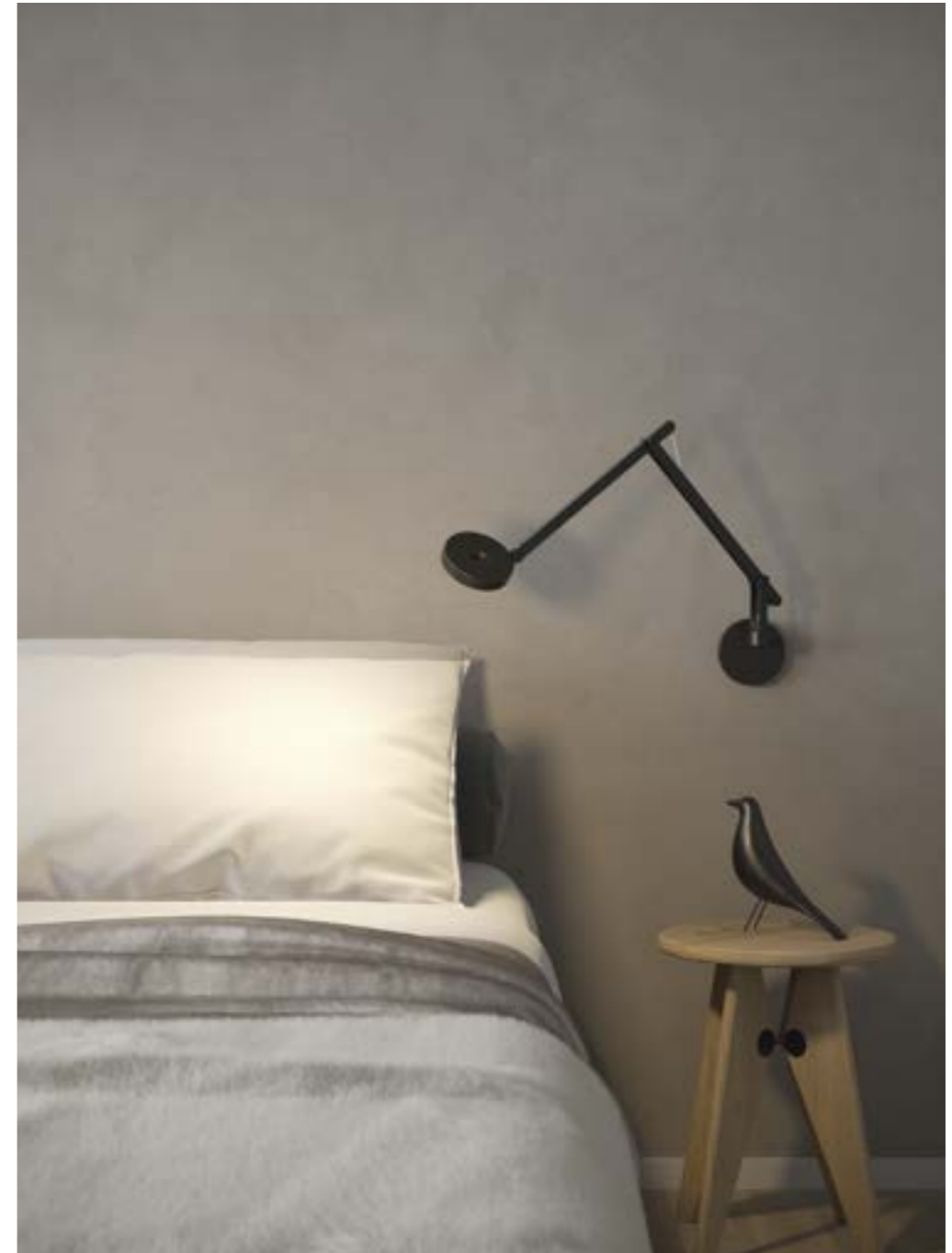

## String mini

String mini



String



String mini: Table

cod: T1 mini / T1 mini DTW

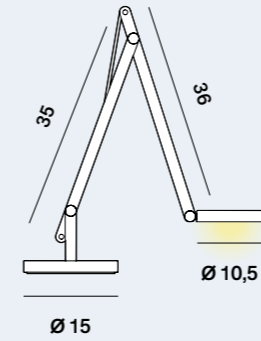

Light Source	MID POWER LED
Power	9 Watt
Kelvin	2.700
Kelvin DTW	2.500 » 4.000
Dimmer	push button
Dimmet DTW	push dim to warm
Lumen	700
Lumen DTW	100 » 600
CRI	90

String mini: Wall

cod: W2 mini / W2 mini DTW

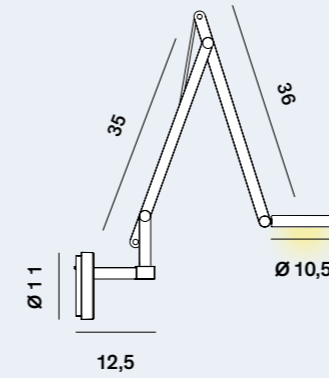

Light Source	MID POWER LED
Power	9 Watt
Kelvin	2.700
Kelvin DTW	2.500 » 4.000
Dimmer	push button
Dimmet DTW	push dim to warm
Lumen	700
Lumen DTW	100 » 600
CRI	90

## Catalogue

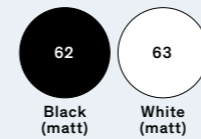

62 Black (matt)  
63 White (matt)

## Satin Collection (upon request)



20 Graphite 33 Royal gold 43 Silver 48 Dark bronze 64 Bronze 65 Champagne

## Kerakoll Warm Collection (upon request)



W2 Sand W4 Rope color W6 Dove-gray W8 Coffee

## String colour

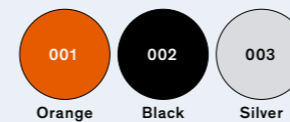

001 Orange 002 Black 003 Silver



# String XL

Dante Donegani & Giovanni Lauda  
2015

IT – La struttura in alluminio è sostenuta da una base con zavorra in ghisa e dotata di un cavo elastico colorato che ne compensa i movimenti. Nel braccio inferiore è integrato un dimmer a tocco e la testa, dotata di un diffusore in policarbonato che scherma la luce diretta dei LED, è orientabile.

EN – The aluminium structure is supported by a base with cast-iron ballast with a coloured elastic cord that compensates the movements. A touch dimmer is built into the lower arm and the head, which features a polycarbonate diffuser, shields the direct light of the LEDs and is adjustable.

DE – Die Struktur aus Aluminium lagert auf einem mit Gusseisen beschwerten Fuß und ist mit einem farbigen, elastischen Kabel ausgestattet, das die Bewegungen ausgleicht. Im unteren Arm ist ein Touch-Dimmer eingebaut. Der Kopf mit Schirm aus durchscheinendem oder verchromtem Polykarbonat kaschiert das direkte Licht der LEDs und ist schwenkbar.

FR – La structure en aluminium est soutenue par une base avec lest en fonte et équipée d'un câble élastique coloré qui en compense les mouvements. Dans le bras inférieur se trouve un variateur tactile et la tête, équipée d'un diffuseur en polycarbonate qui filtre la lumière directe des LEDs est orientable.

ES – La estructura de aluminio está sostenida por una base con contrapeso de fundición y dispone de un cable elástico de color que compensa sus movimientos. En el brazo inferior se halla un regulador táctil y la cabeza, dotada de un difusor de policarbonato que sirve de pantalla a la luz directa de los LEDs, es orientable.



230

# String XL



Design  
Donegani & Lauda

Year  
15

Category: Floor 

231

String: Floor

cod: XL

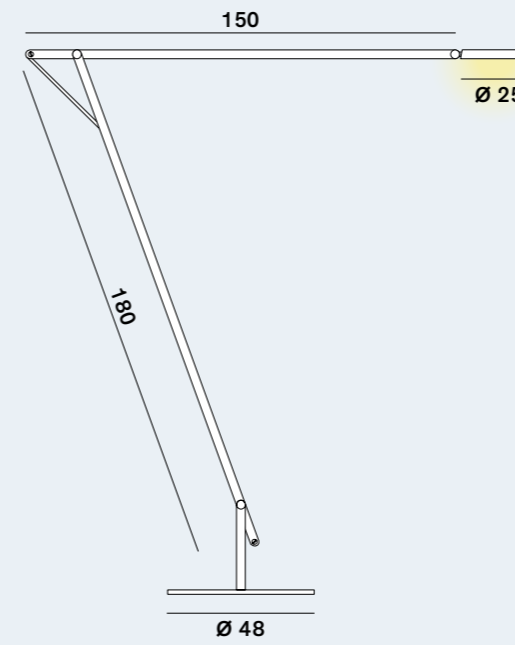

Light Source	MID POWER LED
Power	43 Watt
Kelvin	2.700
Dimmer	touch
Lumen	3.100
CRI	90

## Examples of configuration

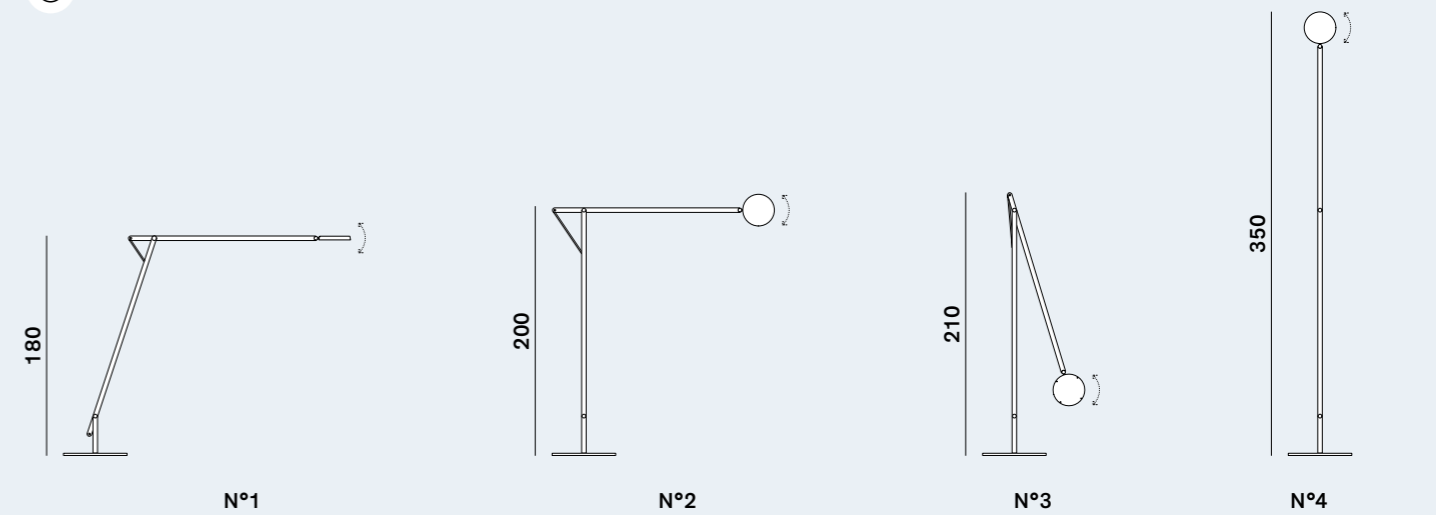

## Catalogue

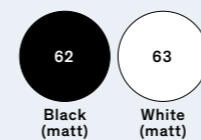

## String colour

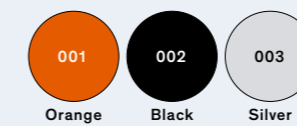

# Sunset

Paolo Dell'Elce  
2015

IT – Lampada ad emissione indiretta realizzata in alluminio. All'aspetto emozionale si collega quello funzionale: la testa curva della lampada infatti è stata concepita per sfruttare al meglio la riflessione della luce sulle pareti.

EN – This indirect-lighting lamp is made of aluminium. Its emotional shape is also functional: in fact, the curved head of the lamp has been designed to enhance the reflection of light onto the walls.

DE – Aluminiumleuchte mit indirekter Lichtabstrahlung. Zu dem emotionalen Aspekt gesellt sich der praktische: der gewölbte Kopf der Lampe wurde so konzipiert, um auf bestmögliche Weise die Reflexion des Lichts an den Wänden auszunutzen.

FR – Lampe à émission indirecte en aluminium. Son aspect émotionnel est étroitement lié à son rôle fonctionnel : la tête recourbée de la lampe est en effet conçue pour exploiter au mieux la réflexion de la lumière sur les murs.

ES – Lámpara de emisión indirecta realizada de aluminio. Al aspecto emocional se une el aspecto funcional: la cabeza curva de la lámpara ha sido concebida para aprovechar del mejor modo posible la reflexión de la luz en las paredes.

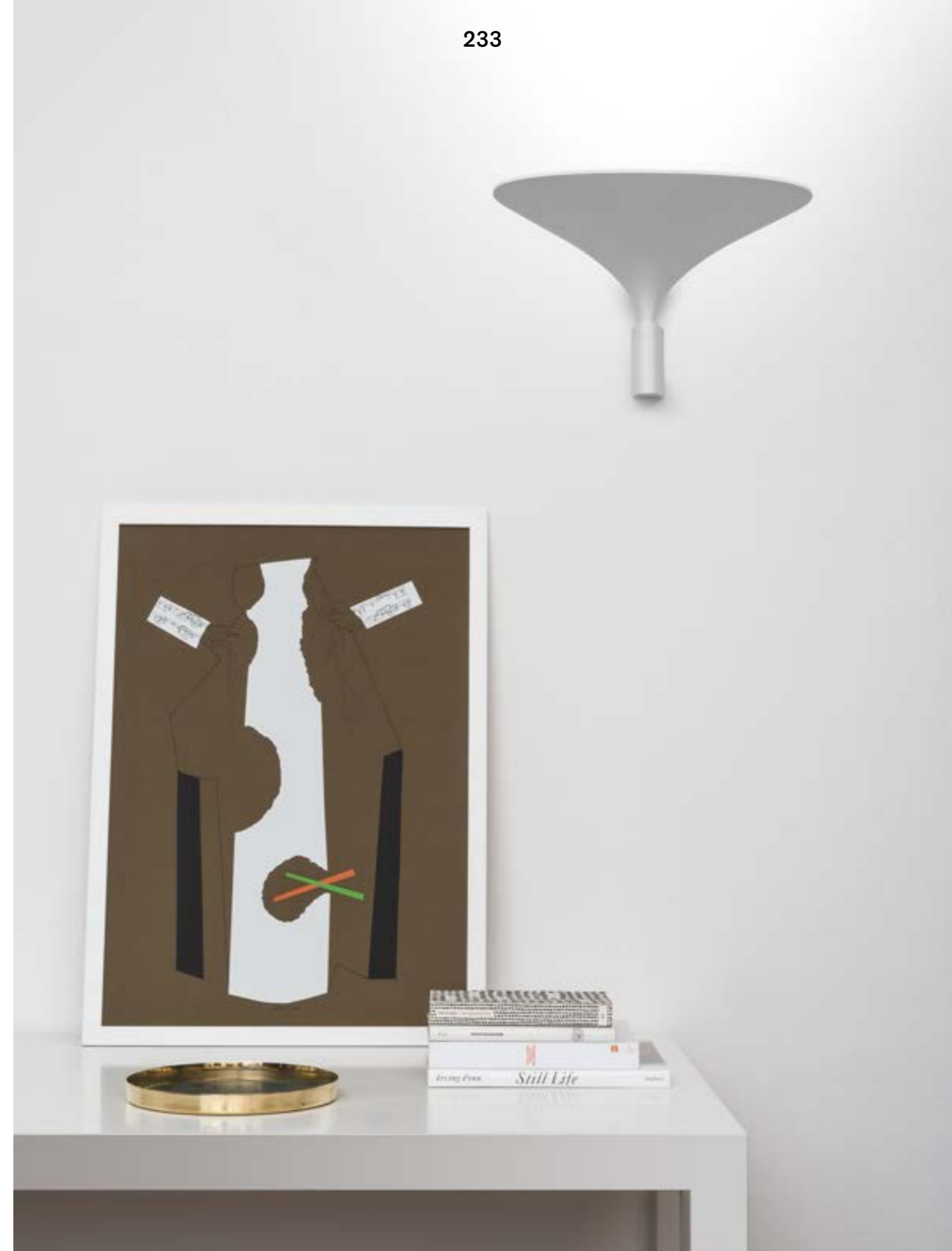

234

Sunset



Design  
Paolo Dell'Elce

Year  
15

Category: Floor / Wall



235

Sunset: Wall

cod: W0, W1

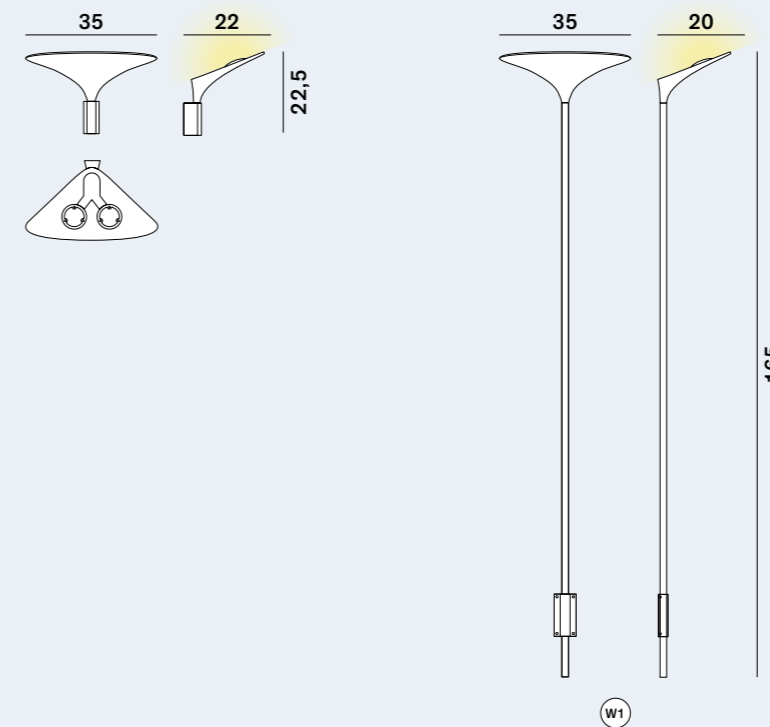

Light Source	ACRICHE HV LED
Power	34 Watt
Kelvin	2.700, 3.000
Dimmer (W0)	phase
Dimmer (W1)	foot
Lumen	3.400
CRI	90

Sunset: Floor

cod: F1

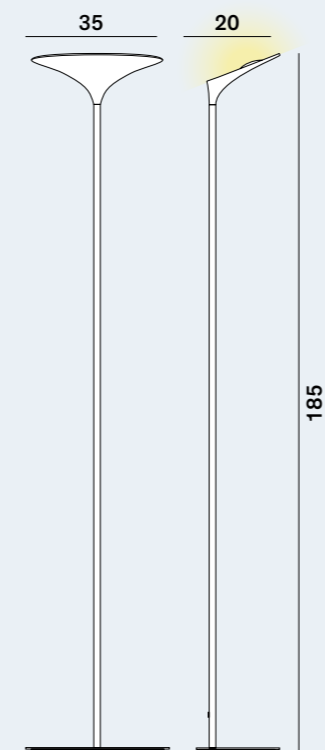

Light Source	ACRICHE HV LED
Power	34 Watt
Kelvin	2.700, 3.000
Dimmer	foot
Lumen	3.400
CRI	90

Catalogue

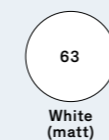

Satin Collection (upon request)



Kerakoll Warm Collection (upon request)



# Tick

Dante Donegani & Giovanni Lauda  
2011

IT – Lampada a luce indiretta, posizionabile a parete o a soffitto, in verticale o in orizzontale. Il corpo sottile, in pressofusione di alluminio, racchiude la sorgente LED, le componenti elettroniche ed il sistema di fissaggio a muro.

EN – This indirect light lamp can be fixed to the wall or suspended from the ceiling, either horizontally or vertically. The narrow, die-cast aluminum body encloses the LED light source, the electronic components and the wall-mounting system.

DE – Indirekt beleuchtende Lampe, die vertikal oder horizontal an der Wand oder an der Decke angebracht werden kann. Der dünne Körper aus Aluminiumdruckguss umschließt das LED-Leuchtmittel, die elektronischen Komponenten und das Wandbefestigungssystem.

FR – Lampe à lumière indirecte, à positionner au mur ou au plafond, à la verticale ou à l'horizontale. Le corps mince, en aluminium moulé sous pression, renferme la source LED, les éléments électroniques et le système de fixation au mur.

ES – Lámpara de luz indirecta, para pared o cielorraso, colocación vertical u horizontal. El cuerpo sutil, de aluminio fundido a presión, aloja la fuente luminosa LED, los componentes electrónicos y el sistema de fijación a la pared.



238

Tick



239

Tick: Ceiling / Wall

cod: W0

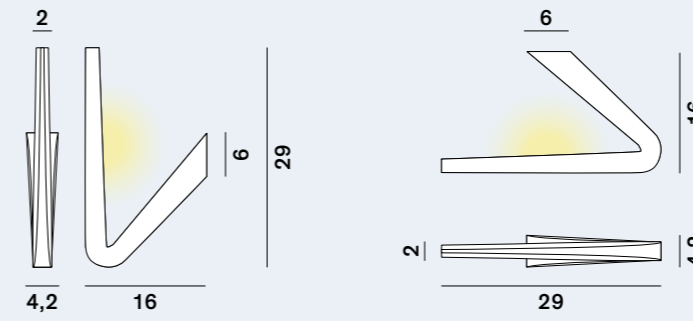

Light Source	MID POWER LED
Power	14 Watt
Kelvin	2.700
Lumen	1.200
CRI	90

Catalogue

Satin Collection (upon request)



63

White (matt)

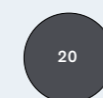

20

Graphite



33

Royal gold



43

Silver

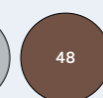

48

Dark bronze



62

Matt black

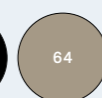

64

Bronze

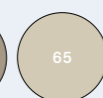

65

Champagne

Design  
Donegani & Lauda

Year  
11

Category: Ceiling / Wall

# Tide

Paolo Dell'Elce  
2013

IT – Lampada in alluminio ad emissione indiretta, Tide è caratterizzata da una sottile e sinuosa geometria che le dona leggerezza visiva e strutturale senza rinunciare ad un elevato flusso luminoso.

EN – Tide is an indirect emission aluminium lamp featuring a thin and sinuous geometry that translates into visual and structural lightness while providing a very high light flow.

DE – Tide ist eine Aluminium-Leuchte mit indirekter Lichtabstrahlung. Sie zeichnet sich für ihre feine, gewundene Geometrie aus, die ihr in Bezug auf Aussehen und Struktur Leichtigkeit verleiht, ohne auf einen hohen Lichtstrom zu verzichten.

FR – Lampe en aluminium à émission indirecte, Tide se caractérise par une géométrie mince et sinueuse qui lui procure une légèreté visuelle et structurelle, tout en ne renonçant pas à un flux lumineux très intense.

ES – Lámpara de aluminio de emisión indirecta caracterizada por una sutil y sinuosa geometría que le proporciona ligereza visual y estructural sin renunciar a un elevado flujo luminoso.



242

# Tide



Design **Paolo Dell'Elce** Year **13** Category: **Wall** 

243

Tide: Wall

cod: W0

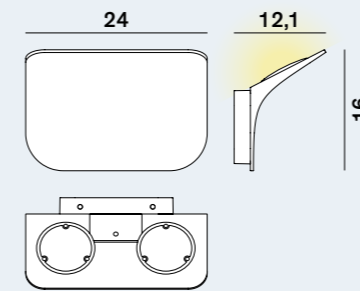

Light Source	ACRICHE HV LED
Power	34 Watt
Kelvin	2.700, 3.000
Dimmer	phase
Lumen	3.400
CRI	90

### Catalogue



63

White (matt)

### Satin Collection (upon request)

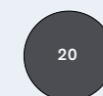

20

Graphite



33

Royal gold



43

Silver



48

Dark bronze



62

Matt black

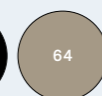

64

Bronze

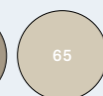

65

Champagne

### Kerakoll Warm Collection (upon request)



W2

Sand



W4

Rope color



W6

Dove-gray



W8

Coffee



# Tobu

Tommaso Tommasi  
2021

**IT – È una famiglia di lampade da terra e da parete. La luce, indiretta e diffusa, è emessa da due diffusori. Tobu prende spunto dalla torcia simbolo delle olimpiadi e celebra la recente assegnazione a Milano e Cortina dei giochi olimpici invernali del 2026. È concepita per grandi spazi museali, teatri o abitazioni con soffitti da illuminare e mettere in evidenza. Il supporto in acciaio sostiene i due cilindri in alluminio orientabili. I dimmer sono posti nella parte terminale dei cilindri e consentono la regolazione separata dei due proiettori a seconda delle necessità del luogo e dell'intensità di luce richiesta. L'ottica è intercambiabile e consente di montare 4 diversi tipi di riflettore: 20°, 30°, 50° e 90°.**

EN – Tobu is a family of wall and floor lamps. The indirect and diffused light is emitted from two light sources. It is inspired by the torch that symbolises the Olympic games and celebrates the recent awarding to Milan and to Cortina of the 2026 Winter Olympics. It is designed for large spaces in museums, theatres and houses with ceilings to be lit up and highlight the ambiance. The steel stem holds the two orientable aluminum cylinders. The dimmers are inserted at the bottom of the cylinders and allow for separate adjustment of the two projectors, according to location needs and to light intensity required. The interchangeable optics allow to use 4 different types of reflectors: 20°, 30°, 50° and 90°.

DE – Tobu ist eine Familie aus Steh und Wandleuchten mit zwei Diffusoren, die indirektes sowie diffuses Licht sorgen. Tobu inspiriert sich an der Olympiafackel und feiert Mailand und Cortina, die vor kurzer Zeit Austragungsorte für die olympischen Winterspiele 2026 genannte wurden. Tobu ist für die Beleuchtung von großen Museumsräume, Theater oder Wohnungen konzipiert, um die Decken hervorzuheben. Die Struktur aus Stahl trägt die beiden orientierbaren Aluminiumzylinder. Das Dimmer befindet sich am Endbereich der Zylinder und ermöglicht eine getrennte Einstellung der zwei Scheinwerfer, je nach den Bedürfnissen des Raumes und der gewünschten Lichtstärke. Die auswechselbare Optik erlaubt die Montage von 4 verschiedenen Scheinwerfertypen: 20°, 30°, 50° und 90°.

FR – C'est une série de lampadaires et d'appliques. Deux diffuseurs émettent une lumière indirecte et diffuse. Tobu a été inspirée par la torche qui est le symbole des Jeux olympiques pour fêter la décision récente d'accueillir les jeux olympiques d'hiver 2026 à Milan et à Cortina. Elle est conçue pour de grands espaces dans des musées, des théâtres ou des habitations avec des plafonds à éclairer pour tout mettre en vue. Le support en acier soutient les deux cylindres d'aluminium orientables. Les variateurs d'intensité se trouvent dans la partie terminale des cylindres et permettent de régler les deux projecteurs séparément, en fonction des exigences des lieux et de l'intensité de lumière voulue. Le matériel optique est interchangeable et permet de monter 4 types de réflecteurs : 20°, 30°, 50° et 90°.

ES – Es una familia de lámparas de pie y de pared. La luz indirecta y difusa es emitida por dos difusores. Tobu se inspira en la antorcha olímpica y celebra la reciente asignación de los Juegos Olímpicos de Invierno de 2026 a Milán y Cortina. Ha sido concebida para grandes espacios museísticos, teatros o viviendas con cielorrasos para iluminar y así resaltar todo el ambiente. El soporte de acero sostiene los dos cilindros de aluminio orientables. Los reguladores están situados en el extremo de los cilindros y permiten ajustar los dos proyectores por separado según las necesidades del lugar y la intensidad de luz requerida. Las ópticas son intercambiables, lo que permite montar 4 tipos diferentes de reflectores: 20°, 30°, 50° y 90°.



1



2



1

IT – Interruttore / dimmer  
 EN – Switch / dimmer  
 DE – Schalter/ Dimmer  
 FR – Interrupteur / gradateur de lumière tactile  
 ES – Interruptor / regulador de intensidad

2

IT – 4 diversi tipi di riflettore: 20°, 30°, 50° e 90°  
 EN – 4 different types of reflectors: 20°, 30°, 50° and 90°  
 DE – 4 verschiedenen Scheinwerfertypen: 20°, 30°, 50° und 90°  
 FR – 4 types de réflecteurs : 20°, 30°, 50° et 90°  
 ES – 4 tipos diferentes de reflectores: 20°, 30°, 50° y 90°

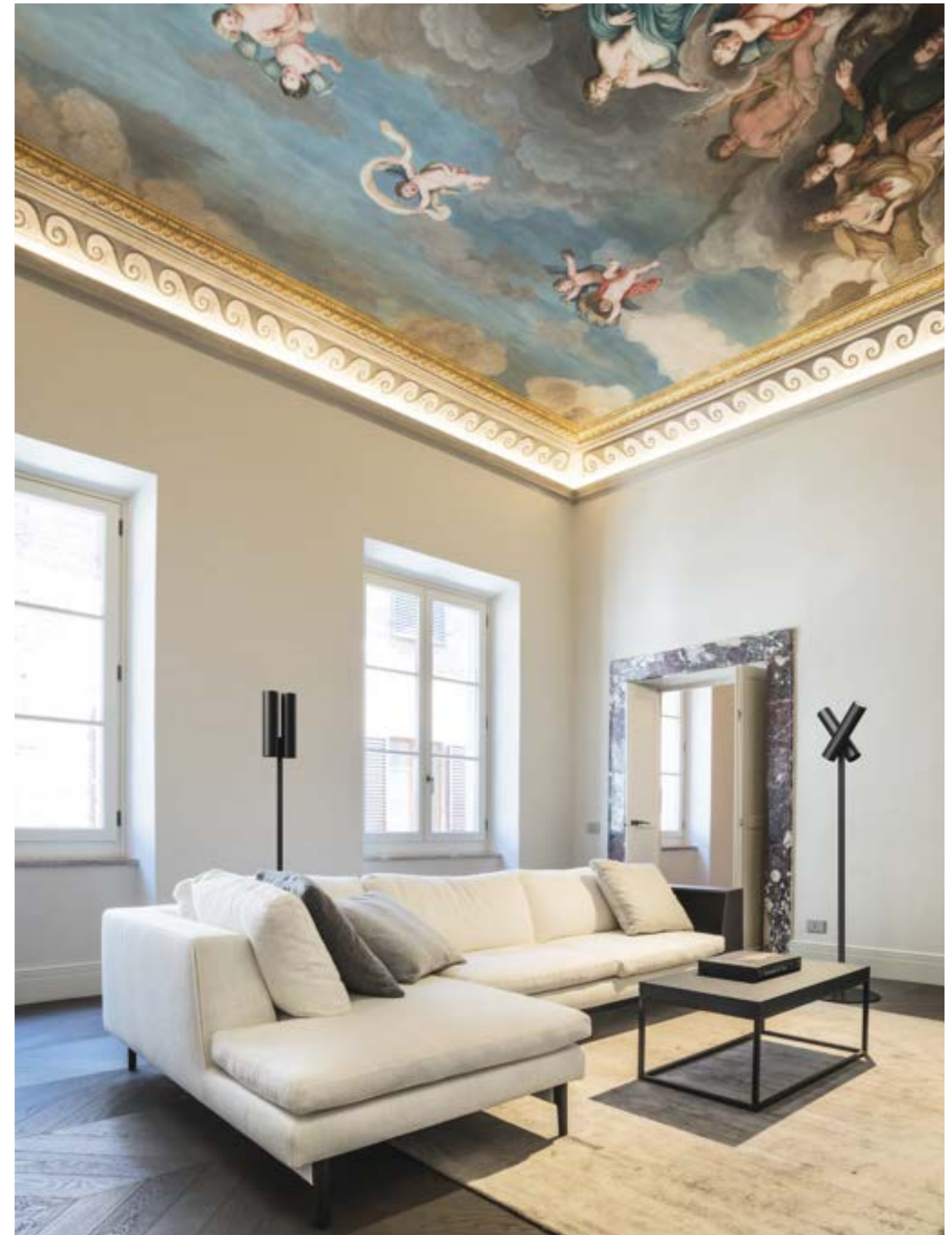

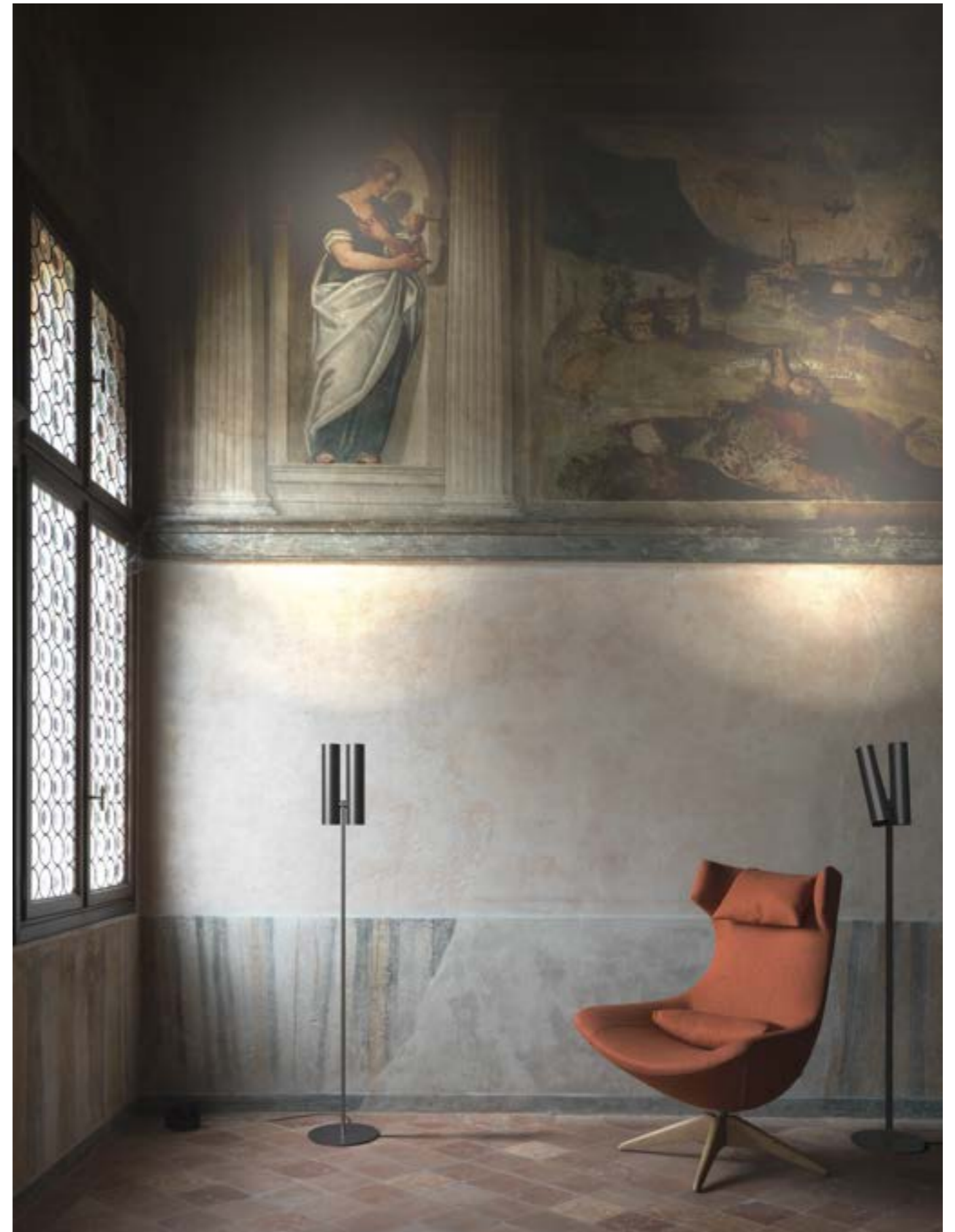
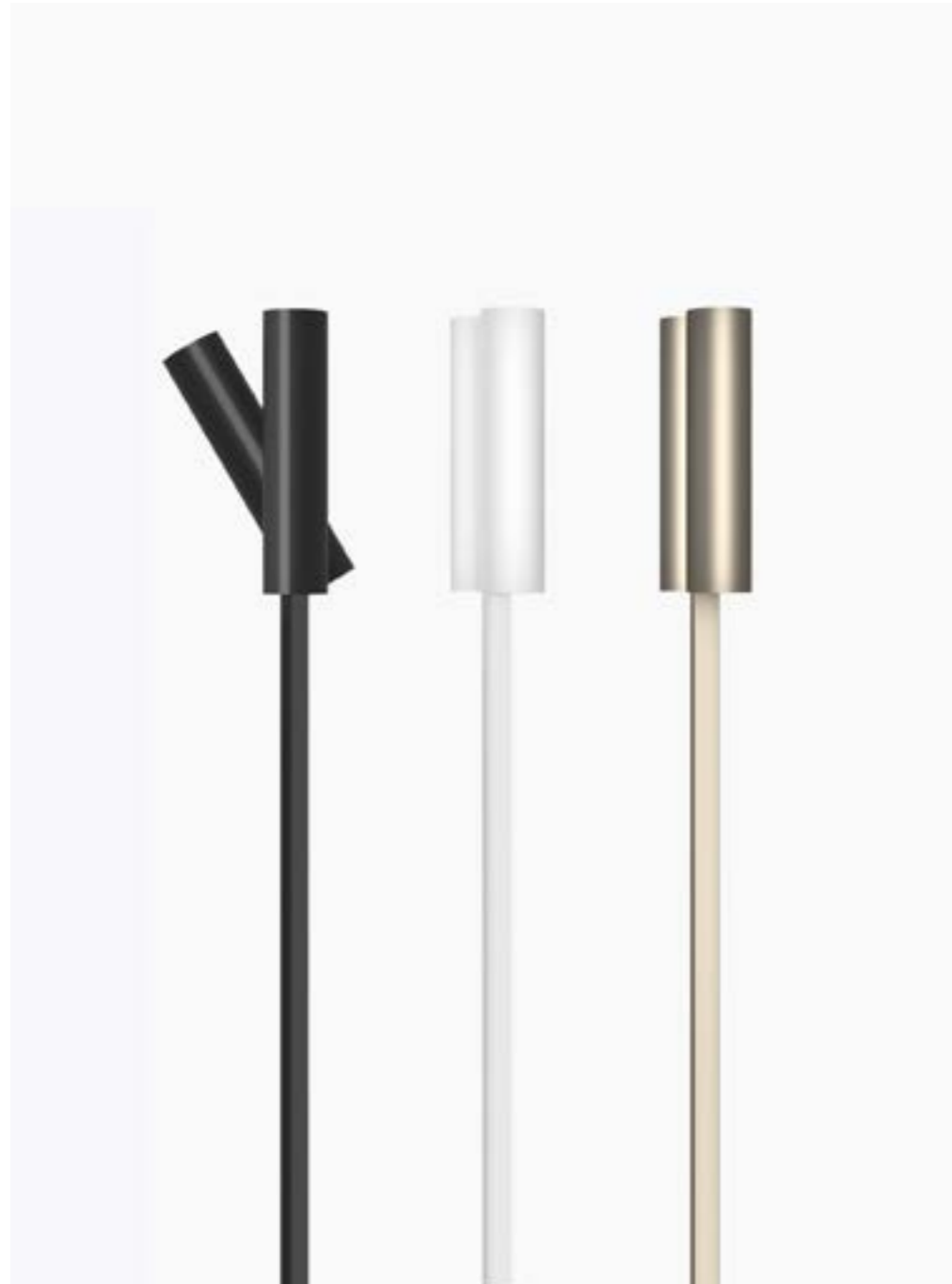



252

Tobu



Design  
Tommaso Tommasi

Year  
21

Category: Floor / Wall 

253

Tobu: Floor

cod: F1

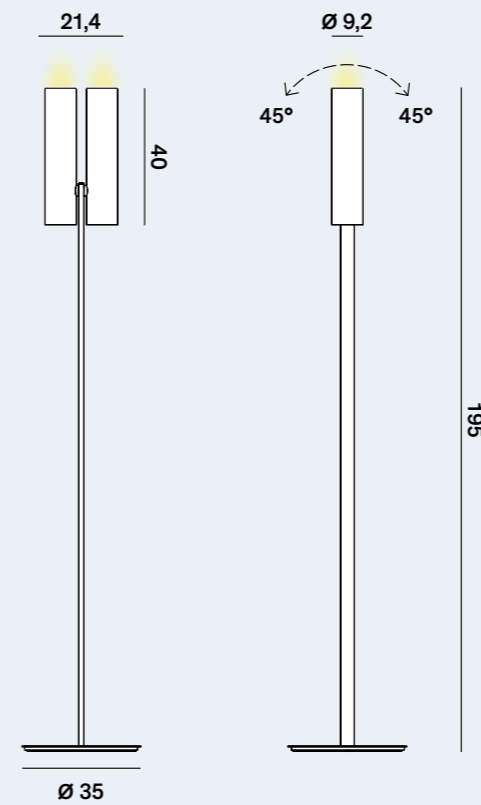

Light Source	COB LED
Power	76 Watt
Kelvin	2.700, 3.000
Dimmer	potenziometro
Lumen	7.100
CRI	90
Reflectors	20°, 30°, 50°, 90°

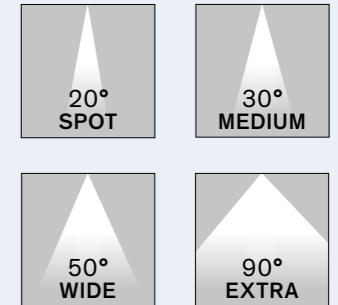

Tobu: Wall

cod: W1

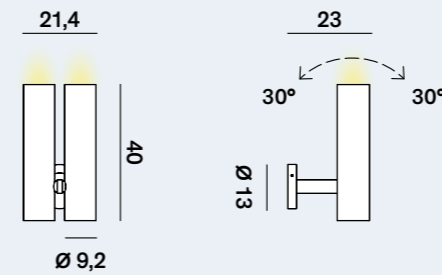

Light Source	COB LED
Power	76 Watt
Kelvin	2.700, 3.000
Dimmer	potenziometro
Lumen	7.100
CRI	90
Reflectors	20°, 30°, 50°, 90°

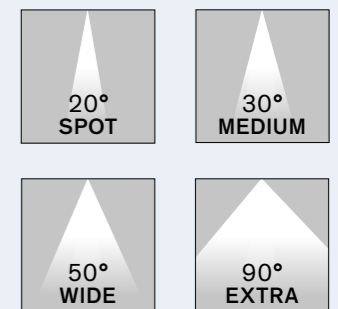

Catalogue

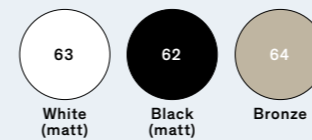

# Venere

Giovanni Lauda  
2021

IT – È una lampada a luce diffusa da installare a parete o a soffitto. La sorgente LED, di grande efficienza luminosa, è dimmerabile. Il corpo, composto da due elementi sovrapposti e incernierati tra di loro, è una fusione in alluminio mentre il diffusore è in policarbonato opalino stampato ad iniezione. La lampada, sottile ed elegante, è perfettamente integrata nelle superfici delle pareti ma si può aprire fino a 96° e ruotare in tutte le direzioni per orientare la luce nella direzione desiderata. La forma circolare ed il movimento della lampada ricordano un occhio che rivolge lo sguardo intorno a sé oppure l'occhio di una Venere affetta da strabismo, leggendario elemento di fascinazione estetica.

EN – Venere is a diffused-light wall- or ceiling-mounted lamp. The highly illuminating LED light source is dimmerable. The main body of the lamp, consisting of two overlapping elements joined by a hinge, is an aluminum casting while the diffuser is made of injection-molded opaline polycarbonate. This slim and elegant lamp is perfectly integrated in the wall or ceiling surface, but can open out to 96° and rotate in all directions when the light needs to be beamed towards a specific target. Its circular shape and its movement are reminiscent of a human eye looking around or of the 'strabismus of Venus', a fascinating element of legendary beauty.

DE – Venere ist eine Leuchte mit diffusem Licht, die an der Wand oder an der Decke installiert werden kann. Die Led-Lichtquelle mit höher Leistung ist dimmbar. Die Wand-Deckenleuchte besteht aus zwei überlappenden und klappbaren Elementen aus Aluminiumguss, während der Diffusor aus spritzgegossenem opalen Polycarbonat besteht. Die Leuchte, perfekt und elegant, integriert sich ideal an der Wand. Sie lässt sich bis zu 96° öffnen und in alle Richtungen drehen, um das Licht in die gewünschte Richtung zu orientieren. Die runde Form und die Bewegung der Leuchte erinnern an ein Auge, welches den Blick um sich selbst dreht, oder an das Auge einer Venus mit Silberblick, einem legendären Element ästhetischer Faszination.

FR – Cette lampe créant une lumière diffuse peut s'appliquer au mur ou au plafond. La source à diode électroluminescente, d'une grande efficacité lumineuse, est dimmable. Le corps, en deux éléments superposés et articulés entre eux, est fait d'une fusion d'aluminium, tandis que le diffuseur est en polycarbonate opalin moulé par injection. La lampe, d'une minceur élégante, s'inscrit parfaitement dans les surfaces des murs, mais peut également s'ouvrir jusqu'à 96° et tourner dans toutes les directions, de façon à orienter la lumière dans la direction voulue. La forme circulaire de la lampe et son mouvement rappellent un œil qui tourne pour regarder autour de soi ou bien l'œil d'une Vénus au strabisme légendaire en faisant le charme.

ES – Es una lámpara de luz difusa para instalar en la pared o en el techo. La fuente LED, dotada de alta eficiencia luminosa, es regulable. El cuerpo, compuesto por dos elementos sobrepuestos y unidos entre sí por bisagras, es una fusión de aluminio, mientras que el difusor es de policarbonato opalino moldeado por inyección. La lámpara, delgada y elegante, se integra perfectamente en las superficies de las paredes, pero puede abrirse hasta 96° y girar en todas las direcciones para dirigir la luz hacia la dirección deseada. La forma circular y el movimiento de la lámpara recuerdan a un ojo que mira a su alrededor o al clásico estrabismo de Venus, elemento legendario de fascinación estética.

Focus  
Venere

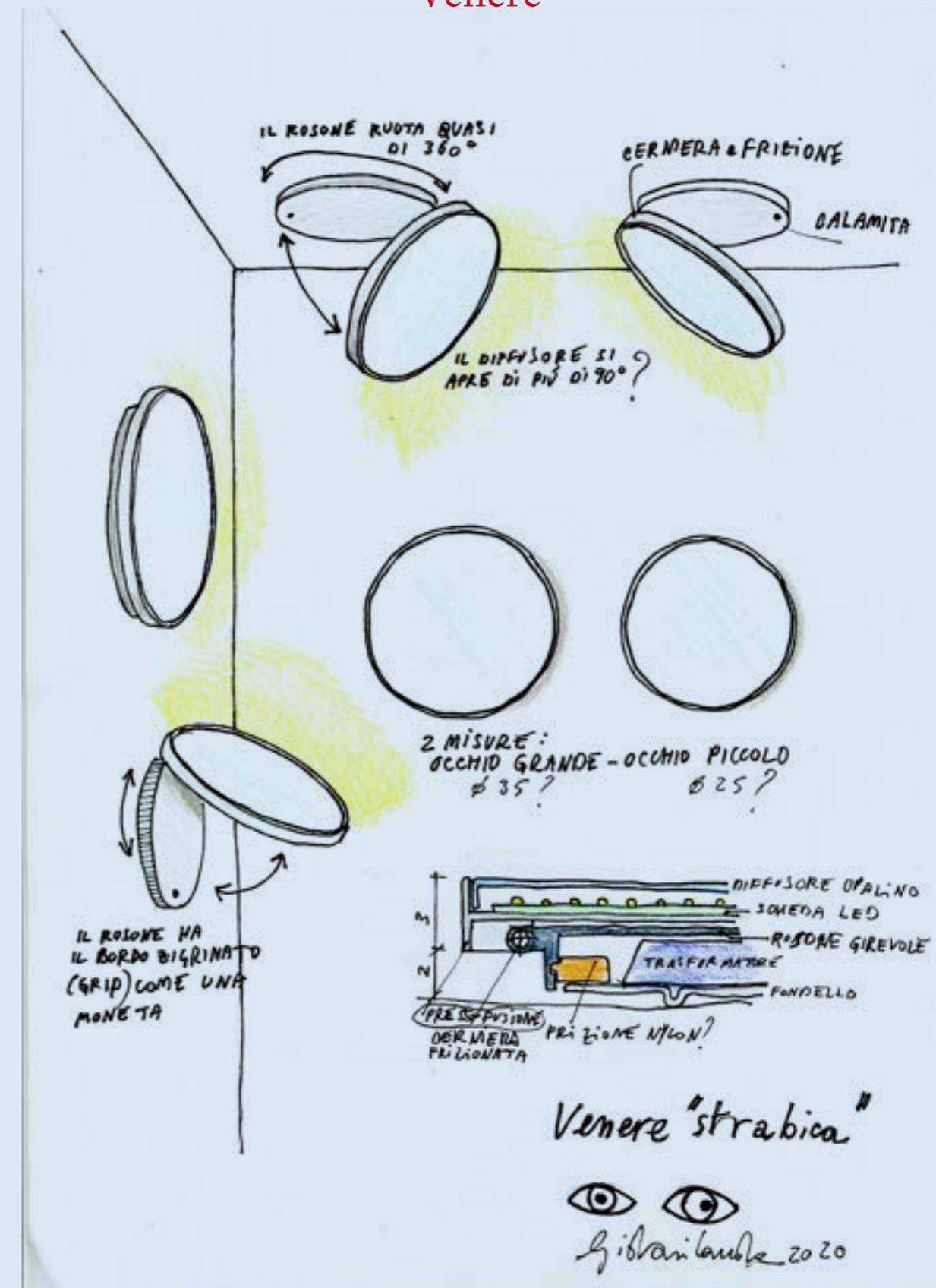

## Venere

### Lo strabismo di Venere

La forma circolare ed il movimento della lampada ricordano un occhio che rivolge lo sguardo intorno a sé, deviando dall'asse visivo. E' come l'occhio della dea della bellezza Venere, affetta da strabismo e capace di ammaliare con il suo sguardo.

Anche nella lampada Venere lo "strabismo", elemento di fascinazione estetica nella mitologia classica, è un pregio; una caratteristica funzionale che permette di plasmare lo spazio e renderlo più 'affascinante', accentuando la luce in un angolo dell'ambiente, rivolgendo l'apparecchio verso un elemento

dell'arredo, sottolineando un percorso.....

Molto sottile e aderente alla parete - quando è a riposo- la lampada è una presenza discreta ma estremamente performativa, con movimenti che permettono di orientare la luce come si farebbe con un faretto, senza però avere meccanismi a vista che ne comprometterebbero la semplicità formale.

Venere appartiene infatti ad una nuova categoria di lampade, poste al confine tra "tecnico" e "decorativo", che consentono di modificare, personalizzare e gestire la luce e possono essere impiegate indifferentemente in qualsiasi contesto.

### The Venus Squint

The circular shape and the flow of the lamp are reminiscent of an eye that turns its gaze around itself, deviating from the visual axis. It is just like the eye of Venus, the goddess of beauty, whose squint could make her gaze quite alluring. And in the Venere (Venus) lamp the "squint", an element of aesthetic fascination in classical mythology, becomes a virtue and a functional feature that allows modeling a space to make it more 'charming', accentuating light in a corner of the room, turning the lamp towards a piece of furniture, illuminating a walkway...

Very thin and adherent to the wall

when off, the lamp is a discreet yet high-performing presence, whose flow allows directing the light as you would with a spotlight, minus the visible mechanisms that would compromise the formal simplicity of the piece.

Indeed, Venere belongs to a new category of lamps, on the borderline between "technical" and "decorative", whose light can be adjusted, customized and managed to fit any setting with great versatility.

DE – Die runde Form und die Bewegung der Leuchte erinnern an ein Auge, welches den Blick um sich selbst dreht und von der Sichtachse abweicht, oder an das Auge einer Venus mit Silberblick, einem legendären Element ästhetischer Faszination. Bei der Leuchte Venere ist der „Silberblick“ ein Vorzug, eine Funktion, die es ermöglicht, den Raum zu formen und faszinierend zu machen. Dieser Effekt entsteht, indem man das Licht in eine Ecke des Raumes richtet, oder zu einem Möbelstück wendet oder eine Fläche betont. Die Leuchte ist flach und elegant, sie integriert sich ideal an der Wand. Venere hat eine unauffällige aber äußerst spektakuläre Präsenz. Sie lässt sich bis zu 96° öffnen und in alle Richtungen drehen. Das Licht kann, wie bei einem Strahler orientiert werden, ohne sichtbare Mechanismen zu haben, die ihre minimalistische Form beeinträchtigen würden. Zwischen technisch und dekorativ, gehört Venere zu einer neuen Typologie von Lampen, die zu jedem Raum passen.

FR – La forme circulaire et le mouvement de la lampe rappellent un œil qui regarderait autour de lui, en déviant de son axe de vision. Tout comme l'œil de la déesse de la beauté, Vénus, connue pour son strabisme et capable d'ensorceler les hommes et les dieux de son regard. Dans le cas de la lampe « Venere » (Vénus) également, le « strabisme », cet élément de charme esthétique dans la mythologie classique, devient un plus, une caractéristique fonctionnelle permettant de modeler l'espace et de le rendre plus 'séduisant' en accentuant la lumière dans un angle, en tournant le faisceau lumineux vers un meuble, en soulignant un parcours... Très mince, la lampe colle au mur quand elle est au repos; sa présence est discrète, mais extrêmement performante, avec des mouvements permettant d'orienter la lumière comme on le ferait avec un petit phare, sans toutefois avoir de mécanismes en vue qui en compromettraient la simplicité formelle. Venere appartient en effet à une nouvelle catégorie de lampes, se situant à la frontière entre ce qui est "technique" et ce qui est "décoratif", qui permettent de modifier, de personnaliser et de gérer la lumière, des lampes à utiliser partout indifféremment, quel que soit le contexte.

ES – La forma circular y el movimiento de la lámpara recuerdan a un ojo que mira a su alrededor, desviándose del eje visual. Es como el ojo de Venus, la diosa de la belleza que gracias a su estrabismo era capaz de hechizar con su mirada. También en la lámpara Venere el "estrabismo", elemento de fascinación estética en la mitología clásica, es una virtud; es una característica funcional que permite plasmar el espacio y hacerlo más "fascinante", acentuando la luz en un rincón de la habitación, dirigiendo el aparato hacia un mueble, destacando un recorrido... Muy delgada y adherida a la pared - cuando no se utiliza - la lámpara es una presencia discreta pero extremadamente funcional, con movimientos que permiten dirigir la luz como si fuera un foco, pero sin mecanismos visibles que comprometan su simplicidad formal. Venere pertenece a una nueva categoría de lámparas, colocadas en el límite entre "técnico" y "decorativo", que permiten modificar, personalizar y gestionar la luz y pueden ser utilizadas indiferentemente en cualquier contexto.





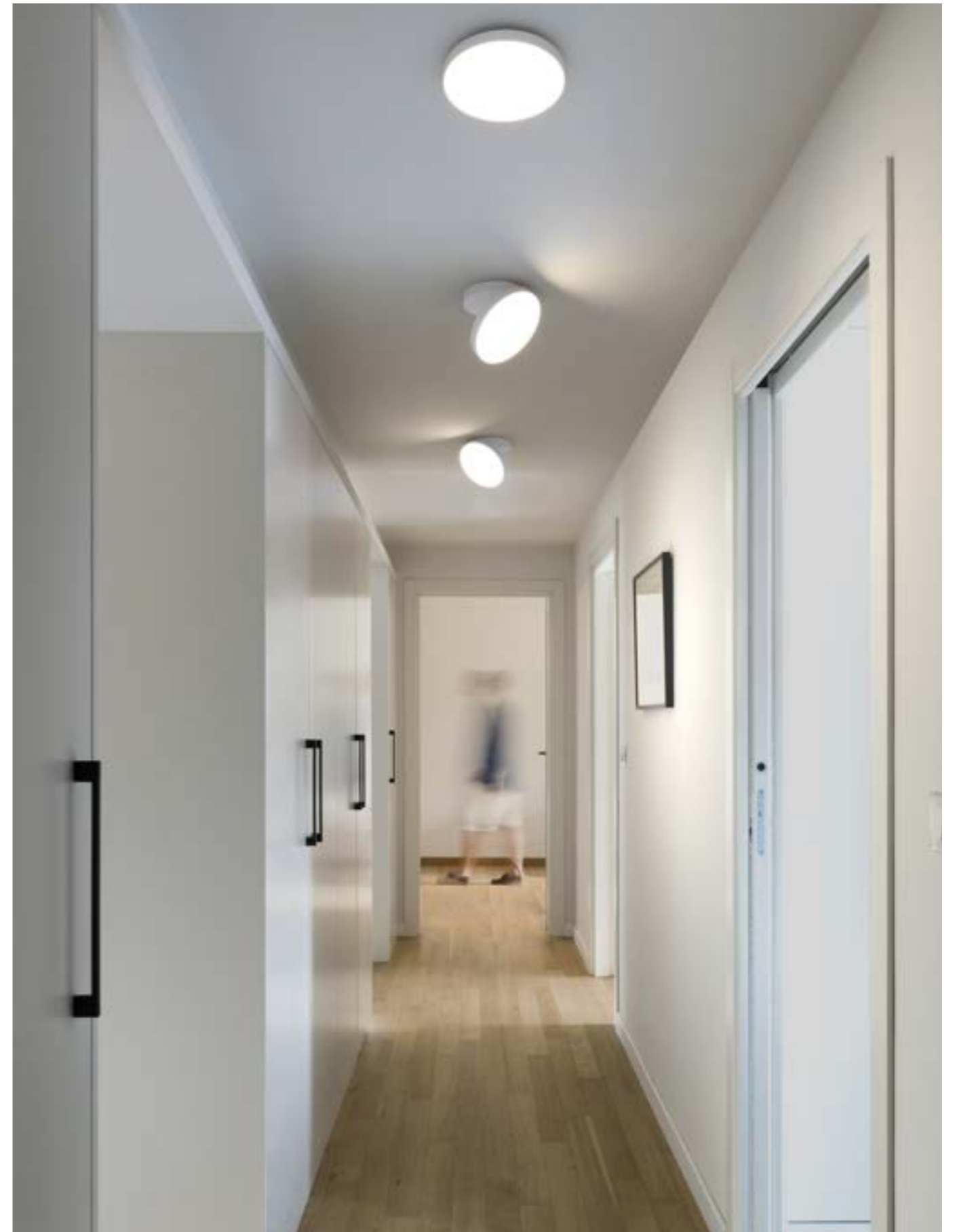

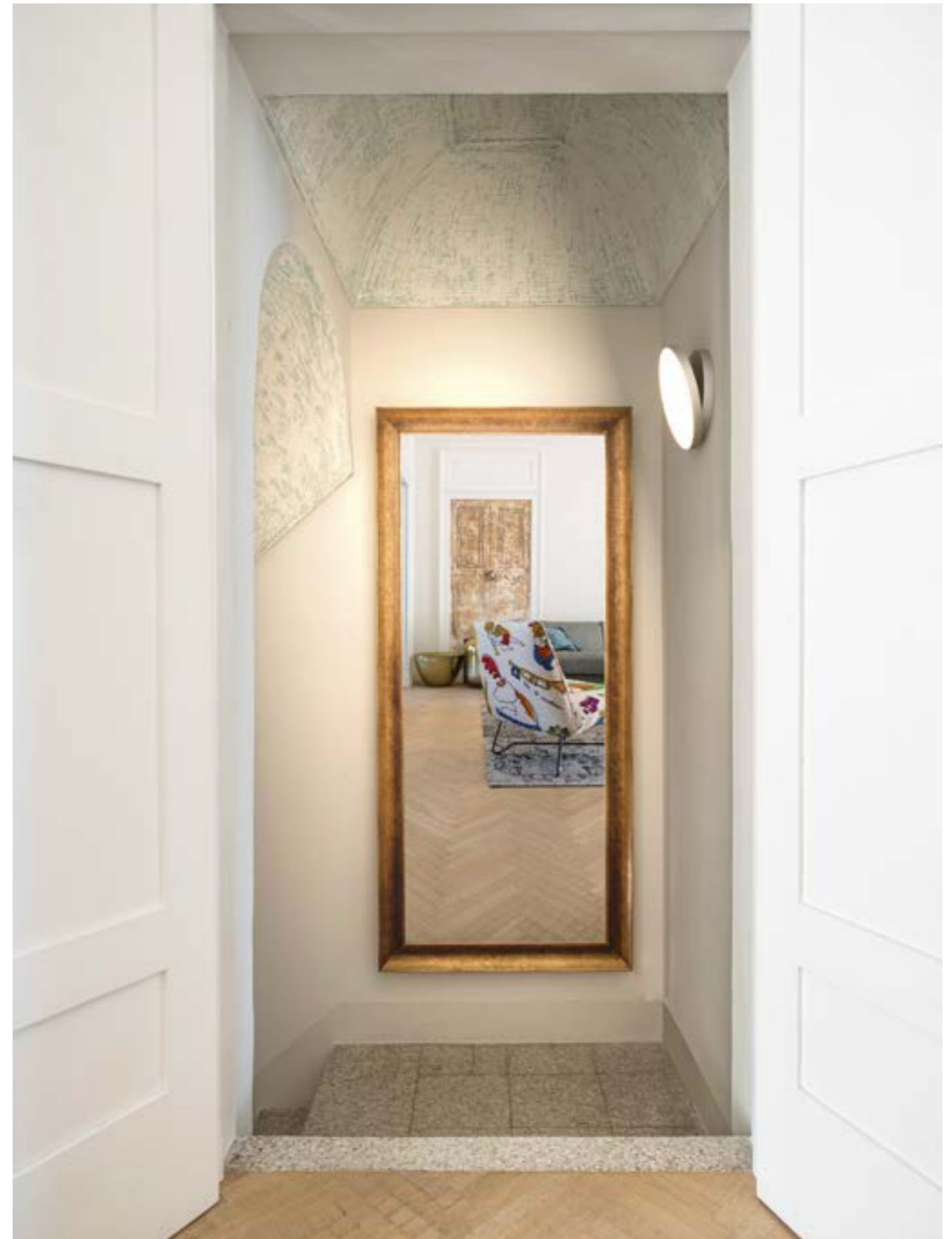



262

# Venere



Venere: Ceiling-Wall

cod: W1

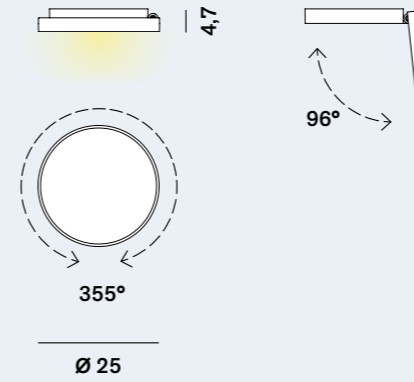

Light Source	MID POWER LED
Power	25 Watt
Kelvin	2.700, 3.000
Dimmer	push, dali
Lumen	2.100
CRI	90

Venere: Ceiling-Wall

cod: W2

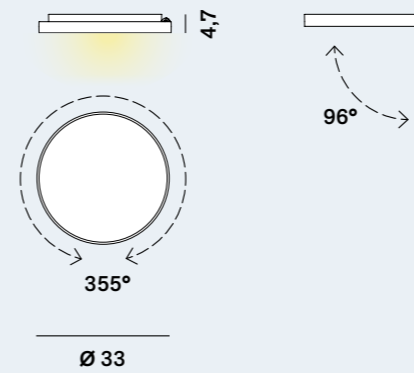

Light Source	MID POWER LED
Power	36 Watt
Kelvin	2.700, 3.000
Dimmer	push, dali
Lumen	3.600
CRI	90

Catalogue

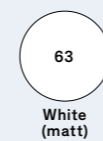

Satin Collection (upon request)



Kerakoll Warm Collection (upon request)



# Rosoni

R.T.D.  
2021

**IT – Tre proposte (una rotonda e due lineari in due differenti misure) per realizzare composizioni di più sospensioni in maniera ordinata ed organizzata. I rosoni multipli di Rotaliana permettono di creare cascate luminose di grande effetto per arricchire gli spazi domestici o commerciali, oppure delle linee di luci per illuminare un grande tavolo da pranzo o lavoro. Una perfetta soluzione tecnica di facile utilizzo studiata per le lampade della nostra collezione e una versione standard utilizzabile anche con altri prodotti.**

EN – Rotaliana's Multi-Port Canopy offer three options, available in Round and two Linear sizes allowing to create custom compositions of multiple suspensions. The Multi-Port R1/R2 and R3 Canopies allow you to create impressive light compositions that compliment and illuminate a variety of Residential, Commercial and Hospitality interiors. An easy to use and install solution designed for our collection of pendant fixtures and can also be used with other products.

DE – Drei Varianten – einmal rund und eine schmale elegante Schiene in zwei Größen – hiermit können verschiedene Anordnungen und wirkungsvolle Kompositionen mit mehreren Pendeln gestaltet werden. Die Baldachine von Rotaliana ermöglichen die Kombination von effektvollen leuchtenden Kaskaden, um Wohn- oder Geschäftsräume einzurichten, oder besondere Lichtlinien, um einen großen Ess- oder Arbeitstisch zu beleuchten. Eine perfekte benutzerfreundliche technische Lösung, angepasst für die Leuchten aus unserer Kollektion, oder auch eine Standardversion für die Verwendung von anderen Produkten.

FR – Trois propositions (une ronde et deux linéaires, de taille différente) pour réaliser des compositions faites de plusieurs suspensions, et ceci de façon ordonnée et organisée. Les rosaces multiples de Rotaliana permettent de créer des cascades lumineuses faisant un bel effet de façon à décorer des espaces privés ou commerciaux, ou bien traçant des lignes de lumière pour éclairer une grande table de salle à manger ou table de travail. Une solution technique parfaite pour un emploi facile, étudiée pour les lampes de notre collection, mais comprenant également une version standard à utiliser avec d'autres articles.

ES – Tres propuestas (una redonda y dos lineales en dos diferentes tamaños) para realizar composiciones compuestas por varias suspensiones de forma ordenada y organizada. Los florones múltiples de Rotaliana permiten crear cascadas luminosas de gran efecto para enriquecer el espacio doméstico o comercial, o bien líneas de luces para iluminar una gran mesa de comedor o de trabajo. Una perfecta solución técnica fácil de usar, diseñada para las lámparas de nuestra colección y una versión estándar utilizable también con otros productos.











## Rosoni / Canopies



Design  
R.T.D.

Year  
21

Category: Accessories ↗

Rosoni / Canopies: Accessories

cod: R1

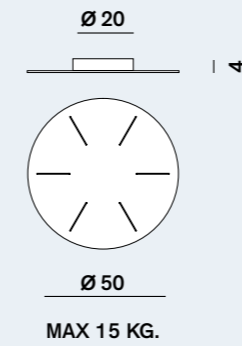

DRINK H1	min. 1 max. 6
DRY H3	min. 1 max. 6
FLOW GLASS H1-H2	min. 1 max. 3
GOCCIA H1-H2	min. 1 max. 6
LUXY H5	min. 1 max. 6
POMI H1-H2-H3	min. 1 max. 3
DINA H1	3 - 6
SQUIGGLE H6	3 - 6
SQUIGGLE H1-H2-H3	3
FURIN	3 - 6

Rosoni / Canopies: Accessories

cod: R2

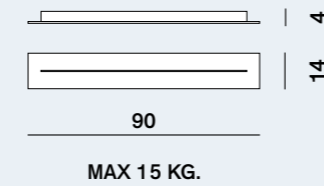

DRINK H1	min. 1 max. 3
DRY H3	min. 1 max. 3
FLOW GLASS H1-H2	min. 1 max. 3
GOCCIA H1-H2	min. 1 max. 3
LUXY H5	min. 1 max. 3
POMI H1-H2-H3	min. 1 max. 3
DINA H1	3
SQUIGGLE H6	3
FURIN	3

Rosoni / Canopies: Accessories

cod: R3

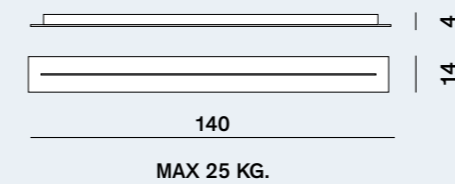

DRINK H1	min. 1 max. 6
DRY H3	min. 1 max. 6
FLOW GLASS H1-H2	min. 1 max. 3
GOCCIA H1-H2	min. 1 max. 6
LUXY H5	min. 1 max. 6
POMI H1-H2-H3	min. 1 max. 5
DINA H1	3 - 6
SQUIGGLE H6	min. 1 max. 6
FURIN	min. 1 max. 12

Catalogue



Satin Collection (upon request)



Warm Collection (upon request)



## Finiture / Finishing

## Satin Collection

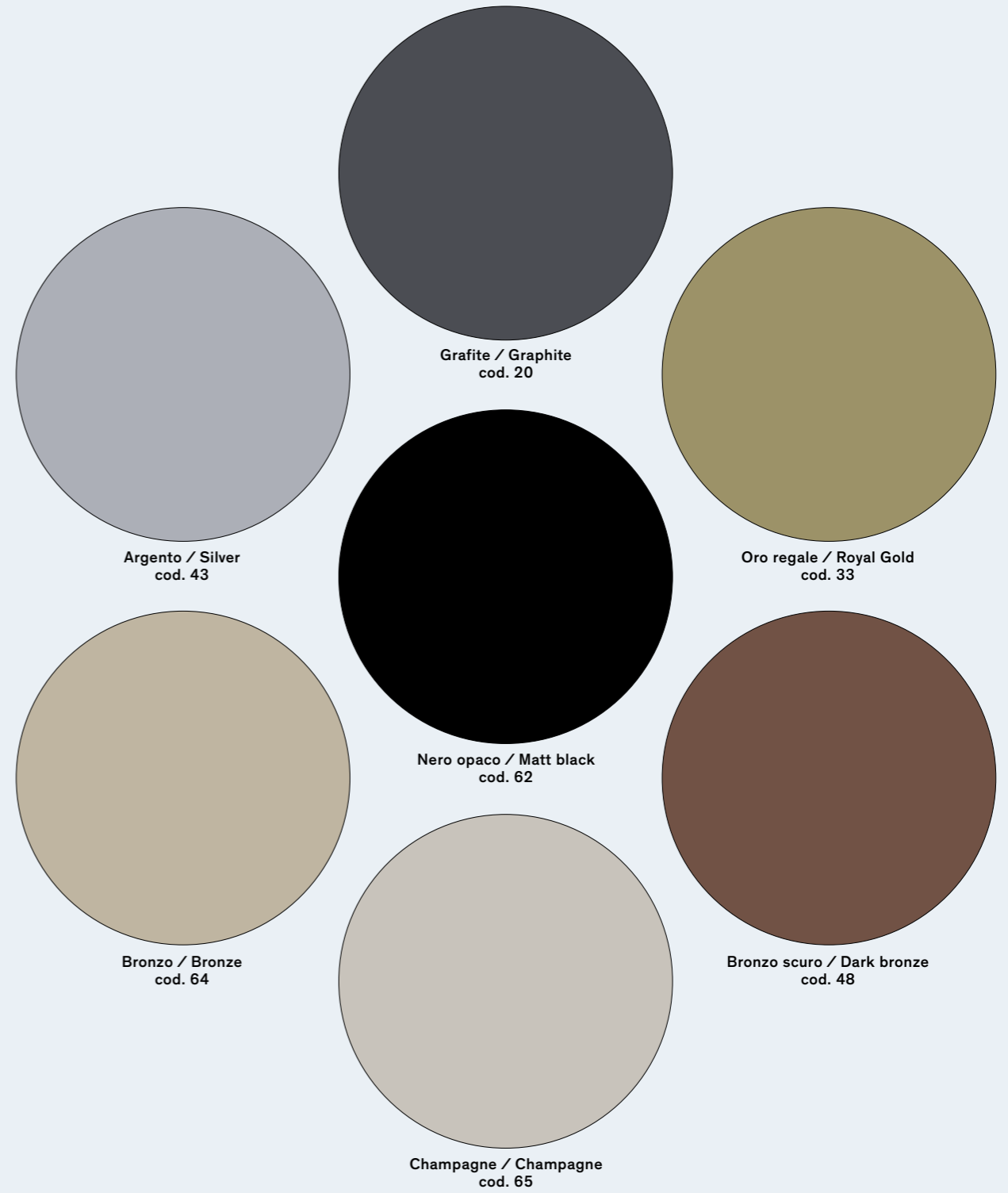

## Metallic Collection

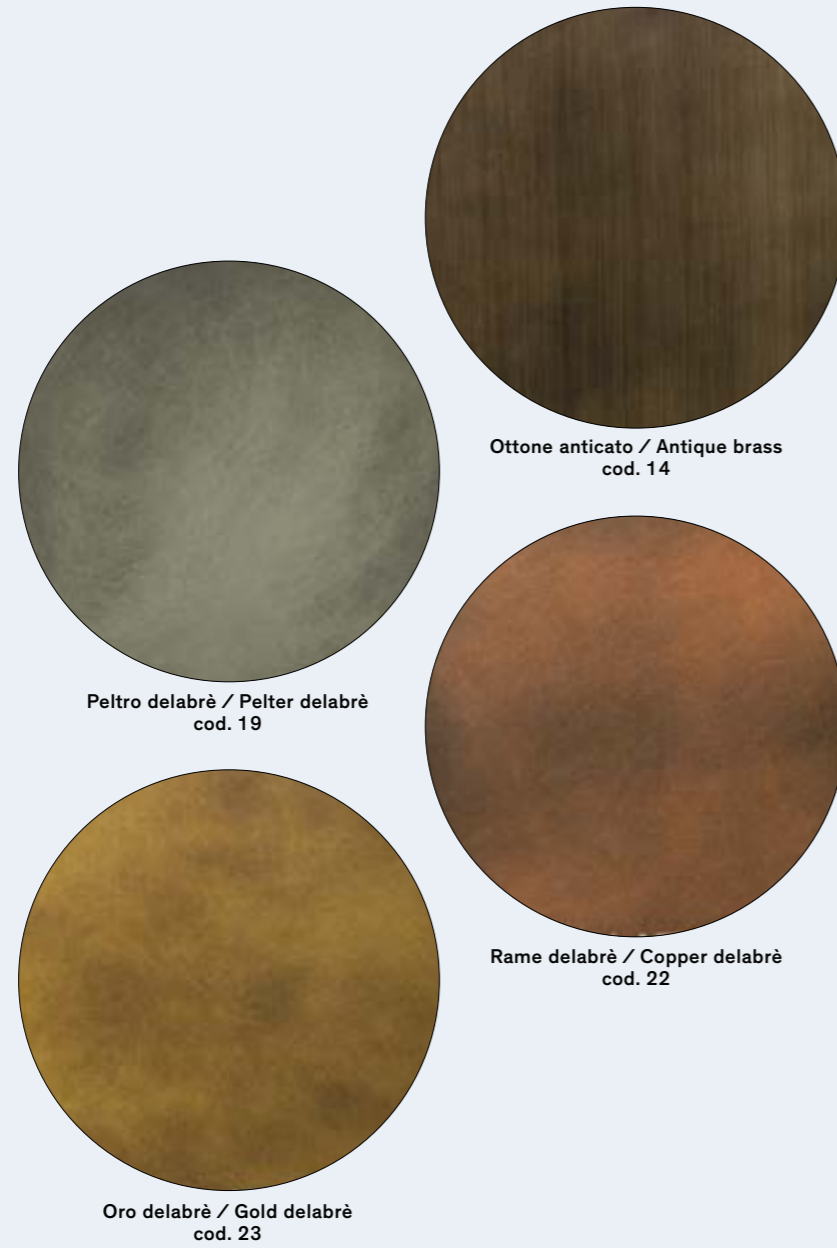

## Kerakoll Warm Collection

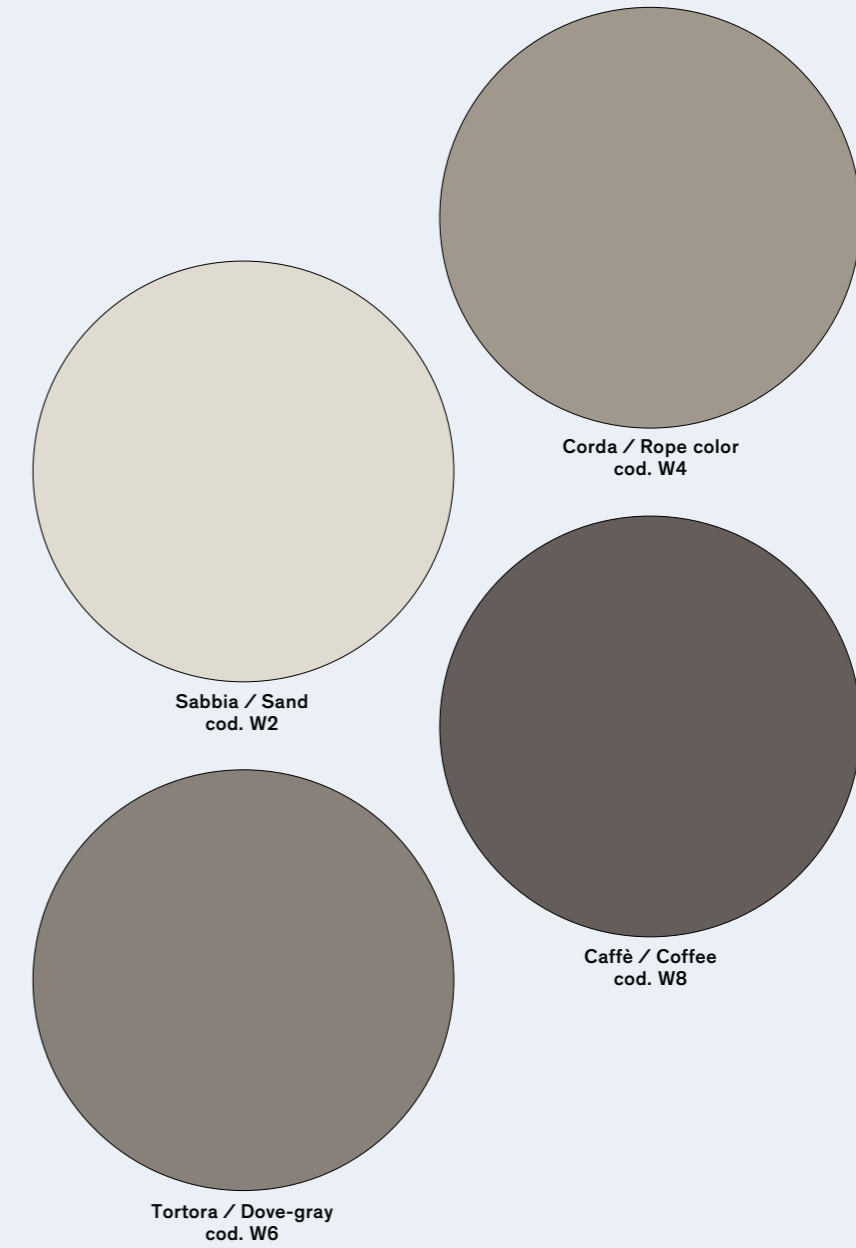

**The Collection:**  
**Belvedere, Chiardiluna,**  
**Ciminiere d'Italia, CM2, Collide,**  
**Dina, Dina+, Dresscode, Drink, Dry,**  
**Eden Collection, Febo, Flow Glass,**  
**Frame, Furin, Goccia, InOut, Ipe, Lightwire,**  
**Luxy, MultiPot+, Overlap, Pomi,**  
**Prince, QB, Squiggle, String,**  
**Sunset, Tick, Tide,**  
**Tobu, Venere.**

# Wall

Belvedere / pag. 20

W1

W2

CM2 / pag. 42

W1

W2

Collide / pag. 48

H0

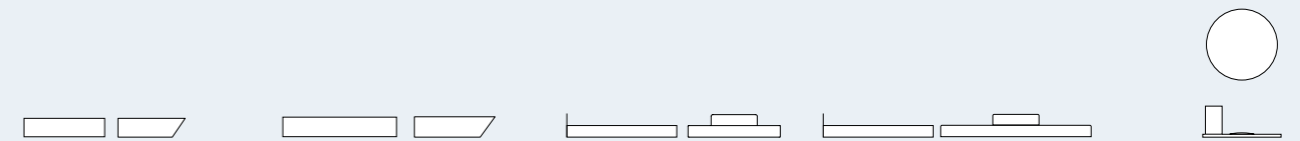

Dresscode / pag. 66

H1

H2

H3

W1

W2

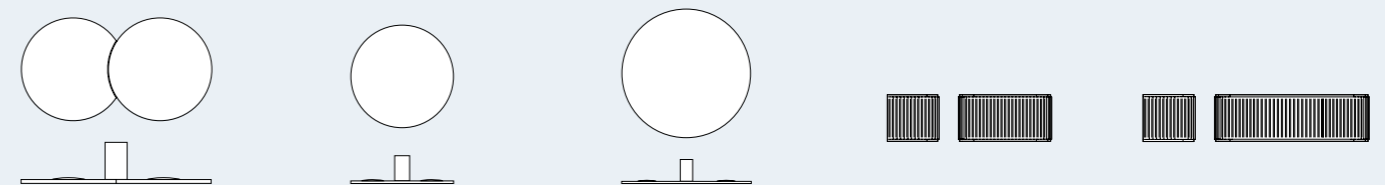

Frame / pag. 106

W1

W2

W3

W4

InOut / pag. 126

W1



lpe / pag. 132

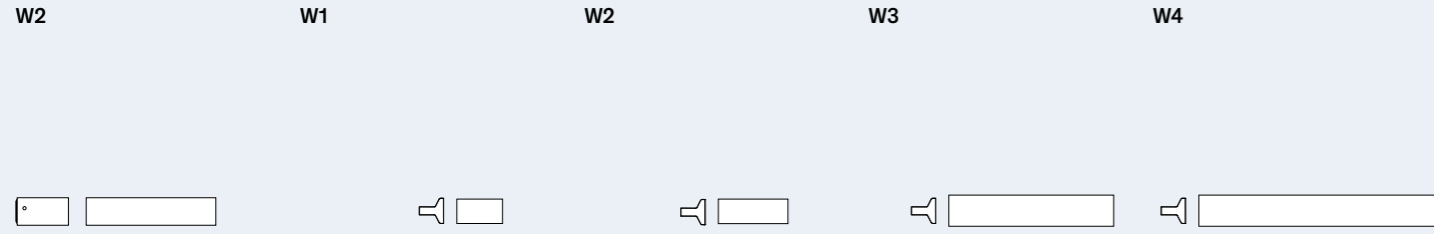

Luxy / pag. 144

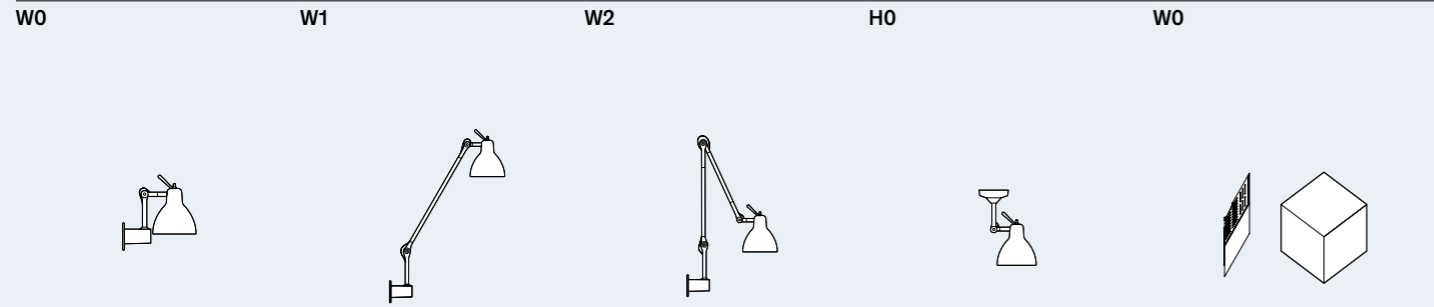

String / pag. 212

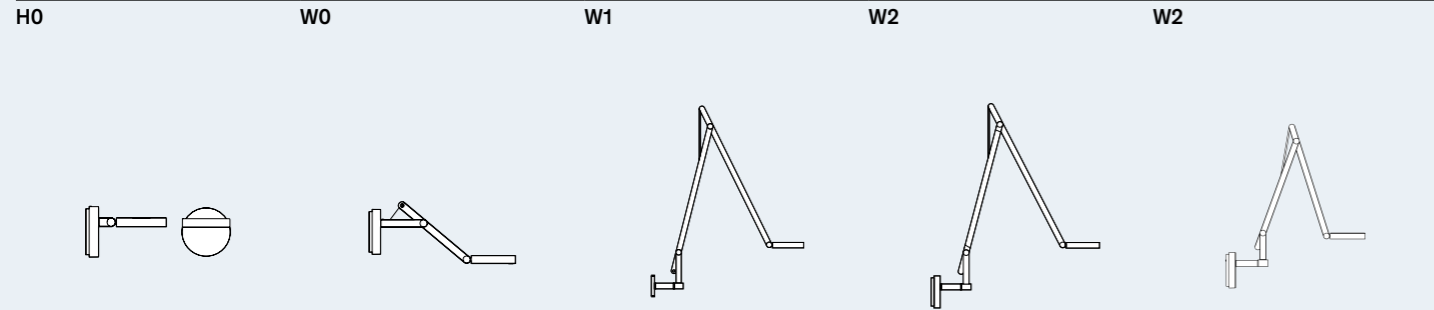

Sunset / pag. 232

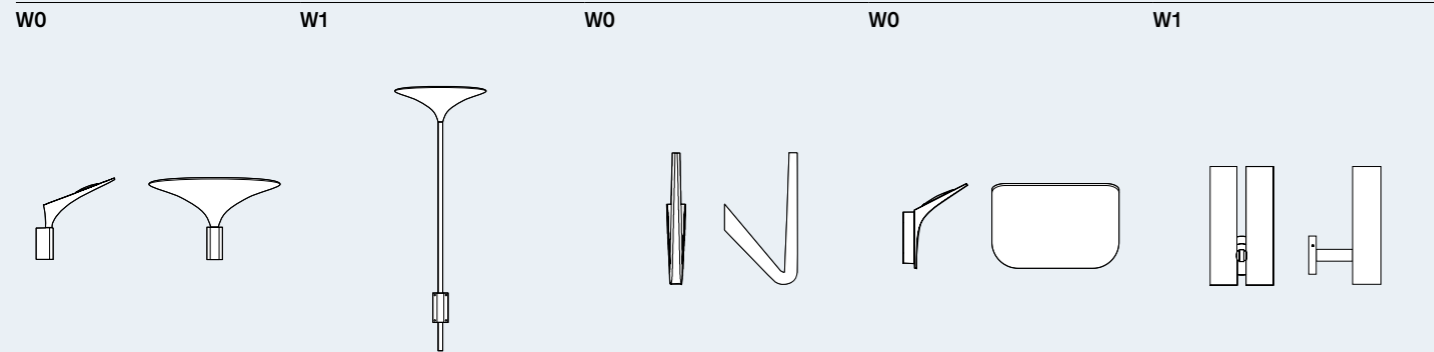

Venere / pag. 254

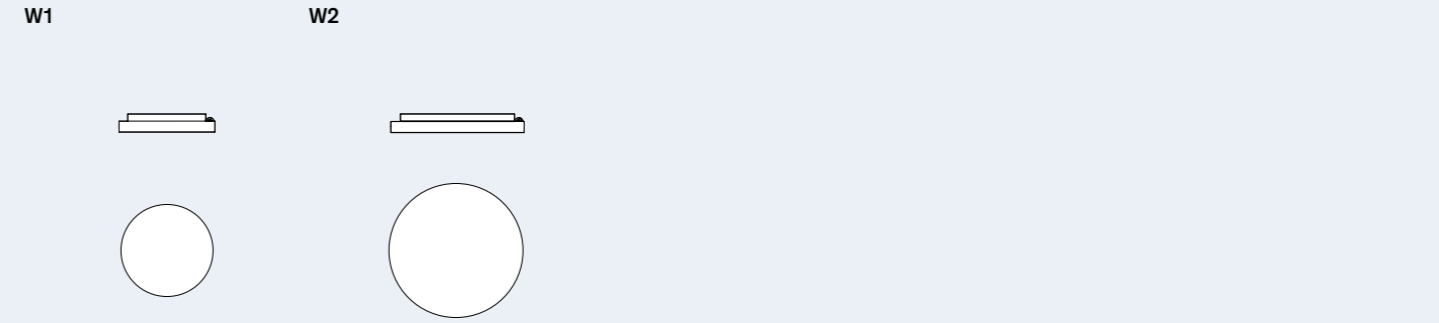

# Suspension

Dina / pag. 54

H1



Drink / pag. 72

H1



H3

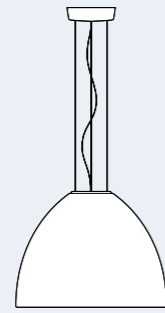

Dry / pag. 78

H1

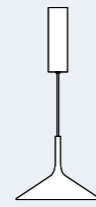

H2

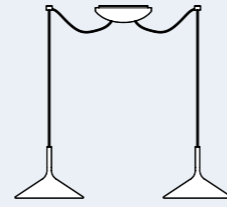

H3



H4

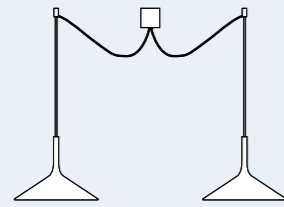

Febo / pag. 94

H1

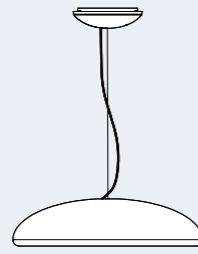

Flow Glass / pag. 100

H1

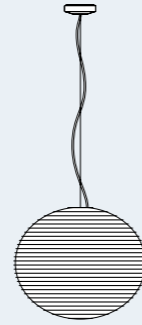

H2



Furin / pag. 114

H1



Goccia / pag. 120

H1



H2

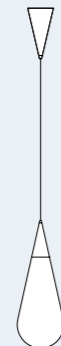

Abaco

Luxy / Luxy Glam / pag. 144

H5



Overlap / pag. 170

H1

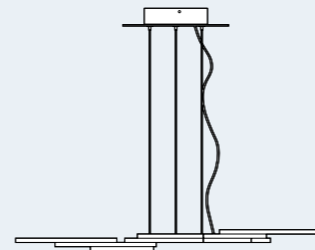

Pomi / pag. 176

H1



H2



H3



Squiggle / pag. 190

H1

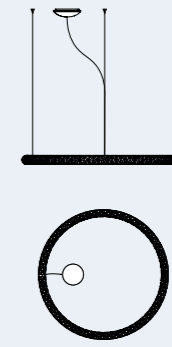

H2

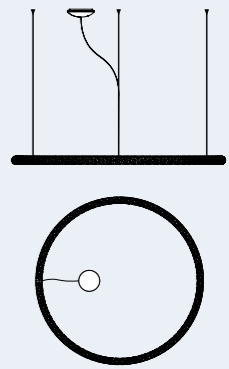

H3

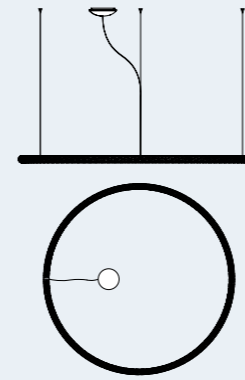

H4

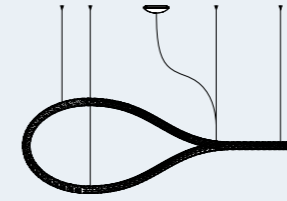

H5

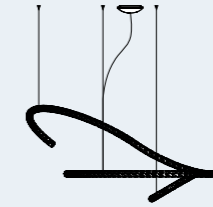

H6



H8

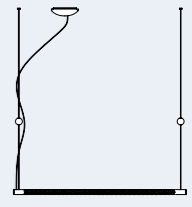

H9

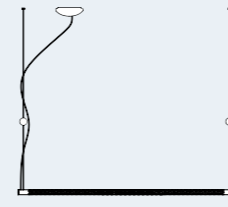

H10

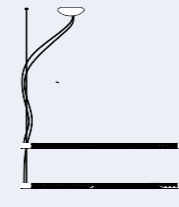

H11

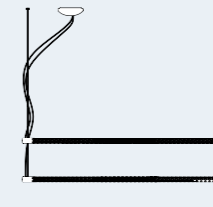

H12

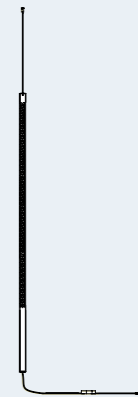

Abaco

# Floor

Ciminiere d'Italia / pag. 36

F1



F2

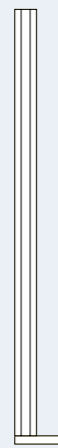

F3



Drink / pag. 72

F1



Dry / pag. 78

F1



Lightwire / pag. 140

F1



Luxy / pag. 144

F1



Luxy Glam / pag. 154

F0



Prince / pag. 182

F1



Squiggle / pag. 190

F1

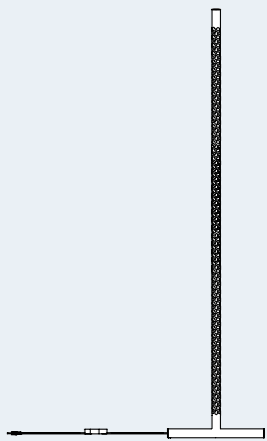

Eden Collection / pag. 84

F1

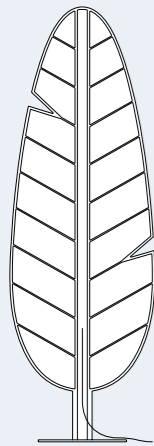

F2

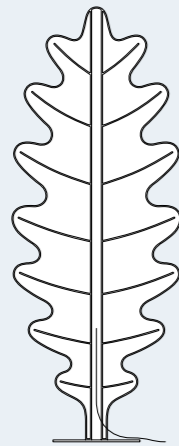

F3

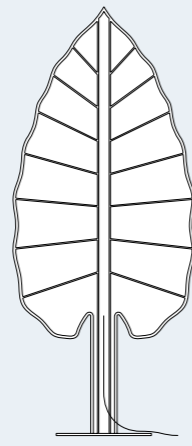

Flow Glass / pag. 100

F1



F2



String / pag. 212

F1

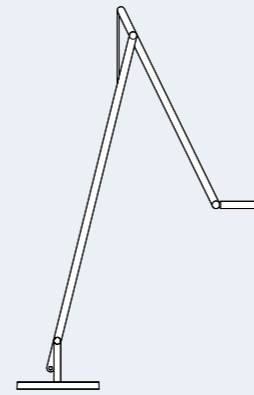

String / pag. 228

XL

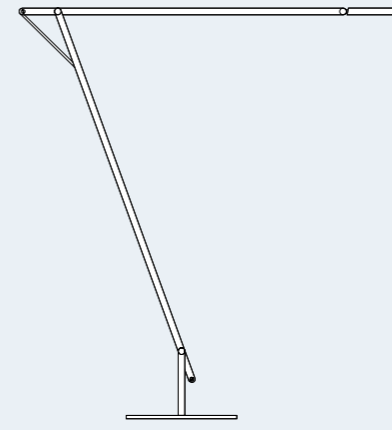

Sunset / pag. 232

F1



Tobu / pag. 244

F1

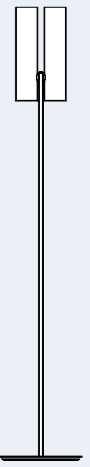

# Table

Chiardiluna / pag. 26      Dina / Dina+ / pag. 50      Flow Glass / pag. 100  
 T1                                  T1                                  T2                                  T3                                  T4

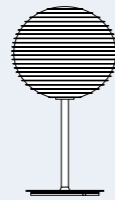

Luxy / pag. 144                                  Luxy Glam / pag. 154      MultiPot+ / pag. 162      String / pag. 212  
 T1                                  T2                                  T0                                  T1

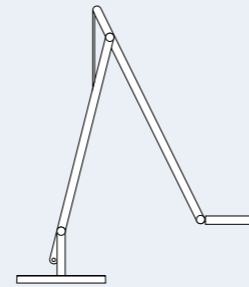
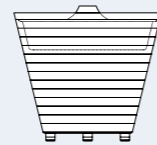
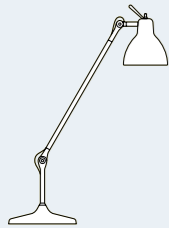

String mini / pag. 220  
 T1

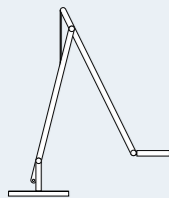

# Ceiling

Collide / pag. 48                                  Luxy / pag. 144  
 H0                                  H1                                  H2                                  H3                                  H0

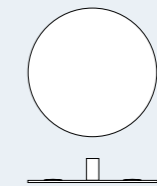
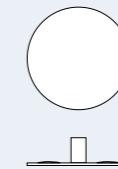
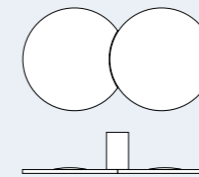

Flow Glass / pag. 100                                  String / pag. 212      Tick / pag. 236  
 H1                                  H3                                  H4                                  H0                                  WO

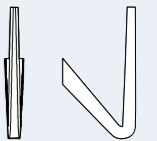
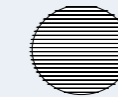
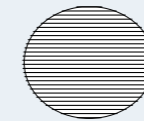

Venere / pag. 254  
 W1                                  W2

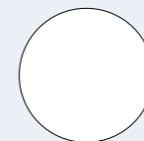
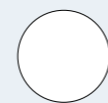



# Credits

All right reserved.  
No part of this publication may be reproduced, stored in a retrieval system or transmitted, in any form or by any means, electronic, mechanical, photocopying, recording or otherwise, without the prior permission of Rotaliana.

Rotaliana reserves the right to introduce any changes to its own models, without prior notice.

Photography  
 ↳ Rotaliana  
 ↳ Carlo Baroni  
 ↳ Emilio Tremolada

Text  
 ↳ Rotaliana

Printing  
 ↳ Saturnia Trento

Year 2022

digital version

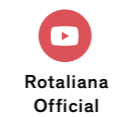

Rotaliana srl  
via Trento 115-117  
38017 Mezzolombardo  
Trento, Italia

T. +39 0461 60 23 76  
info@rotaliana.it  
www.rotaliana.it



