

COLORI



A alluminio/aluminium



AN antracite/anthracite



BI bianco/white



BL bianco lucido/glossy white



FA foglia argento/silver leaf



FO foglia oro/gold leaf



FR foglia rame/copper leaf



G grigio/grey



NE nero/black



NL nero lucido/glossy black



OB old brown



OS oro silver/gold silver



PA polvere argento/silver powder



PO polvere oro/gold powder



PE bianco perla/pearl white



PT peltro/pewter



R rosso/red



RU ruggine/rust



TO titanio/titanium



V verde/green



AS alluminio satinato/brushed aluminium



BS bronzo spazzolato/brushed bronze



CR cromo/chrome



FS ferro spazzolato/brushed iron



OR oro opaco/brushed gold



OT ottone satinato/satin brass



RA rame/copper



RB rame bronzato/bronzed copper



AE argento etrusco/etruscan silver



AR ardesia/slate



BE bianco etrusco/etruscan white



EC ecru/ecru



OE oro etrusco/etruscan gold



RE rame etrusco/etruscan copper

VETRI/GLASS



CO cristallo/crystal



FE fumè/smoked



RO rosa/pink



8MM
PAG. 332



ALBATROS
PAG. 104



ARBOR
PAG. 348



BOOMERANG
PAG. 328



CANALETTO
PAG. 190



CAVEAU
PAG. 88



CIDI
PAG. 390



CONFORT
PAG. 290



CORNICE
PAG. 160

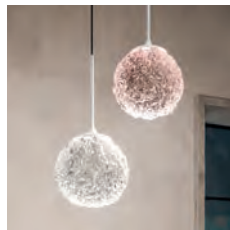

CRISTALGLOB
PAG. 168

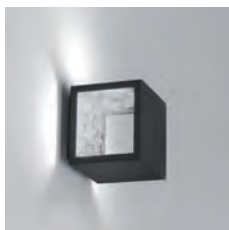

CUBÒ
PAG. 262



DA DO
PAG. 374



DARMA
PAG. 268



DIADEMA
PAG. 250



DUETTO
PAG. 212



EMISFERO
PAG. 182



ESSENZA
PAG. 38



GIÙUP
PAG. 240

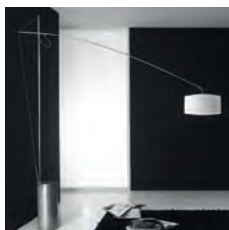

GRU
PAG. 196

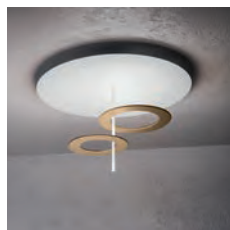

HULA HOOP
PAG. 56



ISI
PAG. 318



KONE
PAG. 278

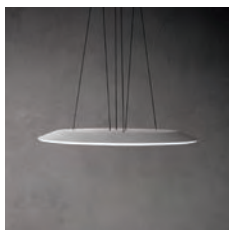

LADY B
PAG. 258



LAMA
PAG. 6

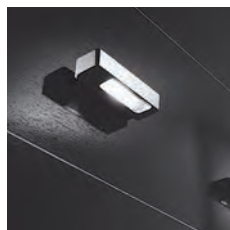

LINGOTTO
PAG. 340

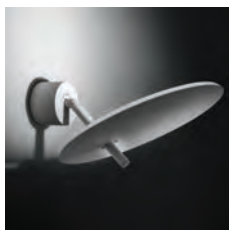

LUÀ
PAG. 220

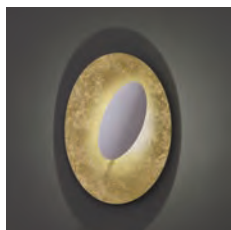

MASAI
PAG. 20



MIX
PAG. 398



NIDO
PAG. 418



OLIMPIA
PAG. 206



ORIZZONTE
PAG. 112

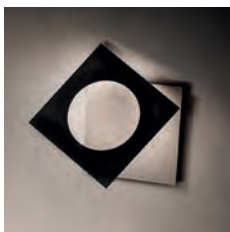

PETRA
PAG. 66

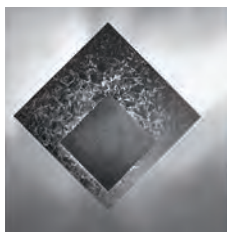

PIASTRA
PAG. 404

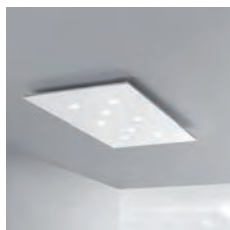

POP
PAG. 304



REVERSE
PAG. 200



RING
PAG. 324



RUBIC
PAG. 384

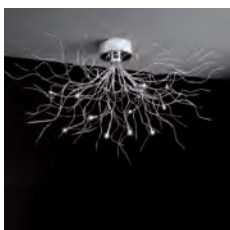

SAGGINA
PAG. 410



SALSOLA
PAG. 426



SCUDO
PAG. 312



SPILLO
PAG. 126



SWING
PAG. 300

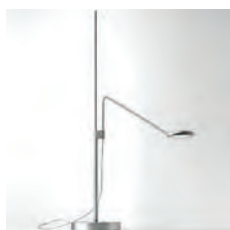

TECLA
PAG. 360



TI
PAG. 344



TRATTO
PAG. 336



VERA
PAG. 46

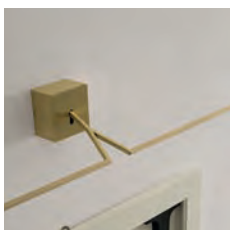

YPSILON
PAG. 118



ZETA
PAG. 122

INDICE





L A M A



LAMA

Giulio Cappellini &
Leonardo Talarico - 2023

Lampada da tavola composta da due sezioni di cono in sottilissima lamina metallica. Terminali in materiale plastico.

Finiture in colori opachi o lucidi
Disponibile anche in temperatura di colore 2700°K
Dimmer cablato.

Table lamp composed by two intersected cones in extra thin metal sheets. Terminal in plastic material.

Painted with brilliant or matt finishings .
Also available in 2700°K LED color temperature
Dimmable cordset.

Modello depositato

Registered design

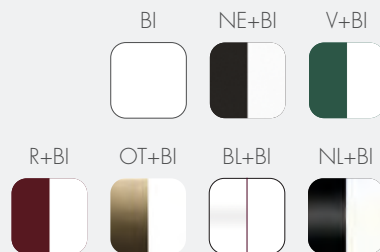

9



Art.	W	V	Lumen	°K led	A cm	B cm	C cm
LAMA LP DIMMERABILE	8	220-240	720	3000	20	10	30

LED disponibili a richiesta nella temperatura colore 2700 °K







LAMA

Giulio Cappellini &
Leonardo Talarico - 2023

Lampada da terra composta da due sezioni di cono in sottilissima lamina metallica. Terminali in materiale plastico.

Finiture in colori opachi o lucidi
Disponibile anche in temperatura di colore 2700°K
Dimmer cablato.

Floor lamp composed by two intersected cones in extra thin metal sheet. Terminal in plastic material.

Painted with brilliant or matt finishings .
Also available in 2700°K LED color temperature
Dimmable cordset.

Modello depositato

Registered design



13



Art.	W	V	Lumen	°K led	A cm	B cm	C cm
LAMA LG DIMMERABILE	20	220-240	1960	3000	40	20	60

LED disponibili a richiesta nella temperatura colore 2700 °K



LAMA

Giulio Cappellini &
Leonardo Talarico - 2023

Lampada da terra composta da due sezioni di cono in sottilissima lamina metallica. Terminali in materiale plastico.

Finiture in colori opachi o lucidi
Disponibile anche in temperatura di colore 2700°K
Dimmer cablato.

Floor lamp composed by two intersected cones in extra thin metal sheet. Terminal in plastic material.

Painted with brilliant or matt finishings .
Also available in 2700°K LED color temperature
Dimmable cordset.

Modello depositato

Registered design



15



Art.	W	V	Lumen	°K led	A cm	B cm	C cm
LAMA ST DIMMERABILE	22	220-240	3400	3000	40	20	185

LED disponibili a richiesta nella temperatura colore 2700 °K







LAMA

Giulio Cappellini &
Leonardo Talarico - 2023

Lampada da soffitto composta da due sezioni di cono in sottilissima lamina metallica. Terminali in materiale plastico.

Finiture in colori opachi o lucidi
Disponibile anche in temperatura di colore 2700°K

Ceiling lamp composed by two intersected cones in extra thin metal sheet. Terminal in plastic material.

Painted with brilliant or matt finishings .
Also available in 2700°K LED color temperature

Modello depositato

Registered design



19



Art.	W	V	Lumen	°K led	A cm	B cm	C cm
LAMA P	8	220-240	720	3000	20	10	30

LED disponibili a richiesta nella temperatura colore 2700 °K





M A S A I



MASAI

Marco Pagnoncelli - 2022

Lampada da terra in alluminio curvato sul quale viene proiettata la luce da un proiettore in alluminio pressofuso ovale. Illuminazione a led ad alta efficienza a luce indiretta.

Disponibile anche in temperatura di colore 2700°K

Dimmer cablato incluso

Modello depositato

Curved aluminium floor lamp; light emission by a projector in oval die cast aluminium. High efficiency LED for indirect lighting.

Also available in 2700°K LED color temperature

Dimmable cordset included

Registered design

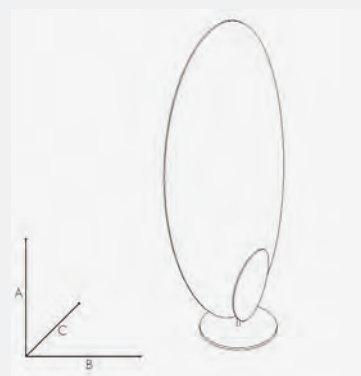
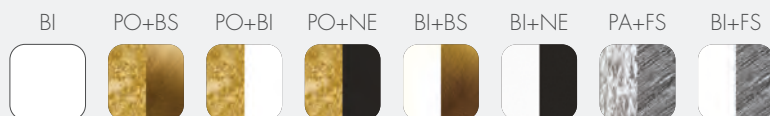

Art.	W	V	Lumen	°K led	A cm	B cm	C cm
MASAI ST 20	20	220-240	1960	3000	138	64	30
MASAI ST 53	40	220-240	3920	3000	138	64	30

DIMMERABILI

LED disponibili a richiesta nella temperatura colore 2700 °K



MASAI

Marco Pagnoncelli - 2022

Lampada da tavolo in alluminio curvato sul quale viene proiettata la luce da un proiettore in alluminio pressofuso ovale. Illuminazione a led ad alta efficienza a luce indiretta.

Disponibile anche in temperatura di colore 2700°K

Dimmer cablato incluso

Modello depositato

Curved aluminium table lamp; light emission by a projector in oval die cast aluminium. High efficiency LED for indirect lighting.

Also available in 2700°K LED color temperature

Dimmable cordset included

Registered design

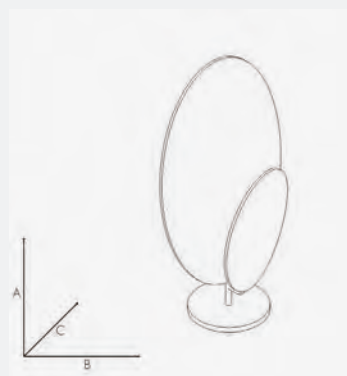

Art.	W	V	Lumen	°K led	A cm	B cm	C cm
MASAI LP	15	220-240	1440	3000	49	28	14
MASAI LG	20	220-240	1960	3000	74	44	20

DIMMERABILI

LED disponibili a richiesta nella temperatura colore 2700 °K



MASAI

Marco Pagnoncelli - 2022

Sospensione in alluminio curvato sul quale viene proiettata la luce da due proiettori in alluminio pressofuso ovale. Illuminazione a led ad alta efficienza a luce indiretta.

Disponibile anche in temperatura di colore 2700°K

Dimmerabile con sistema TRIAC

Modello depositato

Curved aluminium suspension lamp; light emission by two projectors in oval die cast aluminium. High efficiency LED for indirect lighting.

Also available in 2700°K LED color temperature

Dimmable with TRIAC system

Registered design

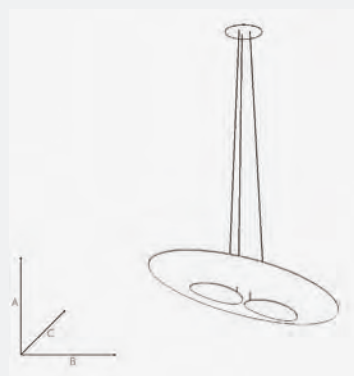
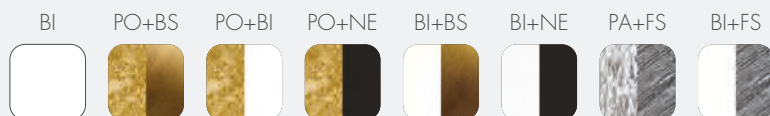

Art.	W	V	Lumen	°K led	A cm	B cm	C cm
MASAI 90 S	45	220-240	4320	3000	200	90	50
MASAI 130 S	60	220-240	5880	3000	200	130	64

DIMMERABILE TRIAC

LED disponibili a richiesta nella temperatura colore 2700 °K



MASAI

Marco Pagnoncelli - 2022

Lampada da parete/soffitto in alluminio curvato sul quale viene proiettata la luce da un proiettore in alluminio pressofuso ovale. Illuminazione a led ad alta efficienza a luce indiretta.

Disponibile anche in temperatura di colore 2700°K

Dimmerabile con sistema TRIAC

Modello depositato

Curved aluminium lamp for wall or ceiling mounting; light emission by a projector in oval die cast aluminium. High efficiency LED for indirect lighting. Tilttable diffuser

Also available in 2700°K LED color temperature

Dimmable with TRIAC system

Registered design

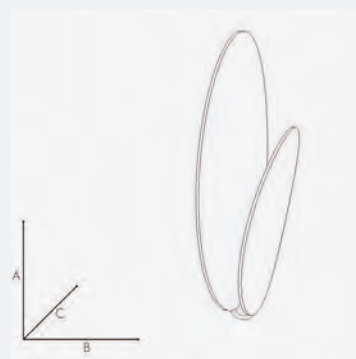
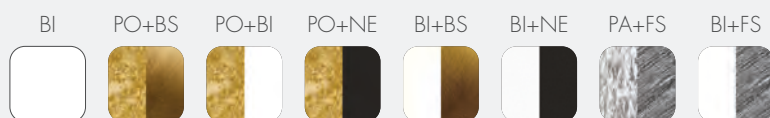

Art.	W	V	Lumen	°K led	A cm	B cm	C cm
MASAI 50	15	220-240	1440	3000	50	36	14
MASAI 70	20	220-240	1960	3000	70	44	16

DIMMERABILE TRIAC

LED disponibili a richiesta nella temperatura colore 2700 °K



MASAI

Marco Pagnoncelli - 2022

Lampada da soffitto in alluminio curvato sul quale viene proiettata la luce da due proiettori in alluminio pressofuso ovale. Illuminazione a led ad alta efficienza a luce indiretta.

Disponibile anche in temperatura di colore 2700°K

Dimmerabile con sistema TRIAC

Modello depositato

Curved aluminium lamp for ceiling mounting; light emission by a projector in oval die cast aluminium. High efficiency LED for indirect lighting.

Also available in 2700°K LED color temperature

Dimmable with TRIAC system

Registered design

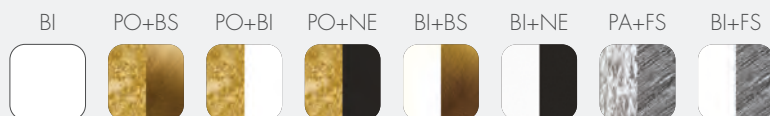

Art.	W	V	Lumen	°K led	A cm	B cm	C cm
MASAI 90 DIMMERABILE TRIAC	40	220-240	3920	3000	90	60	18

LED disponibili a richiesta nella temperatura colore 2700 °K



MASAI

Marco Pagnoncelli - 2022

Lampada da parete in alluminio curvato sul quale viene proiettata la luce da un proiettore in alluminio pressofuso ovale. Illuminazione a led ad alta efficienza a luce indiretta.

Curved aluminium lamp for wall mounting; light emission by a projector in oval die cast aluminium. High efficiency LED for indirect lighting.

Riflettore orientabile e diffusore ruotabile

Adjustable reflector, titable diffuser

Also available in 2700°K LED color temperature

Disponibile anche in temperatura di colore 2700°K

Dimmable with TRIAC system

Dimmerabile con sistema TRIAC

Modello depositato

Registered design

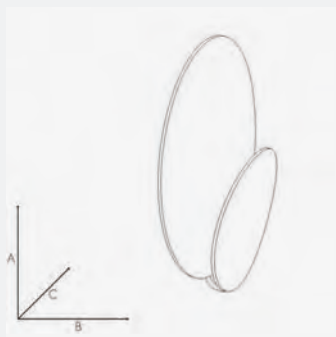
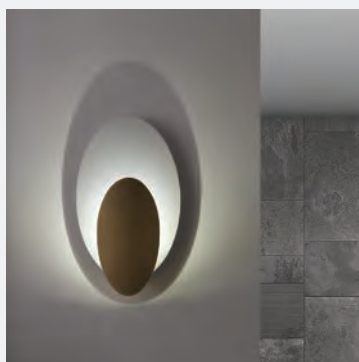

Art.	W	V	Lumen	°K led	A cm	B cm	C cm
MASAI AP 20	20	220-240	1960	3000	50	28	18
MASAI AP 15	15	220-240	1440	3000	38	22	16

DIMMERABILE TRIAC

LED disponibili a richiesta nella temperatura colore 2700 °K



MASAI

Marco Pagnoncelli - 2022

Lampada da parete in alluminio curvato sul quale viene proiettata la luce da un proiettore in alluminio pressofuso ovale. Illuminazione a led ad alta efficienza a luce indiretta.

Disponibile anche in temperatura di colore 2700°K

Dimmerabile con sistema TRIAC

Modello depositato

Curved aluminium lamp for wall mounting; light emission by a projector in oval die cast aluminium. High efficiency LED for indirect lighting.

Also available in 2700°K LED color temperature

Dimmable with TRIAC system

Registered design

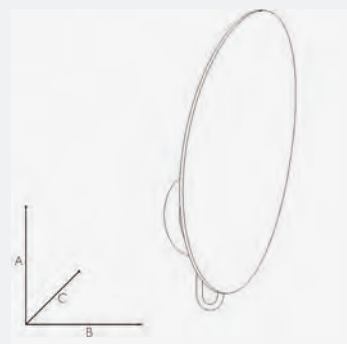

Art.	W	V	Lumen	°K led	A cm	B cm	C cm
MASAI AP P	15	220-240	1440	3000	25	14	13
MASAI AP G	20	220-240	1960	3000	36	18	18

DIMMERABILE TRIAC

LED disponibili a richiesta nella temperatura colore 2700 °K

terra



F5 Ferro Spazzolato / brushed iron



BS Bronzo Spazzolato / brushed bronze



BI Bianco / white



NE Nero / black

MASAI

Marco Pagnoncelli - 2022

Lampada da terra in alluminio curvato sul quale viene proiettata la luce da tre proiettori in alluminio pressofuso ovale. Illuminazione a led ad alta efficienza a luce indiretta.

Disponibile anche in temperatura di colore 2700°K

Dimmer cablato incluso

Modello depositato

Curved aluminium floor lamp; light emission by 3 projectors in oval die cast aluminium. High efficiency LED for indirect lighting.

Also available in 2700°K LED color temperature

Dimmable cordset included

Registered design

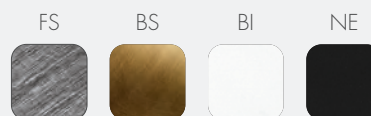
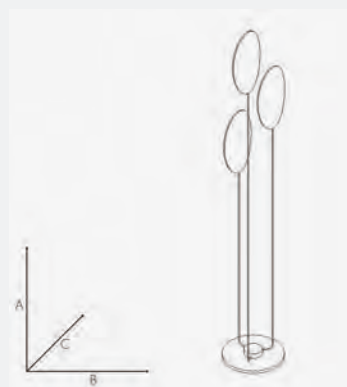

Art.	W	V	Lumen	°K led	A cm	B cm	C cm
MASAI ST 45 DIMMERABILE	45	220-240	4320	3000	183	30	30

LED disponibili a richiesta nella temperatura colore 2700 °K



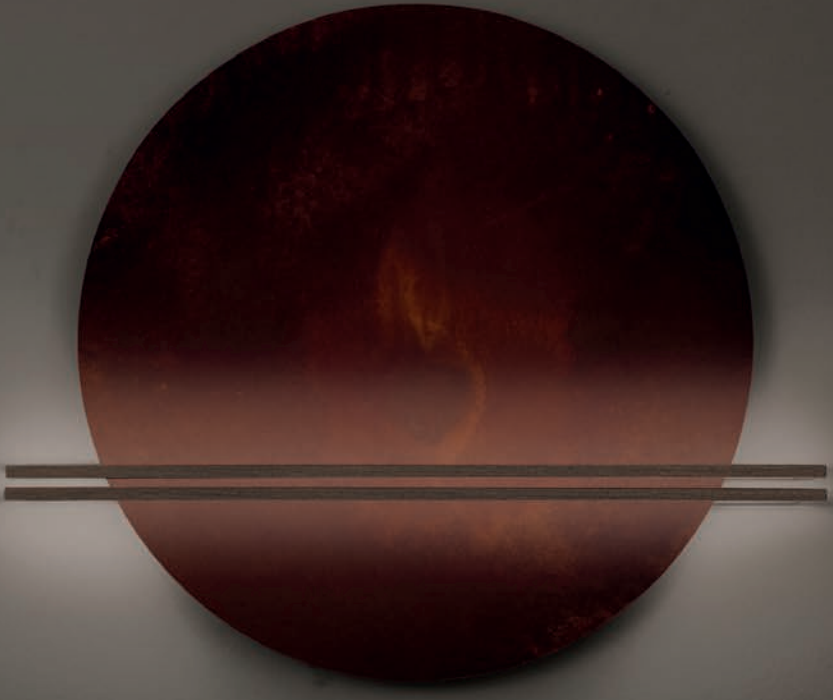

ESSENZA



40

parete

ESSENZA

Marco Pagnoncelli - 2022

Collezione a luce indiretta realizzata da un disco riflettente in alluminio di diverse finiture sul quale viene proiettata la luce proveniente da due profili di sezione quadrata 7x7 millimetri. Illuminazione a led ad alta efficienza

Adatta per montaggio a parete o soffitto

Disponibile anche in temperatura di colore 2700°K

Alimentatore dimmerabile TRIAC incluso

Modello depositato

A collection of luminaires for indirect lighting made by a round shaped aluminium reflector with different finishings, on which light is emitted by 2 profiles with squared section, 7,7mm thick. The profiles can be mounted in centered or decentered position. Suitable for wall or ceiling mounting. High emission LEDs.

Also available in 2700°K LED color temperature

TRIAC dimmable driver included

Registered design

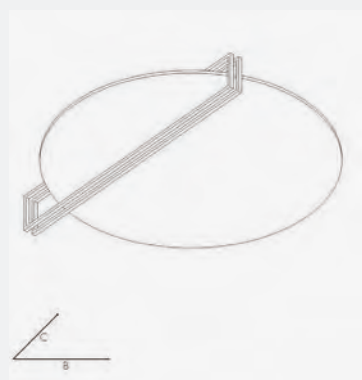

Art.	W	V	Lumen	°K led	B cm	C cm
ESSENZA 90 D	35	220-240	4004	3000	90	13,5
ESSENZA 70 D	25	220-240	3080	3000	70	13,5
ESSENZA 47 D	17	220-240	2152	3000	47	11
ESSENZA 30 D	11	220-240	1232	3000	30	9,5

DIMMERABILE TRIAC

LED disponibili a richiesta nella temperatura colore 2700 °K



ESSENZA

Marco Pagnoncelli - 2022

Collezione a luce indiretta realizzata da un disco riflettente in alluminio di diverse finiture sul quale viene proiettata la luce proveniente da due profili di sezione quadrata 7x7 millimetri. Illuminazione a led ad alta efficienza

Adatta per montaggio a parete o soffitto

Disponibile anche in temperatura di colore 2700°K

Alimentatore dimmerabile TRIAC incluso

Modello depositato

A collection of luminaires for indirect lighting made by a round shaped aluminium reflector with different finishings, on which light is emitted by 2 profiles with squared section, 7,7mm thick. The profiles can be mounted in centered or decentered position. Suitable for wall or ceiling mounting. High emission LEDs.

Also available in 2700°K LED color temperature

TRIAC dimmable driver included

Registered design

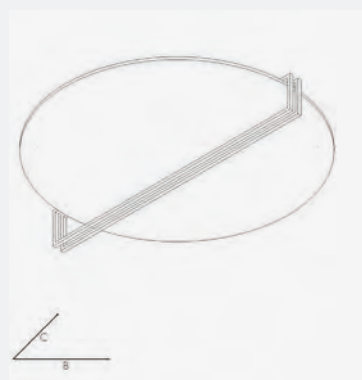

Art.	W	V	Lumen	°K led	B cm	C cm
ESSENZA 90	35	220-240	4004	3000	90	13,5
ESSENZA 70	25	220-240	3080	3000	70	13,5
ESSENZA 47	17	220-240	2152	3000	47	11
ESSENZA 30	11	220-240	1232	3000	30	9,5

DIMMERABILE TRIAC

LED disponibili a richiesta nella temperatura colore 2700 °K



ESSENZA

Marco Pagnoncelli - 2022

Sospensione a luce indiretta realizzata da un disco riflettente in alluminio di diverse finiture sul quale viene proiettata la luce proveniente da un profilo in posizione centrale ed uno in sospensione, ciascuno di sezione quadrata 7x7 millimetri.

Illuminazione a led ad alta efficienza

Disponibile anche in temperatura di colore 2700°K

Alimentatore dimmerabile TRIAC incluso

Modello depositato

Indirect light suspension made by a round shaped aluminium reflector with different finishings, on which light is emitted by 1 centered and 1 hanging profile with squared section, 7,7mm thick. Suitable for wall or ceiling mounting. High emission LEDs.

Also available in 2700°K LED color temperature

TRIAC dimmable driver included

Registered design

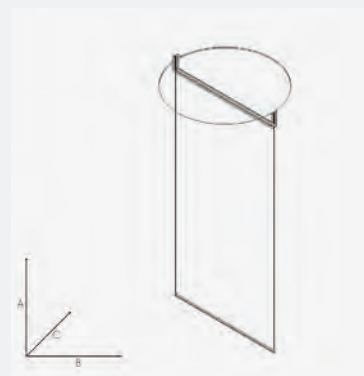

Art.	W	V	Lumen	°K led	A cm	B cm
ESSENZA 90 S DIMMERABILE TRIAC	50	220-240	5512	3000	200	90

LED disponibili a richiesta nella temperatura colore 2700 °K





VERA



VERA

Marco Pagnoncelli - 2022

Lampada a parete o soffitto in alluminio dalle differenti varianti colore e potenza luminosa LED
Orientabilità del disco luminoso a 360° parallelo alla parete e 90° perpendicolare alla parete
Illuminazione indiretta/diretta ad alta resa

Disponibile anche con LED 2700 °K

Disponibile anche nella versione dimmerabile 1-10/push o DALI

Alimentatore incluso.

Modello depositato

Wall or ceiling aluminium light fitting with different finishes and wattages
Adjustable light disc, 360° parallel and 90° perpendicular
Direct/indirect high efficiency LED light emission

Also available in 2700°K LED color temperature

Also available in 1-10V/push or DALI dimmable version

Driver included.

Registered design

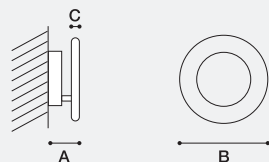

Art.	W	V	Lumen	°K led	A cm	B cm	C cm
VERA 31	25,2	220-240	3278	3000	7/36	31	0,6
VERA 26	16,8	220-240	2180	3000	7/32	26	0,6
VERA 21	13,5	220-240	1784	3000	7/27	21	0,6

DIMMERABILE TRIAC

LED disponibili a richiesta nella temperatura colore 2700 °K



VERA

Marco Pagnoncelli - 2022

Lampada a parete o soffitto in alluminio dalle differenti varianti colore e potenza luminosa LED. Orientabilità del disco luminoso a 360° parallelo alla parete. Illuminazione indiretta/diretta ad alta resa.

Disponibile anche con LED 2700 °K

Disponibile anche nella versione dimmerabile 1-10/push o DALI |

Alimentatore incluso.

Modello depositato

Wall or ceiling aluminium light fitting with different finishes and wattages

Adjustable light disc, 360° parallel

Direct/indirect high efficiency LED light emission

Also available in 2700°K LED color temperature

Also available in 1-10V/push or DALI dimmable version

Driver included.

Registered design

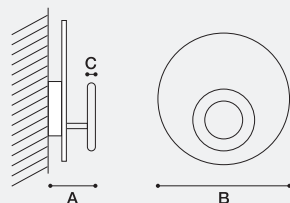

Art.	W	V	Lumen	°K led	A cm	B cm	C cm
VERA 66	25,2	220-240	3278	3000	17	66	0,6
VERA 50	16,8	220-240	2180	3000	14	50	0,6

DIMMERABILE TRIAC

LED disponibili a richiesta nella temperatura colore 2700 °K



VERA

Marco Pagnoncelli - 2022

Lampada da terra in alluminio dalle differenti varianti di colore

Disco cavo a LED ad alta efficienza

Disponibile anche con LED 2700 °K

Alimentatore incluso.

Modello depositato

Aluminum floor lamp with different color finishes

Hollow disc with high efficiency LEDs

Also available with 2700°K LED color temperature

Driver included.

Registered design

53

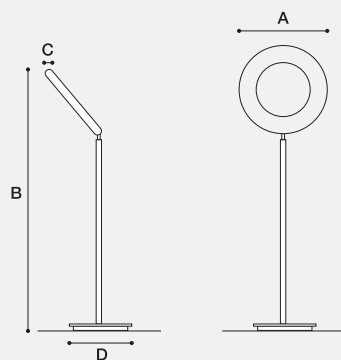

Art.	W	V	Lumen	°K led	A cm	B cm	C cm	D cm
VERA ST DIMMERABILE	25,2	220-240	3278	3000	31	190	0,6	27

LED disponibili a richiesta nella temperatura colore 2700 °K

COLORI / COLOURS

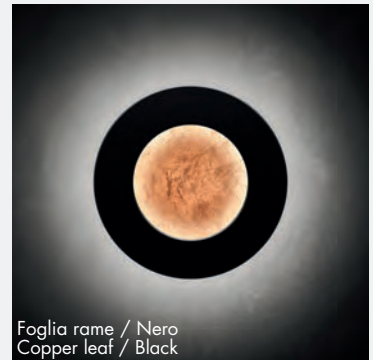

Abbinamento colori | Colors match

Disco inferiore
Lower disc
(da 2mm | 2mm thick)

Anello superiore
Upper ring
(da 6mm | 6mm thick)



Bianco
White



Rame bronzato
Bronzed copper



Ottone
Satin Brass



Ruggine
Rust



Bianco
White



Nero
Black



Alluminio spatolato
Brushed aluminium



Foglia oro
Gold leaf



Bianco
White



Ruggine
Rust



Foglia rame
Copper leaf



Nero
Black



Foglia argento
Silver leaf



Bianco
White



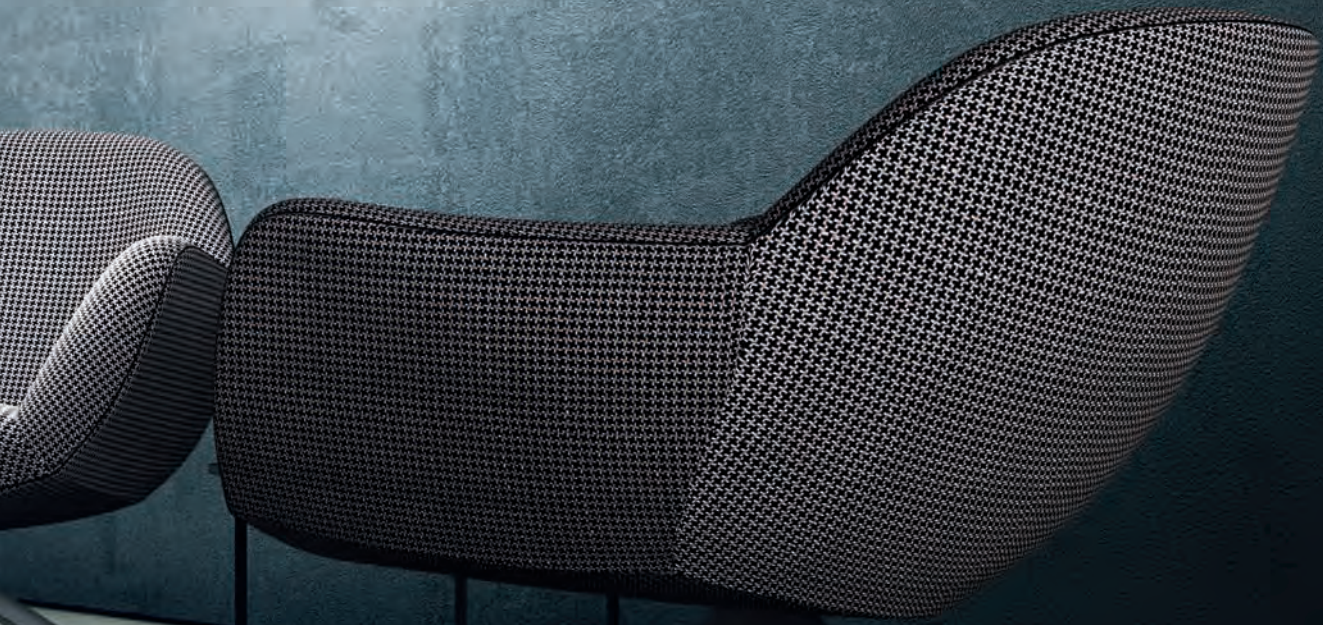

HULA HOOP



HULA HOOP

Marco Pagnoncelli - 2022

Lampada a soffitto in alluminio dalle differenti varianti colore e potenza luminosa LED
Illuminazione indiretta/diretta ad alta resa

Disponibile anche con LED 2700 °K

Alimentatore incluso.

Dimmerabile con sistema TRIAC.

Modello depositato

Ceiling aluminium light fitting with different finishes and wattages
Direct/indirect high efficiency LED light emission

Also available in 2700°K LED color temperature

Driver included.

Dimmable with TRIAC system.

Registered design

59

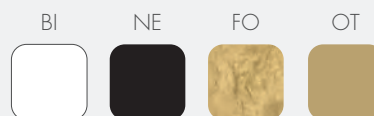

abbinamento colori | colors match

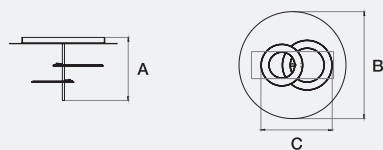
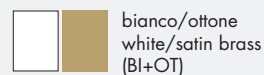
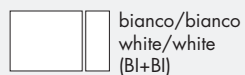

Art.	W	V	Lumen	°K led	A cm	B cm	C cm
HULA HOOP P2 DIMMERABILE TRIAC	42	220-240	5458	3000	40	ø 66	44

LED disponibili a richiesta nella temperatura colore 2700 °K



HULA HOOP

Marco Pagnoncelli - 2022

Lampada a soffitto in alluminio dalle differenti varianti colore e potenza luminosa LED
Illuminazione indiretta/diretta ad alta resa

Disponibile anche con LED 2700 °K

Alimentatore incluso.

Dimmerabile con sistema TRIAC.

Modello depositato

Ceiling aluminium light fitting with different finishes and wattages
Direct/indirect high efficiency LED light emission

Also available in 2700°K LED color temperature

Driver included.

Dimmable with TRIAC system.

Registered design

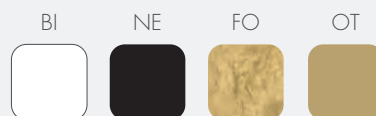

abbinamento colori | colors match

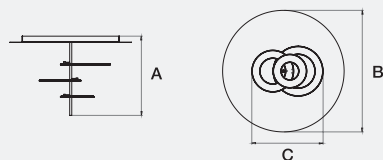
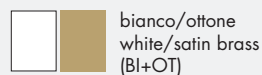
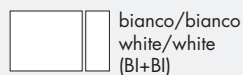

Art.	W	V	Lumen	°K led	A cm	B cm	C cm
HULA HOOP P3 DIMMERABILE TRIAC	55,5	220-240	7242	3000	50	ø 75	50

LED disponibili a richiesta nella temperatura colore 2700 °K



HULA HOOP

Marco Pagnoncelli - 2022

Sospensione in alluminio dalle
differenti varianti colore
Illuminazione indiretta/diretta ad
alta resa

Aluminium suspension with
different finishings
Direct/indirect high efficiency LED
light emission

Disponibile anche
con LED 2700 °K

Also available in 2700°K LED
color temperature

Alimentatore incluso.

Driver included.

Dimmerabile con sistema TRIAC.

Dimmable with TRIAC system.

Modello depositato

Registered design



abbinamento colori | colors match



Art.	W	V	Lumen	°K led	A cm	B cm	C cm
HULA HOOP S2 DIMMERABILE TRIAC	50,4	220-240	6556	3000	160	ø 50	32

LED disponibili a richiesta nella temperatura colore 2700 °K



HULA HOOP

Marco Pagnoncelli - 2022

Sospensione in alluminio dalle
differenti varianti colore
Illuminazione indiretta/diretta ad
alta resa

Aluminium suspension with
different finishings
Direct/indirect high efficiency LED
light emission

Disponibile anche
con LED 2700 °K

Also available in 2700°K LED
color temperature

Alimentatore incluso.

Driver included

Dimmerabile con sistema 1-10V

Dimmable with 1-10V system

Modello depositato

Registered design

65



abbinamento colori | colors match

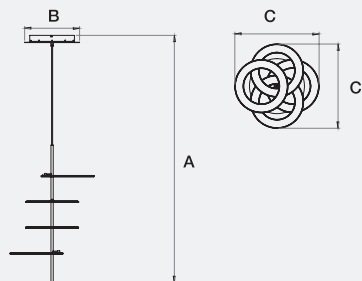

Art.	W	V	Lumen	°K led	A cm	B cm	C cm
HULA HOOP S4 DIMMERABILE 1-10V	100	220-240	13112	3000	160	ø 32	50

LED disponibili a richiesta nella temperatura colore 2700 °K





PETRA



PETRA

Marco Pagnoncelli - 2022

Lampada a parete o soffitto in alluminio dalle differenti varianti colore e potenza luminosa LED
Orientabilità del quadrato luminoso a 360° parallelo alla parete e 90° perpendicolare alla parete
Illuminazione indiretta/diretta ad alta resa

Disponibile anche con LED 2700°K

Disponibile anche nella versione dimmerabile 1-10/push o DALI

Alimentatore incluso.

Modello depositato

Wall or ceiling aluminium light fitting with different finishes and wattages
Adjustable square light unit, 360° parallel and 90° perpendicular
Direct/indirect high efficiency LED light emission

Also available in 2700°K LED color temperature

Also available in 1-10V/push or DALI dimmable version

Driver included.

Registered design

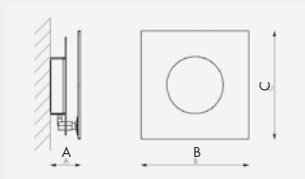

Art.	W	V	Lumen	°K led	A cm	B cm	C cm
PETRA 31	25,2	220-240	3278	3000	7	31	31
PETRA 26	16,8	220-240	2180	3000	7	26	26
PETRA 21	13,5	220-240	1784	3000	7	21	21

DIMMERABILE TRIAC

LED disponibili a richiesta nella temperatura colore 2700 °K



PETRA

Marco Pagnoncelli - 2022

Lampada a parete o soffitto in alluminio dalle differenti varianti colore e potenza luminosa LED. Orientabilità del quadrato luminoso a 360° parallelo alla parete | Illuminazione indiretta/diretta ad alta resa

Disponibile anche con LED 2700 °K

Disponibile anche nella versione dimmerabile 1-10/push o DALI Alimentatore incluso.

Possibilità di aggiungere da una a quattro unità kit di sospensione KIT400, dimmerabile TRIAC:
per PETRA 66 (max 4)
per PETRA 50 (max 3)
per PETRA 40 (max 2)

Modello depositato

Wall or ceiling aluminium light fitting with different finishes and wattages
Adjustable square light unit, 360° parallel
Direct/indirect high efficiency LED light emission

Also available in 2700°K LED color temperature

Also available in 1-10V/push or DALI dimmable version
Driver included.

It is possible to add from 1 up to 4 units of KIT400 suspension kit, TRIAC dimmable:
for PETRA 66 (max 4)
for PETRA 50 (max 3)
for PETRA 40 (max 2)

Registered design

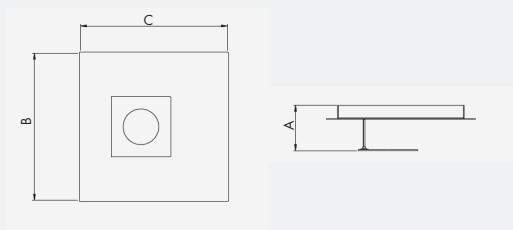

Art.	W	V	Lumen	°K led	A cm	B cm	C cm
PETRA 66	25,2	220-240	3278	3000	20	66	66
PETRA 50	16,8	220-240	2180	3000	20	50	50
PETRA 40	13,5	220-240	1784	3000	20	43	43

DIMMERABILE TRIAC

LED disponibili a richiesta nella temperatura colore 2700 °K



PETRA

Marco Pagnoncelli - 2022

Lampada a parete in alluminio dalle differenti varianti colore e potenza luminosa LED. Orientabilità del quadrato luminoso e dello spot. Illuminazione indiretta/diretta ad alta resa. Doppia accensione.

Disponibile anche con LED 2700 °K. Alimentatori inclusi.

Quadrato luminoso dimmerabile TRIAC

Modello depositato

Ceiling aluminium light fitting with different finishes and wattages. Adjustable light square and spot. Direct/indirect high efficiency LED light emission. Double switching

Also available in 2700°K LED color temperature

Drivers included

TRIAC dimmable square light unit

Registered design

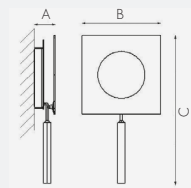

Art.	W	V	Lumen	°K led	A cm	B cm	C cm
PETRA 21.L							
PROIETTORE	13,5	220-240	1784	3000	7	21	38
SPOT	1,5	220-240	176	3000			
TOTALE	15,0	220-240	1960	3000			
DIMMERABILE TRIAC							

LED disponibili a richiesta nella temperatura colore 2700 °K



PETRA

Marco Pagnoncelli - 2022

Lampada a soffitto in alluminio dalle differenti varianti colore
Orientabilità dei quadrati luminosi a 360° paralleli alla parete
Illuminazione indiretta/diretta ad alta resa

Disponibile anche con LED 2700 °K

Possibilità di aggiungere fino a 2 unità kit di sospensione KIT400.

Alimentatori inclusi
Quadrato luminoso dimmerabile TRIAC

Modello depositato

Ceiling aluminium light fitting with different finishes.

Adjustable square light units, 360° parallel.

Direct/indirect high efficiency LED light emission.

Also available in 2700°K LED color temperature

Drivers included.

It is possible to add up to 2 units of KIT400 suspension kit, TRIAC dimmable light units

Registered design

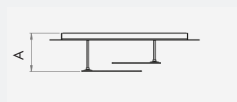
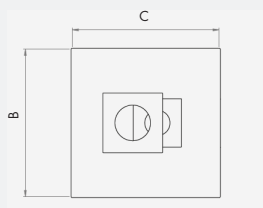

Art.	W	V	Lumen	°K led	A cm	B cm	C cm
PETRA 2 DIMMERABILE TRIAC	42	220-240	5458	3000	18	66	66

LED disponibili a richiesta nella temperatura colore 2700 °K

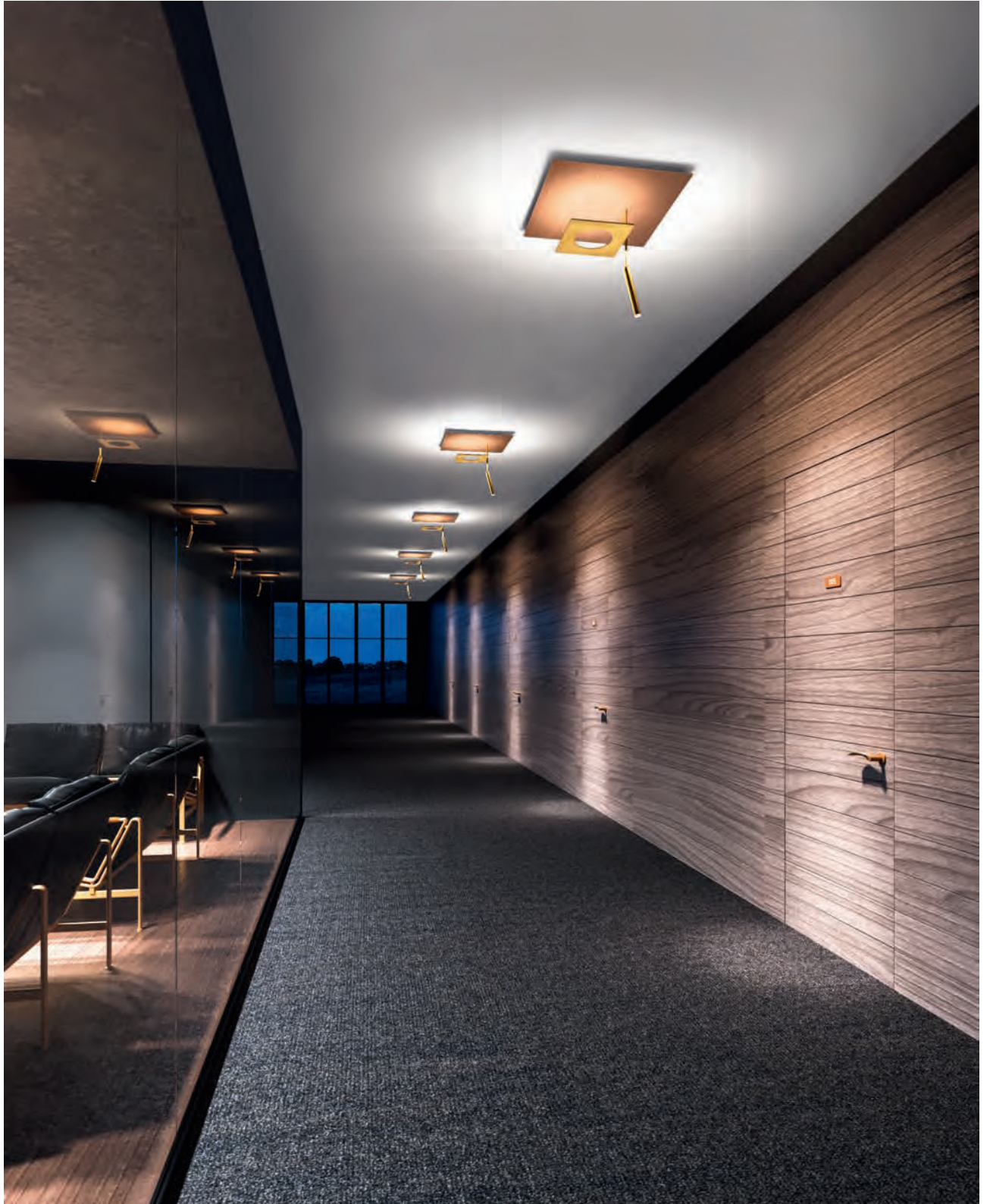

PETRA

Marco Pagnoncelli - 2022

Lampada a soffitto in alluminio dalle differenti varianti colore. Orientabilità dei quadrati luminoso a 360° paralleli alla parete e dello spot. Illuminazione indiretta/diretta ad alta resa.

Disponibile anche con LED 2700 °K

Alimentatori inclusi.
Quadrati luminosi dimmerabili
TRIAC

Ceiling aluminium light fitting with different finishes. Adjustable spot and square light units, 360° parallel. Direct/indirect high efficiency LED light emission.

Also available in 2700°K LED color temperature.

Drivers included.
TRIAC dimmable square light units.

Modello depositato

Registered design

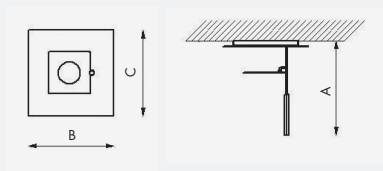

Art.	W	V	Lumen	°K led	A cm	B cm	C cm
PETRA P2.66							
PROIETTORE	25,2	220-240	3278	3000	45	66	66
SPOT	9	220-240	1440	3000			
TOTALE	34,2	220-240	4718	3000			
PETRA P2.50							
PROIETTORE	16,8	220-240	2180	3000	45	50	50
SPOT	9	220-240	1440	3000			
TOTALE	25,8	220-240	3620	3000			
PETRA P2.40							
PROIETTORE	13,5	220-240	1784	3000	45	40	40
SPOT	9	220-240	1440	3000			
TOTALE	22,5	220-240	3224	3000			

DIMMERABILE TRIAC

LED disponibili a richiesta nella temperatura colore 2700 °K



PETRA

Marco Pagnoncelli - 2022

Lampada a soffitto in alluminio dalle differenti varianti colore
Orientabilità dei quadrati luminoso a 360° paralleli alla parete e dello spot
Illuminazione indiretta/diretta ad alta resa

Disponibile anche con LED 2700 °K

Alimentatori inclusi
Quadrati luminosi dimmerabili
TRIAC

Ceiling aluminium light fitting with different finishes.
Adjustable spot and square light units, 360° parallel.
Direct/indirect high efficiency LED light emission.

Also available in 2700°K LED color temperature.

Drivers included.
TRIAC dimmable square light units.

Modello depositato

Registered design

79

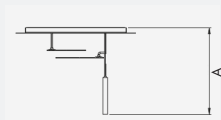
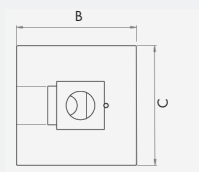

Art.	W	V	Lumen	°K led	A cm	B cm	C cm
PETRA.3							
PROIETTORE	42	220-240	5458	3000	45	66	66
SPOT	9	220-240	1440	3000			
TOTALE	51	220-240	6898	3000			
DIMMERABILE TRIAC							

LED disponibili a richiesta nella temperatura colore 2700 °K



PETRA

Marco Pagnoncelli - 2022

Lampada a soffitto in alluminio
dalle differenti varianti colore
Orientabilità del quadrato
luminoso a 360° paralleli alla
parete, spot a sospensione
Illuminazione indiretta/diretta ad
alta resa
Disponibile anche
con LED 2700 °K

Alimentatori inclusi.
Quadrato luminoso dimmerabile
TRIAC

Ceiling aluminium light fitting with
different finishes
Adjustable square light unit, 360°
parallel, suspension spot
Direct/indirect high efficiency LED
light emission

Also available in 2700°K LED
color temperature

Drivers included.
TRIAC dimmable square light unit

Modello depositato

Registered design

81

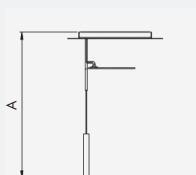
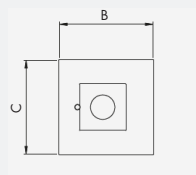

Art.	W	V	Lumen	°K led	A cm	B cm	C cm
PETRA S2							
PROIETTORE	25,2	220-240	3278	3000	150	66	66
SPOT	9	220-240	1440	3000			
TOTALE	34,2	220-240	4718	3000			
DIMMERABILE TRIAC							

LED disponibili a richiesta nella temperatura colore 2700 °K



PETRA

Marco Pagnoncelli - 2022

Lampada a soffitto di forma rettangolare in alluminio dalle differenti varianti colore e Orientabilità dei quadrati luminosi a 360° paralleli alla parete. Spot a sospensione. Illuminazione indiretta/diretta ad alta resa.

Disponibile anche con LED 2700 °K

Alimentatori inclusi
Quadrati luminosi dimmerabili
TRIAC

Ceiling aluminium light fitting, rectangular shaped, with different finishes. Adjustable light squares, 360° parallel. Suspension spot. Direct/indirect high efficiency LED light emission

Also available in 2700°K LED color temperature

Drivers included.
TRIAC dimmable square light units.

Modello depositato

Registered design

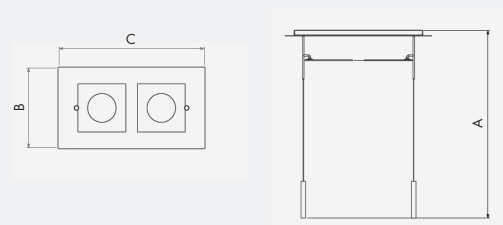

Art.	W	V	Lumen	°K led	A cm	B cm	C cm
PETRA S4.R							
PROIETTORE	33,6	220-240	4360	3000	150	40	80
SPOT	18	220-240	2880	3000			
TOTALE	51,6	220-240	7240	3000			
DIMMERABILE TRIAC							

LED disponibili a richiesta nella temperatura colore 2700 °K



PETRA

Marco Pagnoncelli - 2022

Lampada a soffitto in alluminio dalle differenti varianti colore. Orientabilità dei quadrati luminosi a 360° paralleli alla parete. Spot a sospensione Illuminazione indiretta/diretta ad alta resa.

Disponibile anche con LED 2700 °K

Alimentatori inclusi
Quadrati luminosi dimmerabili
TRIAC

Ceiling aluminium light fitting with different finishes. Adjustable light squares, 360° parallel . Suspension spot. Direct/indirect high efficiency LED light emission.

Also available in 2700°K LED color temperature.

Drivers included.
TRIAC dimmable square light units.

Modello depositato

Registered design

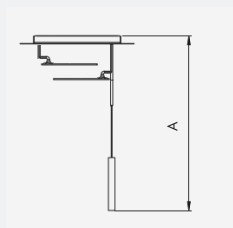
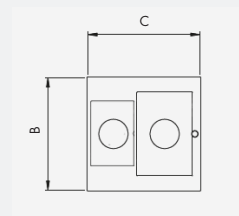

Art.	W	V	Lumen	°K led	A cm	B cm	C cm
PETRA S3							
PROIETTORE	41	220-240	5458	3000	150	66	66
SPOT	9	220-240	1440	3000			
TOTALE	51	220-240	6898	3000			
DIMMERABILE TRIAC							

LED disponibili a richiesta nella temperatura colore 2700 °K

ACCESSORI / ACCESSORIES

per/for PETRA **66** (max 4) - PETRA **50** (max 3) - PETRA **40** (max 2)

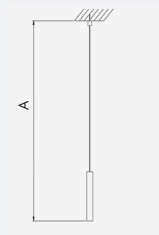

Art.	W	V	Lumen	°K led	A cm
KIT 400	9	220-240	1440	3000	400

LED disponibili a richiesta nella temperatura colore 2700 °K

COLORI / COLOURS





Ecrù / Ottone satinato
Ecrù / Satin Brass

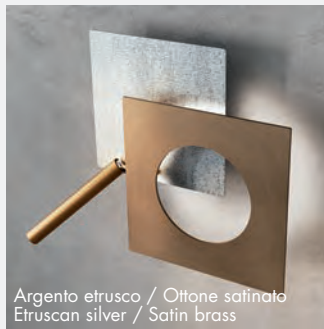

Argento etrusco / Ottone satinato
Etruscan silver / Satin brass



Oro etrusco / Ruggine
Etruscan gold / Rust



Nero ardesia / Alluminio satinato
Slate black / Satin aluminum

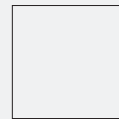

Bianco
White

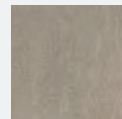

Ecrù
Ecrù

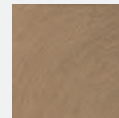

Ottone satinato
Satin brass

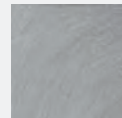

Alluminio satinato
Satin aluminum



Rame etrusco
Etruscan copper



Argento etrusco
Etruscan silver

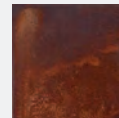

Ruggine
Rust

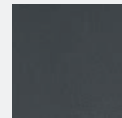

Nero ardesia
Slate black

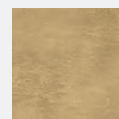

Oro etrusco
Etruscan gold



Nero
Black





CAVEAU chosen by Stylepark Selected Light + Building 2018 | Trendspot Design
HALL 1.2 - J40

CAVEAU

Marco Pagnoncelli

È TEMPO DI NUOVA LUCE.

Tecnologia ed emozione insieme, per illuminare gli spazi del tempo presente. Con una luce nuova, dall'impatto scenografico semplicemente unico. Caveau è la lampada ad incasso che rientra totalmente nella parete, racchiusa entro una copertura di forma circolare, dotata di sistema di apertura/chiusura automatizzato. Icona di stile, con cui ICONO accende una nuova scintilla nel connubio tra forma e funzione.



GUARDA IL VIDEO
WATCH THE VIDEO



**VERSATILE, ELEGANTE,
INSERITA NEL VIVERE
CONTEMPORANEO.**

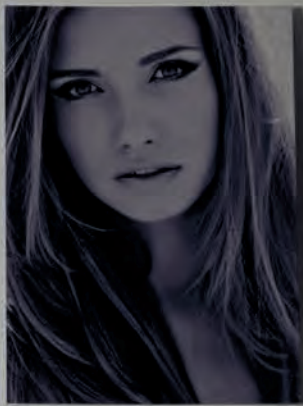

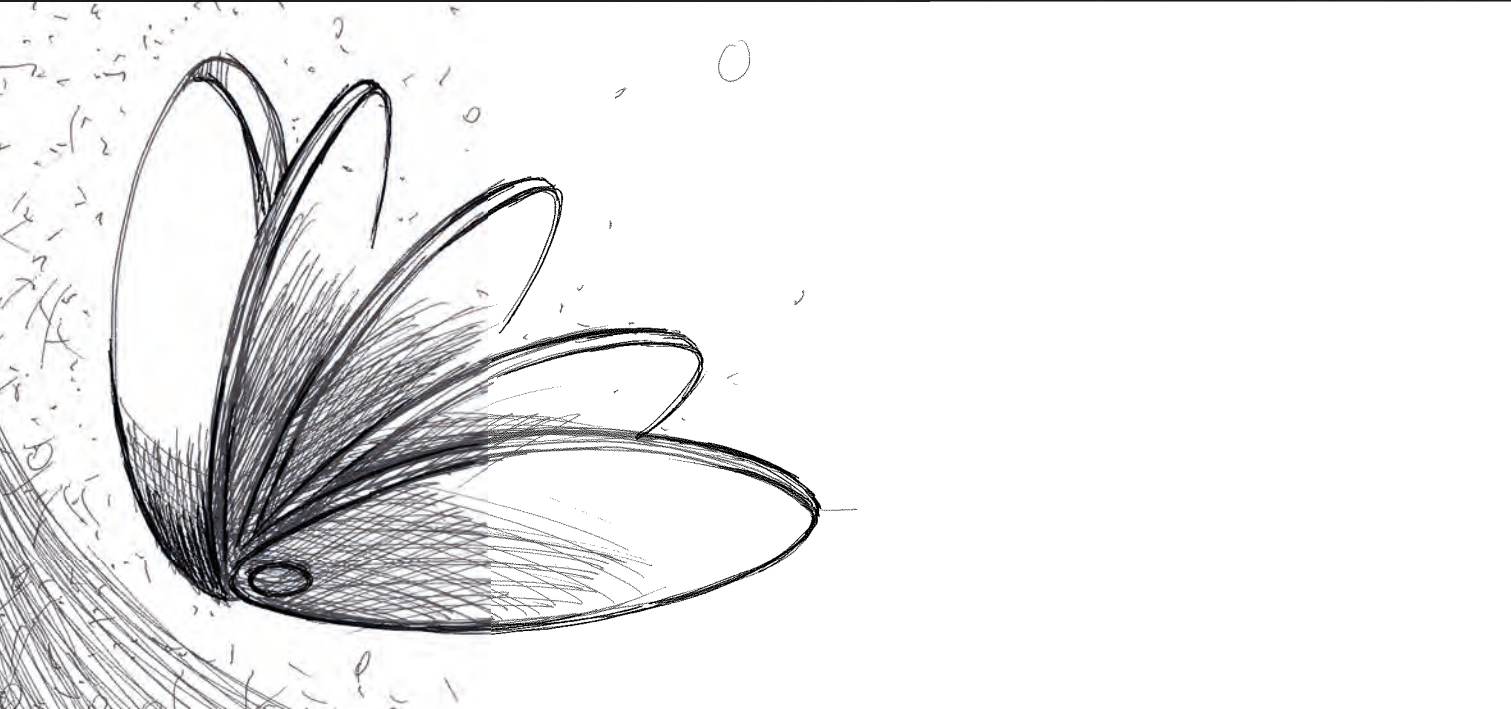

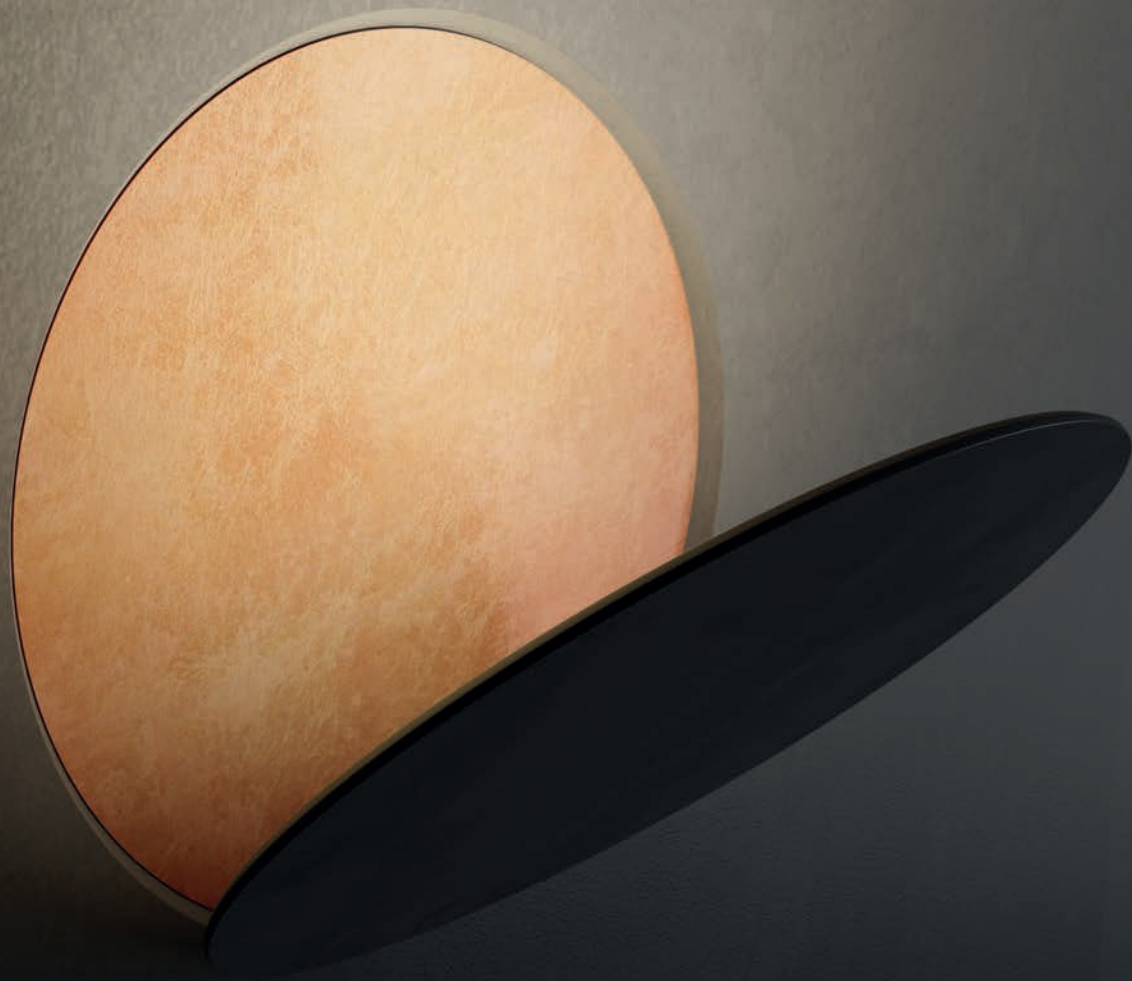

ILLUMINA IL FUTURO E RIDEFINISCE IL CONFORT

Caveau offre una risposta versatile ed elegante a chi cerca soluzioni innovative per arredare con più personalità. Appare dal muro e porge come da uno scrigno la quantità di luce desiderata, per poi svanire nuovamente con discrezione ad interno parete.

VERSATILITÀ NELLE FINITURE

Adattabile ai più svariati contesti di arredo - grazie alle tante possibilità di rivestimento e di colore -, Caveau è una lampada a Led a luce riflessa di altissima qualità con temperatura cromatica calda ad intensità variabile.

Illumina, a seconda delle esigenze, anche ambienti di grandi dimensioni in virtù della potenza di emissione raggiungibile.







incasso

CAVEAU

Marco Pagnoncelli - 2016



LAMPADA INCASSO A PARETE
Lampada ad incasso dal design essenziale ad apertura automatizzata, con possibilità di programmare l'angolo di apertura da 0° a 90°.

Driver e centralina di controllo incluse.

Illuminazione a LED 24V dimmerabile.

Disponibile nella temperatura colore LED 3000 °K e 2700 °K.
Ingegnerizzazione del movimento Paolo Bassani

RECESSED WALL LAMP

A recessed wall lamp with an essential design and with automatic opening. Adjustable opening from 0° to 90°. 24V dimmable light source. Driver and control unit included. Available with 3000 °K or 2700 °K LED colour temperature.

Engineering movement Paolo Bassani

Modello depositato



Registered design

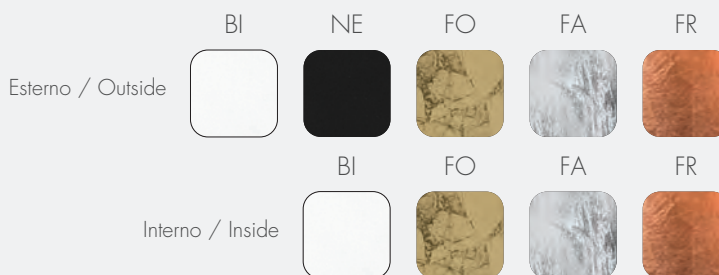

97

CONTROCASSA / WALL HOUSING

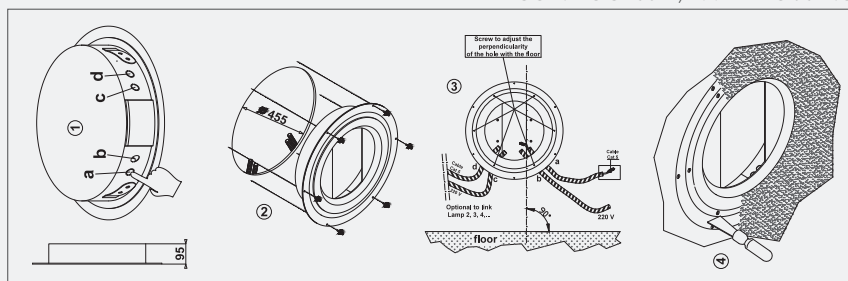
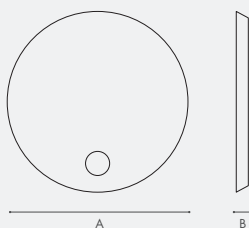

Art.	W	V	Lumen	°K led	A cm	B cm	FORO cm
CAVEAU	30	220-240	4861	3000	Ø32	0,6	45
CA.CAV	CONTROCASSA / WALL HOUSING						
P.L.T.01	SCHEMA PULSANTE INCLUSO BLUETOOTH						

LED Disponibili a richiesta nella temperatura colore 2700 °K





IN FATTO DI LUCE, OGNUNO HA LA PROPRIA INCLINAZIONE.

Caveau soddisfa ogni esigenza, con una gestione dell'emissione luminosa determinata dalla minore o maggiore apertura dell'elemento-cerchio. Il movimento automatizzato consente di programmare l'angolo in un range che va da 0° a 90°, con quantità di luce sempre precisamente determinabili. Per esempio - a copertura appena socchiusa, e a luce accesa - si determina lo scenografico effetto eclissi; mentre a copertura interamente aperta, si ha una emissione che può giungere sino ad un equivalente di 300 Watt. In fatto di luce, ognuno ha la propria inclinazione: Caveau, invece, le ha tutte.

UNA DISTINZIONE SOTTILE.

L'incasso a parete viene eseguito con facilità: grazie alla struttura quanto mai sottile della lampada, infatti, è richiesto soltanto un intervento di ridotta profondità nel muro.

Caveau - inseribile all'interno sia di muratura che di cartongesso - può dunque venire montata anche in vasto numero di esemplari nello stesso ambiente, senza costi di posa in opera o tempistiche particolarmente impegnativi.

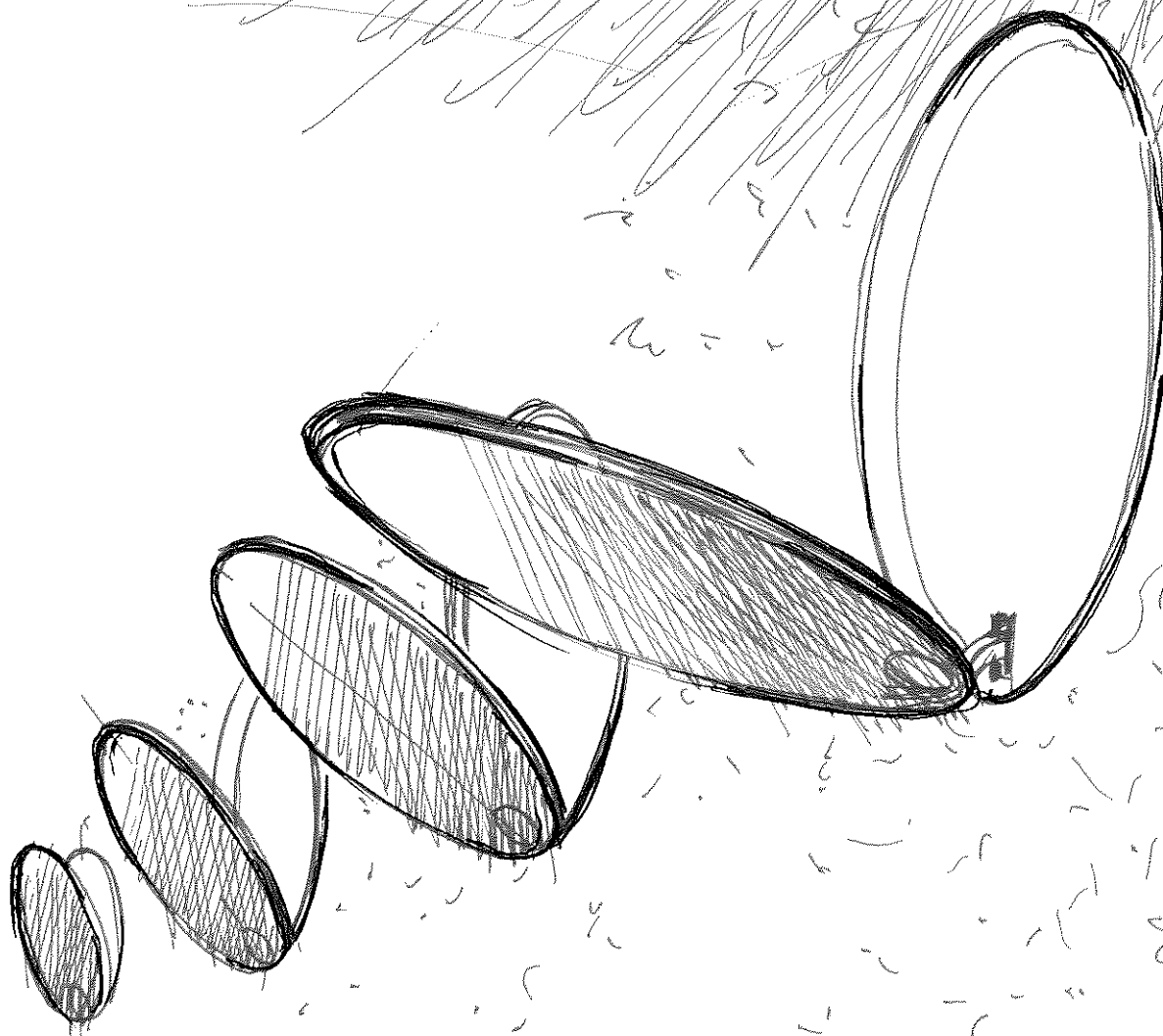





UNA LAMPADA DAVVERO SMART.

Le funzioni di Caveau sono gestibili mediante tecnologia bluetooth da tutti i dispositivi - sia Apple che Android -, in linea con le esigenze della domotica più avanzata.

Il quadro comandi è facilmente accessibile, contrariamente a quanto accade in numerose altre lampade. Programmare Caveau, manualmente o via software, risulta perciò quanto mai agevole.

Per questo, si tratta di una lampada realmente innovativa sotto tanti aspetti diversi: la qualità del led a luce riflessa, abbinata a un'eleganza del tutto personale, supportata da tecnologie avanzate.





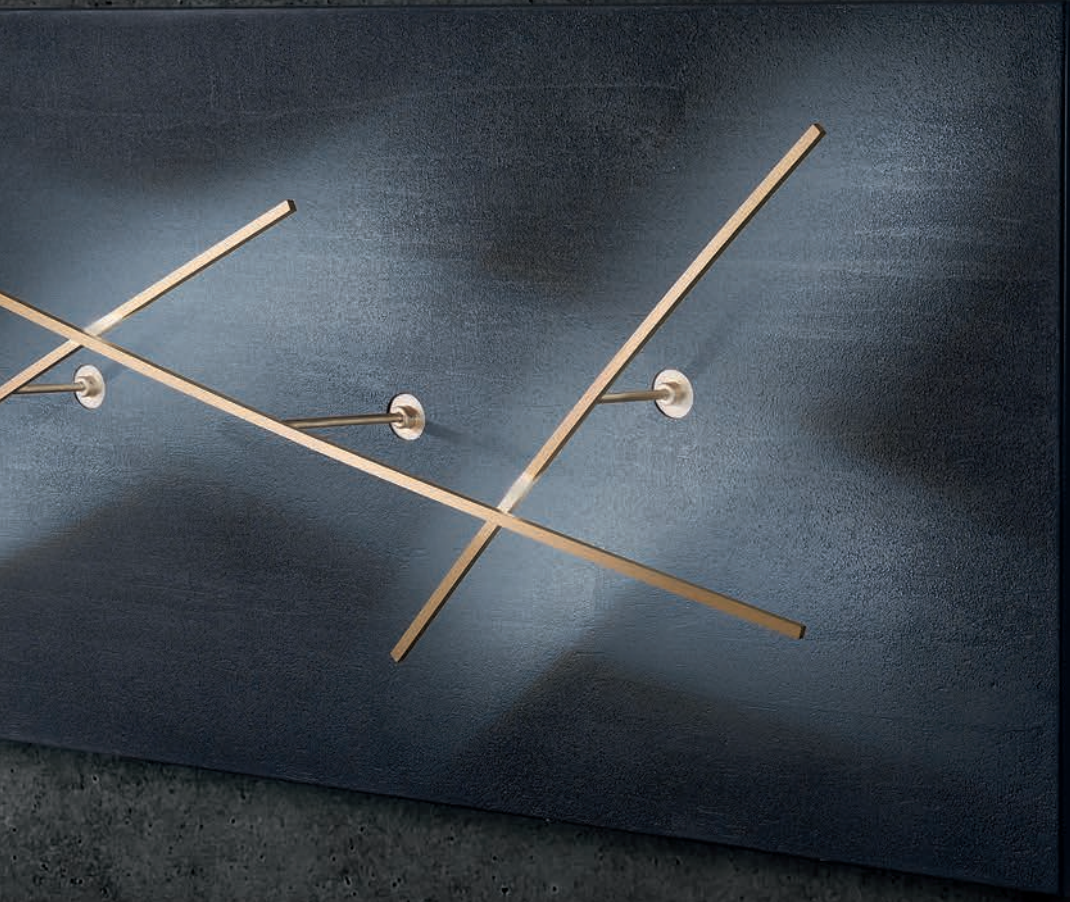

ALBATROS



ALBATROS

Marco Pagnoncelli - 2022

Collezione ad alto impatto scenografico realizzata da una struttura scatolare rettangolare effetto pietra, sulla quale viene proiettata la luce prodotta da tre astine di sezione quadrata curvate e orientabili in senso rotatorio.

A collection of light fittings with high scenic impact, made by a stone-like rectangular structure on which light is emitted by 3 rotating curved rods with squared section.

Driver included.

Alimentatore incluso.

Modello depositato

Registered design

107

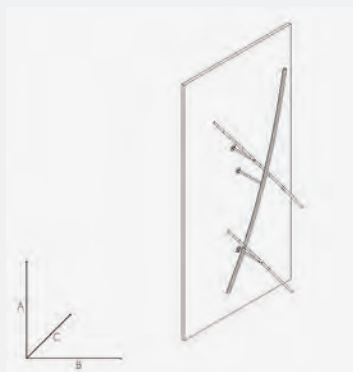
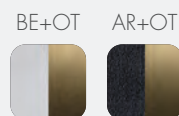

Art.	W	V	Lumen	°K led	A cm	B cm	C cm
ALBATROS 145	45	220-240	6155	3000	145	70	18
ALBATROS 100	30	220-240	3702	3000	100	50	17

LED disponibili a richiesta nella temperatura colore 2700 °K



ALBATROS

Marco Pagnoncelli - 2014

Lampada curvata da incasso a soffitto o parete, a luce indiretta, realizzata in trafilata di ottone 7x7mm. Disponibile in kit da minimo 3 elementi e diverse potenze luminose. Illuminazione a microstrisce LED ad alta efficienza luminosa. Finiture colore: verniciato bianco (BI), cromo (CR).

Alimentatori a pag. 136

Wall or ceiling flush mounting curved lamp, indirect light made of 7x7 mm brass profile. Available as a kit of at minimum 3 elements and various light intensities. High lighting efficiency LED micro-strips. Available in: white varnish (BI), chrome (CR).

Power supply units on page 136.

Modello depositato



Registered design

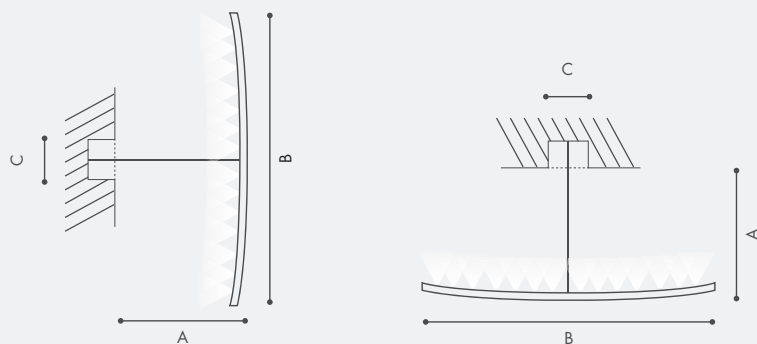

BI

CR



109

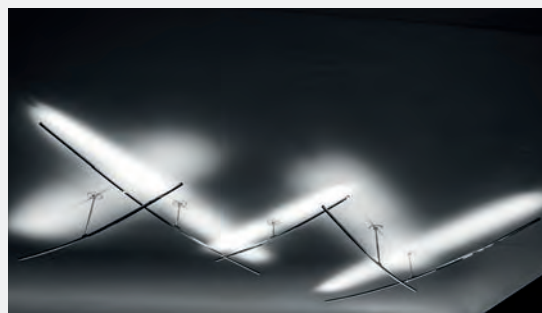

CONTROCASSE CARTONGESSO COD. CA.80
WALL HOUSING FOR PLASTERBOARD COD. CA.80

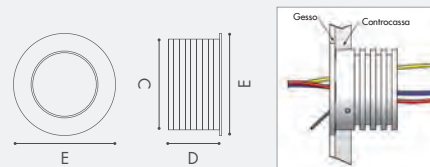

Art.	W	V	Lumen	°K led	A cm	B cm	Foro C cm	D cm	E cm	*misure per singolo elemento/ measures for single element
ALBATROS 3i.70i	20,76	220-240	1800	3000	8/25	70	6	2,0	7	Trasformatore NON compreso/Driver NOT included
ALBATROS 3i.90i	31,68	220-240	2640	3000	8/25	90	6	2,0	7	Trasformatore NON compreso/Driver NOT included
ALBATROS 3i.110i	39,60	220-240	5280	3000	8/25	110	6	2,0	7	Trasformatore NON compreso/Driver NOT included
ALBATROS 3i.3*	30,68	220-240	3240	3000	8/25	110	6	2,0	7	Trasformatore NON compreso/Driver NOT included

***COMPOSIZIONE 1xi70i + 1xi90i + 1xi110i**

LED Disponibili a richiesta nella temperatura colore 2700 °K

110

parete



ALBATROS

Marco Pagnoncelli - 2014

Lampada curvata da parete orientabile diretta o indiretta, realizzata in trafilata di ottone 7x7mm. Disponibile in 3 misure e diverse potenze luminose. Illuminazione a microstrisce LED ad alta efficienza luminosa. Finiture colore: verniciato bianco (BI), cromo (CR), foglia oro+oro (FO+OR).

Curved wall lamp, adjustable for direct or indirect light, made of 7x7 mm brass profile. Available in 3 sizes and various light intensities. High lighting efficiency LED micro-strips. Available in: white varnish (BI), chrome (CR), gold leaf+gold (FO+OR).

Alimentatore incluso.

Driver included.

Modello depositato

Registered design

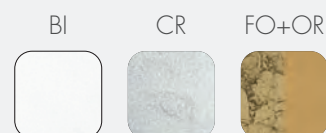

111

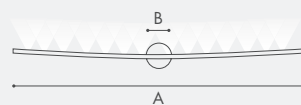
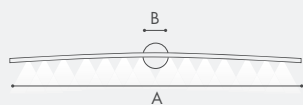
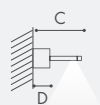

Movimento

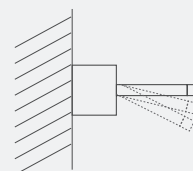

Art.	W	V	Lumen	°K led	A cm	B cm	C cm	D cm	
ALBATROS.50.M	4,80	220-240	440	3000	50	9	13	4,5	Trasformatore incorporato/Built-in driver
ALBATROS.70.M	7,92	220-240	660	3000	70	9	13	4,5	Trasformatore incorporato/Built-in driver
ALBATROS.90.M	10,56	220-240	880	3000	90	9	13	4,5	Trasformatore incorporato/Built-in driver

LED Disponibili a richiesta nella temperatura colore 2700 °K





ORIZZONTE





116

parete



ORIZZONTE

Marco Pagnoncelli - 2014

Lampada da parete fissa a luce diretta o indiretta, realizzata in trafila di ottone 7x7mm.

Disponibile in 3 misure

e diverse potenze luminose.

Illuminazione a microstrisce

LED ad alta efficienza luminosa.

Finiture colore: verniciato

bianco (BI), cromo (CR), oro

opaco (OR).

Alimentatore integrato

Wall lamp, fixed direct or indirect light, made of 7x7 mm brass profile. Available in 3 sizes and various light intensities.

High lighting efficiency LED

micro-strips. Available in:

white varnish (BI), chrome (CR),

brushed gold (OR).

Built-in driver.

Modello depositato

Registered design

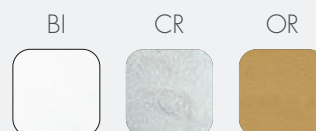

117

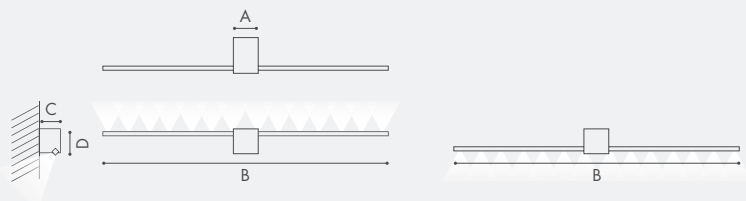

Art.	W	V	Lumen	°K led	A cm	B cm	C cm	D cm	
ORIZZONTE.50	4,80	220-240	440	3000	6	50	10	6	Alimentatore incluso/Built-in driver
ORIZZONTE.70	7,92	220-240	660	3000	6	70	10	6	Alimentatore incluso/Built-in driver
ORIZZONTE.90	10,56	220-240	880	3000	6	90	10	6	Alimentatore incluso/Built-in driver

LED Disponibili a richiesta nella temperatura colore 2700 °K





YPSILON



YPSILON

Marco Pagnoncelli - 2022

Lampada da parete a luce diretta o indiretta, realizzata in trafilata di ottone 7x7mm.

Disponibile in 3 misure e diverse potenze luminose.

Illuminazione a microstrisce LED ad alta efficienza luminosa
Finiture: oro opaco (OR), cromo (CR), bronzo spazzolato (BS)

Alimentatore incluso.

Modello depositato

Wall lamp with direct/indirect light emission, made in 7x7mm brass drawing.

Available in 3 lengths and different wattages.

Lighting by high efficiency LED micro strips.

Finishes: dim gold (OR), chrome (CR), brushed bronze (BS).

Driver included.

Registered design

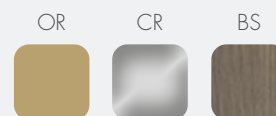
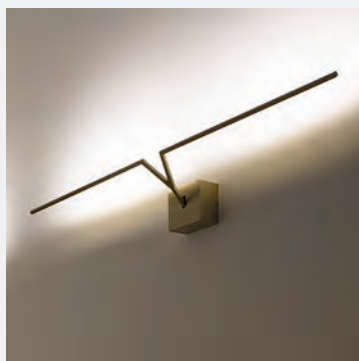

121

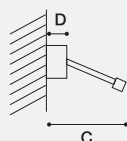
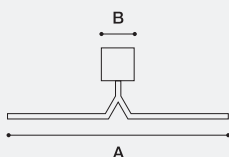

Art.	W	V	Lumen	°K led	A cm	B cm	C cm	D cm
YPSILON 50	4,80	220-240	440	3000	50	8	10/17	4,5
YPSILON 70	7,92	220-240	660	3000	70	8	10/17	4,5
YPSILON 90	10,56	220-240	880	3000	90	8	10/17	4,5

LED disponibili a richiesta nella temperatura colore 2700 °K





ZETA



ZETA

Marco Pagnoncelli - 2022

Lampada da parete a luce diretta o indiretta, realizzata in trafilata di ottone 7x7mm.

Disponibile in 3 misure e diverse potenze luminose.

Illuminazione a microstrisce LED ad alta efficienza luminosa

Finiture: oro opaco (OR), cromo (CR), bronzo spazzolato (BS)

Alimentatore incluso.

Modello depositato

Wall lamp with direct/indirect light emission, made in 7x7mm brass drawing.

Available in 3 lengths and different wattages.

Lighting by high efficiency LED micro strips.

Finishes: dim gold (OR), chrome (CR), brushed bronze (BS).

Driver included.

Registered design

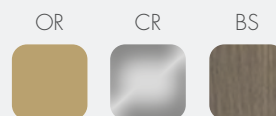

125

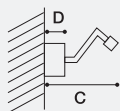
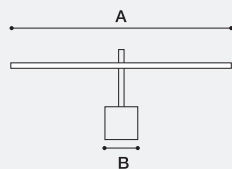

Art.	W	V	Lumen	°K led	A cm	B cm	C cm	D cm
ZETA 50	4,80	220-240	440	3000	50	8	17/20	4,5
ZETA 70	7,92	220-240	660	3000	70	8	17/20	4,5
ZETA 90	10,56	220-240	880	3000	90	8	17/20	4,5

LED disponibili a richiesta nella temperatura colore 2700 °K





SPILLO



SPILLO

Marco Pagnoncelli - 2012

Lampada incasso a filo muro da parete e soffitto con asta orientabile realizzata in trafila di ottone sezione 7x7 mm.

Disponibile in varie misure e diverse potenze.

Illuminazione a microstriscia LED ad alta efficienza luminosa.

Necessita di alimentatore e controcassa, non inclusi.*

Finiture colore:

verniciato bianco (BI), verniciato nero (NE), cromo (CR), oro opaco (OR).

Alimentatori, controcasse e specifiche tecniche a pag. 140-141.

Built-in flush wall or ceiling lamp with adjustable drawn brass rod, 7x7 mm section.

Available in various dimensions and power levels.

Lighting by high luminous efficiency LED micro-strip.

Requires power supply unit and wall housing, which is not included.*

Available in:

white varnish (BI), black varnish (NE), chrome (CR), brushed gold (OR).

Power supply units, wall housings and technical specifications on page 140-141.

Modello depositato

Registered design

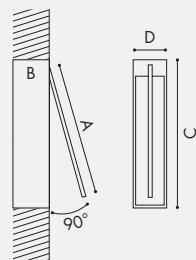

Art.	W	V	Lumen	°K led	A cm	B cm	C cm	D cm	∅7 cm
SPILLO1i.12	1,32	12	110	3000	11,5	3	12,6	3,3	8,2x13,2
SPILLO1i.22	2,64	12	220	3000	21,5	3	22,6	3,3	8,2x23,2
SPILLO1i.32	3,96	12	330	3000	31,5	3	32,6	3,3	8,2x33,2
SPILLO1i.42	4,80	12	440	3000	41,5	3	42,6	3,3	8,2x43,2
SPILLO1i.52	6,60	12	550	3000	51,5	3	52,6	3,3	8,2x53,2
SPILLO1i.62	7,92	12	660	3000	61,5	3	62,6	3,3	8,2x63,2
SPILLO1i.82	10,56	12	880	3000	81,5	3	82,6	3,3	8,2x83,2

LED Disponibili a richiesta nella temperatura colore 2700 °K















SPILLO

Marco Pagnoncelli - 2012

Lampada incasso a filo muro da parete e soffitto con doppia asta orientabile realizzata in trafilata di ottone sezione 7x7mm. Disponibile in varie altezze e diverse potenze. Illuminazione a microstriscia LED ad alta efficienza luminosa.

Necessita di alimentatore e controcassa, non inclusi.*

Finiture colore:

verniciato bianco (BI), verniciato nero (NE), cromo (CR), oro opaco (OR).

Alimentatori, controcasse e specifiche tecniche a pag. 140-141.

Built-in flush wall or ceiling lamp with double adjustable drawn brass rod, 7x7 mm section.

Available in various dimensions and power levels. Lighting by high luminous efficiency LED micro-strip. **Requires power supply unit and wall housing, which is not included.***

Available in:

white varnish (BI), black varnish (NE), chrome (CR), brushed gold (OR).

Power adapters, wall housing and technical specifications on page 140-141.

Modello depositato

Registered design

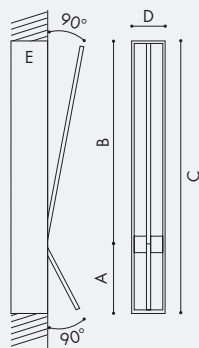

137



Art.	W	V	Lumen	°K led	A cm	B cm	C cm	D cm	E cm	∅7 cm
SPILLO2i.50	9,24	12	770	3000	21,5	51,5	75	3,3	3	8,2x75,6
SPILLO2i.80	14,52	12	1210	3000	31,5	81,5	115	3,3	3	8,2x115,6

LED Disponibili a richiesta nella temperatura colore 2700 °K





ACCESSORI / ACCESSORIES

tabelle alimentatori - power supply data

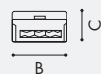

Art.	Output V	W	A mm	B mm	C mm
Alim.1	12	4,2	59	42	20

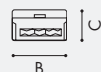
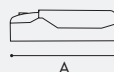
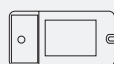
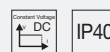

Art.	Output V	W	A mm	B mm	C mm
Alim.2	12	8,4	70	42	20

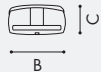
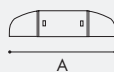
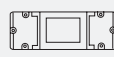
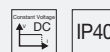

Art.	Output V	W	A mm	B mm	C mm
Alim.3	12	16	138	40	28

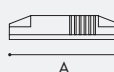
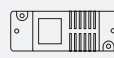
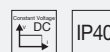

Art.	Output V	W	A mm	B mm	C mm
Alim.5	12	48	206	51	36

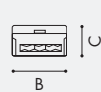
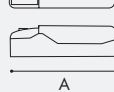
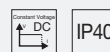

Art.	Output V	W	A mm	B mm	C mm
Alim.EFUR.25dim	12	25	145	55	20



Schema di montaggio controcasse per cartongesso / Assembly instructions for outer casing plasterboard

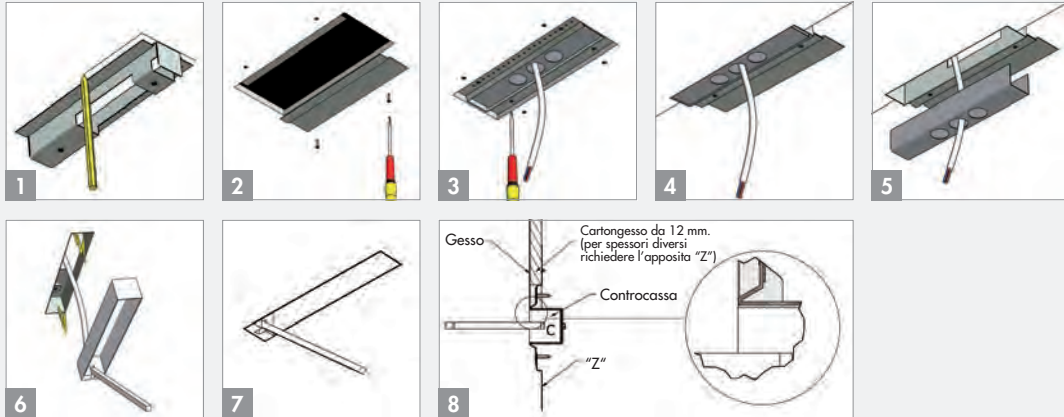

Codici controcasse cartongesso / Codes wall housing for plasterboard

	Cod.		Cod.
SPILLO1i.12	CA.13	SPILLO2i.50	CA.75
SPILLO1i.22	CA.23	SPILLO2i.80	CA.115
SPILLO1i.32	CA.33		
SPILLO1i.42	CA.43		
SPILLO1i.52	CA.53		
SPILLO1i.62	CA.63		
SPILLO1i.82	CA.83		

Schema di montaggio controcasse per laterizio / Assembly instructions for outer casing masonry wall

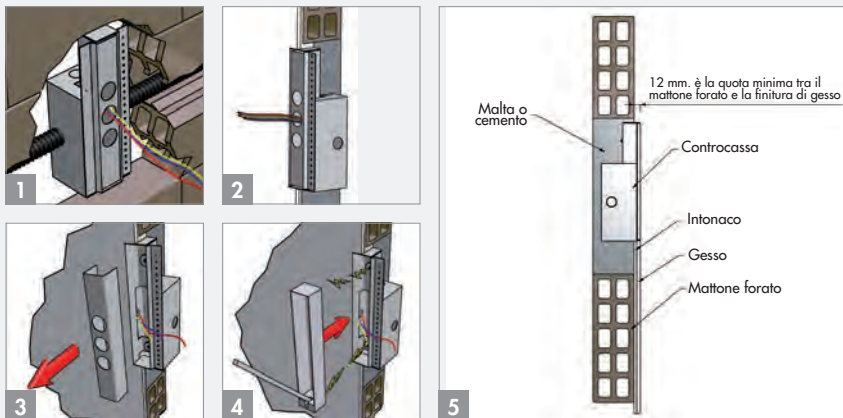

Codici controcasse laterizio / Codes wall housing for masonry wall

	Cod.		Cod.
SPILLO1i.12	CA.13L	SPILLO2i.50	CA.75L
SPILLO1i.22	CA.23L	SPILLO2i.80	CA.115L
SPILLO1i.32	CA.33L		
SPILLO1i.42	CA.43L		
SPILLO1i.52	CA.53L		
SPILLO1i.62	CA.63L		
SPILLO1i.82	CA.83L		

PROFONDITÀ CONTROCASSA 7 CM



SPILLO

Marco Pagnoncelli - 2012

Lampada da parete e soffitto ad incasso con asta orientabile realizzata in trafilata di ottone sezione 7x7 mm. Disponibile in varie misure e diverse potenze. Illuminazione con microstriscia LED ad alta efficienza luminosa.

Necessita di alimentatore e controcassa non inclusi.*

Finiture colore:

verniciato bianco (BI), verniciato nero (NE), cromo (CR), oro opaco (OR).

Alimentatori, controcasse e specifiche tecniche a pag. 146-147.

Built-in wall and ceiling lamp with adjustable drawn brass rod, 7x7 mm section. Available in various dimensions and power levels. Lighting by high luminous efficiency LED micro-strip. **Requires power supply unit and wall housing, which is not included.***

Available in:

white varnish (BI), black varnish (NE), chrome (CR), brushed gold (OR).

Power supply units, wall housings and technical specifications on page 146-147.

Modello depositato

Registered design

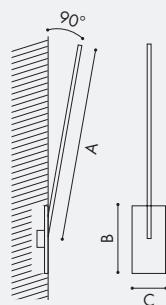

143

Art.	W	V	Lumen	°K led	A cm	B cm	C cm	Ø7 cm
SPILLO1iE.20	2,64	12	220	3000	20	10	5	10x15
SPILLO1iE.30	3,96	12	330	3000	30	10	5	10x15
SPILLO1iE.40	4,80	12	440	3000	40	10	5	10x15
SPILLO1iE.50	6,60	12	550	3000	50	10	5	10x15
SPILLO1iE.60	7,92	12	660	3000	60	10	5	10x15
SPILLO1iE.80	10,56	12	880	3000	80	10	5	10x15

LED Disponibili a richiesta nella temperatura colore 2700 °K







ACCESSORI / ACCESSORIES

tabelle alimentatori - power supply data

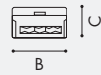

Art.	Output V	W	A mm	B mm	C mm
Alim.1	12	4,2	59	42	20



IP40

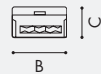
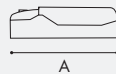

Art.	Output V	W	A mm	B mm	C mm
Alim.2	12	8,4	70	42	20



IP40

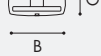
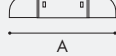
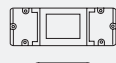

Art.	Output V	W	A mm	B mm	C mm
Alim.3	12	16	138	40	28



IP40

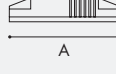
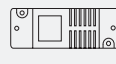

Art.	Output V	W	A mm	B mm	C mm
Alim.5	12	48	206	51	36



IP40

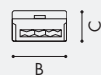
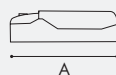

Art.	Output V	W	A mm	B mm	C mm
Alim.EFUR.25dim	12	25	145	55	20



IP40

Schema di montaggio controcasse per cartongesso / Assembly instructions for outer casing plasterboard



Schema di montaggio controcasse per cartongesso / Assembly instructions for outer casing plasterboard

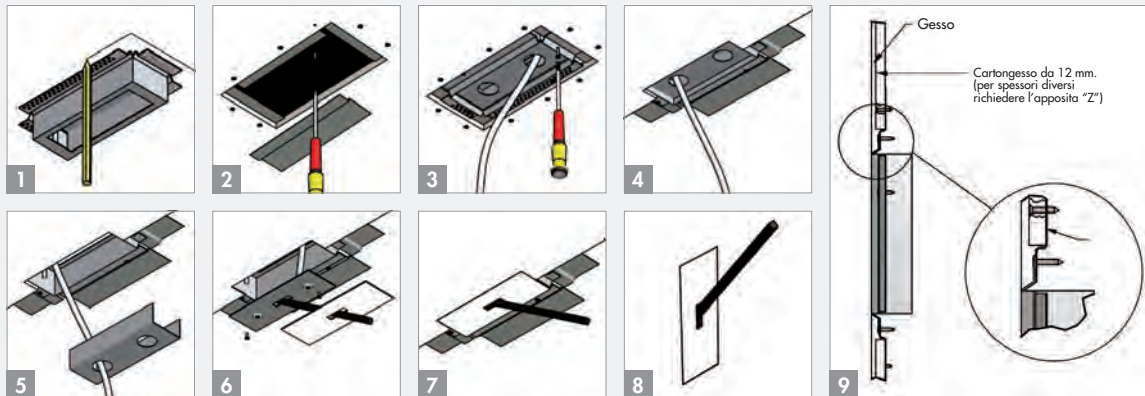

Codici controcasse cartongesso / Codes wall housing for plasterboard

Cod.

SPILLO1iE.20	CA.15
SPILLO1iE.30	CA.15
SPILLO1iE.40	CA.15
SPILLO1iE.50	CA.15
SPILLO1iE.60	CA.15
SPILLO1iE.80	CA.15

147

Schema di montaggio controcasse per laterizio / Assembly instructions for outer casing masonry wall

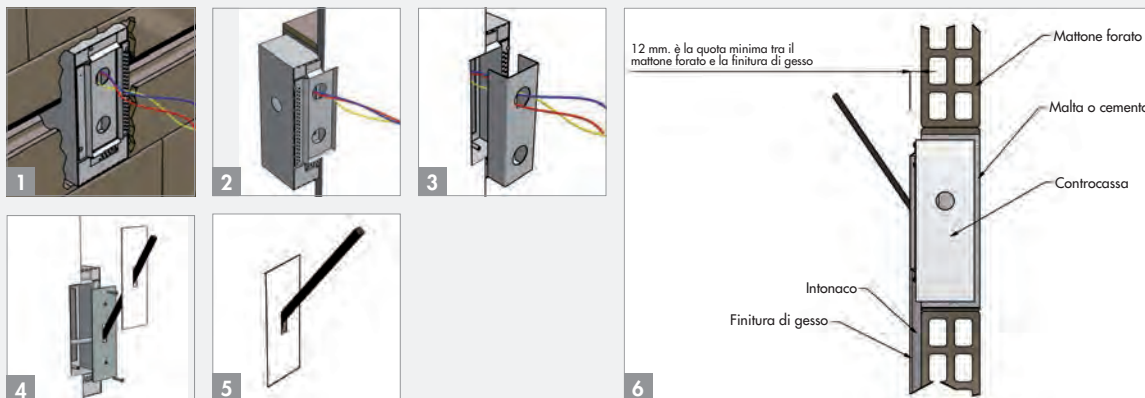

Codici controcasse laterizio / Codes wall housing for masonry wall

Cod.

SPILLO1iE.20	CA.15L
SPILLO1iE.30	CA.15L
SPILLO1iE.40	CA.15L
SPILLO1iE.50	CA.15L
SPILLO1iE.60	CA.15L
SPILLO1iE.80	CA.15L





150

parete | soffitto



SPILLO

Marco Pagnoncelli - 2012

Lampada da parete e soffitto con asta orientabile realizzata in trafilata di ottone sezione 7x7 mm. Disponibile in varie altezze e diverse potenze. Illuminazione a microstriscia LED ad alta efficienza luminosa. Completa di alimentatore. Finiture colore: verniciato bianco (BI), verniciato nero (NE), bianco+cromo (BI+CR), oro opaco (OR). Alimentatore incluso.

Wall and ceiling lamp with adjustable drawn brass rod, 7x7 mm section. Available in various dimensions and power levels. Lighting by high luminous efficiency LED micro-strip. Complete with power supply unit. Available in: white varnish (BI), black varnish (NE), white+chrome (BI+CR), brushed gold (OR). Driver included.

Modello depositato

Registered design

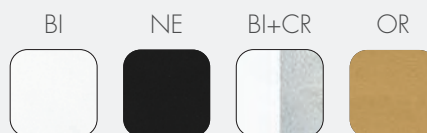

151

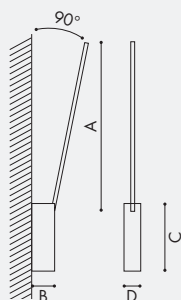

Art.	W	V	Lumen	°K led	A cm	B cm	C cm	D cm
SPILLO1.40	4,80	220-240	440	3000	40	6	10	3,2
SPILLO1.50	6,60	220-240	550	3000	50	6	10	3,2
SPILLO1.60	7,92	220-240	660	3000	60	6	10	3,2
SPILLO1.80	10,56	220-240	880	3000	80	6	17	3,2

LED Disponibili a richiesta nella temperatura colore 2700 °K



SPILLO

Marco Pagnoncelli - 2012

Lampada da parete e soffitto a doppia asta orientabile realizzata in trafilata di ottone sezione 7x7 mm.

Disponibile in varie altezze e diverse potenze.

Illuminazione a microstriscia LED ad alta efficienza luminosa.

Completa di alimentatore.

Finiture colore: verniciato bianco (BI), verniciato nero (NE), bianco+cromo (BI+CR), oro opaco (OR).

Alimentatore incluso.

Wall and ceiling lamp with double adjustable drawn brass rod, 7x7 mm section.

Available in various dimensions and power levels.

Lighting by high luminous efficiency LED micro-strip.

Complete with power supply unit. Available in: white

varnish (BI), black varnish (NE), white+chrome (BI+CR), brushed gold (OR).

Driver included.

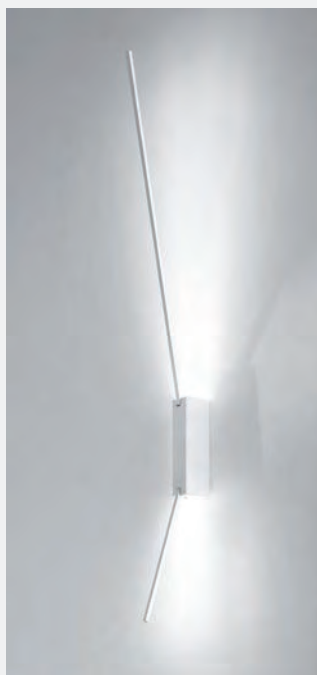

Modello depositato

Registered design

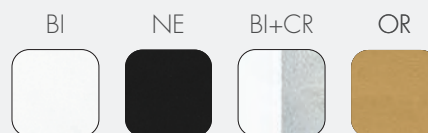

153

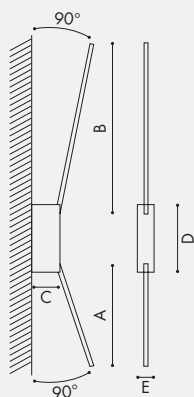

Art.	W	V	Lumen	°K led	A cm	B cm	C cm	D cm	E cm
SPILLO2.40	7,44	220-240	660	3000	20	40	6	12	3,2
SPILLO2.60	11,88	220-240	990	3000	30	60	6	19	3,2
SPILLO2.80	15,36	220-240	1320	3000	40	80	6	19	3,2

LED Disponibili a richiesta nella temperatura colore 2700 °K





SPILLO

Marco Pagnoncelli - 2012

Lampada a sospensione ad aste quadrate 7x7mm. Illuminazione diretta o indiretta ottenuta tramite semplice torsione dell'asta quadrata. Illuminazione con microstriscia LED ad alta efficienza luminosa alimentata a 12V. Alimentatore compreso. Finiture colore: bianco laccato a liquido (BI), cromo (CR), oro opaco (OR). Alimentatore incluso.

Suspension lamp with stem-shaped lights 7x7mm. Different length to intertwine according to the environment. Direct or indirect light on each single light with a simple twisting movement. High efficiency Micro LED strip lighting supplied at 12V. Power supply included. Available in: white liquid enamel (BI), chrome (CR), brushed gold (OR). Driver included.

Modello depositato



Registered design

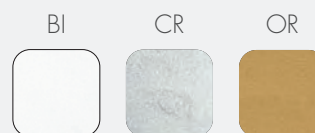
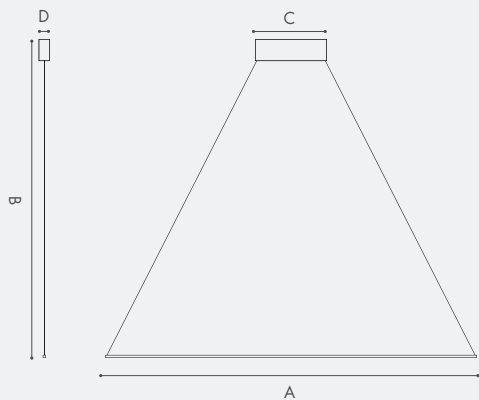

155

Art.	W	V	Lumen	°K Led	A cm	B cm	C cm	D cm
SPILLO100	13,20	220-240	1100	3000	104	150	20	3

LED Disponibili a richiesta nella temperatura colore 2700 °K





SPILLO

Marco Pagnoncelli - 2012

Lampada a sospensione ad aste quadrate 7x7mm. di diversa lunghezza intrecciate tra loro a discrezione e gusto del cliente. Illuminazione diretta o indiretta su ogni singola asta con un semplice movimento di torsione. Illuminazione con microstriscia LED ad alta efficienza luminosa alimentata a 12V. Alimentatore compreso. Finiture colore: bianco laccato a liquido (BI), cromo (CR), oro opaco (OR). Alimentatore incluso.

Suspension lamp with stem-shaped lights 7x7mm. Different length to intertwine according to the environment. Direct or indirect light on each single light with a simple twisting movement. High efficiency Micro LED strip lighting supplied at 12V. Power supply included. Available in: white liquid enamel (BI), chrome (CR), brushed gold (OR). Driver included.

Modello depositato

Registered design

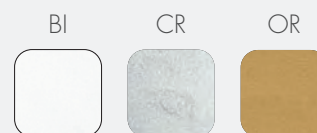
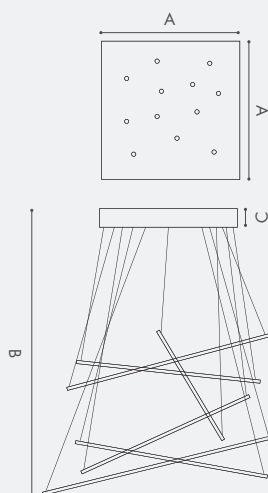

157

Art.	W	V	Lumen	°K Led	A cm	B cm	C cm	BACCHETTE
SPILLO6	47	220-240	3960	3000	30	150	4	2x40 cm 2x60 cm 2x80 cm

LED Disponibili a richiesta nella temperatura colore 2700 °K





SPILLO

Marco Pagnoncelli - 2012

Lampada a stelo quadrato 7x7mm appesa a soffitto tramite fili trasparenti in nylon con movimento ascendente e discendente. Illuminazione con microstriscia LED ad alta efficienza luminosa alimentata a 12V. Alimentatore compreso. Finiture colore: bianco laccato a liquido (BI), cromo (CR), oro opaco (OR). Alimentatore incluso.

Ceiling lamp with stem-shaped lights 7x7mm, suspended thanks to nylon cables with up & down direction. High efficiency Micro LED strip lighting supplied at 12V. Power supply included. Available in: white liquid enamel (BI), chrome (CR), brushed gold (OR). Driver included.

Modello depositato

Registered design

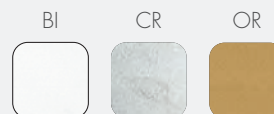

159

Art.	W	V	Lumen	°K Led	A cm	B cm	C cm
SPILLO170.ST	20	220-240	1650	3000	max 300	170	2,5

LED Disponibili a richiesta nella temperatura colore 2700 °K





CORNICE



CORNICE

Marco Pagnoncelli - 2013

Lampada a parete di forma quadrata fissa a illuminazione indiretta con microstriscia LED ad alta efficienza luminosa alimentata a 12V. Alimentatore compreso.

Wall lamp with fixed square-shaped body for indirect lighting. High efficiency Micro LED strip lighting supplied at 12V. Power supply included.

Modello depositato

Registered design



BI

TO

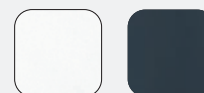

163

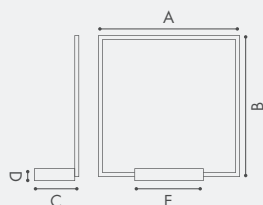

Art.	W	V	Lumen	° K Led	A cm	B cm	C cm	D cm	E cm
CORNICE 25AP	11	220-240	916	3000	25	28	10	3	12
CORNICE 35AP	16	220-240	1356	3000	35	38	10	3	17

LED Disponibili a richiesta nella temperatura colore 2700 °K



CORNICE

Marco Pagnoncelli - 2013

Lampada a sospensione a doppio quadrato con possibilità di luce diretta oppure luce diretta+indiretta, altezza da stabilire al momento del posizionamento nell'ambiente, illuminata con microstrisce LED ad alta efficienza luminosa alimentata a 12V. Alimentatore compreso.

Suspension lamp with double square-shaped body for either direct or direct+indirect lighting. Different height to define according to the environment. High efficiency Micro LED strip lighting supplied at 12V. Power supply included.

Modello depositato

Registered design



165

BI TO

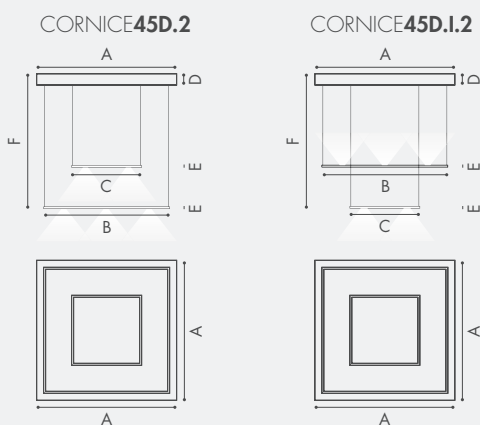
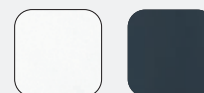

Art.	W	V	Lumen	° K Led	A cm	B cm	C cm	D cm	E cm	F cm
CORNICE45D.2	32,5	220-240	2712	3000	50	45	25	4	0,7	170
CORNICE45D.I.2	32,5	220-240	2712	3000	50	45	25	4	0,7	170

LED Disponibili a richiesta nella temperatura colore 2700 °K



CORNICE

Marco Pagnoncelli - 2013

Lampada a sospensione a tre quadrati con luce diretta e indiretta, altezza da stabilire al momento del posizionamento nell'ambiente, illuminata da microstrisce LED ad alta efficienza luminosa alimentata a 12V. Alimentatore compreso.

Suspension lamp with 3 squares for either direct or indirect lighting. Different height to define according to the environment. High efficiency Micro LED strip lighting supplied at 12V. Power supply included.

Modello depositato

Registered design

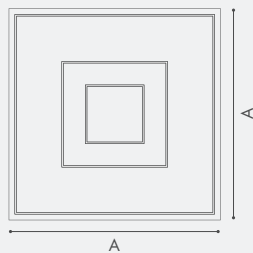
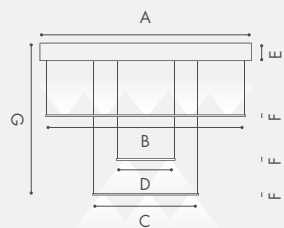

167



Art.	W	V	Lumen	°K led	A cm	B cm	C cm	D cm	E cm	F cm	G cm
CORNICE85.3	74,5	220-240	7178	3000	90	85	45	25	4	0,7	170

LED Disponibili a richiesta nella temperatura colore 2700 °K





CRISTALGLOB



CRISTALGLOB

Marco Pagnoncelli - 2022

Sospensione composta da rosone in alluminio e pendenti in cristallo di Murano.

Possibilità di montare sul rosone da 4 a 14 pendenti.

I nottolini passacavo permettono grande creatività nell'installazione
Disponibile anche con temperatura di colore 2700°K
Alimentatore dimmerabile TRIAC

Modello depositato

Suspension composed by a canopy and hanging crystal spheres from Murano.

From 4 up to 14 spheres can be connected to the canopy.

Cordgrips allow extreme creativity during the installation
Also available with 2700° K color temperature
TRIAC dimmable driver

Registered design

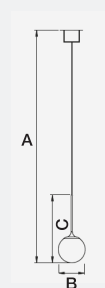

Art.	W	V	Lumen	°K led	A cm	B cm	C cm
CRISTALGLOB S15	9	220-240	1430	3000	150	15	40
CRISTALGLOB S33	13	220-240	2080	3000	180	33	60

LED disponibili a richiesta nella temperatura colore 2700 °K

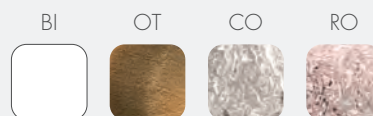







CRISTALGLOB

Marco Pagnoncelli - 2022

Lampada da tavolo composta da corpo in alluminio e cristalli di Murano

Disponibile anche con temperatura di colore 2700° K
Dimmer cablato.

Modello depositato

Table lamp with body in aluminium and crystal spheres from Murano

Also available with 2700°K color temperature
TRIAC dimmable cordset.

Registered design

175

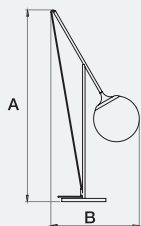
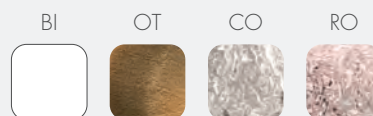

Art.	W	V	Lumen	°K led	A cm	B cm
CRISTALGLOB LP DIMMERABILE	9	220-240	1440	3000	60	28

LED disponibili a richiesta nella temperatura colore 2700 °K



CRISTALGLOB

Marco Pagnoncelli - 2022

Lampada da parete composta da corpo in alluminio e cristalli di Murano.

Disponibile anche con temperatura di colore 2700° K. Alimentatore dimmerabile TRIAC incluso

Modello depositato

Wall lamp with body in aluminium and crystal spheres from Murano

Also available with 2700°K color temperature. TRIAC dimmable driver included

Registered design

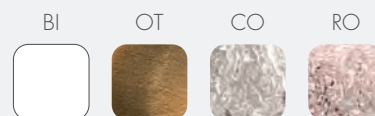
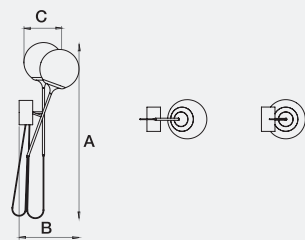

Art.	W	V	Lumen	°K led	A cm	B cm	C cm
CRISTALGLOB AP	9	220-240	1440	3000	40	20	15

LED disponibili a richiesta nella temperatura colore 2700 °K

178



terra

CRISTALGLOB

Marco Pagnoncelli - 2022

Lampada da terra composta da corpo in alluminio e cristalli di Murano.

Floor lamp with body in aluminium and crystal spheres from Murano.

Disponibile anche con temperatura di colore 2700° K.

Also available with 2700°K color temperature.

Dimmer cablato.

Dimmable cordset

Modello depositato

Registered design

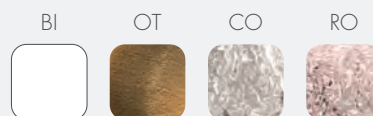
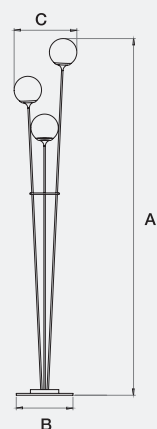

Art.	W	V	Lumen	°K led	A cm	B cm	C cm
CRISTALGLOB ST DIMMERABILE	36	220-240	5760	3000	190	30	35

LED disponibili a richiesta nella temperatura colore 2700 °K

ACCESSORI / ACCESSORIES

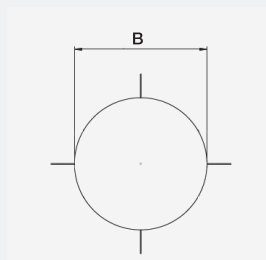

Art. ROSONE/CANOPY **4** W 37 V 220-240 A cm 4,5 B cm 30 ALIMENTATORE INCLUSO

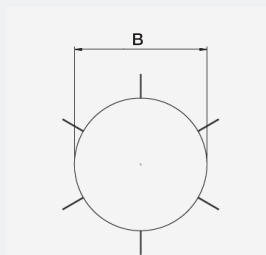

Art. ROSONE/CANOPY **6** W 55 V 220-240 A cm 4,5 B cm 30 ALIMENTATORE INCLUSO

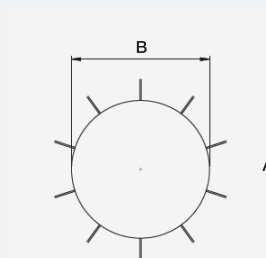

Art. ROSONE/CANOPY **10** W 92 V 220-240 A cm 5 B cm 40 ALIMENTATORE INCLUSO

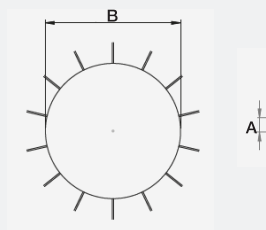

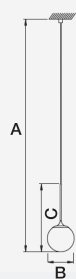

Art. ROSONE/CANOPY **14** W 130 V 220-240 A cm 5 B cm 40 ALIMENTATORE INCLUSO



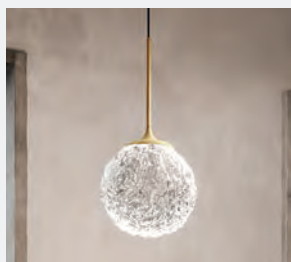

Art.	W	V	Lumen	°K led	A cm	B cm	C cm
KIT SFERA 15	9	220-240	1440	3000	400	15	40

COLORI / COLOURS





 cristallo/ottone
 cristal/satin brass
 (OT+CO)



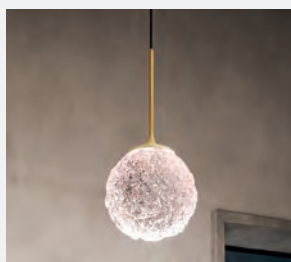

 cristallo/bianco
 cristal/white
 (BI+CO)



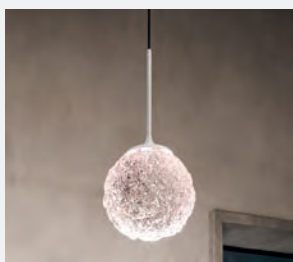

 rosa/ottone
 pink/satin brass
 (OT+RO)





 rosa/bianco
 pink/white
 (BI+RO)





EMISFERO



EMISFERO

Marco Pagnoncelli - 2009

Lampada a sospensione a luce diffusa. Diffusore in vetro bianco incamiciato triplex soffiato a bocca dalla forma irregolare, con finitura acidata. Supporto diffusore in alluminio tornito filettato, bianco opaco laccato a liquido. Sostegno con cavo in acciaio e filo elettrico in materiale plastico incolore da 120 cm. Rosone a soffitto a forma di lente bianco opaco laccato a liquido.

Diffuse light suspension lamp. Diffuser in hand-blown triplex multi-layer white glass of irregular shape, with acid-etched finish. Diffuser holder in turned, threaded aluminium, matt white liquid enamel finish. Suspension with steel cable and 120 cm colourless plastic electrical cable. Lens-shaped ceiling plate, matt white liquid enamel finish.

Modello depositato

Registered design

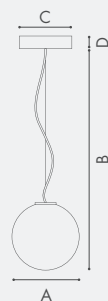

Art.	W	V	Attacco/Socket	A cm	B cm	C cm	D cm
EMISFERO 16S	1x60	220-240	G9	Ø16	130	Ø12,5	3
EMISFERO 33S	1x150	220-240	E27	Ø33	150	Ø12,5	3
EMISFERO 48S	1x200	220-240	E27	Ø48	170	Ø12,5	3

BI





EMISFERO

Marco Pagnoncelli - 2009

Lampada da tavolo o terra a luce diffusa. Diffusore in vetro bianco incamiciato triplex soffiato a bocca dalla forma irregolare, con finitura acidata. Base di appoggio e supporto diffusore in alluminio tornito filettato, bianco opaco laccato a liquido.

Diffuse-light table or floor lamp. Diffuser in hand-blown triplex multi-layer white glass of irregular shape, with acid-etched finish. Base and diffuser holder in turned, threaded aluminium, matt white liquid enamel finish.

Modello depositato

Registered design

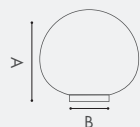

Art.	W	V	Attacco/Socket	A cm	B cm
EMISFERO 16LT	1x60	220-240	G9	Ø16	Ø8
EMISFERO 33LT	1x150	220-240	E27	Ø33	Ø12
EMISFERO 48LT	1x200	220-240	E27	Ø48	Ø16

BI





EMISFERO

Marco Pagnoncelli - 2009

Lampada da parete o soffitto a luce diffusa. Diffusore in vetro bianco incamiciato triplex soffiato a bocca dalla forma irregolare, con finitura acidata. Base di appoggio e supporto diffusore in alluminio tornito filettato, bianco opaco laccato a liquido.

Diffuse-light wall or ceiling lamp. Diffuser in hand-blown triplex multi-layer white glass of irregular shape, with acid-etched finish. Base and diffuser holder in turned, threaded aluminium, matt white liquid enamel finish.

Modello depositato

Registered design



BI



189

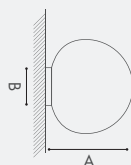

Art.	W	V	Attacco/Socket	A cm	B cm
EMISFERO 16	1x60	220-240	G9	Ø16	Ø6
EMISFERO 33	1x150	220-240	E27	Ø33	Ø10
EMISFERO 48	1x200	220-240	E27	Ø48	Ø14





CANALETTO



CANALETTO

Marco Pagnoncelli - 2017

Collezione di lampade a sospensione con struttura in metallo e diffusori in vetro soffiato da maestri Muranesi. Fornita ad emissione di luce indiretta con LED 220V che non necessitano di alimentatore. Finiture colore: verniciato peltro con diffusore fumè (PT+FE'), verniciato bronzo spazzolato con diffusore vetro cristallo (BS+CO). Disponibile nella temperatura colore LED 3000 °K e 2700 °K

A collection of suspension lamps with metal structure and Murano blown glass diffusers. Indirect light emission with LED 220V, no power supply needed.

Color finishing: powder painted with smoked diffuser (PT+FE'), brushed bronze painted with crystal glass diffuser (BS+CO). Available with 3000°K and 2700°K LED color temperature

Modello depositato

Registered design



PT+FE'



BS+CO

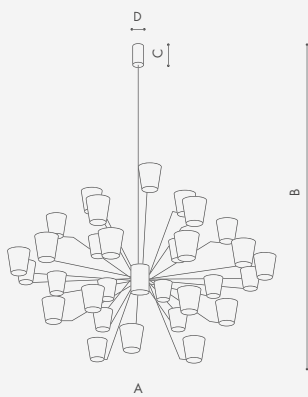

KIT FISSAGGIO
MAGGIORATO

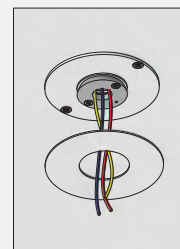

COD. **OP2**

Art.	W	V	Lumen	°K led	A cm	B cm	C cm	D cm	E cm
CANALETTO 30S	135	220-240	10500	3000	125	135	83	10	6
CANALETTO 18S	81	220-240	6300	3000	90	102	60	10	6

LED Disponibili a richiesta nella temperatura colore 2700 °K



CANALETTO

Marco Pagnoncelli - 2017

Collezione di lampade da parete con struttura in metallo e diffusori in vetro soffiato da maestri Muranesi. Fornita ad emissione di luce indiretta con LED 220V che non necessitano di alimentatore. Finiture colore: verniciato petro con diffusore fumè (PE+FE'), verniciato bronzo spazzolato con diffusore vetro cristallo (BS+CO). Disponibile nella temperatura colore LED 3000 °K e 2700° K

A collection of wall lamps with metal structure and Murano blown glass diffusers. Indirect light emission with LED 220V, no power supply needed. Color finishing: powder painted with smoked diffuser (PE+FE), brushed bronze painted with crystal glass diffuser (BS+CO). Available with 3000°K and 2700°K LED color temperature

Modello depositato

Registered design



BS+CO



PT+FE

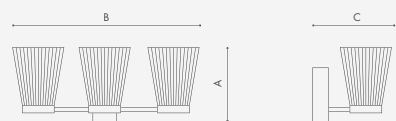

Art.	W	V	Lumen	°K led	A cm	B cm	C cm
CANALETTO 3AP	13,5	220-240	1050	3000	9	43	12
CANALETTO AP	4,5	220-240	350	3000	9	10	12

LED Disponibili a richiesta nella temperatura colore 2700 °K





GRU



GRU

Marco Pagnoncelli - 2007

Lampada da terra a luce diffusa.
Base in ferro tornito con finitura acciaio naturale e nero, struttura tubolare regolabile in altezza e girevole a 280°, con finiture in colore ottone satinato (OT), alluminio satinato (AS) e in cromo galvanico (CR).
Paralume in stoffa tramata nera (NE).

Floor lamp with diffused lighting.
Base in turned iron with natural steel and black finish, tubular structure adjustable in height and a 280°-degree turning radius, with finishes in satin brass (OT), brushed aluminium (AS) and chrome (CR) colour. Lampshade in black textured fabric (NE).



Modello depositato



Registered design

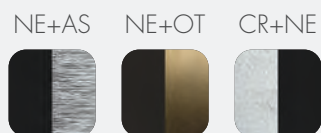

199

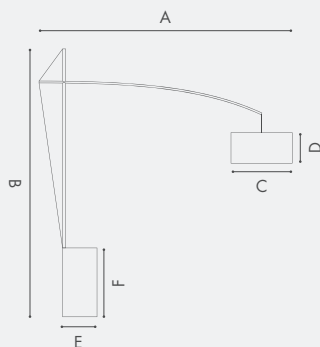

Art.	W	V	Attacco/Socket	A cm	B cm	C cm	D cm	E cm	F cm
GRUST	1x150 max	220-240	E27	200	230	Ø40	18	Ø22	50





REVERSE



RU+FO



BI+FO



BI+BI



NE+BI

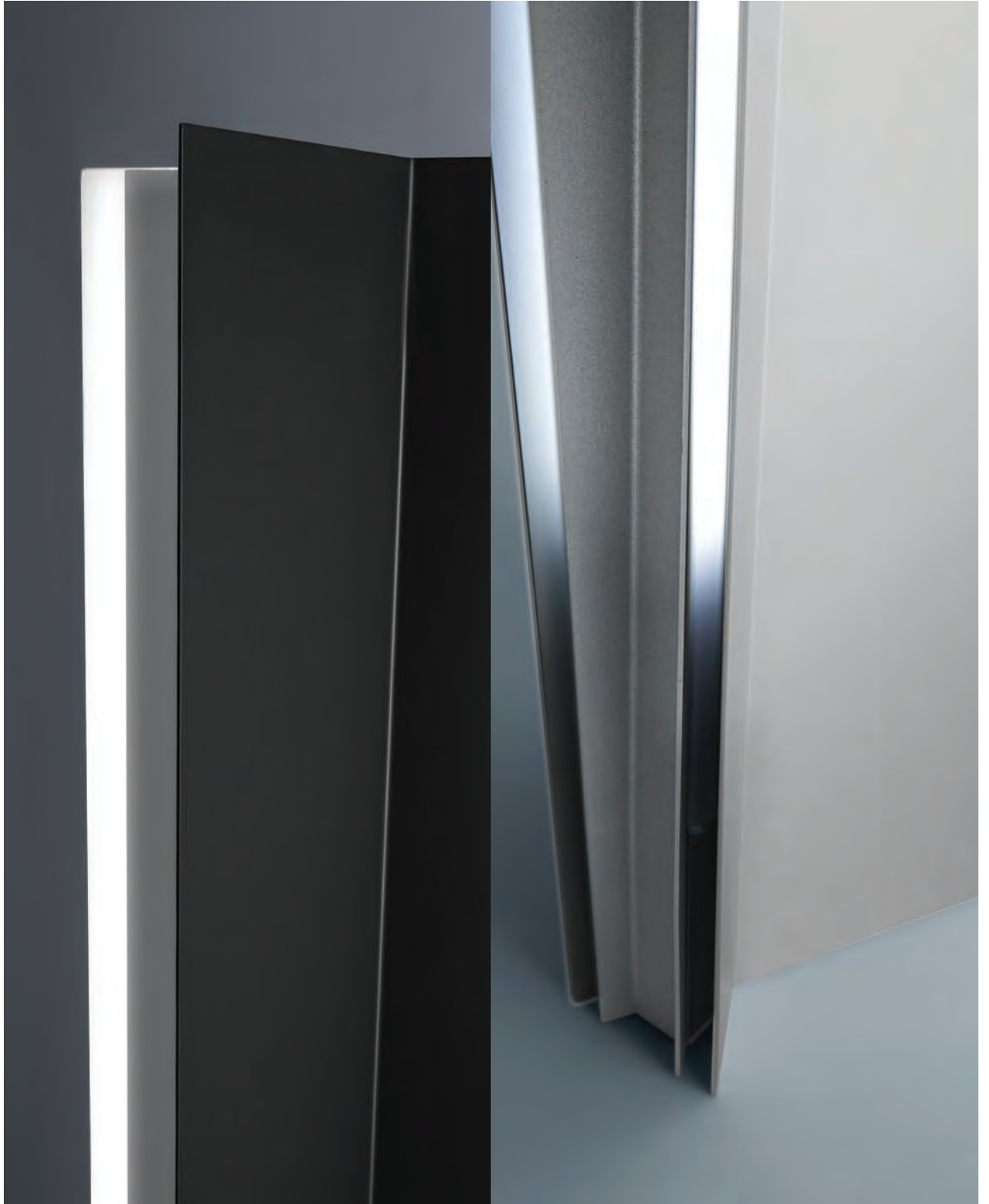

REVERSE

Marco Pagnoncelli - 2015

Lampada da terra dal design minimal realizzata in alluminio piegato dalle facce speculari dalle quali si ottengono illuminazione d'atmosfera nella parte frontale e d'ambiente da quella posteriore.
Illuminazione ad alta resa con strisce di led 24V.
Alimentatore compreso.
Disponibile nella temperatura colore LED 3000 °K e 2700 °K.

FLOOR LAMP
A floor lamp of essential design made in bent aluminium. Its mirror-like surfaces give atmosphere lighting in the front side and ambient lighting on its rear.
The lighting is highly efficient thanks to 24V LED stripes. Driver included.
Available with 3000 °K or 2700 °K LED colour temperature.

Modello depositato

Registered design

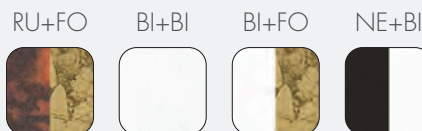

205

Art.		W	V	Lumen	°K led	A cm	B cm	C cm	D cm
REVERSE DIM	front	38	220-240	6837	3000	18	182	16	8

LED Disponibili a richiesta nella temperatura colore 2700 °K





OLIMPIA



OLIMPIA

Mario Ornaghi
Marco Pagnoncelli - 2017

Serie di sospensioni in alluminio tornito nelle varianti a luce diretta/indiretta o solo luce diretta con LED 220V che non necessitano di alimentatore. Disponibili nelle finiture bianco (BI), bianco+foglia oro (BI+FO), nero+bianco (NE+BI), nero+foglia rame (NE+FR). Disponibile nella temperatura colore LED 3000 °K e 2700 °K.

Turned aluminium suspension lamp available with direct/indirect or only direct light beam, LED 220V with no need of driver. Color finishing white (BI), white+gold leaf (BI+FO), black+white (NE+BI), black+copper leaf (NE+FR). Available with 3000°K and 2700°K LED color temperature.

Modello depositato



Registered design

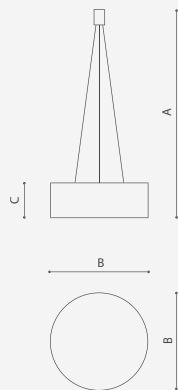
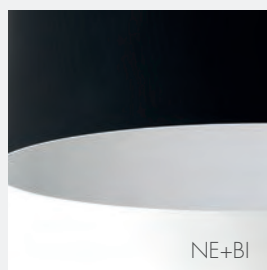

Art.	W	V	Lumen	°K led	A cm	B cm	C cm
OLIMPIA 55S2	40	220-240	3920	3000	170	55	20
OLIMPIA 55S1	20	220-240	1960	3000	170	55	20

LED Disponibili a richiesta nella temperatura colore 2700 °K

KIT FISSAGGIO
MAGGIORATO

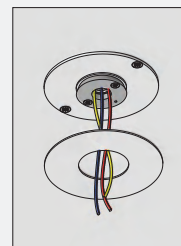

COD. **OP2**







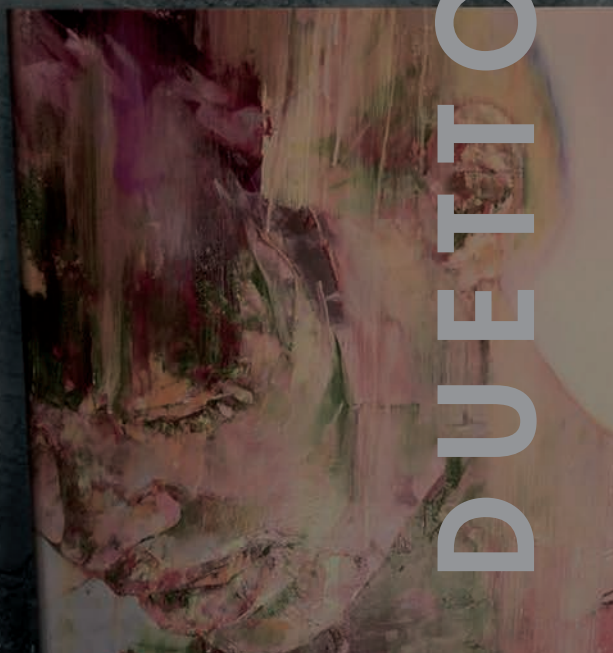

DUETTO

214

sospensione



DUETTO

Mario Ornaghi - 2022

Sospensione in alluminio tornito realizzata in diverse finiture di colore.
Illuminazione a led indiretto con un ottimo confort luminoso conferito dall'anello luminoso che proietta la luce verso l'interno della lampada.

Modello depositato

Turned aluminium suspension made with different finishings. Indirect LED lighting for a high visual comfort, given by a light emitting ring with beam oriented towards the inside reflector

Registered design

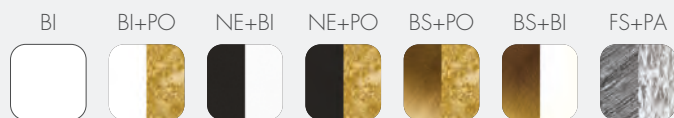

Art.	W	V	Lumen	°K led	A cm	B cm
DUETTO 55 G	25,2	220-240	3278	3000	200	55
DUETTO 35 G	13,5	220-240	1784	3000	200	35

DIMMERABILE TRIAC

LED Disponibili a richiesta nella temperatura colore 2700 °K



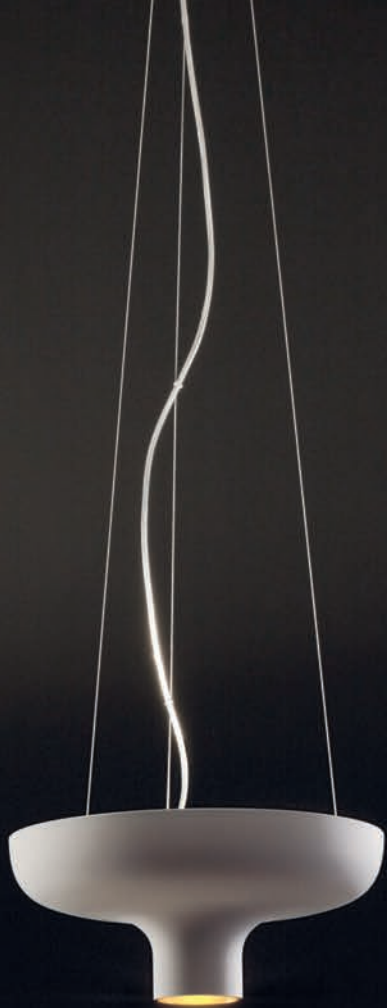



DUETTO

Mario Ornaghi
Marco Pagnoncelli - 2017

Lampada a sospensione in alluminio tornito disponibile in 2 misure e differenti potenze luminose. Fornita ad emissione di luce diretta/inderetta con LED 220V che non necessitano di alimentatore. Finiture colore: verniciato bianco (BI), verniciato bianco+foglia oro (BI+FO), verniciato nero+bianco (NE+BI), verniciato nero+foglia rame (NE+FR). Disponibile nella temperatura colore LED 3000 °K e 2700 °K

Turned aluminium suspension lamp, available in 2 sizes and different wattages. Direct/indirect light emission with LED 220V, no power supply needed. Color finishing: white (BI), white+gold leaf (BI+FO), black+white (NE+BI), black+copper leaf (NE+FR). Available with 3000°K and 2700°K LED color temperature

Modello depositato

Registered design

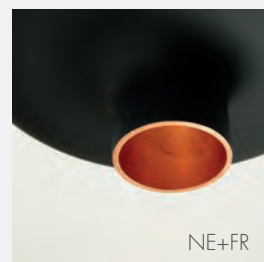
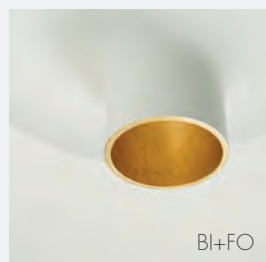

219

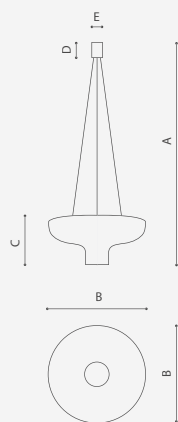

KIT FISSAGGIO
MAGGIORATO

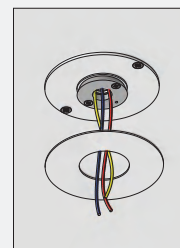

COD. **OP2**

Art.	W	V	Lumen	°K led	A cm	B cm	C cm	D cm	E cm
DUETTO 55S	40	220-240	3920	3000	180	55	25	8	6
DUETTO 38S	35	220-240	3400	3000	170	36	15	8	6

LED Disponibili a richiesta nella temperatura colore 2700 °K





LUÀ



LUÀ

Marco Pagnoncelli - 2015

LAMPADA DA PARETE

Collezione orientabile dal design essenziale protagonista il disco piatto prodotto in alluminio da 6 mm di spessore e dal profilo smussato, particolare questo che ne conferisce unicità e raffinatezza, anche nel dettaglio di colore.

Luminosità ad alta resa ottenuta utilizzando cobled 220V di ultima generazione che non necessitano di alimentatore. Disponibile nella temperatura colore LED 3000 °K e 2700 °K.

WALL LAMP

A collection of essential design. The only 6mm thick adjustable aluminium disc has a smooth profile: these characteristics enhance its class and uniqueness, enriched by the detail of finishings.

High efficiency and performance are granted by the use of 220V last generation cobled, with no driver needed.

Available with 3000 °K or 2700 °K LED colour temperature.

Modello depositato



Registered design

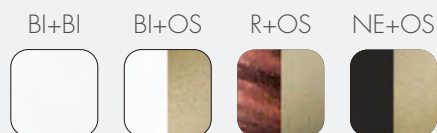

223

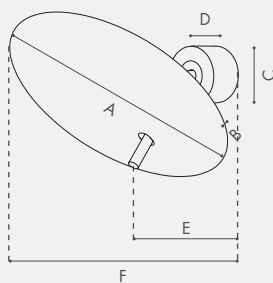

KIT FISSAGGIO
MAGGIORATO

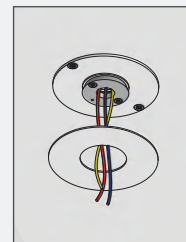

COD. **OP.2**

Art.	W	V	Lumen	°K led	A cm	B cm	C cm	D cm	E cm	F cm
LUÀ 30	20	220-240	1960	3000	Ø31	0,6	Ø6	4	18	max 37
LUÀ 20	20	220-240	1960	3000	Ø22	0,6	Ø6	4	14	max 27

LED Disponibili a richiesta nella temperatura colore 2700 °K







LUÀ

Marco Pagnoncelli - 2015

LAMPADA DA SOSPENSIONE
Collezione orientabile dal design
essenziale protagonista il disco
piatto prodotto in alluminio da
6 mm di spessore e dal profilo
smussato, particolare questo
che ne conferisce unicità e
raffinatezza, anche nel dettaglio
di colore.

Luminosità ad alta resa ottenuta
utilizzando cobled 220V di ultima
generazione che non necessitano
di alimentatore.

Disponibile nella temperatura
colore LED 3000 °K e 2700 °K.

SUSPENSION LAMP

A collection with an essential
design and adjustable light
source.

The only 6mm thick aluminium
disc has a smooth profile, to
enhance its class and uniqueness
even in the details of its colour.
High efficiency and performance
are granted by the use of 220V
last generation cobled, with no
driver needed.

Available with 3000 °K or 2700
°K LED colour temperature.

Modello depositato



Registered design

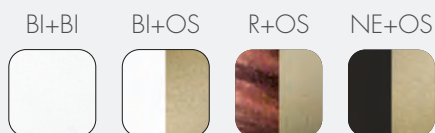
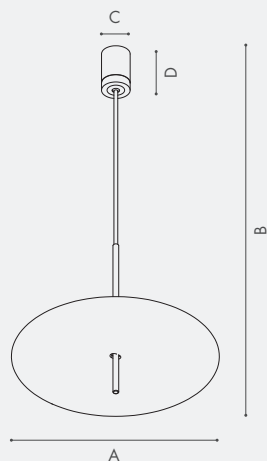

Art.	W	V	Lumen	°K led	A cm	B cm	C cm	D cm
LUÀ 60C	60	220-240	5880	3000	Ø60	60	Ø6	10

KIT FISSAGGIO
MAGGIORATO

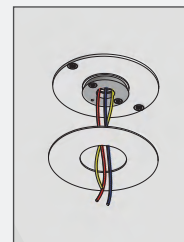

COD. OP.2

LED Disponibili a richiesta nella temperatura colore 2700 °K



LUÀ

Marco Pagnoncelli - 2015

LAMPADA DA SOSPENSIONE
Collezione orientabile dal design
essenziale protagonista il disco
piatto prodotto in alluminio da
6 mm di spessore e dal profilo
smussato, particolare questo
che ne conferisce unicità e
raffinatezza, anche nel dettaglio
di colore.

Luminosità ad alta resa ottenuta
utilizzando cobled 220V di ultima
generazione che non necessitano
di alimentatore.

Disponibile nella temperatura
colore LED 3000 °K e 2700 °K.

SUSPENSION LAMP

A collection with an essential
design and adjustable light
source.

The only 6mm thick aluminium
disc has a smooth profile, to
enhance its class and uniqueness
even in the details of its colour.
High efficiency and performance
are granted by the use of 220V
last generation cobled, with no
driver needed.

Available with 3000 °K or 2700
°K LED colour temperature.

Modello depositato



Registered design

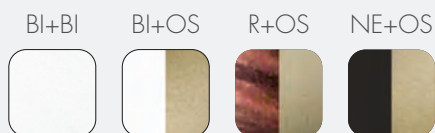
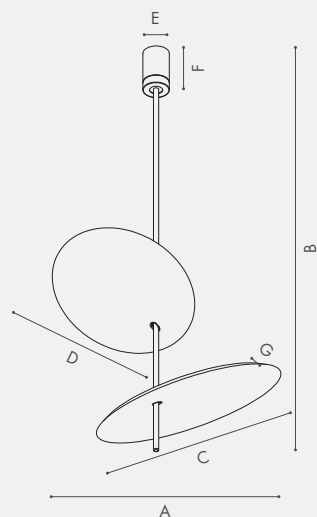

KIT FISSAGGIO
MAGGIORATO

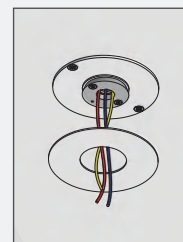

COD. **OP.2**

Art.	W	V	Lumen	°K led	A cm	B cm	C cm	D cm	E cm	F cm	G cm
LUÀ 2C	40	220-240	3920	3000	40	60	Ø31	Ø22	Ø6	10	0,6

LED Disponibili a richiesta nella temperatura colore 2700 °K







LUÀ

Marco Pagnoncelli - 2015

LAMPADA DA TERRA

Collezione orientabile dal design essenziale protagonista il disco piatto prodotto in alluminio da 6 mm di spessore e dal profilo smussato, particolare questo che ne conferisce unicità e raffinatezza, anche nel dettaglio di colore.

Luminosità ad alta resa ottenuta led 24V di ultima generazione che non necessitano di alimentatore.

Disponibile nella temperatura colore LED 3000 °K e 2700 °K.

FLOOR LAMP

A collection with an essential design and adjustable light source.

The only 6mm thick aluminium disc has a smooth profile, to enhance its class and uniqueness even in the details of its colour. High efficiency and performance are guaranteed by the use of 24V last generation led, with no driver needed.

Available with 3000 °K or 2700 °K LED colour temperature.

Modello depositato



Registered design

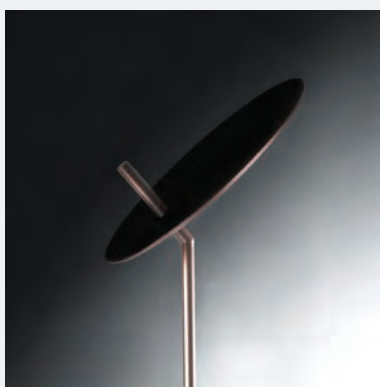
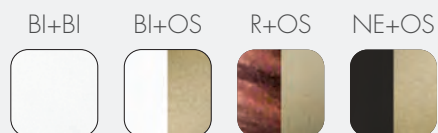

Art.	W	V	Lumen	°K led	A cm	B cm	C cm	D cm	E cm
LUÀ ST DIMMERABILE	22	220-240	3400	3000	Ø31	190	Ø15	35	160

LED Disponibili a richiesta nella temperatura colore 2700 °K







LUÀ

Marco Pagnoncelli - 2015

LAMPADA DA TAVOLO

Collezione orientabile dal design essenziale protagonista il disco piatto prodotto in alluminio da 6 mm di spessore e dal profilo smussato, particolare questo che ne conferisce unicità e raffinatezza, anche nel dettaglio di colore.

Luminosità ad alta resa ottenuta utilizzando cobled 220V di ultima generazione che non necessitano di alimentatore.

Disponibile nella temperatura colore LED 3000 °K e 2700 °K.

TABLE LAMP

A collection with an essential design and adjustable light source.

The only 6mm thick aluminium disc has a smooth profile, to enhance its class and uniqueness even in the details of its colour. High efficiency and performance are granted by the use of 220V last generation cobled, with no driver needed.

Available with 3000 °K or 2700 °K LED colour temperature.

Modello depositato



Registered design

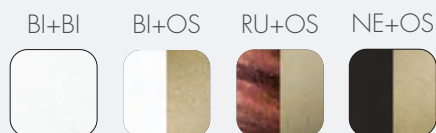
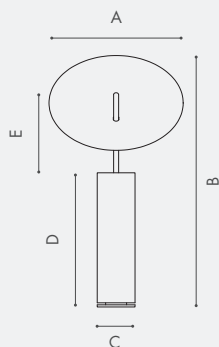

237

Art.	W	V	Lumen	°K led	A cm	B cm	C cm	D cm	E cm
LUÀ LG	20	220-240	1960	3000	Ø31	68	Ø9	32	18,5
LUÀ LP	15	220-240	1440	3000	Ø22	46	Ø6	22	11,5

DIMMERABILE

LED Disponibili a richiesta nella temperatura colore 2700 °K









GIÙUP



GIÙUP

Marco Pagnoncelli - 2015

LAMPADA DA TERRA

Collezione dal design retrò realizzata in alluminio tornito. Corpo lampada orientabile permette una illuminazione indiretta confortevole. Illuminazione a led ad alta resa e efficienza ottenuta utilizzando led 24V che non necessitano di alimentatore.

FLOOR LAMP

A collection with a classical design made of turned aluminium. The body of the fitting is adjustable for a comfortable indirect lighting. The 24V LEDs, highly performing and efficient, do not need any driver.

Modello depositato



Registered design

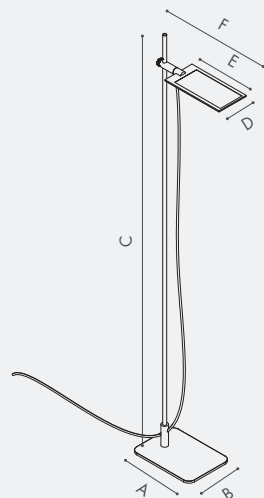

NE



BI



243

Art.	W	V	Lumen	°K led	A cm	B cm	C cm	D cm	E cm	F cm
GIÙUP ST DIM	29	220-240	4000	3000	32	23	197	15	30,2	38,2

LED Disponibili a richiesta nella temperatura colore 2700 °K

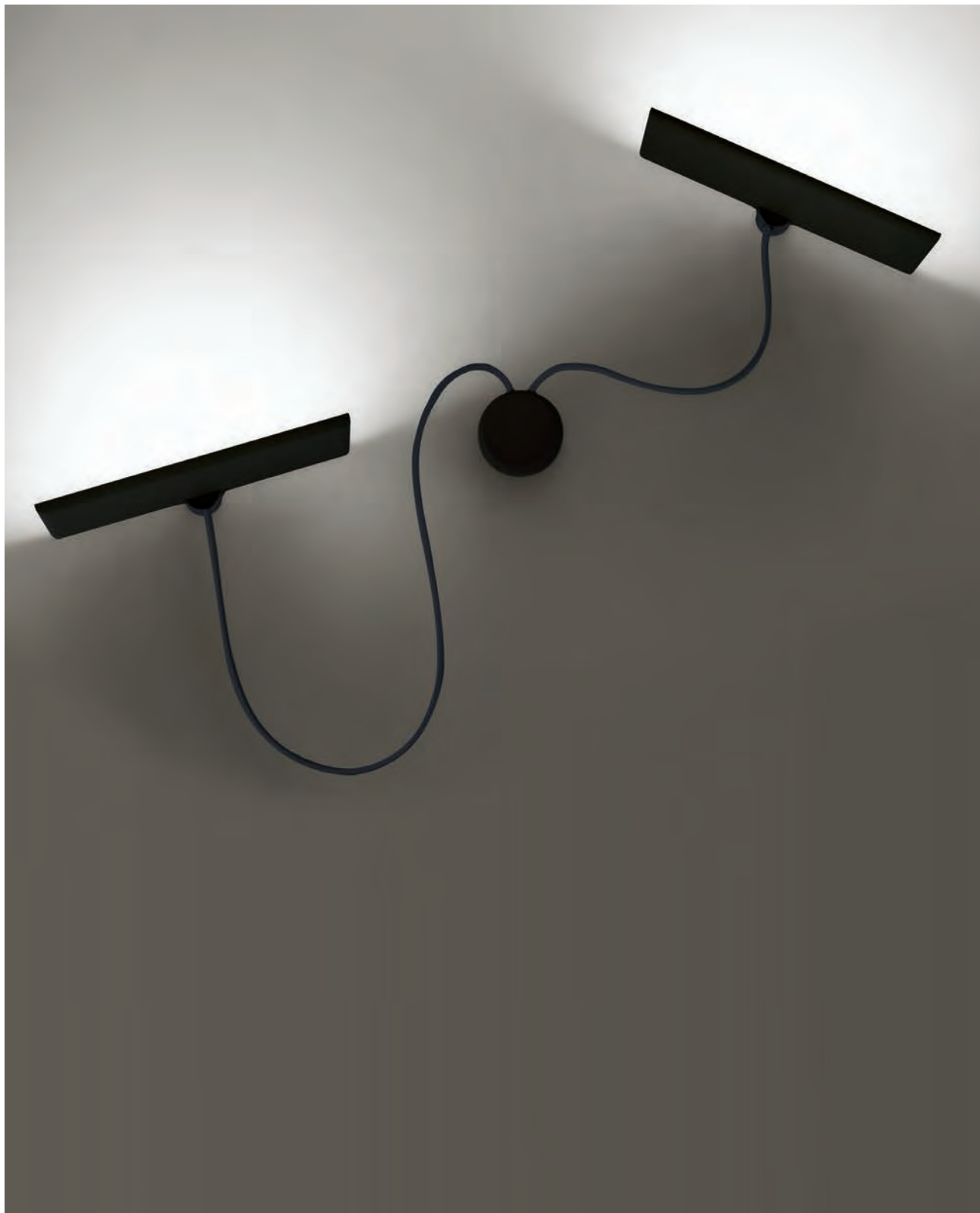

GIÙUP

Marco Pagnoncelli - 2015

LAMPADA DA PARETE

Collezione dal design retrò realizzata in alluminio tornito. Corpo lampada orientabile permette una illuminazione indiretta confortevole. Illuminazione a led ad alta resa e efficienza ottenuta utilizzando led 220V che non necessitano di alimentatore.

WALL LAMP

A collection with a classical design made of turned aluminium. The body of the fitting is adjustable for a comfortable indirect lighting. The 220V LED, highly performing and efficient, don't need any driver.

Modello depositato



Registered design

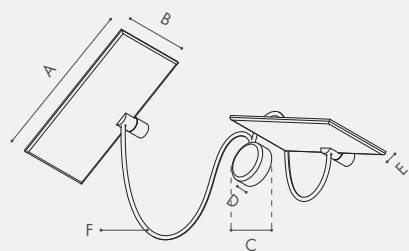

NE

BI



245

Art.	W	V	Lumen	°K led	A cm	B cm	C cm	D cm	E cm	F cm
GIÙUP APB 40.2	40	220-240	3800	3000	30,2	15	Ø8	2,5	1	80
GIÙUP APB 80.2	80	220-240	7600	3000	30,2	15	Ø8	2,5	1	80

LED Disponibili a richiesta nella temperatura colore 2700 °K

246

parete



GIÙUP

Marco Pagnoncelli - 2015

LAMPADA DA PARETE

Collezione dal design retrò realizzata in alluminio tornito. Corpo lampada orientabile permette una illuminazione indiretta confortevole. Illuminazione a led ad alta resa e efficienza ottenuta utilizzando led 220V che non necessitano di alimentatore.

WALL LAMP

A collection with a classical design made of turned aluminium. The body of the fitting is adjustable for a comfortable indirect lighting. The 220V LED, highly performing and efficient, don't need any driver.

Modello depositato



Registered design

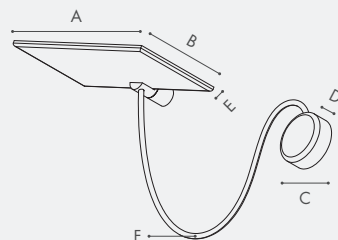

NE

BI



247

Art.	W	V	Lumen	°K led	A cm	B cm	C cm	D cm	E cm	F cm
GIÙUP APB 20	20	220-240	1900	3000	30,2	15	Ø8	2,5	1	80
GIÙUP APB 40	40	220-240	3800	3000	30,2	15	Ø8	2,5	1	80

LED Disponibili a richiesta nella temperatura colore 2700 °K



GIÙUP

Marco Pagnoncelli - 2015

LAMPADA DA PARETE

Collezione dal design retrò realizzata in alluminio tornito. Corpo lampada orientabile permette una illuminazione indiretta confortevole. Illuminazione a led ad alta resa e efficienza ottenuta utilizzando led 220V che non necessitano di alimentatore.

WALL LAMP

A collection with a classical design made of turned aluminium. The body of the fitting is adjustable for a comfortable indirect lighting. The 220V LED, highly performing and efficient, don't need any driver.

Modello depositato



Registered design

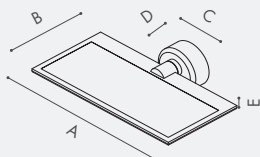

NE

BI



249

Art.	W	V	Lumen	°K led	A cm	B cm	C cm	D cm	E cm
GIÙUP AP 20	20	220-240	1900	3000	30,2	15	Ø8	2,5	1
GIÙUP AP 40	40	220-240	3800	3000	30,2	15	Ø8	2,5	1

LED Disponibili a richiesta nella temperatura colore 2700 °K





DIADEMA



DIADEMA

Marco Pagnoncelli - 2015

Collezione dal design ricercato realizzata in alluminio da 6 mm di spessore.

La ricerca dei profili smussati conferiscono originalità e unicità al prodotto.

Illuminazione indiretta ad alta luminosità ed efficienza a cobled 220V di ultima generazione che non necessitano di alimentatore.

Disponibile nella temperatura colore LED 3000 °K e 2700 °K.

A collection of refined design made by only 6mm thick aluminium.

The research of smooth profiles is giving originality and uniqueness to this fitting.

The high efficiency indirect lighting is given by 220V last generation cobled, no driver needed.

Available with 3000 °K or 2700 °K LED colour temperature.

Modello depositato



Registered design

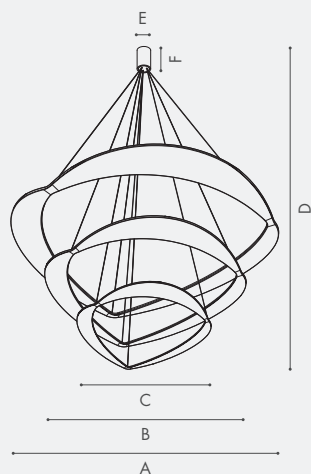

BI

FO



253

KIT FISSAGGIO
MAGGIORATO

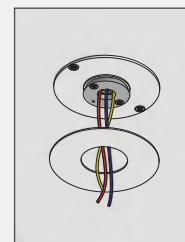

COD. **OP.2**

DIADEMA 3D = DECENTRATO

Art.	W	V	Lumen	°K led	A cm	B cm	C cm	D cm	E cm	F cm
DIADEMA 3D	165	220-240	16080	3000	Ø90	Ø70	Ø50	200	Ø3	10
DIADEMA 3	165	220-240	16080	3000	Ø90	Ø70	Ø50	200	Ø6	10

LED Disponibili a richiesta nella temperatura colore 2700 °K



DIADEMA

Marco Pagnoncelli - 2015

Collezione dal design ricercato realizzata in alluminio da 6 mm di spessore.

La ricerca dei profili smussati conferiscono originalità e unicità al prodotto.

Illuminazione indiretta ad alta luminosità ed efficienza a cobled 220V di ultima generazione che non necessitano di alimentatore.

Disponibile nella temperatura colore LED 3000 °K e 2700 °K.

A collection of refined design made by only 6mm thick aluminium.

The research of smooth profiles is giving originality and uniqueness to this fitting.

The high efficiency indirect lighting is given by 220V last generation cobled, no driver needed.

Available with 3000 °K or 2700 °K LED colour temperature.

Modello depositato



Registered design

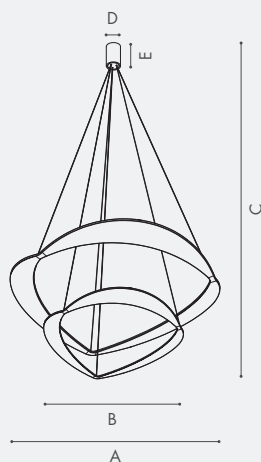

DIADEMA 2.90D - 2.70D = DECENTRATO

Art.	W	V	Lumen	°K led	A cm	B cm	C cm	D cm	E cm
DIADEMA 2.90D	120	220-240	11760	3000	Ø90	Ø50	200	Ø3	10
DIADEMA 2.70D	105	220-240	10200	3000	Ø70	Ø50	200	Ø3	10
DIADEMA 2.90	120	220-240	11760	3000	Ø90	Ø50	200	Ø6	10
DIADEMA 2.70	105	220-240	10200	3000	Ø70	Ø50	200	Ø6	10

LED Disponibili a richiesta nella temperatura colore 2700 °K

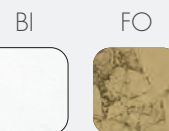

KIT FISSAGGIO
MAGGIORATO

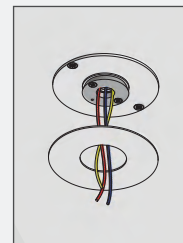

COD. **OP.2**



DIADEMA

Marco Pagnoncelli - 2015

Collezione dal design ricercato realizzata in alluminio da 6 mm di spessore.

La ricerca dei profili smussati conferiscono originalità e unicità al prodotto.

Illuminazione indiretta ad alta luminosità ed efficienza a cobled 220V di ultima generazione che non necessitano di alimentatore.

Disponibile nella temperatura colore LED 3000 °K e 2700 °K.

A collection of refined design made by only 6mm thick aluminium.

The research of smooth profiles is giving originality and uniqueness to this fitting.

The high efficiency indirect lighting is given by 220V last generation cobled, no driver needed.

Available with 3000 °K or 2700 °K LED colour temperature.

Modello depositato



Registered design

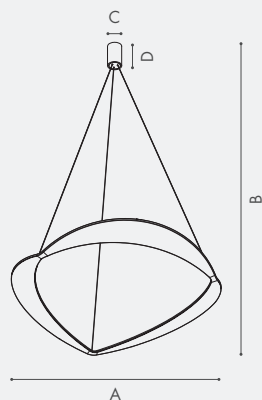

BI

FO



257

DIADEMA 1.90D - 1.70D - 1.50D = DECENTRATO

Art.	W	V	Lumen	°K led	A cm	B cm	C cm	D cm
DIADEMA 1.90D	60	220-240	5880	3000	Ø90	200	Ø3	10
DIADEMA 1.70D	60	220-240	5880	3000	Ø70	200	Ø3	10
DIADEMA 1.50D	45	220-240	4320	3000	Ø50	200	Ø3	10
DIADEMA 1.90	60	220-240	5880	3000	Ø90	200	Ø6	10
DIADEMA 1.70	60	220-240	5880	3000	Ø70	200	Ø6	10
DIADEMA 1.50	45	220-240	4320	3000	Ø50	200	Ø6	10

KIT FISSAGGIO
MAGGIORATO

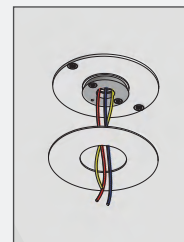

COD. **OP.2**

LED Disponibili a richiesta nella temperatura colore 2700 °K





LADY B



LADY B

O.I.L. DESIGN LAB - 2022

Sospensione estremamente sottile
adatto ad ambienti domestici e
professionali.

Diffusore in materiale bisatinato
smussato da 6 mm uniformemente
illuminato.

Alimentatore incluso.

Disponibile in due dimensioni e
potenze LED ad alta efficienza.

Dimmerabile a richiesta.

Extremely slight suspension
lamp, suitable for domestic and
professional environments.

Diffuser in 6 mm smooth beveled
double-glazed material.

Power supply included.

Available in two sizes and high
efficiency LED powers.

Dimmable on demand.

Modello depositato

Registered design

261

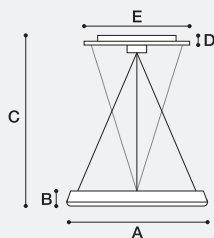

Art.	W	V	Lumen	°K led	A cm	B cm	C cm	D cm	E cm
LADY B 80	85	220-240	9000	3000	80	3,6	150	4,5	28
LADY B 58	45	220-240	4500	3000	58,5	3,6	150	4,5	28

LED disponibili a richiesta nella temperatura colore 2700 °K



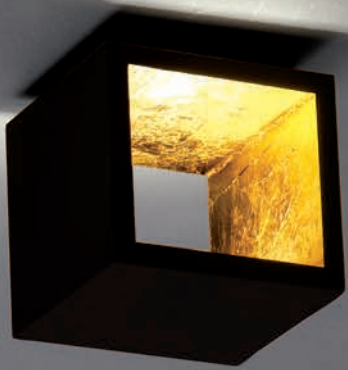

CUBÓ



CUBÒ

Marco Pagnoncelli - 2013

Lampada da soffitto o parete con corpo in alluminio estruso fornita con luce a LED 220V che non necessita di alimentatore. Nelle versioni a parete possibilità di luce sia verticale che orizzontale. Finiture colore: bianco laccato a liquido (BI), titanio+bianco (TO+BI), titanio+foglia argento (TO+FA), nero+foglia oro (NE+FO). Disponibile nella temperatura colore LED 3000 °K e 2700 °K.

Wall or ceiling lamp in extruded aluminium supplied with 220V LEDs not requiring a power supply unit. Wall version allows either vertical or horizontal light emission. Available in: white liquid enamel (BI), titanium+white (TO+BI), titanium+silver leaf (TO+FA), black+gold leaf (NE+FO). Available with 3000 °K or 2700 °K LED colour temperature.

Modello depositato

Registered design



265

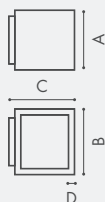

Art.	W	V	Lumen	° K Led	A cm	B cm	C cm	D cm
CUBÒ1.5	4	220-240	360	3000	10	10	11	1
CUBÒ1.10	8	220-240	720	3000	10	10	11	1

LED Disponibili a richiesta nella temperatura colore 2700 °K



CUBÒ

Marco Pagnoncelli - 2013

Lampada da tavolo con corpo in alluminio estruso fornita con luce a LED 220V che non necessita di alimentatore. Finiture colore: bianco laccato a liquido (BI), titanio+bianco (TO+BI), titanio+foglia argento (TO+FA), nero+foglia oro (NE+FO). Disponibile nella temperatura colore LED 3000 °K e 2700 °K.

Table lamp in extruded aluminium supplied with 220V LEDs not requiring a power supply unit. Available in: white liquid enamel (BI), titanium+white (TO+BI), titanium+silver leaf (TO+FA), black+gold leaf (NE+FO). Available with 3000 °K or 2700 °K LED colour temperature.

Modello depositato



Registered design



267

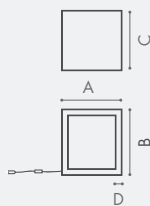

Art.	W	V	Lumen	° K Led	A cm	B cm	C cm	D cm
CUBÒ 1.5 LP	4	220-240	360	3000	10	11	10	1

LED Disponibili a richiesta nella temperatura colore 2700 °K





DARMA

270

sospensione



DARMA

Marco Pagnoncelli - 2016

Lampada a sospensione con corpo in alluminio multirigato fornito con led 220V, che non necessita di alimentatore.

Disponibile nella temperatura colore LED 3000 °K e 2700 °K.

Modello depositato



Suspension lamp with turned, grooved aluminium body, supplied with 220 V LED; no power supply needed.

Available with 3000 °K or 2700 °K LED colour temperature.

Registered design



271



Art.	W	V	Lumen	° K Led	A cm	B cm	C cm	D cm
DARMA S10	8	220-240	720	3000	Ø7	42	2	5

LED Disponibili a richiesta nella temperatura colore 2700 °K



DARMA

Marco Pagnoncelli - 2014

Lampada da parete con corpo in alluminio multirigato fornito con led 220V, che non necessita di alimentatore.

Disponibile nella temperatura colore LED 3000 °K e 2700 °K.

Modello depositato



Wall lumped with turned, grooved aluminium body, supplied with 220 V LED; no power supply needed.

Available with 3000 °K or 2700 °K LED colour temperature.

Registered design



BI

TO+BI



273

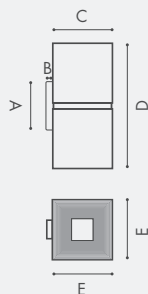

Art.	W	V	Lumen	° K Led	A cm	B cm	C cm	D cm	E cm
DARMA AP35	30	220-240	2880	3000	9,5	1,3	10	16,8	10
DARMA AP20	16	220-240	1440	3000	8	1,3	7	13,5	7

LED Disponibili a richiesta nella temperatura colore 2700 °K



DARMA

Marco Pagnoncelli - 2014

Lampada da soffitto con corpo in alluminio multirigato fornito con led 220V, che non necessita di alimentatore.

Disponibile nella temperatura colore LED 3000 °K e 2700 °K.

Ceiling lamp with turned, grooved aluminium body, supplied with 220 V LED; no power supply needed.

Available with 3000 °K or 2700 °K LED colour temperature.

Modello depositato



Registered design



BI TO+BI

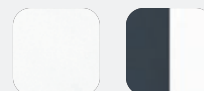

275

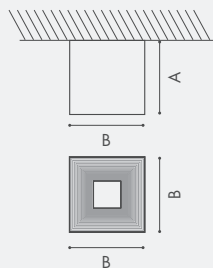

Art.	W	V	Lumen	° K Led	A cm	B cm
DARMA10P	8	220-240	720	3000	6,5	7
DARMA17P	15	220-240	1440	3000	8	10

LED Disponibili a richiesta nella temperatura colore 2700 °K

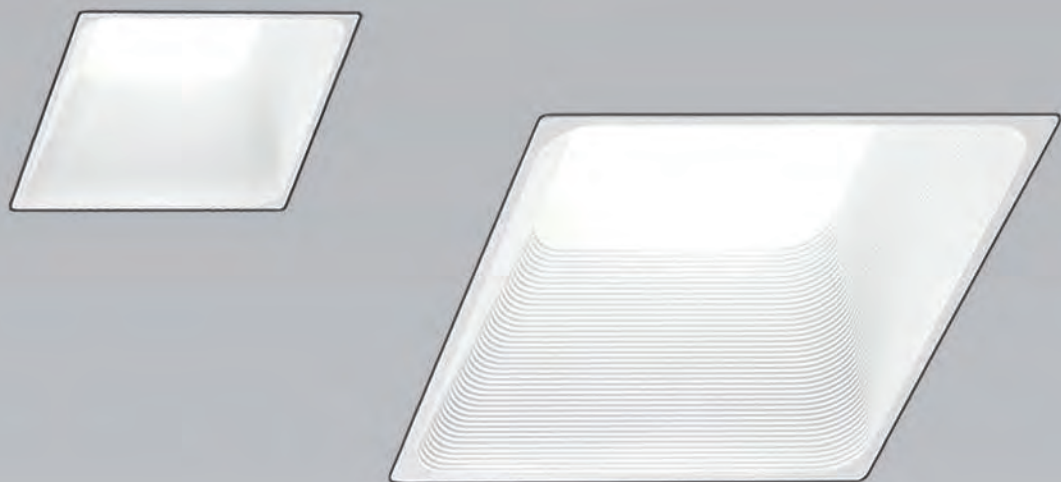

DARMA

Marco Pagnoncelli - 2014

Faretto in alluminio tornito da incasso a scomparsa con parte luminosa satinata multirigata. Utilizzabile a soffitto per illuminare piccoli e grandi spazi.

Disponibile in 2 dimensioni e due potenze.

Illuminazione a led che non necessita di alimentatore.

Finiture colore: bianco (BI).

Disponibile nella temperatura colore LED 3000 °K e 2700 °K.

Turned flush mounting hideaway spotlight with grooved satin lighting section. Ceiling mounted installation for brightening small and large areas. Available in 2 sizes and 2 power levels. LED illumination that does not require power supply. Available in: white (BI).

Available with 3000 °K or 2700 °K LED colour temperature.

Modello depositato

Registered design



Schema di montaggio controcasse per cartongesso / Assembly instructions for outer casing plasterboard

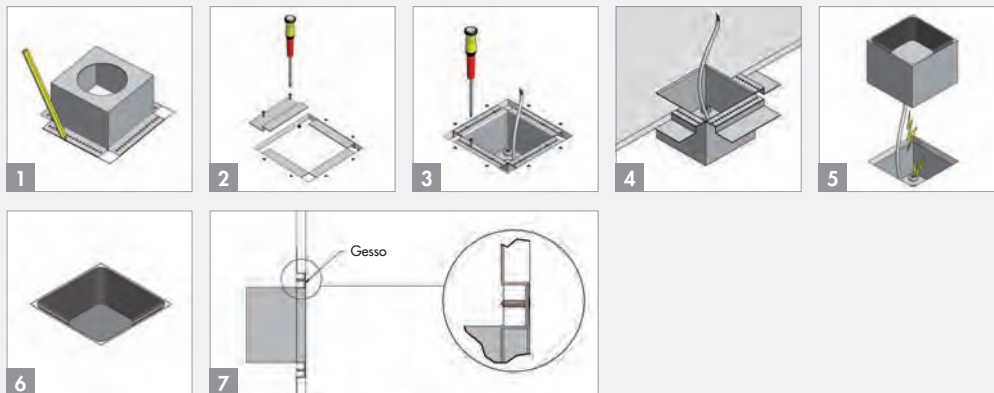

BI



277

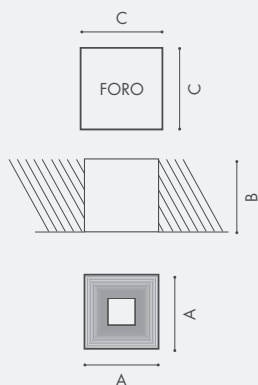

Art.	W	V	Lumen	° K Led	A cm	B cm	C cm
DARMA10	8	220-240	720	3000	7	6,5	12,5
DARMA17	15	220-240	1440	3000	10	8	16

LED Disponibili a richiesta nella temperatura colore 2700 °K



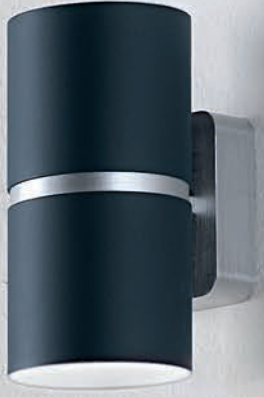

KONE

280

parete



KONE

Marco Pagnoncelli - 2014

Lampada da parete con corpo in alluminio tornito fornita con led 220V, che non necessita di alimentatore.

Disponibile nella temperatura colore LED 3000 °K e 2700 °K.

Modello depositato



Wall lamp with turned aluminium body, supplied with 220 V LED; no power supply needed.

Available with 3000 °K or 2700 °K LED colour temperature.

Registered design

281

BI TO+BI

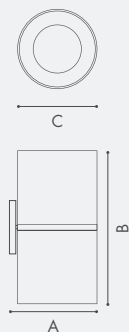
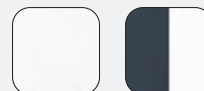

Art.	W	V	Lumen	° K Led	A cm	B cm	C cm
KONE 16AP	16	220-240	1440	3000	9	13,3	7
KONE 35AP	30	220-240	2880	3000	12	16,7	10

LED Disponibili a richiesta nella temperatura colore 2700 °K

282

terra



KONE

Marco Pagnoncelli - 2016

LAMPADA TERRA

Collezione dal design essenziale perfettamente adattabile in ogni ambiente.
Scheda LED 24V con alimentatore integrato.

Disponibile nella temperatura colore LED 3000 °K e 2700 °K.

FLOOR LAMP

A collection of essential design, to be easily set in every environment.
LED 24V board with built-in driver.

Available with 3000 °K or 2700 °K LED colour temperature.

Modello depositato



Registered design

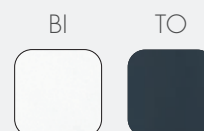

283



Art.	W	V	Lumen	° K Led	A cm	B cm	C cm
KONEST DIMMERABILE	22	220-240	3400	3000	30	185	Ø7

LED Disponibili a richiesta nella temperatura colore 2700 °K

284

sospensione



KONE

Marco Pagnoncelli - 2016

Lampada a sospensione in alluminio tornito utilizzabile per illuminare piccoli e grandi spazi. Disponibile in 2 misure e differenti potenze luminose. Fornito con luce a LED 220V che non necessita di alimentatore. Finiture colore: bianco laccato a liquido (BI), titanio+bianco (TO+BI). Disponibile nella temperatura colore LED 3000 °K e 2700 °K.

Suspension lamp with turned aluminium body suitable for wall or big space lighting. Two different measures and powers. Supplied with 220V LEDs not requiring a power supply unit. Available in: white liquid enamel (BI), titanium+white (TO+BI). Available with 3000 °K or 2700 °K LED colour temperature.

Modello depositato



Registered design



285

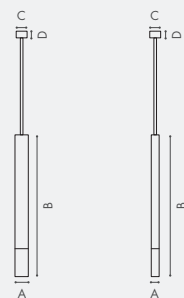

Art.	W	V	Lumen	° K Led	A cm	B cm	C cm	D cm
KONE 55	4	220-240	360	3000	Ø5	42	6	8
KONE 10	8	220-240	720	3000	Ø7	42	6	8

LED Disponibili a richiesta nella temperatura colore 2700 °K

286

soffitto



KONE

Marco Pagnoncelli - 2013

Lampada a soffitto in alluminio tornito utilizzabile per illuminare piccoli e grandi spazi. Disponibile in 3 misure e differenti potenze luminose. Fornito con luce a LED 220V che non necessita di alimentatore. Finiture colore: bianco laccato a liquido (BI), titanio+bianco (TO+BI), nero+foglia oro (NE+FO). Disponibile nella temperatura colore LED 3000 °K e 2700 °K.

Ceiling lamp with turned aluminium body suitable for wall or big space lighting. Three different measures and powers. Supplied with 220V LEDs not requiring a power supply unit. Available in: white liquid enamel (BI), titanium+white (TO+BI), black+gold leaf (NE+FO). Available with 3000 °K or 2700 °K LED colour temperature.

Modello depositato

Registered design

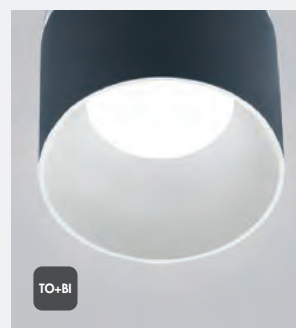

Art.	W	V	Lumen	° K Led	A cm	B cm
KONE5P	4	220-240	360	3000	5	7
KONE7P	8	220-240	720	3000	7	7
KONE10P	15	220-240	1440	3000	10	9

LED Disponibili a richiesta nella temperatura colore 2700 °K



KONE

Marco Pagnoncelli - 2013

Faretto in alluminio tornito da incasso a scomparsa con parte luminosa satinata rientrata rispetto al filo parete. Utilizzabile a soffitto per illuminazione di piccoli e grandi spazi. Disponibile in 3 dimensioni e varie potenze. Illuminazione a LED 220V che non necessita di alimentatore. Finiture colore: bianco laccato a liquido (BI), foglia oro (FO), foglia argento (FA). Disponibile nella temperatura colore LED 3000 °K e 2700 °K.

Spotlight in turned aluminium for trimless recessed installation. Lighting part satin-finished recessed in the wall. Suitable for ceiling lighting-both small and big spaces. Available in 3 measures and different powers. Supplied with 220V LEDs not requiring a power supply unit. Available in: white liquid enamel (BI), gold leaf (FO), silver leaf (FA). Available with 3000 °K or 2700 °K LED colour temperature.

Modello depositato



Registered design

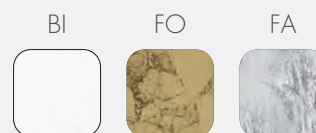
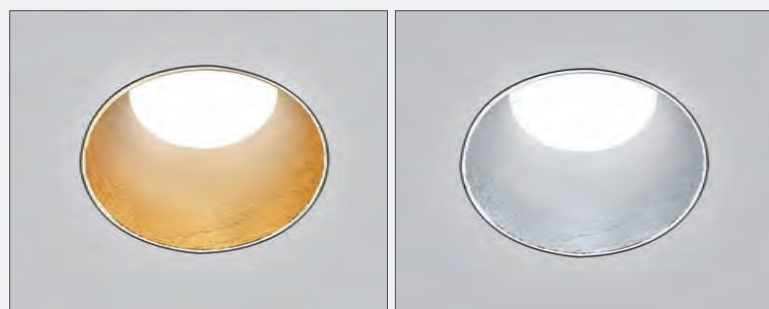

289

COD. CONTROCASSE CARTONGESSO WALL HOUSING FOR PLASTERBOARD

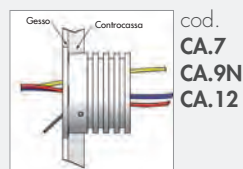
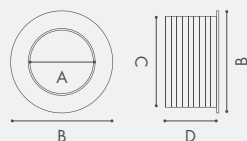

COD. CONTROCASSE LATERIZIO WALL HOUSING FOR MASONRY WALL

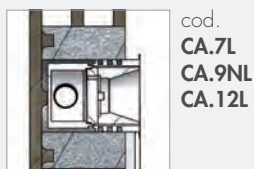
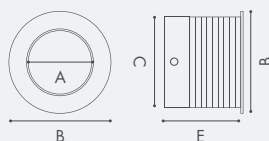

Art.	W	V	Lumen	° K Led	A cm	B cm	C cm	D cm	E cm
KONE7	4	220-240	360	3000	4,7	7	6	4,7	8
KONE9	8	220-240	720	3000	6,1	9	8	4,7	8,2
KONE12	15	220-240	1440	3000	8,9	12	10	8	11,5

LED Disponibili a richiesta nella temperatura colore 2700 °K



CONFORT

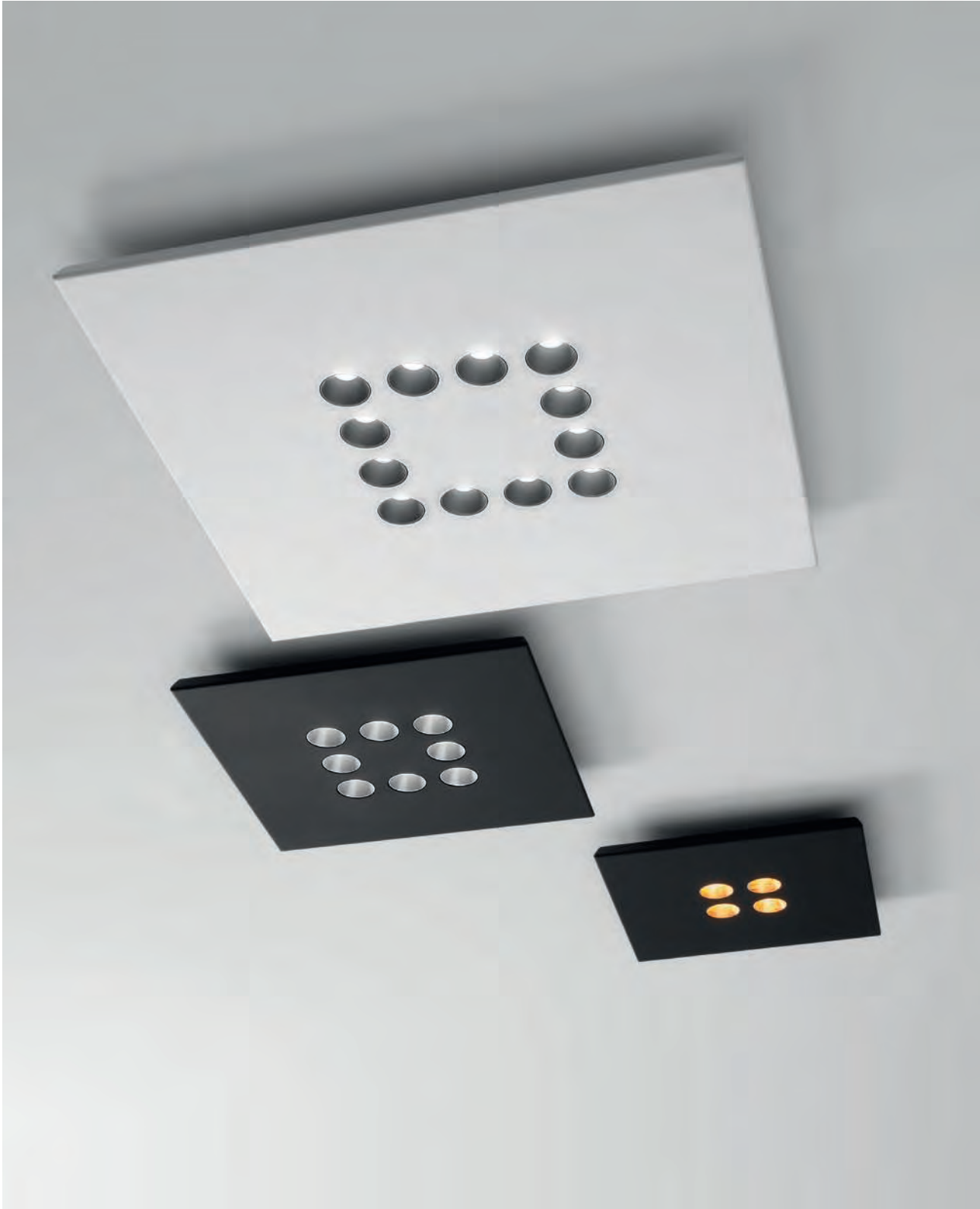

CONFORT

Marco Pagnoncelli - 2017

Lampada da soffitto in alluminio disponibile in diverse misure e differenti potenze luminose. Fornita ad emissione diretta. Finiture colore: verniciato bianco o nero con riflettore alluminio (A), bianco perla (PE), antracite (AN), foglia oro (FO), foglia rame (FR). Disponibile nella temperatura di colore 3000°K e 2700°K

Aluminium ceiling lamp available in different sizes and wattages. Direct light emission. Color finishing: white or black with reflectors aluminium (A), pearl white (PE), anthracite (AN), gold leaf (FO), copper leaf (FR). Available in 3000°K and 2700°K color temperature.

Modello depositato

Registered design



NE+PE

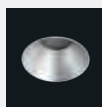

NE+A

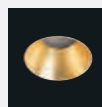

NE+FO

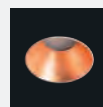

NE+FR



NE+AN



BI+PE

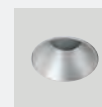

BI+A

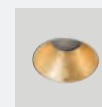

BI+FO

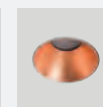

BI+FR



BI+AN

293

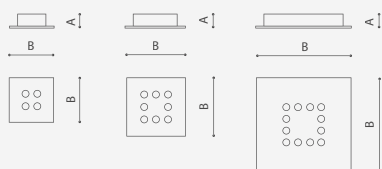

Art.	W	V	Lumen	°K led	A cm	B cm
CONFORT 4Q	18,8	220-240	1704	3000	4,5	38
CONFORT 8Q	37,6	220-240	3408	3000	4,5	45
CONFORT 12Q	56,4	220-240	5112	3000	4,5	65

LED Disponibili a richiesta nella temperatura colore 2700 °K



CONFORT

Marco Pagnoncelli - 2017

Lampada da soffitto in alluminio disponibile in diverse misure e differenti potenze luminose. Fornita ad emissione diretta. Finiture colore: verniciato bianco o nero con riflettore alluminio (A), bianco perla (PE), antracite (AN), foglia oro (FO), foglia rame (FR). Disponibile nella temperatura di colore 3000°K e 2700°K

Aluminium ceiling lamp available in different sizes and wattages. Direct light emission. Color finishing: white or black with reflectors aluminium (A), pearl white (PE), anthracite (AN), gold leaf (FO), copper leaf (FR). Available in 3000°K and 2700°K color temperature.

Modello depositato

Registered design



NE+PE

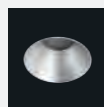

NE+A

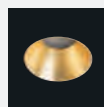

NE+FO

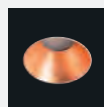

NE+FR

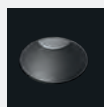

NE+AN



BI+PE

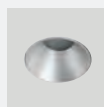

BI+A

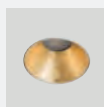

BI+FO

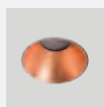

BI+FR



BI+AN

295



Art.	W	V	Lumen	°K led	A cm	B cm	C cm
CONFORT 3R	14,1	220-240	1278	3000	4,5	46	20
CONFORT 6R	28,2	220-240	2556	3000	4,5	71	20
CONFORT 9R	42,3	220-240	3834	3000	4,5	97	20

LED Disponibili a richiesta nella temperatura colore 2700 °K



CONFORT S

Marco Pagnoncelli - 2017

Lampada a sospensione in alluminio disponibile in diverse misure e differenti potenze luminose.

Fornita ad emissione diretta o diretta/indiretta.

Finiture colore: verniciato bianco o nero con riflettore alluminio (A), bianco perla (PE), antracite (AN), foglia oro (FO), foglia rame (FR).

Disponibile nella temperatura di colore 3000°K e 2700°K

Aluminium suspension lamp available in different sizes and wattages.

Direct or direct/indirect light emission.

Color finishing: white or black with reflectors aluminium (A), pearl white (PE), anthracite (AN), gold leaf (FO), copper leaf (FR).

Available in 3000°K and 2700°K color temperature.

Modello depositato

Registered design

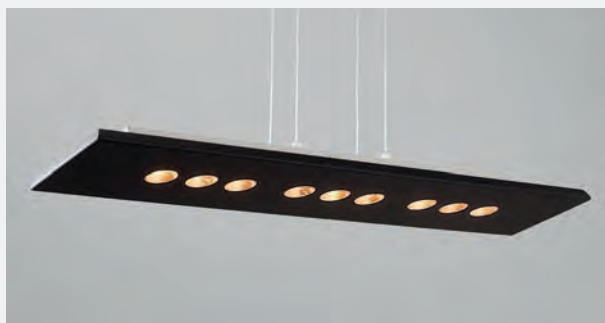

NE+PE

NE+A

NE+FO

NE+FR

NE+AN

BI+PE

BI+A

BI+FO

BI+FR

BI+AN

CONFORT 9SR

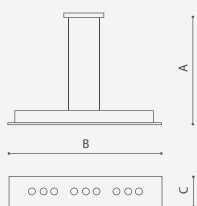

CONFORT 10SR

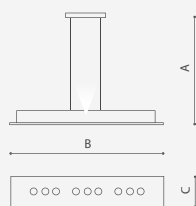

CONFORT 125Q

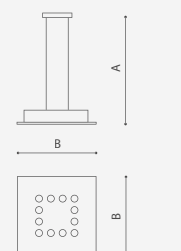

CONFORT 135Q

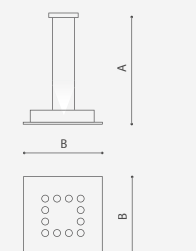

Art.	W	V	Lumen	°K led	A cm	B cm	C cm
CONFORT 9SR	42,3	220-240	3834	3000	150	97	20
CONFORT 10SR	57,3	220-240	5274	3000	150	97	20
CONFORT 125Q	56,4	220-240	5112	3000	150	65	
CONFORT 135Q	71,4	220-240	6552	3000	150	65	

LED Disponibili a richiesta nella temperatura colore 2700 °K

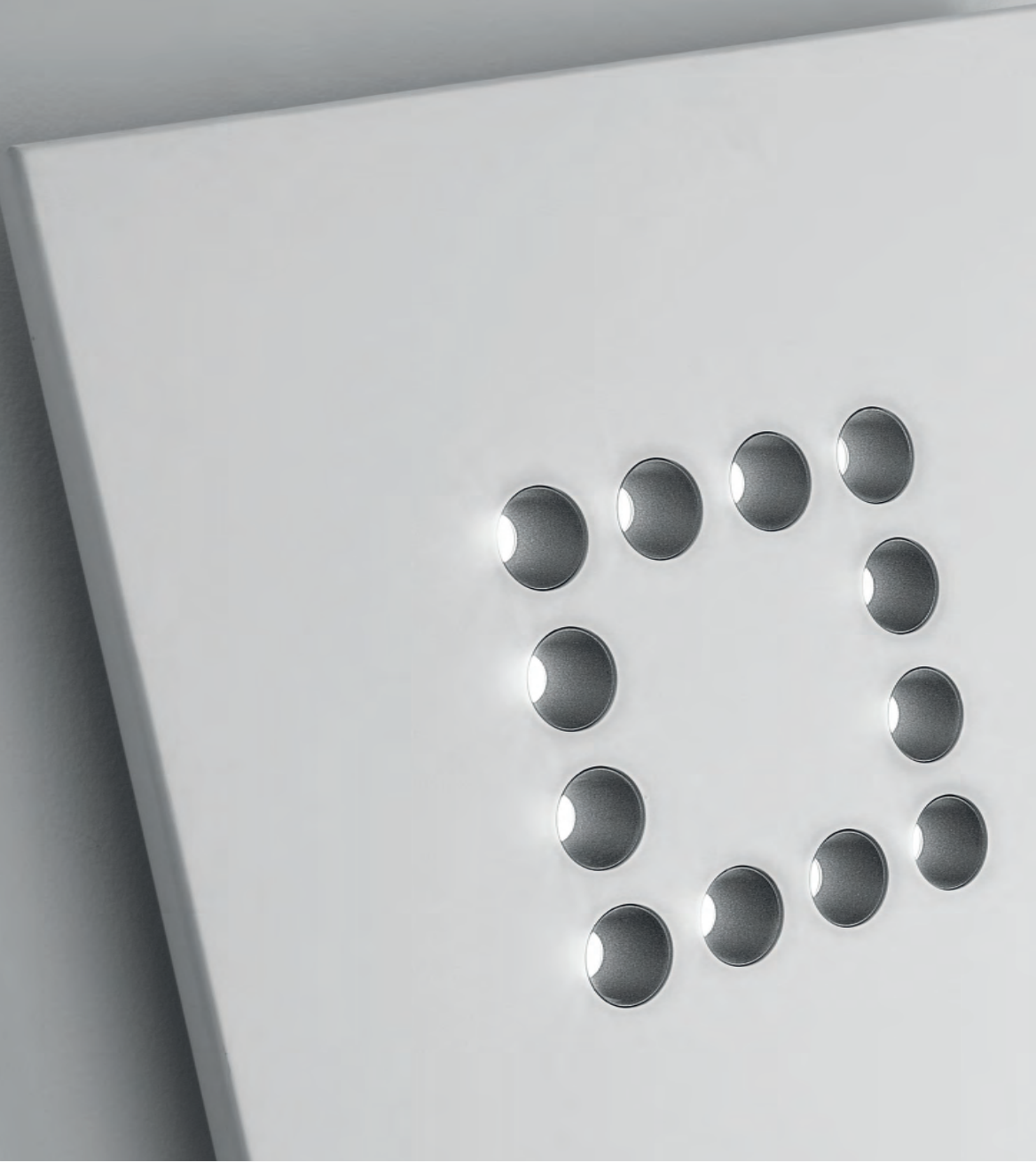

BI+PE



BI+A



BI+FO



BI+FR



BI+AN

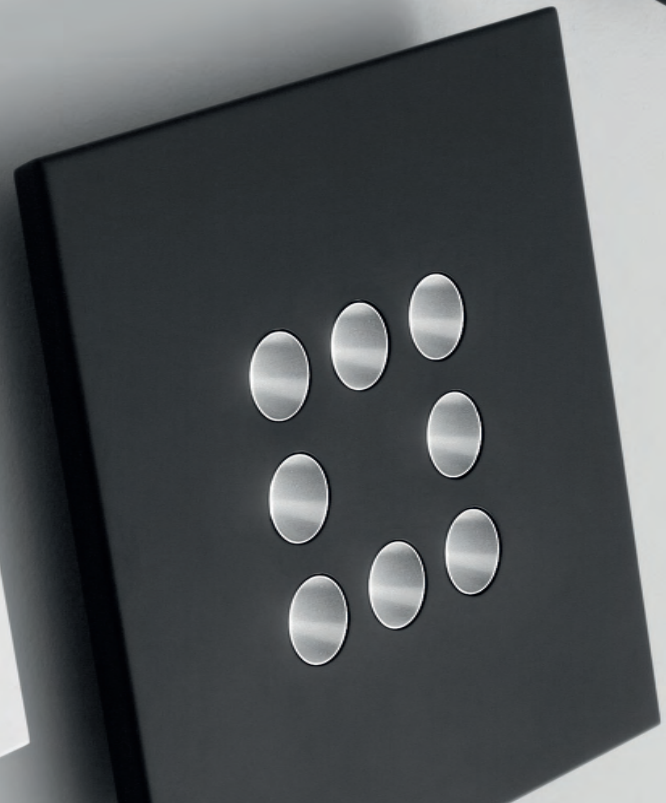

FINITURE

La collezione di lampade serie Confort rappresenta una soluzione ottimale per il moderno abitare. La raffinata ed ampia gamma di finiture qui rappresentate sono in grado di soddisfare tutte le vostre esigenze.

The collection of lamps of the series Confort is the best solution for modern living rooms. The wide and refined range of color finishings can satisfy all your requirements

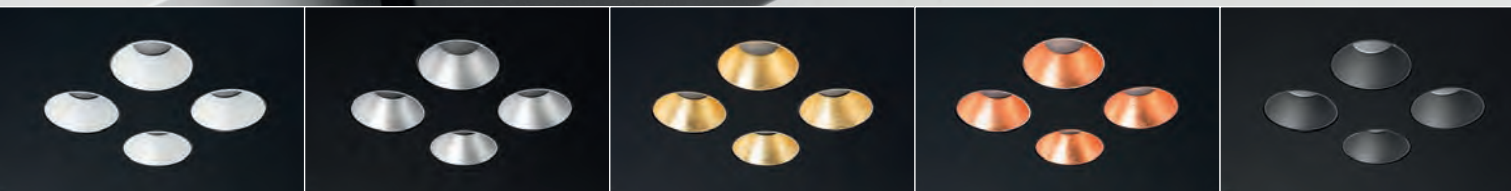

NE+PE

NE+A

NE+FO

NE+FR

NE+AN





SWING



SWING

Marco Pagnoncelli - 2012

Lampada da soffitto con corpo/
diffusore in alluminio 2 mm di
spessore.

Fissaggio rapido tramite sistema
a magneti.

Disponibile nella temperatura
colore LED 3000 °K e 2700 °K.

Ceiling lamp with body/diffuser
in 2 mm thick aluminium.

Rapid fastening with magnet
system.

Available with 3000 °K or 2700
°K LED colour temperature.

Modello depositato

Registered design



BI

NE



303

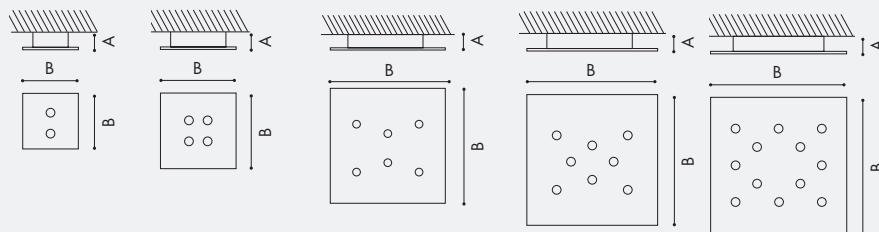

Art.	W	V	Lumen	°K Led	A cm	B cm
SWING2	9,4	220-240	852	3000	3,8	20
SWING4	18,8	220-240	1704	3000	3,8	25
SWING6	28,2	220-240	2556	3000	3,8	35
SWING8	37,6	220-240	3408	3000	3,8	45
SWING12	56,4	220-240	5112	3000	3,8	65

LED Disponibili a richiesta nella temperatura colore 2700 °K





POP

306

sospensione



POP

Marco Pagnoncelli - 2011

Lampada a sospensione dalla forma pura quadrata, a luce diretta o a luce diretta+indiretta, caratterizzata dalla luce a LED 220V e dal profilo disegnato a U, che conferiscono design esclusivo e raffinato sia dal punto di vista estetico che cromatico. Disponibile nella temperatura colore LED 3000 °K e 2700 °K.

Suspension lamp with a pure square shape, 220V LEDs with possible versions either direct or direct + indirect light. The U profile characterizes the exclusive and polished design both aesthetically and chromatically. Available with 3000 °K or 2700 °K LED colour temperature.

Modello depositato

Registered design

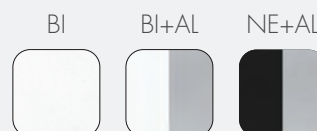

307

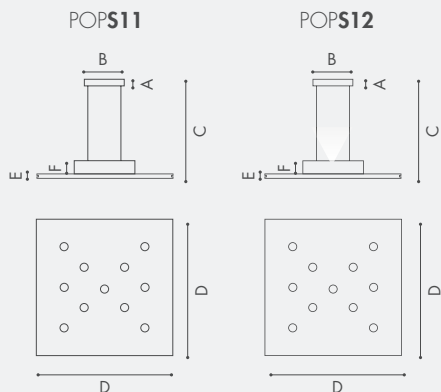

Art.	W	V	Lumen	°K Led	A cm	B cm	C cm	D cm	E cm	F cm
POPS11	51,7	220-240	4686	3000	2,2	18	120	65	0,9	4,3
POPS12	66,7	220-240	6126	3000	2,2	18	120	65	0,9	4,3

LED Disponibili a richiesta nella temperatura colore 2700 °K

308

sospensione



POP

Marco Pagnoncelli - 2012

Sospensione dalla forma geometrica rettangolare caratterizzata dalla luce a LED 220V e dal profilo disegnato a U, che conferiscono design esclusivo e raffinato sia dal punto di vista estetico che cromatico. Disponibile nella temperatura colore LED 3000 °K e 2700 °K.

Suspension lamp with rectangular-shaped body supplied with 220V LEDs. The U profile characterizes the exclusive and polished design both aesthetically and chromatically. Available with 3000 °K or 2700 °K LED colour temperature.

Modello depositato

Registered design

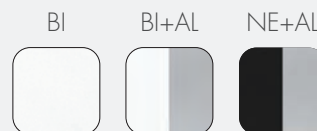

309

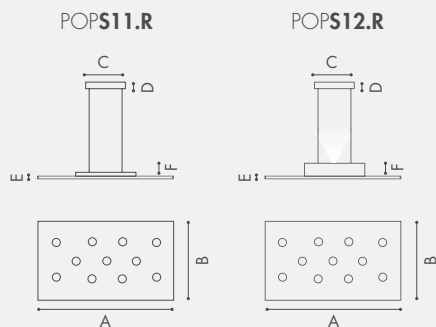

Art.	W	V	Lumen	°K led	A cm	B cm	C cm	D cm	E cm	F cm
POPS11.R	51,7	220-240	4686	3000	92	47	18	2,2	0,9	4,3
POPS12.R	66,7	220-240	6126	3000	92	47	18	2,2	0,9	4,3

LED Disponibili a richiesta nella temperatura colore 2700 °K

310

soffitto



POP

Marco Pagnoncelli - 2011

Lampada a soffitto dalla forma rettangolare a luce diretta caratterizzata dalla luce a LED e dal profilo disegnato a U, che conferiscono design esclusivo e raffinato sia dal punto di vista estetico che cromatico.
Disponibile nella temperatura colore LED 3000 °K e 2700 °K.

Ceiling lamp with a rectangular shape and LEDs. The U profile characterizes the exclusive and polished design both aesthetically and chromatically.
Available with 3000 °K or 2700 °K LED colour temperature.

Modello depositato



Registered design

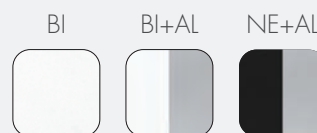
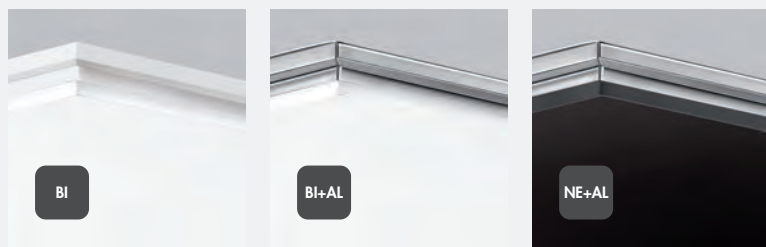

311

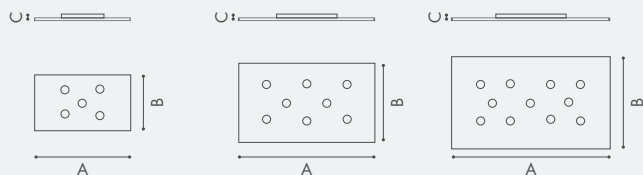

Art.	W	V	Lumen	°K Led	A cm	B cm	C cm
POP5	23,5	220-240	2130	3000	45	25	3,8
POP8	37,6	220-240	3408	3000	60	35	3,8
POP11	51,7	220-240	4686	3000	92	47	3,8

LED Disponibili a richiesta nella temperatura colore 2700 °K





SCUDO

314

sospensione



SCUDO

Marco Pagnoncelli - 2013

Lampada a sospensione dalla forma tondeggiante corpo/diffusore in alluminio 2 mm di spessore.
Disponibile nelle versioni a illuminazione diretta o illuminazione diretta+indiretta.
Finiture colore: bianco laccato a liquido (BI), nero (NE).
Disponibile nella temperatura colore LED 3000 °K e 2700 °K.

Suspension lamp with round-shaped body/diffuser in aluminium (thickness 2mm).
Available versions either with direct or direct + indirect light emission.
Available in: white liquid enamel (BI), black (NE).
Available with 3000 °K or 2700 °K LED colour temperature.



Modello depositato



Registered design

SCUDO.S9

SCUDO.S10

BI

NE



315

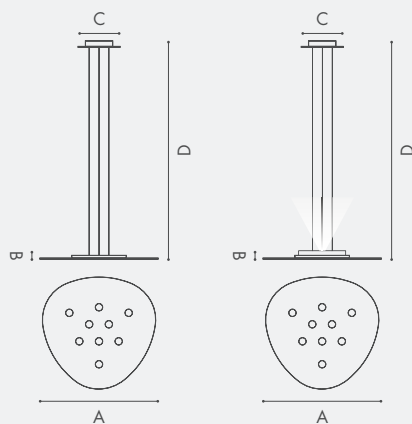

Art.	W	V	Lumen	° K Led	A cm	B cm	C cm	D cm
SCUDO.S9	42,3	220-240	3834	3000	Ø65	5,2	20,8	120
SCUDO.S10	57,3	220-240	5274	3000	Ø65	5,2	20,8	120

LED Disponibili a richiesta nella temperatura colore 2700 °K



SCUDO

Marco Pagnoncelli - 2013

Lampada a soffitto dalla forma tondeggiante con corpo/diffusore in alluminio 2 mm di spessore.

Lampada adatta a composizioni: acquistando elementi singoli si possono eseguire differenti forme.

Finiture colore: bianco laccato a liquido (BI), nero (NE).

Disponibile nella temperatura colore LED 3000 °K e 2700 °K.

Ceiling lamp with body/diffuser in aluminium (thickness 2mm). It can be suitable for modular realisation: with single luminaires different arrangement can be created.

Available in: white liquid enamel (BI), black (NE).

Available with 3000 °K or 2700 °K LED colour temperature.

Modello depositato



Registered design

BI NE



317

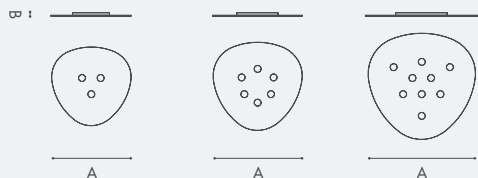

Art.	W	V	Lumen	° K Led	A cm	B cm
SCUDO3	14,1	220-240	1278	3000	32	3,8
SCUDO6	28,2	220-240	2556	3000	46	3,8
SCUDO9	42,3	220-240	3834	3000	65	3,8

LED Disponibili a richiesta nella temperatura colore 2700 °K



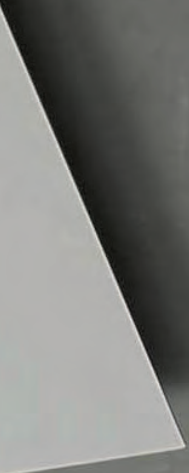
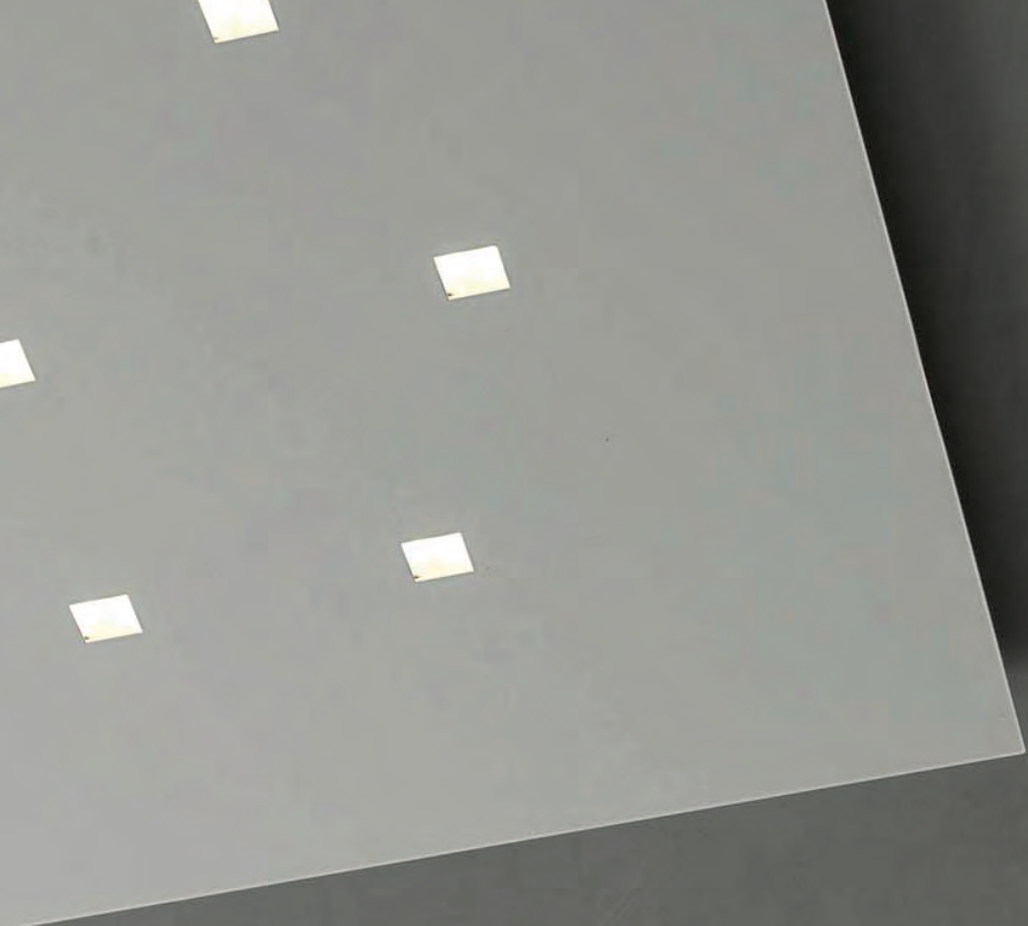

ISI

320

soffitto

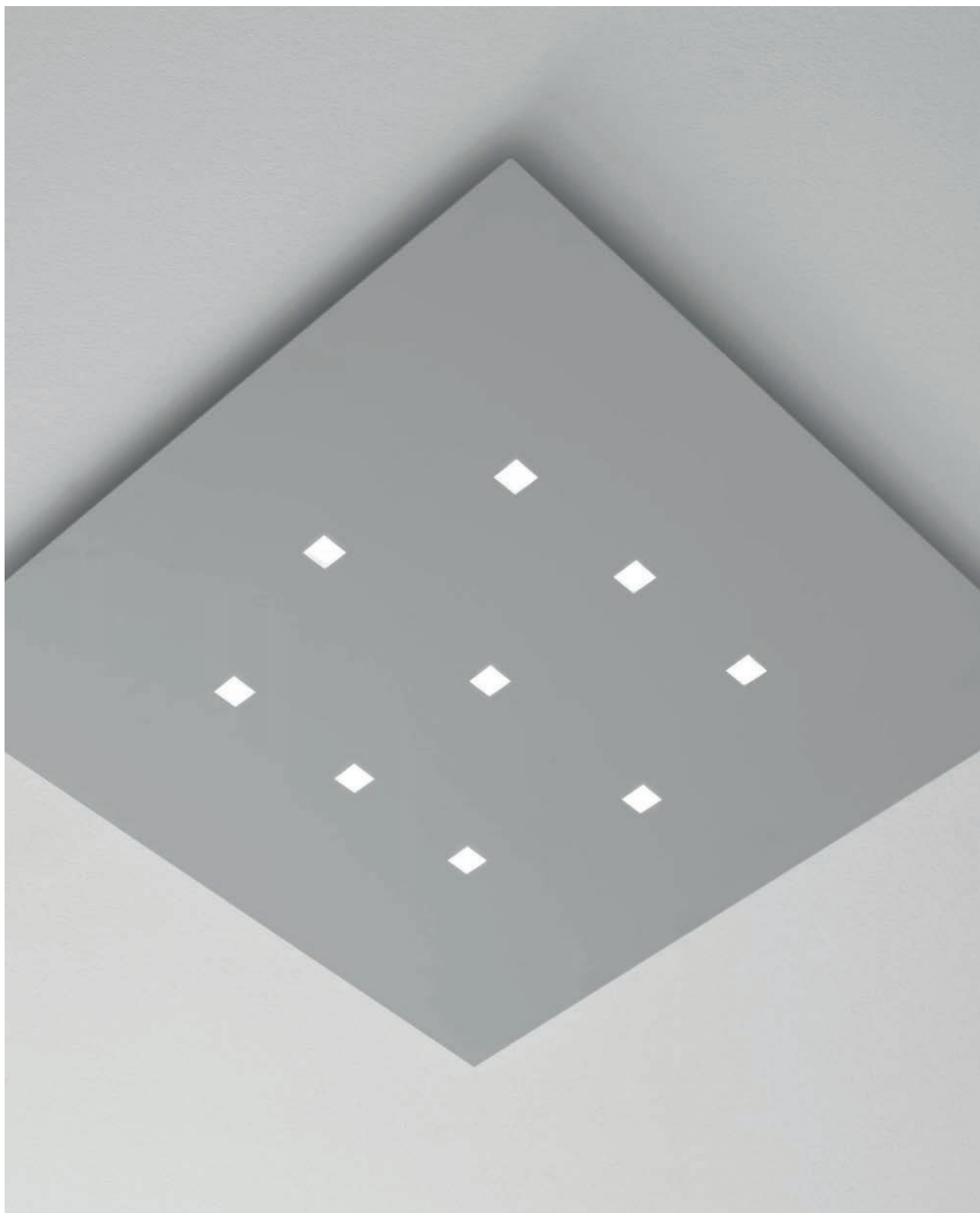

ISI

Marco Pagnoncelli - 2017

Lampada da soffitto di forma quadrata o rettangolare con corpo diffusore in ferro 1,5 mm di spessore.

Verniciato a polvere. Disponibile in colore bianco (BI) o grigio (G). Fissaggio rapido dello schermo tramite sistema a magneti. Disponibile nella temperatura colore LED 3000°K e 2700°K

Ceiling Lamp with square or rectangular shape, diffuser in iron 1,5 mm thickness.

Powder painted. Available in white (BI) or grey (G) color. Quick fixing of the screen by magnets. Available with 3000°K and 2700°K LED color temperature

Modello depositato

Registered design

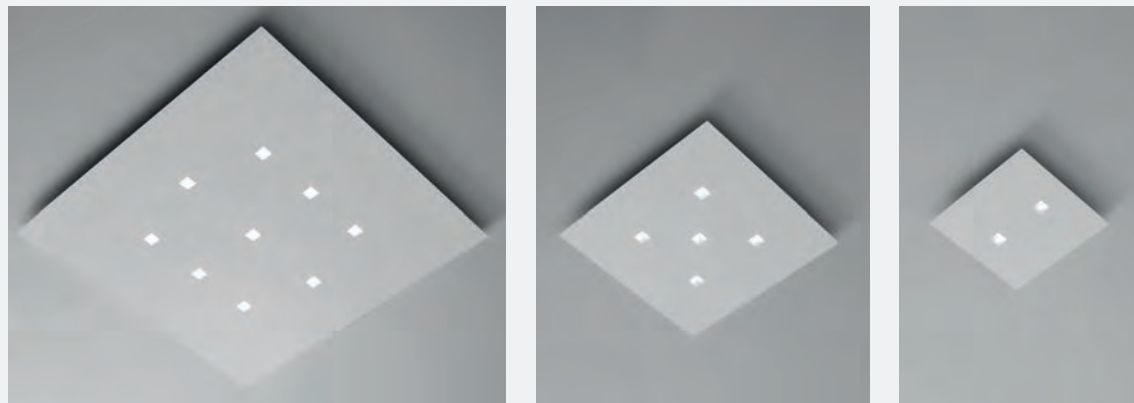

321

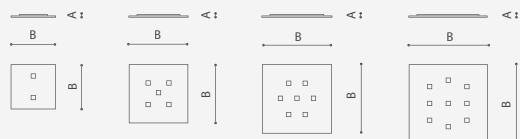

Art.	W	V	Lumen	°K led	A cm	B cm
ISI Q2	9,4	220-240	852	3000	4	20
ISI Q5	23,5	220-240	2130	3000	4	32
ISI Q7	32,9	220-240	2982	3000	4	41
ISI Q9	42,3	220-240	3834	3000	4	55

LED Disponibili a richiesta nella temperatura colore 2700 °K

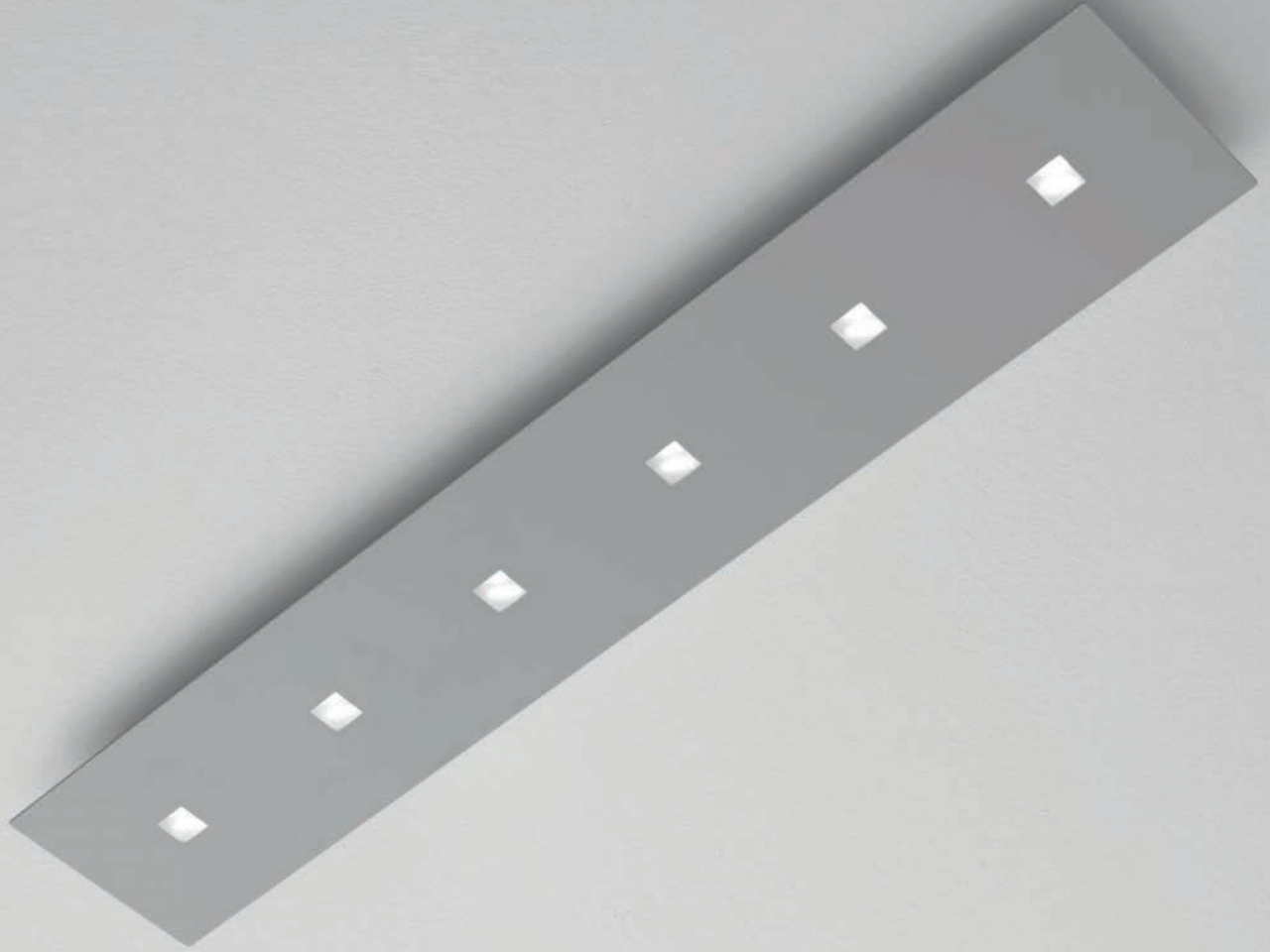

ISI

Marco Pagnoncelli - 2017

Lampada da soffitto di forma quadrata o rettangolare con corpo diffusore in ferro 1,5 mm di spessore.

Verniciato a polvere.

Disponibile in colore bianco (BI) o grigio (G).

Fissaggio rapido dello schermo tramite sistema a magneti.

Disponibile nella temperatura colore LED 3000°K e 2700°K

Ceiling Lamp with square or rectangular shape, diffuser in iron 1,5 mm thickness.

Powder painted.

Available in white (BI) or grey (G) color.

Quick fixing of the screen by magnets.

Available with 3000°K and 2700°K LED color temperature

Modello depositato

Registered design

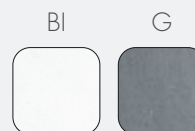

323

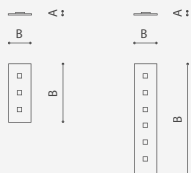

Art.	W	V	Lumen	°K led	A cm	B cm	C cm
ISI R3	14,1	220-240	1278	3000	4	12	35
ISI R6	28,2	220-240	2556	3000	4	12	70

LED Disponibili a richiesta nella temperatura colore 2700 °K





RING

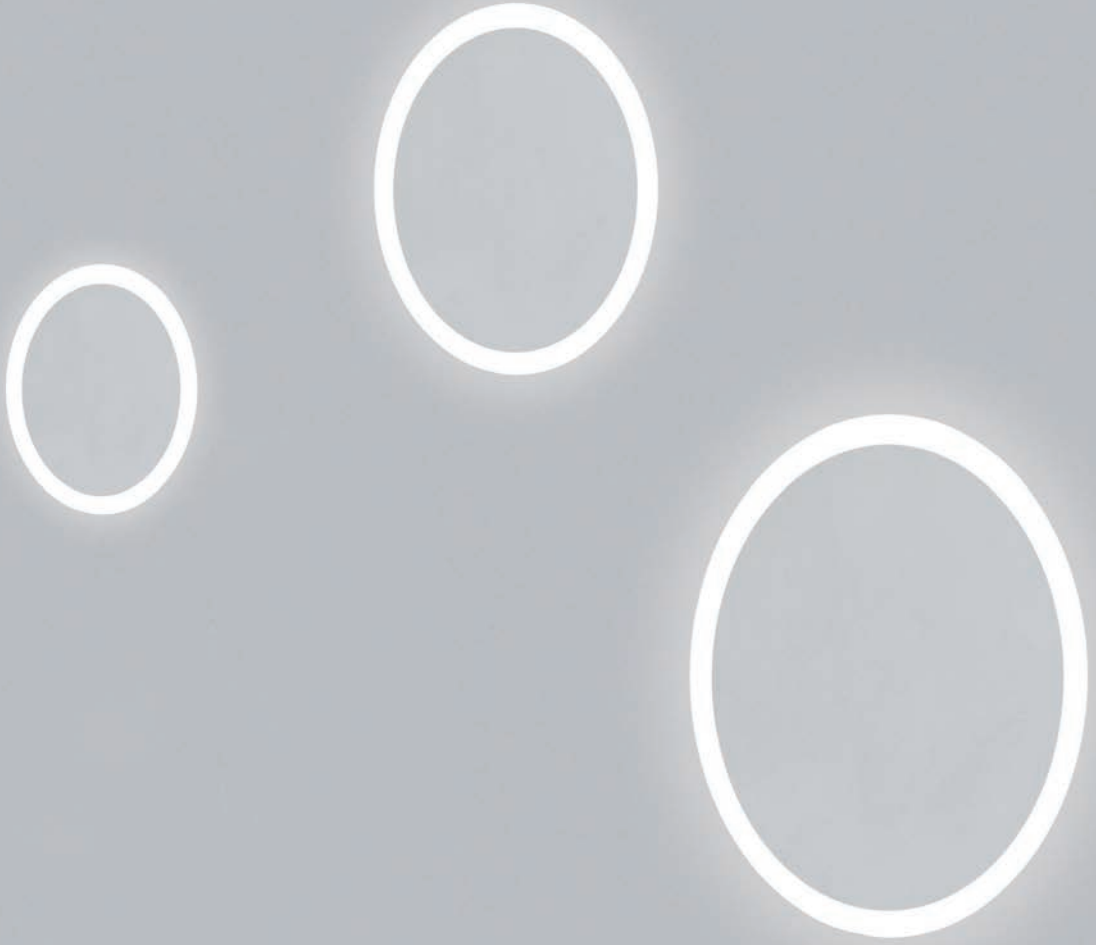

RING

Marco Pagnoncelli - 2013

Faretto in alluminio tornito da incasso a scomparsa in modo da creare un taglio di luce circolare nella parete. Una volta posizionato può essere tinteggiato come la parete rendendolo così parte integrante della parete stessa. Utilizzabile come segnapasso, oppure a soffitto abbinato con il faretto Kone dà la possibilità di avere doppia illuminazione e quindi effetti luminosi particolarmente accattivanti. Disponibile in 3 misure e 2 potenze luminose. Illuminazione a LED 220V che non necessita di alimentatore.

Spotlight in turned aluminium for trimless recessed installation creating a round cut in the wall. After installation, it can be painted like the wall for a uniform effect. Suitable as step light, or for ceiling version in addition to Kone luminaire for a double amazing light effects. Available in 3 measures and 2 powers. Supplied with 220V LEDs not requiring a power supply unit.

Modello depositato

Registered design



BI



327

COD. CONTROCASSE CARTONGESSO WALL HOUSING FOR PLASTERBOARD

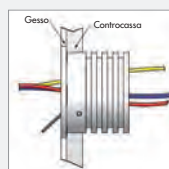
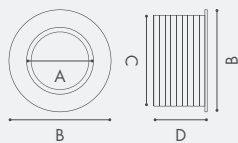

cod.
CA.7
CA.9
CA.12

COD. CONTROCASSE LATERIZIO WALL HOUSING FOR MASONRY WALL

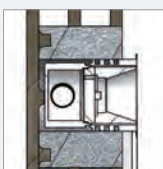
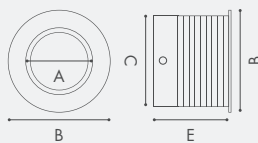

cod.
CA.7L
CA.9L
CA.12L

Art.	W	V	Lumen	° K Led	A cm	B cm	C cm	D cm	E cm
RING 7	4	220-240	360	3000	4,7	7	6	4,7	8,5
RING 9	4	220-240	360	3000	5,9	9	8	4,7	8,5
RING 12	8	220-240	720	3000	8,9	12	10	7,7	11,5

LED Disponibili a richiesta nella temperatura colore 2700 °K





BOOMERANG



BOOMERANG

Marco Pagnoncelli - 2009-2014

Lampada a parete in alluminio pressofuso a luce indiretta. A LED 220V senza alimentatore.

Finiture: bianco laccato a liquido (BI).

Indirect light pressure die-cast aluminium wall lamp.

220 V LED without power supply.

Finishes: white liquid enamel (BI).

Modello depositato



Registered design

BI



331

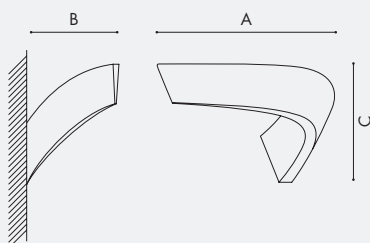

Art.	W	V	Lumen	° K Led	A cm	B cm	C cm
BOOMERANG APLED	11	220-240	2760	3000	32	16,5	20

LED Disponibili a richiesta nella temperatura colore 2700 °K



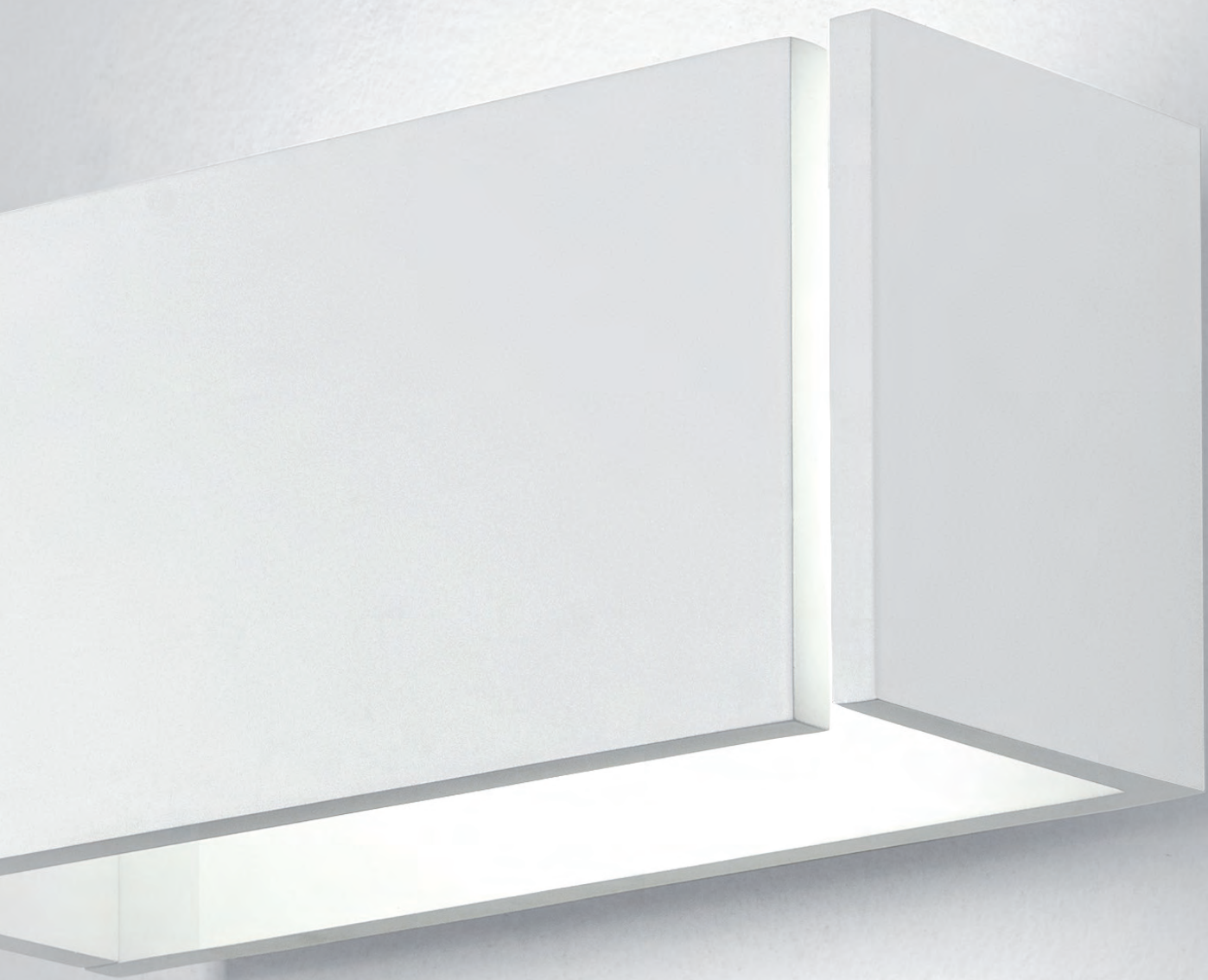

8 M M

334



parete

8MM

Marco Pagnoncelli - 2014

Lampada da parete in alluminio estruso dalla forma rettangolare allungata. Illuminazione a LED 220V indiretta che non necessita di alimentatore.

Finiture colore: bianco laccato a liquido (BI), nero (NE).

Disponibile nella temperatura colore LED 3000 °K e 2700 °K.

Wall lamp with extended rectangular-shaped extruded aluminium body. Supplied with 220V LEDs not requiring a power supply unit.

Available in: white liquid enamel (BI), black (NE).

Available with 3000 °K or 2700 °K LED colour temperature.

Modello depositato



Registered design

BI



NE



335

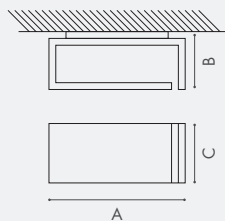

Art.	W	V	Lumen	° K Led	A cm	B cm	C cm
8MMAP	13	220-240	1075	3000	20,5	9	9

LED Disponibili a richiesta nella temperatura colore 2700 °K



TRATTO



TRATTO

Marco Pagnoncelli - 2012

Lampada da parete con corpo in alluminio dal profilo sottile. Alimentatore incluso. Finiture colori: verniciato bianco (BI), verniciato nero (NE).

Wall lamp with slender aluminium body. Power supply unit included. Available in: white varnish (BI), black varnish (NE).

Modello depositato

Registered design



BI NE



339

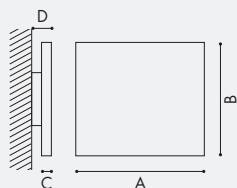

Art.	W	V	mA	Lumen	°K Led	A cm	B cm	C cm	D cm
TRATTO 16.G.2	16,8	220-240	700	1920	3000	24	15	1,5	5,0

LED Disponibili a richiesta nella temperatura colore 2700 °K





LINGOTTO

342



parete

LINGOTTO

Marco Pagnoncelli - 2012

Lampada da parete in alluminio estruso dalla forma rettangolare allungata. Illuminazione a LED 220V indiretta che non necessita di alimentatore.

Finiture colore: bianco laccato a liquido (BI), nero (NE).

Disponibile nella temperatura colore LED 3000 °K e 2700 °K.

Wall lamp with extended rectangular-shaped extruded aluminium body. Supplied with 220V LEDs not requiring a power supply unit.

Available in: white liquid enamel (BI), black (NE).

Available with 3000 °K or 2700 °K LED colour temperature.

Modello depositato



Registered design

BI

NE



343

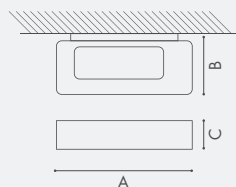

Art.	W	V	Lumen	°K Led	A cm	B cm	C cm
LINGOTTOLED	13	220-240	1075	3000	19	8,5	4,5

LED Disponibili a richiesta nella temperatura colore 2700 °K





TI

346

parete



TI

Marco Pagnoncelli - 2013

Lampada da parete in alluminio estruso dalla forma a T.
Illuminazione indiretta LED 220V che non necessita di alimentatore.
Disponibile in varie potenze.
Possibilità di applicazione in verticale o orizzontale.
Finiture colore: bianco laccato a liquido (BI), nero (NE).
Disponibile nella temperatura colore LED 3000 °K e 2700 °K.

Wall lamp T-shaped in extruded aluminium. Supplied with 220V LEDs not requiring a power supply unit. Available in different powers. Possible installation both vertically and horizontally.
Available in: white liquid enamel (BI), black (NE).
Available with 3000 °K or 2700 °K LED colour temperature.

Modello depositato

Registered design

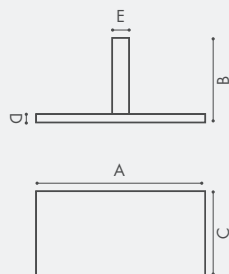

BI

NE



347

Art.	W	V	Lumen	° K Led	A cm	B cm	C cm	D cm	E cm
TI10R	10	220-240	700	3000	20	10	10	1	2
TI20R	16	220-240	1440	3000	20	10	10	1	2

LED Disponibili a richiesta nella temperatura colore 2700 °K

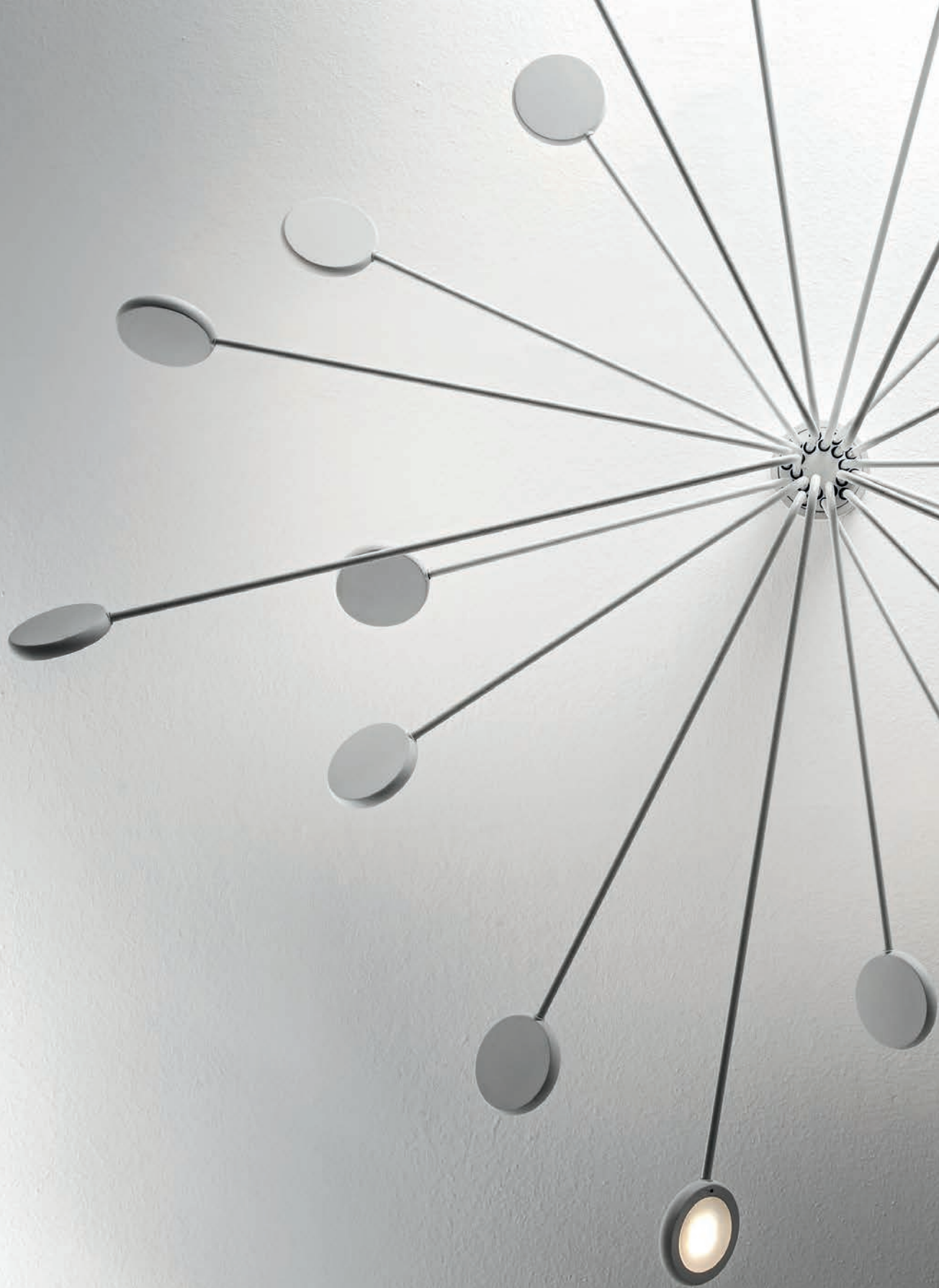

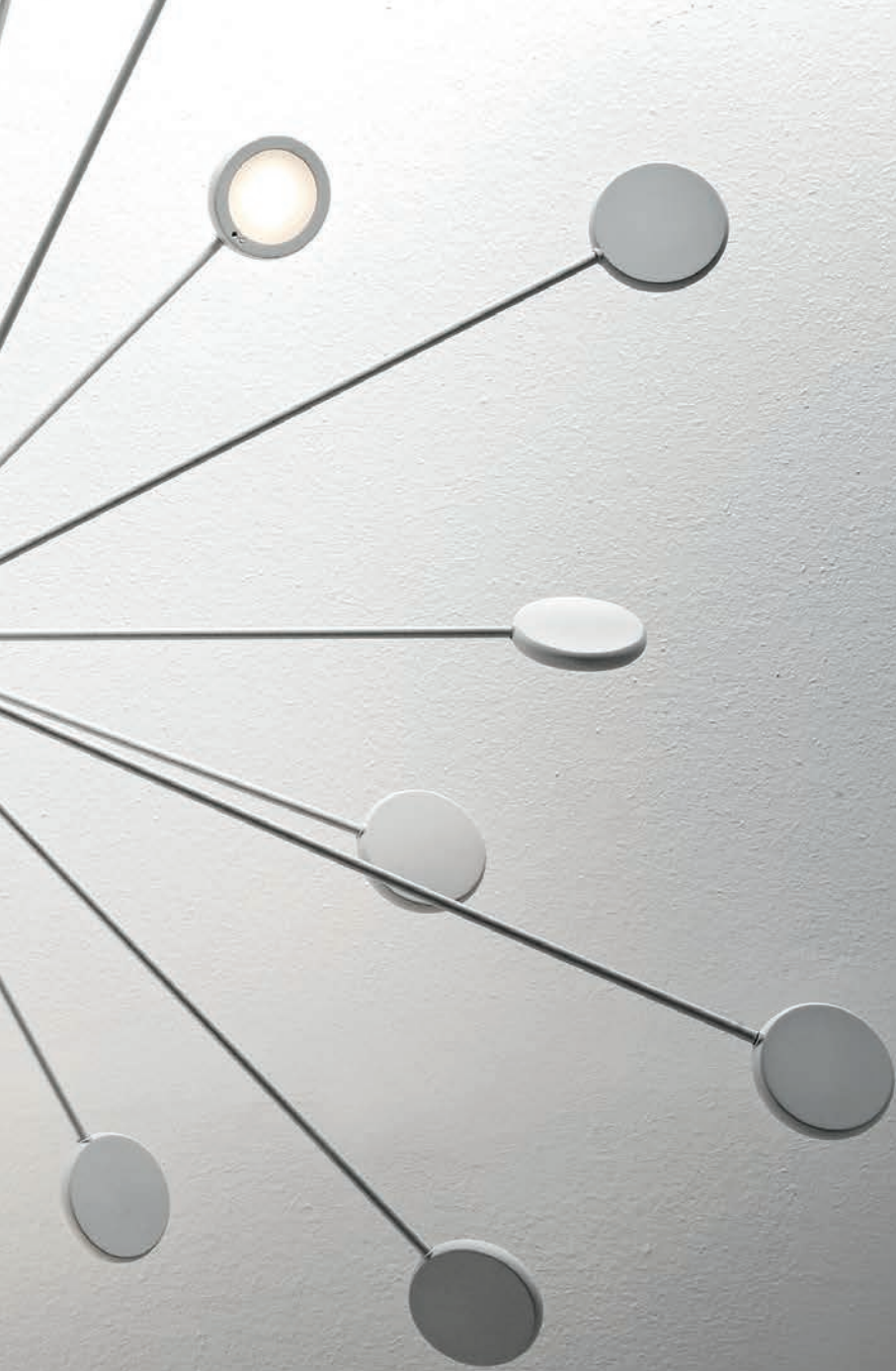

ARBOR

350

sospensione



ARBOR

Marco Pagnoncelli - 2015

Collezione dal design raffinato ed essenziale realizzata da piccolissimi braccetti metallici a sezione circolare alle cui estremità sono collocate le fonti luminose girevoli di forma tonda nelle quali alloggiano led a 220V che non necessitano di alimentatore.

Questa capacità di orientamento dei corpi luce conferisce a questo prodotto una particolarità importante nel suo genere, in quanto in base all'esigenza dell'utente la luce può essere totalmente indiretta, diretta e indiretta, oppure completamente diretta.

Disponibile nella temperatura colore LED 3000 °K e 2700 °K.

SUSPENSION

A collection with an essential and refined design.

Small metal arms hold round adjustable light sources, in which are housed 220V LED that do not need any driver.

The possibility to turn the light sources gives the chance to have direct and indirect lighting, total as well as partial, according to the user's needs.

Available with 3000°K AND 2700°K LED colour temperature.

Modello depositato

Registered design



BI

OS



351

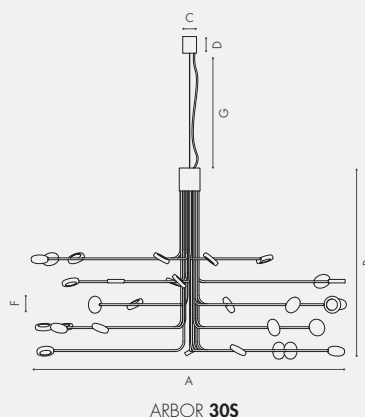
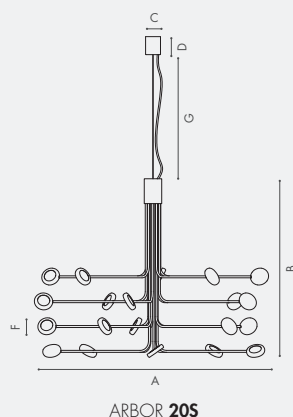
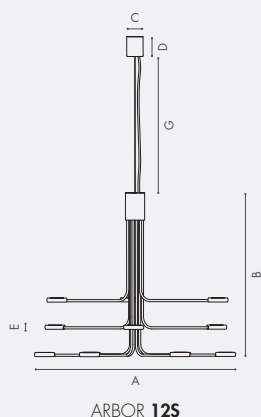

Art.	W	V	Lumen	°K led	A cm	B cm	C cm	D cm	E cm	F cm	G cm
ARBOR 125	60	220-240	4200	3000	70	58	7	9,5	1,1	Ø7	100
ARBOR 205	100	220-240	7000	3000	80	58	7	9,5	1,1	Ø7	100
ARBOR 305	150	220-240	10500	3000	120	70	10	12	1,1	Ø7	100

LED Disponibili a richiesta nella temperatura colore 2700 °K



ARBOR

Marco Pagnoncelli - 2015

Collezione dal design raffinato ed essenziale realizzata da piccolissimi braccetti metallici a sezione circolare alle cui estremità sono collocate le fonti luminose girevoli di forma tonda nelle quali alloggiano led a 220V che non necessitano di alimentatore.

Questa capacità di orientamento dei corpi luce conferisce a questo prodotto una particolarità importante nel suo genere, in quanto in base all'esigenza dell'utente la luce può essere totalmente indiretta, diretta e indiretta, oppure completamente diretta.

Disponibile nella temperatura colore LED 3000 °K e 2700 °K.

A collection with a refined and essential design. Small metal arms hold turning round light sources in which are housed 220V LED boards, no driver is needed.

By turning the light sources, these fittings are unique because following the customer's taste, they give the chance to have total on partial direct and indirect lighting. Available with 3000 °K or 2700 °K LED colour temperature.

Modello depositato



Registered design

BI

OS



353

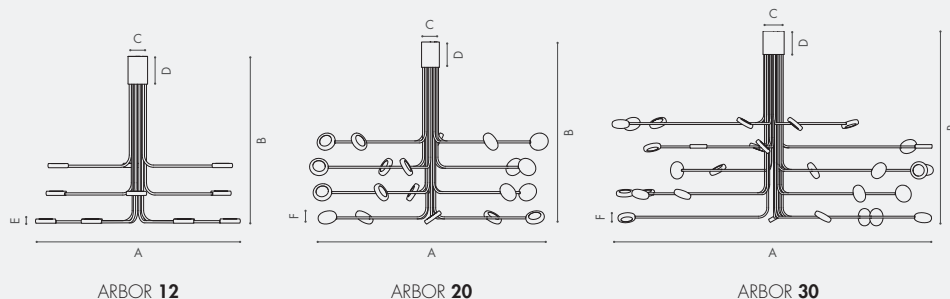

KIT FISSAGGIO
MAGGIORATO

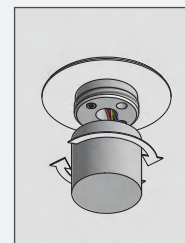

COD. OP.1

Art.	W	V	Lumen	°K led	A cm	B cm	C cm	D cm	E cm	F cm
ARBOR 12	60	220-240	4200	3000	70	58	7	9,5	1,1	Ø7
ARBOR 20	100	220-240	7000	3000	80	58	7	9,5	1,1	Ø7
ARBOR 30	150	220-240	10500	3000	120	70	10	12	1,1	Ø7

LED Disponibili a richiesta nella temperatura colore 2700 °K



ARBOR

Marco Pagnoncelli - 2015

Collezione dal design raffinato ed essenziale realizzata da piccolissimi braccetti metallici a sezione circolare alle cui estremità sono collocate le fonti luminose girevoli di forma tonda nelle quali alloggiano led a 220V che non necessitano di alimentatore. Questa capacità di orientamento dei corpi luce conferisce a questo prodotto una particolarità importante nel suo genere, in quanto in base all'esigenza dell'utente la luce può essere totalmente indiretta, diretta e indiretta, oppure completamente diretta. Disponibile nella temperatura colore LED 3000 °K e 2700 °K.

A collection with a refined and essential design. Small metal arms hold turning round light sources in which are housed 220V LED boards, no driver is needed. By turning the light sources, these fittings are unique because following the customer's taste, they give the chance to have total on partial direct and indirect lighting. Available with 3000 °K or 2700 °K LED colour temperature.

Modello depositato



Registered design

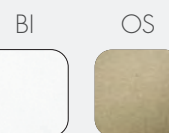
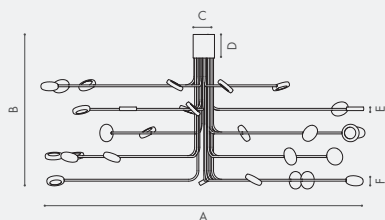

KIT FISSAGGIO
MAGGIORATO

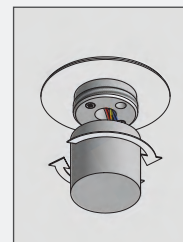

COD. **OP.1**

Art.	W	V	Lumen	°K led	A cm	B cm	C cm	D cm	E cm	F cm
ARBOR 12PL	60	220-240	4200	3000	70	32	7	9,5	1,1	Ø7
ARBOR 20PL	100	220-240	7000	3000	98	32	10	9,5	1,1	Ø7

LED Disponibili a richiesta nella temperatura colore 2700 °K







ARBOR

Marco Pagnoncelli - 2015

LAMPADA TERRA

Collezione dal design essenziale e sorgenti luminose orientabili.

Scheda LED a 24V con

alimentatore integrato

Dimmerabile.

Disponibile con temperatura di colore LED 3000°K e 2700°K

FLOOR LAMP

A collection with an essential design and adjustable light sources.

24V LED board with built-in driver.

Dimmable.

Available with 3000°K and 2700°K LED colour temperature

Modello depositato



Registered design

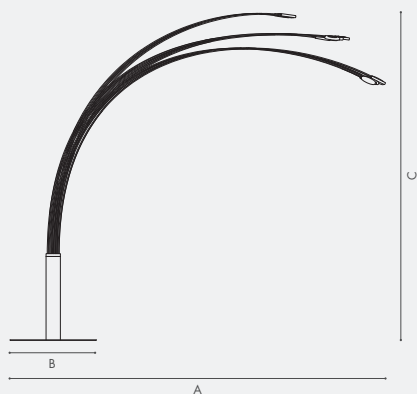

BI



OS



359

Art.	W	V	Lumen	°K led	A cm	B cm	C cm
ARBOR 12ST	60	220-240	5580	3000	200	40	200/220

LED Disponibili a richiesta nella temperatura colore 2700 °K



TECLA



362

tavolo



TECLA

Marco Pagnoncelli - 2016

LAMPADA TAVOLO

Collezione dal design essenziale e sorgente luminosa orientabile.
Regolabile in altezza e con rotazione del braccio
Scheda LED a 24V con alimentatore a spina
Accensione, spegnimento e dimmerazione regolati da sensore ottico.
Disponibile nella temperatura colore LED 3000 °K e 2700 °K.

TABLE LAMP

A collection with an essential design and adjustable light source.
Adjustable height and rotating arm.
24V LED board with plug-in driver.
On/off switching and dimming by optical sensor.
Available with 3000 °K or 2700 °K LED colour temperature.

Modello depositato

Registered design

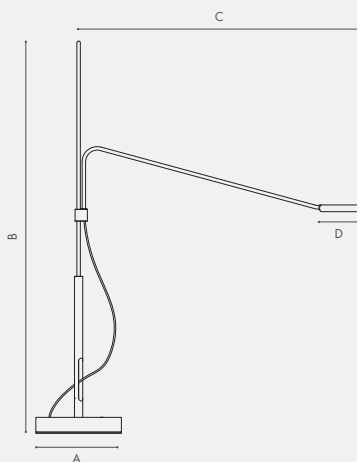

BI

NE



363

Art.	W	V	Lumen	°K led	A cm	B cm	C cm	D cm
TECLA micro	4,1	220-240	465	3000	15	67,5	49	Ø7
TECLA mini	4,1	220-240	465	3000	15	90	59	Ø7
TECLA	4,1	220-240	465	3000	15	90	79	Ø7

LED Disponibili a richiesta nella temperatura colore 2700 °K





TECLA

366

terra



TECLA

Marco Pagnoncelli - 2016



LAMPADA TERRA

Collezione dal design essenziale e sorgente luminosa orientabile. Sorgente luminosa doppia regolabile in altezza e con rotazione del braccio. Scheda LED a 24V con alimentatore a spina. Accensione, spegnimento e dimmerazione regolati da sensore ottico. Disponibile nella temperatura colore LED 3000 °K e 2700 °K.

Modello depositato



FLOOR LAMP

A collection with an essential design and adjustable light source. Double light source with adjustable height and rotating arm. 24V LED board with plug-in driver. On/off switching and dimming by optical sensor. Available with 3000 °K or 2700 °K LED colour temperature.

Registered design

BI



NE



367

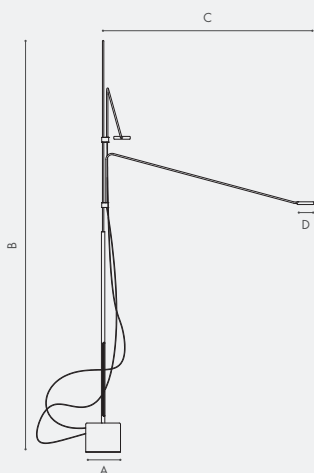

Art.	W	V	Lumen	°K led	A cm	B cm	C cm	D cm
TECLA 2ST	8,2	220-240	930	3000	15	150	79	Ø7

LED Disponibili a richiesta nella temperatura colore 2700 °K

368

terra



TECLA

Marco Pagnoncelli - 2016

LAMPADA TERRA

Collezione dal design essenziale e sorgente luminosa orientabile.

Sorgente luminosa singola regolabile in altezza e con rotazione del braccio

Scheda LED a 24V con alimentatore a spina

Accensione, spegnimento e dimmerazione regolati da sensore ottico.

Disponibile nella temperatura colore LED 3000 °K e 2700 °K.

FLOOR LAMP

A collection with an essential design and adjustable light source.

Single light source with adjustable height and rotating arm.

24V LED board with plug-in driver.

On/off switching and dimming by optical sensor.

Available with 3000 °K or 2700 °K LED colour temperature.



Modello depositato



Registered design

BI

NE



369

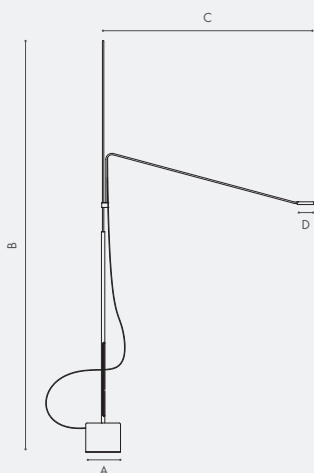

Art.	W	V	Lumen	°K led	A cm	B cm	C cm	D cm
TECLA 1ST	4,1	220-240	465	3000	15	150	79	Ø7

LED Disponibili a richiesta nella temperatura colore 2700 °K

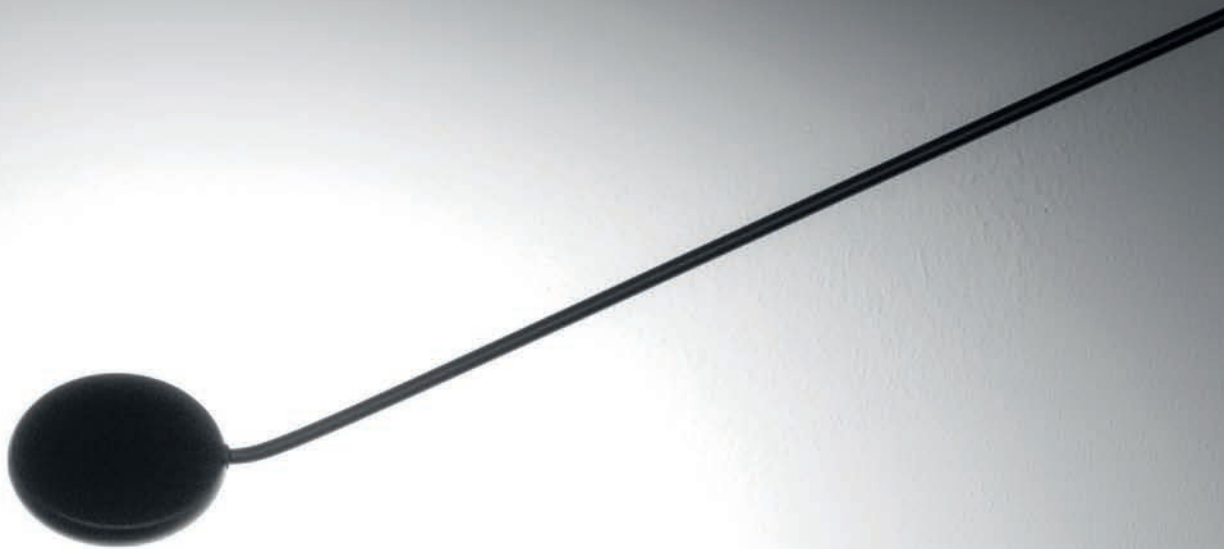



TECLA

372

parete



TECLA

Marco Pagnoncelli - 2016

LAMPADA PARETE

Collezione dal design essenziale e sorgente luminosa orientabile.

Sorgente luminosa singola regolabile in altezza e con rotazione del braccio

Scheda LED a 24V con alimentatore integrato.

Disponibile nella temperatura colore LED 3000 °K e 2700 °K.

WALL LAMP

A collection with an essential design and adjustable light source. Adjustable height and rotating arm.

24V LED board with built-in driver.

Available with 3000 °K or 2700 °K LED colour temperature.

Modello depositato



Registered design



BI

NE



373

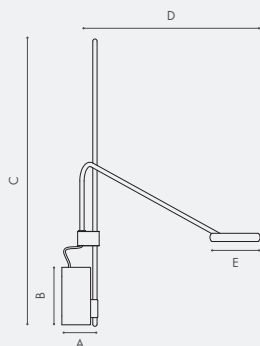

Art.	W	V	Lumen	°K led	A cm	B cm	C cm	D cm	E cm
TECLA AP micro	4,1	220-240	465	3000	7,5	11	60	49	Ø7
TECLA AP mini	4,1	220-240	465	3000	7,5	11	60	59	Ø7
TECLA AP	4,1	220-240	465	3000	7,5	11	60	79	Ø7

LED Disponibili a richiesta nella temperatura colore 2700 °K

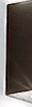



DA DO

376

parete



DA DO

Marco Pagnoncelli - 2012

Faretto da parete con corpo in alluminio.
Illuminazione con biemissione di luce diretta+indiretta.
Fornito con LED 220V che non necessitano di alimentatore.
Finiture colori:
verniciato bianco (BI), verniciato nero (NE).
Disponibile nella temperatura colore LED 3000 °K e 2700 °K.

Wall spotlight with aluminium body.
Lighting with double emission of direct+indirect light. Supplied with 220V LEDs not requiring a power supply unit.
Available in:
white varnish (BI), black varnish (NE).
Available with 3000 °K or 2700 °K LED colour temperature.

Modello depositato

Registered design



BI NE



377

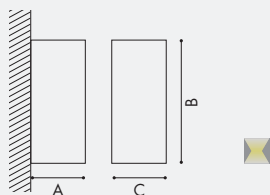

Art.	W	V	Lumen	°K Led	A cm	B cm	C cm
DADO2.10	9,4	220-240	852	3000	5	10	5

LED Disponibili a richiesta nella temperatura colore 2700 °K

378

parete



D A D O

Marco Pagnoncelli - 2012

Faretto da parete con corpo in alluminio.
Fornito con LED 220V che non necessitano di alimentatore.
Finiture colori:
verniciato bianco (BI), verniciato nero (NE).
Disponibile nella temperatura colore LED 3000 °K e 2700 °K.

Wall spotlight with aluminium body.
Supplied with 220V LEDs not requiring a power supply unit.
Available in:
white varnish (BI),
black varnish (NE).
Available with 3000 °K or 2700 °K LED colour temperature.

Modello depositato



Registered design

BI NE



379

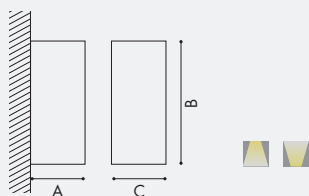

Art.	W	V	Lumen	°K Led	A cm	B cm	C cm
DADO1.10	4,7	220-240	426	3000	5	10	5

LED Disponibili a richiesta nella temperatura colore 2700 °K

380

soffitto



D A D O

Marco Pagnoncelli - 2012

Faretto da soffitto con corpo in alluminio.
Fornito con LED 220V che non necessita di alimentatore.
Finiture colori:
verniciato bianco (BI),
verniciato nero (NE).
Disponibile nella temperatura colore LED 3000 °K e 2700 °K.

Ceiling spotlight with aluminium body.
Supplied with 220V LEDs not requiring a power supply unit.
Available in:
white varnish (BI),
black varnish (NE).
Available with 3000 °K or 2700 °K LED colour temperature.

Modello depositato

Registered design



381

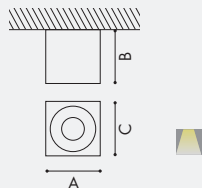

Art.	W	V	Lumen	°K Led	A cm	B cm	C cm
DADO1.5	4,7	220-240	426	3000	5	5	5

LED Disponibili a richiesta nella temperatura colore 2700 °K

382

parete | soffitto



D A D O

Marco Pagnoncelli - 2012

Faretto da parete e soffitto
inclinato con corpo in
alluminio. Fornito con LED 220V
che non necessita di alimentatore.

Finiture colori:

verniciato bianco (BI),
verniciato nero (NE).

Disponibile nella temperatura
colore LED 3000 °K e 2700 °K.

Inclined wall and ceiling spotlight
with aluminium body. Supplied
with 220V LEDs not requiring a
power supply unit.

Available in:

white varnish (BI),
black varnish (NE).

Available with 3000 °K or 2700
°K LED colour temperature.

Modello depositato



Registered design



BI

NE



383

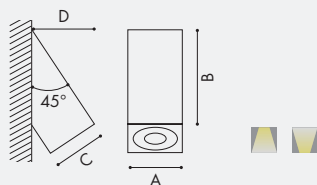

Art.	W	V	Lumen	°K Led	A cm	B cm	C cm	D cm
DADO1.45	4,7	220-240	426	3000	5	8,6	5	5

LED Disponibili a richiesta nella temperatura colore 2700 °K





RUBIC

386

parete | soffitto



RUBIC

Marco Pagnoncelli - 2013

Faretto ad una luce in alluminio tornito da soffitto o parete, orientabile sia nella sorgente luminosa che nell'attacco a parete. Fornito con luce a LED 220V che non necessita di alimentatore.

Finiture colore: bianco laccato a liquido (BI), nero (NE).

Disponibile nella temperatura colore LED 3000 °K e 2700 °K.

Ceiling or wall spotlight with turned aluminium body. Adjustable both in light source and installation.

Supplied with 220V LEDs not requiring a power supply unit.

Available in: white liquid enamel (BI), black (NE).

Available with 3000 °K or 2700 °K LED colour temperature.

Modello depositato



Registered design

387

BI NE

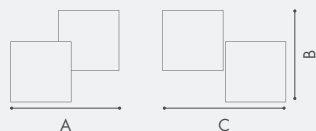

Art.	W	V	Lumen	° K Led	A cm	B cm	C cm
RUBIC5	4,7	220-240	426	3000	9	7,5	10,5

LED Disponibili a richiesta nella temperatura colore 2700 °K



RUBIC

Marco Pagnoncelli - 2013

Faretto a 2 luci in alluminio tornito da soffitto o parete, orientabile sia nella sorgente luminosa che nell'attacco a parete. Fornito con luce a LED 220V che non necessita di alimentatore. Finiture colore: bianco laccato a liquido (BI), nero (NE). Disponibile nella temperatura colore LED 3000 °K e 2700 °K.

Ceiling or wall double spotlight with turned aluminium body. Adjustable both in light source and installation. Supplied with 220V LEDs not requiring a power supply unit. Available in: white liquid enamel (BI), black (NE). Available with 3000 °K or 2700 °K LED colour temperature.

Modello depositato

Registered design



BI NE



389



Art.	W	V	Lumen	° K Led	A cm	B cm	C cm
RUBIC10	9,4	220-240	852	3000	16	9	7,5

LED Disponibili a richiesta nella temperatura colore 2700 °K



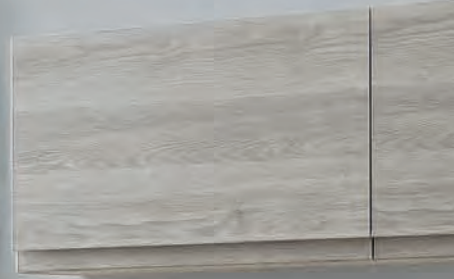

CIDI

392

parete



CIDI

Marco Pagnoncelli - 2013

Lampada da parete orientabile in alluminio dalla forma tonda. Illuminazione a LED 220V che non necessita di alimentatore. Finiture colore: bianco laccato a liquido (BI), titanio (TO). Disponibile nella temperatura colore LED 3000 °K e 2700 °K.

Wall adjustable lamp with round-shaped aluminium body. Supplied with 220V LEDs not requiring a power supply unit. Available in: white liquid enamel (BI), titanium (TO). Available with 3000 °K or 2700 °K LED colour temperature.

Modello depositato

Registered design

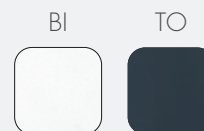

393

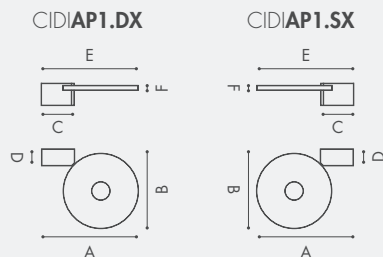

Art.	W	V	Lumen	° K Led	A cm	B cm	C cm	D cm	E cm	F cm
CIDI API.DX	15	220-240	1440	3000	16	17	7	3,5	20	1,8
CIDI API.SX	15	220-240	1440	3000	16	17	7	3,5	20	1,8

LED Disponibili a richiesta nella temperatura colore 2700 °K



CIDI

Marco Pagnoncelli - 2013

Lampada da soffitto orientabile in alluminio dalla forma tonda. Illuminazione a LED 220V che non necessita di alimentatore. Finiture colore: bianco laccato a liquido (BI), titanio (TO). Disponibile nella temperatura colore LED 3000 °K e 2700 °K.

Ceiling adjustable lamp with round-shaped aluminium body. Supplied with 220V LEDs not requiring a power supply unit. Available in: white liquid enamel (BI), titanium (TO). Available with 3000 °K or 2700 °K LED colour temperature.

Modello depositato



Registered design

395

BI TO

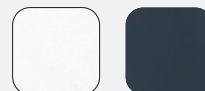

Art.	W	V	Lumen	°K Led	A cm	B cm	C cm	D cm	E cm	F cm
CIDIPL2	30	220-240	2880	3000	36	15	36	16	7	3,5

LED Disponibili a richiesta nella temperatura colore 2700 °K







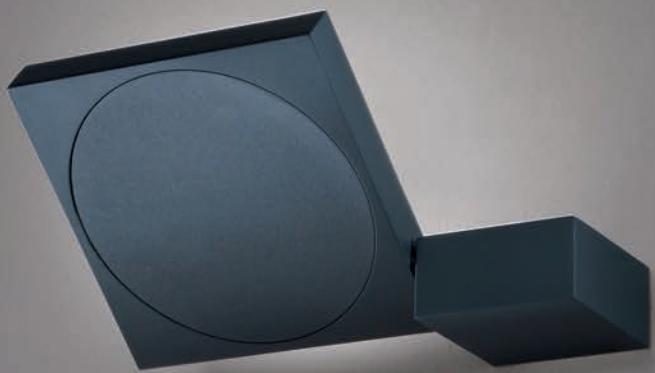

MIX

400

parete

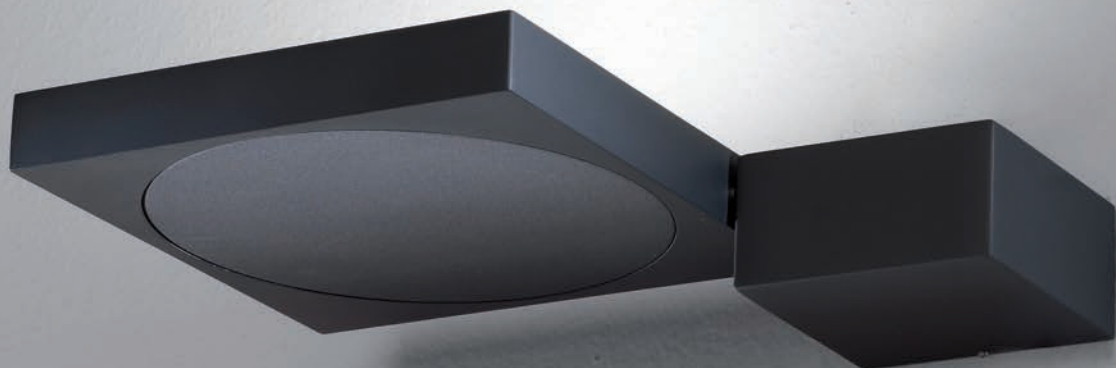

MIX

Marco Pagnoncelli - 2013

Lampada da parete orientabile in alluminio dalla forma quadrata. Illuminazione a LED 220V che non necessita di alimentatore. Finiture colore: bianco laccato a liquido (BI), titanio (TO). Disponibile nella temperatura colore LED 3000 °K e 2700 °K.

Wall adjustable lamp with square-shaped aluminium body. Supplied with 220V LEDs not requiring a power supply unit. Available in: white liquid enamel (BI), titanium (TO). Available with 3000 °K or 2700 °K LED colour temperature.

Modello depositato

Registered design



401

MIXAP1.DX

MIXAP1.SX

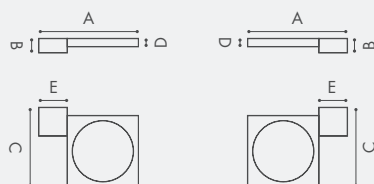

Art.	W	V	Lumen	° K Led	A cm	B cm	C cm	D cm	E cm
MIXAP1.DX	15	220-240	1440	3000	21	3,5	17,5	1,8	7
MIXAP1.SX	15	220-240	1440	3000	21	3,5	17,5	1,8	7

LED Disponibili a richiesta nella temperatura colore 2700 °K

402



soffitto

MIX

Marco Pagnoncelli - 2013

Lampada da soffitto orientabile in alluminio dalla forma quadrata. Illuminazione a LED 220V che non necessita di alimentatore. Finiture colore: bianco laccato a liquido (BI), titanio (TO). Disponibile nella temperatura colore LED 3000 °K e 2700 °K.

Ceiling adjustable lamp with square-shaped aluminium body. Supplied with 220V LEDs not requiring a power supply unit. Available in: white liquid enamel (BI), titanium (TO). Available with 3000 °K or 2700 °K LED colour temperature.

Modello depositato



Registered design

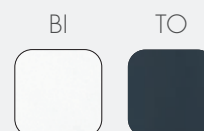

403

MIXPL2

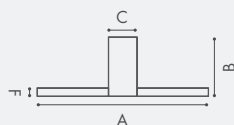

MIXPL2

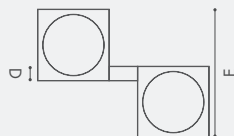

MIXAP2

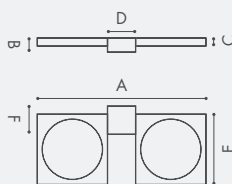

Art.	W	V	Lumen	° K Led	A cm	B cm	C cm	D cm	E cm	F cm
MIXPL2	30	220-240	2880	3000	35	14,5	7	3,5	24,5	1,8
MIXAP2	30	220-240	2880	3000	35	3,5	1,8	7	17,5	7

LED Disponibili a richiesta nella temperatura colore 2700 °K

La **serie PIASTRA** è composta da due piastre dello spessore di 3 mm. in ferro sovrapposte a luce indiretta. La piastra posteriore viene decorata con foglia oro o argento a scelta, mentre la piastra anteriore viene arrugginita naturalmente con cicli di bagnatura e asciugatura all'aperto per più di 21 giorni. Ciò significa che, ad ogni partita di lastre di ferro, a seconda della percentuale di piombo ed acciaio contenuti, la colorazione finale della ruggine varia.

Tale variazione è pertanto da considerarsi una particolarità della lampada e non un difetto di fabbricazione.

The **PIASTRA series** consists of two overlapping ironplates, 3-mm thick, with indirect light. The rear plate is decorated with gold or silver leaf as desired, while the front plate is naturally rusted by means of wetting and drying cycles outdoors for more than 21 days. This means that, with each lot of iron slabs, depending on the percentage of lead and steel contained in the same slabs, the final colour of the rust may vary.

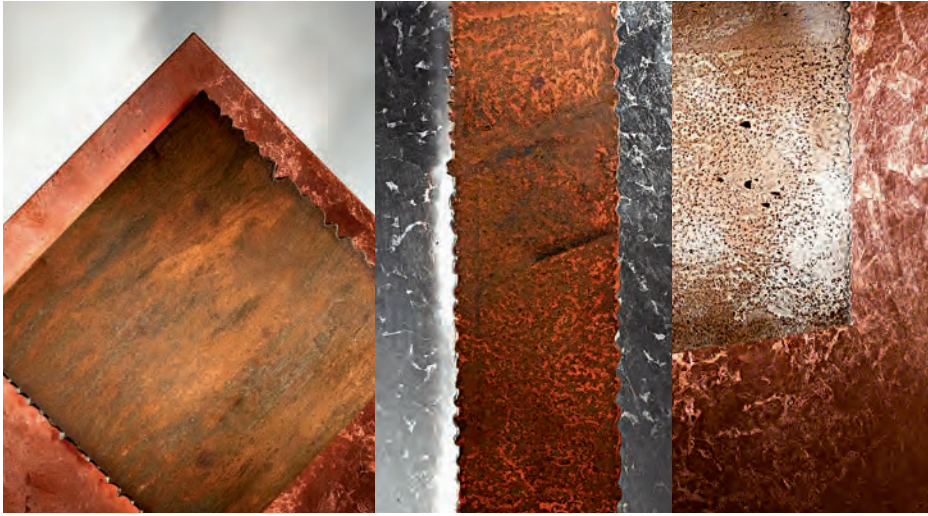
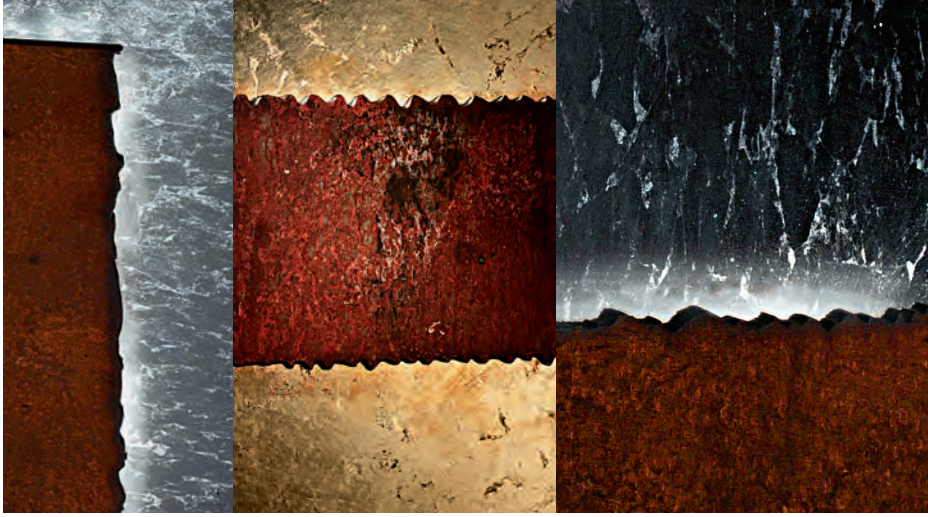
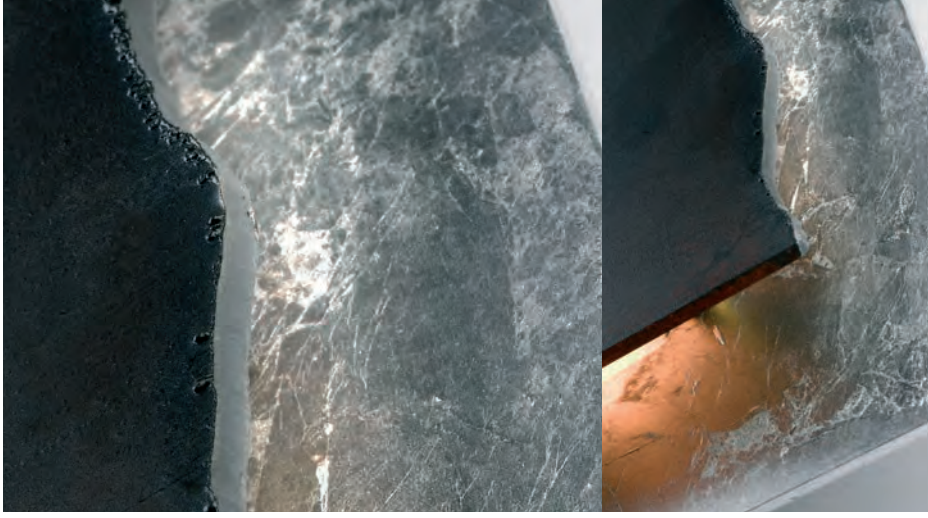

PIASTRA



PIASTRA

Marco Pagnoncelli - 2005

Lampada da parete in metallo a luce diffusa a LED, rivestita a mano con foglia argento (FA) o foglia oro (FO).
Elemento decorativo in ferro arrugginito.

Wall lamp made in metal with diffused lighting LED, hand-lined with silver leaf (FA) or gold leaf (FO).
Decoration in rusted iron.

Modello depositato

Registered design



FA

FO



407

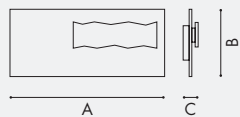

Art.	W	V	Lumen	°K Led	A cm	B cm	C cm
PIASTR RP LED	10	220-240	700	3000	30	20	7
PIASTR RM LED	25	220-240	1750	3000	80	35	7
PIASTR RG LED	50	220-240	3500	3000	160	20	7

LED Disponibili a richiesta nella temperatura colore 2700 °K

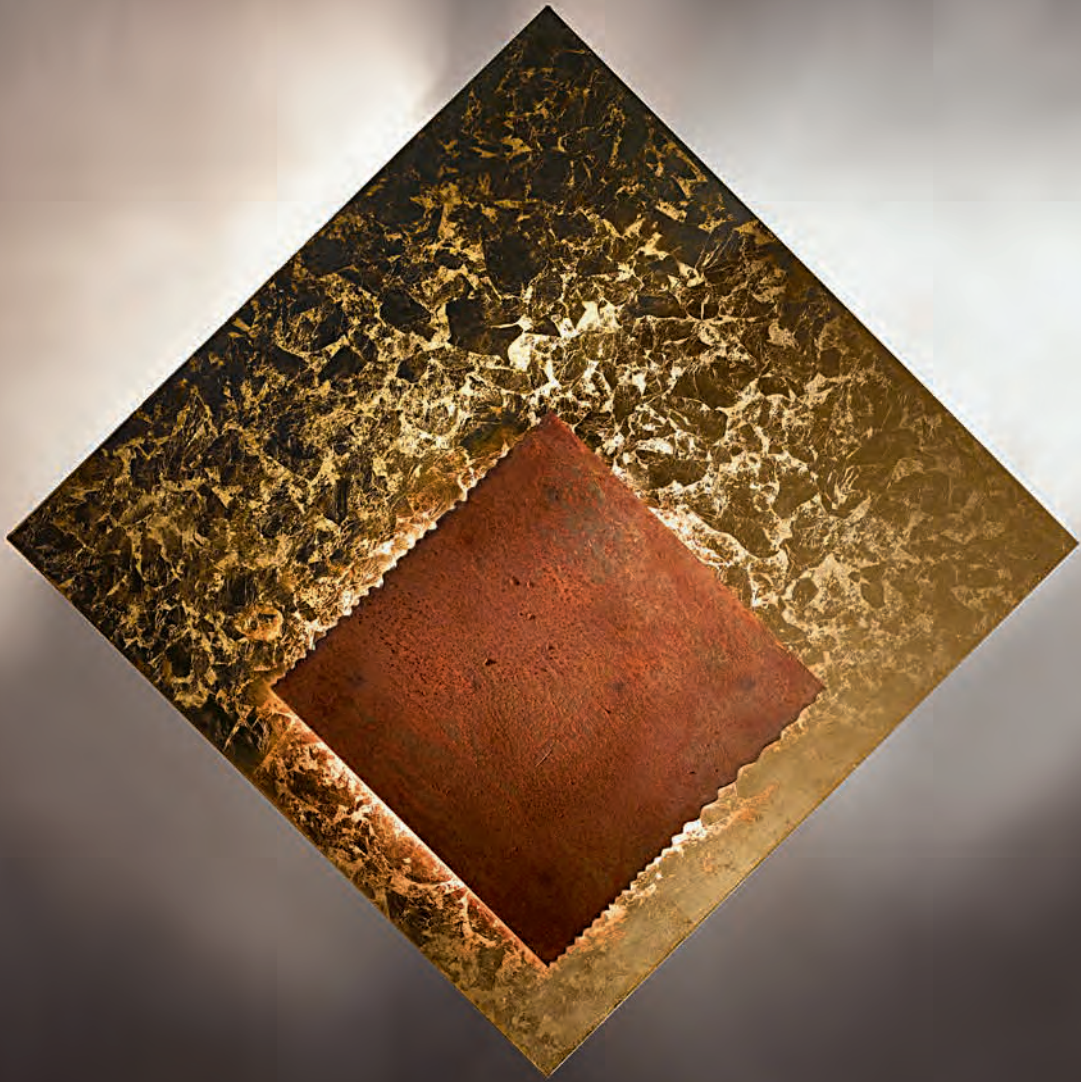

PIASTRA

Marco Pagnoncelli - 2005

La **serie PIASTRA** è composta da due piastre dello spessore di 3 mm. in ferro sovrapposte a luce indiretta. La piastra posteriore viene decorata con foglia oro o argento a scelta, mentre la piastra anteriore viene arrugginita naturalmente con cicli di bagnatura e asciugatura all'aperto per più di 21 giorni. Ciò significa che, ad ogni partita di lastre di ferro, a seconda della percentuale di piombo ed acciaio contenuti, la colorazione finale della ruggine varia.

Tale variazione è pertanto da considerarsi una particolarità della lampada e non un difetto di fabbricazione.

The **PIASTRA series** consists of two overlapping ironplates, 3-mm thick, with indirect light. The rear plate is decorated with gold or silver leaf as desired, while the front plate is naturally rusted by means of wetting and drying cycles outdoors for more than 21 days. This means that, with each lot of iron slabs, depending on the percentage of lead and steel contained in the same slabs, the final colour of the rust may vary.

Modello depositato

Registered design



FA

FO



409

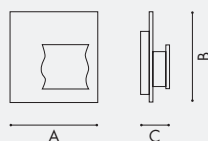

Art.	W	V	Lumen	°K Led	A cm	B cm	C cm
PIASTRA QG LED	35	220-240	2450	3000	70	70	7
PIASTRA QM LED	25	220-240	1750	3000	50	50	7
PIASTRA QP LED	25	220-240	1750	3000	35	35	7

LED Disponibili a richiesta nella temperatura colore 2700 °K





SAGGINA

412

sospensione



SAGGINA

Marco Pagnoncelli - 2003

Lampada a sospensione modellabile a luce diffusa, realizzata con fili di rame, nelle finiture: cromo lucido (CR). La forma data ai fili di rame, personalizza la lampada.

Mouldable hanging lamp with diffused lighting, made with copper wires, with the following finishes: polished chrome (CR). The shape given to the copper wires personalises the lamp.

Trasformatore toroidale

Toroidal transformer

Modello depositato

Registered design



CR



413

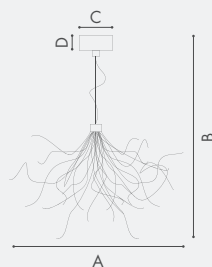

Art.	W	V	Attacco/Socket	A cm	B cm	C cm	D cm
SAGGINA 12S	12x20	12	G4	Ø50/110	80/150	8	Ø17,5
SAGGINA 24S	24x20	12	G4	Ø60/160	90/160	10	21,5



SAGGINA

Marco Pagnoncelli - 2003

Lampada a sospensione modellabile a luce diffusa, realizzata con fili di rame, nelle finiture: cromo lucido (CR). La forma data ai fili di rame, personalizza la lampada.

Mouldable hanging lamp with diffused lighting, made with copper wires, with the following finishes: polished chrome (CR). The shape given to the copper wires personalises the lamp.

Trasformatore toroidale

Toroidal transformer

Modello depositato

Registered design



CR

415

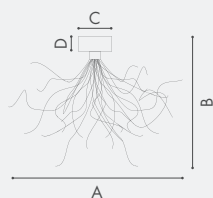

Art.	W	V	Attacco/Socket	A cm	B cm	C cm	D cm
SAGGINA 12	12x20	12	G4	Ø50/110	40/80	8	Ø17,5
SAGGINA 24	24x20	12	G4	Ø60/160	30/90	10	Ø21,5



416

parete | soffitto

SAGGINA

Marco Pagnoncelli - 2003

Lampada a soffitto o parete modellabile a luce diffusa, realizzata con fili di rame, nelle finiture: cromo lucido (CR). La forma data ai fili di rame, personalizza la lampada.

Mouldable ceiling or wall lamp with diffused lighting, made with copper wires, with the following finishes: polished chrome (CR). The shape given to the copper wires personalises the lamp.

Trasformatore toroidale

Toroidal transformer

Modello depositato

Registered design



CR



417

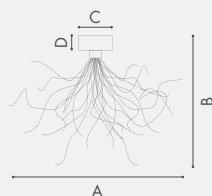

Art.	W	V	Attacco/Socket	A cm	B cm	C cm	D cm
SAGGINA 3	3x20	12	G4	Ø20/45	15/35	7	Ø10
SAGGINA 6	6x20	12	G4	Ø30/90	30/70	7	Ø14



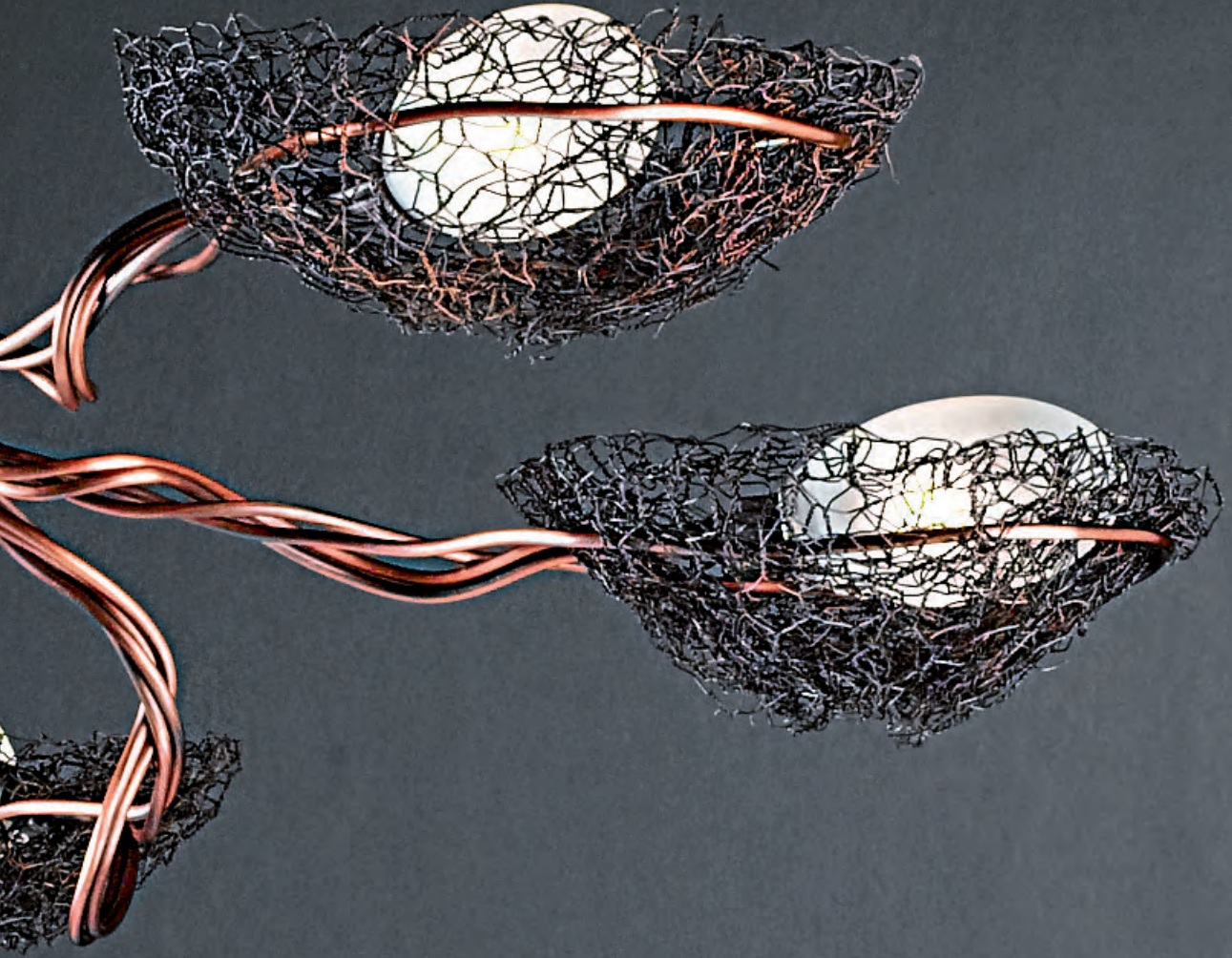

NIDO

420

parete | soffitto



NIDO

Marco Pagnoncelli - 2004

Lampada a sospensione o a parete a luce diffusa dalla forma personalizzabile. Trecce in rame formate manualmente nelle colorazioni rame bronzato (RA). Nidi realizzati in rete metallica interamente a mano con finitura rame bronzato o nikel. L'uovo in vetro soffiato che riveste la lampadine è semplicemente appoggiato nel nido.

Hanging and wall lamp with diffused lighting and personalised shape. Hand-made copper braids in the bronzed copper, gold or nickel colouring. Nests made in metallic mesh, entirely by hand, with a bronzed copper (RA). The egg in blown glass that lines the light bulb is simply placed inside the nest.

Modello depositato

Registered design



RA



421



Art.	W	V	Attacco/Socket	A/B	Nido cm
NIDO 2	2x60	220-240	G9	Variabile a modellazione	Ø18
NIDO 3	3x60	220-240	G9	Variabile a modellazione	Ø18
NIDO 6	6x60	220-240	G9	Variabile a modellazione	Ø18



NIDO

Marco Pagnoncelli - 2004

Lampada a sospensione o a parete a luce diffusa dalla forma personalizzabile. Trecce in rame formate manualmente nelle colorazioni rame bronzato (RA). Nidi realizzati in rete metallica interamente a mano con finitura rame bronzato. L'uovo in vetro soffiato che riveste la lampadine è semplicemente appoggiato nel nido.

Hanging and wall lamp with diffused lighting and personalised shape. Hand-made copper braids in the bronzed copper. Nests made in metallic mesh, entirely by hand, with a bronzed copper (RA). The egg in blown glass that lines the light bulb is simply placed inside the nest.

Modello depositato

Registered design



RA



423



Art.	W	V	Attacco/Socket	A/B	Nido cm
NIDO API P	1x75	220-240	G9	Variabile a modellazione	Ø18
NIDO API G	1x100	220-240	E14	Variabile a modellazione	Ø23



NIDO

Marco Pagnoncelli - 2004

Lampada da tavolo a luce diffusa dalla forma definita, realizzata in rete metallica interamente a mano con finitura rame bronzato (RA). L' uovo in vetro soffiato che riveste la lampadine è semplicemente appoggiato nel nido. Accensione e regolazione si ottiene toccando in qualsiasi punto il filo metallico modellabile.

Table lamp with diffused lighting and permanent shape, made entirely by hand in metallic mesh with bronzed copper (RA). The glass egg that lines the light bulbs is simply placed inside the nest. Touch the mouldable wire anywhere to turn on the lamp and adjust it.

Modello depositato



Registered design

RA



425



Art.	W	V	Attacco/Socket	A/B	A cm	Nido cm
NIDOLP	1x60	220-240	G9	Variabile a modellazione	Ø10	Ø18





SALSOLA



SALSOLA

Marco Pagnoncelli - 2011

Lampada da terra o da appoggio per interni, disponibile nelle versioni: bianco (BI), old brown (OB). Completa di cavo di alimentazione con interruttore.

Indoor ceiling/wall light available in: white (BI), old brown (OB).

Le dimensioni dell'oggetto possono risultare variabili, in virtù della sua realizzazione in gran parte manuale.

The products may vary slightly in size due to the fact that they are manufactured predominantly by hand.

Modello depositato

Registered design

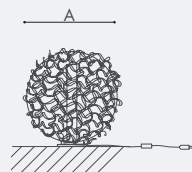

BI

OB



429

Art.	V	Attacco/Socket	A cm
SALSOLA 48LT-IN1	220-240	E27 max 105w o Energy saving	48
SALSOLA 65LT-IN1	220-240	E27 max 105w o Energy saving	65
SALSOLA 85LT-IN1	220-240	E27 max 200w o Energy saving	85

CE CL I IP20



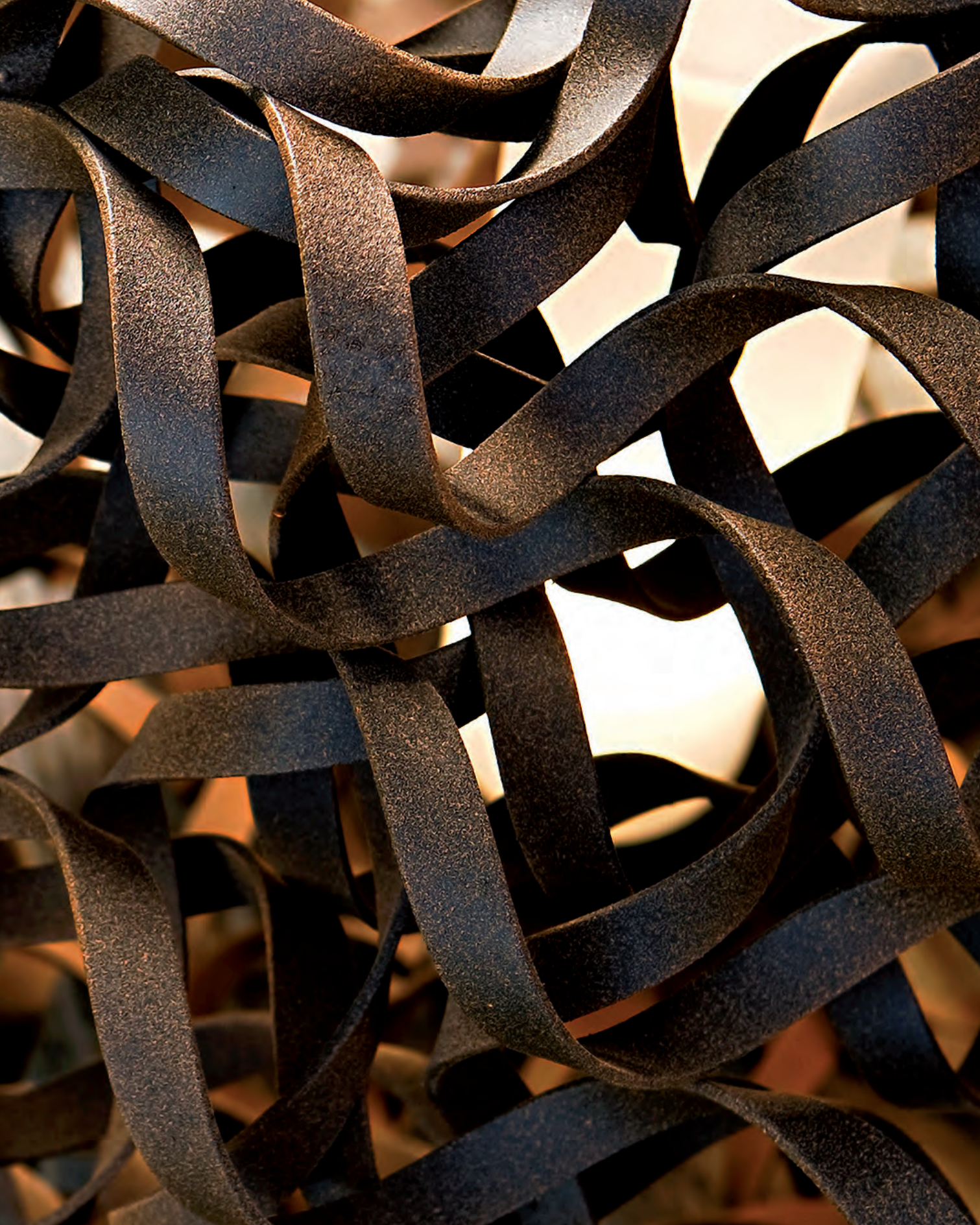



SALSOLA

Marco Pagnoncelli - 2011

Lampada da terra o da appoggio riposizionabile (MO) per esterni **IP55**, disponibile solo nella versione struttura d'alluminio con finiture bianco (BI), old brown (OB). Completa di cavo di alimentazione (mt. 5) e spina **IP44**.

I prodotti SALSOLA OUTSIDE sono sottoposti a trattamenti anticorrosivi. Una protezione di fondo, testata a 700 h in nebbia salina, più la finitura colore, testata a 240 h in nebbia salina, assicurano una notevole durata nel tempo.

Le dimensioni dell'oggetto possono risultare variabili, in virtù della sua realizzazione in gran parte manuale.

Repositionable outdoor floor or table lamp (MO) **IP55** rating, available with aluminium structure only and white (BI), old brown (OB) finish. Complete with power cable (mt. 5) and **IP44** plug.

SALSOLA OUTSIDE products are treated with anti-corrosive coatings. A protective undercoat, tested for 700 hrs in saline fog and a colour finish, tested for 240 hrs in saline fog, ensure these products an extremely long life.

The products may vary slightly in size due to the fact that they are manufactured predominantly by hand.

Modello depositato

Registered design

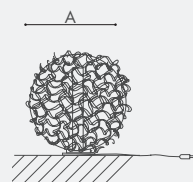

Art.	V	Attacco/Socket	A cm
SALSOLA 48MO-OU1	220-240	E27 max 105w o Energy saving	48
SALSOLA 65MO-OU1	220-240	E27 max 105w o Energy saving	65
SALSOLA 85MO-OU1	220-240	E27 max 200w o Energy saving	85

CE CLI IP55

BI OB

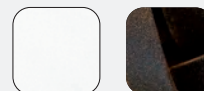



SALSOLA

Marco Pagnoncelli - 2011

Lampada da terra fissa (FX) per esterni, disponibile solo nella versione struttura d'alluminio con finiture bianco (BI), old brown (OB).

I prodotti SALSOLA OUTSIDE sono sottoposti a trattamenti anticorrosivi. Una protezione di fondo, testata a 700 h in nebbia salina, più la finitura colore, testata a 240 h in nebbia salina, assicurano una notevole durata nel tempo.

Le dimensioni dell'oggetto possono risultare variabili, in virtù della sua realizzazione in gran parte manuale.

Fixed outdoor floor lamp (FX) available with aluminium structure only and white (BI), old brown (OB) finish.

SALSOLA OUTSIDE products are treated with anti-corrosive coatings. A protective undercoat, tested for 700 hrs in saline fog and a colour finish, tested for 240 hrs in saline fog, ensure these products an extremely long life.

The products may vary slightly in size due to the fact that they are manufactured predominantly by hand.

Modello depositato

Registered design

435

BI

OB

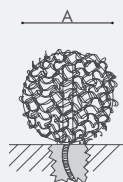

Art.	V	Attacco/Socket	A cm
SALSOLA 48FX-OU1	220-240	E27 max 105w o Energy saving	48
SALSOLA 65FX-OU1	220-240	E27 max 105w o Energy saving	65
SALSOLA 85FX-OU1	220-240	E27 max 200w o Energy saving	85

CE CL I IP55

L'azienda si riserva, ferme restando le caratteristiche basilari del prodotto, di apportare senza preavviso tutte le modifiche che riterrà necessarie allo scopo di migliorare la qualità del prodotto stesso. La proprietà, la realizzazione e riproduzione delle caratteristiche estetiche e costruttive qui illustrate sono riservate a termini di legge. I colori hanno valore indicativo in quanto soggetti alle tolleranze dei processi di stampa.

While maintaining the basic characteristics of the product, the Manufacturer reserves the right to make modifications at any time and without any prior notice, with the sole aim of improving the quality of the product. The property, realization and reproduction of aesthetics, design and manufacturing characteristics, here illustrated, are reserved by law. Colours are merely indicative as they are subject to alterations in the printing process.

PROGETTO CREATIVO: **Grafinvest.it** STAMPA: **Grafinvest+** STAMPATO: **Maggio 2023**

È vietata la riproduzione anche parziale di questo catalogo. It is forbidden to reproduce any part of this catalogue.



Via Vittorio Veneto, 57
24041 BREMBATE (BG) - IT
Tel. +39.035.801239
Fax +39.035.802989
italia@iconeluce.com
sales@iconeluce.com
www.iconeluce.com





iconeluce.com