

 . CANGINI & TUCCI<sup>®</sup>

COMPANY PROFILE





## Cangini e Tucci, qualche dato.

Cangini e Tucci è un'azienda familiare con sede a Cesena, in Emilia Romagna.

**Anno di fondazione:** 1961

**Numero dipendenti:** 18 + 3 soci

**Brevetti depositati:** 12

**Sede:** Via Archimede 36, 47521 - Cesena (FC)

**Showroom:** Pacini & Cappellini - Via Albricci 7, 20122 - Milano (MI)

## Cangini and Tucci, some facts.

Cangini and Tucci is a family business based in Cesena, Emilia Romagna.

**Year founded:** 1961

**Number of employees:** 18 + 3 partners

**Patents:** 12

**Headquarters:** Via Archimede 36, 47521 - Cesena (FC)

**Showroom:** Pacini & Cappellini - Via Albricci 7, 20122 - Milan (MI)

## STORIA DI UNA RIVOLUZIONE AZIENDALE STORY OF A BUSINESS REVOLUTION



Fondata nel 1961 dal maestro Gino Luigi Cangini a Cesena (FC), che apprende fin dalla giovanissima età varie tecniche di lavorazione del vetro. L'arte predominante ispira ad una lavorazione di un vetro pregiato (borosilicato) soffiato a lume e modellato interamente a mano. Autentico ideatore, si producono collezioni artistiche di oggetti da regalo e di arredamento per la casa.

Dopo un grande successo nel campo dell'oggettistica, nel 1987 Gino Cangini si ritira e subentrano il genero e le figlie.

La Cangini e Tucci negli anni continua comunque a mantenere la sua peculiare caratteristica artigianale. Vero anticipatore, dal 2001 il genero Pietro Tucci inizia a produrre i primi corpi illuminanti in vetro borosilicato, materiale che fino ad allora non era mai stato utilizzato nel settore illuminotecnico, ricevendo apprezzamenti e stima da parte del pubblico il quale ha spinto ad incrementare il catalogo prodotti avvalendosi di giovani designer, fino ad affermare totalmente l'azienda nell'illuminazione senza mai perdere le caratteristiche artigianali che la contraddistinguono da sempre.

*Founded in 1961 by master Gino Luigi Cangini in Cesena, FC, who learned various glassmaking techniques from a very young age. The predominant art inspires a working of a fine glass (borosilicate) lamp-blown and shaped entirely by hand. An authentic creator, artistic collections of giftware and home furnishings are produced.*

*After great success in the giftware field, Gino Cangini retired in 1987 and was succeeded by his son-in-law and daughters.*

*Cangini and Tucci over the years, however, continues to maintain its distinctive craftsmanship. A true forerunner, from 2001 son-in-law Pietro Tucci began producing the first lighting fixtures in borosilicate glass, a material that until then had never been used in the lighting industry, receiving appreciation and esteem from the public which prompted them to increase the product catalog by making use of young designers, until the company became totally established in lighting without ever losing the craftsmanship characteristics that have always distinguished it.*

**MADE IN ITALY PER DAVVERO.  
MADE IN ITALY FOR REAL.**

I valori che si trasmettono ogni giorno nella produzione dei prodotti sono di pura qualità artigianale: la cura dei particolari, unita all'impiego di una superiore qualità dei materiali, costituiscono gli obiettivi principali, al fine di offrire alla stimata clientela un prodotto sempre unico nel suo genere.

Il design, la scelta dei particolari, dei decori e la variegata offerta dei colori, sono affidati ad abili esperti, che con grande passione studiano le soluzioni più interessanti per la modellistica.

Ogni lavorazione viene eseguita interamente a mano e questo consente ad ogni prodotto di essere assolutamente originale.

Per questo motivo le dimensioni degli oggetti possono variare di alcuni millimetri rispetto a quelle elencate, certi che questo aggiunge pregio e ne garantisce l'autenticità.

Ogni singolo pezzo della produzione CANGINI E TUCCI è unico, autentico e rigorosamente Made in Italy.

*The values that are conveyed every day in the production of the products are of pure craftsmanship quality: attention to detail, combined with the use of superior quality materials, are the main objectives, in order to offer the esteemed clientele a product that is always unique.*

*The design, the choice of details, decorations and the varied offer of colors, are entrusted to skilled experts, who with great passion study the most interesting modeling solutions.*

*Each work is done entirely by hand, which allows each product to be absolutely original.*

*For this reason, the dimensions of the objects may vary by a few millimeters from those listed, certain that this adds value and guarantees their authenticity.*

*Every single piece of CANGINI E TUCCI production is unique, authentic and strictly Made in Italy.*

**PRODOTTI  
PRODUCTS**

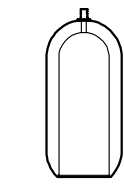

AERON®

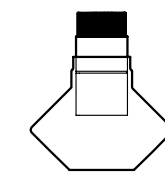

AUF®

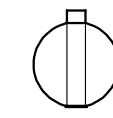

ECLISSE®

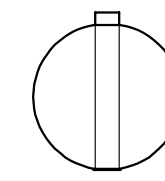

ECLISSE MAX®

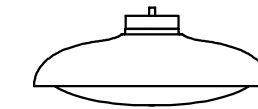

FIJI®

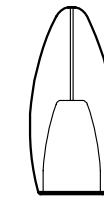

FLUTE®

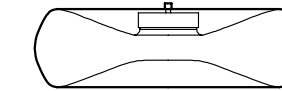

FOLD®

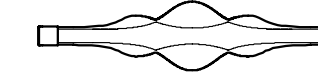

FREQUENCY®  
21

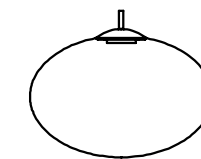

GEO®  
87

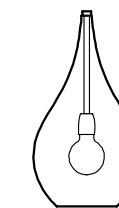

LACRIMA®  
183

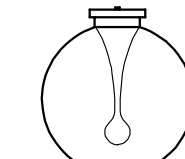

LA STILLA®  
65

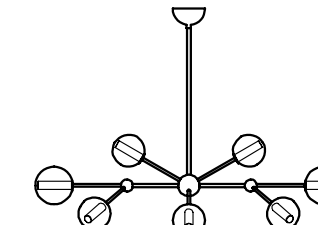

MIREA®  
163

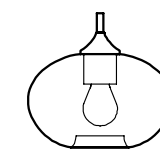

PARIGI®  
191

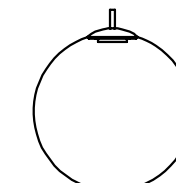

PIT®  
73

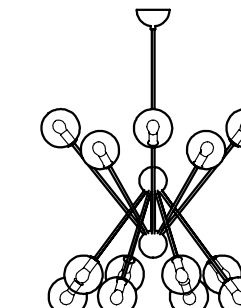

SCARLETT®  
175



TAO®  
157

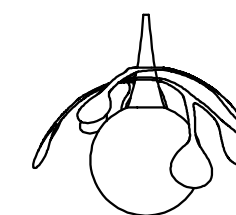

VEGETAL®  
53

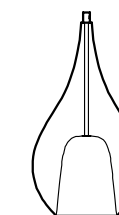

ZOE®  
35

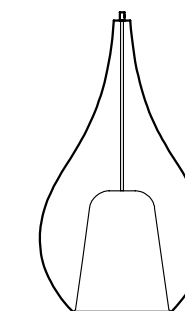

ZOE® MAX  
45



ZOE VGM®  
201

# LED E TECNOLOGIA

## LED AND TECHNOLOGY

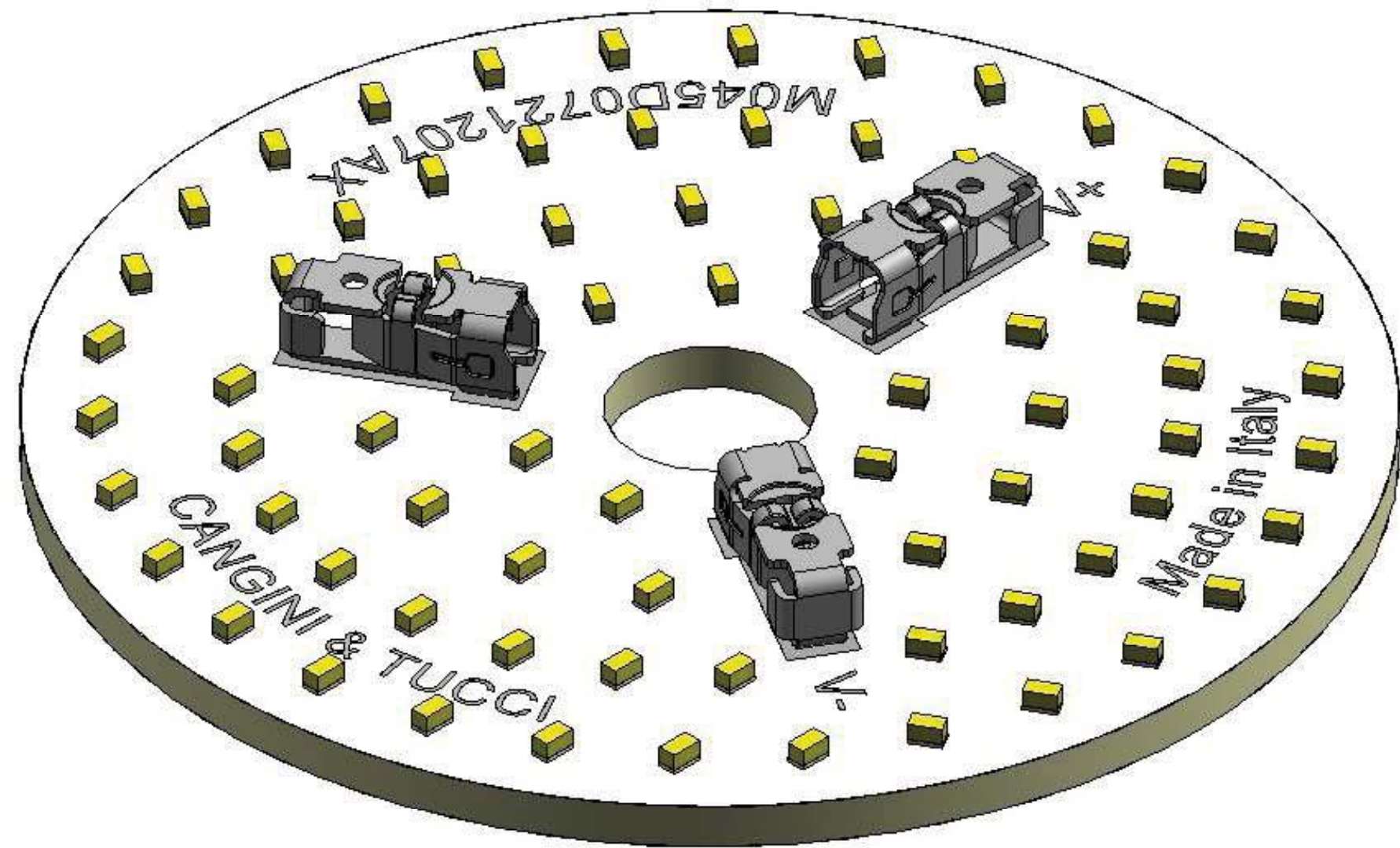









Sulle nostre lampade montiamo LED ad alto potenziale di ultima generazione.

Cerchiamo di raggiungere un ottimo livello di performance di illuminazione senza per questo andare ad intaccare la qualità della luce e l'affidabilità delle nostre sorgenti, cose che per noi restano prioritarie.

*We mount the latest generation of high-power LEDs on our lamps.*

*We try to achieve a very good level of lighting performance without going to the detriment of light quality and reliability of our sources, things that remain priorities for us.*

### CARATTERISTICHE TECNICHE

|   |           |   |            |   |         |   |   |
|---|-----------|---|------------|---|---------|---|---|
|  | Ø57 x 6mm | Lm  | 2370Lm     |  | /       | IP  | 20  |
|  | 500mA     | Lm/w  | 134,3 Lm/W | CRI   | Typ. 95 |  | 50000 hrs.  |
| W   | 17,4W     | LED   | 72         | MacAdam   | 3       | DIMM  | SI  |
| V   | 32-40V    |  | /          |  | 180°    | CE  |  |
|   |           |   |            |   |         |   |  |

# DESIGN, BREVETTI E INNOVAZIONE

## DESIGN, PATENTS AND INNOVATION

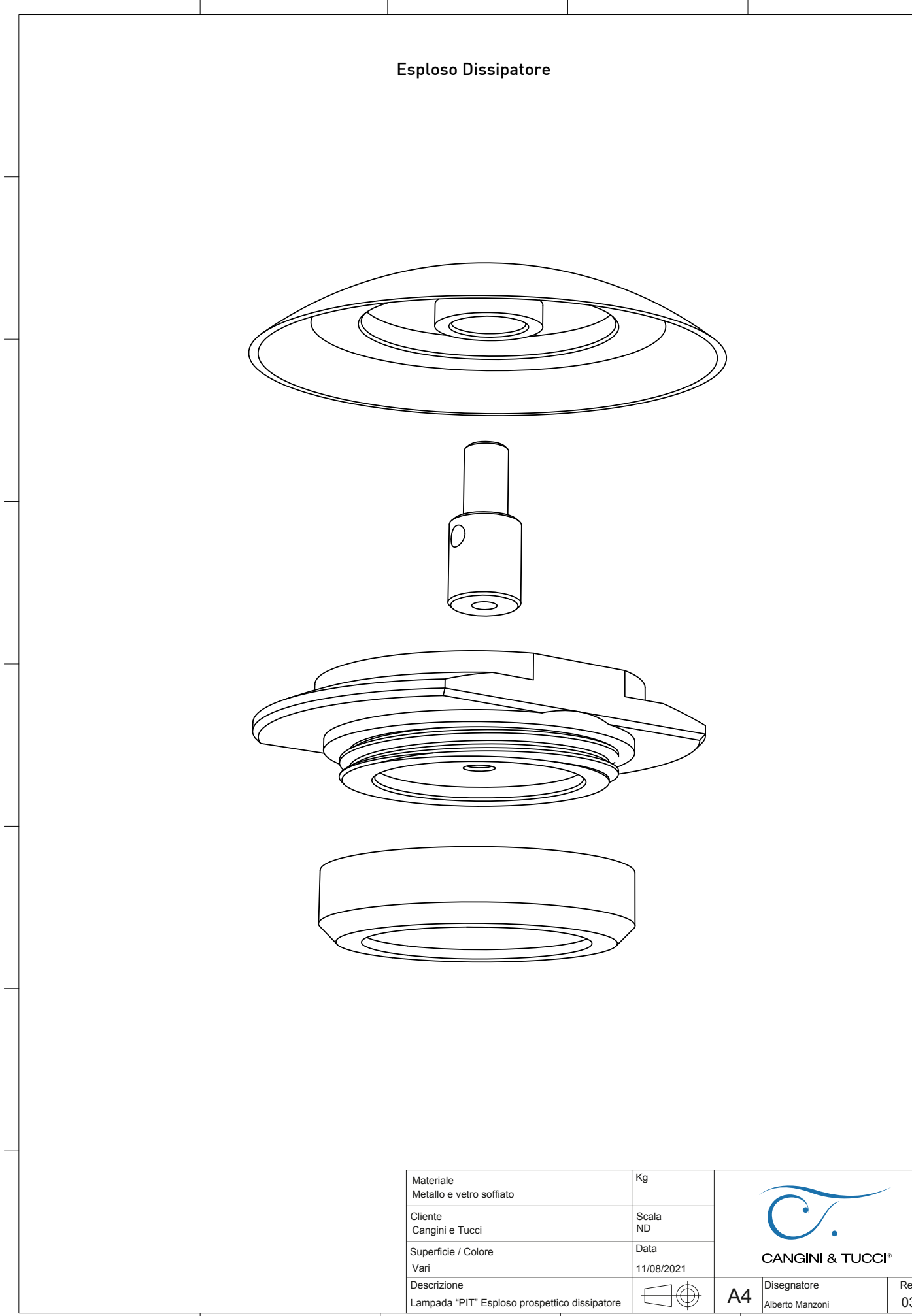
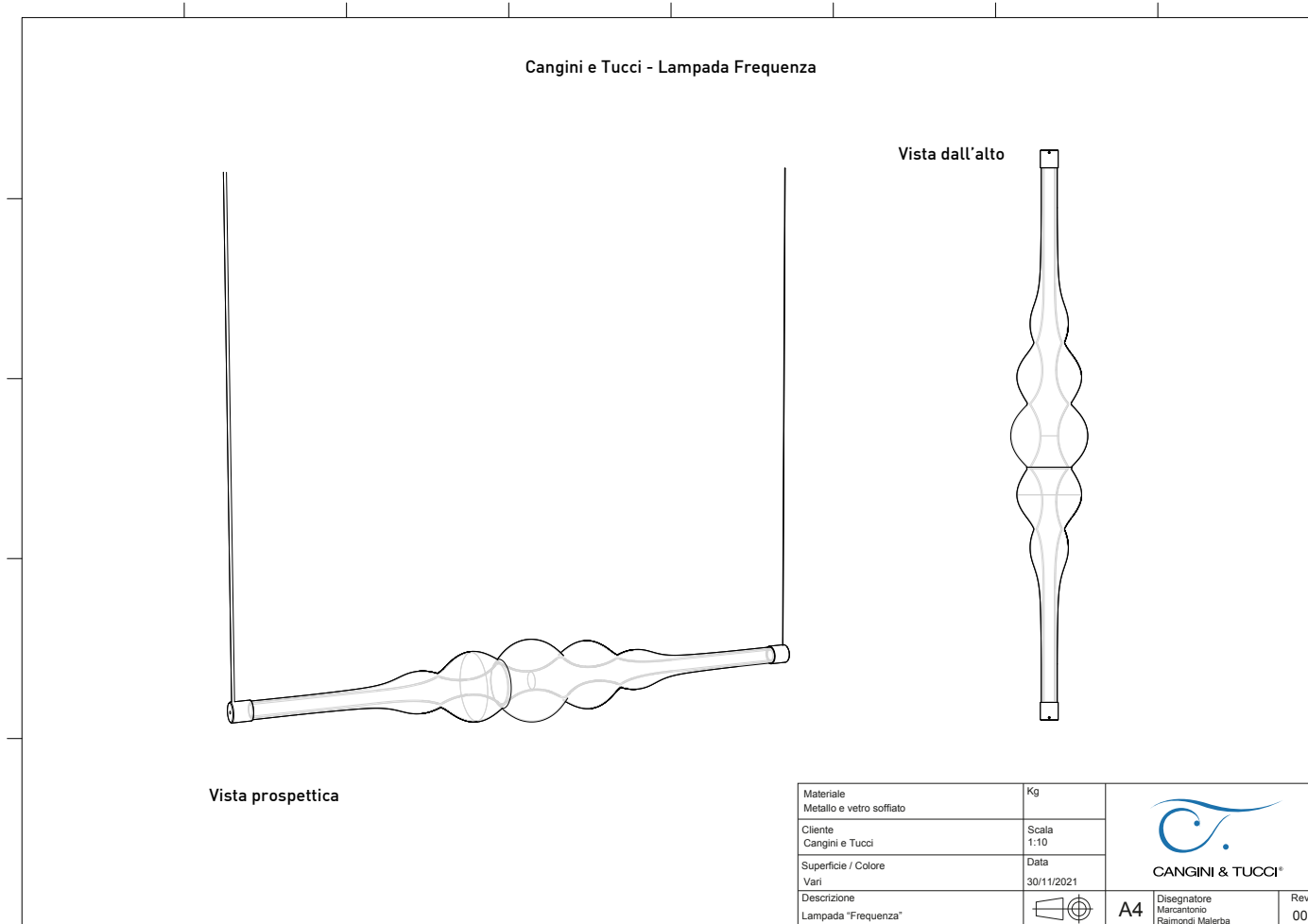
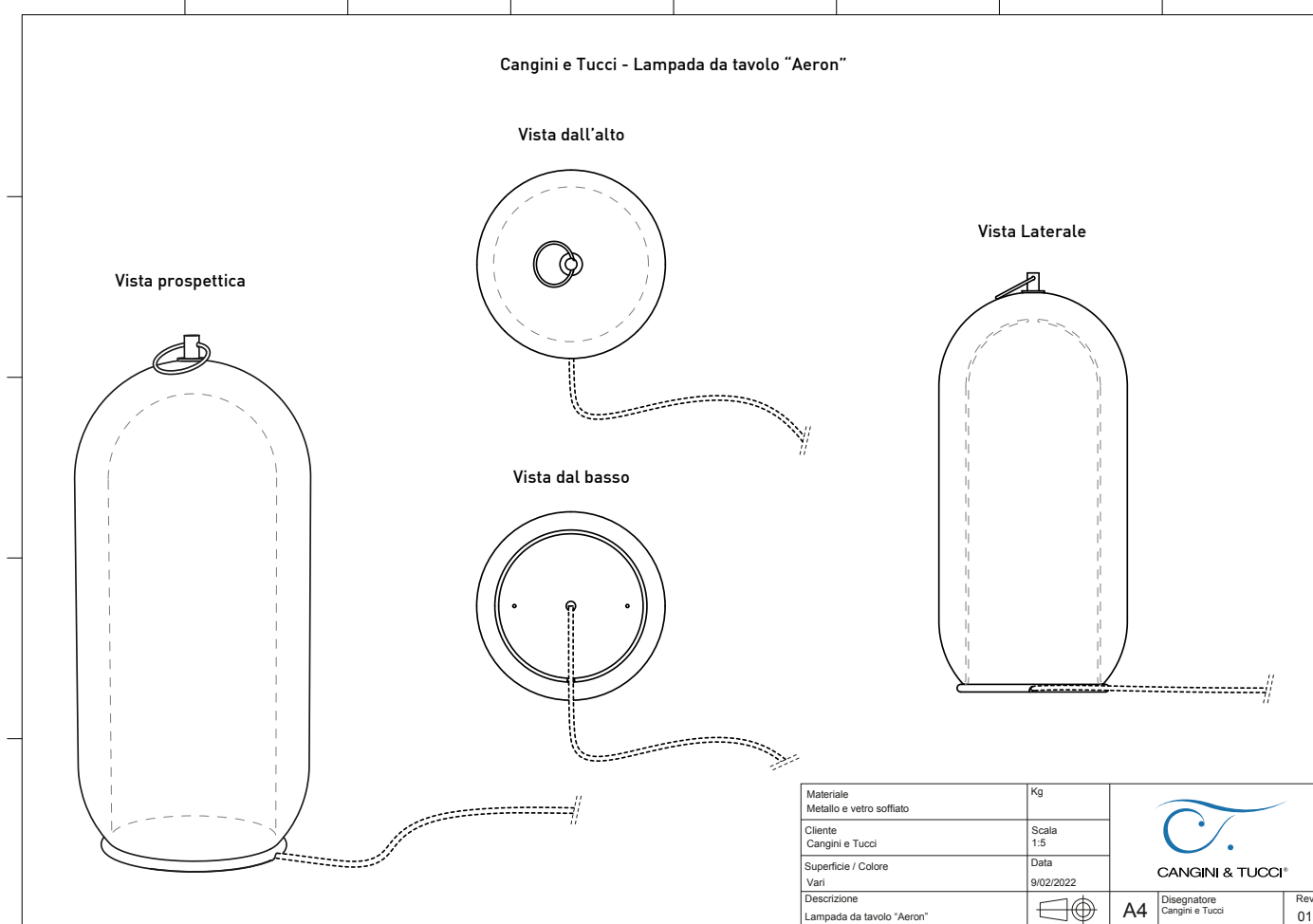

Abbiamo da sempre creduto nell'importanza di differenziarci attraverso il progetto e il design. Abbiamo dato da sempre credito a giovani designer promettenti, cercando di trasmettere loro il linguaggio del vetro e delle tecniche di trasformazione che utilizziamo, cercando di essere allo stesso tempo aperti alle nuove idee che potevano nascere da una mente fresca, e non "contaminata" dal fare quotidiano.

Questo, negli anni, ci ha portato un contenuto sempre crescente di soluzioni innovative a problematiche complesse. Alcune di queste soluzioni sono state depositate e sono diventate brevetti. Ad oggi infatti contiamo ben 12 brevetti depositati. Questo sottolinea la propensione continua all'innovazione della nostra azienda.

*We have always believed in the importance of differentiating ourselves through project and design. We have always given credit to promising young designers, trying to pass on to them the language of glass and the transformation techniques we use, while at the same time trying to be open to new ideas that could arise from a fresh mind, and not "contaminated" by everyday doing. This, over the years, has brought us an ever-increasing content of innovative solutions to complex problems. Some of these solutions have been filed and have become patents. In fact, to date we count as many as 12 patents filed. This underscores our company's continuous drive for innovation.*



# DESIGNERS



## MARCANTONIO

Product designer

Lamps Designed:

- Frequency
- La Stilla
- Vegetal



## ALBERTO MANZONI

Art Director

Lamps Designed:

- AUF
- Scarlett
- Lady Louis
- Inti



## CRISTIAN LIVOI

Product designer

Lamps Designed:

- Fold



## ENRICO DE LOTTO

Product designer

Lamps Designed:

- Fiji

# PREMI DI DESIGN DESIGN AWARDS



**DESIGN PLUS**  
powered by: **light+building**  
**Best of award 2022**

**CANGINI E TUCCI FREQUENCY,  
DESIGNED BY MARCANTONIO,  
WINS THE "BEST OF" AWARD 2022**

A HIGHLY QUALIFIED JURY OF EXPERTS EVALUATES:

- **Design:** design quality, choice of material, operability (universal design)
- **Ecology:** energy efficiency, sustainability (use of resources), durability
- **Technology:** innovation, functionality, technical quality and integrability

Nel 2022 Frequency, la lampada da sospensione disegnata da Marcantonio ha vinto il premio "Best of" indetto dal German Design Council. Durante la fiera di Francoforte "Light+Building" a ottobre 2022, siamo stati premiati per le seguenti categorie:

- Design: qualità del design, scelta dei materiali, usabilità
- Ecosostenibilità: efficienza energetica, sostenibilità, durabilità
- Tecnologia: innovazione, funzionalità, qualità tecnica e adattabilità

Il German Design Council sta prendendo inoltre in esame Frequency e Zoe Max per il German Design Award 2023.

*In 2022 Frequency, the pendant lamp designed by Marcantonio won the "Best of" award given by the German Design Council. During the Frankfurt "Light+Building" fair in October 2022, we were awarded for the following categories:*

- *Design: design quality, choice of materials, usability*
- *Eco-sustainability: energy efficiency, sustainability, durability*
- *Technology: innovation, functionality, technical quality and adaptability*

*The German Design Council is also considering Frequency and Zoe Max for the German Design Award 2023.*

# RICONOSCIMENTI AWARDS



lieferant  
des jahres  
**2022**

PREMIO Licht+Concept: MIGLIOR FORNITORE DELL'ANNO

*Licht+Concept AWARD: BEST SUPPLIER OF THE YEAR*



# CANGINI & TUCCI

# TUTTO SU MISURA CUSTOMIZATION

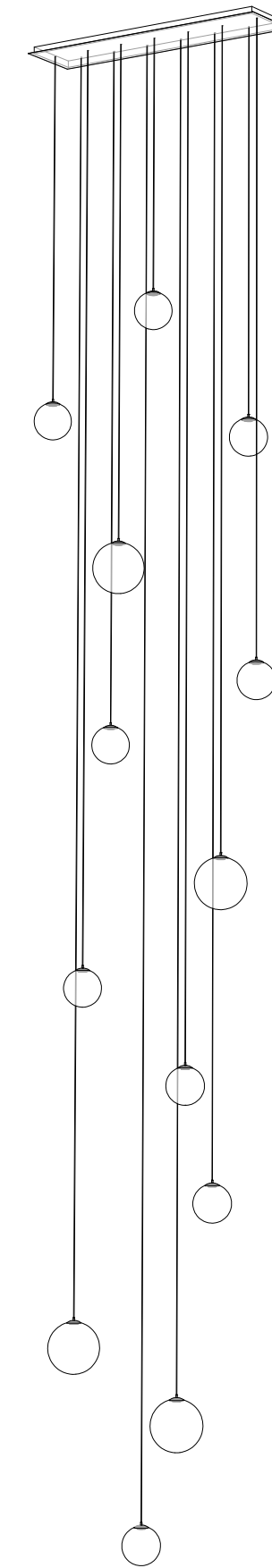
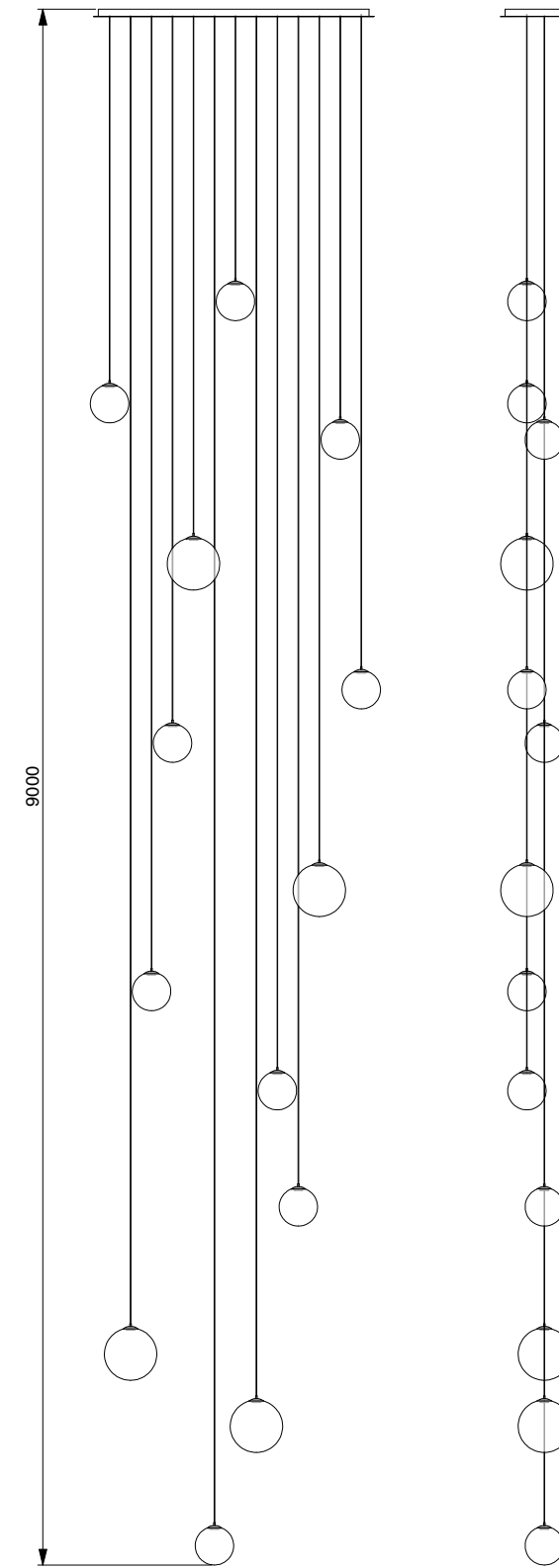
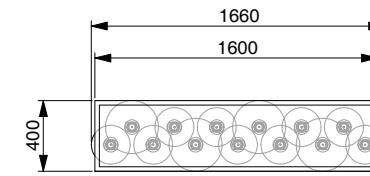
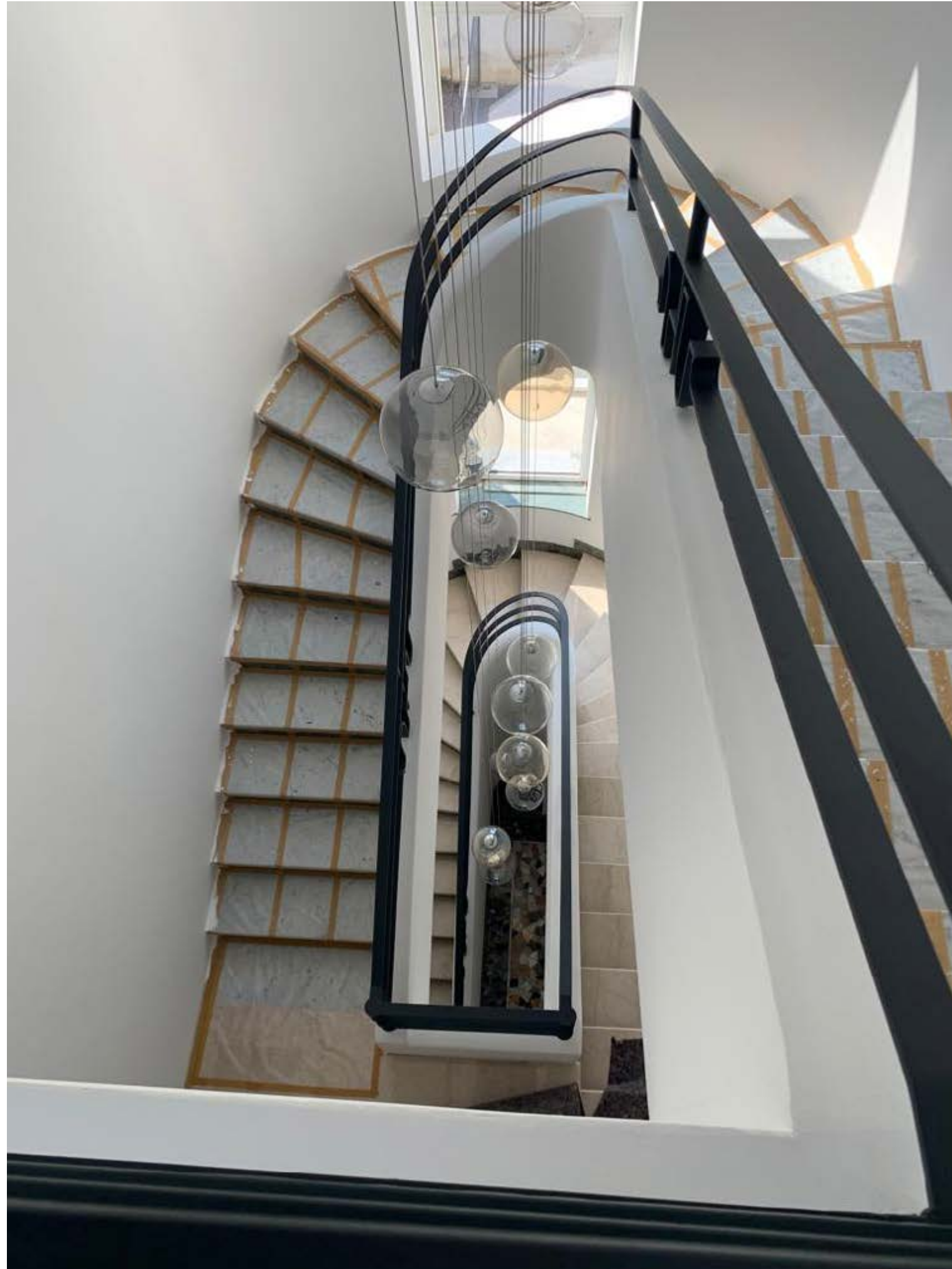

Sentiamo la necessità di elaborare e dare vita alla vostra immaginazione. Un valore che ci contraddistingue è la realizzazione e personalizzazione degli ambienti in base alle vostre esigenze.

Le nostre “case history” unite alla nostra natura artigiana ci permettono di supportare la vostra idea attraverso la nostra visione.

Se voi riuscite ad immaginarlo noi possiamo produrlo.

*We feel the need to elaborate and bring your imagination to life. A value that sets us apart is the realization and customization of environments according to your needs.*

*Our “case histories” combined with our artisan nature allow us to support your idea through our vision.*

*If you can imagine it we can produce it.*

## UNA NUOVA GENERAZIONE DI ARTIGIANI

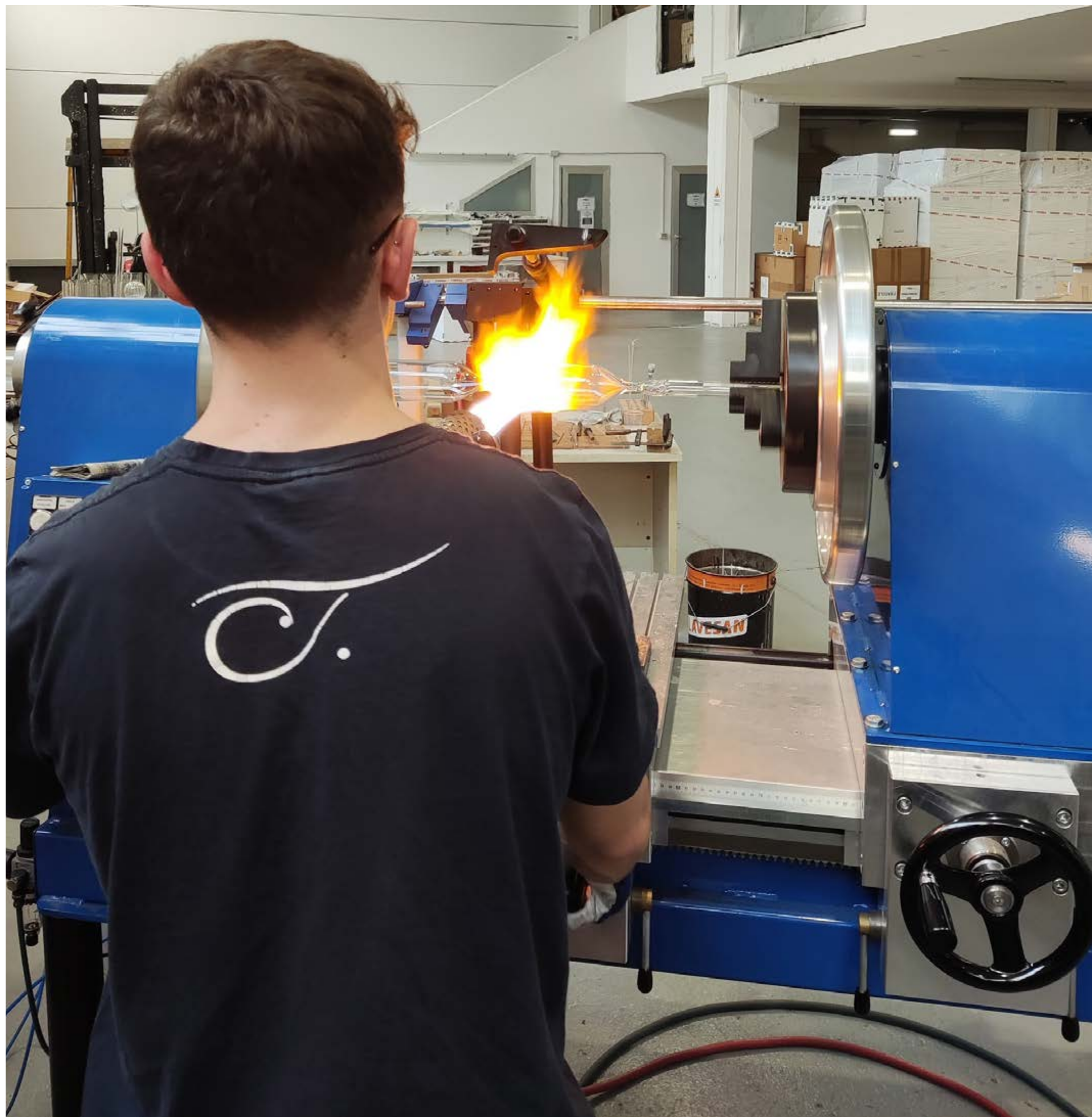

L'età media degli artigiani che quotidianamente lavorano alle fiamme per modellare i vetri che compongono le nostre lampade è 27 anni. Questo per noi è grande motivo di vanto perchè significa che stiamo portando avanti una tradizione, stiamo insegnando a una nuova generazione un mestiere meraviglioso che altrimenti andrebbe perso.

*The average age of the artisans who daily work at the flames to shape the glass that makes up our lamps is 27 years old. This is a great source of pride for us because it means we are carrying on a tradition, we are teaching a new generation a wonderful craft that would otherwise be lost.*

# VAN GOGH MUSEUM AMSTERDAM



## ZOE Van Gogh

La serie di lampade Zoe Van Gogh è il risultato della collaborazione tra Cangini e Tucci e il Van Gogh Museum di Amsterdam.

L'arte del più grande pittore impressionista di tutti i tempi incontra la qualità dell'artigianato e del Made in Italy. Tutte le lampade sono infatti progettate e realizzate in Italia da mani artigiane esperte e da maestri soffiatori.

Le piccole imperfezioni che si riscontrano sulle superfici delle decorazioni sono peculiarità che attestano l'unicità del prodotto e la diversità di ogni prodotto rispetto all'altro e sono quindi da considerarsi motivo di valore aggiunto, proprio come la firma di un grande artista.

## ZOE Van Gogh

*The Zoe Van Gogh series of lamps is the result of the collaboration between Cangini e Tucci x Van Gogh Museum in Amsterdam.*

*The art of the greatest impressionist painter of all time meets the quality of craftsmanship and Made in Italy.*

*All the lamps are designed and made in Italy by expert artisan hands and master glass blowers.*

*The small imperfections that can be found on the surfaces of the decorations are peculiarities that attest the uniqueness of the product and the diversity of each product from the other and are therefore to be considered a reason of value, like the signature of a great artist.*

Home Tickets & Visit Art & Stories About Webstore NL | EN

## Collaboration Cangini & Tucci

Cangini & Tucci collaborated with the Van Gogh Museum to create a special series of mouth-blown lamps inspired by Vincent van Gogh's iconic work *Almond Blossom*.



VAN GOGH MUSEUM AMSTERDAM

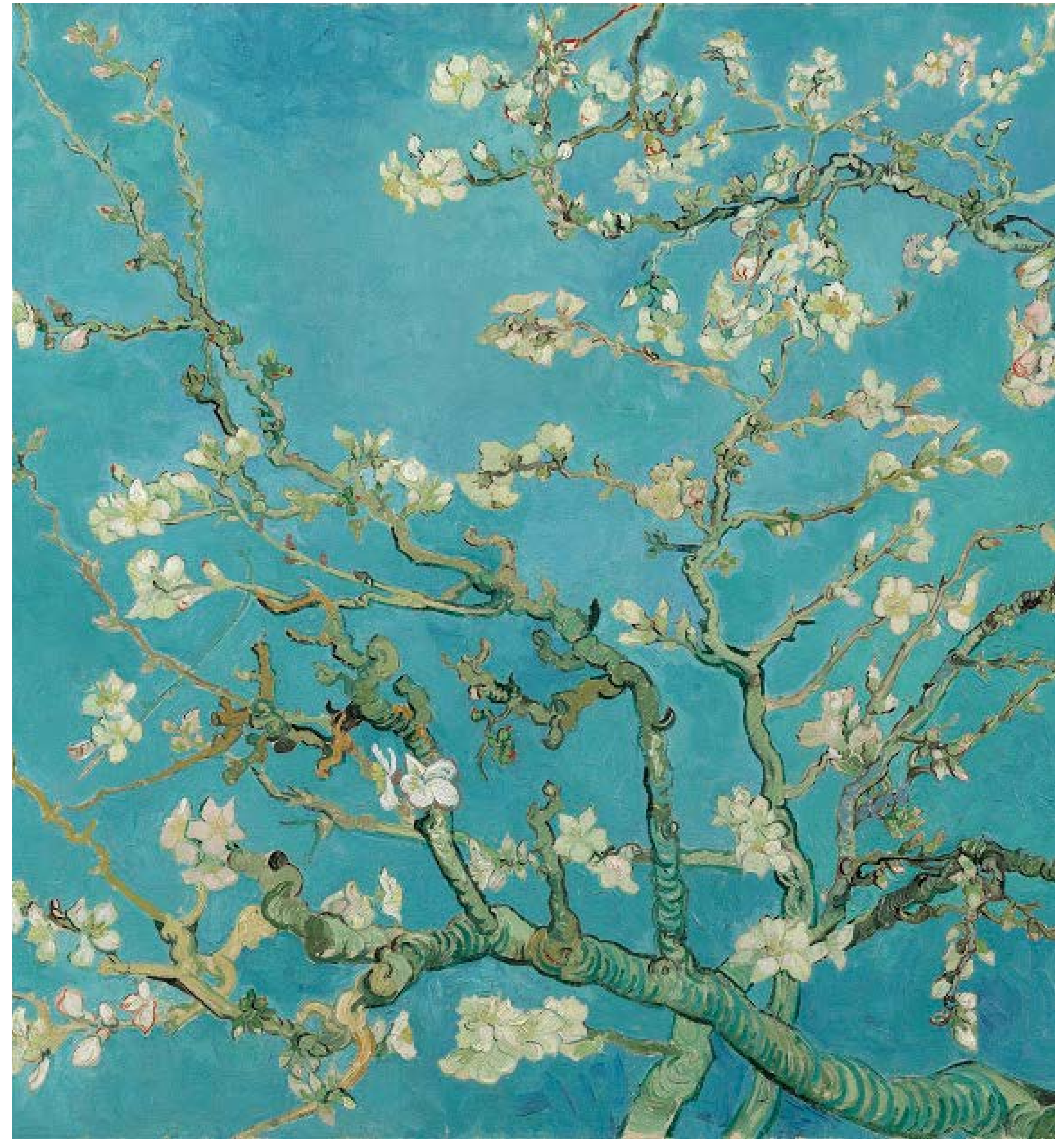

## FIERE ED EVENTI FAIRS AND EVENTS



Partecipiamo alle più importanti fiere di settore: Salone del mobile EuroLuce, Salone del mobile Eurocucina (in collaborazione con Pacini Cappellini), Fuorisalone (presso lo showroom di Pacini & Cappellini), Light+Building a Francoforte. Per noi è un momento fondamentale per avere il polso del mercato internazionale e confrontarci con le altre aziende nell'ambito del design.

*We participate in the most important trade fairs in the industry: EuroLuce Furniture Show, Eurocucina Furniture Show (in collaboration with Pacini Cappellini), Fuorisalone (at the Pacini & Cappellini showroom), Light+Building in Frankfurt. It is a key moment for us to have the pulse of the international market and compare ourselves with other companies in the design field.*

 Salone  
del Mobile  
Milano

 **FUORISALONE.IT**

**light+building**

 CANGINI & TUCCI®





**CANGINI&TUCCI S.r.l**

Via Archimede, 36

47521 Cesena (FC)

Tel. +39 0547 303035

Fax +39 0547 645146

[info@canginietucci.com](mailto:info@canginietucci.com)

[www.canginietucci.com](http://www.canginietucci.com)