

The Standard for Modern Cabinet Makers

AURIGA



PRODUCTIVITY AND PRECISION



Top features for maximum productivity

The AURIGA series offers high tech in minimum space and concentrates on the significant aspects for high quality edgebanding. The series is designed for workpiece thicknesses of up to 60 mm and edging thicknesses of up to 8 mm. High performance jointing and copying units increase the processing range for the AURIGA series. The above-average productivity and top features make this series the best in its class.

- Stable, welded base frame with noise abatement hood in equipment area.
- Ergonomically mounted 18.5" Touch Screen Control right next to entry area.
- The machines have a jointing cutter unit equipped with two milling motors, as well as a patented air stream jointing cutter.
- Double machining operations are eliminated, resulting in significantly longer service life and extremely low noise level.





- Highly flexible glue application with Glu Jet Hybrid Technology as standard feature on all models.
- Motor-driven nozzle adjustment is a standard feature.
- Diamond tipped cutters with integrated chip removal as well as precise concentricity and long tool life as standard features.
- High performance equipment for perfect edging finish.

Illustrations may contain optional features.



Superior competency for edgebanding

The edgebander series AURIGA unifies compact design and a high degree of automation – thus making HOLZ-HER the standard for modern cabinet makers.





AURIGA 1308

Complete processing at the professional level – with two finishing units. Fully automatic operation of machining units at the touch of a button via NC servo-axes, directly on rotating and pivoting 18.5" Touch Screen Control panel. The patented Glu Jet application system included as a standard feature on the AURIGA ensures perfect edge appearance.



AURIGA 1308 XL

Highest degree of automation in its class – with three finishing units completely eliminates any need for manual post processing. State-of-the-art servo-axes allow all setup operations to be completed without opening the machine hood. The patented Glu Jet application system included as a standard feature on the AURIGA ensures perfect edge appearance. The optional spraying unit also ensures a perfect edge finish.

Edge Control Touch

The HOLZ-HER Edge Control Touch provides extremely high performance and is exemplary for its simple operation. Ergonomic, simple and uniform tablet design.

Display

- 18.5" touchscreen with 16:9 format.
- Brilliant graphic display of machining process.
- Simple operation – rotating and swiveling control panel at eye height.

Operation

- Electronically controlled set-up processes with 100% repetition accuracy.
- Clear and complete acquisition of all operating data: Total running meters, total parts, total hours with reset.
- Custom user management with password protection and single authorization.

Equipment/Service

- Network connectivity.
- Online maintenance, high speed data interchange with HOLZ-HER service department.
- Barcode interface for automatic program call-up.
- External USB port for data backup and system updates.
- Connection to HOLZ-HER process data acquisition system for direct read-out of operating data (optional).

Edge Control Touch –
high standards guarantee your
investment for the future.



Adaptive package

The optimized, automatic control for the extensive pressure adjustments with plausibility checks allows HOLZ-HER to realize automatic glue quantity control matched to the specific requirements. Moreover, an adaptive trimming blade automatically adapts the pressure of the trimming blade to the edge thickness.

Also included is an adaptive pressure unit for optimum adjustment of the pressure on the first pressure roller to the specific application for perfect results every time. This reduces adjustment errors and reject quotas to a minimum (optional).

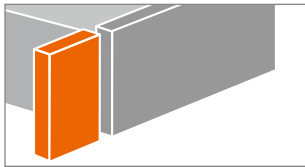

Adaptive trimming blade

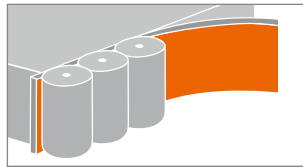

Adaptive pressure unit

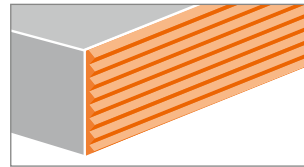

Automatic glue quantity control

Highly efficient production through HOLZ-HER machine network Programming – Sawing – Edgebanding – CNC Machining

CabinetControl (1)

- Design component at the click of the mouse.
- Automatic generation of cutting lists and CNC programmes.

Rational and precision sawing (2)

- Perfect cutting results.
- Mature optimization software.
- Optimum sawing cycle.

Intelligent edgebanding (3)

- Program selection at the touch of a button.
- Alternative: fully automatic with barcode.

Perfect data flow (4)

- Program information also via data matrix barcode.

Effective CNC performance (5)

- Automatic program call with barcode.
- Variable programming with CAMPUS Software.
- Perfect cutting results.



Glu Jet – Zero joint with thin film technology

The clear advantages of our hybrid technology in combination with the new HOLZ-HER thin film technique make this gluing system the all-rounder for craftsmen and industrial users. Visual zero joints with PUR glue – allowing use in wet areas – are natural for HOLZ-HER customers.

Ultra-thin glue joints, easily equivalent to industrial laser edges, are easy to achieve with the HOLZ-HER Glu Jet system, which also offers unrivaled flexibility.

From state-of-the-art, high gloss edging right up to thick edging cross sections in the solid wood range, HOLZ-HER remains unequaled in terms of appearance, regardless of the material. HOLZ-HER sets tomorrow's trends today.

Glue change and cleaning require only 3 minutes each



Heat-up time
3 minutes



Glue change*
3 minutes

* to PUR glue, to EVA glue
and color change



Cleaning
3 minutes



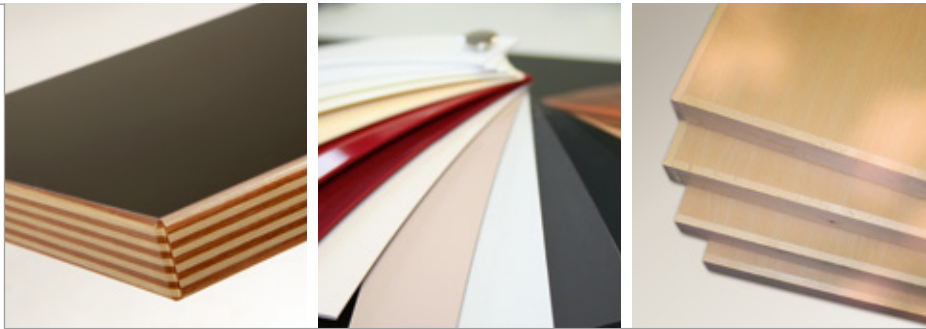

PUR glue is the standard for professional cabinet makers

Industrial technology for every shop – with the Glu Jet System you can process PUR glue on a standard basis; just as simply as EVA glue. Strong arguments for you and your customers:

- No additional glue basin.
- No expensive nitrogen tanks.
- High strength joint for extremely long service life.
- Resistant to heat and water, providing quality advantages in all areas of cabinetmaking.

**Waterproof PUR glue – ideal for
kitchen and bath furniture**



Perfect edgebanding

AURIGA units offer a convincing range of performance. From premilling unit, edge feeder, unequaled HOLZ-HER glue application system, and end trimming and cutting units all the way to the custom equipment in the finishing area, ten high performance modules are available for perfect edgebanding.

Corner rounding

Corner rounding unit for processing corners with edging thicknesses up to 3 mm. Tools for radiuses up to 3 mm and chamfers up to 45 degrees – postformed profiles possible.

- Diamond tipped tools for long tool life.
- Integrated chip removal in tool.





Premilling

Cut edges often have small tears in the top layer. The premilling unit ensures perfect panel surfaces and prepares the panels for the gluing process. Equipped with patented air-stream jointing tools.

Including height adjustment for optimum utilization of cutters.

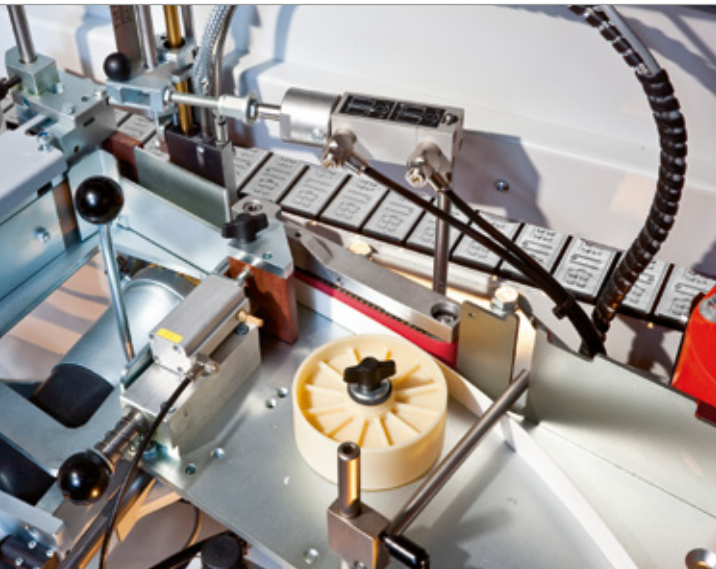
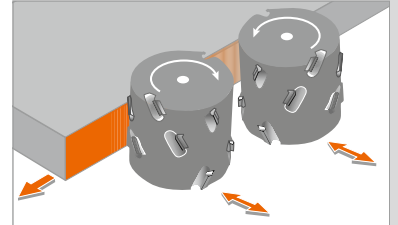

Edge feeder

Fully automatic, user-friendly feed of strips and coiled edging; conversion without tools.

Gentle material handling with transport belt for edging transport and light barrier for edging recognition.

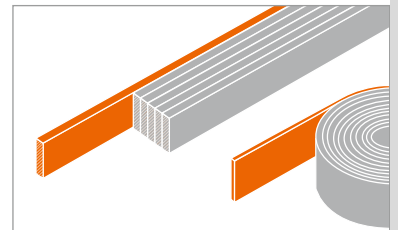

Pressure unit

High quality 3-roller pressure unit for pressing edging against panel cleanly and forcefully. First roller with motor drive. Two conical subsequent pressure rollers.

Pneumatic, application-controlled pressure unit.

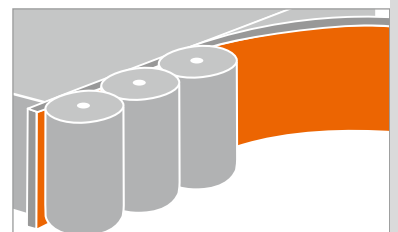

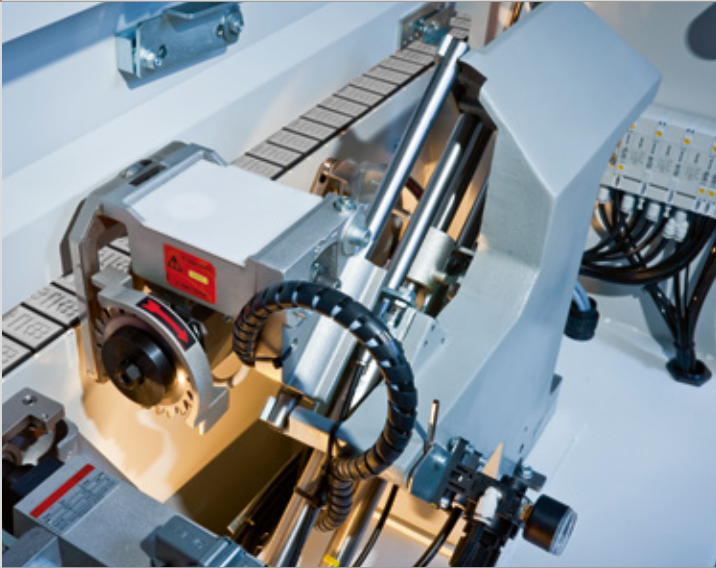

Pneumatic end trimming unit

For straight or chamfered end trimming on thin edging; a standard feature allows this unit to be pivoted to 10 degrees pneumatically. High quality version with stable cast iron pillars.

Each saw motor mounted on two guides for precisely trimming off protruding edging.

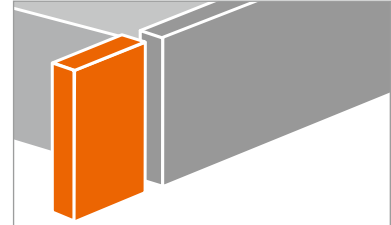

Pneumatic cutter unit

Multifunction cutter unit for flush cut on edging with thickness up to 8 mm, radiuses up to 3 mm, pivots 0 – 15 degrees. Including diamond tools.

Further equipment:

- Integrated chip removal in tool.
- ProLock system.
- Also available with four NC servo-axes (optional).

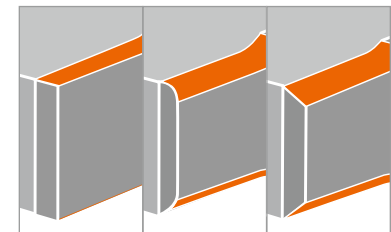

Corner rounding unit

Unit for copying vertical end edges, various edge profiles possible – including postformed profiles. Integrated chip removal. With diamond tipped tools for long tool life.

60 mm operating height.

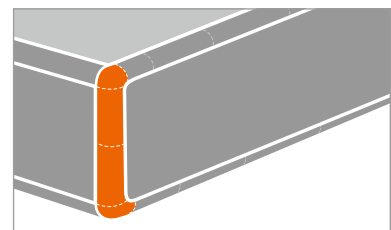

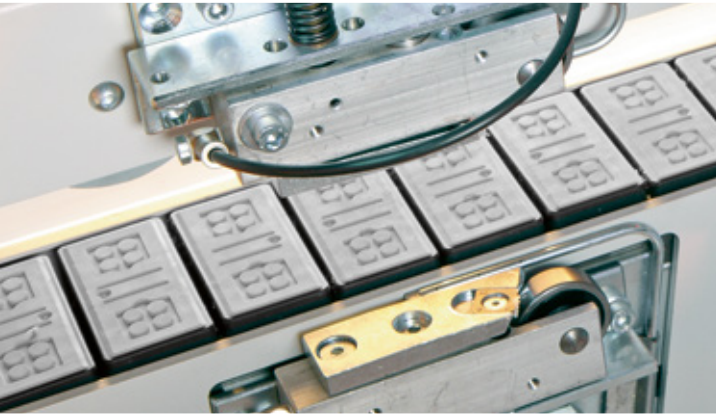
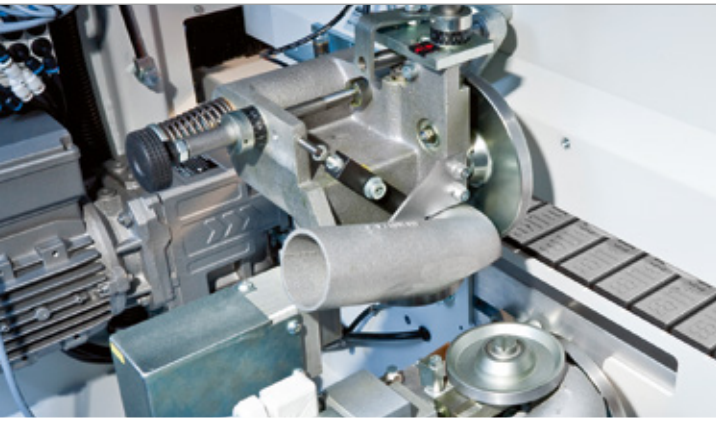

Finishing

Perfect finishing – generous post-machining area for up to three finishing units (depending on model).

■ Scraper unit

For perfect smoothing of radiuses and chamfers on plastic edging.

Also available with NC servo-axes (optional) (Fig. 1).

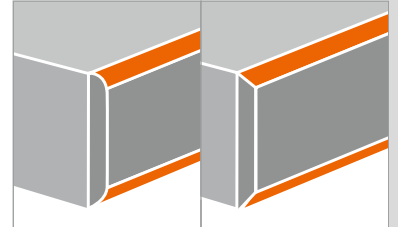

■ Flat scrapers

The application-controlled glue scraper removes all glue residues, which are then blown off the panel by the integrated blow nozzles (Fig. 2). Also with pre- and post sensing (optional).

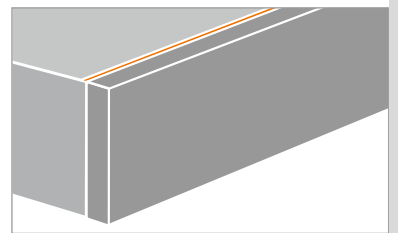

■ Buffing unit

Polishing for maximum gloss; for complete finishing (Fig. 3).

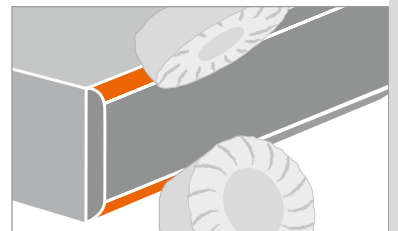

Spraying units

A release agent is sprayed on to a precisely defined area by special spray nozzles in the entry area. This prevents any glue or contamination residues from adhering. These glue and contamination residues are removed reliably by the spraying unit (for cleaning agent) in the discharge area in combination with the buffing unit (optional).

Now with new horizontal spraying unit for high gloss edging.

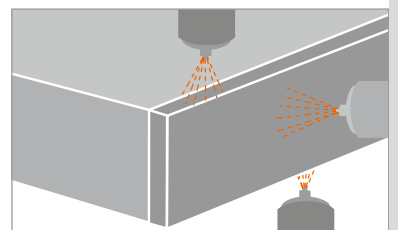

Overview of AURIGA series

Machine	AURIGA 1308	AURIGA 1308 XL
Control	PPC 315 with Touchscreen	PPC 315 with Touchscreen
Bridge	Manual	Manual
	Motor-driven	Motor-driven
Edge feeder	Autom. for strips and coiled edging	Autom. for strips and coiled edging
Premilling	45 mm	45 mm
	60 mm	60 mm
Glue application	Glu Jet (thin film technology)	Glu Jet (thin film technology)
	Granule and /or cartridge hopper	Granule and /or cartridge hopper
Pressure unit	3 pneum. rollers incl. conical subsequent pressure rollers	3 pneum. rollers incl. conical subsequent pressure rollers
End trimming	Two-motor 60 mm pneumatic pivoting feature	Two-motor 60 mm pneumatic pivoting feature
Cutting	Multi-function 8 mm pivotable 0° – 15°	Multi-function 8 mm pivotable 0° – 15°
	MOT 4 pneumatic pivotable	MOT 4 pneumatic pivotable
Corner rounding	60 mm	60 mm
Scraper	Pneumatic incl. chip collection box	Pneumatic incl. chip collection box
	+ MOT versions	+ MOT versions
Glue scraper	Application controlled incl. blow nozzles	Application controlled incl. blow nozzles
	With pre- and post-sensing	With pre- and post-sensing
Buffing	x	Buffing unit
Spraying device	x	Parting and cleaning agent

Standard

Optional

x

Not possible



	AURIGA 1308	AURIGA 1308 XL
Machine dimensions		
Overall length (A)	4630 mm	4930 mm
Weight	1250 kg	1420 kg
Feed speed		
Feed speed	10 m/min	10 m/min
Working dimensions		
Minimum workpiece length	160 mm	160 mm
Workpiece thickness	8 – 60 mm	8 – 60 mm
Edge thickness	0,4 – 8 mm	0,4 – 8 mm

TECHNICAL DATA

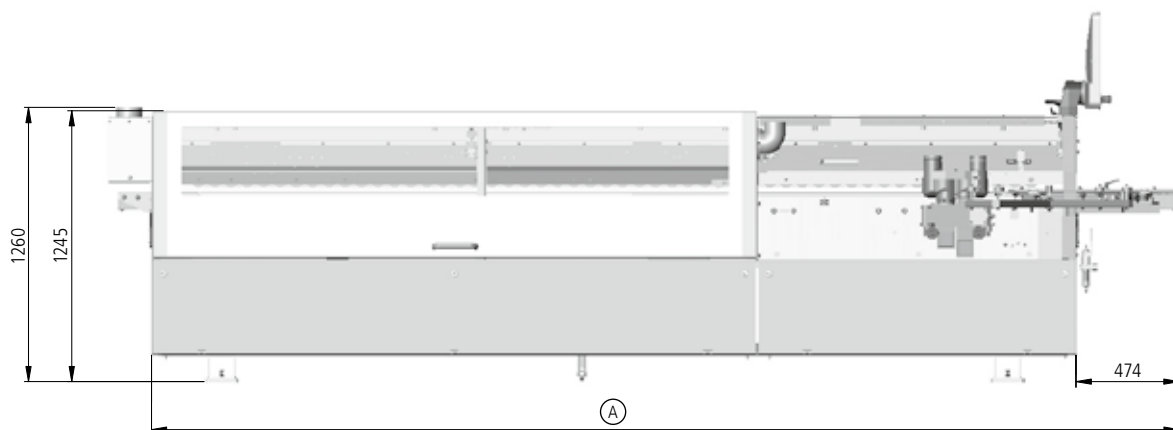
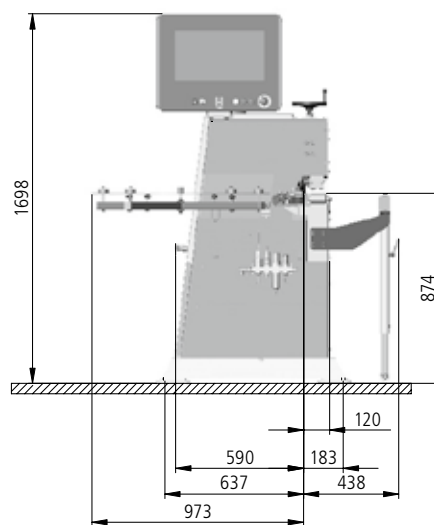
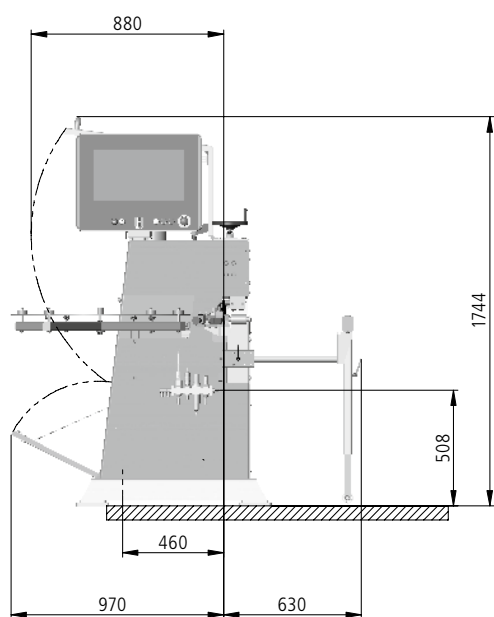

Product brochures and many
videos are available at
www.holzher.com



The technical data specified is intended for reference only. HOLZ-HER woodworking machines are subject to constant development and are therefore subject to modification without prior notice. The illustrations are therefore not binding. Some of the machines shown also contain special equipment not included as a standard feature. For clarity, some of the machines are shown without protective hood.

Picture credits:

»Schreiner« © liseagence – istock.com
»moderne Küche« © ARochau – Fotolia.com

UK – HOLZ-HER 3594 45 – Printed in Germany/Imprimé en Allemagne
Printed on: 17.05.2017 – First edition: 12.03.2012

Your authorized HOLZ-HER dealer

**HOLZ-HER GmbH**
Plochinger Straße 65
72622 Nürtingen
Deutschland
T +49 (0) 70 22 702-0
kontakt@holzher.com
www.holzher.com

HOLZHER

Ein Unternehmen der WEINIG Gruppe