

PANHANG
by
HOKUBEMA



since 1918

334|20

335|20

336|20

436|10

546|10

PLANING MACHINES

It's time to get a Panhang



PLANING MACHINES

334|20

335|20

336|20

436|10

546|10



„Where there is work, there is potential“

„Planing machines of the latest generation are not comparable to the devices from the past at all. They work with greater precision and make wood processing much easier.

Surface and thickness planing machines of the PANHANS brand set a good example here. The technology is perfect and operation leaves nothing to be desired.

Control of the current models is particularly impressive. The simple setting of work processes on displays that can be read easily makes it easy to achieve precise results. Processes can also be filed in the program storage to be reused at any time.

Doubtlessly, the HOKUBEMA designers not only know what they are doing, but also know what is important for users and what we expect of the machines.

In addition to the high quality, I am also impressed by the comprehensive service range. Competent contacts are ready before and after the purchase to advise and support me actively.

What about the wood chips? There's no way around them. They're finer than ever, but they have stopped ending up on the floor. They are now extracted right where they appear.“

It's time to get a Panhans





SURFACE PLANING MACHINE

334|20

335|20

336|20

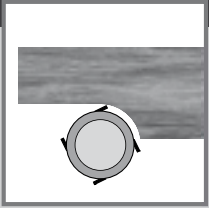

- 3 different planing widths
Model 334|20 = 410 mm
Model 335|20 = 510 mm
Model 336|20 = 630 mm
- Table length 2850 mm
- Infeed table electrically adjustable
- Hollow and pointed joint setting
- Drive power 5.5 kW

THICKNESS PLANING MACHINE

436|10

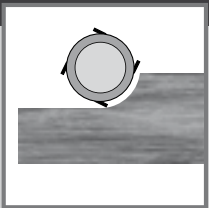

- Planing width 630 mm
- Planing height 3 - 300 mm
- Electrical jointer table adjustment with position control easy drive
- Jointer table supported protected against tipping
- Drive power 7.5 kW

PLANING MACHINE DUO

334|20 335|20 336|20 + 436|10



Surface and thickness planing machines of the PANHANS brand can be placed space-savingsly side by side due to their special form.

This ensures an optimal work process.

The properties of the two machines can be used without restriction.

COMBINED PLANING MACHINE

546|10

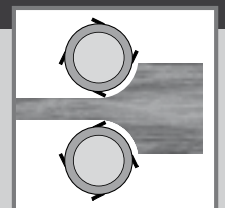

- Planing width 630 mm
- Comfortable dressing and thickness planing without machine conversion
- Stably formed and precise jointer tables
- No folding up of the work tables
- Both work steps are possible in dual mode with a dressing stop position of 315 mm

SURFACE PLANING MACHINE

334₂₀

335₂₀

336₂₀

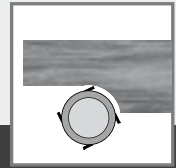

1

Operation and safety

Centralized and placed at eye level - the well-structured operating panel permits all settings.

2

Toothed table lips

The machine is serially equipped with toothed table lips to reduce noise

3

Single-lever dressing stop

The dressing stop can be set to the desired depth with a single hand. The angle is adjusted just as easily between 45 and 90°.

4

Planing protection

Safety is of high importance. Areas of the knife shaft that are not in use are covered by easily adjustable protective devices.

5

Ergonomic machine front

The shape of the machine front permits the operator to stand very close to the blade shaft and dressing stop. Together with the cut-out at the machine bottom, this ensures back-protecting work.

6

Fine-planed work table

The work table is made of high-quality materials, very finely planed and with a wave-like surface. An air cushion effect occurs between the work piece and the table surface, making it much easier to slide on the tables.

7

Console for additional devices

An infeed device can be installed on the serial console.

Planing Widths

334 ₂₀	410 mm
335 ₂₀	510 mm
336 ₂₀	630 mm



convincing in detail



- Finely planed asymmetrical tables
1620 mm long infeed table (better planing area),
1170 mm long outfeed table,
total table length 2850 mm.
- Toothed table lips for noise reduction.
- Operating panel well-structured at eye level with
digital display of the chip removal and current
condition of the outfeed table (hollow-pointed joint
or straight).
With template holder and easily reachable tool
deposit.
Push button switch for start/stop and automatic
motor brake.
- Infeed table with electrical adjustment up to 8 mm
via pushbutton, accuracy 1/10 mm. Hollow and
pointed joint setting via central adjustment spindle
and display via scale and digital display in the
operating panel.
- Swivelling dressing stop, depth and swivel adjust-
ment via single-lever quick adjustment (therefore no
reaching across the blade shaft).
Stop guide 4-fold via hardened round rod guide with
extremely easy adjustment.
- Stable anodised aluminium hollow-chamber profile
with integrated swivelling auxiliary stop for secure
hand rest on narrow workpieces.
- Blade shaft drive with 5.5 kW at 5000 rpm.
- Machine run in at the factory.
- Space-saving setup in combination with thickness
plane 436110.

• Motor	5.5 kW / 7.5 HP
• Planing widths	410 / 510 / 630 mm
• Total table width	2850 mm
• Takeoff	up to 8 mm
• Depth of cut	with motoric adjustment

Image shows options.

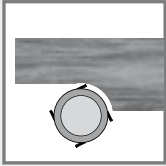

SURFACE PLANING MACHINE

STANDARD

LED-display for takeoff

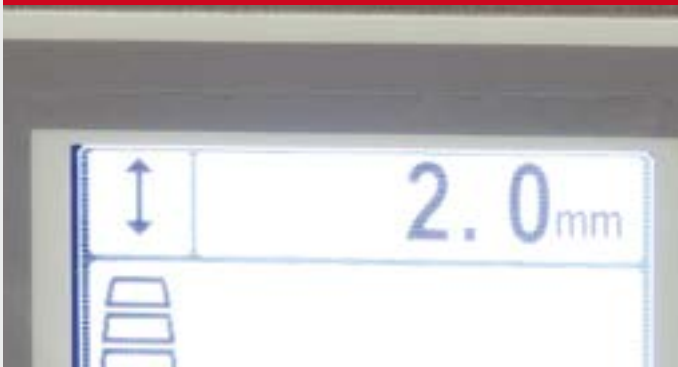

The takeoff set here can be read digitally at the display.

Hollow and pointed joint setting



The setting is made manually at the outfeed table. The control and scale show the current condition.

Toothed table lips



Integrated in the work table, this construction ensures a low-noise operation of the planing shaft.

Planing fence



Depth and swivelling range of 90 - 45° of the planing fence can be adjusted by the centrally positioned operating lever.

Planing protecting device TXF 1570



With two-piece cover, continuous adjustment of height and depth.

PANHANS wedge-bar blade shaft



With 4 planer knives,, 2 screw-on type brass devices make adjustment easier.

OPTIONS

Suvamatic protectin device



Two-piece cover with spring-mounted surface pressure, which can be folded down.

Model	Item No.
334 20	3281
335 20	3281
336 20	3285

TX-matic planing protection device



Two-piece, cover can be folded down, with spring-mounted pressure.

Model	Item No.
334 20	3283
335 20	3283
336 20	3284

Tersa blade shaft

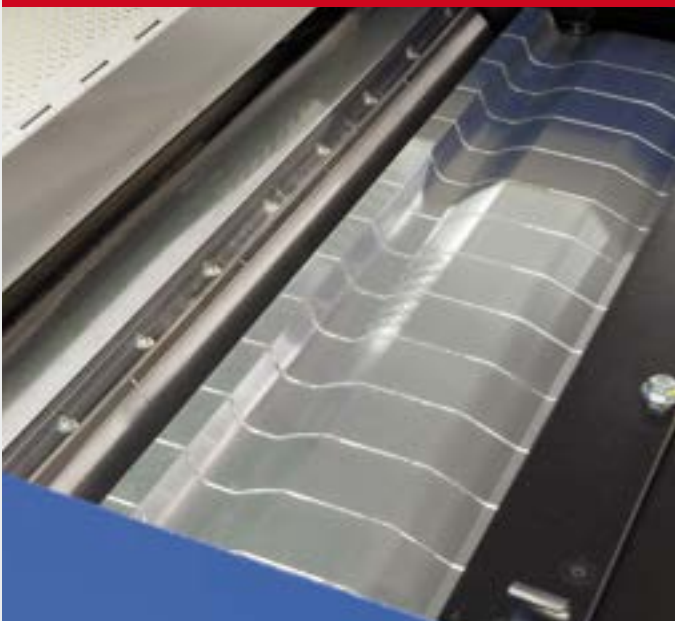

With 4 reversible knives for low-noise operation and quick tool change, precise knife setting.

Model	Item No.
334 20	4082
335 20	4470
336 20	4471

Spiral cutter head

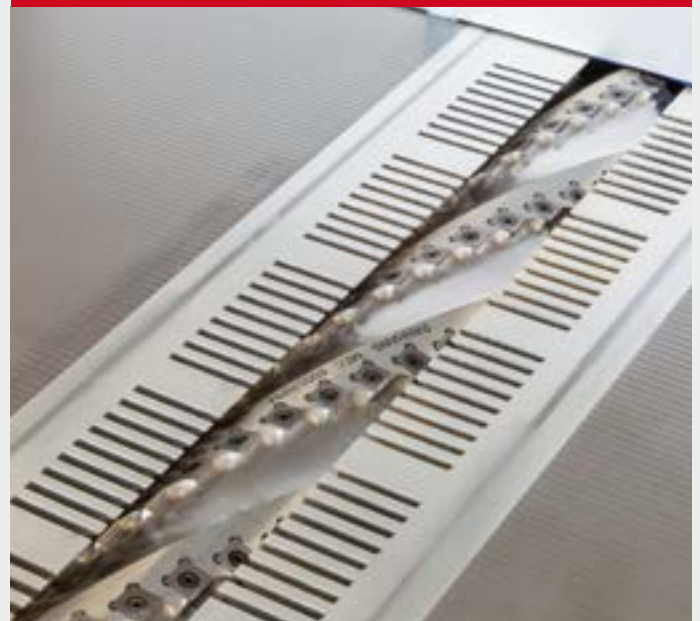

With 6 spiral-shaped rows of blade and HM reversible blades for pulling cut and enormous noise reduction, long life, short chips.

Model	Item No.
334 20	4639
335 20	4640
336 20	4472

THICKNESS PLANING MACHINE 436|10

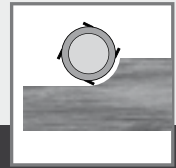

Planing width

436|10 630 mm

1

Intuitive settings

All relevant values are set at the machine front, well-structured and easily accessible.

Planing height, chip removal and infeed speed can be chosen easily. A program memory keeps the desired values for subsequent work ready (option).

2

Cover hood with safety switch

The hood provides access to the tool deposit compartment. This makes the blade change simple and quick.

3

Parallel and precise

Designed for high loads and precisely guided - the jointer table is resting on 4 solid trapezoid spindles.

4

Fine-planed jointer table

The work table is very finely planed. An air cushion effect occurs between the work piece and the table surface, making it much easier to transport the wood through.

5

Large deposit

The sound-insulated machine hood serves as a practical deposit area.

Workpieces can be put down on it between the processing steps.



convincing in detail



- Compact machine dimensions
L 1191 mm W 1091 mm H 1110 mm at the full plane width of 630 mm.
- Machine hood generously covered in carpet to put down and return already-planed workpieces; single-part hood opens upwards.
- Low-noise design due to special sound-absorbing materials.
- Fine-planed machine tables
Length 1100 mm, table height adjustment with 4 trapezoidal thread spindles, 2 additional lateral guides as tipping protection.
- Electro motor-powered height adjustment with easy drive control, display via large LED display with switching size for absolute planing height and chip removal.
- Blade shaft drive with 7.5 kW at 5000 rpm.
- Jerk-free transport of the wood, infeed and extraction roller, as well as the link pressure bars, have pendulum supports for soft transfers when planing and no impact effect on the workpiece and the machine mechanics.
- Rubberised infeed and extraction roller with a diameter of 90 mm, 5-fold segmented for simple exchange among each other on each roll for longer service lives, thickness compensation on concurrent planing of several bars next to each other up to 3 mm.
- Minimal chip removal 0.1 mm for rubber rolls without pressure points in the wood.
- Push button switch for start/stop and automatic motor brake.
- Machine run in at the factory.
- Space-saving setup in combination with PANHANS surface planing machine.

• Motor power	7.5 kW / 10 HP
• Planing width	630 mm
• Planing height	3 up to 300 mm
• Total table length	1100 mm
• Takeoff	0.1 up to 8 mm

Image shows options.

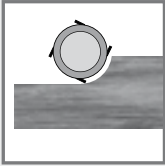

THICKNESS PLANING MACHINE

STANDARD

Position control easy drive



Easy and precise setting of the planing height from 3 to 300 mm.
2 feed speeds can be activated (7 + 14 m/min).

Thickness table



With 4 trapezoid spindles, secure against tilting for optimal planing results.

Roller mill



Precise setting, infeed and outfeed rollers 90 mm Ø, segmented rubber rollers, pendulum-mounted and standard link pressure bars for perfect planing.

PANHANS wedge-bar blade shaft



With 4 planer knives,, 2 screw-on type brass setting devices make precise adjustment easier.

OPTIONS

Positioning control for 99 programs



Displays target/actual value, smooth infeed speed.

Item No. 4336

Manual movement via arrows.
Direct dimensional movement for planing size or chip removal.

Program-controlled with infeed for raw size, finished size, chip removal and smoothing sizes.

Adjustable guide rollers



2 rollers, lift- and retractable for better transport of moist wood, with ribbed steel infeed and rubber outfeed roller

Item No. 4480

Thickness table extension



With automatic height adjustment
Dimension 1000 x 630 mm
Dimension 2000 x 630 mm

Item No. 4339
Item No. 4740

Steel infeed roller

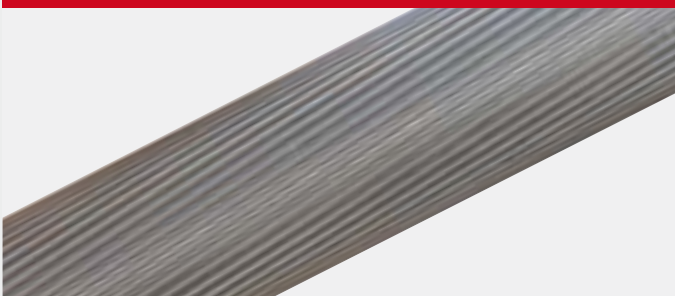

Instead of the standard rubber infeed roller, recommended for planing moist or rough wood

Item No. 4341

Sectioned infeed roller

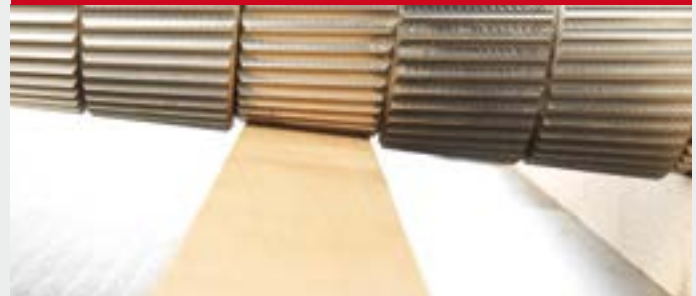

For thickness compensation of approx. 3 mm, for planing several adjoining bars.

Item No. 4461

Tersa-knife shaft

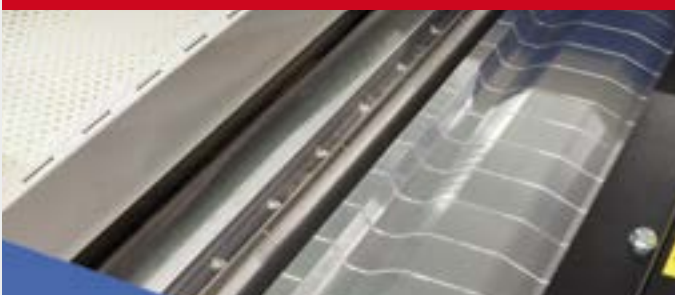

With 4 reversible knives for low-noise operation and quick tool change, precise knife setting.

Item No. 4471

Spiral cutter head



With 6 spiral-shaped rows of blade and HM reversible blades for pulling cut and enormous noise reduction, long life, short chips.

Item No. 4472

COMBINED SURFACE AND THICKNESS PLANING MACHINE 546|10

Planing width

546|10 630 mm

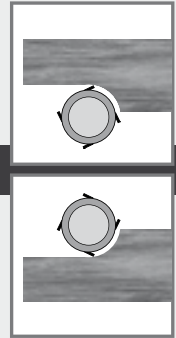

Maximum function - minimal space

The combined plane offers the benefits of both PANHANS models on a small footprint. The optimal machine combination for higher demands.

1

Surface planing machine

The work table provides functions of the tried and tested PANHANS dressing plane.

2

Thickness planing machine

The thickness planing function can be taken into operation without difficult conversion work. Since machine tables do not need to be folded up, the highest ergonomics have been reached as well.

3

Surfacing fence

The swivelling stops can be quickly and easily adjusted to different angles from 90 to 45°. The integrated and also swivelling auxiliary stop serves for safe hand rest on narrow workpieces.

4

Planing protection

Safety is of high importance. Areas of the knife shaft that are not in use are covered by easily adjustable protective devices.



convincing in detail



• Motor power	7.5 kW / 10 HP
• Planing width	630 mm
• Total table length	2555 mm
• Chip removal surface planing	up to 5 mm
• Cut depth adjustment	with motoric adjustment
• Height adjustment thickness planing machine	3 - 250 mm, electrically with position control easy drive

- Dressing and thickness planing in dual position without adjustment measures at a planing width of up to 315 mm, leading to enormous time and equipment cost savings. The dressing tables never need to be swivelled.
- Maximum plane widths up to 630 mm.
- Separate operating elements in the respective work position with electrical table adjustments for the infeed table with digital display of the chip removal and for the jointer table with easy drive control.
- Fine-planed solid surfacing tables, total length 2555 mm with removable table surfaces as an additional insertion table for thickness planing and optimal removal of the planed workpieces in the outlet area of the jointer table.
- Swivelling dressing stop with stable anodised aluminium hollow-chamber profile with integrated swivelling auxiliary stop for secure hand rest on narrow workpieces. Depth adjustment via 2 hardened and polished round guide rods, 4-fold guide, smooth adjustment.
- Integrated extraction hood in the dressing stop for the thickness plane function with grid bolts for dual position.
- Fine-planed jointer table, length 1100 mm with 400 mm extension, table height adjustment via 4 trapezoid thread spindles, 2 additional lateral guides as tipping protection.
- Electro-motor height adjustment with easy drive control, display via LED with switching size for absolute planing height and chip removal.
- Blade shaft drive with 7.5 kW, 5000 rpm.
- Jerk-free transport of the wood, infeed and extraction rollers, as well as the link pressure bars, have pendulum supports for soft transfers when planing, no impact effect on the workpiece.
- Rubberised infeed and 2 extraction rollers, 5-fold segmented for simple exchange among each other on each roll, including thickness compensation on concurrent planing of several bars next to each other up to 3 mm.
- Minimal chip removal 0.1 mm for rubber rolls without pressure points in the wood.
- Push button switch for start/stop and automatic motor brake.

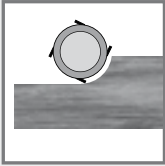

COMBINED PLANING MACHINE

STANDARD

Quick adaption - surface planing-mode



The table element is used in the planing table for a complete support for surface planes bigger than 315 mm up to 630 mm width.

Quick adaption - thickness planing-mode



In thickness planing mode, the table element of the planing table is in the lower position as infeed extension of the thickness table.

Table adjustment surface planing function



Electrical adjustment by push button, with LED-display, exactness 0.1 mm

Table adjustment thickness planing function



Position control easy drive for easy and precise adjustment of planing height from 3 to 250 mm

OPTIONS

Positioning control



Displays target/actual value, smooth infeed speed, direct setting of cutting height or takeoff

Item No. 4644

Adjustable guide rollers



2 rollers, lift- and retractable for better transport of moist wood, with ribbed steel infeed and rubber outfeed roller

Item No. 4482

Steel infeed roller

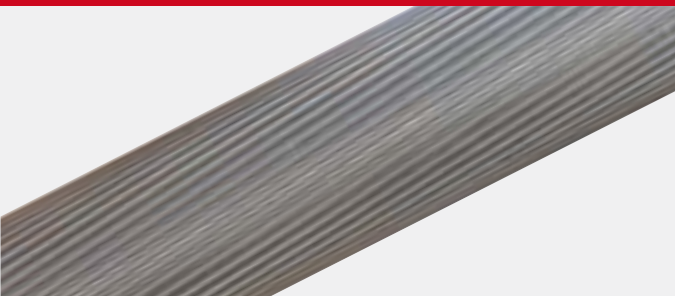

Instead of the standard rubber infeed roller, recommended for planing moist or rough wood

Item No. 4646

Sectioned infeed roller



For thickness compensation of approx. 3 mm, for planing several adjoining bars.

Item No. 4484

Tersa-knife shaft

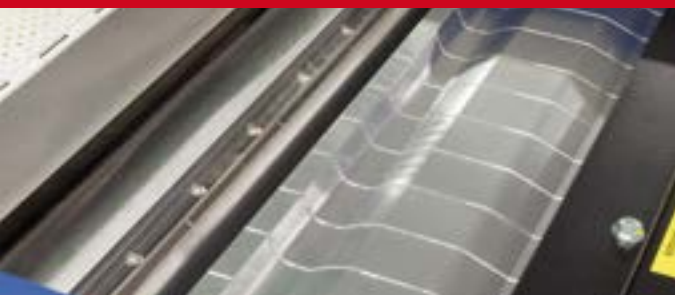

With 4 reversible knives for low-noise operation and quick tool change, precise knife setting.

Item No. 4471

Spiral cutter head



With 6 spiral-shaped rows of blade and HM reversible blades for pulling cut and enormous noise reduction, long life, short chips.

Item No. 4472

Connectible outfeed



Transports short workpieces from 320 mm in length out of the machine

Item No. 4343

Thickness table extension



With automatic height adjustment, prevents tipping over of workpieces
Dimension 1000 x 630 mm

Item No. 4339

SURFACE PLANING MACHINE

334|20 335|20 336|20

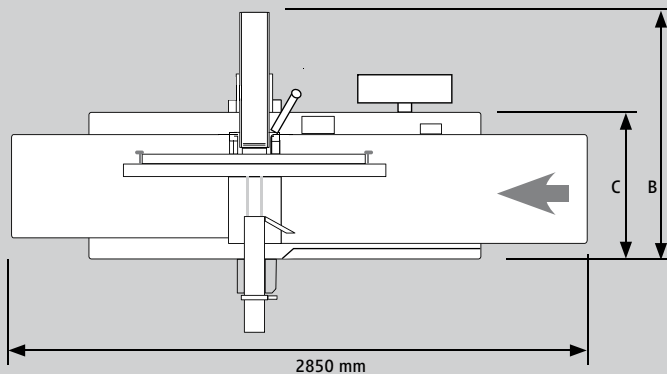

- Planing width 410 / 510 / 630 mm
- Infeed table 1620 mm
- Outfeed table 1170 mm
- Motor power main motor 5.5 kW / 7.5 HP
- Voltage 400 V / 50 Hz
- Suction hood 160 mm
- Knife shaft speed 5000 rpm
- Weight 870 / 1050 / 1400 kg

- Operating panel at eye level
- Electromotive adjustment of the infeed table through pushbutton
- Digital display for cutting height and planing depth
- PANHANS-4 knife shaft with and brass setting devices
- Fence tiltable up to 45° embedded in extremely smooth steel guide with one hand operation
- Planing fence ruler anodized
- Tiltable auxiliary stop 1545
- Finely planed cast iron tables
- Adjustment of hollow and pointy joints at the outfeed table
- Toothed table lips for the reduction of noise
- Console for feeder unit
- Bridge guard TXF 1570 with removable two pieces cover
- Automatic motor brake
- Automatic star/delta starting
- Motor protection switch

B (total depth) **C** (depth machine body)

• 334 20	1320 mm	635 mm
• 335 20	1420 mm	735 mm
• 336 20	1540 mm	855 mm
• Length all models		2850 mm
• Height all models		900/860 mm

THICKNESS PLANING MACHINE

436|10

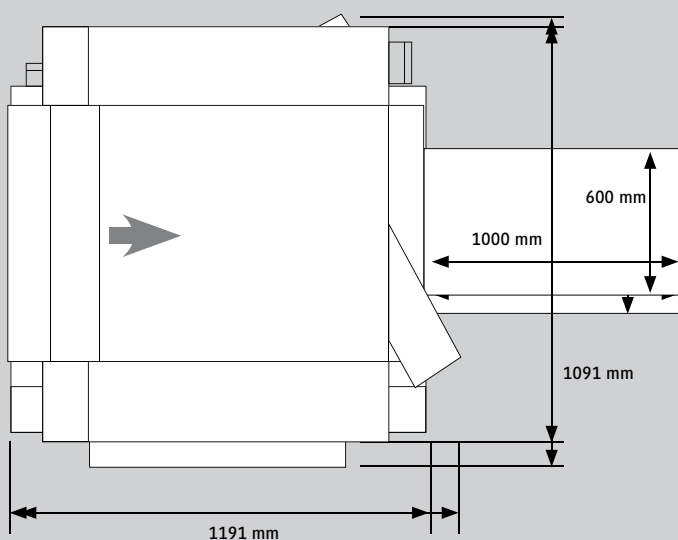

- Planing width 630 mm
- Planing height 3 - 300 mm
- Table length 1100 mm
- Motor power main motor 7.5 kW / 10 HP
- Motor power infeed motor 0.55/0.75 kW / 0.8/1.0 HP
- Feed speed 7 + 14 m/min
- Suction hood 160 mm
- Weight 1050 kg

- Ergonomic machine dimensions
- PANHANS-4 knife shaft with and brass setting devices
- Oscillating mounted feed rollers
- Segmented rubber infeed and rubber outfeed roller \varnothing 90 mm
- 2 feed speeds through pole-changing feed motor
- Segmented pressure beam
- Finely planed thickness table without table rollers
- Thickness table on 4 trapezoid spindles
- Electrical height adjustment of the thickness table
- Position control easy drive
- Automatic motor brake
- Automatic star/delta starting
- Suction hood 160 mm, usable to the left or right

PLANING MACHINE-DUO

334|20 335|20 336|20 + 436|10

- | | | |
|---------------------------|------------------------|---------|
| | A (total depth) | |
| • 334 20 + 436 10 | | 1850 mm |
| • 335 20 + 436 10 | | 1950 mm |
| • 336 20 + 436 10 | | 2070 mm |
| • Total length all models | | 2990 mm |

Basic information of the single machines on page 18

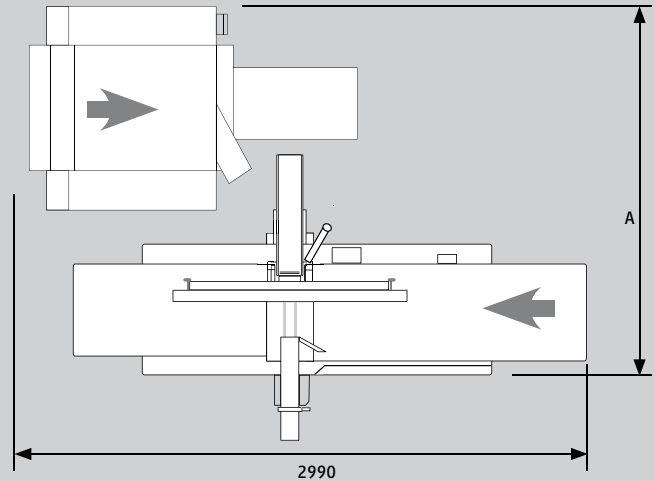

COMBINED PLANING MACHINE

546|10

- | | |
|---------------------------------|-------------------|
| • Planing width | 630 mm |
| • Planing height | 3 - 250 mm |
| • Table length surfacer | 2555 mm |
| • Table length thicknesser | 1100 + 400 mm |
| • Chip removal max. surfacer | 5 mm |
| • Chip removal max. thicknesser | 8 mm |
| • Knife shaft rotating speed | 5000 rpm |
| • Motor power main motor | 7.5 kW / 10 HP |
| • Motor power infeed motor | 0.55 kW / 0.75 kW |
| | 0.8 PS / 1.0 HP |
| • Feed speed | 7 + 14 m/min |
| • Suction hood | 2 x 160 mm ø |
| • Weight | 1210 kg |
| • Voltage | 400 V / 50 Hz |

- Ergonomic machine dimensions
- Finely planed tables
- PANHANS- knife shaft with and brass setting devices
- Pushbutton switch with electronic soft start
- Wear-free electronic motor brake
- 2 suction hoods, 160 mm ø

Surface planing machine

- Electro-motoric adjustment of infeed table by pressing a button
- Bridge protection TXF 1570 with fold-away cover

Thickness planing machine

- Oscillating mounted feed rollers
- Segmented rubber infeed roller
- 2 segmented rubber outfeed rollers
- 2 feed speeds through pole-changing feed motor
- Segmented pressure beam
- Thickness table without table rollers
- Highly ripped thickness table non-tilting on 4 trapezoid spindles
- Electronic height adjustment of thickness table
- Positioning control easy drive

Dimensions in **planing position** 630 mm planing width

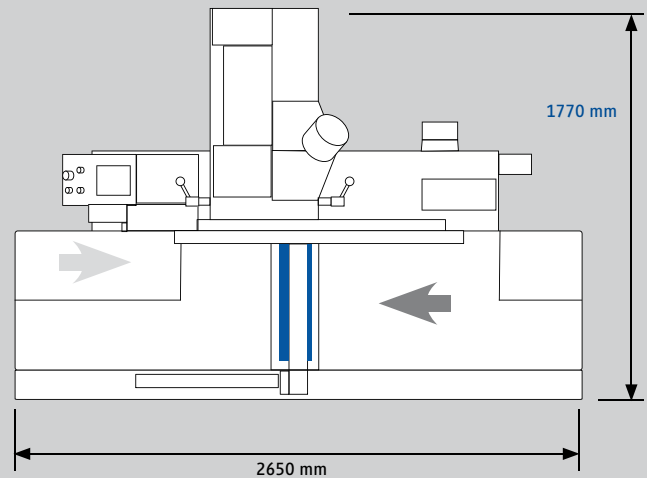

- Total space requirement 2650 x 1770 mm
- Height 912 mm

Dimensions in **dual position** 315 mm planing width

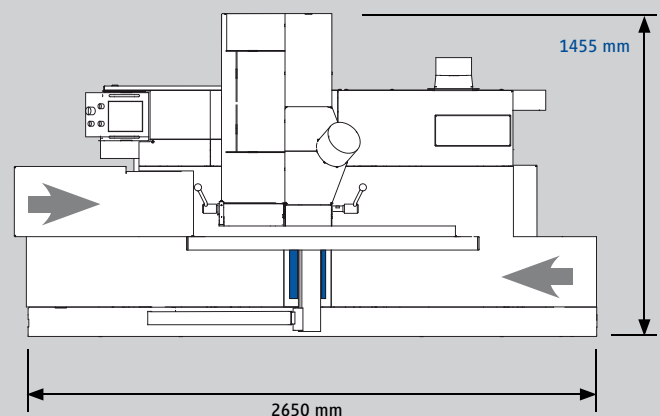

- Total space requirement 2650 x 1455 mm
- Height 912 mm

PANHANS



since 1918

Drilling · Sawing · Milling · Planing · SI-TEC · Service

It's time to get a Panhans

HOKUBEMA

HOKUBEMA
Maschinenbau GmbH

Anton-Günther-Str. 3 - 7
D-72488 Sigmaringen

Phone +49 7571 755-0
Fax +49 7571 755-222

www.hokubema-panhans.de
info@hokubema-panhans.de