

KARPENTER®

Designed by Us Defined by Nature

ASSEMBLING INSTRUCTION

HANGING DESK

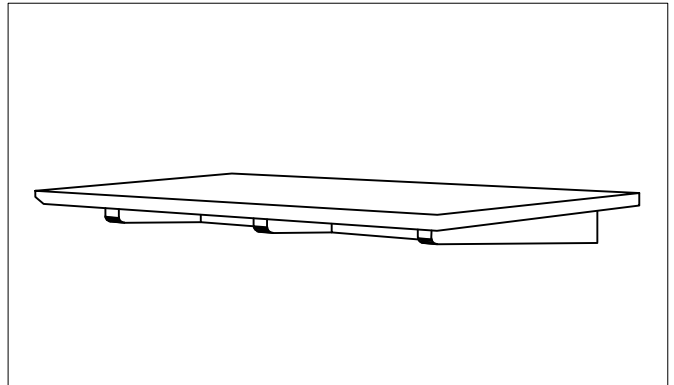

Pre Assembly :

- Please read all instructions before beginning assembly
- Place all parts on a carpet or foam in shipping box. Find the letter (A,B,C,...) on each part and check with below part list to ensure we have all components.
- Save all packing materials until assembly is complete to avoid accidentally discarding smaller parts or hardware.
- This cart requires one people to do assembly.

Parts Included :

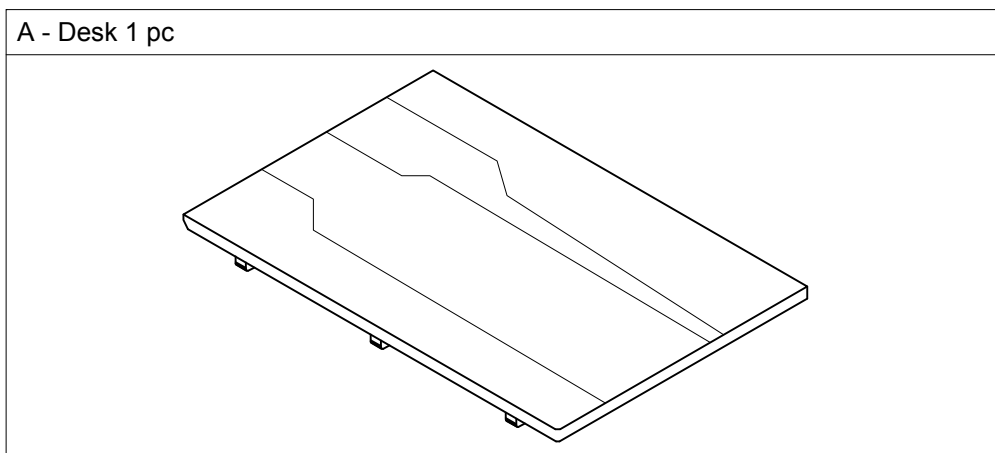

Hardware Enclosed:

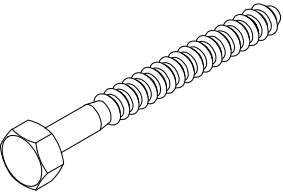
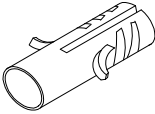
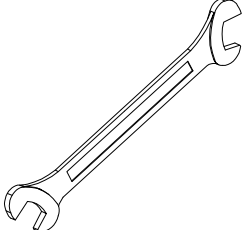
aa - Fischer Screw - 4 pcs	bb - Wall Plug - 4 pcs	cc - Wrench /Tool - not included
		

Assembly Instructions :

1. Lay Cabinet onto clean smooth surface as carpet or cardboard.
2. Drill the wall and insert the Wall Plugs (bb).
3. Hang the Desk (A) to the wall. Secured by Fischer Screw (aa).
Tighten by tool (cc) (not included)

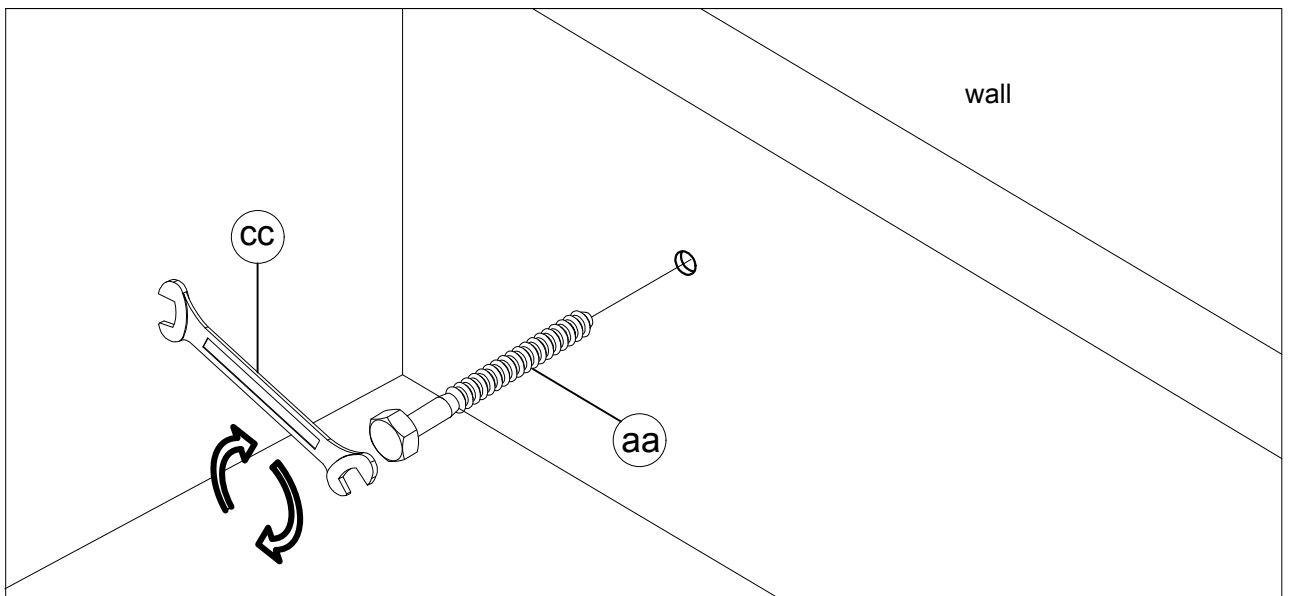
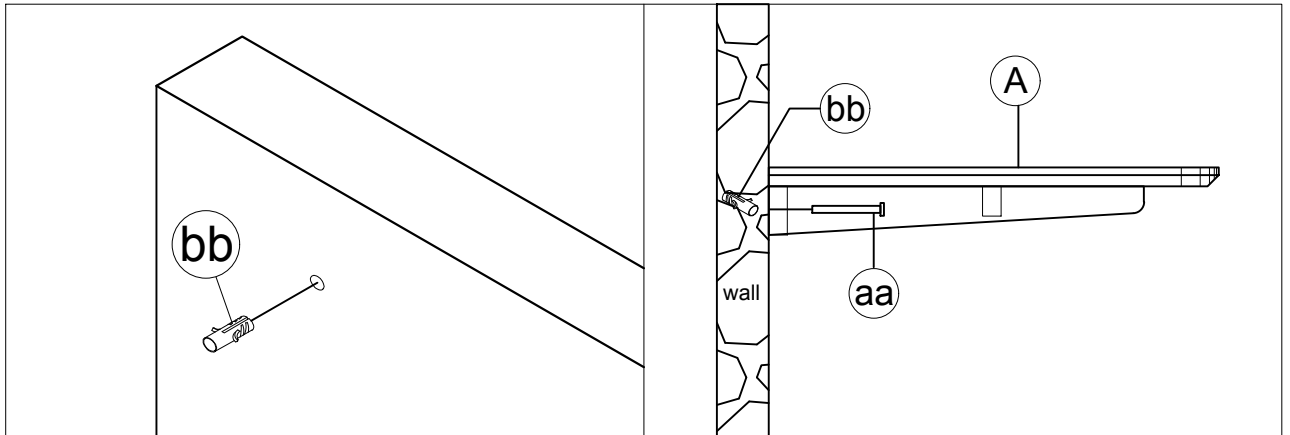

Care Instructions :

- Hardware may loosen over time. Periodically check to make sure all components are tight. Re-tighten if necessary.
- Dust with soft dry cloth.
- Avoid abrasive cleaners. If a cleaner is needed, use a mild-cleaner spray and blot with an absorbent cloth.
- For indoor use only.