

LEVEN DRUM FLOOR LIGHT

Tom Raffield

Product Specification

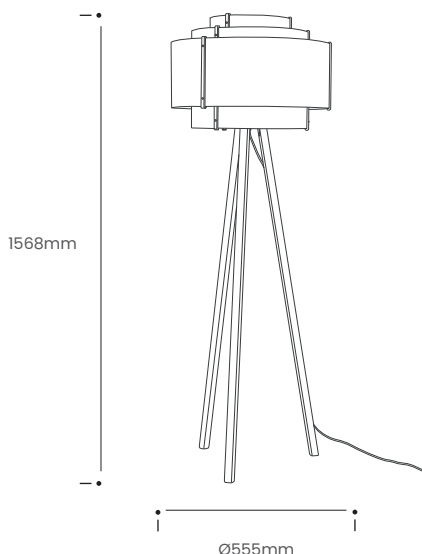





Leven Drum Floor Light



Showcasing structural beauty. Inspired by the striking formations of smooth, sea-eroded cliff faces and ridged headlands that distinguish the north coast of Cornwall, the Leven Lighting Range effortlessly elevates space with its tiered drum aesthetic.

Meaning 'level' in Cornish, the Leven Drum Floor Light is handcrafted using four tiers of curving oak or walnut timber that climb a central plywood frame summit. Secured at the seams with five brass accented rivets, each arching layer of sustainably sourced wood builds a balanced silhouette of careful craftsmanship. Use the Leven Drum Floor Light to brighten a myriad of contemporary living spaces that call out for sophisticated illumination.

Glow beyond. Elevate your interior.

| Product Type : Floor Light | SKU | Wood types | Dimensions L x W x H (mm) | | Weight (kg) | |
|-------------------------------|---|--|--|---|-------------|-------|
| | | | Unboxed | Boxed | Unboxed | Boxed |
| Leven Drum Floor Light | TR-LEVN-WDFLR-O | Oak | Ø555 x 1568 | Shade 615 x 615 x 490 | 4.05 | |
| | TR-LEVN-WDFLR-W | Walnut | | Stand 1260 x 135 x 135 | | |
| Materials | Oak  | Walnut  | Other materials | | | |
| | | | Brass Brackets  | Birch ply frame  | | |
| Finish | Wooden floor stand - Finished with a blend of natural wax oils to give a protective, hardwearing and beautiful finish. Shade - Non-toxic, hard wearing water based varnish - satin | | | | | |
| Wiring kit options | Brass bulb holder with black inline foot switch and plug  | Wiring kit | Flex | Recommended light bulb | | |
| | | Plastic inline foot switch | Flex colour: grey fabric  | | | |
| | | E27 (240v) | Cable length: 240cm from switch to bulb holder. 115cm from switch to plug. | Max 25W LED | | |
| Care information | Dusting your light regularly and with a light feather duster should keep your light looking clean, otherwise wipe with a damp cloth and remove any moisture with a dry cloth. Gentle furniture polishes can also be used. | | | | | |
| Additional information | <ul style="list-style-type: none"> Suitable for use on 240v circuits. This product can be plugged straight into a 240v outlet. Assembly instructions and fixings included. | | | | | |