

## Technical specifications

Panel thickness	min-max 10-50 mm
Edge thickness to be trimmed off	min-max 0,4-3,0 mm
Pneumatic trimming motor	0,37 KW 24.000 RPM (Compressed air 6,5 Bar)
Cutterhead	Shaft Ø 6 mm - Z2 R = 2 mm - Z2 R = 3 mm
Dust collection outlet	Ø 100 mm

We reserve the right to make modifications. The illustrated machines may show some units which are not included in the standard version.  
For photographic reasons some units are without protections. The use of the machine must be made with all protections installed.

## Características técnicas

Altura del panel	min-max 10-50 mm
Espesor del canto	min-max 0,4-3,0 mm
Motor neumático perfilador	0,37 KW 24.000 RPM (aire comprimido 6,5 Bar)
Fresa	Eje Ø 6 mm - Z2 R = 2 mm - Z2 R = 3 mm
Tubo de aspiración	Ø 100 mm

Nos reservamos el derecho de hacer modificaciones sin previo aviso. La máquina ilustrada puede tener equipos no incluidos en la versión estándar.  
Por razones fotográficas algunos grupos son sin protección. El uso de la máquina se entiende con todas las protecciones montadas.

## Características Técnicas

Altura do painel	min-max 10-50 mm
Espessura do canto	min-max 0,4-3,0 mm
Motor pneumático refilador	0,37 KW 24.000 RPM (ar comprimido 6,5 Bar)
Fresa	Eixo Ø 6 mm - Z2 R = 2 mm - Z2 R = 3 mm
Cano de aspiração	Ø 100 mm

Reservamos o direito de fazer modificações sem aviso prévio. A máquina ilustrada pode conter elementos que não estão incluídos na versão padrão.  
Por razões de fotografia alguns grupos são sem protecção. O uso da máquina faz-se com todas as protecções montadas.

## Dimensioni d'ingombro - Overall dimensions - Dimensiones

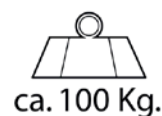
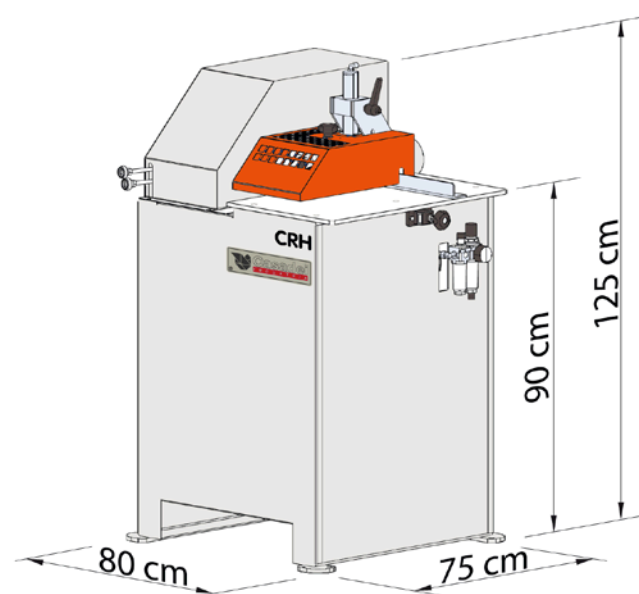

— ProWoodTech —

**Casadei Industria WOOD S.r.l.**

Via Guardia di Rocca, 14  
47899 Serravalle  
Repubblica di San Marino  
Tel. +378 0549 960011  
Fax +378 0549 955010  
www.casadei-industria.com



— ProWoodTech —



**Hydropneumatic copy rounder  
for straight or shaped corners**

**Redondeadora copiadora hidroneumatica  
para angulos rectos y moldurados**

**Arredondeadora copiadora hidropneumática  
para ângulo reto ou em forma**

# CRH

Panel previously edged, end trimmed and flush trimmed by **Casadei Industria Edgebanders**

Panel anteriormente chapeado, retestado y perfilado con **Chapeadoras Casadei Industria**

Painel anteriormente plagado, destopado e refilado com coladeiras **Casadei Industria**

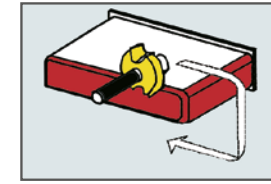
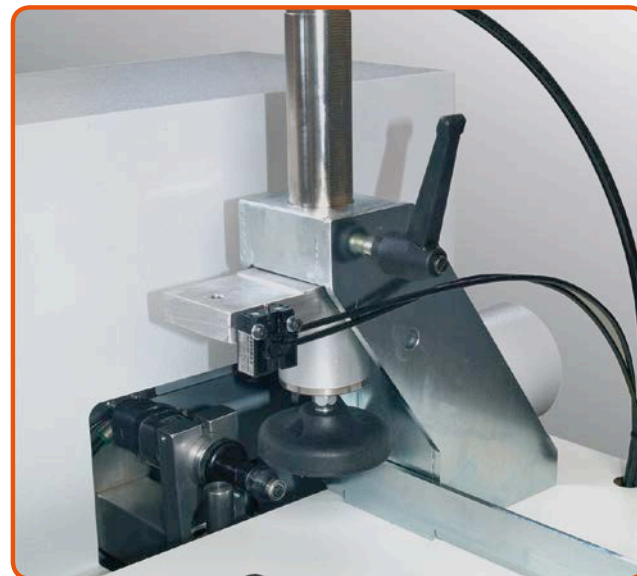
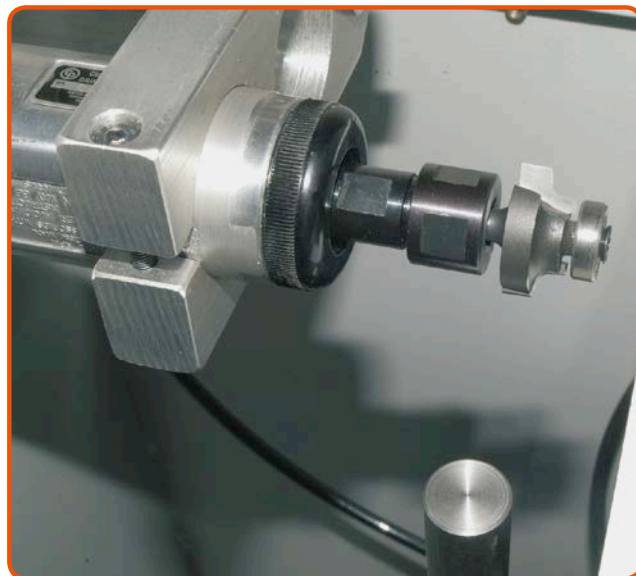
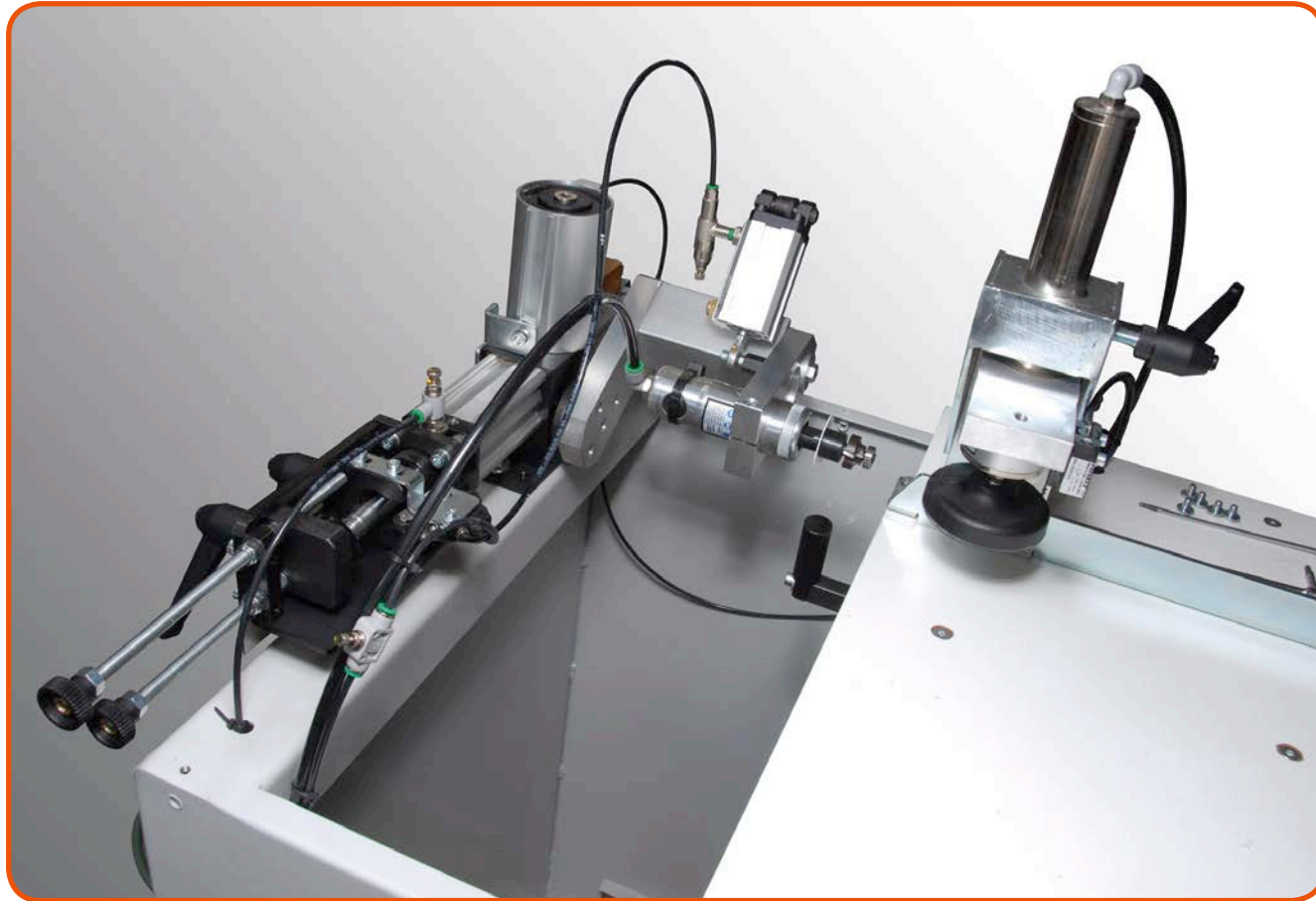

Rounding on straight corner (PVC 2 mm edge)  
Redondeo en angulo recto (canto PVC 2 mm)  
Arredondamento no ângulo reto (bordo PVC 2 mm)

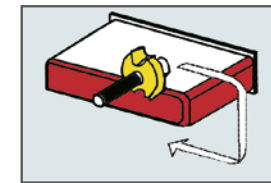
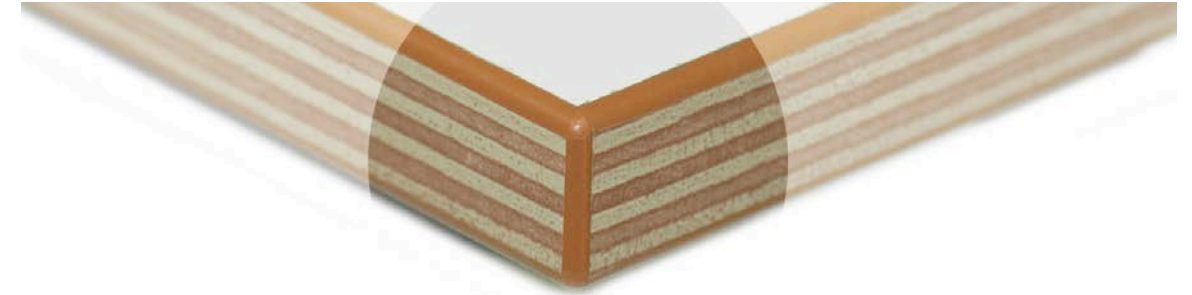

Rounding on shaped corners (post / soft-forming)  
Redondeo en angulo moldurado (post /soft-forming)  
Arredondamento no ângulo em forma(post/soft-forming)

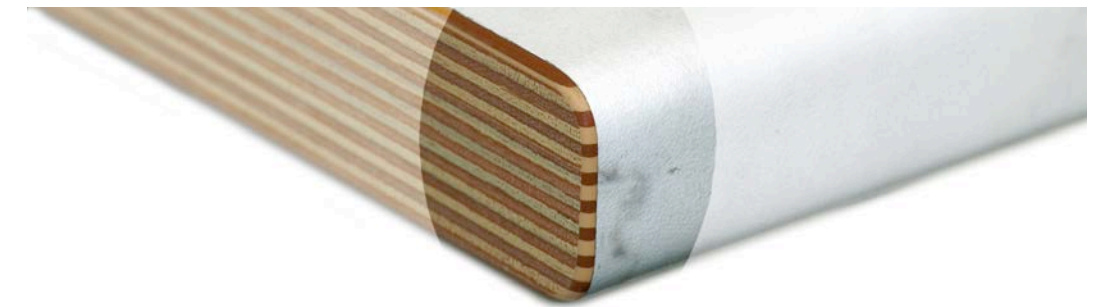
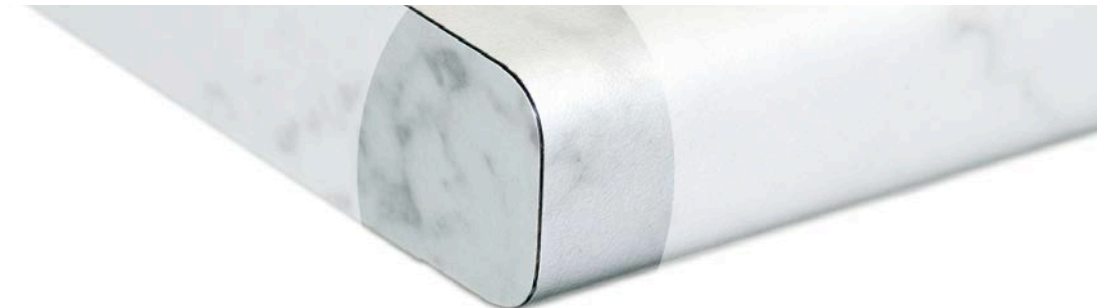

Other profiles that can be rounded with the CRH  
Otros redondeos ejecutables con el CRH  
Mais perfis executáveis com a CRH

