











	Model	EW393E DP-15A	
	Code Production	TH50NTEWZNZMDDPS	
	Interface :		
			
	Overall Dimension (Width-Depth-Height) *open	mm	706x800x1479(1909*)
	Packaging Dimension (WxDxH)	mm	760x840x1520
	Gross weight	Kg	100
	Net weight	Kg	90
	Volume	mc	0,97
	Rack size	mm	500x500
	Max door /hood opening	mm	400
	Max glasses/plate Height	mm	380
	General construction		double skin
	Door/hood Construction		single skin
	Tank construction		deep drawn
	Tank volume	liter	15
	Tank heating element	W	2.200
	Tank surface strainers		Yes- composite
	Wash pump type		double flow
	Wash pump power	W	470
	Wash temperature	°C	55
	Boiler type		pressurized
	Boiler volume	liter	6
	Back-flow system		valve
	Boiler heating element	W	2.730
	Rinse booster pump		NO
	Rinse booster pump power	W	-
	Rinse temperature	°C	80
	Rinse water consumption	Liter /rack	2,2
	Optimal external water pressure	bar	2 - 4
	Drain system		partial drain
	Drain pump		standard built in
	Rinse aid dispenser		YES
	Detergent dispenser		YES
	Wash cycle	sec	60 - 120 - 150 - continuous
	Self cleaning		YES
	Automatic drain		YES
	Electric Power	W	3.200
	Electric Connection	V - ph - Hz	240V 1N 50Hz
	Fuse	A	15
	Plates racks	n° 1	780131
	Flat Rack	n° 1	780132
	Cutterly Rack	n° 1	780139
	Electric cable "Australia"	n° 1	YES
	Drain hose	n° 1	YES
	Fill hose "WaterMark"	n° 1	YES

A		∅ 35 mm M	A	EXIT	∅ 35 mm M
B		G 3/4" M	B	EXIT	G 3/4" F
C		Power supply			



* LUCE UTILE PER CESTELLO
USEFUL SPACE FOR BASKET
LUMIERE UTILE POUR PANIER
NUTZBARE OFFENING FÜR KORBE
ABERTURA UTILI PARA CESTO

Designed by:
M.FUCCI
Date:
03.12.2013

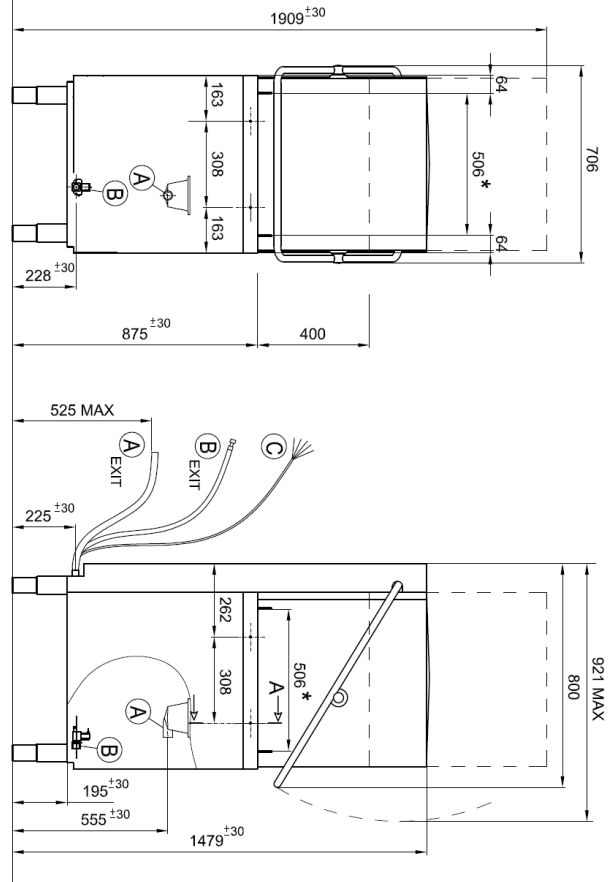
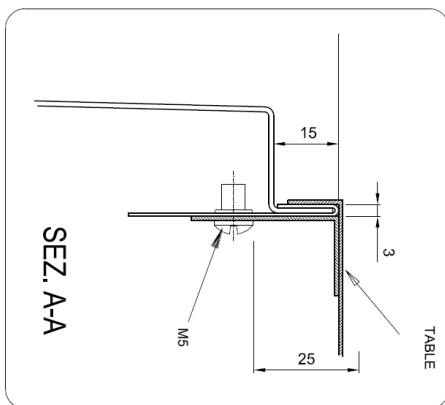
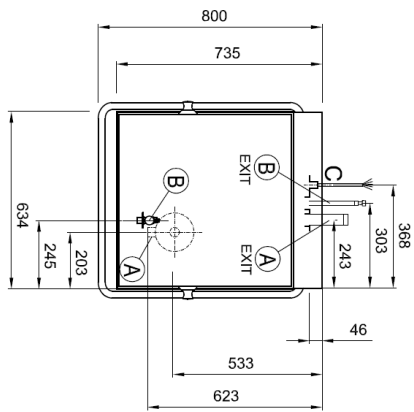
Installation layout

Hood type

Code:
69496A_01

Rev.:

