



HAY LIGHT SOURCE OVERVIEW

Subject to increases in prices and printing errors

LIGHT SOURCE OVERVIEW

CONTENT

Click on the page number to find the product.

30 Degrees S	11	Fifty-Fifty Table Lamp	24	Nelson Saucer Crisscross Bubble Pendant S	8
30 Degrees M	11	Fifty-Fifty Wall	24	Nelson Saucer Crisscross Bubble Pendant M	8
30 Degrees L	11	LBM Corner Table Lamp	22	Nelson Saucer Wall Sconce Cabled S	10
Anagram Table Lamp	13	LBM Table Lamp	22	Neon Tube LED	27
Apex Clip Lamp	16	Marselis Floor Lamp	24	Neon Tube LED Slim 50	27
Apex Desk Clip Lamp	16	Marselis Table Lamp	24	Neon Tube LED Slim 120	27
Apex Desk Lamp	16	Matin Flush Mount 380	3	Noc Clip	13
Apex Floor Lamp	16	Matin Flush Mount 500	3	Noc Wall	13
Apex Table Lamp	16	Matin Table Lamp 300	23	Noc Wall Button	13
Apex Wall Lamp	15	Matin Table Lamp 380	23	Ono Flush Mount 200	17
Apollo Chandelier 745	19	Matin Wall 300	23	Ono Flush Mount 350	17
Apollo Chandelier 1065	19	Matin Wall 380	23	Pao Glass Pendant 350	21
Apollo Portable Lamp	20	Mousqueton Portable Lamp	25	Pao Glass Table Lamp	21
Apollo Table Lamp Shade	13	Nelson Apple Bubble Pendant M	9	Pao Portable Lamp	20
Apollo Wall Sconce	19	Nelson Ball Bubble Pendant S	6	Pao Steel Floor Lamp	14
Arcs Shade	12	Nelson Ball Bubble Pendant M	6	Pao Steel Pendant 230	3
Arcs Wall Sconce	12	Nelson Ball Bubble Pendant L	6	Pao Steel Pendant 350	3
Arcs Wall Switch	12	Nelson Ball Crisscross Bubble Pendant S	8	Pao Steel Pendant 470	3
Bonbon Shade 310	5	Nelson Ball Crisscross Bubble Pendant M	8	Paper Cube Floor Lamp	15
Bonbon Shade 320	5	Nelson Ball Wall Sconce Cabled S	10	Paper Cube Table Lamp	15
Bonbon Shade 380	5	Nelson Bell Bubble Pendant XL	9	Parade Portable Lamp	20
Bonbon Shade 500	5	Nelson Cigar Bubble Pendant L	7	Parade Portable Lamp 240	20
Brim Pendant 245	18	Nelson Cigar Bubble Pendant S	6	Parade Table Lamp 160	26
Buoy Glass Pendant 200	18	Nelson Cigar Bubble Pendant M	6	Parade Table Lamp 240	26
Buoy Glass Pendant 300	18	Nelson Cigar Bubble Pendant XL	7	Parade Table Lamp 320	26
Buoy Glass Table Lamp 200	18	Nelson Cigar Crisscross Bubble Pendant S	8	PC Double arm w. wall bracket	22
Buoy Glass Table Lamp 300	18	Nelson Cigar Crisscross Bubble Pendant M	8	PC Linear	21
Cloche	12	Nelson Cigar Wall Sconce Cabled S	10	PC Pendant S	4
Common Floor Lamp Base	15	Nelson Lantern Bubble Pendant S	10	PC Pendant M	4
Common Pendant Cord Set	5	Nelson Pear Bubble Pendant S	9	PC Pendant L	4
Common Table Cord Set	5	Nelson Pear Bubble Pendant M	9	PC Portable	20
Common Table Lamp Base	15	Nelson Pear Crisscross Bubble Pendant S	9	PC Table S	4
Cupola Clip Lamp	17	Nelson Pear Crisscross Bubble Pendant M	9	PC Table L	4
Cupola Desk Lamp	17	Nelson Pear Wall Sconce Cabled S	11	PC Task Double arm w. clamp	22
Cupola Wall Lamp	17	Nelson Propeller Bubble Pendant M	10	PC Task Double arm w. table base	22
Drome Table Lamp	25	Nelson Saucer Bubble Pendant S	7	PC Task Double arm w. table insert	22
Factor Linear Suspension Lamp	21	Nelson Saucer Bubble Pendant M	7	Rope Trick	25
Fifty-Fifty Floor Lamp	24	Nelson Saucer Bubble Pendant L	7	Slant	12
Fifty-Fifty Mini	24	Nelson Saucer Bubble Pendant XL	7	Turn on	25

LIGHT SOURCE OVERVIEW

HAY recommends using the lamps with LED bulbs only

PRODUCT / BULB NOT INCLUDED

RECOMMENDED LIGHT SOURCE

Pao Steel Pendant 230

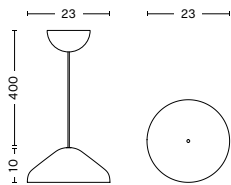

2 x LED G9, 3-5W (max. 5W), 300-600lm, 2700-3000K Warm white



Pao Steel Pendant 350

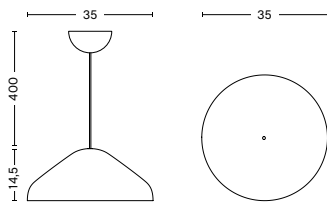

2 x LED E14 (A15), 5-8W (max. 8W), 500-800lm, 2700-3000K Warm white

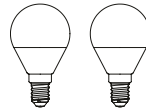

Pao Steel Pendant 470

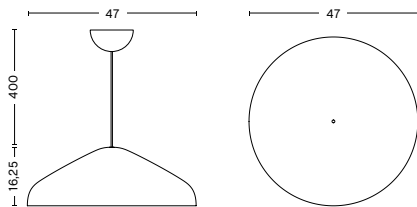

2 x LED E27 (A19), 10-13W (max. 13W), 1000-1500lm, 2700-3000K Warm white

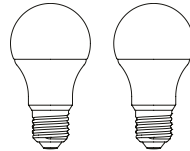

Matin Flush Mount 380

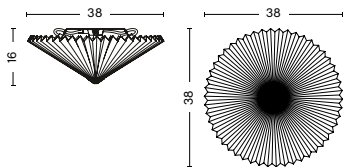

2 x LED E14 (A15 or B8), 5-8W (max. 8W), 500-800lm, 2700-3000K Warm white

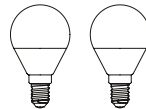

Matin Flush Mount 500

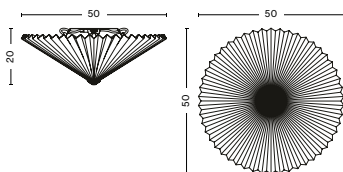

2 x LED E14 (A15 or B8), 5-8W (max. 8W), 500-800lm, 2700-3000K Warm white

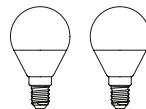

LIGHT SOURCE OVERVIEW

HAY recommends using the lamps with LED bulbs only

PRODUCT / BULB NOT INCLUDED

RECOMMENDED LIGHT SOURCE

PC Pendant S

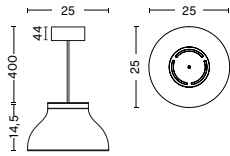

3 x LED G9, 3-5W (max. 5W), 300-600lm, 2700-3000K Warm white

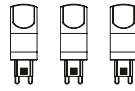

PC Pendant M

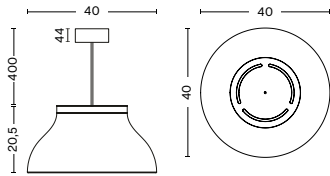

1 x LED E27 (A19), 10-13W (max. 13W), 1000-1500lm, 2700-3000K Warm white

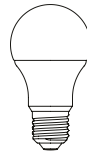

PC Pendant L

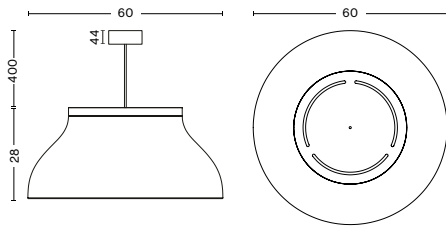

3 x LED E27 (A19), 10-13W (max. 13W), 1000-1500lm, 2700-3000K Warm white

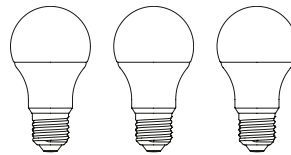

PC Table S

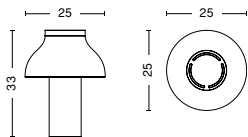

1 x LED E27 (A19), 10-13W (max. 13W), 1000-1500lm, 2700-3000K Warm white, Dimmable

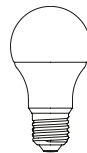

PC Table L

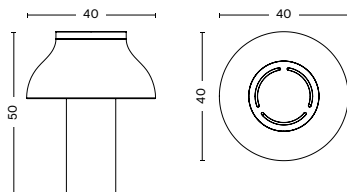

1 x LED E27 (A19), 10-13W (max. 13W), 1000-1500lm, 2700-3000K Warm white, Dimmable

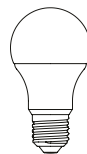

LIGHT SOURCE OVERVIEW

HAY recommends using the lamps with LED bulbs only

PRODUCT / BULB NOT INCLUDED

RECOMMENDED LIGHT SOURCE

Bonbon Shade 310

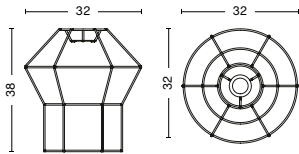

1 x LED E27 (A19), 10-13W (max. 15W), 1000-1500lm, 2700K Warm white

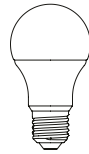

Bonbon Shade 320

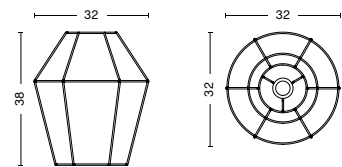

1 x LED E27 (A19), 10-13W (max. 15W), 1000-1500lm, 2700K Warm white

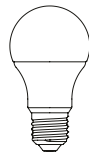

Bonbon Shade 380

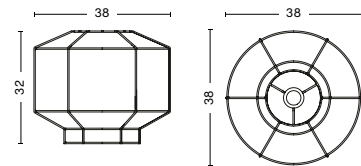

1 x LED E27 (A19), 10-13W (max. 15W), 1000-1500lm, 2700K Warm white

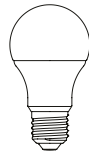

Bonbon Shade 500

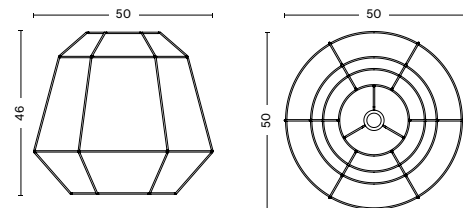

1 x LED E27 (A21 or G30), 10-13W (max. 15W), 1000-1500lm, 2700K Warm white

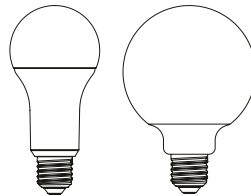

Common Pendant Cord Set

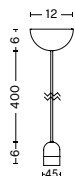

1 x LED E27 (A19) 10-15W, 1000-1500lm, 2700-3000K Warm white

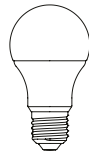

Common Table Cord Set

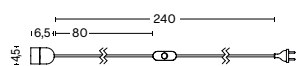

1 x LED E27 (A19) 10-15W, 1000-1500lm, 2700-3000K Warm White

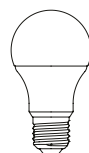

LIGHT SOURCE OVERVIEW

HAY recommends using the lamps with LED bulbs only

PRODUCT / BULB NOT INCLUDED

RECOMMENDED LIGHT SOURCE

Nelson Ball Bubble Pendant S

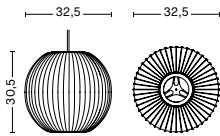

1 x LED E27 (A15), 5-8W (max. 8W), 500-800lm, 2700-3000K Warm white



Nelson Ball Bubble Pendant M

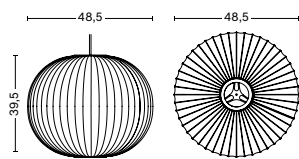

1 x LED E27 (A19), 10-13W (max. 13W), 1000-1500lm, 2700K Warm white

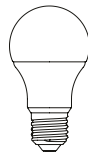

Nelson Ball Bubble Pendant L

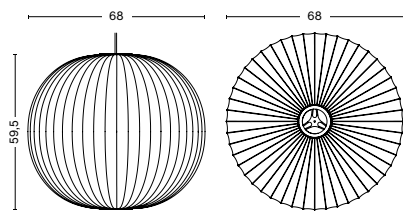

1 x LED E27 (A21 or G30), 10-13W (max. 13W), 1000-1500lm, 2700K Warm white

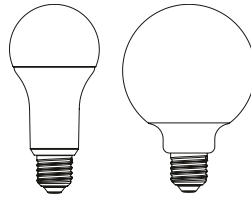

Nelson Cigar Bubble Pendant S

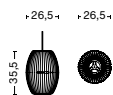

1 x LED E27 (A15), 5-8W (max. 8W), 500-800lm, 2700-3000K Warm white



Nelson Cigar Bubble Pendant M

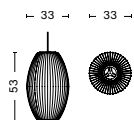

1 x LED E27 (A19), 10-13W (max. 13W), 1000-1500lm, 2700K Warm white

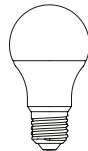

LIGHT SOURCE OVERVIEW

HAY recommends using the lamps with LED bulbs only

PRODUCT / BULB NOT INCLUDED

RECOMMENDED LIGHT SOURCE

Nelson Cigar Bubble Pendant L

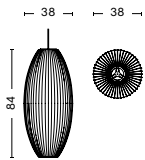

1 x LED E27 (A21 or G30), 10-13W (max. 13W), 1000-1500lm, 2700K Warm white

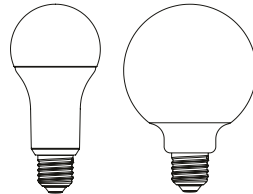

Nelson Cigar Bubble Pendant XL

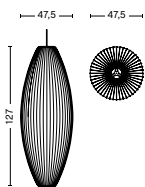

1 x LED E27 (A21 or G30), 10-13W (max. 13W), 1000-1500lm, 2700K Warm white

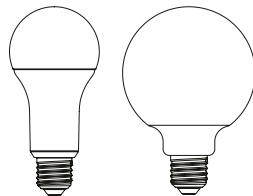

Nelson Saucer Bubble Pendant S

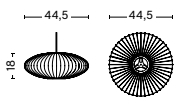

1 x LED E27 (A15), 5-8W (max. 8W), 500-800lm, 2700-3000K Warm white



Nelson Saucer Bubble Pendant M

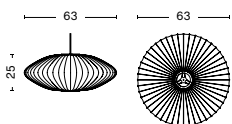

1 x LED E27 (A19), 10-13W (max. 13W), 1000-1500lm, 2700K Warm white

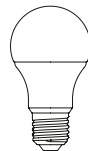

Nelson Saucer Bubble Pendant L

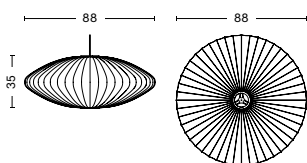

1 x LED E27 (A21 or G30), 10-13W (max. 13W), 1000-1500lm, 2700K Warm white

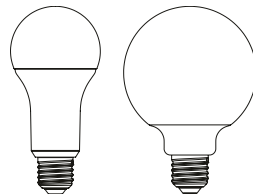

Nelson Saucer Bubble Pendant XL

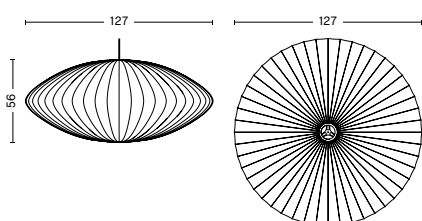

1 x LED E27 (A21 or G30), 10-13W (max. 13W), 1000-1500lm, 2700K Warm white

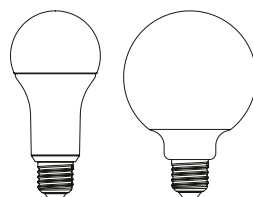

LIGHT SOURCE OVERVIEW

HAY recommends using the lamps with LED bulbs only

PRODUCT / BULB NOT INCLUDED

RECOMMENDED LIGHT SOURCE

Nelson Saucer Crisscross Bubble Pendant S

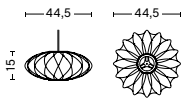

1 x LED E27 (A15,) 5-8W (max. 8W), 500-800lm, 2700-3000K Warm white



Nelson Saucer Crisscross Bubble Pendant M

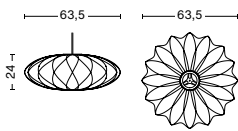

1 x LED E27 (A19), 10-13W (max. 13W), 1000-1500lm, 2700K Warm white

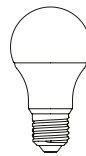

Nelson Ball Crisscross Bubble Pendant S

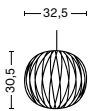

1 x LED E27 (A15), 5-8W (max. 8W), 500-800lm, 2700-3000K Warm white



Nelson Ball Crisscross Bubble Pendant M

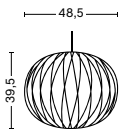

1 x LED E27 (A19), 10-13W (max. 13W), 1000-1500lm, 2700K Warm white

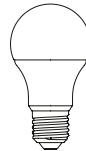

Nelson Cigar Crisscross Bubble Pendant S

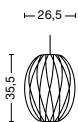

1 x LED E27 (A15), 5-8W (max. 8W), 500-800lm, 2700-3000K Warm white



Nelson Cigar Crisscross Bubble Pendant M

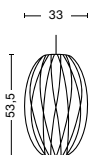

1 x LED E27 (A19), 10-13W (max. 13W), 1000-1500lm, 2700K Warm white

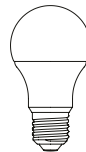

LIGHT SOURCE OVERVIEW

HAY recommends using the lamps with LED bulbs only

PRODUCT / BULB NOT INCLUDED

RECOMMENDED LIGHT SOURCE

Nelson Pear Crisscross Bubble Pendant S

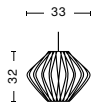

1 x LED E27 (A15), 5-8W (max. 8W), 500-800lm, 2700-3000K Warm white



Nelson Pear Crisscross Bubble Pendant M

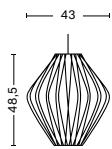

1 x LED E27 (A19), 10-13W (max. 13W), 1000-1500lm, 2700K Warm white

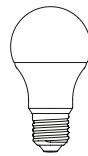

Nelson Pear Bubble Pendant S

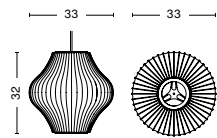

1 x LED E27 (A15), 5-8W (max. 8W), 500-800lm, 2700-3000K Warm white



Nelson Pear Bubble Pendant M

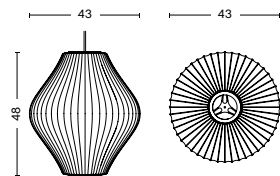

1 x LED E27 (A19), 10-13W (max. 13W), 1000-1500lm, 2700K Warm white

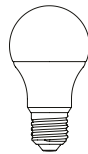

Nelson Apple Bubble Pendant M

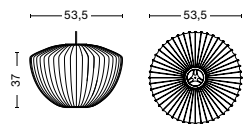

1 x LED E27 (A19), 10-13W (max. 13W), 1000-1500lm, 2700K Warm white

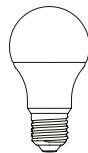

Nelson Bell Bubble Pendant XL

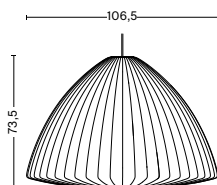

1 x LED E27 (A21 or G30), 10-13W (max. 13W), 1000-1500lm, 2700K Warm white

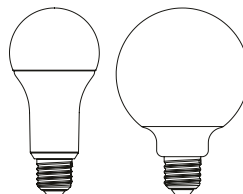

LIGHT SOURCE OVERVIEW

HAY recommends using the lamps with LED bulbs only

PRODUCT / BULB NOT INCLUDED

RECOMMENDED LIGHT SOURCE

Nelson Propeller Bubble Pendant M

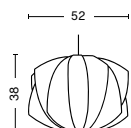

1 x LED E27 (A19), 10-13W (max. 13W), 1000-1500lm, 2700K Warm white

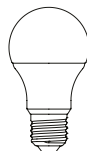

Nelson Lantern Bubble Pendant S

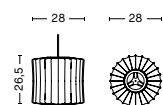

1 x LED E27 (A15), 5-8W (max. 8W), 500-800lm, 2700-3000K Warm white



Nelson Ball Wall Sconce Cabled S

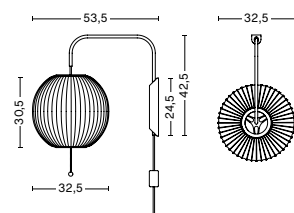

1 x LED E27 (A15), 5-8W (max. 8W), 500-800lm, 2700-3000K Warm white



Nelson Cigar Wall Sconce Cabled S

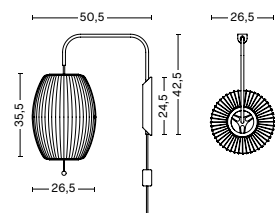

1 x LED E27 (A15), 5-8W (max. 8W), 500-800lm, 2700-3000K Warm white



Nelson Saucer Wall Sconce Cabled S

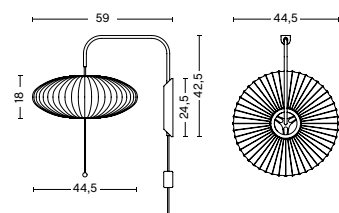

1 x LED E27 (A15), 5-8W (max. 8W), 500-800lm, 2700-3000K Warm white



LIGHT SOURCE OVERVIEW

HAY recommends using the lamps with LED bulbs only

PRODUCT / BULB NOT INCLUDED

RECOMMENDED LIGHT SOURCE

Nelson Pear Wall Sconce Cabled S

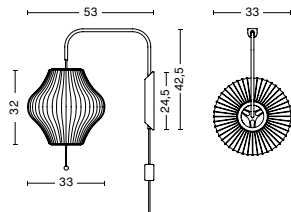

1 x LED E27 (A15), 5-8W (max. 8W), 500-800lm, 2700-3000K Warm white



30 Degrees S

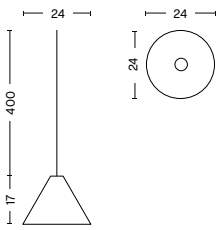

1 x LED E27 (A15), 5-8W (max. 15W), 470lm, 2700K Warm white



30 Degrees M

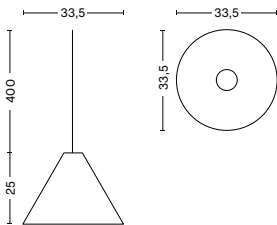

1 x LED E27 (A19), 10-13W (max. 15W), 810lm, 2700K Warm white

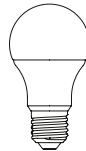

30 Degrees L

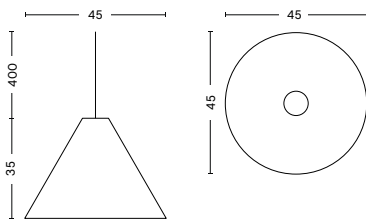

1 x LED E27 (A19), 10-13W (max. 15W), 810lm, 2700K Warm white

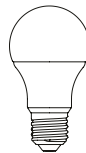

LIGHT SOURCE OVERVIEW

HAY recommends using the lamps with LED bulbs only

PRODUCT / BULB NOT INCLUDED

RECOMMENDED LIGHT SOURCE

Arcs Shade

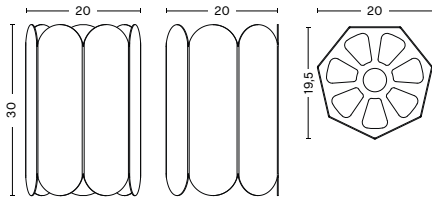

1 x LED E27 (A15 or A19), 10-13W (max. 15W), 1000-1500lm, 2700K Warm white



Arcs Wall Sconce

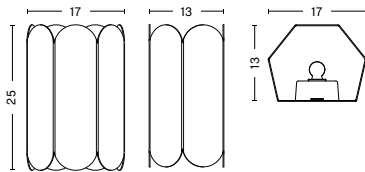

1 x LED E14 (A15 or A19), 5-8W (max. 8W), 500-800lm, 2700-3000K Warm white



Arcs Wall Switch

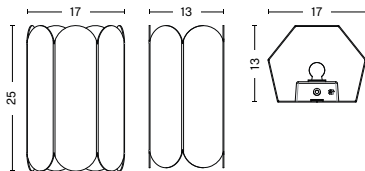

1 x LED E14 (A15 or A19), 5-8W (max. 8W), 500-800lm, 2700-3000K Warm white



Slant

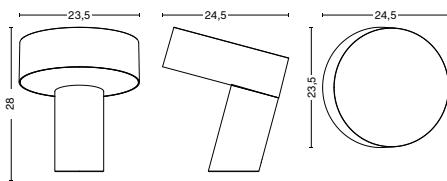

1 x LED E27 (A15 or A19), 10-13W (max. 15W), 1000-1500lm, 2700K Warm white

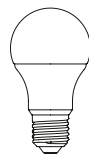

Cloche

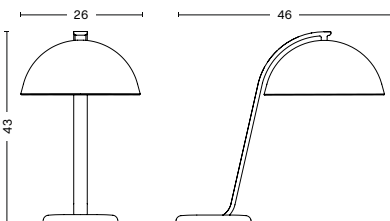

1 x LED E14 (A15), 5.5W (max. 8W), 470lm, 2800K Warm white



LIGHT SOURCE OVERVIEW

HAY recommends using the lamps with LED bulbs only

PRODUCT / BULB NOT INCLUDED

RECOMMENDED LIGHT SOURCE

Noc Clip

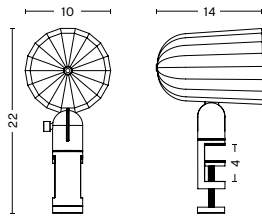

1 x LED E14 (A15), 5.5W (max. 5,5W), 470lm, 2800K Warm white



Noc Wall

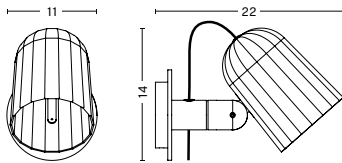

1 x LED E14 (A15), 5.5W (max. 5,5W), 470lm, 2800K Warm white



Noc Wall Button

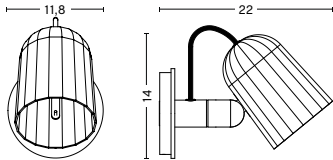

1 x LED E14 (A15), 5.5W (max. 5,5W), 470lm, 2800K Warm white



Apollo Table Lamp Shade

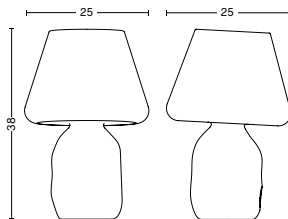

1 x LED E27 (A19), 10-15W (max. 15W), 1000-1500lm, 2700K Warm white

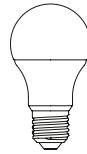

Anagram Table Lamp

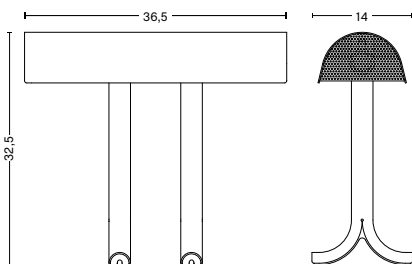

2 x LED E14 (B10), 5-8W (max. 8W), 500-800lm, 2700-3000K Warm white

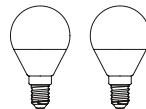

LIGHT SOURCE OVERVIEW

HAY recommends using the lamps with LED bulbs only

PRODUCT / BULB NOT INCLUDED

RECOMMENDED LIGHT SOURCE

Pao Steel Floor Lamp

2 x LED E27 (A19), 10-13W (max. 13W), 1000-1500lm, 2700-3000K Warm white

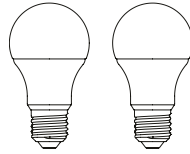
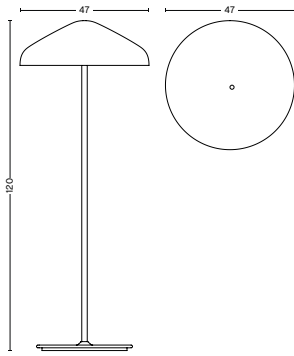

LIGHT SOURCE OVERVIEW

HAY recommends using the lamps with LED bulbs only

PRODUCT / BULB NOT INCLUDED

RECOMMENDED LIGHT SOURCE

Common Table Lamp Base

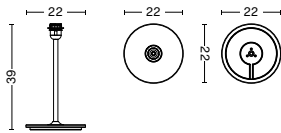

1 x LED E14 (A15), 8-13W (max. 13W), 1000-1500lm, 2700K Warm white



Common Floor Lamp Base

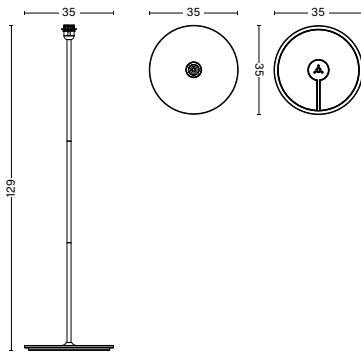

1 x LED E14 (A15), 8-13W (max. 13W), 1000-1500lm, 2700K Warm white



Paper Cube Table Lamp

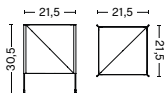

1 x LED E14 (A15), 5-8W (max. 8W), 500-800lm, 2700K Warm white



Paper Cube Floor Lamp

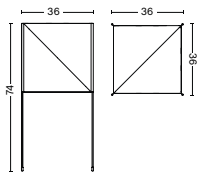

1 x LED E27 (A19), 10-13W (max. 13W), 500-00lm, 2700-3000K Warm white

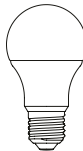

Apex Wall Lamp

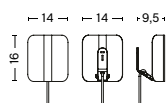

1 x LED E14 (B10), 5-8W (max. 8W), 500-800lm, 2700-3000K Warm white



LIGHT SOURCE OVERVIEW

HAY recommends using the lamps with LED bulbs only

PRODUCT / BULB NOT INCLUDED

RECOMMENDED LIGHT SOURCE

Apex Clip Lamp

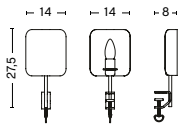

1 x LED E14 (B10), 5-8W (max. 8W), 500-800lm, 2700-3000K Warm white



Apex Desk Clip Lamp

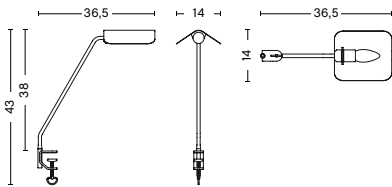

1 x LED E14 (B10), 5-8W (max. 8W), 500-800lm, 2700-3000K Warm white



Apex Desk Lamp

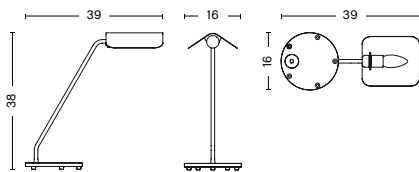

1 x LED E14 (B10), 5-8W (max. 8W), 500-800lm, 2700-3000K Warm white



Apex Table Lamp

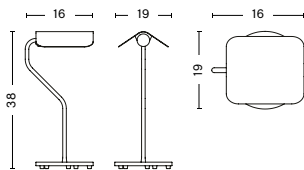

1 x LED E14 (B10), 5-8W (max. 8W), 500-800lm, 2700-3000K Warm white



Apex Floor Lamp

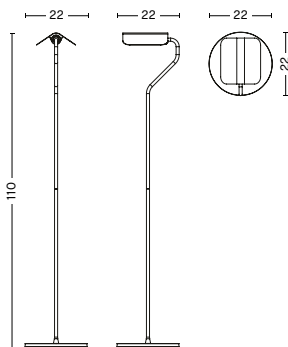

1 x LED E14 (B10), 5-8W (max. 8W), 500-800lm, 2700-3000K Warm white



LIGHT SOURCE OVERVIEW

PRODUCT / BULB NOT INCLUDED

RECOMMENDED LIGHT SOURCE

Cupola Clip Lamp

1 x LED E14 5-8W, 500-800lm, 2700-3000K Warm white

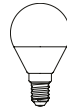
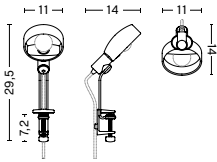

Cupola Desk Lamp

1 x LED E14 5-8W, 500-800lm, 2700-3000K Warm white

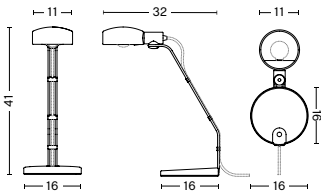

Cupola Wall Lamp

1 x LED E14 5-8W, 500-800lm, 2700-3000K Warm white

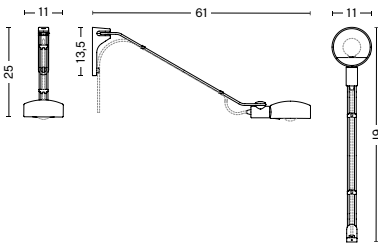

Ono Flush Mount 200

1 x LED E14 (A15) 5-8W, 500-800lm, 2700-3000K Warm white

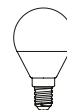
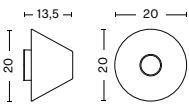

Ono Flush Mount 350

1 x LED E14 (A15) 5-8W, 500-800lm, 2700-3000K Warm white

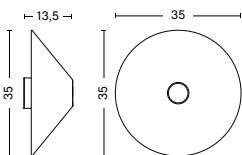

LIGHT SOURCE OVERVIEW

PRODUCT / BULB NOT INCLUDED

RECOMMENDED LIGHT SOURCE

Brim Pendant 245

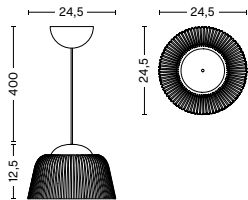

2 x LED G9 3-6W, 500-800lm, 2700-3000K Warm white



Buoy Glass Pendant 200

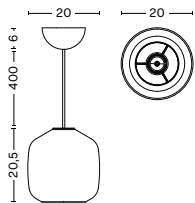

1 x LED E27 (A19), 10-15W (max. 15W), 1000-1500lm, 2700-3000K Warm white

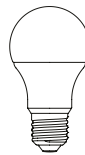

Buoy Glass Pendant 300

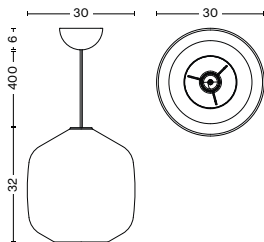

1 x LED E27 (A19), 10-15W (max. 15W), 1000-1500lm, 2700-3000K Warm white

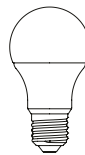

Buoy Glass Table Lamp 200

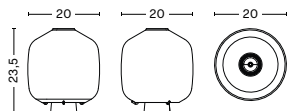

1 x LED E27 (A19), 10-15W (max. 15W), 1000-1500lm, 2700-3000K Warm white

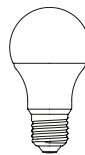

Buoy Glass Table Lamp 300

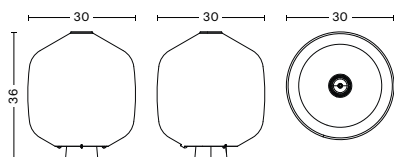

1 x LED E27 (A19), 10-15W (max. 15W), 1000-1500lm, 2700-3000K Warm white

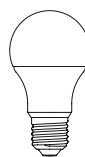

LIGHT SOURCE OVERVIEW

HAY recommends using the lamps with LED bulbs only

PRODUCT / BULB NOT INCLUDED

RECOMMENDED LIGHT SOURCE

Apollo Chandelier 745

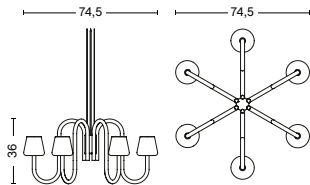

6 x LED G9, 3-5W (max. 5W), 300-600lm, 2700-3000K Warm white

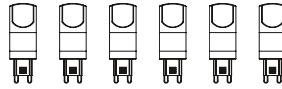

Apollo Chandelier 1065

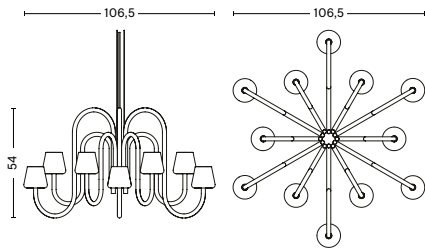

12 x LED G9, 3-5W (max. 5W), 300-600lm, 2700-3000K Warm white

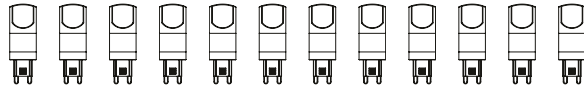

Apollo Wall Sconce

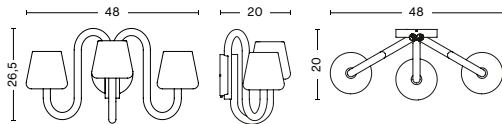

3 x LED G9, 3-5W (max. 5W), 300-600lm, 2700-3000K Warm white

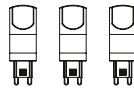

LIGHT SOURCE OVERVIEW

HAY recommends using the lamps with LED bulbs only

PRODUCT / BULB INCLUDED

LIGHT SOURCE

Apollo Portable Lamp

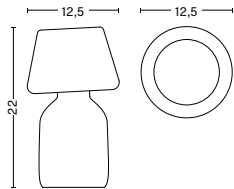

1 x LED G4, 3W, 220lm, 2800K Warm white



Micro USB cable included for charging with a standard USB outlet

Pao Portable Lamp

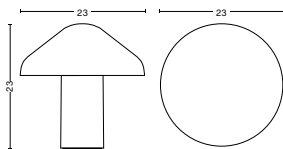

1 x LED G4, 3W, 220lm, 2800K Warm white



Micro USB cable included for charging with a standard USB outlet

PC Portable

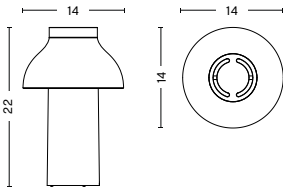

1 x LED G4, 3W, 220lm, 2800K Warm white



Micro USB cable included for charging with a standard USB outlet

Parade Portable Lamp 160

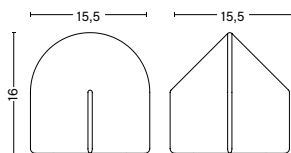

1 x LED G4, 3W, 220lm, 2800K Warm white



Micro USB cable included for charging with a standard USB outlet

Parade Portable Lamp 240

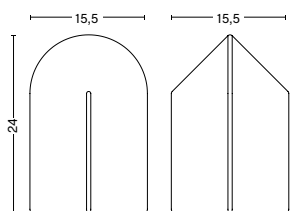

1 x LED G4, 3W, 220lm, 2800K Warm white



Micro USB cable included for charging with a standard USB outlet

LIGHT SOURCE OVERVIEW

PRODUCT / INTEGRATED LED

LIGHT SOURCE

Pao Glass Pendant 350

Integrated LED, 10W, 690lm 2600K Warm white

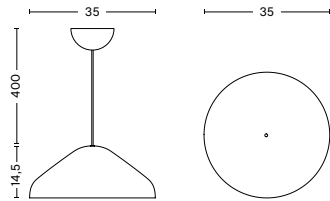

Pao Glass Table Lamp

Integrated LED, 11W, 700lm 2600K Warm white

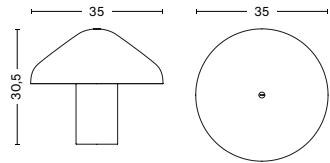

PC Linear

Integrated LED, 28W, 2300lm, 3000K Warm white

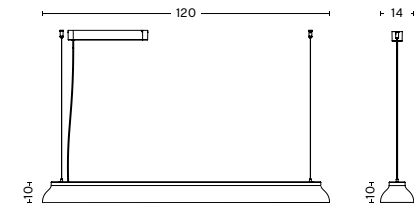

Factor Linear Suspension Lamp

Integrated LED, 38W, 2300lm (Diffused), 3600lm (Directional), 2600K (Diffused), 3500K (Directional) Warm white

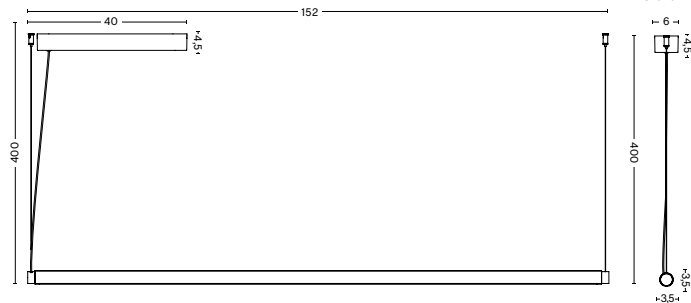

LIGHT SOURCE OVERVIEW

PRODUCT / INTEGRATED LED

LIGHT SOURCE

PC Task Double arm w. clamp

Integrated LED, 5.7W, 407lm, 3100K cool white

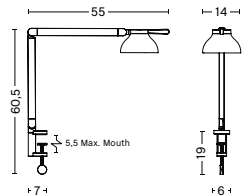

PC Double arm w. wall bracket

Integrated LED, 5.7W, 407lm, 3100K cool white

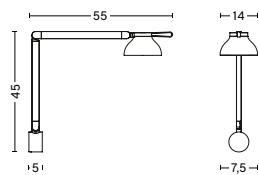

PC Task Double arm w. table insert

Integrated LED, 5.7W, 407lm, 3100K cool white

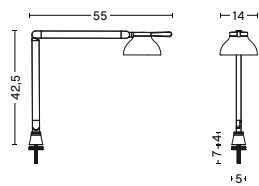

PC Task Double arm w. table base

Integrated LED, 5.7W, 407lm, 3100K cool white

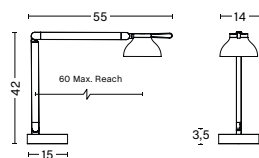

LBM Table Lamp

Integrated LED, 8W, 360lm, 2800K Warm white

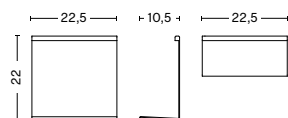

LBM Corner Table Lamp

Integrated LED, 8W, 430lm, 2860K Warm white

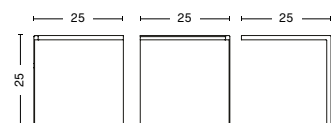

LIGHT SOURCE OVERVIEW

PRODUCT / INTEGRATED LED

LIGHT SOURCE

Matin Table Lamp 300

Integrated LED, 5W, 150lm, 2800K Warm white

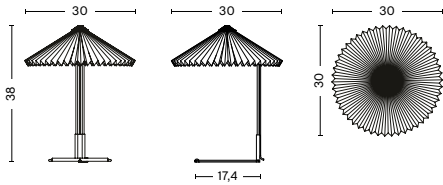

Matin Table Lamp 380

Integrated LED, 5W, 150lm, 2800K Warm white

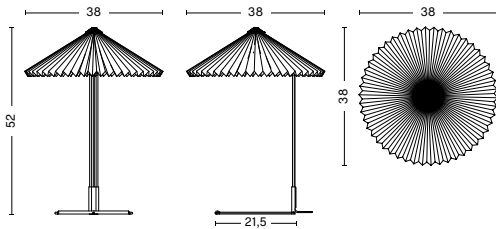

Matin Wall 300

Integrated LED, 5W, 150lm, 2800K Warm white

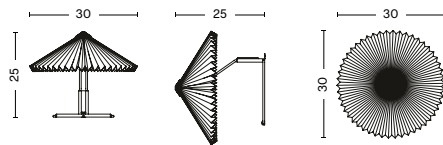

Matin Wall 380

Integrated LED, 5W, 150lm, 2800K Warm white

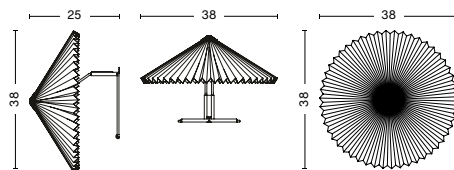

Matin Wall 380

Integrated LED, 12W, 420lm, 2600K Warm white

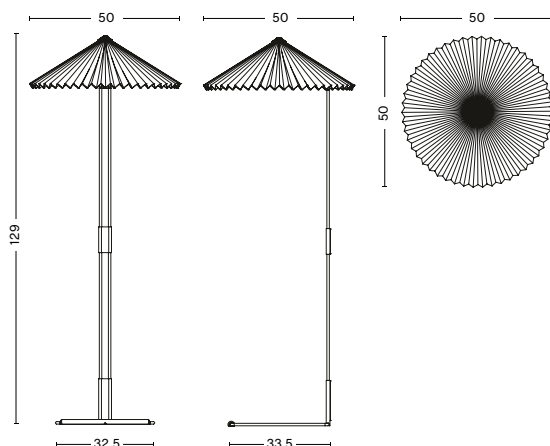

LIGHT SOURCE OVERVIEW

PRODUCT / INTEGRATED LED

LIGHT SOURCE

Fifty-Fifty Wall

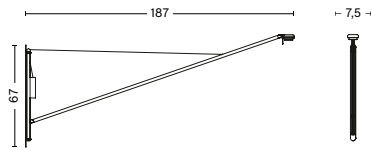

Integrated LED, 7,7W, 700lm, 3100K cool white

Fifty-Fifty Mini

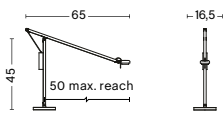

Integrated LED, 4W, 360lm, 3000K Warm white

Fifty-Fifty Table Lamp

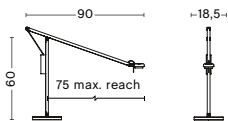

Integrated LED, 4W, 360lm, 3000K Warm white

Fifty-Fifty Floor Lamp

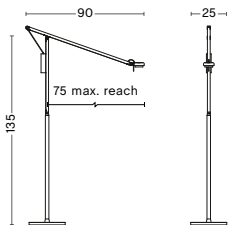

Integrated LED, 4W, 360lm, 3000K Warm white

Marselis Table Lamp

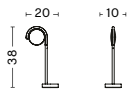

Integrated LED, 4W, 213lm 2700K Warm white

Marselis Floor Lamp

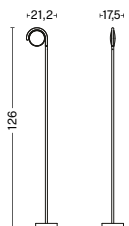

Integrated LED, 4W, 213lm 2700K Warm white

LIGHT SOURCE OVERVIEW

PRODUCT / INTEGRATED LED

LIGHT SOURCE

Turn on

Integrated LED, 4.5W, 250lm, 2700K Warm white

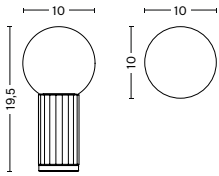

Rope Trick

Integrated LED, 10W, 410lm, 3000K Warm white

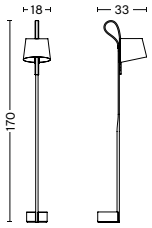

Mousqueton Portable Lamp

Integrated LED, 3W, 157lm, 2550K Warm white

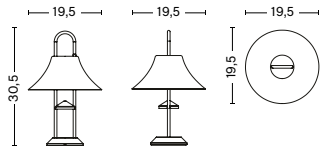

Drome Table Lamp

Integrated LED, 8W, 380lm, 2700K Warm white

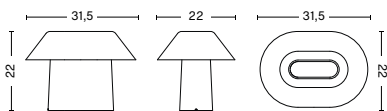

LIGHT SOURCE OVERVIEW

PRODUCT / INTEGRATED LED

LIGHT SOURCE

Parade Table Lamp 160

Integrated LED, 5W, 150lm, 2800K Warm white

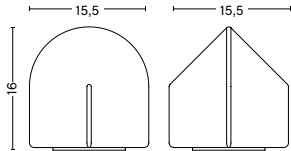

Parade Table Lamp 240

Integrated LED, 5W, 150lm, 2800K Warm white

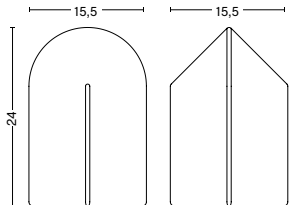

Parade Table Lamp 320

Integrated LED, 5W, 150lm, 2800K Warm white

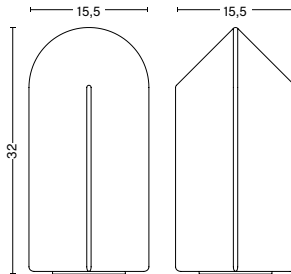

LIGHT SOURCE OVERVIEW

PRODUCT / INTEGRATED LED

LIGHT SOURCE

Neon Tube LED

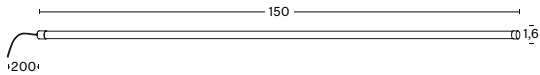

WARM WHITE Integrated LED, 14W, 1463lm, 3000K Warm white

RED Integrated LED, 11W, 202lm, 1000K Warm white

ICE BLUE Integrated LED, 15W, 987lm, 3000K Warm white

PINK Integrated LED, 15W, 596lm, 1970K Warm white

YELLOW Integrated LED, 14W, 1111lm, 2000K Warm white

Not dimmable, not connectable, no replaceable light source

Neon Tube LED Slim 50

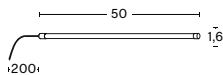

WARM WHITE Integrated LED, 3,5W, 208lm, 3000K Warm white

BLUE Integrated LED, 3,5W, 117lm, 3000K Warm white

PINK Integrated LED, 3,5W, 75lm, 1970K Warm white

YELLOW Integrated LED, 3,5W, 190lm, 2000K Warm white

Not dimmable, not connectable, no replaceable light source

Neon Tube LED Slim 120

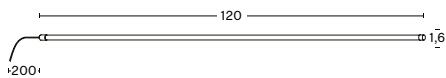

WARM WHITE Integrated LED, 7,5W, 486lm, 3000K Warm white

BLUE Integrated LED, 7,5W, 117lm, 3000K Warm white

PINK Integrated LED, 7,5W, 144lm, 1970K Warm white

YELLOW Integrated LED, 7,5W, 375lm, 2000K Warm white

Not dimmable, not connectable, no replaceable light source

HAY

COPYRIGHT / HAY 2025

WWW.HAY.COM