

Amantii

ELECTRIC FIREPLACE

www.amantii.com

INSTALLATION AND OPERATION INSTRUCTIONS FOR

SYM-50-XT BESPOKE	BS1910050-1
SYM-60-XT BESPOKE	BS1910060-1
SYM-74-XT BESPOKE	BS1910074-1
SYM-88-XT BESPOKE	BS1910088-1
SYM-100-XT BESPOKE	BS1910100-1

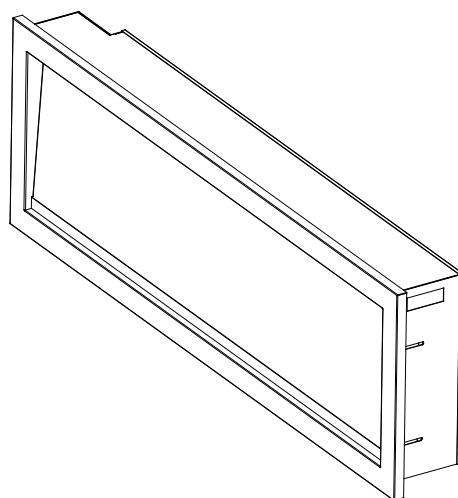

SAFETY INFORMATION



WARNING

if the information in these instructions are not followed exactly, a fire or explosion may result causing property damage, personal injury or loss of life.

Do not store or use gasoline or other flammable vapors and liquids in the vicinity of this or any other.

INSTALLER: LEAVE THIS MANUAL WITH THE APPLIANCE.

CONSUMER: RETAIN THIS MANUAL FOR FUTURE REFERENCE.



WARNING: This product can expose you to chemicals including lead in the wiring, which is [are] known to the State of California to cause birth defects of other reproductive harm. For more information visit: www.p65warnings.ca.gov

TABLE OF CONTENTS

Please read and carefully follow all of the instruction found in this manual. The instructions included here will assure that you have many years of dependable and enjoyable service from your Amantii Electric Fireplace.

IMPORTANT INSTRUCTIONS	3
CAUTIONS	4
FCC STATEMENT	5
UNPACKING AND TESTING APPLIANCE	6
GROUNDING APPLIANCE	6
LOCATING THE FIREPLACE	6
PRODUCT SPECIFICATION	7
OUTDOOR INSTALLATIONS	9
INSTALLATION- BUILT-IN	10
HARDWIRE INSTALLATION	13
DECORATIVE MEDIA INSTALLATION	15
MANUAL OPERATION	16
REMOTE CONTROL OPERATION	17
TROUBLE SHOOTING	20
REPLACEMENT PARTS	21
EXPLODED VIEW	22
ELECTRIC FIREPLACE WARRANTY	23

IMPORTANT INSTRUCTIONS

1. Read all instructions before installing or using this heater.
2. Keep combustible materials, such as furniture, pillows, bedding, papers, clothes and curtains at least 3 feet from the front, sides and rear of the heater.
3. Always unplug heater when not in use.
4. Do not operate the fireplace if it has a damaged cord or plug, after it has malfunctioned, or if the unit has been dropped or damaged in any way.
5. Do not run the cord under carpeting. Do not cover the cord with throw rugs, runners or anything else. Arrange the cord away from traffic areas where it could not be tripped over.
6. To disconnect the heater, turn the controls to "OFF" before removing the plug from the outlet.
7. Do not insert or allow foreign objects to enter any ventilation or exhaust opening, as this may cause an electric shock, fire or damage to the heater.
8. To prevent a possible fire, do not block air intakes in any manner.
9. A heater has hot and arcing or sparking parts inside. Do not use it in areas where gasoline, paint or flammable liquids are used or stored.
10. Use this heater only as described in this manual. Any other use not recommended by the manufacturer may cause fire, electric shock or injury.
11. Avoid the use of an extension cord, the extension cord will overheat and cause a fire. This heater is not to be used with an extension cord.
12. Always use properly grounded fused and polarized outlets.
13. Always use ground fault protection where it is required by electrical codes.
14. Always disconnect the power before performing any cleaning, maintenance or relocation of the heater.
15. To prevent a possible fire, do not burn wood or other materials in this heater.
16. To prevent electric shock or fire, always use a certified electrician, should new circuits or outlets be required.
17. When transporting or storing the heater, keep it in a dry place, free from excessive vibration.
18. This appliance should not be modified under any circumstances.
19. Packaging material should be kept away from children and be disposed of in a safe manner. Plastic bags are not toys and should be kept away from children and infants.
20. Do not use this heater in small rooms when they are occupied by persons not capable of leaving the room on their own, unless constant supervision is provided.
21. If the glass is damaged, do not use the heater in order to avoid a hazard.
22. Do not leave children unsupervised where heater is turned on.
23. CAUTION Some parts of this product can become very hot and cause burns. Particular attention has to be given where children and vulnerable people are present.

SAVE THESE INSTRUCTIONS

CAUTIONS

Do's	Always install the heater in accordance with this guide. If in doubt obtain expert advice.
	Always make sure the electrical socket is accessible and located adjacent to, but not above the heater.
	Always disconnect the heater from the electrical supply before moving it, or carrying out cleaning, maintenance.
	Always make sure the heater is firmly secured to prevent it from being tipped over.
	Always use a fireguard when young children and infirm persons can come into contact with the heater.
Don'ts	Never leave children unsupervised in a room where the heater is ON and unguarded.
	Never obstruct or cover the fan outlet or force items into heater openings.
	Never use aerosols or steam cleaners on or around the heater.
	Never route the main supply cable under carpet etc.
	Never install the heater close to curtains or combustible materials.
	Never use the heater to dry clothes etc.
	Never sit or stand on the heater.

FCC CAUTIONS

This device complies with part 15 of the FCC Rules. Operation is subject to the following two conditions:(1)This device may not cause harmful interference, and (2) this device must accept any interference received, including interference that may cause undesired operation.

Any Changes or modifications not expressly approved by the party responsible for compliance could void the user's authority to operate the equipment.

Note:This equipment has been tested and found to comply with the limits for a Class B digital device, pursuant to part 15 of the FCC Rules. These limits are designed to provide reasonable protection against harmful interference in a residential installation. This equipment generates uses and can radiate radio frequency energy and, if not installed and used in accordance with the instructions, may cause harmful interference to radio communications. However, there is no guarantee that interference wil not occur in a particular installation. If this equipment does cause harmful interference to radio or television reception, which can be determined by turning the equipment off and on,the user is encouraged to try to correct the interference by one or more of the following measures:

Reorient or relocate the receiving antenna

Increase the separation between the equipment and receiver.

Connect the equipment into an outlet on a circuit different from that to which the receiver is connected.

Consult the dealer or an cxperienced radio/TV technician for help.

This equipment complies with FCC radiation exposure limits set forth for an uncontrolled environment. This equipment should be installed and opeated with minimum distance 20cm between the radiator & your body.

UNPACKING AND TESTING APPLIANCE

Carefully remove the appliance from the box.

Prior to installing the appliance, test to make sure the appliance operates properly by plugging the power supply cord into a 120 Volt grounded outlet.

Test all aspects of its operation (manual switches, remote and heater) to make sure all components are operating correctly.

As with most electronic devices, your new electric fireplace has been designed to operate at temperatures between 5 °C (41 °F) and 35 °C (95 °F). During the cold winter months, allow the fireplace to reach room temperature before turning it on.

NOTE: There may be trace of odor during the first few minutes of initial use. This is harmless, normal and will never occur again.

GROUNDING APPLIANCE

This appliance is for use on 120 Volts. The cord has a plug as shown in (A). An adapter as shown in (C) is available for connecting three-blade grounding type plugs to two-slot. The green grounding lug extending from the adapter must be connected to a permanent ground such as a properly grounded outlet box. The adapter should not be used if a three-slot grounded receptacle is available.

To disconnect appliance, turn controls to off, then remove plug from outlet.

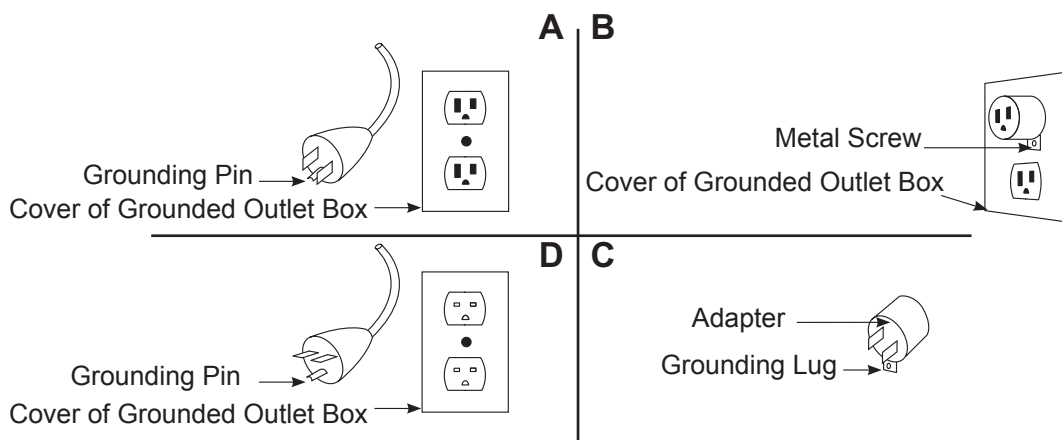

LOCATING THE FIREPLACE

Plan where to locate and frame the fireplace. This will save time and money later when you install the fireplace. Before installation consider the following:

1. Where the fireplace is located must allow for wall and ceiling clearances.
2. Consider a location where the fireplace screen will not be exposed to direct sunlight from windows or doors.
3. A 15 ampere, 120 Volt, 60 Hz branch circuit with proper ground must be available at the location. Preferably a dedicated branch circuit should be provided to avoid circuit breakers to trip or fuses to blow.

PRODUCT SPECIFICATION

This appliance has been tested in accordance with the UL Standard 2021 for fixed and location dedicated electric room appliances in the United States and Canada. If you need assistance during installation, please contact your local dealer.

NOTE: This appliance must be electrically wired and grounded in accordance with local codes. In the absence of local codes, use the current CSA C22.1 Canadian Electrical Code in Canada or the ANSI/NFPA 70 National Electrical Code in the United States.

product model	BS1910050-1 (SYM-50-XT BESPOKE)		BS1910060-1 (SYM-60-XT BESPOKE)	
Voltage	120V AC 60Hz	240V AC 60Hz	120V AC 60Hz	240V AC 60Hz
Watts	1500W	3000W	1500W	3000W
BTU	5120	10240	5120	10240
Appliance size (W x H x D)	50 1/4" x 20 1/8" x 11 3/4" 127.6 x 51 x 29.7cm		60 1/4" x 20 1/8" x 11 3/4" 153 x 51 x 29.7cm	
Glass Viewing (W1 x H1)	48 3/8" x 17 5/8" 123.1 x 44.6 cm		58 3/8" x 17 5/8" 148.4 x 44.6 cm	
Frame size (W2 x H2)	52 1/4" x 21 3/8" 132.7 x 54.4 cm		62 1/4" x 21 3/8" 158.2 x 54.4 cm	
Wall Opening Size (W3 x H3 x D3)	50 3/4" x 20 1/2" x 12 1/4" 128.9 x 52.3 x 31.1 cm		60 3/4" x 20 1/2" x 12 1/4" 154.3 x 52.3 x 31.1 cm	
Cord Length	L =70.9" L =180 cm			

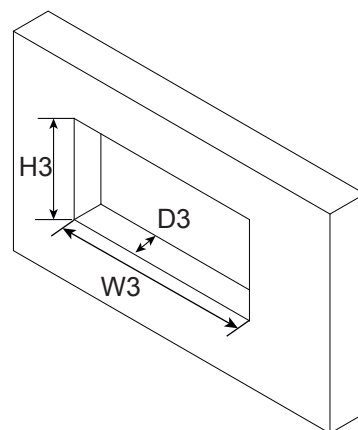
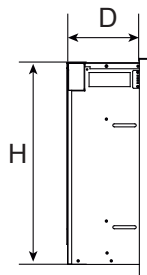
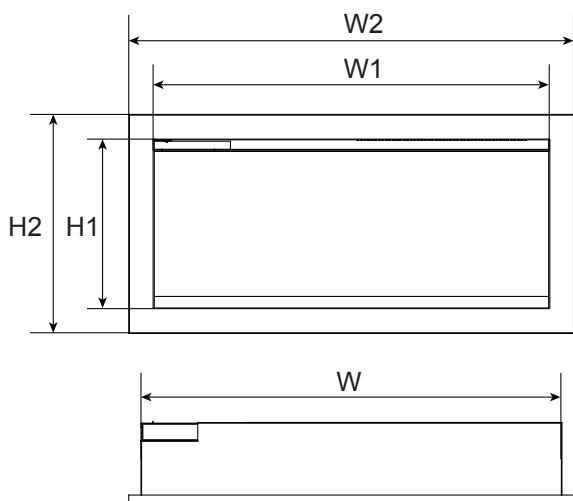

product model	BS1910074-1 (SYM-74-XT BESPOKE)		BS1910088-1 (SYM-88-XT BESPOKE)		BS1910100-1 (SYM-100-XT BESPOKE)	
Voltage	120V AC 60Hz	240V AC 60Hz	120V AC 60Hz	240V AC 60Hz	120V AC 60Hz	240V AC 60Hz
Watts	1500W	3000W	1500W	3000W	1500W	3000W
BTU	5120	10240	5120	10240	5120	10240
Appliance size (W x H x D)	74 1/4" x 20 1/8" x 11 3/4" 188.5 x 51 x 29.7 cm		88 1/4" x 20 1/8" x 11 3/4" 224.1 x 51 x 29.7 cm		100 1/4" x 20 1/8" x 11 3/4" 254.6 x 51 x 29.7 cm	
Glass Viewing (W1 x H1)	72 3/8" x 17 5/8" 184 x 44.6 cm		86 3/8" x 17 5/8" 219.5 x 44.6 cm		98 3/8" x 17 5/8" 250 x 44.6 cm	
Frame size (W2 x H2)	76 1/4" x 21 3/8" 193.7 x 54.4 cm		90 1/4" x 21 3/8" 229.3 x 54.4 cm		102 1/4" x 21 3/8" 259.7 x 54.4 cm	
Wall Opening Size (W3 x H3 x D3)	74 3/4" x 20 1/2" x 12 1/4" 189.9 x 52.3 x 31.1 cm		88 3/4" x 20 1/2" x 12 1/4" 225.4 x 52.3 x 31.1 cm		100 3/4" x 20 1/2" x 12 1/4" 255.9 x 52.3 x 31.1 cm	
Cord Length	L =70.9" L =180 cm					

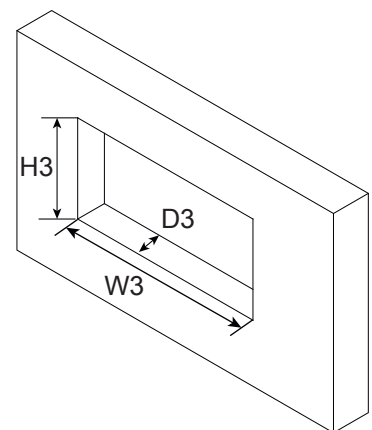
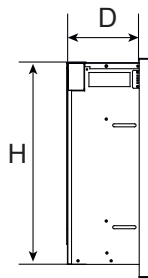
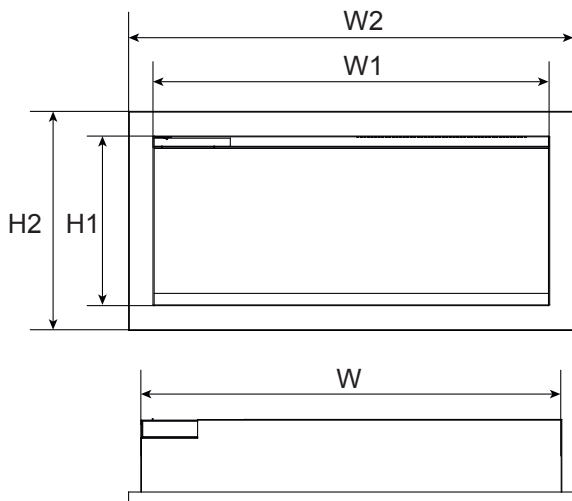

OUTDOOR INSTALLATIONS

The Symmetry Xtra Tall Bespoke Series electric fireplaces are suitable for installation on an inside wall in an outdoor area protected from direct water impingement. In addition to maintaining the listed mantel and combustibles clearances, a rain protection overhang factor of 1/2 shall be constructed to the front and to each side of the installed appliance. See illustration below. All wiring connections to line power shall be in accordance with local building code requirements. Inquires about local codes and regulations must be done prior to installation.

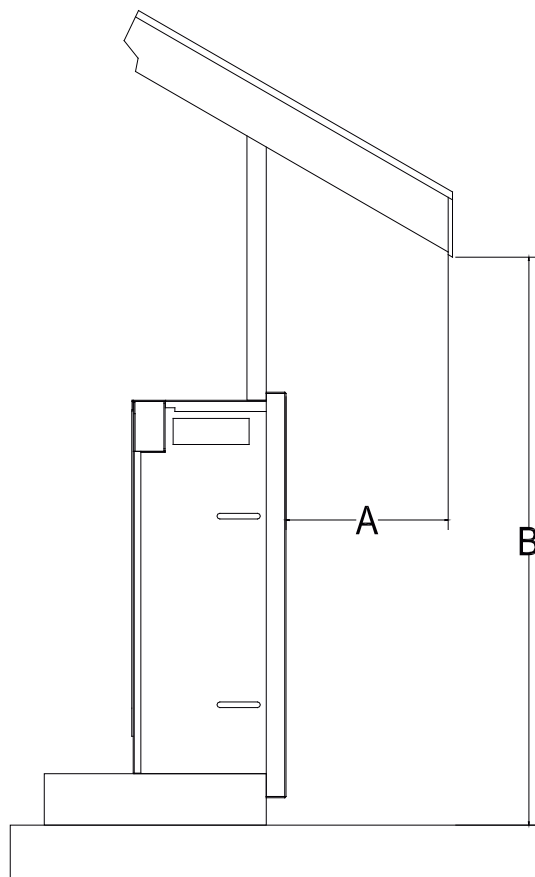

The overhang(A) must extend at least 1/2 the roof-line height. Height is measured from the base of the fireplace.

For example: if the roof-line(B) is 8" above the base of the fireplace, the overhang(A) must be at least 4".

INSTALLATION- BUILT-IN

NOTE: Due to the many different materials used to build walls, it is highly recommended that you consult your local builder before you install this appliance on a wall.

PREPARATION

Select a location that is not prone to moisture and is located at least 0.91m or 3 feet away from combustible materials such as curtains, drapes, furniture, bedding, paper, etc.

2. Mark the desired location on the floor and store the appliance in a safe, dry and dust free place.

3. Prepare a wall with a framed opening to accommodate the size of your unit. Leave at least 1/4" (6mm) around the edge of the appliance. Any new wiring must be done in compliance with local and national codes and other applicable regulations.

Prior to installing, test the appliance to make sure the appliance is fully operational by plugging the power supply cord into a 120 Volt grounded outlet.

THE ROUGH WALL OPENING SIZE OF THE FIREPLACE PLEASE REFER TO THE PRODUCT SPECIFICATION SHEET.

INSTALLATION

1. Unscrew 4 screws on the top, 4 magnets are at the bottom (The quantity varies depending on the size of the unit) and take off the trim. (NOTE: Keep hold of the front glass as it may fall down automatically when the trim is removed.)

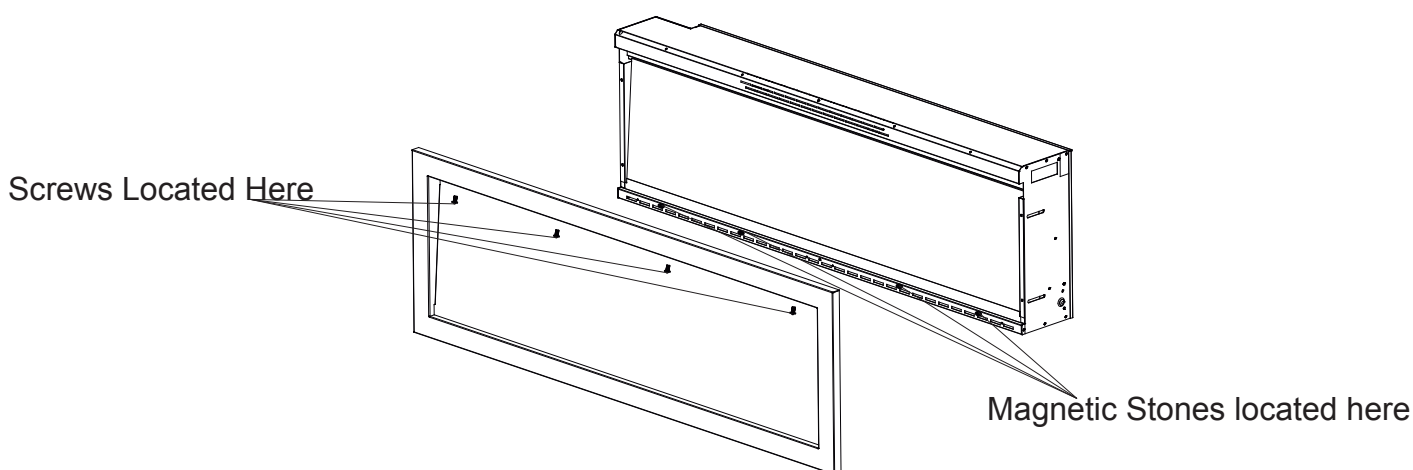

2. Carefully remove the front glass panel once the trim has been removed. Use caution as the glass is now loose.

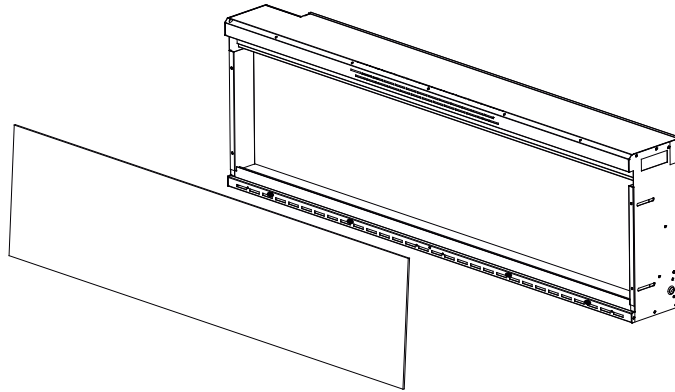

3. Unscrew the 2 screws located on each side and take off the inner side steel panels.

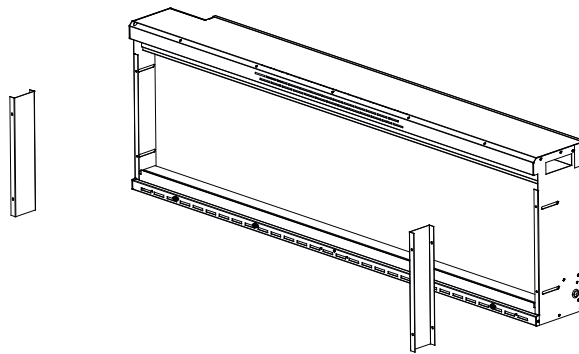

4. Put the trim back onto the appliance and fasten with screws.(NOTE: This step is to make sure that the fireplace fits the wall opening well and there is no gap between the trim and the wall after installation)

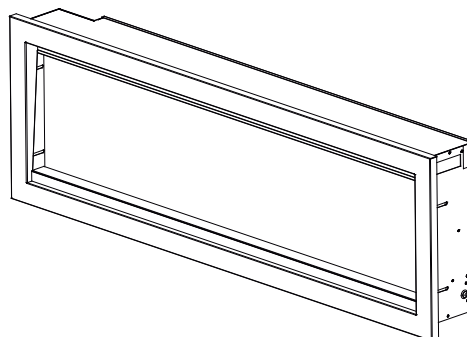

5. Put the fireplace into the wall opening and fix it to the wall by screwing 2 screws each side.

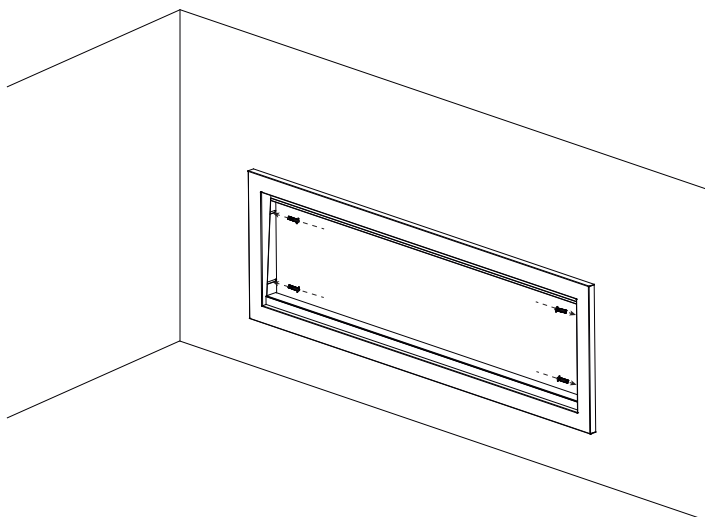

6. Remove the trim following STEP 1. Screw back the inner side steel panels.

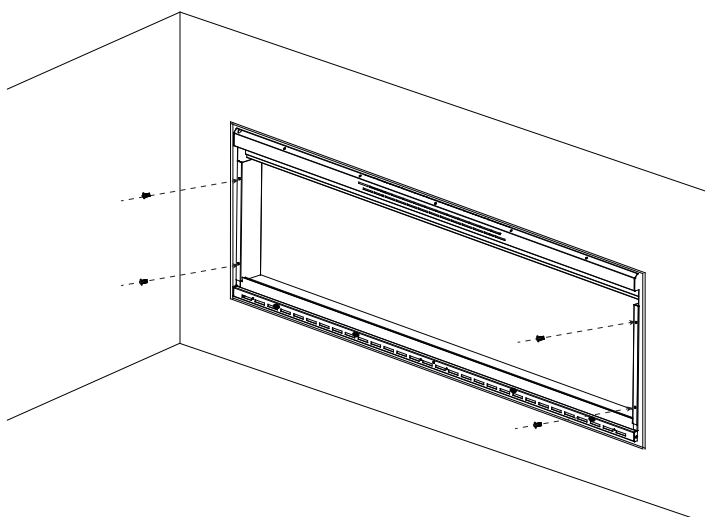

7. Insert the front glass panel back in place after the media installation has been completed.

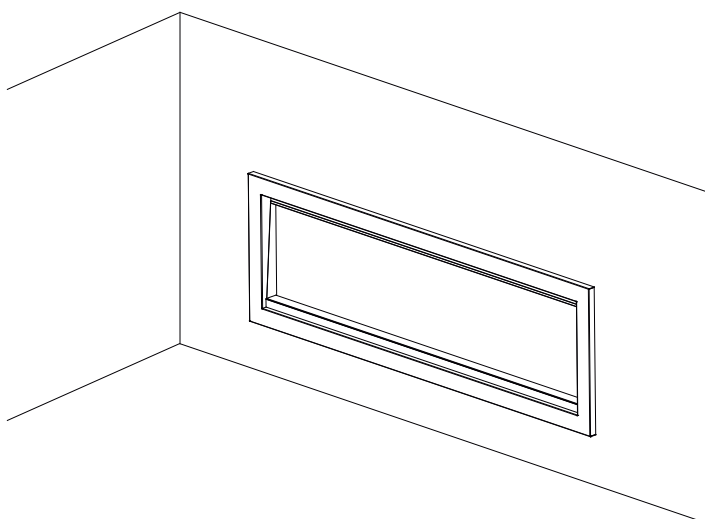

HARDWIRE INSTALLATION

Turn off the appliance completely and let cool before servicing. Only a qualified service person should service and repair this electric appliance.

If it is necessary to hardwire this appliance, a qualified electrician must remove the cord connection, and wire the appliance directly to the house hold wiring.

This appliance must be electrically connected and grounded in accordance with local codes, if hardwired. In the absence of local codes, use the current CSA C22.1 CANADIAN ELECTRICAL CODE in Canada or the current ANSI/NFPA 70 NATIONAL ELECTRICAL CODE in the United States.

This appliance has two types of hardwired. Connect to 120V or 240V.

Connect to 120V

1. Test the unit before removing the cord.

Remove the cover plate from the back top right corner of the appliance by removing the four screws, as shown below. Unscrew and remove power cord.

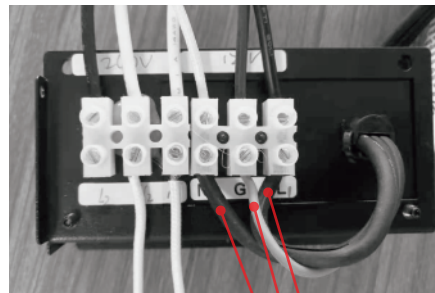

Disconnect the N G L

2. Attach the wiring to the junction block. Please make sure the live wire goes into the “L1”, the neutral wire into “N” and the ground wire into “G”.

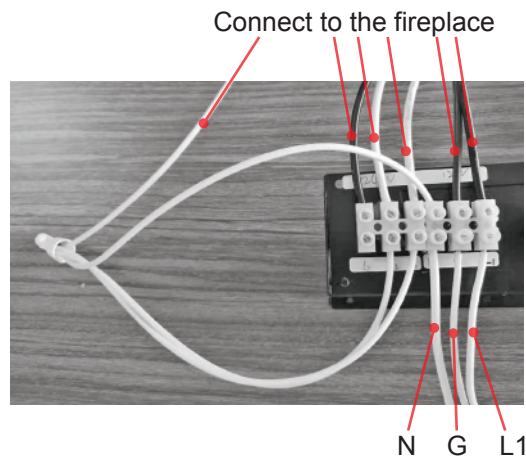

3. Return the cover plate to the back top right corner and screw the four screws back in to fasten the plate.



Connect to 240V

1. Test the unit before removing the cord.

Remove the cover plate from the back top right corner of the appliance by removing the four screws, as shown below. Unscrew and remove power cord.

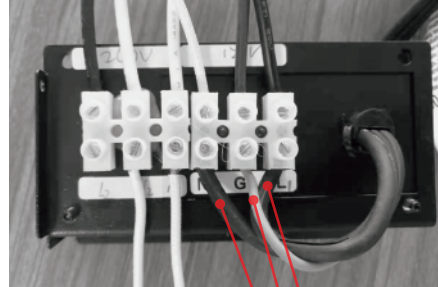

Disconnect the N G L

2. Attach the wiring to the junction block. Please make sure the live wire goes into the “L1” and “L2” (as shown below), the neutral wire into “N” and the ground wire into “G”. Tighten the N1 and N2 with two screw caps.

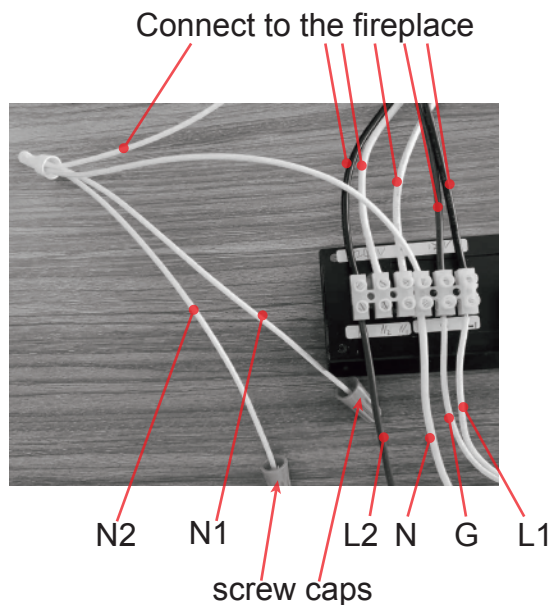

3. Return the cover plate to the back top right corner and screw the four screws back in to fasten the plate.



DECORATIVE MEDIA INSTALLATION

Consumers may purchase optional decorative media if they choose. See dealer for more details.

1. Unscrew 4 screws the quantity varies depending on the size of the unit and take off the trim. (NOTE: Keep hold of the front glass as it may fall down automatically when the trim is removed.)

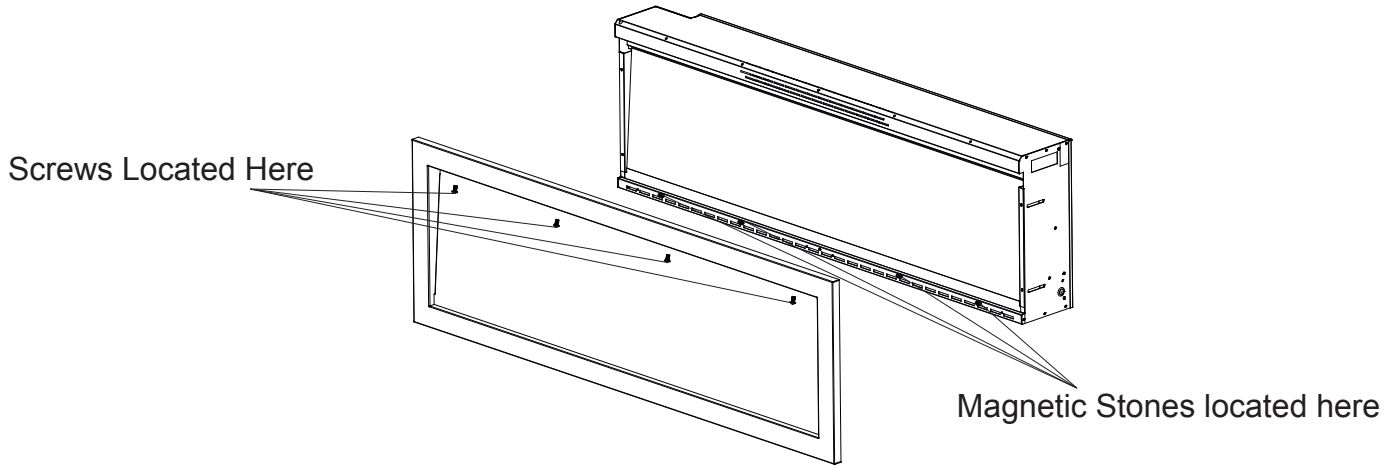

2. Carefully remove the front glass panel once the trim has been removed. Use caution as the glass is now loose.

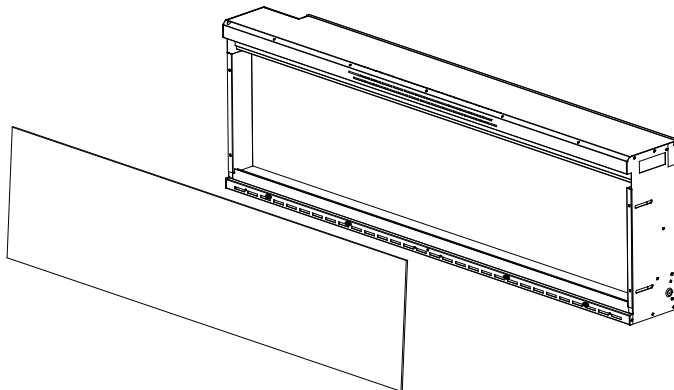

3. Pour the media into the tray. Feel free to use any combination of the fire glass media that you find most appealing. Insert the front glass panel back in place after the media installation has been completed.

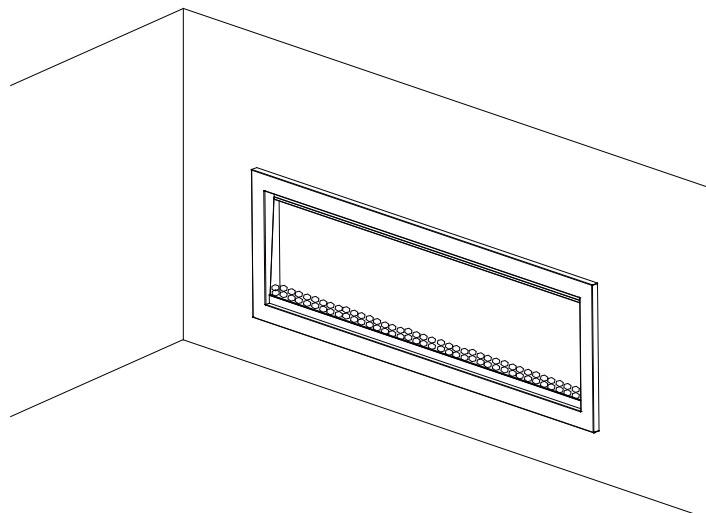

MANUAL OPERATION

The fireplace operates either by the touch panel located on the left front top side of the fireplace or by supplied remote control.

Ensure that the ON / OFF Power Switch on the fireplace is in the ON position.

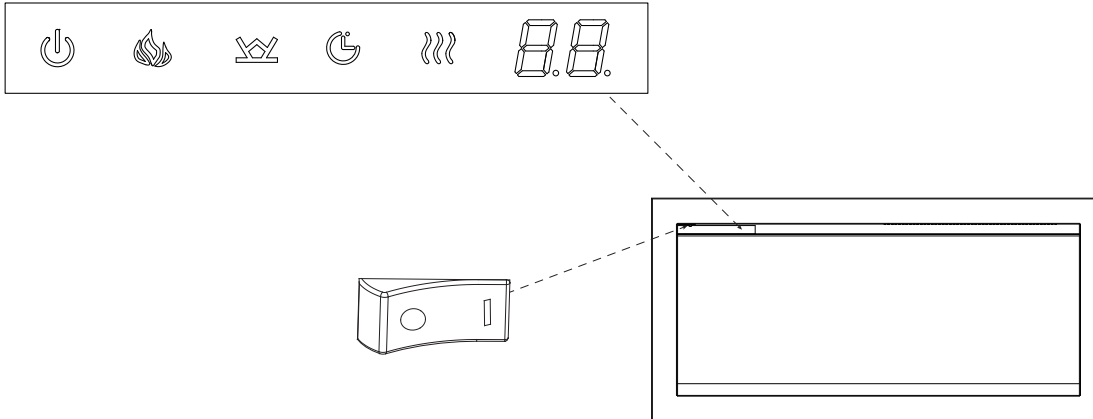



Touch the control panel once to “wakes up” the controls. This will cause the controls to light up. At this time, you can press the power button to turn on fireplace

1. Press “  ” to turn on and off the fireplace.

2. Press “  ” to adjust the flame brightness. There are 6 brightness levels (L6-L1) and an off(OFF) position. Each time the flame button is pressed, the brightness of the flame decrease.

Press the flame button more than 5 seconds, the timer indicator light on and will rapidly blinks, at this time, you can use the TuyaSmart APP to connect to the fireplace.

3. Press “  ” to adjust the ember bed brightness. There are 7 brightness levels (d8-d2), dynamic condition(d1) ,and the OFF(OFF) setting you can cycle through. Each time the ember bed button is pressed, the brightness of the ember bed decrease.

4. Press “  ” for the first time to display the current timing, press the button again to clear the current timing. If the timing in off position, the second press will show 30. Multiple times to set operating duration to OF, 30 min, 1h, 2h, 3h, 4h, 5h, 6h, 7h, 8h.

Press and hold the “  ” for 5 seconds to turn on the sound.

5. Press “  ” for the first time to display the current setting temperature, press the button again to clear the current temperature. If the heater in off position, the second press will show 22°C (72°F). Multiple times to set ambient temperatures at 22°C (72°F), 23°C (74°F), 24°C (76°F), 25°C (78°F), 26°C (80°F), 27°C (82°F), 28°C (83°F), 15°C (59°F), 16°C (60°F), 17°C (62°F), 18°C (64°F), 19°C (66°F), 20°C (68°F), 21°C (70°F).

Temperature unit convert function: When the heater is on, press and hold the “  ” Button for 5 seconds, current temperature unit display will convert to another temperature unit.











NOTE:The heater is turned on by switching on the fan first, then after 5 seconds the heating coil. The heater is turned off by switching off the heating coil first, then after 30 seconds the fan.

REMOTE CONTROL OPERATION









For the remote to function make sure the fireplace is plugged in and the ON / OFF Power Switch on the fireplace is in the ON position and the remote has batteries.

Important: When operating the remote make sure you point the remote to the center of the fireplace. Each time you press the button, there will be a beep tone emitted.

Setting the current time of the remote control

You must press the  key to open the remote control and press the  key to enter the setting current time state. When one of the “Sun” “Mon” “Tue” “Wed” “Thu” “Fri” “Sat” date is flashing, you can press the  or  key to select the current day of the week, and press the  key to confirm and enter hour setting. When the digital tube of time hour flashes, press the  or  key to set the current time and press the  key to confirm and enter minute setting. When the digital tube of time minute flashes, press the  or  key to set the current time and press the  key to confirm.





-  This Power Button turns the fireplace on and off. It has a memory function, press the power button once to turn power on. Pressing the power button again will turn the power off.
-  The Timer Button has adjustable setting at range from 30 minutes to 8 hours. As shown the following: 0:30- 1:00- 1:30- 2:00- 2:30- 3:00- 3:30- 4:00- 4:30- 5:00- 5:30- 6:00- 6:30- 7:00- 7 :30- 8:00. Once you have set the timer, The  icon will be displayed on the LCD screen of the remote control. Press this button again, cancel the timing setting, and the  icon disappears.
When the timer is up, it will close all the functions and enter standby mode. In this mode, you should touch the power icon to restart the appliance.
-  Each time the Heater Button is pressed, the power of the heater will change. As shown the following: H1- H2- AUTO(22°C)- OFF(no display).
H1 means the fireplace on Low Heat.
H2 means the fireplace on High Heat.
AUTO means fireplace can automatically adjust to the temperature you set. When in AUTO, you can set the desired temperature with  or  keys. You can switch temperature unit between Celsius and Fahrenheit with  or  keys.







Each time Speed Button is pressed, the speed of the flame will change. Three options are available: Medium- High- Low.





The Moodlight Button turns the moodlight on and off. When in on position, the display screen of the remote control shows AD 1, when the number “1” flash, you can set the color of moodlight with  or  keys. There are 10 different moodlight colors(AD1-10) and dynamic condition(AD11) to choose from.





The Ember Bed Button turns the Ember bed light on and off. When in on position, the display screen of the remote control default shows 8 8 8. You can press  or  or  keys to change the corresponding color.

 Each time the Red Button is pressed the brightness of the red color decrease. There are 7 brightness levels (8-2), dynamic level(1) and OFF (no display) settings that can be cycled through. When no number is displayed on the remote control LCD screen then the ember bed color is off.

 Each time the Green Button is pressed the brightness of the green color decrease. There are 7 brightness levels (8-2), dynamic level(1) and OFF (no display) settings that can be cycled through. When no number is displayed on the remote control LCD screen then the ember bed color is off.

 Each time the Blue Button is pressed the brightness of the blue color decrease. There are 7 brightness levels (8-2), dynamic level(1) and OFF (no display) settings that can be cycled through. When no number is displayed on the remote control LCD screen then the ember bed color is off.



The Flame Button turns the Flame on and off. When in on position, the LCD screen of the remote control default shows 6 6 6. You can press  or  or  key to change the corresponding color.











 Each time the Red Button is pressed the brightness of the red color decrease. There are 6 brightness levels (6-1) and OFF (no display) settings that can be cycled through. When no number is displayed on the remote control LCD screen then the flame color is off.



 Each time the Orange Button is pressed the brightness of the orange color decrease. There are 6 brightness levels (6-1) and OFF (no display) settings that can be cycled through. When no number is displayed on the remote control LCD screen then the flame color is off.

 Each time the Yellow Button is pressed the brightness of the yellow color decrease. There are 6 brightness levels (6-1) and OFF (no display) settings that can be cycled through. When no number is displayed on the remote control LCD screen then the flame color is off.





7 day timer function

NOTE: Ensure that the current time setting accurate, otherwise the effective time of the 7 day timer function will be different from what you set.

Press the  key once, 7 days from Monday to Sunday will display on the LCD screen of the remote control, press  key within 5 seconds to enter 7 day timer function . When “Sun” is flashing use the  or  key to select the day that you want to set, pressing the  key to confirm. Then “ON” will be displayed on the LCD screen of the remote control, at the same time, the hour on the digital clock flashes, press the  or  key to set the hour and then the minute you want the fireplace to turn on. After setting the start up time, “OFF” will be displayed on the LCD screen. Use the  or  key to set the shutdown time the same as setting the start up time. After setting the shutdown time, “AUTO” will be displayed on the LCD screen of the remote control. The digital temperature flashes, at this time you can set the desired temperature with  or  keys. The fireplace will beep to acknowledge the settings. Now, the 7 day function has been set, the fireplace will save the setting and run automatically.

When the 7 day timer is set, the icon  will be displayed on the LCD screen of the remote control. Press the  key again to cancel the 7 day timer function, the  will disappear.

NOTE: If the 7 day timing and general timing exist at the same time, the shutdown time shall be the earlier time. For example, it is now 6 am on Tuesday, turning on the heaters general timer for 4 hours, will have the shutdown time of 10 am. The previous 7 day shutdown time is 8 am on Tuesday, so today's heater shutdown time is 8 am instead of 10 am.

 The Refer Button queries the 7-day timer setting. This will not turn on the timer function but will only show the previous setting. Press the  or  key to query the day of the week. Press the  or  key to query the start up and shutdown time.

Press  key once to enter the query mode, press the  key again to exit query mode.

 This button turns the fire crackling sound on and off.

TROUBLE SHOOTING

Fault code	Fault Cause	Solution
E1	The heater overheating	Call after-sales service.
E2	NTC is defective.	Call after-sales service.
E3	The heater not working.	If the vents are dirty or clogged. Unplug the power, clean the dust and debris of the vent area. Wait for 5 minutes, plug in and turn on the heater. If the heater still don't work, please call after-sales service.

Each time the heater button is pressed in the E1 state, one beep tone will be given.

Each time the heater button is pressed in the E2 state, two beeps tone will be given.

Each time the heater button is pressed in the E3 state, three beeps tone will be given.

REPLACEMENT PARTS

NO.	DESCRIPTION	PART NUMBER				
		BS1910050-1 (SYM-50-XT BESPOKE)	BS1910060-1 (SYM-60-XT BESPOKE)	BS1910074-1 (SYM-74-XT BESPOKE)	BS1910088-1 (SYM-88-XT BESPOKE)	BS1910100-1 (SYM-100-XT BESPOKE)
1	LED STRIP FOR EMBER BED	3000181230001859-50XT	3000181230001859-60XT	3000181230001859-74XT		
2	LED STRIP FOR FLAME	30002056-50XT	30002059-60XT	30002056-74XT		
3	FRONT GLASS	60000231	60000234	60000237		
4	EMBER BED GLASS	60000233	60000236	60000239		
5	FLAME EFFECT GLASS	60000232	60000235	60000238		
6	LED STRIP FOR TOP LIGHT	30002170-50XT	30002171-60XT	30002170-74XT		
7	FRAME	10002536P	10002550P	10002562P		
8	PCB BOARD	30001984				
9	MOTOR	30001868				
10	AC ADAPTER	30001978				
11	BLOWER AND HEATER ASSEMBLY	3000200630002007				
12	BLUETOOTH SPEAKER SET (POWER PCB + SPEAKER PCB + SPEAKER)	300021183000211930002120				
13	SPEAKER SET (SPEAKER + SPEAKER PCB)	3000203230002057				
14	REMOTE (R1)	10105070				

EXPLODED VIEW

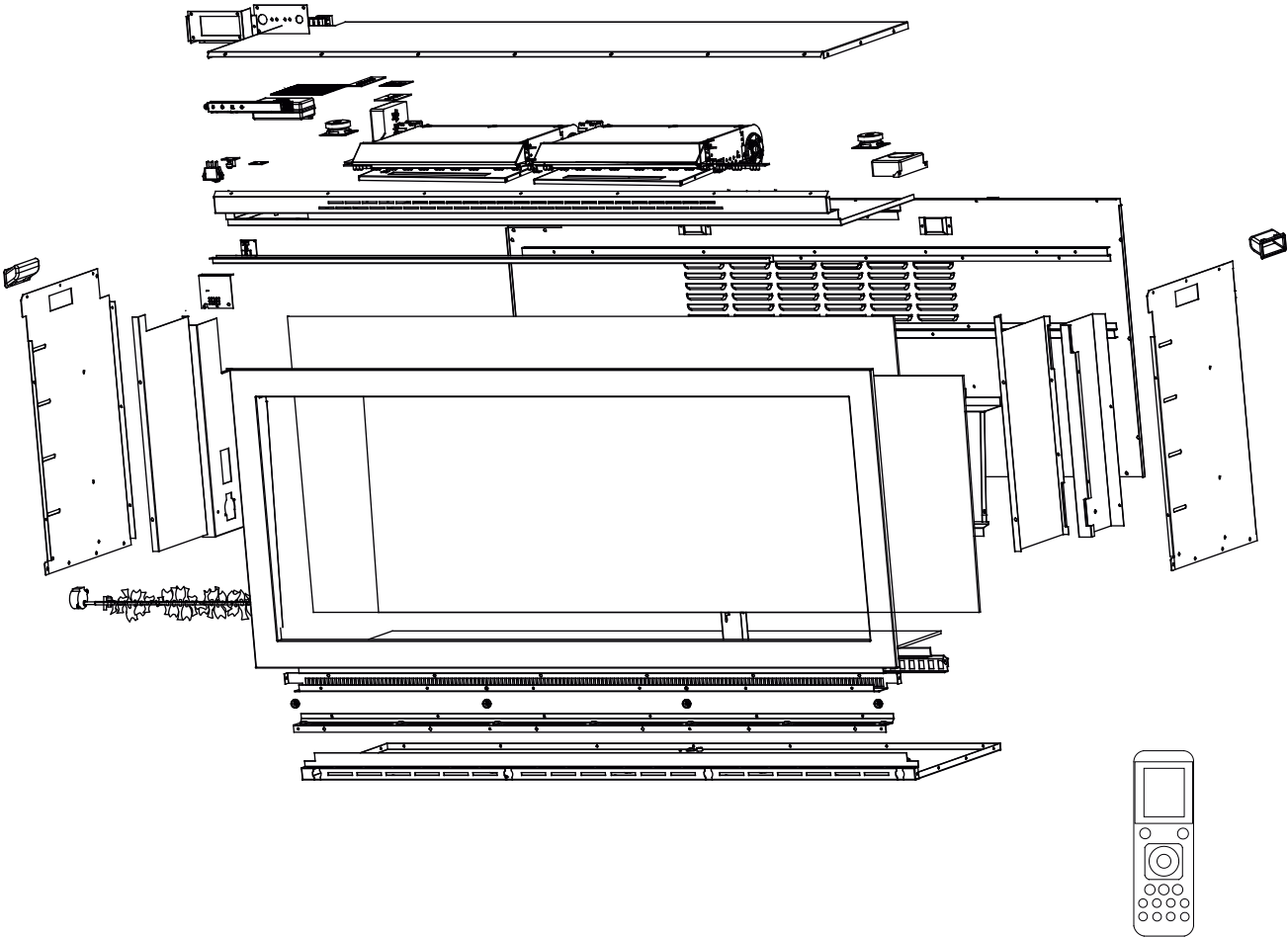

ELECTRIC FIREPLACE WARRANTY

FOR PRODUCTS MANUFACTURED AFTER JANUARY 1, 2016



Amantii Imports Corp. ("Amantii") warrants that your newly purchased Amantii electric fireplace is free from manufacturing and material defects for a period of two (2) years from the date of the first purchase, subject to the conditions and limitations contained below.

WARRANTY APPLICATION & EXCLUSIONS

This limited warranty applies to your newly purchased Amantii electric fireplace; the limited warranty's application is limited to purchases made in any province of Canada or in any of the 52 States of the United States of America, including the District of Columbia. Only the original purchaser of the product is eligible for coverage under this limited warranty; the warranty is not transferable.

PRODUCTS EXCLUDED FROM THIS LIMITED WARRANTY

Light bulbs are not covered by this limited warranty and are the sole responsibility of the owner/purchaser.

WARRANTY COVERAGE AND TERM

Products covered by this limited warranty have been tested and inspected prior to shipment and, subject to the provisions of this warranty, Amantii warrants such products to be free from defects in material and workmanship for a period of two (2) years from the date of the first purchase of such products.

The limited two (2) year warranty period for products also applies to any implied warranties that may exist under applicable law. Some jurisdictions do not allow limitations on how long an implied warranty lasts, so the above limitation may not apply to the purchaser.

All other warranties—expressed or implied—with respect to the product, its components and accessories or any obligation/liabilities on the part of Amantii are hereby expressly excluded.

WARRANTY COVERAGE AND TERM - BESPOKE SERIES

Products covered by this limited warranty have been tested and inspected prior to shipment and, subject to the provisions of this warranty, Amantii warrants such products to be free from defects in material and workmanship for a period of five (5) years from the date of the first purchase of such products.

The limited five (5) year warranty period for products also applies to any implied warranties that may exist under applicable law. Some jurisdictions do not allow limitations on how long an implied warranty lasts, so the above limitation may not apply to the purchaser.

All other warranties—expressed or implied—with respect to the product, its components and accessories or any obligation/liabilities on the part of Amantii are hereby expressly excluded.

LIMITATIONS TO COVERAGE UNDER LIMITED WARRANTY

This limited warranty does not apply to products that have been repaired, except by Amantii or its authorized service representatives, or otherwise altered. This limited warranty further does not apply to defects resulting from misuse, abuse, accident, neglect, incorrect installation, improper maintenance or handling, or operation with an incorrect power source. Products made by other manufacturers, sold with the product or thereafter, are not covered by this limited warranty. The use of unauthorized components will render this warranty null and void.

PANORAMA OUTDOOR UNITS

All Panorama units that are installed outdoors or in moisture intense conditions must use the stainless steel cover. Proof of purchase of the cover is required for any warranty claims.

SERVICE UNDER LIMITED WARRANTY

Defects must be brought to the attention of Amantii Technical Support by contacting Amantii at (1.877.850.9458), or at 502-1027 Davie Street, Vancouver, BC V6E 4L2. Please have your proof of purchase, catalogue/model and serial numbers available when calling; any and all service under the limited warranty requires a proof of purchase of the product.

DEFECTS

Should a product or part covered by this limited warranty be proven to be defective, in material or workmanship, and during the two (2) year limited warranty period, Amantii will replace such defective product or part without charge. If Amantii is unable to replace such product, or if replacement is not commercially practicable or cannot be timely done, in its sole discretion Amantii may, in lieu of replacement, choose to refund the purchase price for such product or part.

ELECTRIC FIREPLACE WARRANTY

FOR PRODUCTS MANUFACTURED AFTER JANUARY 1, 2016

APPLICATION OF PROVINCIAL AND STATE LAW

This limited warranty gives you specific legal rights, and you may also have other rights which vary from jurisdiction to jurisdiction. The provisions of the United Nations Convention on Contracts for the Sale of Goods shall not apply to this limited warranty or the sale of products covered by this limited warranty.

GENERAL

Amantii reserves the right to make changes at any time without notice, in design, material, specifications, prices and the right to discontinue styles and products.

GLASS

This limited warranty does not apply to the following glass products:

Model Type	Tray Glass	Front Glass	Back Glass
Panorama /Symmetry	✓	✓	✓
Wall Mount/ Insert	✓		
Traditional	✓		
Zero Clearance/ FS	✓		
Freestand	✓		

EXCLUSION OF BATTERIES

Ocean carriers have set new rules designed to protect the safety of shipments while in transit. This new rule disallows the inclusion of lithium/alkaline batteries, as a result we will no longer be including batteries with the fireplace remote.

REPLACEMENT MOTORS

With the reliability of the components used in the construction of our electric fireplaces, a complimentary replacement motor will no longer be included inside the carton containing the fireplace.