



HANDRAILING SYSTEMS

VERSATILE AND DURABLE



TABLE OF CONTENTS

GALVANISED HANDRAILS	4
Introduction	6
Application Guidelines	7
Fixed Fittings.....	8
Swivel Fittings	16
Fixings & Ancillaries	18
DDA Range.....	25
Roof Edge Protection	28
Sizing Charts	30
Ball Standards	32
EASIRAIL	34
Introduction	36
Service.....	37
Product Specification	38
Step Kits.....	39
Wall Brackets	40
Posts And Connectors	41
Ancillaries	42
Best Practice Installation Guide.....	44
ABOUT FLOCON	46

DISCLAIMER

Although every effort is made to ensure the information in this brochure is correct at the time of printing, no responsibility can be accepted for any errors or omissions. The information provided is only to be used as a guide, no responsibility will be accepted for any errors or changes in dimensions from our suppliers. For full technical advice, please contact our sales office on: 01443 841 666.





GALVANISED **HANDRAIL**

INTRODUCTION

THE **SAFE CLAMPING SYSTEM** FOR CIRCULAR HOLLOW SECTION TUBE

Flocon has a range of fittings manufactured from Malleable Iron to BS EN 1562 or Ductile Iron (where noted in the fittings description) to BS EN 1563 .

These fittings are used to construct lightweight tubular steel structures and are manufactured to suit five different tube sizes.

Flocon Handrail fittings require no welding, drilling or special tools, simply use a hexagon key to tighten the special setscrews that embed into the tube. The fittings will support an axial load of up to 900 kg when tightened to a torque of 39Nm.

FINISHES AVAILABLE

The castings are Hot dip Galvanised to BS EN ISO 1461 as standard. These fittings can also be supplied in black or powder coated finishes to RAL standard colours, subject to quantity and availability from the coaters.

SIZING

Flocon fittings are suitable for use with steel tubes to BS EN 10255 with a minimum wall thickness of 3.2mm, however please note that internal fitting types: C01, C06, C65, DDA-02 & DDA-06 are only designed for use with 3.2mm thick tube.

Fitting	Tube Size \varnothing	Nominal bore of tube	
		Metric	Imperial
20	26.9mm	20	3/4"
25	33.7mm	25	1"
32	42.4mm	32	1 1/4"
40	48.3mm	40	1 1/2"
50	60.3mm	50	2"

Important Note: The Tube Size \varnothing should be the first consideration as this is the primary structural component for any handrail structure. The application guidelines on the next page will help the design of Racking, General Structures and Handrail.

CUTTING SERVICE

TIME IS MONEY – OPT FOR A PROFESSIONAL CUTTING SERVICE.

Optimise time on a job and irradiate the use of cutting tools on site. At Flocon, we're able to cut our galvanised handrail to your specific measurements and requirements using our automated bandsaw.

Whether your handrail project is an extensive, complicated installation, or a small, one-off job, we are able to cut a mere length of rail or custom saw rail to your bespoke measurements. Our saws cut to a tolerance of -0 to +3mm.

20

\varnothing 26.9mm

25

\varnothing 33.7mm

32

\varnothing 42.4mm

40

\varnothing 48.3mm

50

\varnothing 60.3mm

RACKING AND GENERAL STRUCTURES

Racking and general structures can be constructed using Flocon fittings. Care must be taken to ensure that the tube size selected is adequate for the loads anticipated. To help with the selection of the correct tube, table 1 provides the uniformly distributed loads that can be supported between upright posts, assuming that the load is supported by two tubes. These loads are calculated based on the maximum bending moment for the tube.

Table 2 provides the load capacity for single upright posts with various unsupported lengths. These loads are based on the compression strength and buckling loads of the circular hollow section (CHS) tube.

NB. When designing structures care must be taken to ensure that the load on any one grub screw does not exceed 900kg.

TABLE 1: Horizontal tubes load capacity

Uniformly distributed load in kg using two horizontal tubes

SPAN (M)	TUBE Ø				
	26.9mm x 2.6	33.7mm x 3.2	42.4mm x 3.2	48.3mm x 3.2	60.3mm x 3.6
0.5	540	1060	1750	2380	4000
0.6	435	850	1407	1870	3250
0.7	375	730	1207	1595	2760
0.8	330	645	1063	1385	2420
0.9	295	579	946	1230	2160
1.0	265	525	850	1110	1950
1.1	240	478	770	1013	1775
1.2	219	438	705	930	1625
1.3	202	403	651	858	1497
1.4	187	373	604	796	1387
1.5	175	347	564	741	1290
1.6	-	325	529	693	1205
1.7	-	306	499	650	1129
1.8	-	290	472	613	1061
1.9	-	277	448	581	999
2.0	-	268	427	553	987
2.1	-	-	408	528	944
2.2	-	-	391	505	855
2.3	-	-	376	485	818
2.4	-	-	362	467	785
2.5	-	-	349	450	755
2.6	-	-	-	434	728
2.7	-	-	-	419	703
2.8	-	-	-	405	680
2.9	-	-	-	-	659
3.0	-	-	-	-	639
3.1	-	-	-	-	620
3.2	-	-	-	-	603
3.3	-	-	-	-	588
3.4	-	-	-	-	575
3.5	-	-	-	-	564

Grade: BS EN 10255 (ISO 65)

TABLE 2: Vertical load capacity

Vertical load in kg per strut

LENGTH (m)	TUBE Ø				
	26.9mm x 2.6	33.7mm x 3.2	42.4mm x 3.2	48.3mm x 3.2	60.3mm x 3.6
0.3	1720	2950	4038	4783	7044
0.4	1435	2617	3703	4446	6661
0.5	1150	2284	3368	4109	6278
0.6	910	1951	3033	3772	5895
0.7	725	1618	2690	3435	5512
0.8	590	1348	2363	3098	5129
0.9	480	1128	2028	2761	4746
1.0	-	948	1752	2424	4363
1.1	-	798	1524	2134	3980
1.2	-	-	1340	1884	3597
1.3	-	-	1188	1668	3253
1.4	-	-	1066	1484	2951
1.5	-	-	-	1328	2681
1.6	-	-	-	-	2441
1.7	-	-	-	-	2226
1.8	-	-	-	-	2032
1.9	-	-	-	-	1857
2.0	-	-	-	-	1697

Grade: BS EN 10255 (ISO 65)

Guardrail

Guardrail is the most common form of structure that is built with these fittings and requires careful consideration to meet required design loadings. Design loads are usually specified, however if unsure BS 6399 and BS 6180:2011 are good reference documents.

The loading capacity of any guardrail structure is determined principally by the diameter, thickness and frequency of its Uprights. The table below contains our recommendations to safely meet the stated design loads based on the maximum permissible bending moment of the Upright tube.

TABLE 3

LENGTH (m)	TUBE Ø				
	33.7 x 3.2mm	42.4 x 3.2mm	42.4 x 4.0mm	48.3 x 3.2mm	48.3 x 4.0mm
Design Load	Maximum upright centres (mm)				
900mm high					
360 N/m	814	1369	1595	1828	2584
740 N/m	396	666	776	889	1257
1500 N/m	195	329	383	439	620
1000mm high					
360 N/m	732	1232	1435	1645	2326
740 N/m	356	599	698	800	1131
1500 N/m	176	296	345	395	558
1100mm high					
360 N/m	666	1120	1305	1496	2114
740 N/m	324	545	635	728	1028
1500 N/m	160	269	313	359	507

Grade: BS EN 10255 (ISO 65)
Rails need only be 3.2mm thick and the same diameter as the Upright.

FIXED FITTINGS

CA03.136 Add On Short Tee

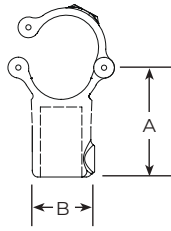

The Add On short Tee allows existing structures to be added to without the need for any dismantling. Tubes must not be jointed within this fitting.

Type	Tube size	A	B	Kg
16.136.032.000	42.4	60	55	0.60
16.136.040.000	48.3	68	60	0.71

CA40.161 Add On 90° Crossover

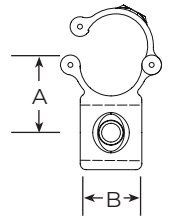

The Add On 90° Crossover allows existing structures to be added to without the need for any dismantling. This fitting is designed to give a 90° offset crossover joint.

Tubes must not be joined within this fitting.

Type	Tube size	A	B	Kg
Sold as special	42.4	49	46	0.65
Sold as special	48.3	55	50	0.73

C00.149 Sleeve Joint

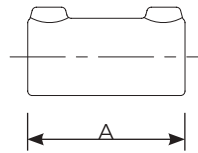

The Sleeve Joint is designed to provide an in-line joint between two tubes of the same diameter.

Type	Tube size	A	Kg
16.149.020.000	26.9	76	0.33
16.149.025.000	33.7	89	0.39
16.149.032.000	42.4	102	0.50
16.149.040.000	48.3	100	0.55
16.149.050.000	60.3	120	1.14

C01.150 Expanding Connector

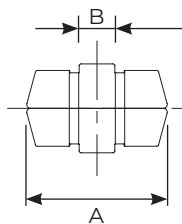

The expanding connector is designed to provide an in line joint between tubes of the same diameter, and a wall thickness of 3.2mm. It fits flush with the tube surface and can be located inside other fittings.



WARNING!

Inline internal connector for joining two tubes together. Only medium gauge 3.2mm wall thick tube can be used. The 150 should never be used as a load bearing joint. The 150 must be used within 100mm of an upright.

Type	Tube size	A	B	Kg
16.150.025.000	33.7	75	19	0.18
16.150.032.000	42.4	75	19	0.27
16.150.040.000	48.3	75	19	0.35

C02.125 90° Elbow

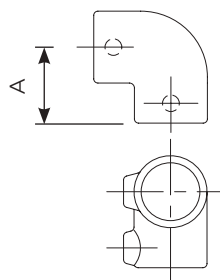

The 90° Elbow is designed to provide a joint between two tubes at right angles to each other. Often used for railing ends and corners.

Type	Tube size	A	Kg
16.125.020.000	26.9	40	0.24
16.125.025.000	33.7	48	0.39
16.125.032.000	42.4	60	0.53
16.125.040.000	48.3	67	0.68
16.125.050.000	60.3	86	1.53

C03.101 Short Tee

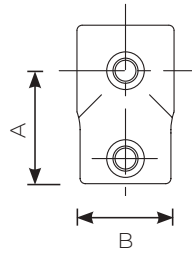

The Short Tee is designed to provide a butt joint between two tubes at right angles to each other. Often used for railing ends and tops. If tubes need to be joined inside the fitting then a C04G type should be used.

Type	Tube size	A	B	Kg
16.101.020.000	26.9	40	38	0.21
16.101.025.000	33.7	48	45	0.35
16.101.032.000	42.4	60	54	0.44
16.101.040.000	48.3	67	60	0.56
16.101.050.000	60.3	86	71	0.76

C04.104 Long Tee

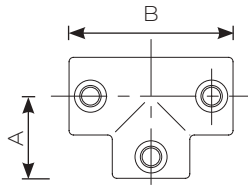

The Long Tee is designed to provide a butt joint between two tubes at right angles to each other. Often used for railing ends and tops. It allows the through tube to be joined inside the fitting. An alternative is the C03G type fitting.

Type	Tube size	A	B	Kg
16.104.020.000	26.9	40	80	0.35
16.104.025.000	33.7	48	96	0.52
16.104.032.000	42.4	60	122	0.77
16.104.040.000	48.3	67	134	0.88
16.104.050.000	60.3	86	172	1.33

C05.104 Variable Elbow (15° to 60°)

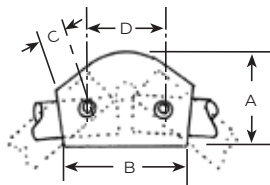

The Variable Elbow is designed to make joints at an angle of between 15° and 60°.

Type	Tube size	A	B	C	D	Kg
16.124.025.000	33.7	65	60	13	50	0.43
16.124.032.000	42.4	80	66	16	55	0.66
16.124.040.000	48.3	95	75	17	55	0.91

C05A.124 Variable Elbow (11° to 30°)

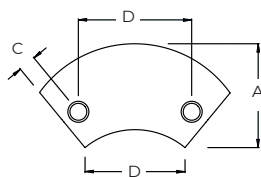

The variable elbow is designed to make joints at an angle of between 11° & 30°.

Type	Tube size	A	B	C	D	Kg
16.A124.032.000	42.4	84	84	16	92	0.82
16.A124.040.000	48.3	94	94	16	102	1.01

C06.147 Internal T Joint

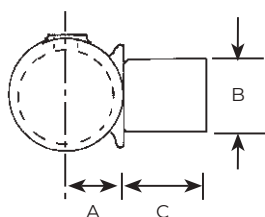

The Internal T joint is designed to provide an angled joint between a tube and a Flocon fitting when used in conjunction with C02G and C03G type fittings. Often used for railing tops and midrails to accommodate a slope as offset railing.

Type	Tube size	A	B	C	Kg
16.147.025.000	33.7	23	33	34	0.33
16.147.032.000	42.4	29	42	40	0.54
16.147.040.000	48.3	31	48	44	0.68

FIXED FITTINGS

C07.184 45° Tee

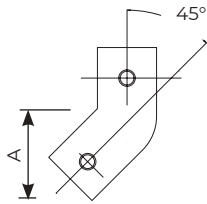

The 45° Tee is used as a bracing and strut component for strengthening structures.

Type	Tube size	A	Kg
16.C07.025.000	33.7	45	0.38
16.C07.032.000	42.4	54	0.63
16.C07.040.000	48.3	60	0.83

C20.128 Three Way 90° Elbow

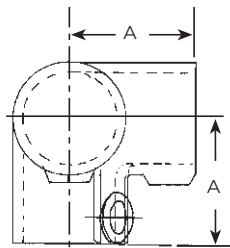

The 3 way 90° Elbow is designed to provide a neat corner for the upper rail of guardrail or frames.

Type	Tube size	A	Kg
16.128.020.000	26.9	40	0.37
16.128.025.000	33.7	48	0.51
16.128.032.000	42.4	60	0.81
16.128.040.000	48.3	67	0.97
16.128.050.000	60.3	84	1.82

C21.116 Three Way through

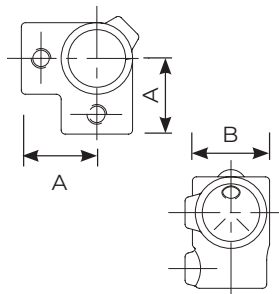

The Corner Complete with through tube is designed to provide a 90° corner for the intermediate rail of guardrail or frames.

Type	Tube size	A	B	Kg
16.116.020.000	26.9	40	38	0.21
16.116.025.000	33.7	48	45	0.39
16.116.032.000	42.4	60	54	0.58
16.116.040.000	48.3	67	60	0.69
16.116.050.000	60.3	86	71	1.1

C22.119 Two Socket Cross

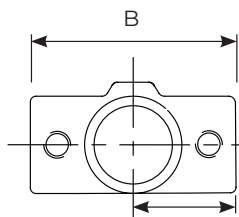

The Two Socket Cross fitting provides the midrail joint for handrail and other structures. It is recommended that the handrail post is continuous through the fitting.

Type	Tube size	A	B	Kg
16.119.020.000	26.9	40	80	0.28
16.119.025.000	33.7	48	95	0.39
16.119.032.000	42.4	60	120	0.57
16.119.040.000	48.3	67	134	0.65
16.119.050.000	60.3	86	172	1.26

C23.176 Side Outlet Tee

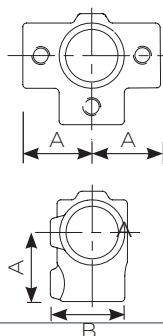

The Side Outlet Tee fitting provides a three way midrail joint for handrail and other structures. It is recommended that the handrail post is continuous through the fitting.

Type	Tube size	A	B	Kg
16.176.020.000	26.9	40	38	0.32
16.176.025.000	33.7	48	45	0.55
16.176.032.000	42.4	60	54	0.83
16.176.040.000	48.3	66	60	0.84
16.176.050.000	60.3	86	71	1.48

C24.158 Four Way Cross

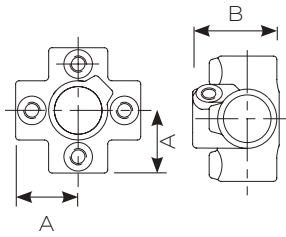

The 4 Way Cross fitting provides a four way midrail joint for handrail and other structures. It is recommended that the handrail post is continuous through the fitting. This fitting may also be used for the top rail with the centre post capped with a C65 Plastic Stop End.

Type	Tube size	A	B	Kg
16.158.020.000	26.9	41	59	0.43
16.158.025.000	33.7	48	65	0.75
16.158.032.000	42.4	60	80	1.14
16.158.040.000	48.3	67	85	1.19
16.158.050.000	60.3	86	90	2.12

C28.130 Adjustable 2 Socket Cross (30° to 45°)

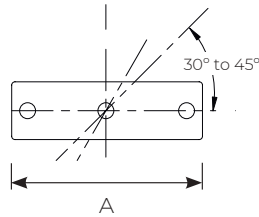

The Adjustable 2 Socket Cross fitting will accommodate any rake angle from 30° to 45°. This fitting is not recommended as the top fitting on a guardrail or balustrade system, use the C29 Adjustable Short Tee.

Type	Tube size	A	Kg
16.130.025.000	33.7	162	0.71
16.130.032.000	42.4	190	1.12
16.130.040.000	48.3	218	1.38

C29.129 Adjustable Short Tee (30° to 60°)

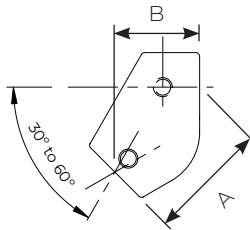

The Adjustable Short Tee fitting will accommodate any rake angle from 30° to 60°. This fitting is commonly used for the top rail of handrail to accommodate the rake angle on slopes. It can also be used for any Tee Joint to make at an angle of between 30° and 60° for light weight structures.

Type	Tube size	A	B	Kg
16.129.025.000	33.7	74	54	0.47
16.129.032.000	42.4	85	63	0.63
16.129.040.000	48.3	102	108	0.78

C40.161 90° Crossover

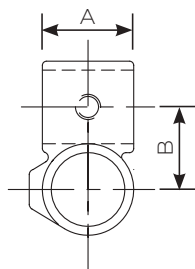

The 90° Crossover connects two rails at 90° to each other and is often used for the handrailing when continuous standard lengths of tube are used.

Please note that tube joints should use the C00 or C01 type fitting, and not the C40 type fitting.

Type	Tube size	A	B	Kg
16.161.020.000	26.9	36	35	0.22
16.161.025.000	33.7	40	40	0.34
16.161.032.000	42.4	49	49	0.41
16.161.040.000	48.3	55	55	0.57
16.161.050.000	60.3	61	64	0.82
16.161.025.032	33.7 / 42.4	45	45	0.46
16.161.025.040	33.7 / 48.3	51	48	0.57
16.161.032.040	42.2 / 48.3	51	52	0.59

C41.135 Clamp on Tee

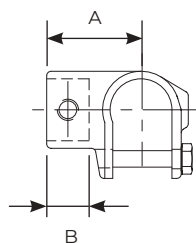

The Clamp on Tee is designed to allow a new tube to be joined to an existing structure.

Torque maximum 15N/M. This uses an M10 stainless steel bolt.

Type	Tube size	A	B	Kg
16.135.020.000	26.9	50	25	0.28
16.135.025.000	33.7	53	25	0.45
16.135.032.000	42.4	67	35	0.61
16.135.040.000	48.3	77	35	0.79
16.135.050.000	60.3	90	45	0.97

FIXED FITTINGS

C42.160 Clamp on Crossover

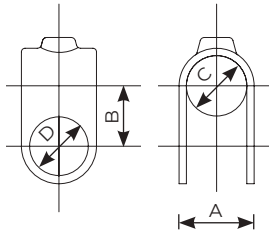

The Clamp on Crossover is designed to allow a new tube to be joined to an existing structure.

Type	Tube size	A	B	C	D	Kg
16.160.020.000	26.9	37	28	27	27	0.15
16.160.025.000	33.7	44	34	34	34	0.27
16.160.032.000	42.4	53	43	43	43	0.47
16.160.040.000	48.3	58	49	49	49	0.54
16.160.050.000	60.3	70	62	61	61	0.74

C041.204 Level to Sloping Down Tee (30° to 45°)

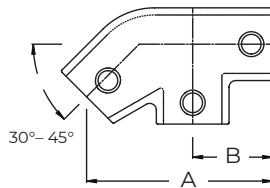

Used to form a Tee on handrails where the rail changes from level to sloping down the stairs. Adjustable between 30° & 45°.

Type	Tube size	A	B	Kg
16.204.032.000	42.4	142	60	1.02
16.204.040.000	48.3	154	68	1.12

C042.A204 Level to Sloping Up Tee (30° to 45°)

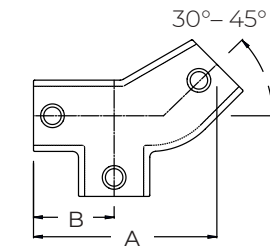

Used to form a Tee on handrails where the rail changes from level to sloping up the stairs. Adjustable between 30° & 45°.

Type	Tube size	A	B	Kg
16.A204.032.000	42.4	142	60	1.02
16.A204.040.000	48.3	154	68	1.12

C50.154 Slope Elbow (0° to 11°)

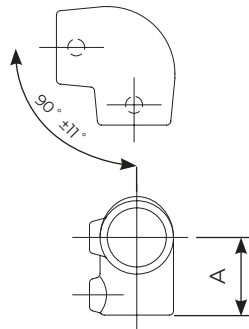

The Slope Elbow is designed to provide an elbow for use on ramps. The variable angle allows the fitting to accommodate slopes up to 11°.

Type	Tube size	A	Kg
16.154.032.000	42.4	60	0.81
16.154.040.000	48.3	67	1.02

C51.153 Short Slope Tee (0° to 11°)

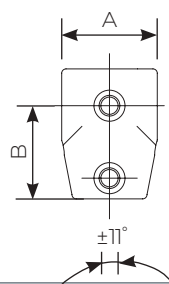

The Slope Short Tee is designed to provide a T joint between two tubes for use on ramps. The variable angle allows the fitting to accommodate slopes up to 11°.

Type	Tube size	A	B	Kg
16.153.032.000	42.4	68	60	0.57
16.153.040.000	48.3	72	68	0.76

C52.155 Long Slope Tee (0° to 11°)

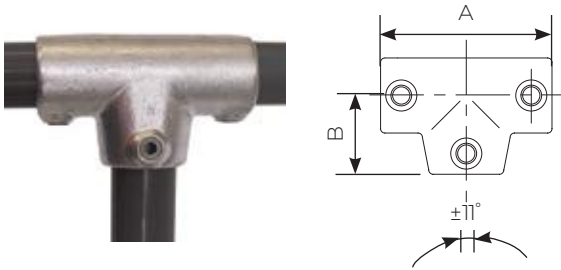

The Slope Long Tee is designed to provide a T joint between two tubes for use on ramps. The variable angle allows the fitting to accommodate slopes up to 11°.

Type	Tube size	A	B	Kg
16.155.032.000	42.2	144	60	1.06
16.155.040.000	48.3	158	67	1.10

C54.156 Slope 2 Socket Cross (0° to 11°)

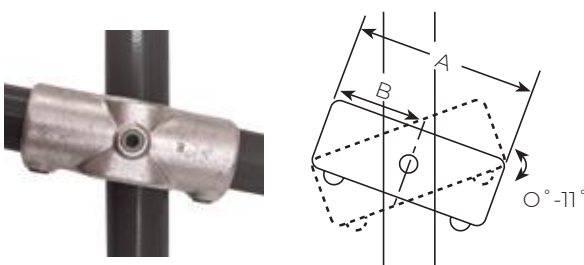

The Slope 2 Socket Cross is designed to provide a joint for the midrail for use on ramps. The variable angle allows the fitting to accommodate slopes up to 11°.

Type	Tube size	A	Kg
16.156.032.000	42.4	144	0.97
16.156.040.000	48.3	158	1

C55.191 27½° Ridge Fitting

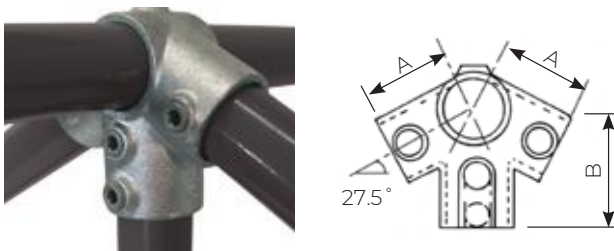

A four way socket fitting used to construct the ridge of a roof structure.

Type	Tube size	A	B	Kg
16.191.040.000	48.3	67	89	1

C56.185 27½° Eaves Fitting

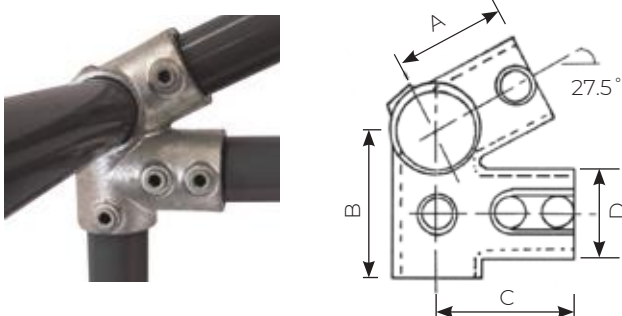

A four way socket fitting used to construct the eaves of a roof structure.

Type	Tube size	A	B	C	D	Kg
16.185.040.000	48.3	67	89	83	51	1.16

C57.177 Three Socket Tee (11° to 30°)

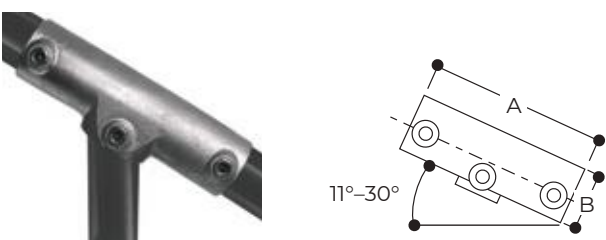

Similar to a type C27, it is used on Safety Railing with slopes between 11°-30° and fixes the top rail to a vertical intermediate upright. Unlike the type C27 these components are ex-stock and do not require machining.

Type	Tube size	A	B	Kg
16.177.032.000	42.4	180	35	1.16
16.177.040.000	48.3	216	40	1.46

FIXED FITTINGS

C58.178 Two Socket Cross (11° to 30°)

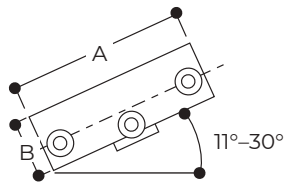

Similar to a type C26, it is used on Safety Railing with slopes between 11°-30° and fixes the mid rail to a vertical intermediate upright. Unlike the type C26 these components are ex stock and do not require machining.

Type	Tube size	A	B	Kg
16.178.032.000	42.4	180	55	0.97
16.178.040.000	48.3	216	60	1.26

C72.122 Acute Angle Elbow (30° to 45°)

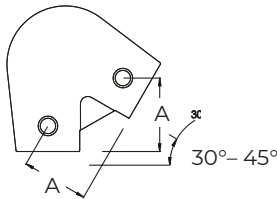

Used when a junction between a sloping tube and an end post is required i.e. guardrail on staircases between 30° & 45°

Type	Tube size	A	Kg
16.122.032.000	42.4	59	0.98
16.122.040.000	48.3	68	1.45

C72A.A122 Acute Angle Elbow (11° to 30°)

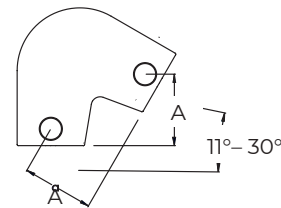

The C72A is used as an alternative to bending, or when a junction between a sloping tube and an end post is required i.e. guardrail on staircases between 11° & 30°

Type	Tube size	A	Kg
16.A122.032.000	42.4	58	0.94
16.A122.040.000	48.3	63	1.12

C201LH.C201 Left Hand Level to sloping down side outlet elbow (30° to 45°)

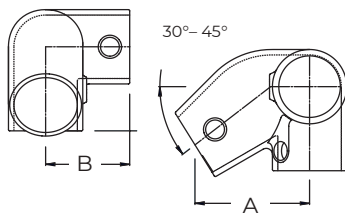

Used to form a Left Hand Side Outlet Elbow on handrails where the top rail changes from level to sloping down the stairs. Adjustable between 30° & 45°

Type	Tube size	A	B	Kg
16.C201.LH0.032	42.4	86	60	1.08
16.C201.LH0.040	48.3	93	68	1.28

C201RH.C201 Right Hand Level to sloping down side outlet elbow (30° to 45°)

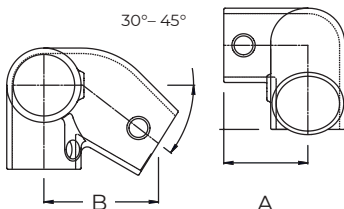

Used to form a Right Hand Side Outlet Elbow on handrails where the top rail changes from level to sloping down the stairs. Adjustable between 30° & 45°

Type	Tube size	A	B	Kg
16.C201.RH0.032	42.4	86	60	1.08
16.C201.RH0.040	48.3	93	68	1.28

C211LH.C211 Left Hand Level to sloping down side outlet tee (30° to 45°)

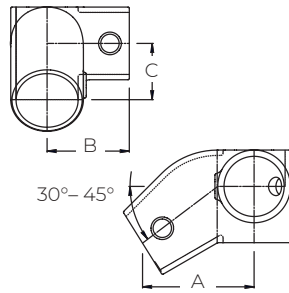

Used to form a Left Hand Side Outlet Tee on handrails where the mid rail changes from level to sloping down the stairs. Adjustable between 30° & 45°

Type	Tube size	A	B	C	Kg
16.C211.LHO.032	42.4	86	60	42	0.96
16.C211.LHO.040	48.3	92	68	47	1.12

C211RH.C211 Right Hand Level to sloping down side outlet tee (30° to 45°)

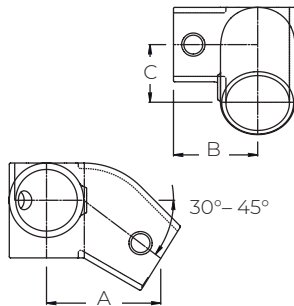

Used to form a Right hand Side Outlet Tee on hand-rails where the mid rail changes from level to sloping down the stairs. Adjustable between 30° & 45°

Type	Tube size	A	B	C	Kg
16.C211.RHO.032	42.4	86	60	42	0.92
16.C211.RHO.040	48.3	92	68	47	1.12

C221.219 Level to Sloping Down / Up Cross (30° to 45°)

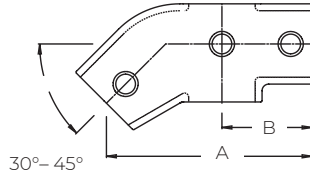

Used to form a cross on handrails where the mid rail changes from either level to sloping down or level to sloping up the stairs. Adjustable between 30° & 45°

Type	Tube size	A	B	Kg
16.219.032.000	42.4	142	60	0.82
16.219.040.000	48.3	154	68	0.95

C229.229 Single Socket Tee (11° to 30°)

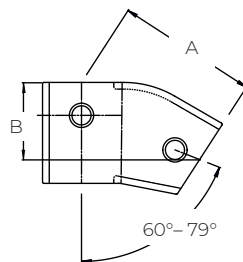

The adjustable Short Tee fitting will accommodate any rake angle from 11° to 30°. It can be used for any Tee Joint to make an angle of between 11° & 30°.

Type	Tube size	A	B	Kg
16.229.032.000	42.4	99	54	0.73
16.229.040.000	48.3	109	59	0.86

C245.277 Adjustable Long Tee (30° to 45°)

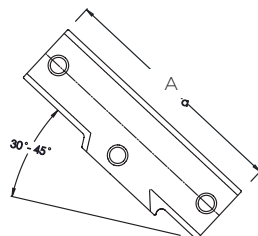

This fitting is used on Safety Railing with slopes between 30° & 45° and fixes the top rail to a vertical intermediate upright

Type	Tube size	A	Kg
16.277.032.000	42.4	180	0.95
16.277.040.000	48.3	216	1.22

SWIVEL FITTINGS

BC05.166 Swivel Elbow

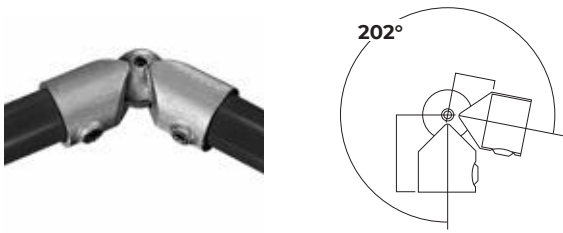

Type BC05 fitting has been designed as a variable angle in-line connection, adjustable through 202°.

Type	Tube size	A	B	Kg
16.166.025.000	33.7	60	33	0.51
16.166.032.000	42.4	73	36	0.81
16.166.040.000	48.3	83	45	1.14



WARNING!

An entire structure should not be constructed from Type BC05 or any other swivel fitting, as these would not provide sufficient stability or rigidity in the structure due to the free rotation of the fitting.

C10G.169M Swivel Base

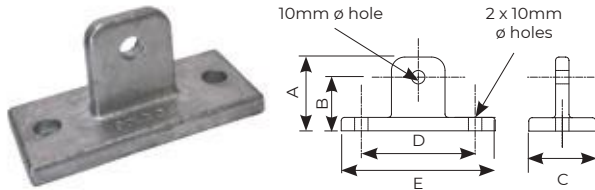

Designed to provide a base fixing. It is usually used in conjunction with a C36G type fitting to make a C46G type base swivel combination.

Type	A	B	C	D	E	Kg
16.169M.000.000	50	40	50	81	111	0.51



WARNING!

This fitting does not provide sufficient rigidity to be used as a railing base without other means of support.

C45.173 Single Swivel Combination

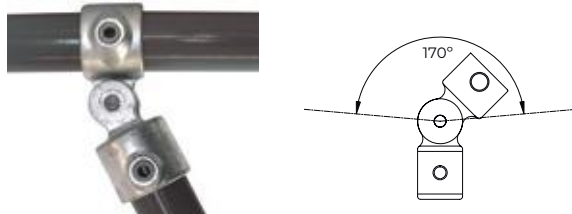

The Single Swivel Combination is designed to provide an angled tee between two tubes. It can be used to construct sloping handrail and for providing bracing struts to structures.

Type	Tube size	Kg
16.173.020.000	26.9	0.42
16.173.025.000	33.7	0.55
16.173.032.000	42.4	0.62
16.173.040.000	48.3	0.73
16.173.050.000	60.3	1.34



WARNING!

This fitting does not provide sufficient rigidity to be used as a railing base without other means of support.

C46.169 Base Swivel Combination

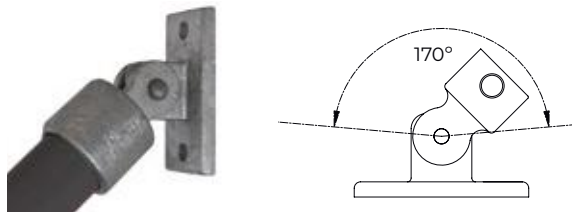

The Base Swivel Combination is designed to provide an angled wall or floor mounting.

Type	Tube size	Kg
16.169.020.000	26.9	0.62
16.169.025.000	33.7	0.87
16.169.032.000	42.4	0.81
16.169.040.000	48.3	0.85
16.169.050.000	60.3	0.96



WARNING!

This fitting does not provide sufficient rigidity to be used as a railing base without other means of support.

C47.167 Double Swivel Combination

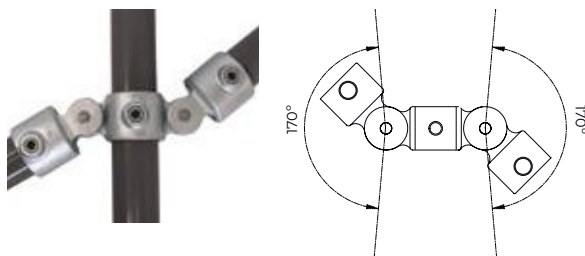

The Double Swivel Combination is designed to provide an in line angled joint as a post, this is suitable for the mid rail of a sloping handrail or to provide bracing to a structure.

Type	Tube size	Kg
16.167.020.000	26.9	0.78
16.167.025.000	33.7	0.99
16.167.032.000	42.4	0.81
16.167.040.000	48.3	1.32
16.167.050.000	60.3	2.5



WARNING!

This fitting does not provide sufficient rigidity to be used as a railing base without other means of support.

C48.168 90° Corner Swivel Combination

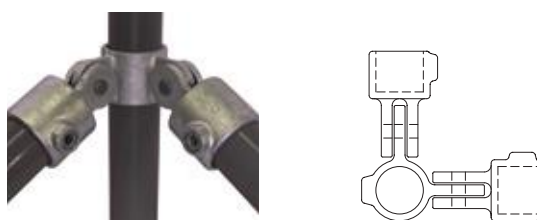

The 90° Corner Swivel Combination is designed to provide an angled joint at a post, this is suitable for the mid rail of sloping handrail or to provide bracing to a structure.

Type	Tube size	Kg
16.168.020.000	26.9	0.75
16.168.025.000	33.7	1.0
16.168.032.000	42.4	1.12
16.168.040.000	48.3	1.46



WARNING!

This fitting does not provide sufficient rigidity to be used as a railing base without other means of support.

C25.148 Short Tee Swivel (Sold singly but used in pairs)

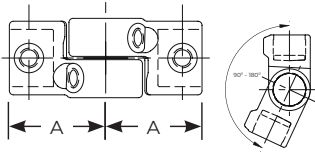

Normally used in pairs for corner angles of 90° to 180°. Also used on staircases with C02 & C03 fittings along with a short piece of tube and a C65 Plastic End Cap in landing areas. **When ordering please specify the number of fittings required, not the number of pairs.**

Type	Tube size	A	Kg
16.148.020.000	26.9	65	0.31
16.148.025.000	33.7	66	0.37
16.148.032.000	42.4	73	0.48
16.148.040.000	48.3	81	0.49
16.148.050.000	60.3	110	0.85

C35.173M Male Through Swivel

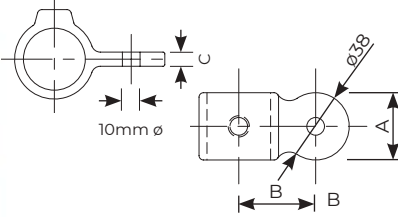

Can be used on its own for use with a shackle and chain or with the C36 female swivel to mount rails at any angle for slopes. It can also be used for attaching flat sheets or boards to a structure and is available assembled with the C36 fittings as a C45 single swivel combination.

Type	Tube size	A	B	C	Kg
16.173M.020.000	26.9	32	38	8	0.15
16.173M.025.000	33.7	32	42	8	0.20
16.173M.032.000	42.4	32	47	8	0.21
16.173M.040.000	48.3	32	50	8	0.24
16.173M.050.000	60.3	48	60	8	0.47

C36F.173F Female End Swivel

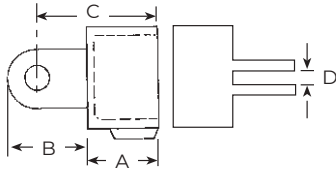

The Female Swivel is designed as part of the swivel combination group of fittings. It can be used with the C10, C35, C37, C38 or C36M male swivel fittings.

Type	Tube size	A	B	C	D	Kg
16.173F.020.000	26.9	39	35	53	10	0.24
16.173F.025.000	33.7	41	35	60	10	0.33
16.173F.032.000	42.4	44	35	63	10	0.38
16.173F.040.000	48.3	50	35	70	10	0.46
16.173F.050.000	60.3	70	40	95	10	0.84

C36M Male End Swivel

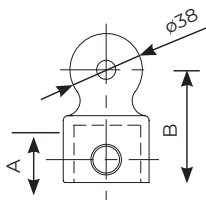

The Male Swivel is designed as part of the swivel combination group of fittings. It can be used with C36F fittings.

Type	Tube size	A	B	Kg
16.C36M.025.000	33.7	30	60	0.28
16.C36M.032.000	42.4	40	70	0.40
16.C36M.040.000	48.3	45	75	0.44

C37.167M Double Male Swivel

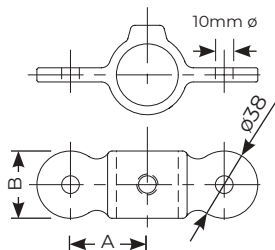

The Double Male Swivel is designed as part of the swivel combination group of fittings. It can be used with two C36 female swivel fittings. The double swivel combination is also available assembled as a type C47 fitting.

Type	Tube size	A	B	Kg
16.167M.020.000	26.9	40	32	0.21
16.167M.025.000	33.7	44	32	0.28
16.167M.032.000	42.4	49	32	0.32
16.167M.040.000	48.3	52	32	0.46
16.167M.050.000	60.3	63	50	0.51

C38.168M 90° Corner Male Swivel

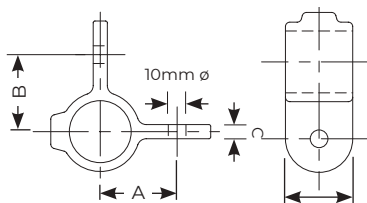

The 90° Corner Male Swivel is designed as part of the swivel combination group of fittings. It can be used with two C36 female swivel fittings to make a corner combination fitting which is also available assembled as a type C48 type fitting.

Type	Tube size	A	B	C	Kg
16.168M.020.000	26.9	40	39	8	0.22
16.168M.025.000	33.7	44	38	8	0.34
16.168M.032.000	42.4	49	48	8	0.39
16.168M.040.000	48.3	53	48	8	0.47

FIXINGS & ANCILLARIES

C11.131 Wall Flange

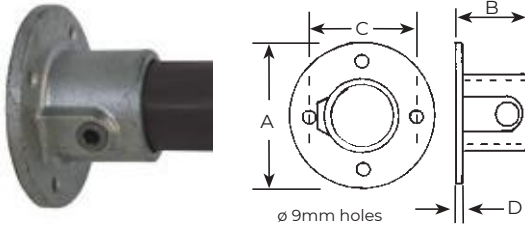

The Wall Flange is designed to provide a positional wall or base fixing.

It is not recommended to use this fitting as a structural railing base.

Type	Tube size	A	B	C	D	Kg
16.131.020.000	26.9	86	42	57	4	0.35
16.131.025.000	33.7	89	45	64	6	0.39
16.131.032.000	42.4	102	50	76	6	0.5
16.131.040.000	48.3	114	57	89	6	0.65
16.131.050.000	60.3	127	64	95	6	1.1

C12.132 Railing Base Flange

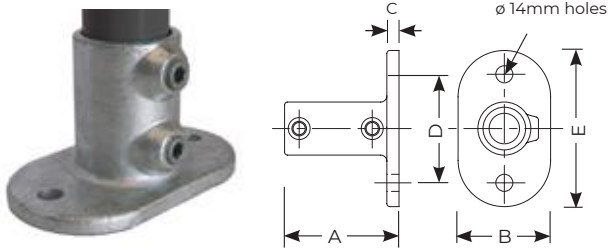

The Railing Base is designed to provide a base for railings and other structures.

Recommended this fitting be used in accordance with Flocon maximum post centre dimensions, see table 3 on Page 5.

Type	Tube size	A	B	C	D	E	Kg
16.132.020.000	26.9	76	65	8	76	114	0.60
16.132.025.000	33.7	89	76	9	89	128	0.91
16.132.032.000	42.4	89	80	10	102	140	1.03
16.132.040.000	48.3	89	89	10	114	152	1.24
16.132.050.000	60.3*	128	128	9	127	165	1.89

* Has \varnothing 18mm holes

C13.144 Railing Vertical Side Support

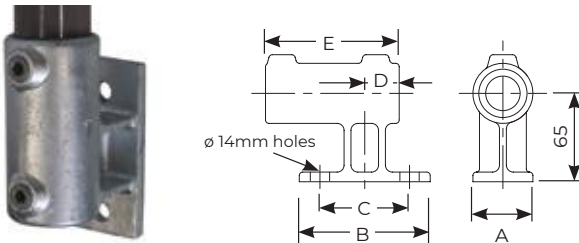

Designed to provide a base for railings and other structures that need a side mounted fixing.

Type	Tube size	A	B	C	D	E	Kg
16.144.025.000	33.7	45	96	67	28	104	0.6
16.144.032.000	42.4	50	109	78	30	114	0.91
16.144.040.000	48.3	60	123	86	34	120	1.03

Recommended this fitting be used in accordance with Flocon maximum post centre dimensions, see table 3 on Page 5.

C14.145 Railing Horizontal Side Support

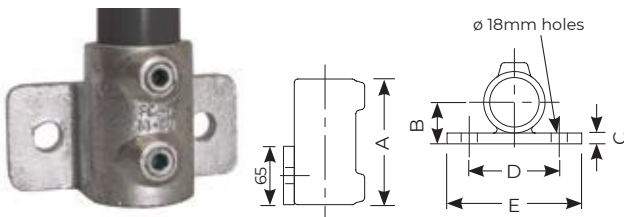

Designed to provide a base for railings and other structures that need a side mounted fixing.

Type	Tube size	A	B	C	Kg
16.145.025.000	33.7	90	30	12	1.08
16.145.032.000	42.4	90	35	12	1.32
16.145.040.000	48.3	90	41	15	1.67

Recommended this fitting be used in accordance with Flocon maximum post centre dimensions, see table 3 on Page 5.

C15.146 Side Palm Fixing

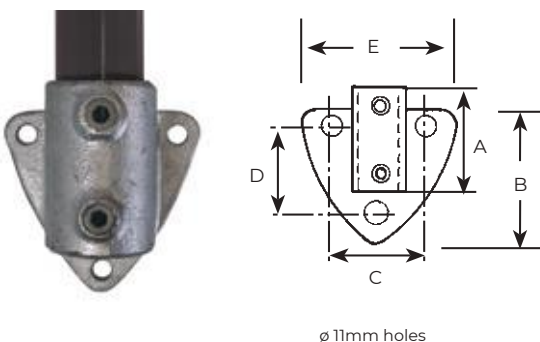

Designed to provide a base for railings and other structures that need a side mounted fixing.

Type	Tube size	A	B	C	D	E	Kg
16.146.025.000	33.7	76	89	71	63	97	0.63
16.146.032.000	42.4	84	98	82	72	108	0.80
16.146.040.000	48.3	92	104	86	78	112	0.84

Recommended this fitting be used in accordance with Flocon maximum post centre dimensions, see table 3 on Page 5.

C16.143 Handrail Bracket

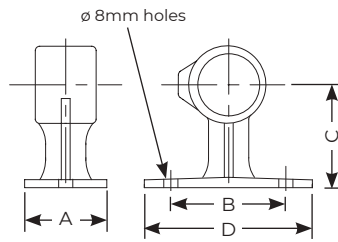

The Handrail Bracket is designed to secure handrail tube to a wall. It can also be used on top of walls as a fixing for a low rail.

Type	Tube size	A	B	C	D	Kg
16.143.020.000	26.9	44	57	55	78	0.36
16.143.025.000	33.7	44	63	57	82	0.46
16.143.032.000	42.4	44	76	63	102	0.57
16.143.040.000	48.3	48	85	67	108	0.62

C17.134 Ground Support

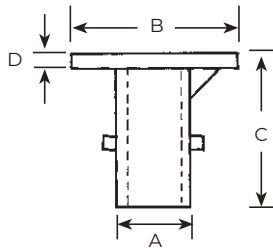

The Ground Socket is designed to provide a base that can be cast into the ground to support a post. The post is removable.

Type	Tube size	A	B	C	D	Kg
16.134.025.000	33.7	60	140	130	4.5	1.42
16.134.032.000	42.4	60	140	130	4.5	1.42
16.134.040.000	48.3	60	140	130	4.5	1.42

Recommend this fitting be used in accordance with Flocon maximum post centre dimensions, see table 3 on Page 5.

C18.142 Base Flange with Integrated Toeboard

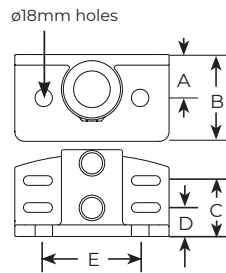

The Base Flange with Integrated Toeboard is ideal for guardrailing and balustrading applications where the addition of a toeboard is required. The side plates have slotted holes to allow for a degree of sideways movement for ease of installation.

Type	Tube size	A	B	C	D	E	Kg
16.142.032.000	42.4	45	90	58	30	100	2.14
16.142.040.000	48.3	45	90	58	30	100	2.28

Recommend this fitting be used in accordance with Flocon maximum post centre dimensions, see table 3 on Page 5.

C30.179 Collar

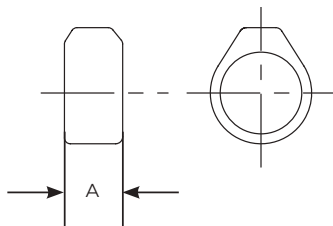

The Collar fitting can be used to support the C03 fitting when the latter is used as a hinge. It can also be used to increase the load capacity of another fitting when used together.

The C30 can be used as a stop for a sliding tube.

Type	Tube size	A	Kg
16.179.020.000	26.9	22	0.08
16.179.025.000	33.7	25	0.13
16.179.032.000	42.4	25	0.16
16.179.040.000	48.3	25	0.18
16.179.050.000	60.3	40	0.32

C31.138 Gate Eye

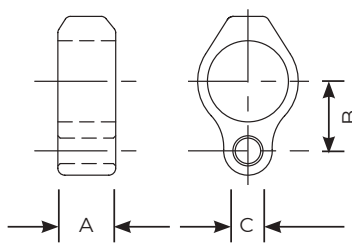

This fitting is designed as a gate eye for light weight gates. If a heavy gate is being used we recommend that C03 and C30 type fittings are used to support the gate.

Type	Tube size	A	B	C	Kg
16.138.020.000	26.9	25	30	15	0.14
16.138.025.000	33.7	25	33	15	0.19
16.138.032.000	42.4	25	38	15	0.25
16.138.040.000	48.3	25	41	15	0.26

FIXINGS & ANCILLARIES

C32.140 Gate Hinge

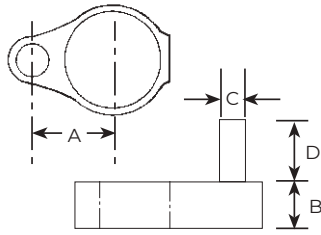

This fitting is designed as a gate hinge for light weight gates. If a heavy gate is being used we recommend that C03 and C30 type fittings are used to support the gate.

Type	Tube size	A	B	C	D	Kg
16.140.020.000	26.9	30	25	13	38	0.21
16.140.025.000	33.7	33	25	13	38	0.27
16.140.032.000	42.4	38	25	13	38	0.3
16.140.040.000	48.3	41	25	13	38	0.32

C33.182 Hook

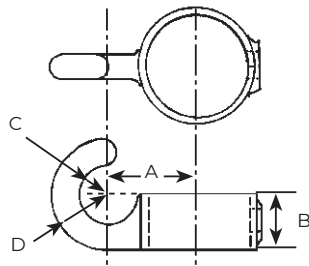

The fitting is designed to provide an attachment for chains.

Type	Tube size	A	B	C	D	Kg
16.182.020.000	26.9	32	25	10	25	0.17
16.182.025.000	33.7	34	25	13	21	0.24
16.182.032.000	42.4	39	25	13	25	0.25
16.182.040.000	48.3	41	25	13	25	0.3

C34.199 Fixing Pad

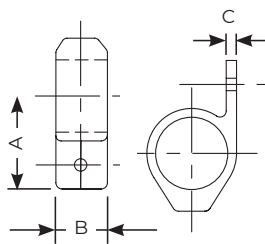

The fitting is designed to provide an attachment for flat sheets or board. It may also be used as a gate stop. An alternative fitting for the attachment of boards is the C35 type.

Type	Tube size	A	B	C	φ	Kg
16.199.025.000	33.7	45	25	5	6	0.16
16.199.032.000	42.4	53	40	5	11	0.32
16.199.040.000	48.3	56	40	5	11	0.35

C43.165 Combination Socket

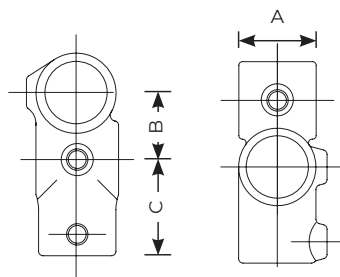

The Combination Socket is designed for racking and similar systems to allow a crossover to be combined with a cross tie.

Type	Tube size	A	B	C	Kg
16.165.020.000	26.9	31	35	40	0.28
16.165.025.000	33.7	42	40	48	0.49
16.165.032.000	42.4	54	50	60	0.75
16.165.040.000	48.3	60	56	67	0.9
16.165.050.000	60.3	72	68	86	1.72

C53.152 Slope Base (0° to 11°)

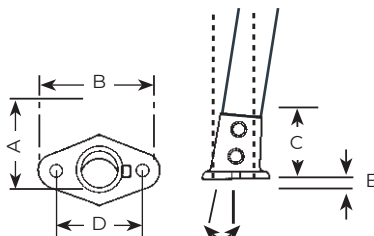

The Slope Base is designed to provide a base for use on ramps. The variable angle allows the fitting to accommodate slopes up to 11°.

Type	Tube size	A	B	C	D	E	Kg
16.152.032.000	42.2	91	140	79	102	10	0.9
16.152.040.000	48.3	96	152	80	114	10	1.4

C59.151 Angle Base Flange (11° to 30°)

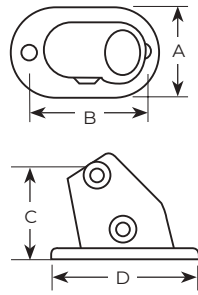

Similar to a type C53, it is used to set the upright at an angle between 11°–30°. This fitting should only be subjected to light loads which cannot be positioned at 90° to the applied load.

For greater loads or other tube sizes a type C12 flange should be used with the upright bent to the required angle ϕ indicates the diameter of the fixing hole.

Type	Tube size	A	B	C	D	ϕ	Kg
16.151.032.000	42.4	76	114	85	146	14	1.27
16.151.040.000	48.3	89	124	95	164	14	1.42

C59A.A151 Angle Base Flange (30° to 45°)

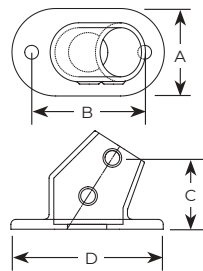

Similar to a type C59, it is used to set the upright at an angle between 30° & 45°. This fitting should only be subjected to light loads which cannot be positioned at 90° to the applied load. For greater load use a type C12

Type	Tube size	A	B	C	D	Kg
16.A151.032.000	42.4	76	106	81	138	1.17
16.A151.040.000	48.3	89	115	85	155	1.53

C200.200 Double Sided Fixing Bracket

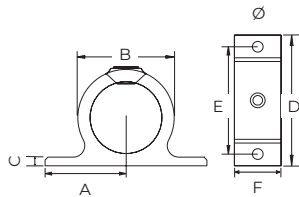

The Type C200 is used as an attachment point for flat sheets or boards and comes supplied with a drilled hole.

Type	Tube size	A	B	C	D	E	F	ϕ	Kg
16.C200.025.000	33.7	45	45	5	90	70	25	6.5	0.18
16.C200.032.000	42.4	53	55	6	106	86	40	11.5	0.38
16.C200.040.000	48.3	56	66.7	6	112	92	40	11.5	0.59



FIXINGS & ANCILLARIES

C60 Spare Screws



Spare Screws come in two sizes, 1/4" ISO 228 for the 20 and 25NB range and 3/8" ISO 228 for the 32, 40 and 50 ranges.

Type	Tube size
16.ALL.SCR.001	26.9, 33.7 & 42.4
16.ALL.SCR.002	48.3 & 60.3

C61 Allen Keys



Allen keys are available in two sizes, the first is suitable for the 20 and 25NB fitting and the other for the 32, 40 and 50nb fittings.

Type	Tube size
16.KEY.020.025	26.9, 33.7 & 42.4
16.KEY.032.040	48.3 & 60.3

C62R Ratchet Keys



The Ratchet driver and dual keys are available to speed assembly. The Ratchet driver will allow tightening to the correct torque.

Type	Tube size
16.PIP.RATCHET	ALL SIZES

C65P.133 Plastic End Cap



Plastic End Caps are available for finishing plain end tubes. Available in grey plastic they will fit medium and heavy gauge tube.

Type	Tube size	Kg
16.133.020.000	26.9	0.008
16.133.025.000	33.7	0.010
16.133.032.000	42.4	0.010
16.133.040.000	48.3	0.016
16.133.050.000	60.3	0.024

C65G.133M Metal End Cap

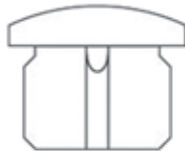

This metal plug is hard to remove once it has been driven in.

Note this metal insert can only be used in conjunction with tube with a wall thickness of 3.2mm. There is an alternative plastic version - C65P

Type	Tube size	Kg
16.133M.020.000	26.9	0.05
16.133M.025.000	33.7	0.10
16.133M.032.000	42.4	0.12
16.133M.040.000	48.3	0.17
16.133M.050.000	60.3	0.29

C66.170 Single Mesh Clip

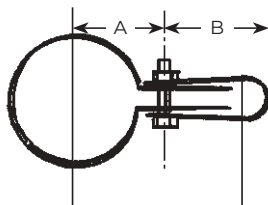

The Single Mesh Clip is designed to provide a fixing for standard mesh panels. It is recommended that the clips are spaced at a maximum of 450mm apart.

Type	Tube size	A	B	C	Kg
16.170.020.000	26.9	27	26	58	0.06
16.170.025.000	33.7	30	26	61	0.07
16.170.032.000	42.4	33	26	64	0.08
16.170.040.000	48.3	38	26	68	0.09
16.170.050.000	60.3	44	26	75	0.09

C67.171 Double Mesh Clip

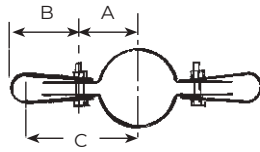

The Double Mesh Clip is designed to provide a fixing for standard mesh panels. It is recommended that the clips are spaced at a maximum of 450mm apart.

Type	Tube size	A	B	C	Kg
16.171.020.000	26.9	27	26	58	0.09
16.171.025.000	33.7	30	26	61	0.12
16.171.032.000	42.4	33	26	64	0.13
16.171.040.000	48.3	38	26	68	0.13
16.171.050.000	60.3	44	26	75	0.14

C68.192 Weather Cowl

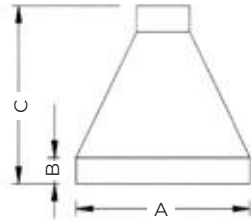

The Weather Cowl is designed to cover the Railing base and provides a weather proof seal when used with a suitable flexible sealant.

Type	Tube size	A	B	C	Kg
16.192.025.000	33.7	140	25	125	0.28
16.192.032.000	42.4	150	25	150	0.33
16.192.040.000	48.3	166	25	150	0.38

C69 Square Plastic End Cap

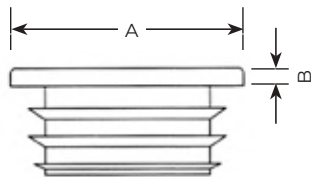

The Plastic End Caps are available for finishing plain end square tubes. Available in grey plastic they will fit medium and heavy tube gauges.

Type	Tube size	A	B	Kg
16.C69.040.040	40X40SHS	40	3.2	0.01
16.C69.050.050	50x50SHS	50	3.2	0.01
16.C69.070.070	70x70SHS	70	3.2	0.02

C70 Crimp Straight

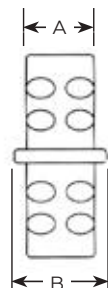

Straight Crimp Joints provide a permanent in-line connection for 33.7mm diameter x 3.2mm thick tube, a crimping tool is necessary.

Type	Tube size	A	B	Kg
16.C70.025.000	33.7	(Ø)26.0	34	0.3

C71 Crimp Elbow

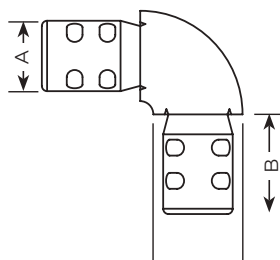

Crimp Elbow provides a permanent 90° connection for 33.7mm diameter x 3.2mm thick tube, a crimping tool is necessary.

Type	Tube size	A	B	C	Kg
16.C71.025.000	33.7	26	38	34	0.47

FIXINGS & ANCILLARIES

BAR.16 Kick Flat Bar



A Kick Plate is a piece of metal attached to the foot of a door, it allows the opening of doors using feet. This is important in businesses or institutions where employees do a lot of material handling and protects the door from being marked or damaged.

They can also allow for doors to be opened using material handling products like dollies and trolleys.

Code	Size
BARI6.7OE.100.006	100mm x 6mm x 3m

K40 Galvanised Kick Plate Clamp



Commonly installed in industrial environments to prevent objects falling from edges of stairs and bridges, Kick Plate Clamps are used to secure kickplates in place.

Available in a galvanized finish, these K40 clamps are manufactured from cast malleable iron to comply with BS EN 14122 standards.

Code	Sizes	
16.K40.040.032	1 1/2"	1 1/4"

KCB1 Kick Flat Corner Joint Internal



When edges of toe plates are installed on industrial applications such as stairs, bridges and walkways, Kick Flat Corner Joints are applied to securely connect toe plates together without leaving a hazardous gap.

Simply tighten or loosen the included grub screw with a ratchet or hex/Allen key.

Code
16.K40.KCB.001

KCB2 Kick Flat Corner Joint External



When edges of toe plates are installed externally on industrial applications such as stairs, bridges and walkways, Kick Flat Corner Joints are applied to securely connect toe plates together without leaving a hazardous gap.

Simply tighten or loosen the included grub screw with a ratchet or hex/Allen key.

Code
16.K40.KCB.002

KCB3 Kick Flat Straight Joint



Straight Joint Kick Flats are installed to secure toe plates to industrial applications such as stairs, bridges and walkways, Kick Flat Straight Joints are applied to securely connect toe plates without leaving hazardous gaps for debris to drop.

Simply tighten or loosen the included grub screw with a ratchet or hex/Allen key.

Code
16.K40.KCB.003



DDA RANGE

DDA RANGE

HANDRAILING FOR THE DISABLED

Under the terms of the Equality Act 2010 (previously the Disability Discrimination Act), reasonable adjustments need to be made to public and commercial buildings to overcome physical barriers which prevent disabled access. The Building Regulations recommend an outside diameter tube size for installations of between 40mm-45mm.

The DDA range has been designed to meet these requirements by providing a non-discriminatory handrail solution that complies with the Equality Act and Part 'M' of the Building Regulations.

The range allows construction of a smooth, continuous handrail of 42.4mm diameter.

DDA fittings are supplied hot dip galvanised as standard, but can be supplied in a powder coated finish to RAL standard colours (subject to quantity and availability from the coaters).

In cold temperatures, a powder coated finish will give the impression of being warmer to the touch. See our Easirail handrails for more details.

DDA-01 Upright Connector

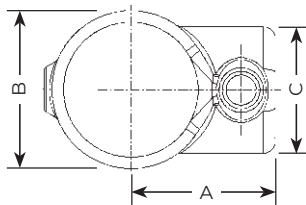

Type	A	B	C	Kg
16.DDA.001.CON	55	60	50	0.38

Connector for attaching the DDA04 intermediate bracket or the DDA02 handrail connector to the 48.3mm o/d upright.

DDA-02 Handrail Connector

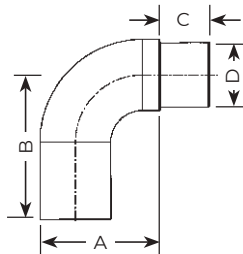

Type	A	B	C	D	Kg
16.DDA.002.RAI	51	86	30	38	0.48

Connector (made from Ductile Iron) for attaching the end of the 42.4mm o/d handrail tube at 90° to the 48.3mm o/d upright.

This bracket is used in conjunction with DDA01 and DDA07.

DDA-03 Wall Bracket

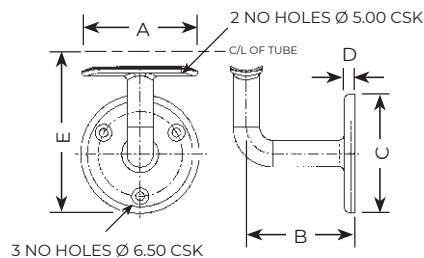

Type	A	B	C	D	E	Kg
16.DDA.003.WBR	88	82	90	8	84	0.62

Bracket (made from Ductile Iron) for supporting the 42.4mm o/d handrail tube to a wall. The 42.4mm o/d tube is fixed to the DDA03 using either 2 x self tapping screws or 2 x pop rivets.

DDA-04 Intermediate Bracket

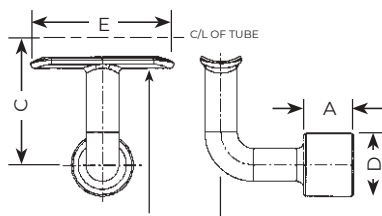

Type	A	B	C	D	E	Kg
16.DDA.004.INB	30	81	84	38	88	0.44

Bracket (made from Ductile Iron) for supporting the top or middle rail tube at an upright in conjunction with a DDA01. The 42.4mm o/d tube is fixed to the DDA04 using either 2 x self tapping screws or 2 x pop rivets.

DDA-05 End Return

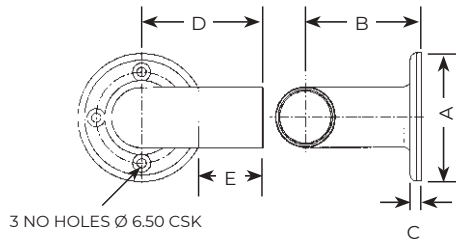

Type	A	B	C	D	E	Kg
16.DDA.005.END	90	82	8	86	46	0.64

Bracket (made from Ductile Iron) for terminating the 42.4mm o/d handrail tube back to a wall. This bracket is used in conjunction with a DDA07.

DDA-06 90° Bend

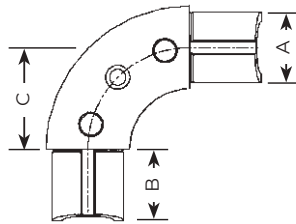

Type	A	B	C	Kg
16.DDA.006.BEN	33.7	35	50	0.93

Expanding elbow (made from Ductile Iron) for creating a smooth 90° bend in the 42.4mm o/d tube.

DDA-07 Internal Connector

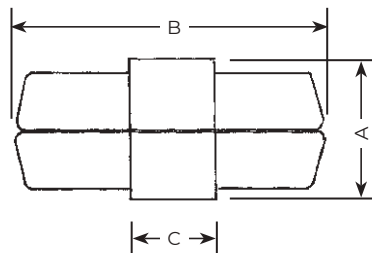

Type	A	B	C	Kg
16.DDA.07.CON	42.4	75	19	0.35

Expanding internal connector for joining sections of 42.4mm o/d tube, or other DDA fittings as and when required.



WARNING!

Inline internal connector for joining two tubes together. Only medium gauge 3.2mm wall thick tube can be used. The DDA07 should never be used as a load bearing joint. The DDA07 must be used within 100mm of an upright.

DDA-08 Plastic End Cap

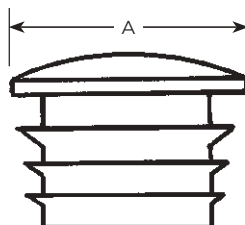

Type	A	Kg
16.133.040.000	48.3	0.016

48.3mm o/d plastic end cap for inserting into the open tube on the top of the upright. For a permanent fix, a suitable adhesive should be used.

DDA-09 Adjustable Bend

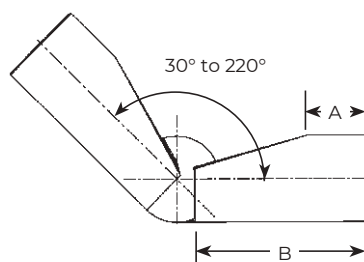

Type	A	B	Kg
16.DDA.09.ADB	31	86	0.61

Fitting (made from Ductile Iron) for creating an adjustable bend between the horizontal and the vertical.



WARNING!

Only to be used in conjunction with DDA-07 internal connectors and O rings.

ROOF EDGE PROTECTION

ROOF EDGE PROTECTION

Defender Roof Edge Protection systems operate on a counterbalance principle using curved PVC counterweights as the main component. A galvanised malleable iron foot with a protective rubber base supports the handrail post; this includes an integral toeplate facility which is a fundamental requirement if there is no perimeter edge upstand.

All systems feature 1100 mm tall factory preassembled uprights that include open cradle fittings allowing the handrail tube to be quickly dropped into place instead of the time consuming process of the tube being fed through several fittings as required with other systems, speeding up assembly and saving cost.



ECONOMY SYSTEM

A simple and cost effective way of protecting roof edges.



STANDARD SYSTEM

Shorter length counterweight tubes, enables installation in restricted roof areas.



PLUS SYSTEM

Aesthetically pleasing, curved uprights with 3 rails for added security.

Benefits of Defender Roof Edge Protection

- System is effectively maintenance free with hot dip galvanised fittings and tube to BS EN ISO 1461
- Recycled PVC counterweights
- For use on asphalt, coated steel sheeted concrete or mineral felt roofs
- Rapid installation, no special tools or specialised labour required
- No on site welding or bending required
- Base fitting allows option of installing uprights up to 11° from vertical
- Bolt on toeplate available to comply with HSG 33

Our systems are freestanding, with no requirement for fixings or drilling and subsequently no repair to the roof membrane.

Suitable for flat roofs up to 3° pitch.

The systems can be configured to satisfy the requirements of BS EN 13374 Class A.



SELF CLOSING SAFETY GATES



Flocon supplies a range of self-closing industrial safety gates. Gates are suitable for external and internal applications, and can be retro-fitted to existing structures.

The gates are spring loaded to automatically close behind the user, to provide a safe environment and overcome the problem of human error. Industrial safety gates provide a safe access to demarcated areas within factories, warehouses and loading bays.

Our industrial safety gates are compliant with the requirements of EN 13374 and EN 14122. The gates have been extensively tested to ensure their durability and reliability.

Flocon self-closing safety gates are supplied 1m wide and 2 x 0.9m wide for larger openings. The gates are available either hot dipped galvanised or powder coated in safety yellow and can be easily trimmed to size on-site.

- Single and double width gates
- Easy to assemble
- Performance tested for trouble free operation
- Fully adjustable for varying widths

Type	Description
RE00T40	RE00T40 - EN - 14122 Defender Vertical Toe-Board Upright
RE11P40	Defender Roof Edge Counterweight assembly
RE11P40S	Short Defender C/B Assembly
RE12P40	Defender Roof Edge Run End Weight assembly
SGEUCV2	Single Gate - Galvanised
SGEUPC2	Single Gate - Powder Coated Galvanised

SIZING CHARTS

How to calculate correct tube cutting length using types C05A, C57, C58, C59A, C72A & C229 on slopes between 11° to 30°

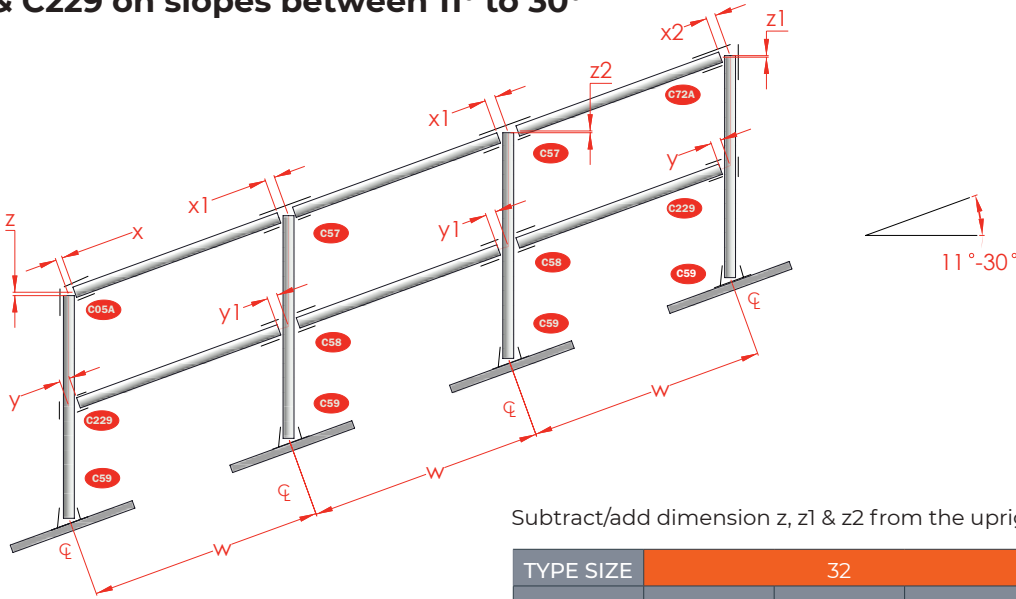

Subtract/add dimension z, z1 & z2 from the upright height

TYPE SIZE	32			40		
	z	z1	z2	z	z1	z2
11°	-10	-28	+7	-20	-34	+6
15°	-11	-25	+7	-25	-29	+6
20°	-13	-34	+7	-21	-39	+6
25°	-15	-43	+7	-22	-50	+6
30°	-18	-53	+7	-4	-61	+6

x Dimensions to be added/subtracted from upright height

Subtract dimension x, x1, x2, y or y1 from upright centres (w). Please note the upright centres must be measured on the slope

TYPE SIZE	32					40				
	x	x1	x2	y	y1	x	x1	x2	y	y1
11°	-25	-26	-35	-52	-26	-26	-29	-35	-51	-29
15°	-21	-28	-46	-53	-58	-22	-31	-47	-52	-31
20°	-16	-30	-48	-55	-30	-20	-34	-50	-54	-34
25°	-15	-33	-52	-59	-33	-14	-38	-54	-57	-38
30°	-8	-37	-57	-64	-42	-29	-42	-60	-62	-42

How to calculate correct tube cutting length using types C041, C042, C12 & C221 on slopes between 30° to 45°

Subtract dimension x to determine rail size on level

TYPE SIZE	32	40
	x	x
35-45°	-21	-24

y Dimensions to be subtracted from upright centres

Please note upright centres must be measured on the slope

TYPE SIZE	32	40
	y	y
30°	-47	-57
35°	-52	-62
40°	-59	-69
35°	-68	-79

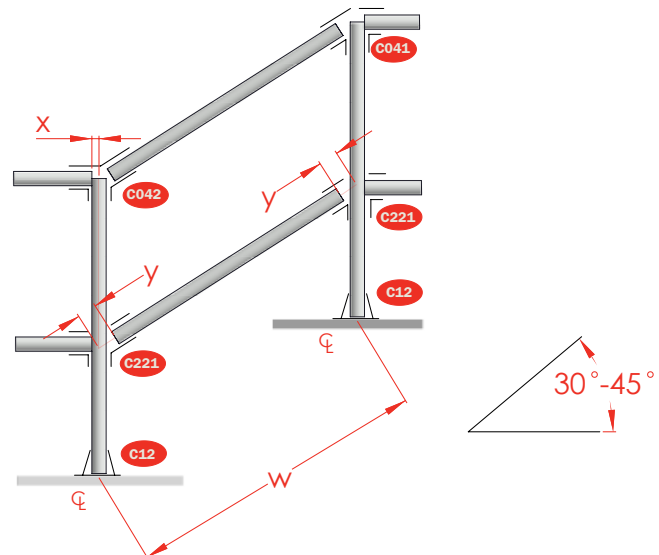

How to calculate correct tube cutting length using types C05, C245, C28, C59A, C72 & C29 on slopes between 30° to 45°

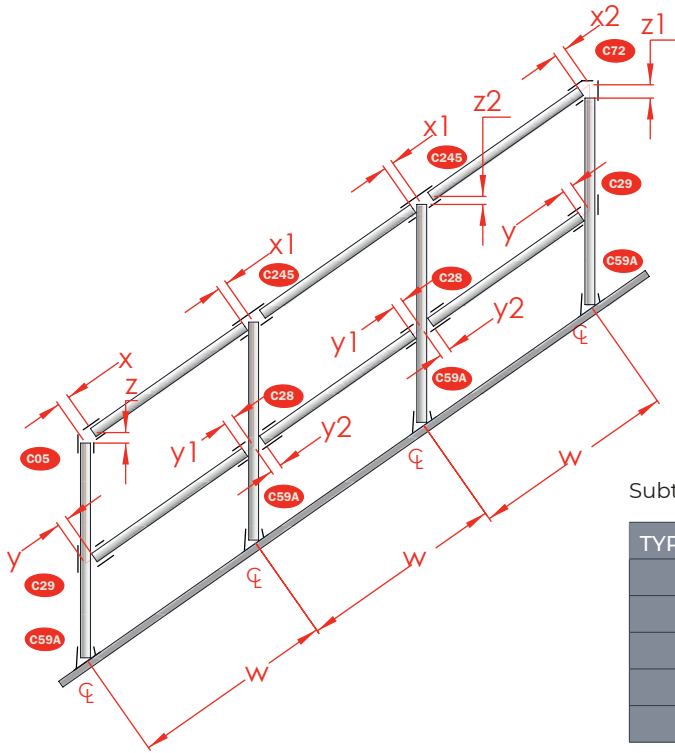

Subtract/add dimension z, z1 & z2 from the upright height

TYPE SIZE	32			40		
	z	z1	z2	z	z1	z2
30°	-17	-48	+5	-27	-47	+6
35°	-16	-59	+5	-21	-53	+6
40°	-8	-69	+5	-14	-68	+6
55°	-2	-80	+5	-5	-79	-4

Subtract dimension x, x1, x2, y or y1 from upright centres (w). Please note the upright centres must be measured on the slope

TYPE SIZE	32					40				
	x	x1	x2	y	y1	x	x1	x2	y	y1
30°	-20	-39	-55	-37	-49	-17	-42	-48	-43	-64
35°	-16	-44	-61	-40	-50	-18	-46	-60	-47	-64
40°	-20	-47	-71	-45	-51	-21	-52	-65	-52	-64
45°	-26	-50	-85	-51	-51	-26	-58	-60	-59	-64

How to calculate correct tube cutting length for straight and level handrails

W = Distance between uprights
 ϕ to ϕ

SIZE	
32	40
x	x
-22	-25

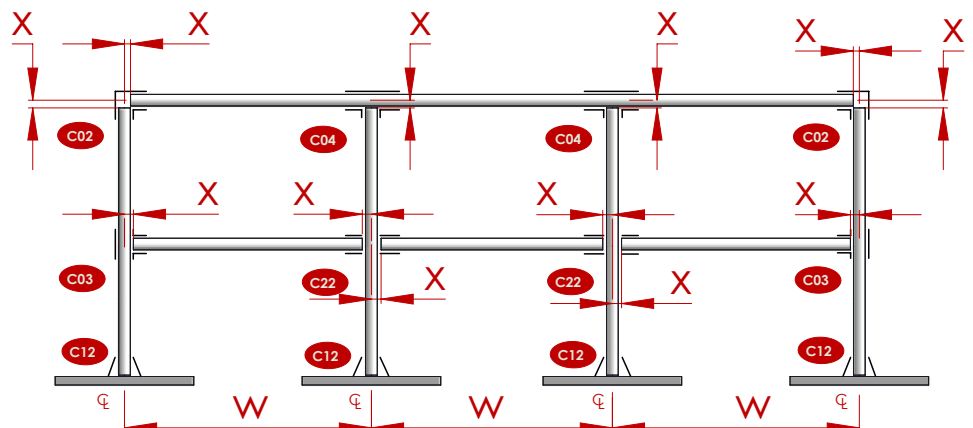

BALL STANDARDS



BALL STANDARDS

Flocon offers Ball Standards in both finished and semi-finished formats together with handrail return bends.

Hot dip galvanised finished standards are constructed from 42.4mm diameter tube complete with balls, suitable for 33.7mm diameter handrailing.

Balls are drilled & tapped, and fitted with stainless steel M8 socket setscrews.

Base plates are complete with 18mm diameter holes to suit M16 fixing bolts.

- Self colour sticks from stock
- Sticks hot dip galvanised ready
- Types 62, 64, 65, 68, 69 & 115 bases for Sticks
- Hot dip galvanised standards from stock
- 38° and 42° staircase standards from stock
- Standards complete with stainless steel setscrew in each ball
- Other diameters and formats available, please send details for quote

HANDRAILING & RETURN BENDS

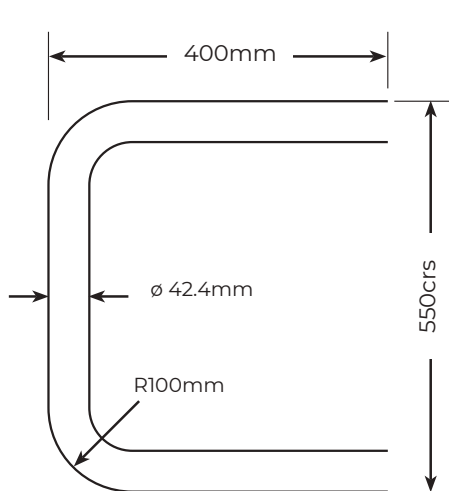

Platform Return Bends

42.4mm diameter from stock

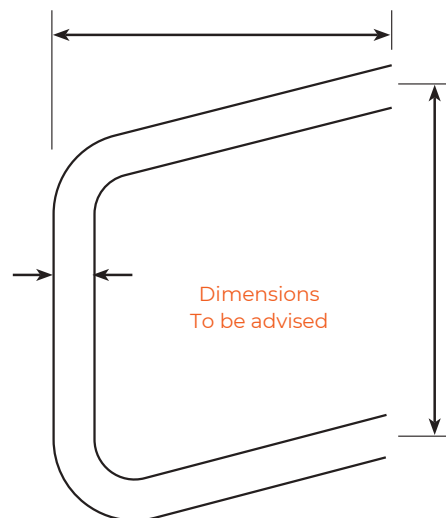

Stair Return Bends

42.4mm diameter from stock

BALL STANDARDS

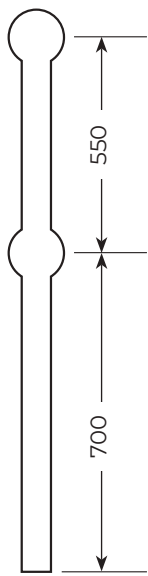

STICK

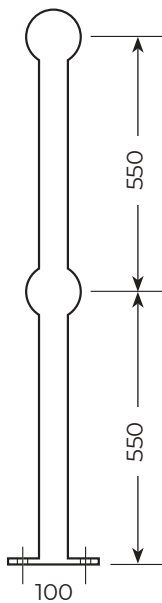

PLATFORM FLAT

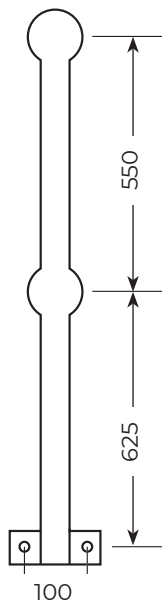

PLATFORM HSP

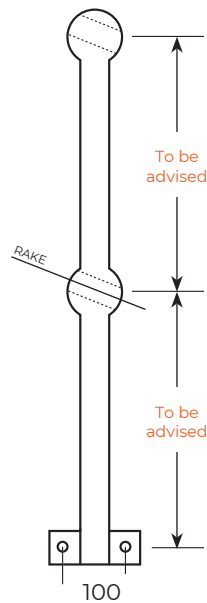

RAKING HSP (R)

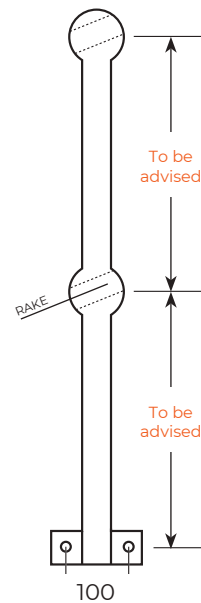

RAKING HSP (L)

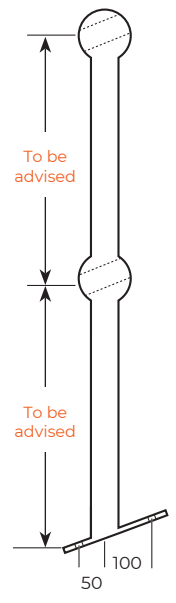

RAKING FLAT

FITTINGS FOR USE WITH BALL STANDARDS



C00 Sleeve Joint



C02 90° Elbow



C41 Clamp on Tee



C11 Wall Flange



C12 Railing Flange



C13 Vertical Railing Base



C14 Horizontal Railing Base



C15 Side Palm



C18 Railing Flange (Toeboard adaptor)



C200 Horizontal Railing Support



 **FLOCON**



EASIRAIL

INTRODUCTION

Whether positioned alongside existing steps or running down a walkway, Easirail avoids the traditional industrial “look” that features oversized joints, like many other handrail alternatives.

Using high quality materials and finishes, Easirail is designed to be fast to install, offering flexibility for a wide array of configurations.

All components are fully galvanised and ready coated in a warm touch acrylic finish for effective corrosion resistance.

The handrail is simply cut to size and attached using ultra strong rivets, providing a quick and secure method of installation.

Our range of Easirail handrail is a fully DDA compliant, stand-alone handrail system with a warm-to-touch powder coated finish. The riveted fixing system creates a seamless and elegant installation suitable for all environments.

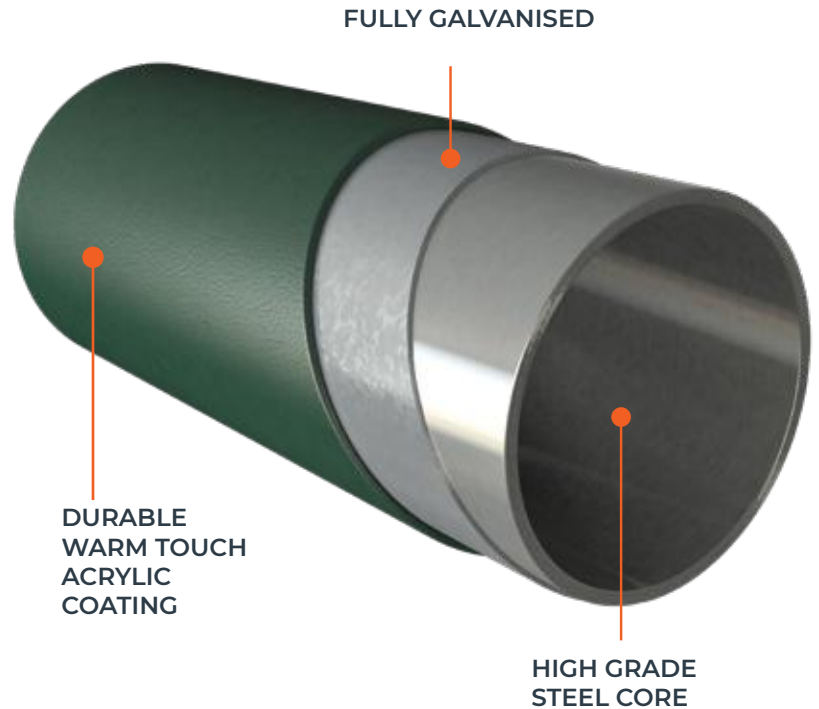

FEATURES AND BENEFITS

<p>WARM TOUCH ACRYLIC COATING</p>	<p>ADJUSTABLE BRACKETS FOR FLEXIBILITY</p>	<p>EASILY INCORPORATES A 600MM MIDRAIL</p>	<p>SURFACE MOUNTED OR FIXED USING CONCRETE</p>	<p>SATISFIES BUILDING REGULATIONS AND GUIDANCE</p>
<p>STRONG CONSTRUCTION AND TESTED COMPONENTS</p>	<p>PROVIDES A CONTINUOUS 42MM DIAMETER HANDRAIL</p>	<p>QUICK AND EASY TO INSTALL WITH NO PAINTING REQUIRED</p>	<p>FULLY GALVANISED PROVIDING AN EFFECTIVE CORROSION RESISTANT FINISH</p>	

SERVICE

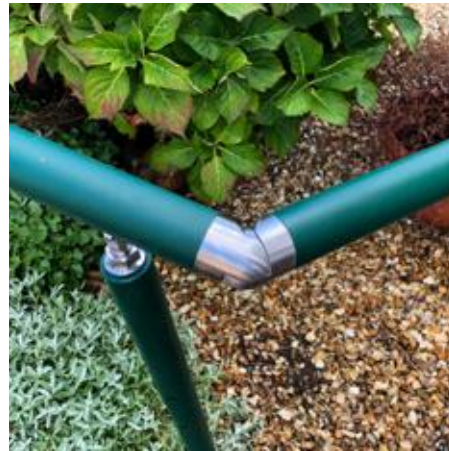

SUPPLY ONLY OR SERVICE AND SUPPLY

Available as supply only or on a supply and install basis, Flocon guarantees an excellent service provision from start to completion of your project.

Our Sales and Service team are able to assist you from initial enquiry and supply, through to installation and after sales support.

Our knowledgeable team can advise the correct specification of equipment for the type of configuration you need to install.

Should you require a full installation service, Flocon works in conjunction with specialist Easirail contractors that have a wealth of experience in access solutions, from individual homes to large scale refurbishments.

Easirail installation teams are efficient and thorough, ensuring that every installation is conducted with minimum disruption and that the area is left clean and tidy. All Easirail configurations are ready for use immediately after installation.

DISTRIBUTION

Flocon has extensive warehousing capabilities, allowing for a comprehensive stock inventory of Easirail to be held on site.

This enables us to cater for all of your Easirail requirements, with the aim of dispatching handrailing and fittings to you within a maximum of 48 hours.

For those that wish to collect, our trade counter is open 7am until 5pm Monday-Friday, 8am till 11am Saturdays.

PRODUCT SPECIFICATION

EASIRAIL HANDRAIL

Our 42mm handrail tube is attached directly to the posts and brackets using 4.8mm domed rivets providing a quick, strong and tamper resistant method of attachment. Additional rivets can be used to provide enhanced security, if required.

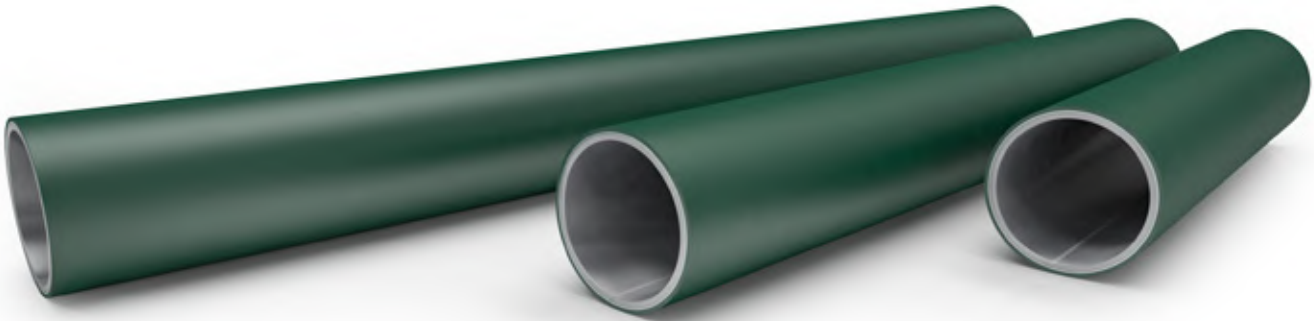

CODE	DESCRIPTION	BOX QTY
H1	100mm Handrail - provides a simple termination with a CCON and HEC	20
H2	200mm handrail	20
H3	300mm handrail	20
H4	400mm handrail	20
H5	500mm handrail	10
H6	600mm handrail	10
H7	700mm handrail	10
H8	800mm handrail	10
H9	900mm handrail	10
H10	1000mm handrail	10
H11	1100mm handrail	10
H12	1200mm handrail	10
H15	1500mm handrail	5
H20	2000mm handrail	5
H30	3000mm handrail	5

EASIRAIL CAPS

The handrail tube is used in conjunction with the range of connectors and end caps, which either have a friction fit or are glued into position.



HEC
HANDRAIL END CAP

Inserts into the open end of the rail

BOX QTY: 40



VHEC
VINYL END CAP

Covers the open end of a handrail

BOX QTY: 40

STEP KITS

EASIRAIL WALL TO FLOOR STEP KITS

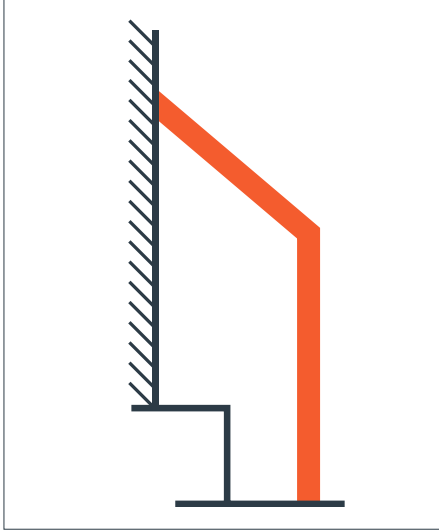

ER-WF1

WALL TO FLOOR 1 STEP KIT

Wall to floor handrail to fit single step projecting 270mm - 300mm

Kit includes ER-VP9T, UCON, H5, ER-SBKT, HEC, X2 Rivets and small glue

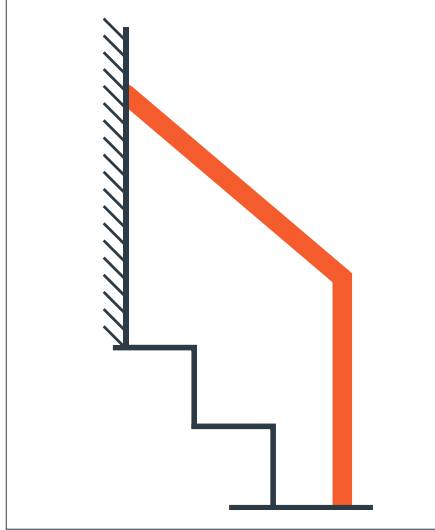

ER-WF2

WALL TO FLOOR 2 STEP KIT

Wall to floor handrail to fit two steps projecting 540mm-600mm

Kit includes ER-VP9T, UCON, H8, ER-SBKT, HEC, X2 Rivets and small glue

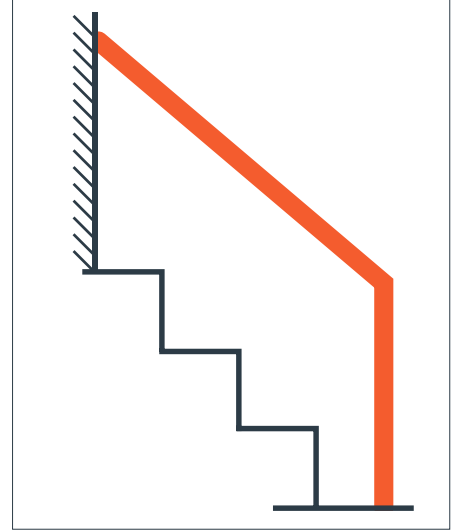

ER-WF3

WALL TO FLOOR 3 STEP KIT

Wall to floor handrail to fit three steps projecting 820mm-900mm

Kit includes ER-VP9T, UCON, H11, ER-SBKT, X2 Rivets and small glue

EASIRAIL FLOOR TO FLOOR STEP KITS

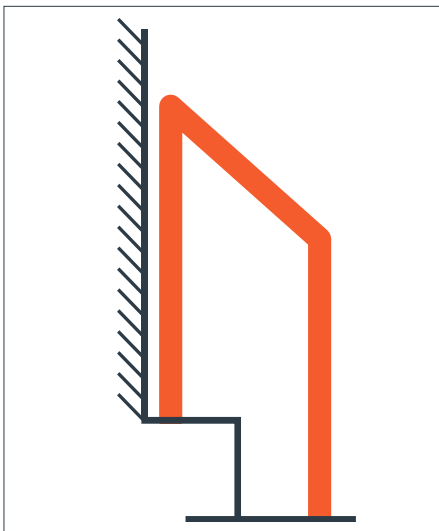

ER-FF1

FLOOR TO FLOOR 1 STEP KIT

Floor to floor handrail to fit single step projecting 270mm — 300mm

Kit includes ER-VP9T, ER-VP9, UCON, H5, HEC, x2 rivets and small glue

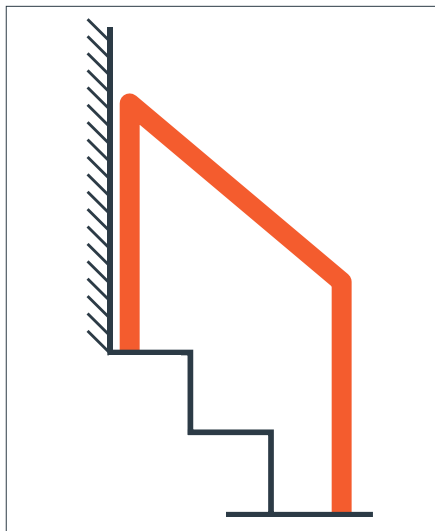

ER-FF2

FLOOR TO FLOOR 2 STEP KIT

Floor to floor handrail to fit two steps projecting 540mm — 600mm

Kit includes ER-VP9T, ER-VP9, UCON, H8, HEC, x2 rivets and small glue

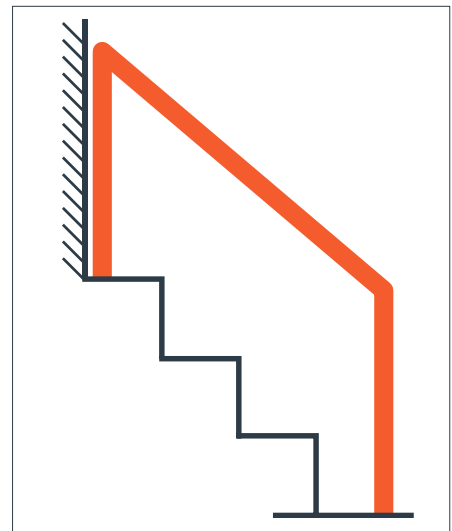

ER-FF3

FLOOR TO FLOOR 3 STEP KIT

Floor to floor handrail to fit three steps projecting 820mm — 900mm

Kit includes ER-VP9T, ER-VP9, UCON, H11, HEC, x2 rivets and small glue

EASIRAIL BRACKETS

The range of brackets provide the ability to attach a handrail to the wall, vertically or horizontally whilst the midrail brackets attaches to the adjustable posts creating a 600mm high midrail.



ER-HBKT
HANDRAIL BRACKET

Attaches rail to a wall allowing horizontal angle adjustment

Requires x3 wall fixings (not included)

BOX QTY: 20



ER-SPBKT
WALL BRACKET

Attaches rail to a wall in fixed positions

Requires x4 wall fixings (not included)

BOX QTY: 20



ER-MBKT
MIDRAIL BRACKET

Attaches to a vertical post providing a 600mm high midrail

Requires x2 wall fixings (not included)

BOX QTY: 20



ER-MINI-SPBKT
WALL BRACKET

Attaches rail to a wall in fixed positions

Requires x2 wall fixings (not included)

BOX QTY: 20



ER-SBKT
STEP BRACKET

Attaches rail a wall allowing vertical angle adjustment

Requires x2 wall fixings (not included)

BOX QTY: 20



ER-SBKL
HANDRAIL BRACKET LEFT

Attaches rail to a wall offset, for ease of use

Requires x3 wall fixings (not included)

BOX QTY: 20



ER-SBKR
HANDRAIL BRACKET RIGHT

Attaches rail to a wall offset, for ease of use

Requires x3 wall fixings (not included)

BOX QTY: 20

POSTS AND CONNECTORS

EASIRAIL POSTS



ER-VP9T
VERTICAL TERMINATION
POST

900mm handrail post
screwed/bolted directly to
the floor



ER-VP9/VP14/VP18
VERTICAL POST

Provides termination
of a 900mm, 1400mm
or 1800mm handrail
straight to ground;
screwed/bolted
directly to the floor

EASIRAIL STAINLESS STEEL CONNECTORS

Stainless steel connectors are precision manufactured from an external grade material ensuring longevity and are simply glued into position, providing an extremely strong fix.



SWCON
STEP WALL CONNECTOR
Connecting rails at an angle to a wall

BOX QTY: 5

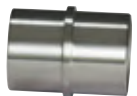

SSCON
STRAIGHT CONNECTOR
Connecting two straight rails

BOX QTY: 5



CTCON
CORNER TEE CONNECTOR
Connecting rails at 90° and a post

BOX QTY: 5



UCON
UNIVERSAL CONNECTOR
90-180°

BOX QTY: 5



MCON
MULTI ANGLE CONNECTOR
Connecting a post and rails at a horizontal
and vertical angle

BOX QTY: 5



IMCON
INLINE CONNECTOR
Providing an in-line midrail or
post extension

BOX QTY: 5

EASIRAIL STANDARD CONNECTORS

The standard connectors provide a friction fit and are manufactured from a UV resistant, hard wearing thermoplastic outer cover and nylon inner collar.



ACON
ANGLE CONNECTOR

Connecting rails that
meet at an angle (~1:12)

BOX QTY: 10



CCON
CORNER CONNECTOR

Connecting rails that
meet at 90°

BOX QTY: 10



SCON
STRAIGHT CONNECTOR

Connecting straight rails

BOX QTY: 10



WCON
WALL CONNECTOR

Connecting rails to the
wall

BOX QTY: 10

EASIRAIL ACCESSORIES

The Easirail handrail system includes a multitude of accessories to assist with any installation. Please see a list of some of them below.

CODE	DESCRIPTION
ER-SGHV	Easiaccess quick set glue (50ml)
GREASE	Grease 400ml - for use when installing rails with rivets
SPRAY	RAL matched spray 6005 or 9005
RVT	Stainless steel domed head ultra-strong rivets
FFXN	Floor fixing – Concrete Anchor Bolt HUS-V 8x95 HILTI
WFXN	Wall Fixing – Concrete screw fixing HUS 6x45 HILTI



SPRAY
RAL MATCHED SPRAY
Available in RAL 6005 or 9005



RVT
ULTRA STRONG RIVETS
Stainless steel domed head



ER-SGHV
QUICKSET GLUE
Easiaccess quick set glue (50ml)



FFXN
FLOOR FIXING
Concrete Anchor Bolt HUS-V 8x95 HILTI



GREASE
400ML GREASE
For when installing rails with rivets



WFXN
WALL FIXING
Concrete screw fixing HUS 6x45 HILTI



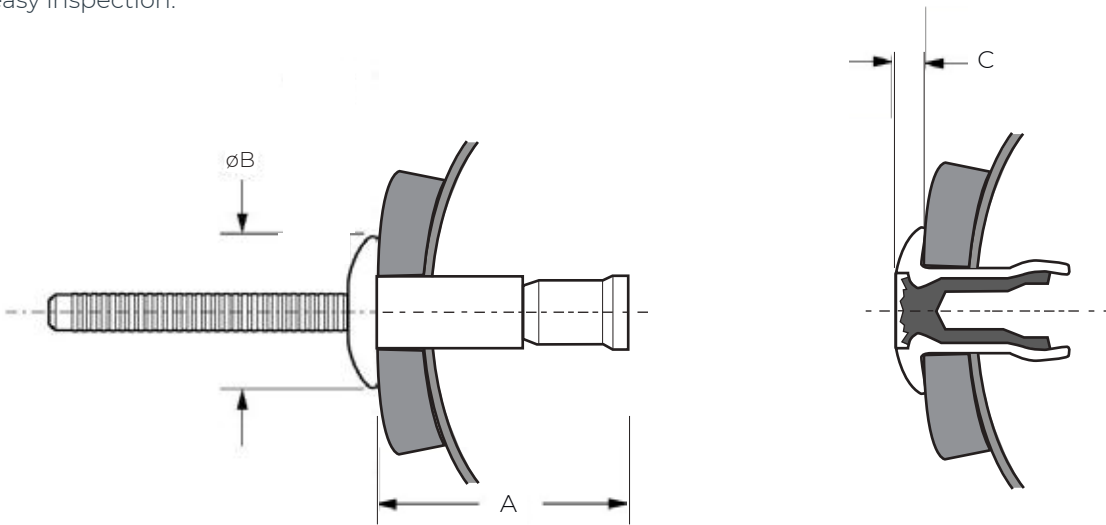

DOMED HEAD STRUCTURAL RIVET

Our rivets are multi-grip structural break-stem fasteners, providing a fully sealed joint and visible lock for quick and easy inspection.



Body: Stainless steel

Stem: Stainless steel

Rivet Size					A	øB	C	 kN	 kN
	min.	max.	min.	max.					
4.8	1.5	6.8	4.9	5.1	18.5	9.7	1.8	5.8	5.0

Measurements in millimetres unless otherwise stated.

Key Features

- Excellent hole fill via radially expanded body provides very strong, vibration resistant joints and compensates for irregular, oversized, slotted or misaligned holes
- Good sheet take-up performance for large gap closing capability
- Stem mechanically locked into body avoids damage, electrical problems or rattling caused by loose stems
- Multi-grip capability
- High shear and tensile strength
- Visible lock for quick and easy inspection
- Stainless steel for effective corrosion resistance

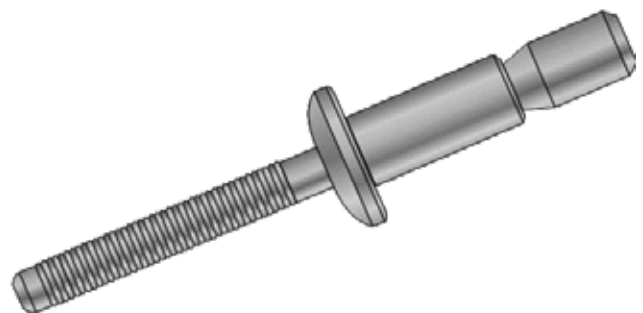

BEST PRACTICE INSTALLATION GUIDE

With any installation that requires fixing to a wall or floor, an evaluation must be made on site as to the structural integrity of the surface that will provide the strength, be it a wall, floor, step or other.

As a general rule and in all circumstances, we suggest setting posts no more than 1200mm apart. This distance can be reduced in high traffic areas or to accommodate specific client and/or environmental considerations.

Domestic Regulations

Over steps, a handrail should be between 850-1000mm from the pitch line of the flight and extending a minimum of 300mm beyond the top and bottom step. Over ramps, the vertical height to the top of the handrail from the surface of the ramp is between 900mm and 1000mm.

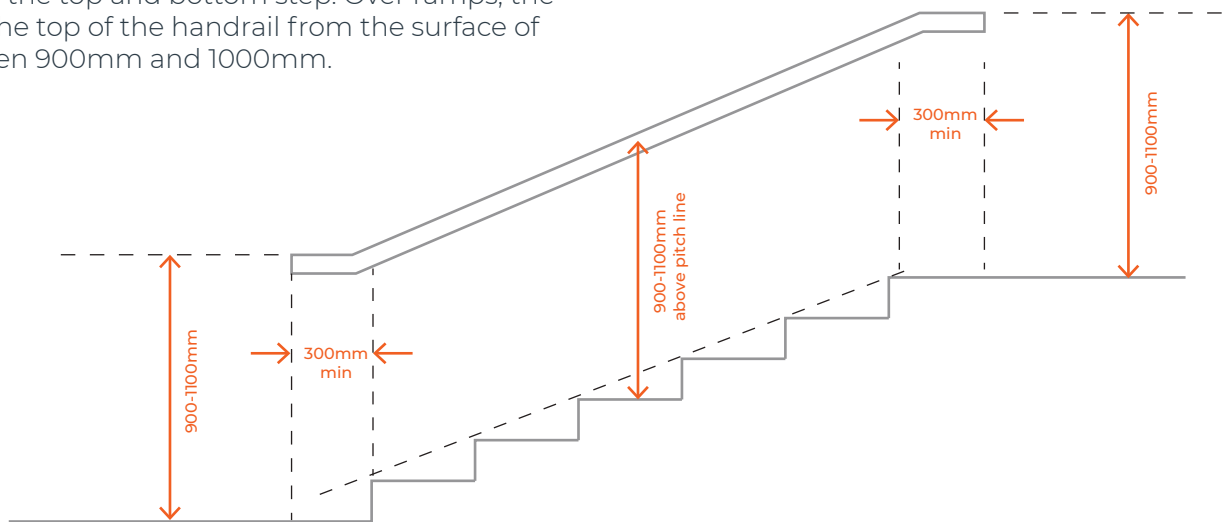

Public Access Regulations

The vertical height to the top of the handrail, above the pitch line of the steps or ramp surface, must be between 900mm and 1000mm.

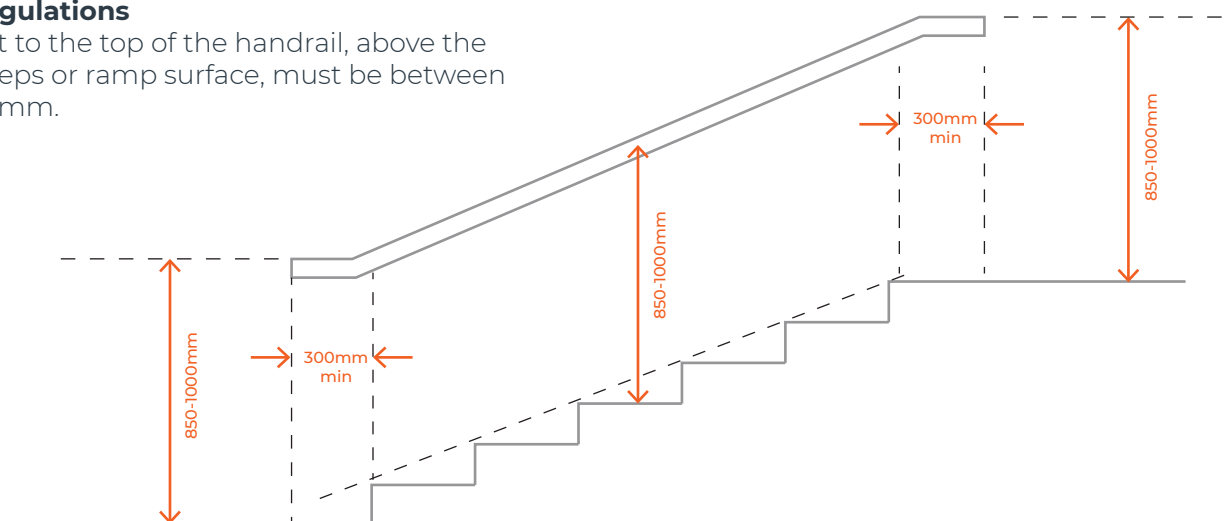

INSTALLATION

Concrete/Core Drilling

Core drill using 50-60mm bit to the depth of at least 250mm. Set post in concrete/postcrete. *

Concrete - Floor Fixing

Mark and drill holes and use suitable exterior grade fixings through base plates of posts. Avoid drilling near edges as this may cause cracking of concrete. We recommend using galvanised threaded concrete bolts or anchor bolts.

Tarmac - Core Drilling

Core drill using 50-60mm bit to the depth of at least 300mm. Set post in concrete/postcrete. Proceed with caution when core drilling into tarmac as the quality of the tarmac can vary significantly. If unsure, proceed with the following installation method. *

Tarmac - Digging/Sawing

Cut a square with a concrete cutting saw and dig down to a minimum of 300mm, fill the hole with concrete/postcrete to secure. Easiaccess use a black dye to match with tarmac.

Flags - Core Drilling

Core drill using 50-60mm bit to the depth of at least 300mm. Set post in concrete/postcrete.*

Flags - Floor Fixing

For this option, the flag size must be a minimum of 600 x 600 x 50mm. Ensure flag is in a good condition and is firmly secured. In this situation, Easiaccess would use a galvanised threaded concrete bolt or anchor bolt, taking care when drilling and tightening, to avoid breaking the flag.

Block Paving

To set into ground, remove at least two blocks and dig down to a minimum of 300mm to achieve a good fixing, concrete/postcrete in place. Dye concrete to match block paving.

Bricks - Core Drilling

Core drill using 50-50mm bit. Drill through to a minimum depth to catch second course and set post in concrete/postcrete. *

Soft Ground

Dig down to a minimum of 300mm, tap post into clay/ground and fill hole with concrete/postcrete. Ensure concrete/postcrete is mixed well and to the correct ratios.

Wall Fixing

Ensure wall is flat and in sound condition and use suitable exterior fixings. The plate for the wall bracket will accept up to an 8m fixing and we recommend a minimum of 60mm long fixing to secure.

Choosing Fixings

There is not a single solution for fixings, as what might work on one surface may not be suitable for another. Always use a fixing that is rated for external use and is fit for purpose. Seek advice if unsure and refer to the product specification/guidance for the fixing under consideration.

Flocon uses the following chemical anchor/resin to secure the posts in combination with concrete/postcrete; FISCHER FIS VT VINYLESTER CHEMICAL MORTAR RESIN

For all our external screws/bolts we use HILTI fixings.

* N.B. Optional when core-drilling

Leave around 40-50mm space at the top and then fill remainder of the hole with an exterior grade fast set resin, leaving an ultra-strong and neat finish.

ABOUT FLOCON



Flocon is one of South Wales' leading distributors of products and supplies that are essential to the pipeline industry.

With hundreds of customers scattered the length and breadth of the country, we support all types of industry sectors from utilities suppliers to manufacturing companies, and hospitals to dairy farms.

We endeavour to provide a high-level service and attention to detail at every aspect of our business, ensuring that all our customers' needs and requirements are fulfilled to the best possible standard.

Our approach is based on a one-to-one bespoke service, delivering excellent value for money to all companies and organisations that trade with us, large and small.

WHAT WE OFFER

- **Excellent technical advice:** Over 150 years of pipeline industry experience
- **Site visits:** Should you need to meet with our team and discuss a project on a 1-2-1 level, we're able to meet you on site at a time that's convenient for you
- **High quality products from leading industry suppliers:** From George Fischer to Spirax Sarco, Pegler Yorkshire to Albion
- **Pre and Post-sales support:** Customer service excellence at the heart of everything we do
- **Specialist sourcing solutions:** Our sourcing services means we can offer a comprehensive supply of all valves, pipes fittings and associated products to meet a customers' project needs
- **Tailored account services:** Flexible and reliable account management tailored to your needs, delivering what you want, when you want it.
- **Fast delivery times:** Same day, overnight and Saturday deliveries





FOR MORE INFORMATION ABOUT FLOCON HANDRAIL SYSTEMS OR ANY OTHER FLOCON PRODUCTS AND SERVICES, CONTACT US ON:

01443 841 666 | Sales@flocon.co.uk | flocon.co.uk

FLOCON VALVES & FITTINGS LTD
Unit D8.3, Main Avenue, Treforest
Industrial Estate, Pontypridd, CF37 5UR



ISO 9001 Cert No 17368