









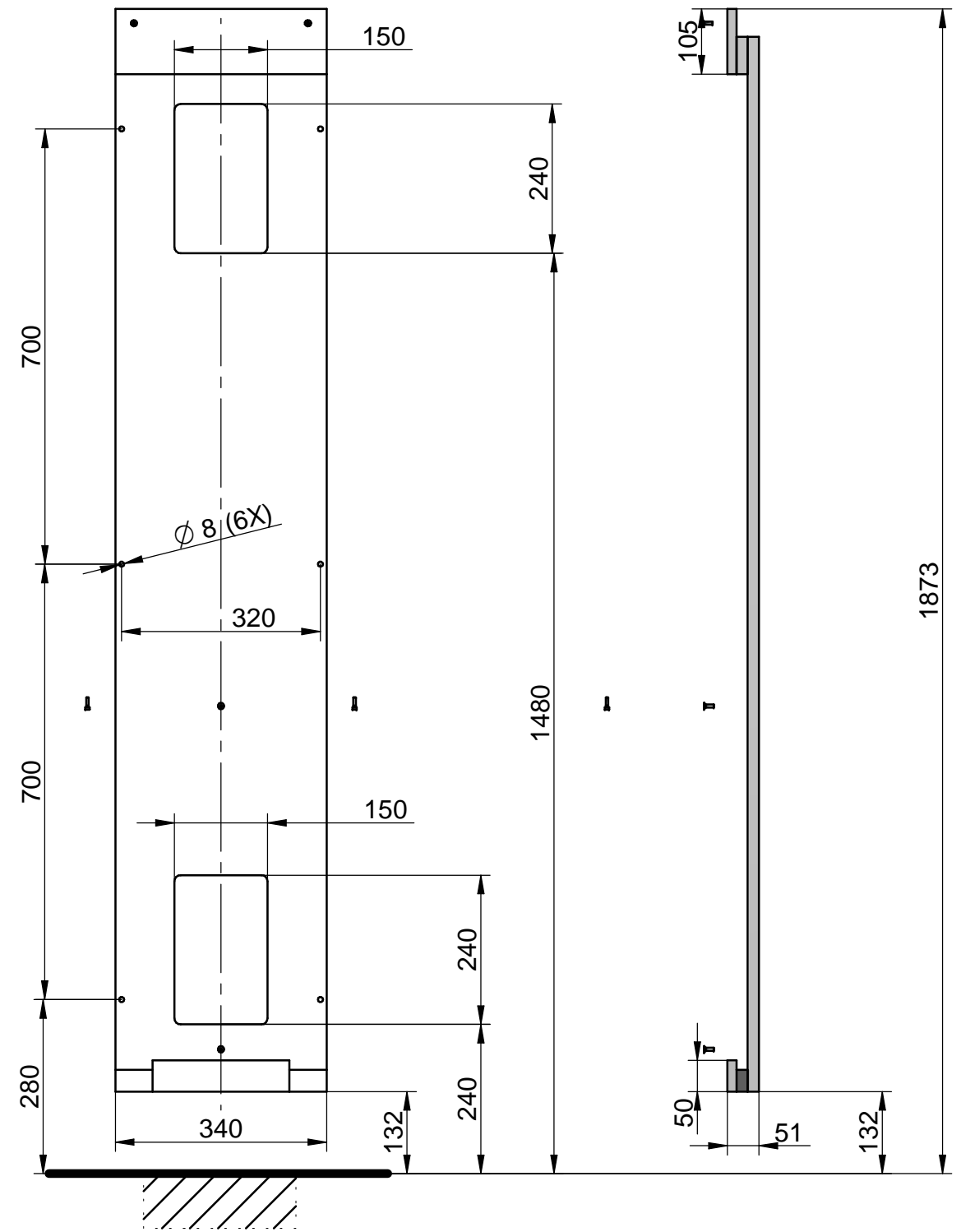
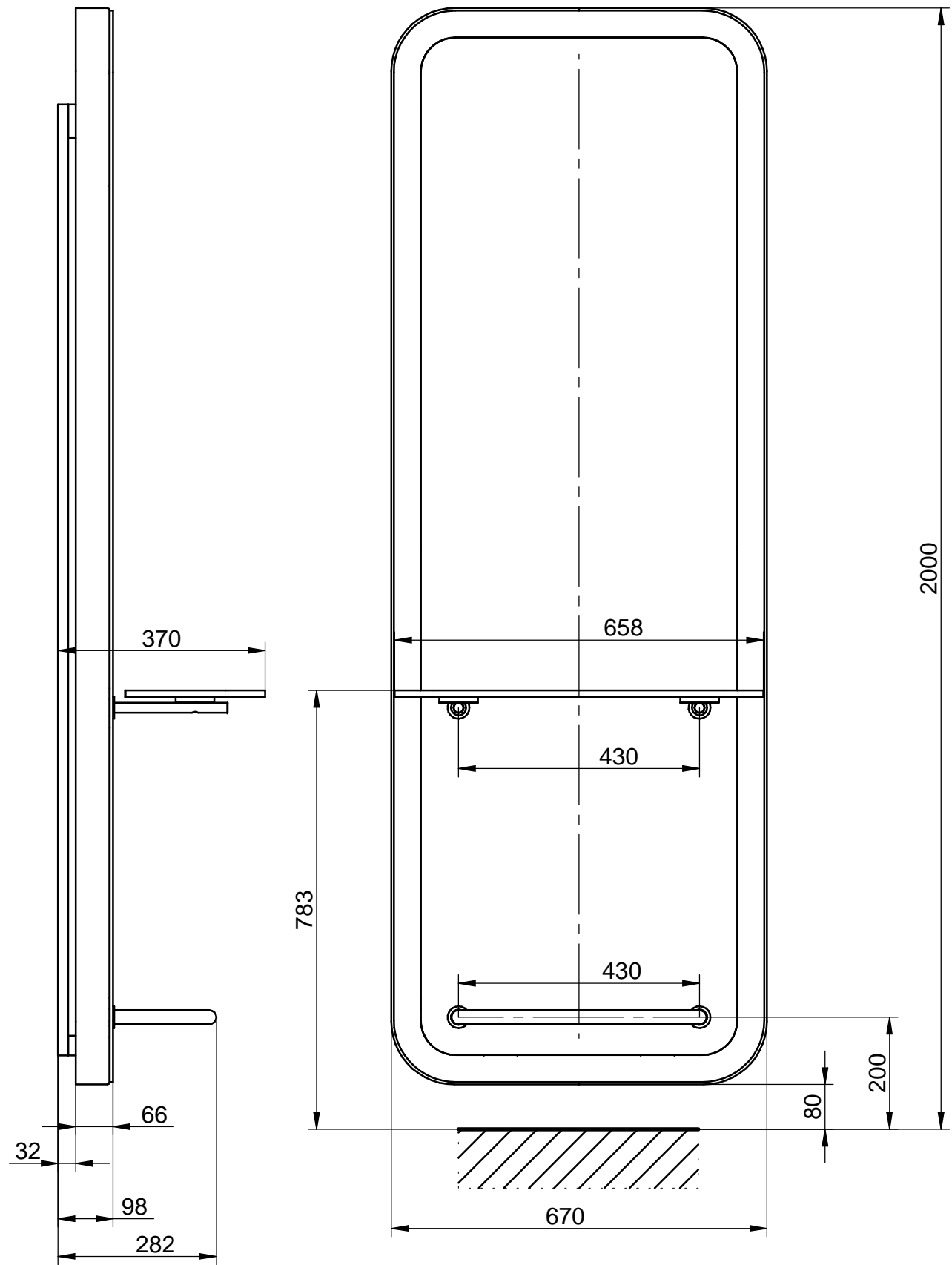

12	1	Glasblad compleet Belluna SU		03.BEST.05.00	
11	4	Kraagbus Belluna Styling Unit	POM	03.BEST.00.03	
10	1	Spiegel Belluna Style compleet		00.BEST.06.00	
9	1	Muurophang Belluna SU		00.BEST.03.00	
8	1	Voetensteun Belluna SU		00.BEST.02.00	
7	1	Frame Belluna Styling Unit		00.BEST.01.00	
6	2	Glasbladdrager Belluna SU	AISI 304 [1.4301]	00.BEST.00.04	
5	2	cil. kop schroef M4x16	elvz		
4	4	platverzonken schroef BZK M6x16	elvz		
3	2	Excentrische spiegelschijf			
2	4	platverz.schroef bzk M8x20	elvz		
1	2	Magneet rond 45	RSt. 37-2		
stuknr	aantal	benaming	materiaal	tekening nr	opmerkingen

		Benaming Belluna Styling Unit			A3
		Materiaal	Name?:Halffabrikaat		Schaal
		Finish Name?:Finish	Opmerking		1:1
		Datum 17-06-2014	 METAALWARENFABRIEK B.V. Driebruggen		Tolerantie NEN-ISO 1101, 406 NEN 3634 EENH:mm
		Naam tekenaar ad heykoop			
		Goedgekeurd op	Proj. Am.	Tekeningnummer	Blad 1 van 3
Uitgave	Wijziging	Door	 	00.BEST.00.00	

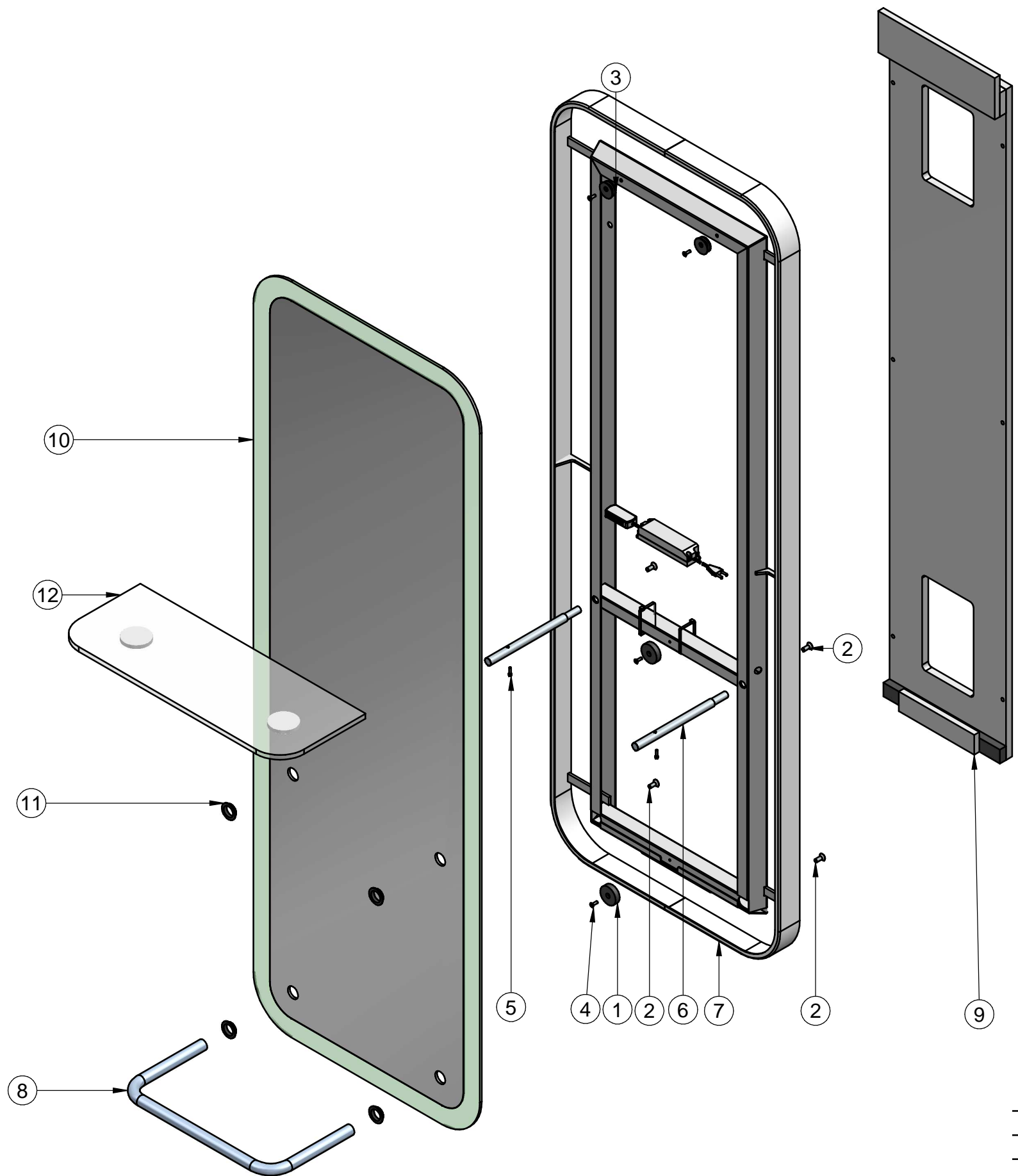

		Benaming Belluna Styling Unit		A3
		Materiaal	Name?:Halffabrikaat	Schaal
		Finish Name?:Finish	Opmerking	1:1
		Datum 17-06-2014	 METAALWARENFABRIEK B.V. Driebruggen	Tolerantie
		Naam tekenaar ad heykoop		NEN-ISO 1101, 406 NEN 3634 EENH:mm
		Goedgekeurd op	Proj. Am.	Tekeningnummer
Uitgave	Wijziging	Door	  00.BEST.00.00	Blad 2 van 3



Benaming		Belluna Styling Unit		A3
Materiaal	Finish	Name?:Halffabrikaat	Opmerking	Schaal
				1:1
Datum	17-06-2014	 METAALWARENFABRIEK B.V. Driebruggen		Tolerantie
Naam tekenaar	ad heykoop	Proj. Am.	Tekeningnummer	NEN-ISO 1101, 406
Goedgekeurd op		 	00.BEST.00.00	NEN 3634
Uitgave	Wijziging	Door		EENH:mm
				Blad 3 van 3