

WATER WHOOSH™

Owner's Manual



WWW.RAVESPORTS.COM

Copyright © 2021

All rights reserved. No part of this publication may be reproduced or transmitted in any form or by any means, electronic or mechanical, including photocopy, recording, or any information storage and retrieval system, without permission in writing from the publisher. Requests should be mailed to RAVE Sports, 985 Aldrin Drive #301 Eagan, MN 55121. 800.659.0790

Table of Contents:

Parts	1
Introduction	2
Safety rules & information	3
Water Whoosh 10	6
Water Whoosh 15	7
Water Whoosh 20.....	8
Assembling your Water Whoosh	9
Connecting to Activity Island	11
Connecting to Aqua Jump Eclipse/Bongo	14
Connecting Water Whooshes together	17
Folding.....	19
Cleaning & storage.....	20
Repairs	21

Date Purchased: _____

Purchased from: _____

Serial Number: _____

(Serial # is located next to the inflation valve on the tube.)

Package Contents:

- Qty 1- Water Whoosh 20 or Whoosh 15 or Whoosh 10
- Qty 1- Double Action Hand Pump
- Qty 1- Repair Kit, owner manual, warranty card

Introduction

Thank you for purchasing a RAVE Sports® Water Whoosh. This Owner's Manual is presented to enhance your enjoyment of the sport and is intended to alert you to some of the potentially dangerous conditions that can arise in all water sports. It also contains important safety instructions and information about how to assemble, use and care for your product.

Please take a few minutes to read this manual before assembling and using the product. Although the product is simple to use, this manual contains important safety information that you and all users must understand to safely enjoy the Water Whoosh.

Make sure that everyone who uses the product also receives proper education and supervision and understands the safety instructions and warnings presented in this manual. Be sure to save this manual for future reference.

IMPORTANT: This Water Whoosh was designed to be used stand-alone or as an attachment to other RAVE Sports products described in this manual. Do not attempt to attach or use it in any other manner than its designed and intended use as described herein.

If you have any questions regarding this product, please call RAVE Sports at 1-800-659-0790 or visit www.ravesports.com. Please have your serial number available.

! WARNING

UNSAFE USE OF THE WATER WHOOSH CAN RESULT IN PERSONAL INJURY OR DEATH.

TO REDUCE THE RISK OF INJURY, READ AND FOLLOW ALL INSTRUCTIONS AND WARNINGS IN THIS MANUAL. DO NOT USE THIS PRODUCT UNLESS YOU UNDERSTAND AND ACCEPT THE RISK OF INJURY INVOLVED WITH THIS ACTIVITY.

Safety Rules and Information

- Read and understand all of the information contained in this owner's manual before assembling and using your product.
- Make sure that everyone who uses the product is provided with and understands these safety rules and information.
- The Water Whoosh is designed to be used on large bodies of water with depth of at least 5 feet (1.5m) of water. Do not use or allow anyone else to use the product on land, any other hard surface or in recreational swimming pools.
- Choose a location for your product that is most protected from wind, of sufficient water depth, and free of obstructions in all directions.
- Always anchor the Water Whoosh securely before use.
- Always wear a U.S. Coast Guard approved Type III personal flotation device (PFD) when using the Water Whoosh.

- Never use the product after sunset, before dawn, or any other time in poor lighting conditions.
- Never use the product in rough surface water conditions, during storms, or when there is lightning. If an unexpected storm arises while using the product, seek shelter on shore. Do not stay on the product.
- Never use the product under the influence of alcohol or drugs.
- Do not connect directly to docks, piers or other hard objects.
- Always use the protective adaptor apron and proper connection straps when connecting to other RAVE Sports inflatables.
- Never tow from a boat or other motorized vehicle.
- To avoid the possibility of a collision, make sure the area around the Water Whoosh is clear of obstructions and other swimmers before each use.
- Drowning Hazard: Never swim or play under the Water Whoosh.
- Never use the product while tired or fatigued. Use extreme caution while swimming between the shore and the product. Do not attempt to swim this distance if you are tired or fatigued.
- Always inspect the areas around and under the product before each use to ensure the water is deep enough and free of all rocks, logs, sand bars, and underwater obstructions and that the product is a safe distance from above water hard objects.
- Ask about local water conditions before using the product in unfamiliar water.

- Inspect your product for any worn, defective, or missing parts. Do not use if there are any signs of damage, wear or deterioration. Replace or repair before use.
- Never dive off the product head first. If jumping off the product, always enter the water feet first.
- Not recommended for children under the age of six. Use the Water Whoosh only under mature, knowledgeable adult supervision.
- The surface of the Water Whoosh will get wet and slippery. Always exercise caution and common sense while using the Water Whoosh. Reckless behavior may result in serious injury.
- The use of the device by children shall be under constant adult supervision.
- Do not attempt or allow flips, somersaults or other acrobatic maneuvers. Landing on the head or neck can cause serious injury, paralysis or death.
- Do not use in shark infested water or in water that may contain other marine life dangerous to humans.
- When not in use, secure the product against unauthorized or unsupervised use.
- This device is not designed to be used as a life saving device.

Water Whoosh 10

(Items #02827 & #02973)

Product	Minimum Water Depth	Maximum Capacity	Maximum Weight	Working Pressure
Water Whoosh 10	5ft (1.5m)	8 Users	800lb (362kg)	5psi (0,34bar)



Water Whoosh 15

(Item #02828 & #02974)

Product	Minimum Water Depth	Maximum Capacity	Maximum Weight	Working Pressure
Water Whoosh 15	5ft (1.5m)	11 Users	1150lb (521kg)	5psi (0,34bar)



Water Whoosh 20

(Item #02829 & #02975)

Product	Minimum Water Depth	Maximum Capacity	Maximum Weight	Working Pressure
Water Whoosh 20	5ft (1.5m)	14 Users	1500lb (680kg)	5 psi (0,34bar)



Liability

While every attempt is made to embody the highest degree of protection in all equipment, we cannot guarantee freedom from injury. The user assumes all risk of injury due to use. All merchandise is sold on this condition, which no representative of the company can waiver or change.

Assembling your Water Whoosh

Inflation

Roll out the Water Whoosh on flat ground. Make sure the area is free of rocks, sticks or other sharp objects that could puncture or damage the product.

Use the enclosed hand pump to inflate the Water Whoosh, or for more rapid inflation and deflation we recommend using the RAVE High Speed Inflator/Deflator. (*Item #01083, not included; sold separately at www.ravesports.com*)



To lock open valve, depress the stem and rotate $\frac{1}{4}$ turn clockwise. To close valve, depress the stem and rotate $\frac{1}{4}$ turn counter-clockwise. The valve stem should be in the depressed position while inflating. Replace cap on valve after inflation to ensure air tight seal.

If you are using the RAVE Sports High Speed Inflator (*Item #01083*), simply lock the adaptor onto the end of the inflation hose and insert into the valve body. Turn $\frac{1}{4}$ turn to lock in place.



To check the exact pressure of your product the use of a RAVE Digital Pressure Gauge (*Item #02809, sold separately on www.ravesports.com*) is recommended.

NOTE: This inflation adaptor will automatically open the valve when inserted and will close the valve when removed. You do not need to manually open/close the valve when using this special adaptor.

Inflate until firm. The high speed inflator will inflate the mat to approx. 2.0-2.5psi (0,14-0,17 bar). This is a good inflation pressure for 1-3 users. Increasing the air pressure beyond this will provide a more rigid unit capable of supporting the weight of more users. Use the enclosed hand pump to top off to the desired air pressure. If you first inflated with the RAVE High Speed Inflator, adding approx. 50 strokes of the hand pump will increase the air pressure to 5psi (0,34 bar) which is sufficient for a large number of users. **DO NOT INFLATE BEYOND 10PSI (0,69 bar) to avoid damage.**

Move to Water

Use 2 or more people to carry the product to the water.

CAUTION: To avoid risk of puncture or damage to the product, **DO NOT DRAG the product.** Always carry it to the water. Float the Water Whoosh™ to the desired location for anchoring.

Anchoring

There are two anchor attachment points (one at each end on the bottom) of the Water Whoosh 20 and Whoosh 15. On the Whoosh 10, there is only one anchor attachment point. Attach anchor(s) to those points to prevent the wind from swinging the product to an undesirable direction.

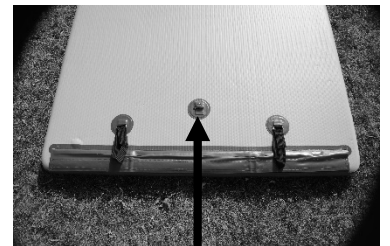

Anchor Point

The Water Whoosh is now ready for use!

To Deflate:

Rapid deflation can be achieved using the “deflate” side of the motor housing. Attach the hose to the deflate side of the motor housing and lock the valve adaptor into the valve.

Using the Water Whoosh™

CAUTION! The surface of the Water Whoosh can become wet and slippery. Refrain from horseplay or other activity that could cause collisions and falls, resulting in injury.

⚠ WARNING: DROWNING HAZARD

NEVER ATTEMPT TO SWIM UNDER THE WATER WHOOSH.
THE WATER WHOOSH IS A LARGE OBJECT ON THE WATER WITH
NO PLACE TO COME UP FOR AIR IF YOU ARE BENEATH IT.

The Water Whoosh is designed to be used as a stand alone product or can be attached to various other RAVE Sports products. If you intend to connect the Water Whoosh to other RAVE Sports products, it may be necessary to purchase a separate connection kit. The larger sizes of RAVE Sports Bongo Bouncers and Aqua Jump Eclipse water trampolines produced in 2017 and after have Velcro strap connectors included. Check on the year and size of your bouncer or trampoline to know if it requires a separate connector kit.

Connecting to a RAVE Activity Island:

Use Activity Island Attachment Kit (Item #02475), purchased separately.

One kit is needed to attach one end of the Water Whoosh to the Activity Island.

Contents of this kit:

- 1-Adaptor Apron
- 2-Connection Straps



Step 1

Attach the long side of the adaptor apron to the underside Velcro® flap of the Water Whoosh.

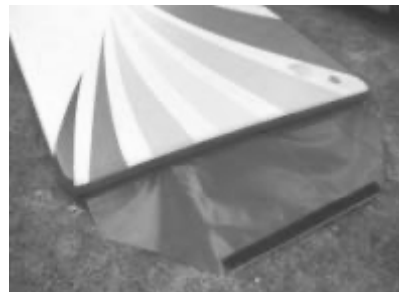

Step 2

Float Water Whoosh up to one of the four sides of Activity Island containing the connection rings and flap.



Step 3

Using the two buckle straps provided, attach the Water Whoosh to Activity Island. Loosely attach both straps to the underside rings of the Water Whoosh and Activity Island (feed the strap through the rings and then through the ladder buckle) Repeat for both straps.

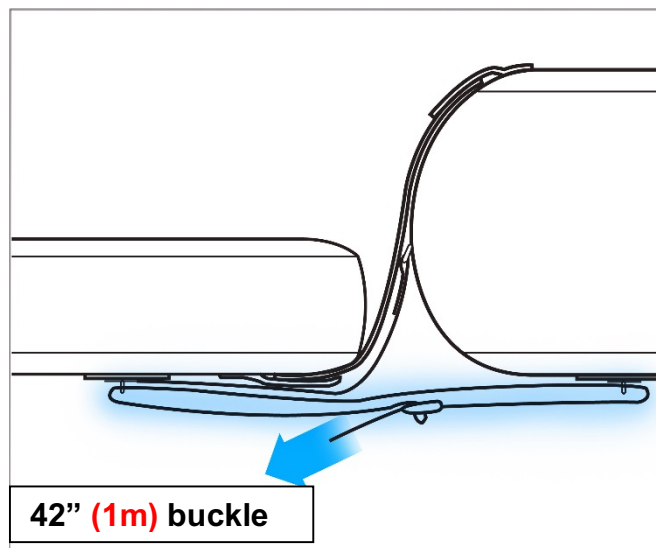

Step 4

Make sure the adaptor apron and the Velcro straps (smaller straps) are folded over the top of the Water Whoosh surface.

Step 5

Pull both Velcro straps (smaller fixed straps on bottom of Water Whoosh) through both of the outside rings on the edge of Activity



Island and affix the Velcro strap on itself by folding the strap together. Close the Velcro side flaps to lock it in place.

Step 6

Pull the Whoosh mat tight to the Activity Island by tightening the bottom two buckle straps.

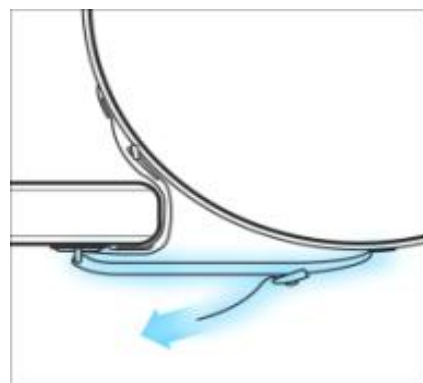

Step 7

Open the long-Velcro flap on the edge of Activity Island.

Attach the adaptor apron to the Activity Island and fold the top flap down over the adaptor apron. Run hand across entire flap to ensure it is securely fastened and smooth.



Anchor far end of Water Whoosh mat and enjoy!

Connecting to RAVE Aqua Jump Eclipse/Bongo products:

NOTE: The Water Whoosh can be attached to RAVE Sports water trampoline & bouncer products.

26" high products- Includes Aqua Jump Eclipse 120, Bongo 10, & Bongo 13

Use #26 Adaptor Kit, item #02473, sold separately (one kit is needed to attach one end of Water Whoosh).

Contents of this kit:

1. – 1, #26 Adaptor strap assembly
2. – 1, Adaptor apron

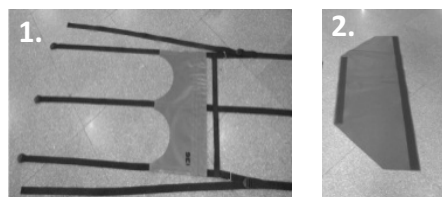

36" high products**- Includes Aqua Jump Eclipse 150, Aqua Jump Eclipse 200, Classic AJ25, , Bongo15, & Bongo20**

NOTE: ***If connecting Water Whoosh to these products, please contact RAVE Customer Service first as newer models of these products have the Water Whoosh Velcro strap connections built right into the tubes and the #36 Adaptor Kit is not necessary.*

Use #36 Adaptor Kit, item #02474, sold separately (one kit is needed to attach one end of Water Whoosh).

Contents of this kit:

1. – 1, #36 Adaptor strap assembly
2. – 1, Adaptor apron

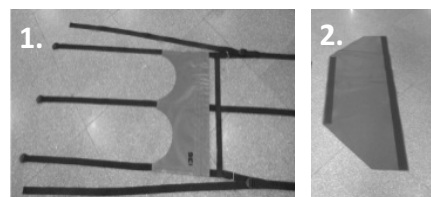

Important: Make sure that you use the right adaptor kit that corresponds to the size of the product you want to connect to.

Step 1

Inflate your Aqua Jump or Bongo product(s).

Step 2

Attach Adaptor Strap to your product. Position adaptor straps on the desired section of your Aqua Jump/Bongo and orient so the Velcro flap is facing downward (arrow will be facing up).

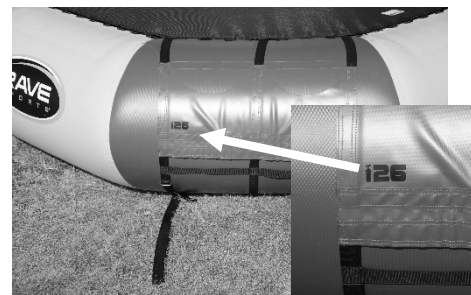

Position all three ladder buckles so they are directly over the inside seam line of your RAVE product as shown. NOTE: This is critical for the secure/safe mounting of the Water Whoosh to your RAVE inflatable.

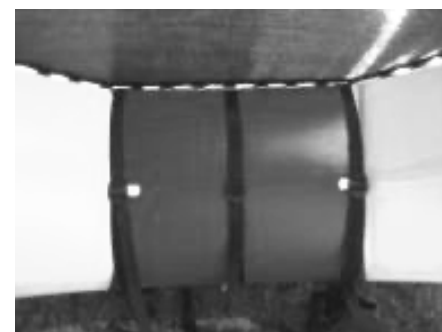

Step 3

Attach the long edge of adaptor apron to the underside Velcro flap of the Water Whoosh and flip it over to the top side of the Whoosh as shown.



Step 4

Lift and carry to shallow water and position both products so that the end of the Water Whoosh (the edge that has the adaptor flap attached to it) is facing the panel of your AJ/Bongo with the adaptor straps connected to it.

Step 5

Run the two pigtail straps (located down low on the outer two straps) through the bottom rings of the Water Whoosh and back through the adaptor strap buckles. Do not tighten these straps at this point.

Step 6

Insert the two Velcro straps coming from the underside of the Water Whoosh through both rings on the adaptor strap on the tube. Fold it over and fasten to the mating Velcro surface. Fold in the side flaps to lock it in place.



Step 7

Pull the lower buckle straps tight until the Water Whoosh is tight against the other RAVE Sports inflatable.



Step 8

Open the Velcro flap on the adaptor straps. Attach the short edge of the adaptor apron onto the exposed Velcro strip and fold the flap of the backer plate back down over the top.



Connecting multiple units together to create a continuous running track (NOTE: Water Whoosh 20 & Whoosh 15 ONLY)

In order to daisy chain whooshes together, an additional purchase of the #20872 Splash Trax to Aqua Jump Adaptor Apron is needed.

IMPORTANT: This safety apron **MUST** be used to prevent entrapment hazards between mat sections. Never connect & use multiple units together without this safety apron in position.

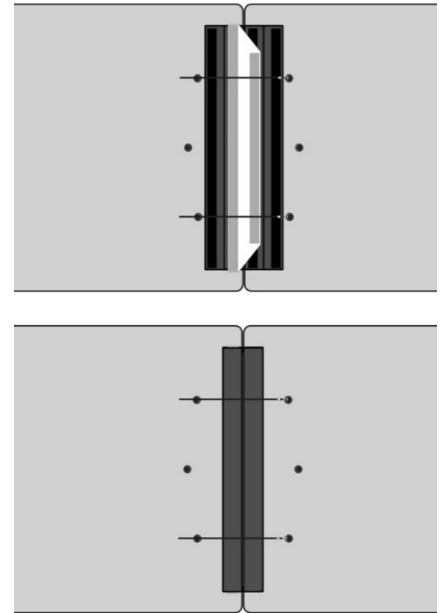

Undo flaps on Whooshes and Velcro the appropriate side to apron.

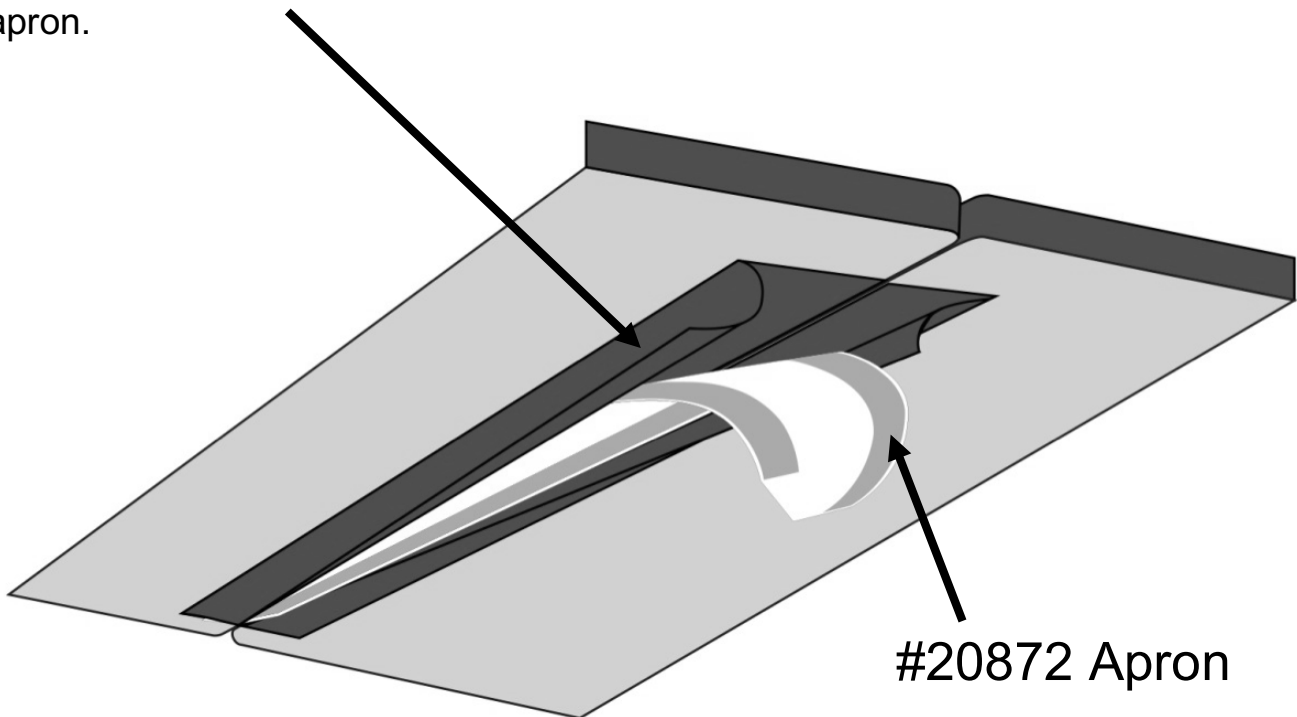

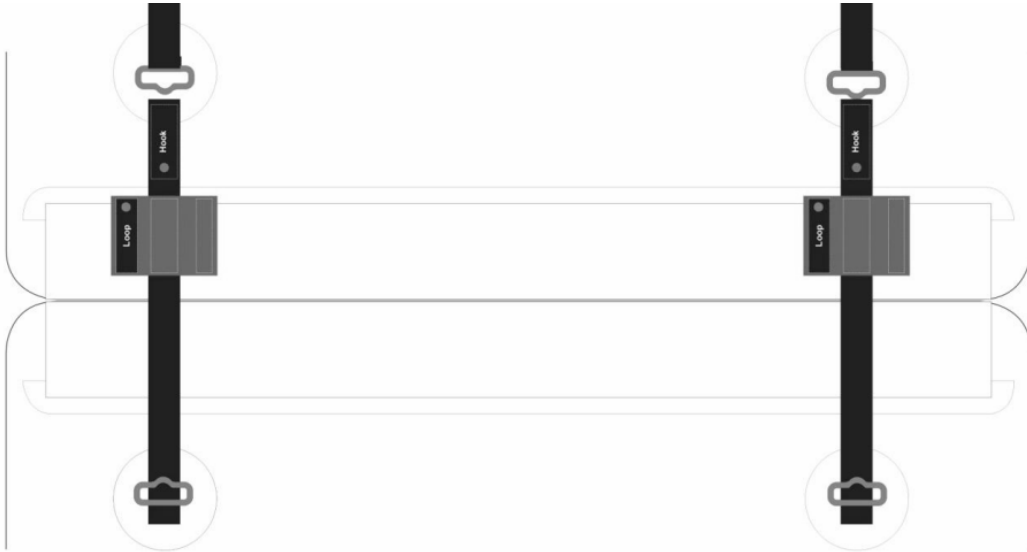

1. Twist and Insert the strap into the ring and pull taut to velcro it in position.

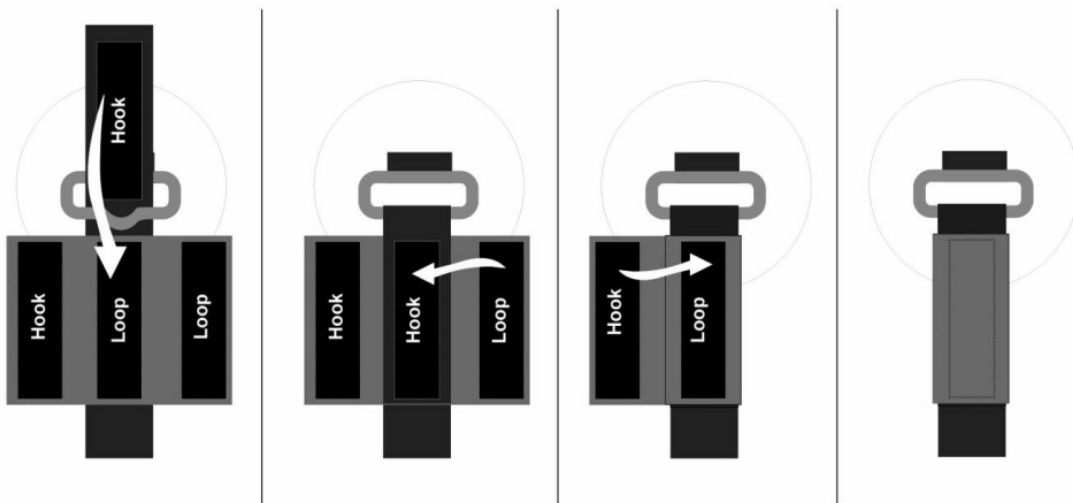
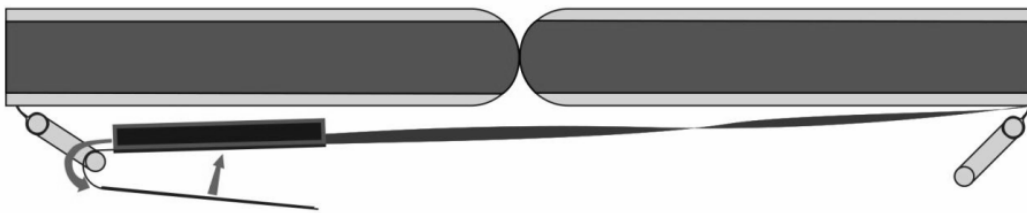

The Whoosh connection should look like this when done

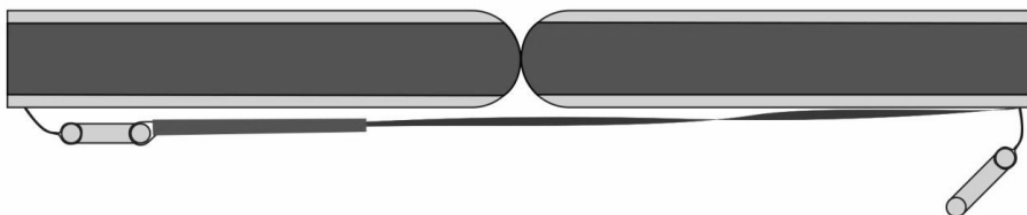

NOTE: Make sure to anchor the product securely before use.

Anchor far end of the Water Whoosh and enjoy!

Folding Instructions

After using your Water Whoosh it is best to deflate and fold for storage. This helps prevent damage and extends the life of your product.



Step 1

Carry the Water Whoosh to land and deflate. Be extremely careful not to drag the product.

Step 2

Let the mat dry for 15 minutes or longer in the sun and then flip over and repeat for the other side. (Dry with a towel, if necessary, to ensure it is completely dry before folding).

Step 3

Lay the mat on a flat surface and fold the mat (long ways) into thirds.

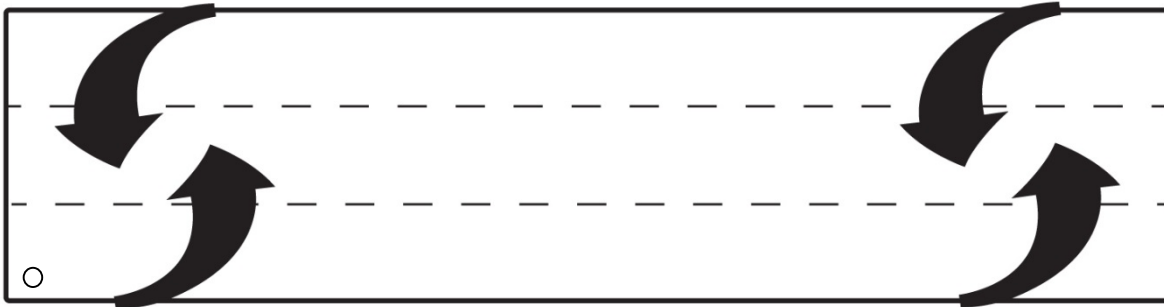

Step 4

Starting at the end opposite the inflation valve, begin folding approx. 10-12" (25-30 cm). Continue folding (DO NOT ROLL) down the length of the mat.

Step 5

Secure the folded mat with the buckle strap provided.

Cleaning and Storage

- When the inflatable product is not being used, store it in a covered, shaded area. This will help protect it against ultraviolet (UV) rays and extend the life of the product.
- Clean the inflatable completely with a mild soap and fresh water. NEVER USE PETROLEUM BASED PRODUCTS OR SOLVENTS FOR CLEANING. NEVER USE A POWER WASHER SINCE THE HIGH PRESSURE WATER JET WILL DAMAGE THE TUBE BEYOND REPAIR.
- Product should be completely dry and remain dry while stored.
- Roll the product loosely and place in a container, preferably one that rodents can't chew through.
- Secure against unauthorized or unsupervised use.
- Store in a cool, dry location. Do not store product directly on concrete surface. Place mothballs around stored inflatable to keep mice and insects away.

..... **Important**

Rodents like muskrats may be attracted to the PVC vinyl of your product.

When your product is on the water, maintaining full air pressure during periods of non-use will discourage them from chewing the vinyl.

Another way to ease the problem of nuisance rodents is to remove the temptation by taking the product out of the water at night. You can also make the whole area unattractive to rodents by changing the environment, making the area less hospitable for rodents. Removing any food source from the shoreline can also be a good deterrent. Check with your local DNR for additional guidance or possible restrictions

Repairs

For large holes, tears or seam failures, contact RAVE Sports at 1-800-659-0790.

Additional repair patches can be found online at www.ravesports.com.

For minor holes and tears:

- Inflate the product and locate the leak by spraying the tube with mild soapy water.
- Determine the hole size and cut a patch 1-2 inches (3-5 cm) wider than the diameter of the hole. Make sure all corners of the patch are rounded.
- Deflate the product and clean the patch and area around the hole with rubbing alcohol. Let dry completely.
- **READ AND UNDERSTAND THE WARNINGS ON THE GLUE CONTAINER.**
- Apply glue to the patch and the area around the hole. Let the glue dry until it is tacky to the touch. (About 30 seconds).
- Lay the product on a flat, hard surface and apply the patch. Working from the center to the outer edge, rub out any air bubbles between the patch and the product.
- Let patch dry for 24 hours before attempting to inflate the product.

RAVE
SPORTS®

RAVE
SPORTS®

THIS PAGE INTENTIONALLY LEFT BLANK.

RAVE
SPORTS®

RAVE
SPORTS®



WWW.RAVESPORTS.COM

RAVE SPORTS

A Subsidiary of Escalade Sports

985 Aldrin Drive #301

Eagan MN, 55121

800.659.0790

January 2021