

24-HOUR TIMER AND AQUASTAT CONTROL ACCESSORY FOR ASTRO 2 | INSTALLATION AND OPERATING INSTRUCTIONS

File No: 11.871
Date: FEBRUARY 24, 2017
Supersedes: 11.871
Date: JULY 16, 2015

1.0	Timer application	1	6.0	Aquastat control accessory	2
2.0	Installation	1	7.0	Aquastat installation	3
3.0	Timer and aquastat application	1	8.0	Timer and aquastat installation	3
4.0	24-Hour timer	2	9.0	Timer programming with manual override switch	3
5.0	Timer installation	2			

1.0 TIMER APPLICATION

The Armstrong 24-hour timers provide On/Off pump control according to preset operating times in order to increase comfort and improve the overall efficiency of domestic hot water re-circulation systems. The 24-hour timers are designed for use with Armstrong circulators installed in indoor hot water re-circulation applications.



Typical timer applications will cycle the pump at preset times, allowing the user to select operation of the circulating pump during high peak usage periods in order to decrease the delivery time to outlet fixtures and reduce wasted water.

The timer control is programmable to ¼ hour intervals within a 24-hour time frame utilizing a user friendly analog clock timer with hour and minute hands, two directional arrows, and AM/PM time setting.

2.0 AQUASTAT APPLICATION

An optional aquastat is available for constant circulation applications to maintain temperature between 85°F and 105°F (29°C and 41°C). The Armstrong aquastat control accessory is designed for use with Astro Series wet rotor circulators in potable hot water re-circulation installations.



The aquastat control automatically turns the circulator on when the temperature in the hot water line falls below approximately 85°F (ON condition - for example when there is low demand on the hot water supply). The control turns it off again when the temperature exceeds 105°F (OFF condition - as in the case of periods with high demand).

3.0 TIMER AND AQUASTAT APPLICATION

The 24-hour timer and aquastat can also be used together giving a comprehensive time and temperature actuated pump control in a domestic hot water re-circulation system. Typical application of the timer and aquastat combination will circulate water only when both time and temperature ON conditions are initiated.



TIMER FEATURES

- Easy to install and program
- Time actuated 24-hour on/off pump control
- Hour and minute time setting with AM/PM function
- Manual override switch modes
- Rugged construction - steel enclosure
- Clear plastic cover for dust and moisture protection of the clock face
- Designed specifically for hot water re-circulation applications
- UL Listed

TIMER FEATURES

- Easy to install
- Temperature actuated pump control
- Environmentally sealed enclosure
- Surface sensing through snap acting bimetallic disc
- UL Listed

4.0 24-HOUR TIMER

TECHNICAL DATA

Description	24-Hour Timer
Application	Time actuated On/Off pump control
Shortest Switching Interval	¼ hour (15 minutes)
Manual Switch Modes	"Timer", "ON" Override, "OFF" Override

TECHNICAL DATA	
Ambient Temperature Range	-40°F to 180°F (-40°C to 82°C)
Power Consumption	120 V, 0.5 W
Supply Voltage	110-120 VAC, 60 Hz
Terminals	¼" spade terminals
Weight	Approximately 3 oz.

5.0 TIMER INSTALLATION

WARNING



Electrical shock hazard - Verify that the electrical rating of the device matches the values shown on the nameplate of the circulator. All electrical work should be performed by a qualified electrician in accordance with the latest edition of the National Electric Code, local codes and regulations. Failure to follow these instructions could result in serious injury, death and/or property damage.

WARNING



Risk of electric shock - This pump is supplied with a grounding conductor and grounding-type attachment plug. To reduce the risk of electric shock, be certain that it is connected only to a properly grounded, grounding-type receptacle.

Note: Steps 1 & 3 apply to retrofit installations.

- Disconnect the electrical supply to the circulator
Note: Numerical component designations included in Steps 2 through 8 refer to circulator and timer components shown in **FIG. 1**.
- Unfasten the mounting 2 screws (4) and remove the terminal box cover (3).
- Disconnect wire leads from the power supply.
- Connect power supply wires (black, white and green) to the timer unit and to the circulator terminals (as shown in **FIG. 2**).
Note: Lead Wiring Specification - Minimum, 6" (152 mm) long, 14 AWG, rated minimum 140°F (60°C). Provided with R/C crimp connectors for attachment to the ground.
- Place the timer box cover (5) using the 2 mounting screws (4). Insure that all lead wires are inside the timer assembly.
- Program the timer according to instructions provided on page 6.
- Connect the unit to electrical supply.
- Start the circulator.

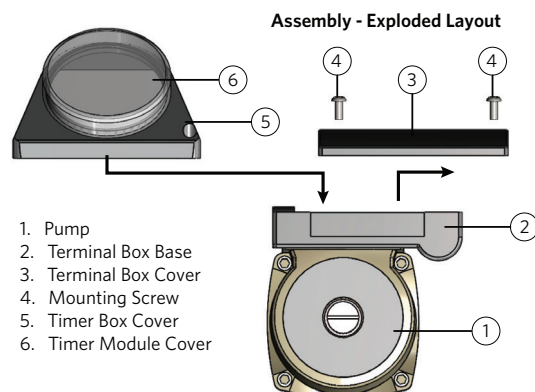

FIG. 1 Astro 2 Series circulator and 24-Hour Timer assembly drawing

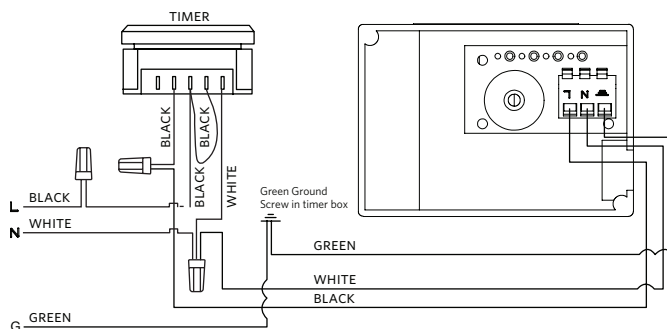

FIG. 2 Astro 2 Series circulator and 24-Hour Timer wiring diagram

6.0 AQUASTAT CONTROL ACCESSORY

TECHNICAL DATA	
Description	Aquastat (thermostatic) switch
Type	Surface sensing, snap acting bimetallic disc
Enclosure	Environmentally sealed
Switch modes*	105 ± 5°F (40 ± 2°C) pump switches OFF 85 ± 6°F (29 ± 3°C) pump switches ON
Contact position	Normally open
Mounting	½": Clip-on type for ⅝" o.d. system piping size (i.e., ½" i.d. copper tubing or ⅜" steel pipe) ¾": Clip-on type for ⅞" o.d. system piping size (i.e., ¾" i.d. copper tubing or ½" steel pipe) May be mounted on either the inlet or outlet piping of the circulator.
Lead length	14" (356 mm)

*Temperatures indicated are at pipe surface

7.0 AQUASTAT INSTALLATION

- 1 Follow Steps 1, 2 and 3 in the Timer Installation section
- 2 The aquastat control is a surface temperature sensing device that must be in contact with the system piping to operate properly. Separate models include clip-on mounts for 3/4" (7/8" o.d.) and 1/2" (5/8" o.d.) copper tubing. (See FIG. 3)
- 3 Connect the black, green and white lead wires according to the wiring diagram (FIG. 4)
Note: Lead Wiring Specification - Minimum, 6" (152 mm) long, 14 AWG, rated minimum 140°F (60°C). Provided with R/C crimp connectors for attachment to the ground.
- 4 Close the terminal box cover and fasten the screw

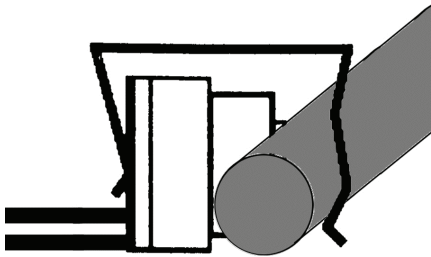

FIG. 3

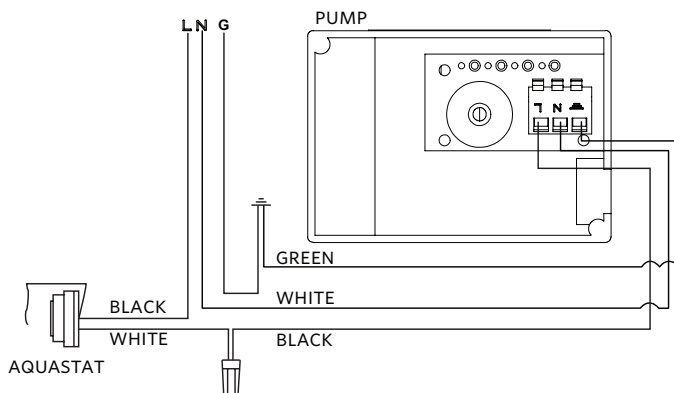

FIG. 4 Astro 2 Series circulator with Aquastat Control wiring diagram

8.0 TIMER AND AQUASTAT INSTALLATION

Follow the installation steps in both the Timer and Aquastat installation instructions and refer to Fig. 5 for the wiring connections.

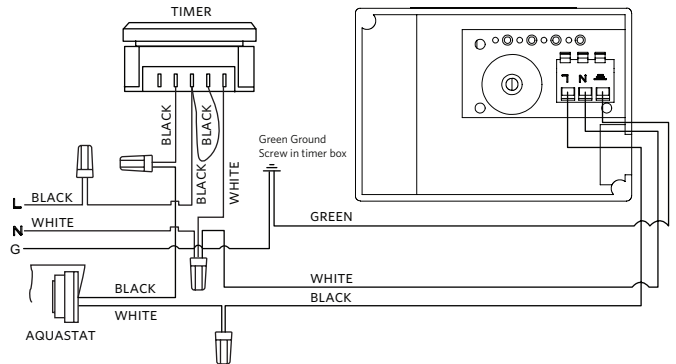

FIG. 5 Astro 2 Series circulator with 24-Hour Timer and Aquastat Control wiring diagram

9.0 TIMER PROGRAMMING WITH MANUAL OVERRIDE SWITCH

Automatic Mode

In order to operate the time switch in the automatic mode, the manual switch must be in the center position. (See FIG. 6)

Manual Mode

With the manual switch selector lever the selected programs can be overridden. In the lower position, marked "0", terminals 3 and 5 are permanently closed. In the upper position, marked "1", terminals 3 and 4 are permanently closed. (See FIG. 6)

OVERRIDE MODE

3-WAY MANUAL OVERRIDE SWITCH

1 = PERMANENT ON
0 = AUTOMATIC
0 = PERMANENT OFF

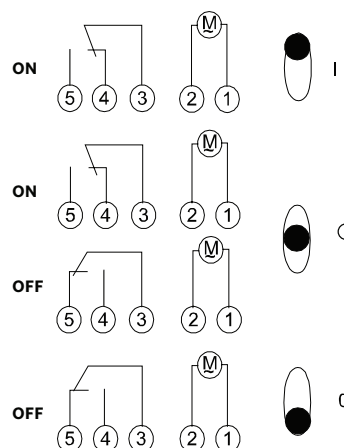
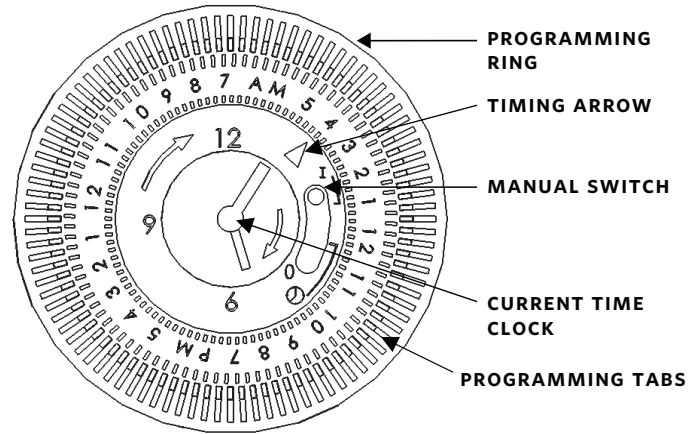

FIG. 6

TIMER PROGRAMMING

1. Set the current time by turning the programming ring clockwise until the timing arrow points to the current time of day.
 2. Restore power to the circulator and set the manual switch on the timer dial to the "ON" position ("I").
 3. Set the required "ON/OFF" times by pushing the programming tabs to the outer position for "ON" time intervals. For "OFF" ("O") operation keep the programming tabs in the inner position.
 4. Set the manual switch to the center position, between the "I" and "O" on the timer dial in order to cycle the pump according to the programming tab settings. The pump will run continuously when the switch is set to "I" (ON) position. The "O" (OFF) position of the switch will shut the circulator off at all times.
 5. In the event of power outage, the timer must be adjusted for the correct time of day after power is restored.
- Note:** The 24-hour timer requires manual resetting for daylight savings time.



TORONTO
+1 416 755 2291

BUFFALO
+1 716 693 8813

BIRMINGHAM
+44 (0) 8444 145 145

MANCHESTER
+44 (0) 8444 145 145

BANGALORE
+91 (0) 80 4906 3555

SHANGHAI
+86 21 3756 6696

SÃO PAULO
+55 11 4781 5500