



HAY NEW ORDER PRICELIST

UNITED KINGDOM JANUARY 2022
REC. RETAIL PRICES IN GBP INCL. VAT
Subject to increases in prices and printing errors

CONTENT

NEW ORDER OVERVIEW	4	STEEL SLIDING DOOR 100 150	31
SHELF TOP 34 100 150	17	STEEL SLIDING DOOR 100 LEFT	31
SHELF MIDDLE 34 100 150	17	STEEL SLIDING DOOR PREPARED FOR LOCK 100 150	32
SHELF BOTTOM 34 100 150	17	STEEL SLIDING DOOR PREPARED FOR LOCK 100 LEFT	32
TRAY TOP 100 150	18	STEEL SLIDING DOOR DOUBLE HEIGHT 100	33
SINGLE PROFILE SET OF 4	19	STEEL SLIDING DOOR DOUBLE HEIGHT 100 LEFT	33
DOUBLE PROFILE SET OF 2	19	STEEL SLIDING DOOR PREPARED FOR LOCK DOUBLE HEIGHT 100	33
CORNER PROFILE SET OF 1 + 1	19	STEEL SLIDING DOOR PREPARED FOR LOCK DOUBLE HEIGHT 100 LEFT	34
BENCHTOP 34 100 150	20	HIGH DRAWER INCL. MOUNTING SET 34 SET OF 1 OR DOUBLE HEIGHT SET OF 2	35
WOODEN PANELS AND DOOR 100 150	21	HIGH DRAWER INCL. MOUNTING SET 100 SET OF 1 OR DOUBLE HEIGHT SET OF 2	35
WOODEN PANELS AND DOOR 100 LEFT	21	DRAWER INCL. MOUNTING SET 34 SET OF 2 OR DOUBLE HEIGHT SET OF 4	36
WOODEN WALL PANELS AND DOOR 100 150	22	DRAWER INCL. MOUNTING SET 100 SET OF 2 OR DOUBLE HEIGHT SET OF 4	36
WOODEN WALL PANELS AND DOOR 100 LEFT	22	MIDDLE BAR FOR DRAWER 34 100	36
STEEL SIDE PANEL 34	23	LOCK BAR DRAWER PREPARED FOR LOCK 34 100	37
STEEL SIDE PANEL DOUBLE HEIGHT 34	23	EXTRA LOCK CYLINDER	37
STEEL SIDE PANEL DOUBLE HEIGHT FOR ADJUSTABLE SHELF 34	23	EXTRA KEY FOR LOCK CYLINDER	37
STEEL SHELF FOR ADJUSTABLE PANELS 100	23	MASTER KEY	38
PINS FOR ADJUSTABLE SHELF SET OF 4	23	EXCHANGE KEY FOR LOCK CYLINDER	38
STEEL BACK PANEL 100 150	24	WALL BRACKET SHELF SET OF 2 WALL BRACKET FOR DOUBLE HEIGHT SHELF SET OF 2	39
STEEL BACK PANEL DOUBLE HEIGHT 100	24	WALL SAFETY BRACKETS FOR SHELVING SYSTEM SET OF 2	39
STEEL WALL BACK PANEL 100 150	24	FLOOR SAFETY BRACKETS FOR SHELVING SYSTEM SET OF 2	39
STEEL WALL BACK PANEL DOUBLE HEIGHT 100	24	REPAIR KIT	40
STEEL TABLE PANEL 34	25	WHEELS SET OF 4	40
STEEL TABLE PANEL DOUBLE HEIGHT 34	25	SHELF BOOK DIVIDER LEFT OR RIGHT	40
STEEL TABLE PANEL DOUBLE HEIGHT FOR ADJUSTABLE SHELF 34	25	TROLLEY A 1 DRAWER & TRAY TOP	41
STEEL TABLE BACK PANEL 100 150	25	TROLLEY B 3 DRAWER & TRAY TOP	41
STEEL TABLE BACK PANEL DOUBLE HEIGHT 100	26	TABLE 4 LEGS	42
STEEL PERFORATED BACK PANEL 100 150	26	TABLE 4 LEGS	42
STEEL PERFORATED BACK PANEL DOUBLE HEIGHT 100	26	TABLE INCL. SINGLE PLUG & PLAY 4 LEGS	43
MOUNTING ADAPTER TRAY	27	TABLE INCL. CABLE MANAGEMENT EDGE 4 LEGS	43
BACK PANEL FASTENER ADAPTER TRAY	27	TABLE INCL. PLUG & PLAY CABLE MANAGEMENT EDGE 4 LEGS	44
TEXTILE PANEL 34 100 150	28	TABLE INCL. CABLE MANAGEMENT EDGE 34 CM 4 LEGS	44
INSIDE TEXTILE PANEL 34 100 150	28	TABLE INCL. PLUG & PLAY CABLE MANAGEMENT EDGE 34 CM 4 LEGS	45
TEXTILE SIDE PANEL DOUBLE HEIGHT 34	29		
INSIDE TEXTILE SIDE PANEL DOUBLE HEIGHT 34	29		
TEXTILE BACK PANEL DOUBLE HEIGHT 100	30		
INSIDE TEXTILE BACK PANEL DOUBLE HEIGHT 100	30		

TABLE INCL. CABLE MANAGEMENT EDGE 34 CM PREPARED FOR TOP TRAY DIVIDER 4 LEGS.....	45	COVER FOR CABLE MANAGEMENT W. PEN HOLDER MODULE SIZE 50 CM.....	63
TABLE INCL. PLUG & PLAY CABLE MANAGEMENT EDGE 34 CM PREPARED FOR TOP TRAY DIVIDER 4 LEGS.....	46	COVER FOR CABLE MANAGEMENT MODULE SIZE 25 CM.....	63
TABLE INCL. CABLE MANAGEMENT PREPARED FOR TOP TRAY DIVIDER AND TABLE SCREENS EDGE 4 LEGS.....	46	COVER FOR CABLE MANAGEMENT MODULE SIZE 50 CM.....	63
TABLE INCL. PLUG & PLAY CABLE MANAGEMENT PREPARED FOR TOP TRAY DIVIDER AND TABLE SCREENS EDGE 4 LEGS.....	47	COVER FOR PLUG AND PLAY DOUBLE P&P CABLE MANAGEMENT MODULE SIZE 25 CM.....	63
TABLE INCL. CABLE MANAGEMENT CENTER OR PREPARED FOR TABLE SCREENS 4 LEGS.....	47	COVER FOR PLUG AND PLAY DOUBLE P&P CABLE MANAGEMENT MODULE SIZE 50 CM.....	64
TABLE INCL. CABLE MANAGEMENT CENTER OR PREPARED FOR TABLE SCREENS 4 LEGS.....	48	FLIP COVER FOR PLUG AND PLAY DOUBLE P&P CABLE MANAGEMENT MODULE SIZE 50 CM MIDDLE.....	64
TABLE INCL. PLUG & PLAY CABLE MANAGEMENT CENTER OR PREPARED FOR TABLE SCREENS 4 LEGS.....	48	NO COMBINATION 101.....	65
TABLE INCL. PLUG & PLAY CABLE MANAGEMENT CENTER OR PREPARED FOR TABLE SCREENS 4 LEGS.....	49	NO COMBINATION 102.....	65
TABLE INCL. DOUBLE PLUG & PLAY CABLE MANAGEMENT CENTER IN COMBINATION WITH TABLE SCREENS 4 LEGS.....	49	NO COMBINATION 103.....	65
TABLE SCREEN EDGE 58 73.....	50	NO BENCH COMBINATION 100.....	66
TABLE SCREEN MIDDLE 100 150 200.....	50	NO BENCH COMBINATION 150.....	66
TABLE LEGS.....	51	NO COMBINATION 201.....	67
DOUBLE TABLE LEGS.....	51	NO COMBINATION 202.....	67
TABLE CONNECTORS.....	52	NO COMBINATION 203.....	68
CABLE CLIP SET OF 2.....	52	NO COMBINATION 204.....	68
CABLE GUIDE FOR TABLE LEG H74.....	52	NO COMBINATION 205.....	69
HIGH TABLE HT-5 H90 CM.....	53	NO COMBINATION 301.....	69
HIGH TABLE HT-12 H90 CM.....	53	NO COMBINATION 303.....	70
HIGH TABLE HT-6 H90 CM.....	54	NO COMBINATION 401.....	70
HIGH TABLE HT-3 H90 CM.....	54	NO COMBINATION 501.....	71
HIGH TABLE HT-8 H90 CM.....	55	NO COMBINATION 502.....	71
HIGH TABLE HT-5 H105 CM.....	55	NO COMBINATION 701.....	72
HIGH TABLE HT-12 H105 CM.....	56	NO COMBINATION 702.....	72
HIGH TABLE HT-6 H105 CM.....	56	NO TABLE COMBINATION 401.....	73
HIGH TABLE HT-3 H105 CM.....	57	COLOURS & MATERIALS.....	74
HIGH TABLE HT-8 H105 CM.....	58	GENERAL TERMS OF SALE AND DELIVERY.....	75
CABLE TRAY 35.....	59	FABRIC & LEATHER UPHOLSTERY.....	75
CABLE TRAY FOR STEP MODULE 35.....	59	CARE & MAINTENANCE.....	75
STEP MODULES FOR CABLE MANAGEMENT.....	60	FSC™ CERTIFICATION.....	75
STEP MODULES FOR CABLE MANAGEMENT.....	61	ECOLABELS.....	75
STEP MODULE EXTENSION CABLE.....	62	SUSTAINABILITY.....	75
STEP MODULES SUPPLY CABLES.....	62	DOWNLOADS.....	75

NEW ORDER OVERVIEW

SHELVES

Shelf, corner, top, middle, and bottom
34|100|150

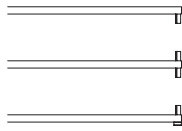

TRAY

Tray top
100|150



BENCHTOPS

Benchtop 34



Benchtop 100

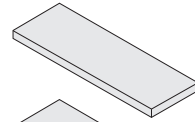

Benchtop 150

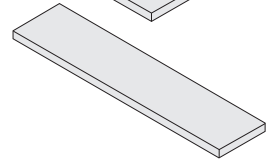

PROFILES

Single profile
Set of 4
H33 cm



Double profile
Set of 2
H33 cm



Corner profile
Set of 1 x triple
1 x single
H33 cm



Single profile
for double height
Set of 4
H68 cm



Double profile
for double height
Set of 2
H68 cm



Corner profile
for double height
Set of 1 x triple
1 x single
H68 cm

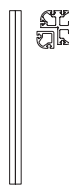

WOODEN SLIDING DOOR AND PANEL SET

Sliding door 100



Panel set 100

Sliding door
corner left 100



Panel set 100

Sliding door 150



Panel set 150

WOODEN SLIDING DOOR AND WALL PANEL SET

Sliding door 100



Wall panel set 100

Sliding door
corner left 100



Wall panel set 100

Sliding door 150



Wall panel set 150

STEEL PANELS

Side panel 34



Side panel double height 34

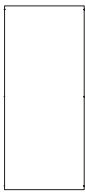

Side panel double height for adjustable shelf 34

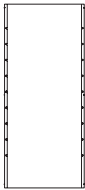

Back panel 100



Back panel Double height 100



Back panel 150



STEEL TABLE PANELS

Table panel 34



Table panel double height 34

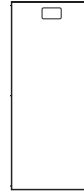

Table panel double height for adjustable shelf 34

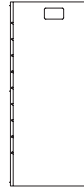

Table back panel 100

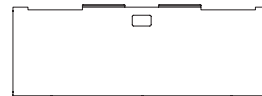

Table back panel double height 100

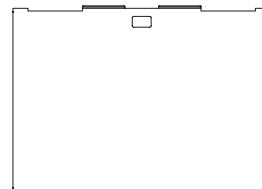
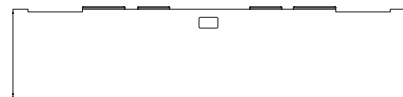

Table back panel 150



STEEL SHELF FOR ADJUSTABLE SIDE PANELS

Steel shelf 100



STEEL WALL BACK PANELS

Wall Panel 100



Wall Panel 150



Wall back panel double height 100



PINS FOR ADJUSTABLE SHELF

Set of 4

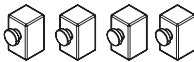

PERFORATED STEEL PANELS

Perforated back panel 100

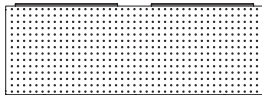

Perforated back panel double height 100

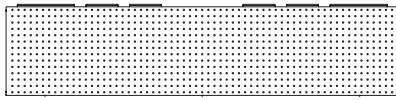
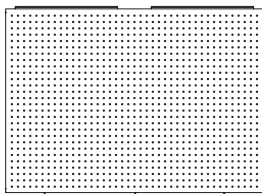

STEEL PANEL ACCESSORIES

Mounting adapter tray

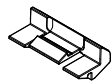

Back panel fastener adapter tray

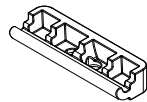

TEXTILE PANELS

Textile side panel 34



Textile side panel double height 34



Textile back panel 100



Textile panel back panel double height 100



Textile back panel 150

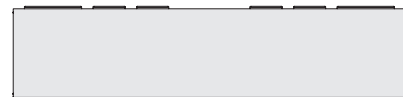

STEEL DOORS

Sliding door 100

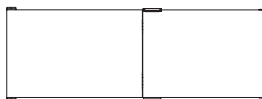

Sliding door 100 prepared for lock

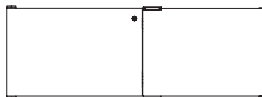

Sliding door 150

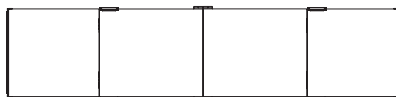

Sliding door 150 prepared for lock



Sliding door double height 100

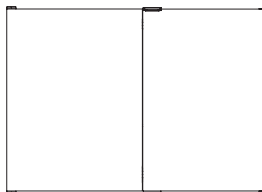

Sliding door double height 100 prepared for lock

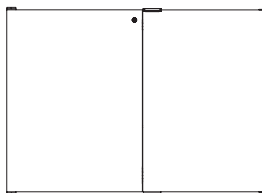

Sliding door 100 left

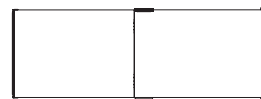

Sliding door 100 left prepared for lock



Sliding door double height 100 left

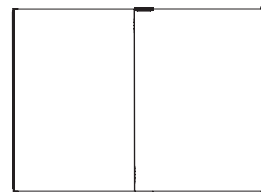

Sliding door double height 100 left prepared for lock

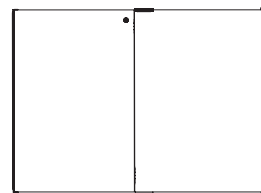

STEEL DRAWERS

High Drawer 34
Set of 1

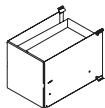

High Drawer 34
Double height
Set of 2

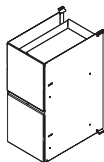

High Drawer 100
Set of 1

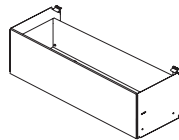

High Drawer 100
Double height
Set of 2

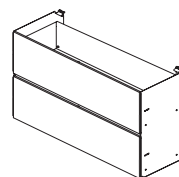

Drawer 34
Set of 2

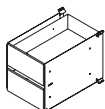

Drawer 34
Double height
Set of 4

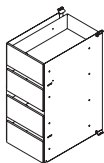

Drawer 100
Set of 2

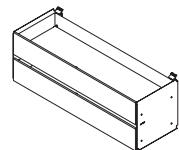

Drawer 100
Double height
Set of 4

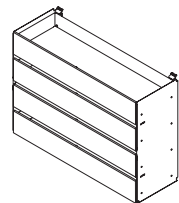

MIDDLE BARS FOR DRAWERS

Lock bar
for drawer

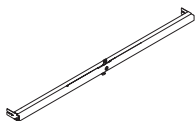

Middle bar
for drawer

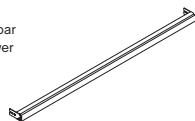

LOCK SYSTEM

Extra lock cylinder



Master key



Extra Key for lock cylinder



Exchange key



SAFETY BRACKETS

Wall safety brackets
Set of 2

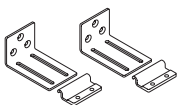

Floor safety brackets
Set of 2

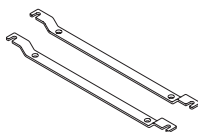

WALL BRACKETS

Wall bracket shelf
Set of 2

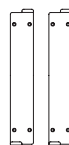

Wall bracket for double height shelf
Set of 2

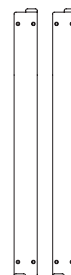

ACCESSORIES

Repair Kit



Wheels
Set of 4

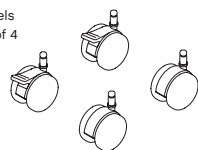

Shelf Book divider,
left or right



TROLLEYS

Trolley A
1 drawer and tray top
incl. lock

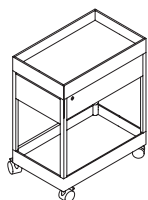

Trolley B
3 drawers & tray top
incl. lock

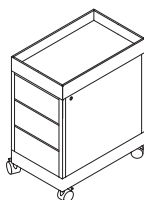

TABLE LEGS

New order tables can be connected to the shelves with table connectors. The tables are available with 1, 2, 3 or 4 legs

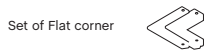
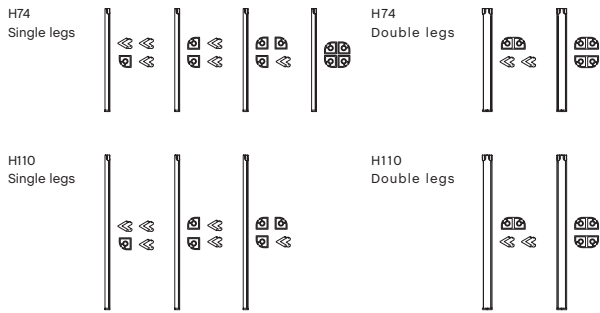
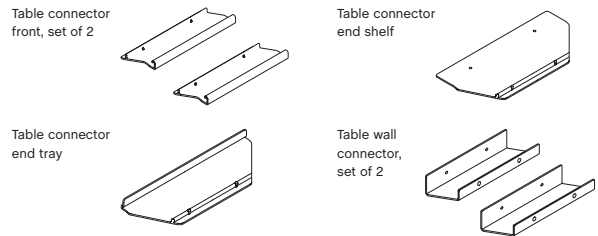
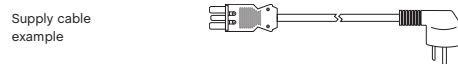
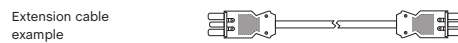
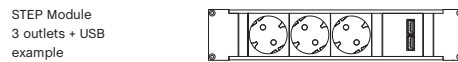
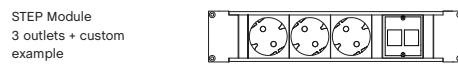
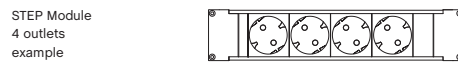
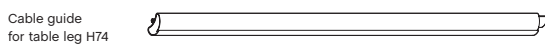
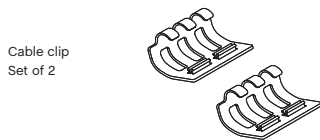
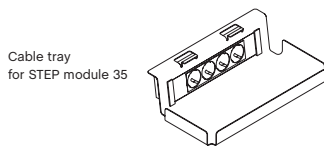
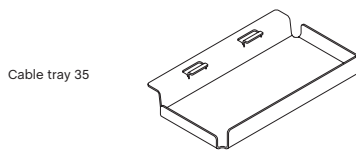

TABLE CONNECTORS



CABLE MANAGEMENT ACCESSORIES



COVERS

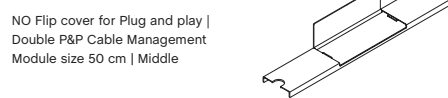
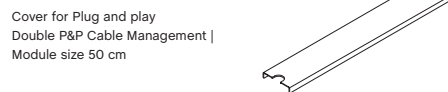
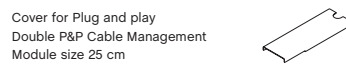
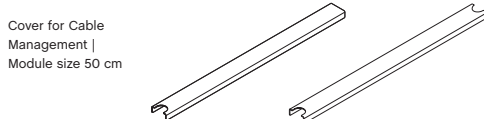
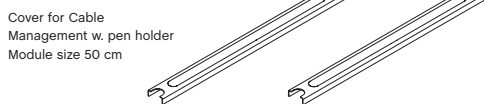

CABLE MANAGEMENT AND TABLE SCREEN OVERVIEW

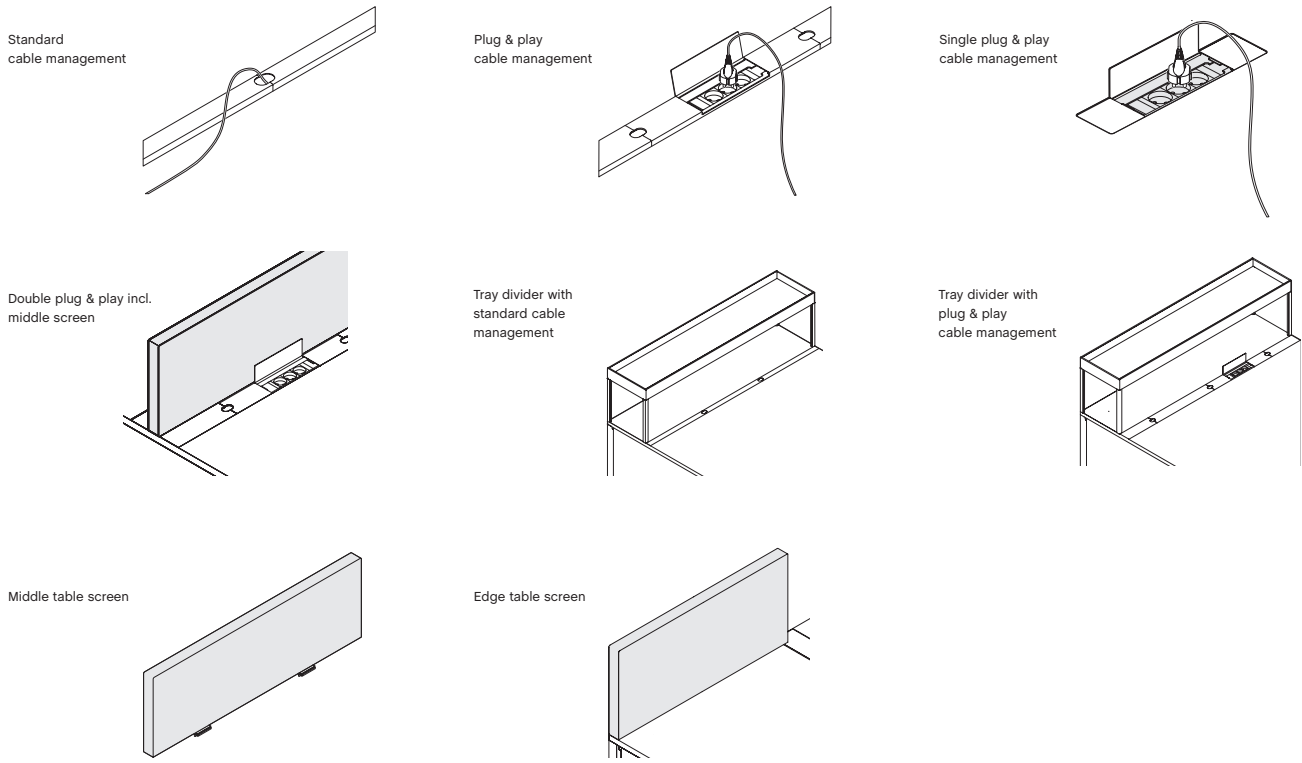

TABLE SCREENS

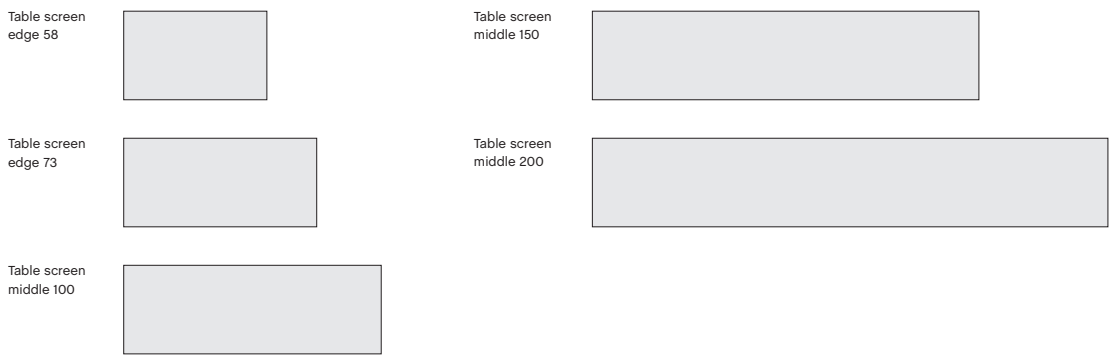

TABLE OVERVIEW

100 x 50



1A

100 x 100

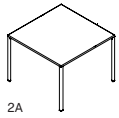

2A

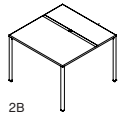

2B

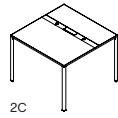

2C

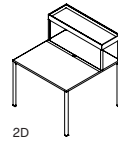

2D

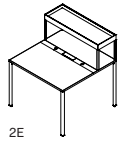

2E

100 x 150

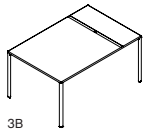

3B

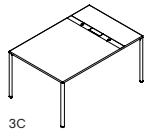

3C

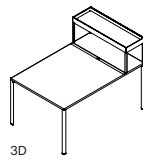

3D

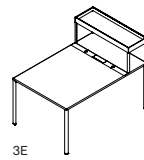

3E

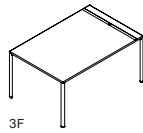

3F

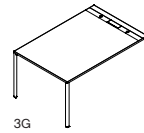

3G

150 x 50

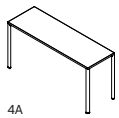

4A

150 x 75

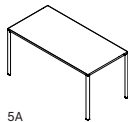

5A

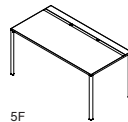

5F

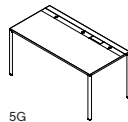

5G

150 x 100

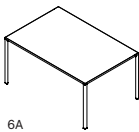

6A

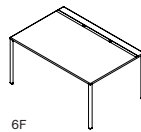

6F

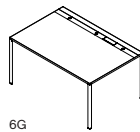

6G

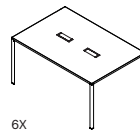

6X

150 x 150

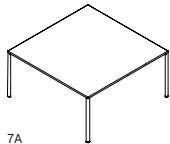

7A

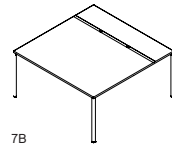

7B

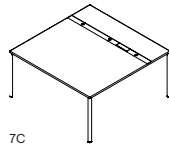

7C

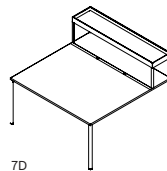

7D

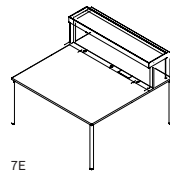

7E

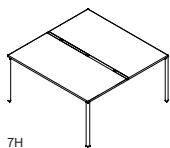

7H

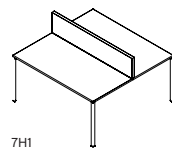

7H1

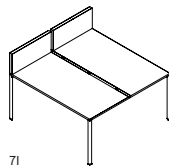

7I

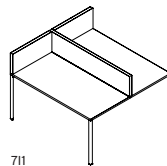

7I1

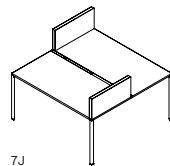

7J

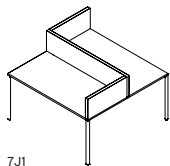

7J1

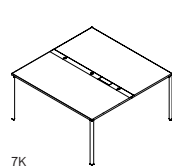

7K

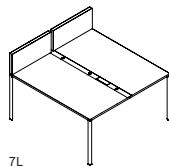

7L

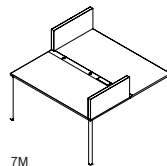

7M

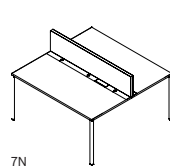

7N

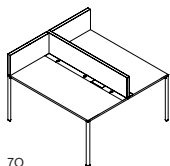

7O

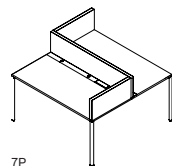

7P

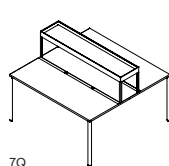

7Q

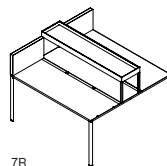

7R

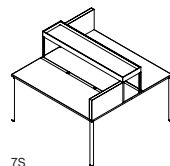

7S

TABLE OVERVIEW

150 x 150

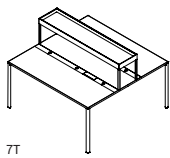

7T

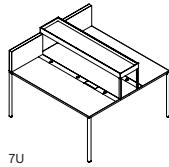

7U

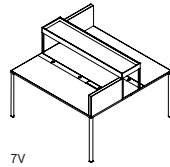

7V

200 x 75

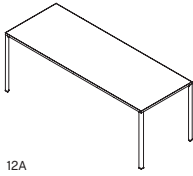

12A

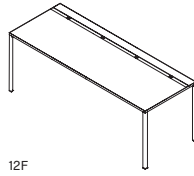

12F

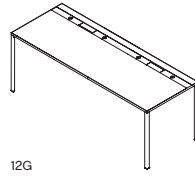

12G

200 x 100

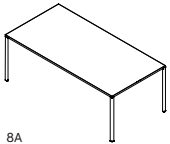

8A

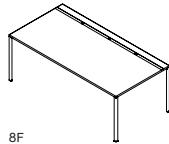

8F

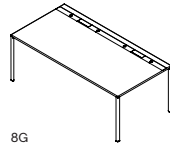

8G

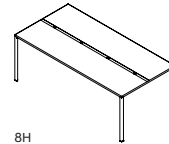

8H

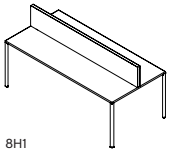

8HI

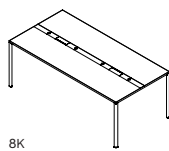

8K

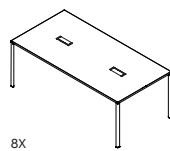

8X

200 x 150

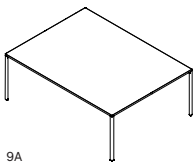

9A

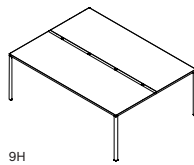

9H

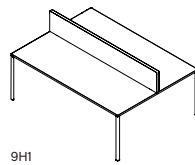

9HI

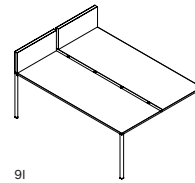

9I

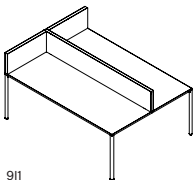

9II

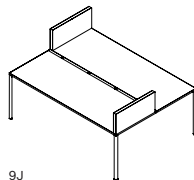

9J

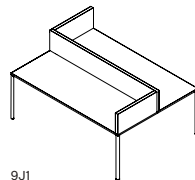

9J1

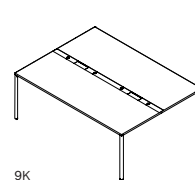

9K

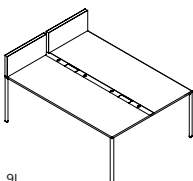

9L

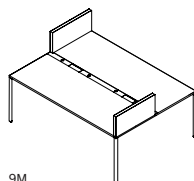

9M

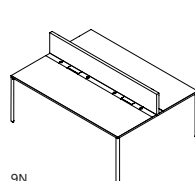

9N

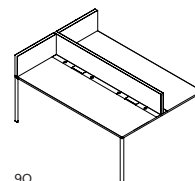

9O

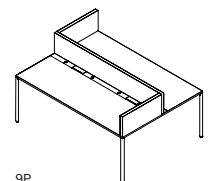

9P

250 x 100

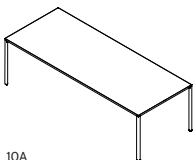

10A

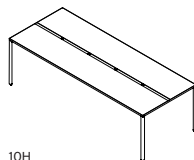

10H

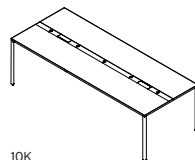

10K

300 x 100

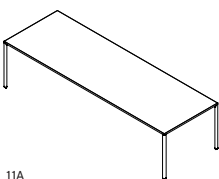

11A

HIGH TABLE OVERVIEW

100 x 150

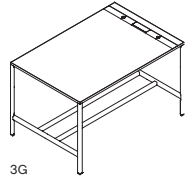
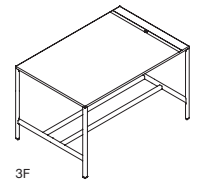
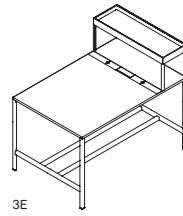
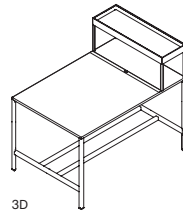
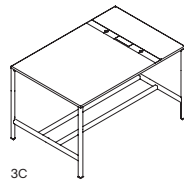
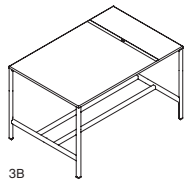

150 x 75

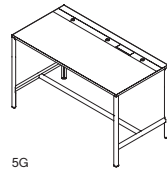
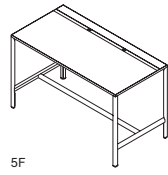
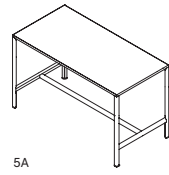

150 x 100

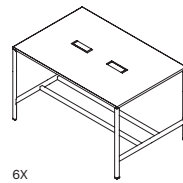
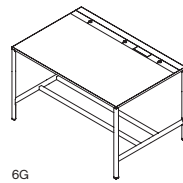
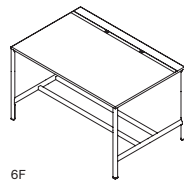
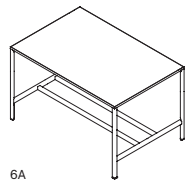

200 x 100

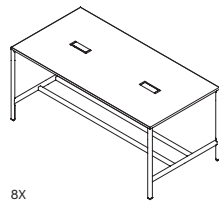
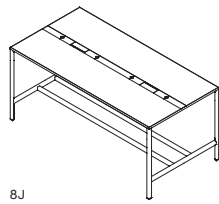
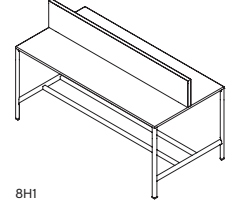
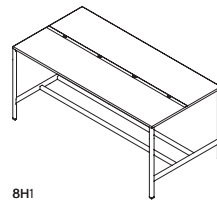
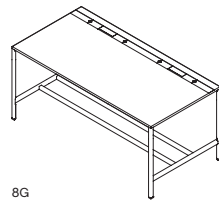
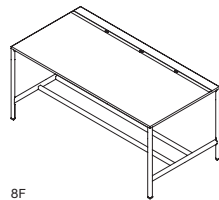
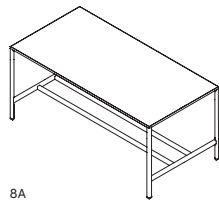

200 x 75

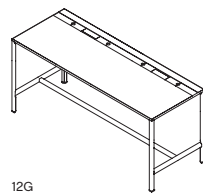
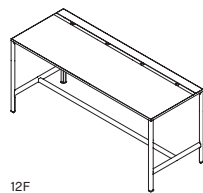
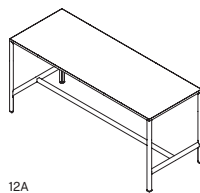

TABLETOP OVERVIEW

100 x 50

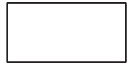

1A

100 x 100

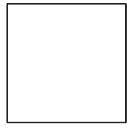

2A

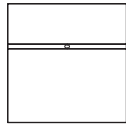

2B

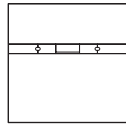

2C

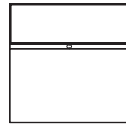

2D

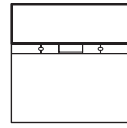

2E

100 x 150

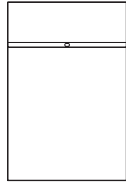

3B

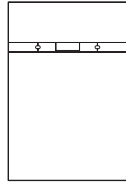

3C

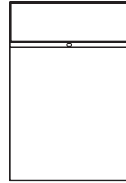

3D

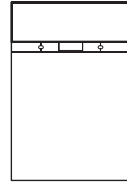

3E

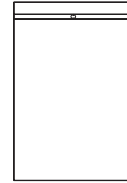

3F



3G

150 x 50



4A

150 x 75



5A

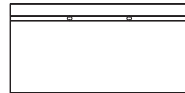

5F

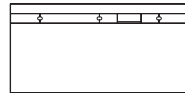

5G

150 x 100

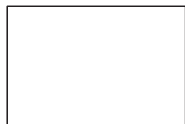

6A

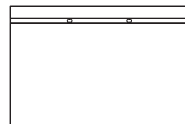

6F

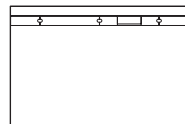

6G

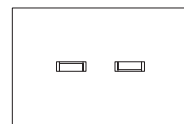

6X

150 x 150

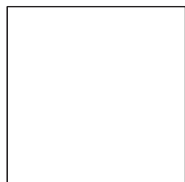

7A

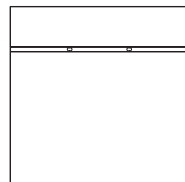

7B

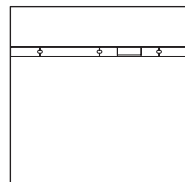

7C

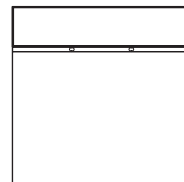

7D

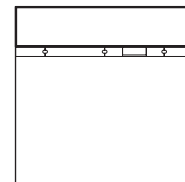

7E

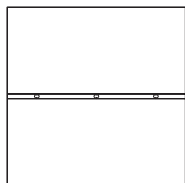

7H

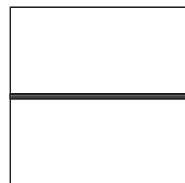

7H1

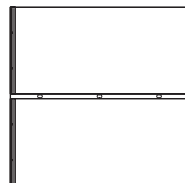

7I

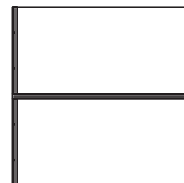

7I1

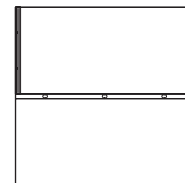

7J

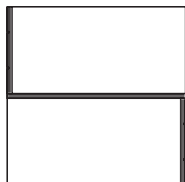

7J1

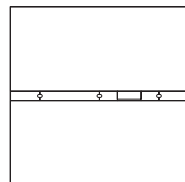

7K

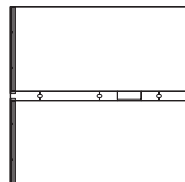

7L

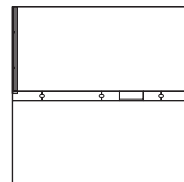

7M

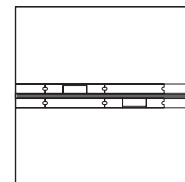

7N

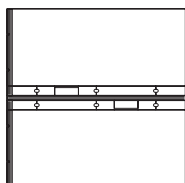

7O

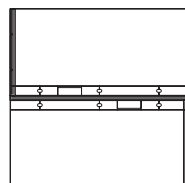

7P

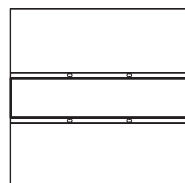

7Q

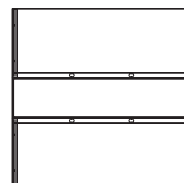

7R

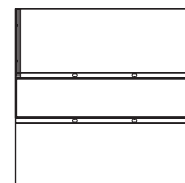

7S

TABLETOP OVERVIEW

150 x 150

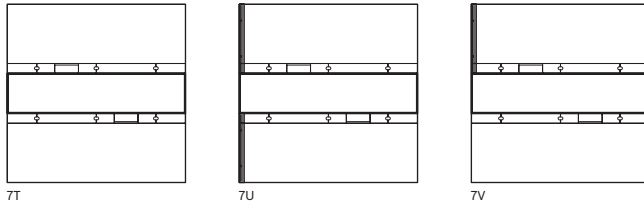

7T 7U 7V

200 x 100

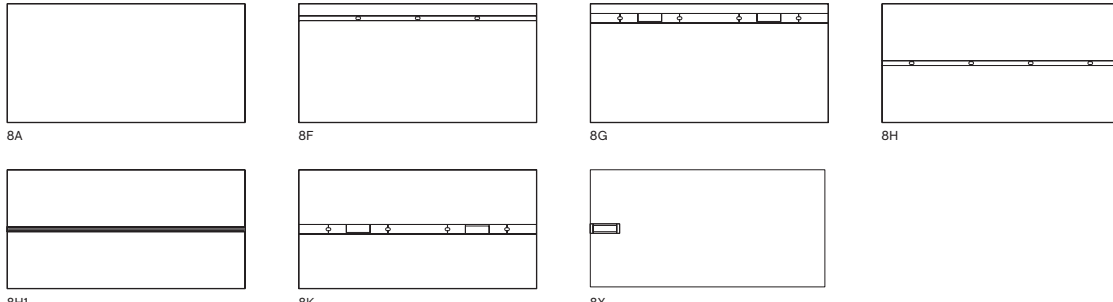

8A 8F 8G 8H

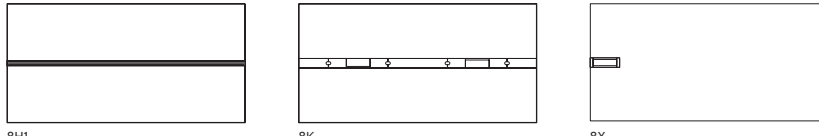

8H1 8K 8X

200 x 150

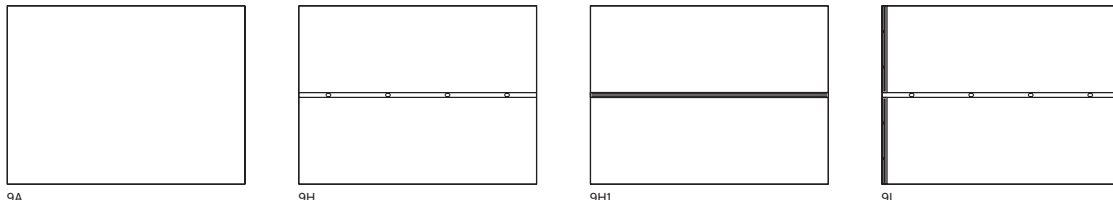

9A 9H 9H1 9I

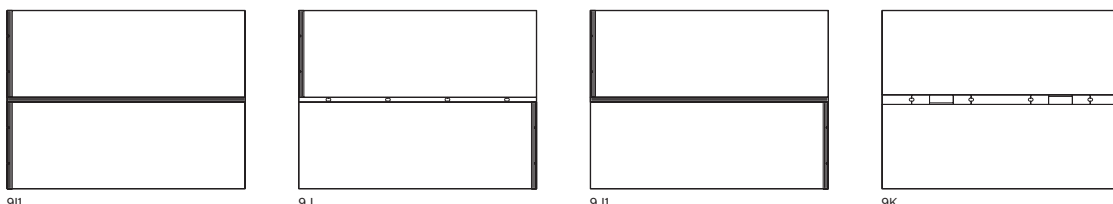

9I1 9J 9J1 9K

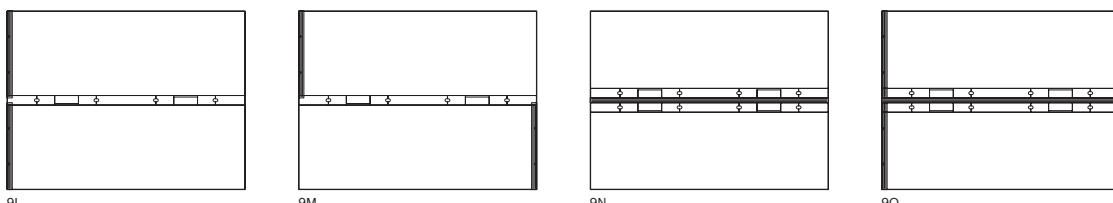

9L 9M 9N 9O

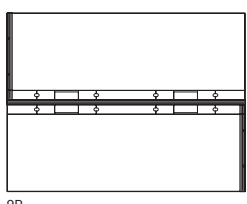

9P

250 x 100

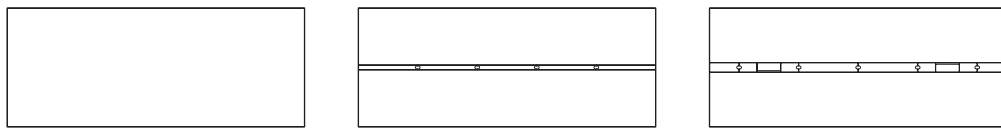

10A 10H 10K

300 x 100

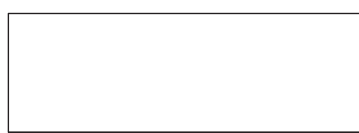

11A

SUGGESTED COMBINATIONS

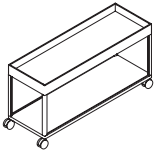

NO Combination 101

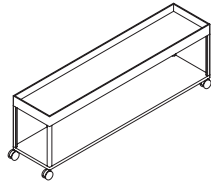

NO Combination 102

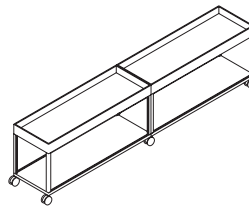

NO Combination 103

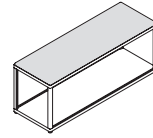

NO Bench combination 100

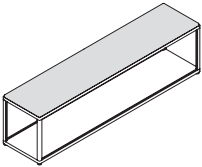

NO Bench combination 150

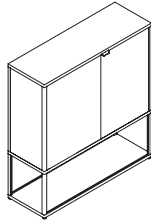

NO Combination 201

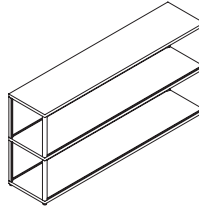

NO Combination 202

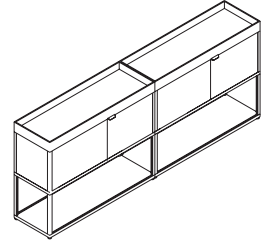

NO Combination 203

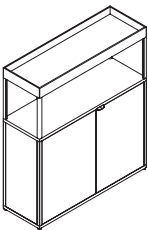

NO Combination 204

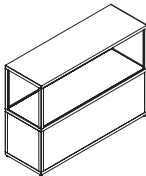

NO Combination 205

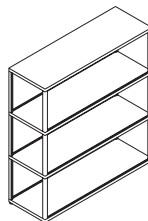

NO Combination 301

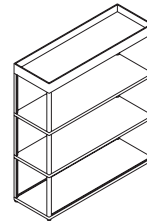

NO Combination 303

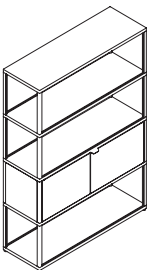

NO Combination 401

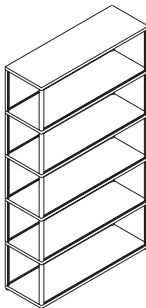

NO Combination 501

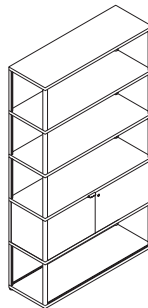

NO Combination 502

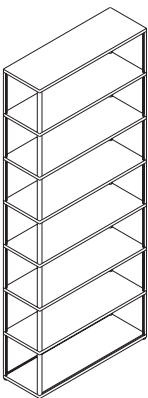

NO Combination 701

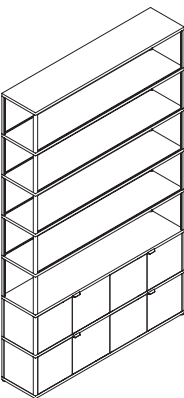

NO Combination 702

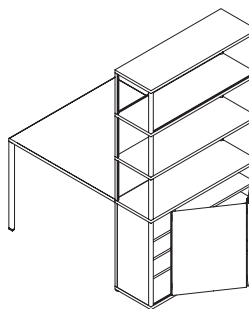

NO Table Combination 401

DIMENSIONS

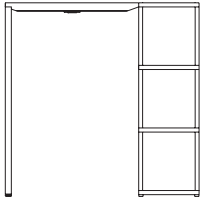

H110 cm

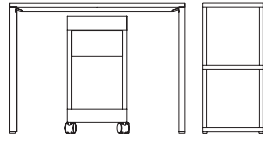

H68 cm

H74 cm

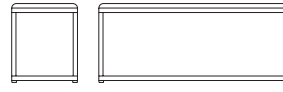

H45 cm

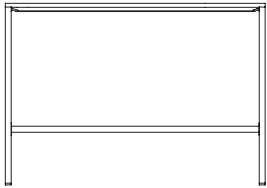

H105 cm

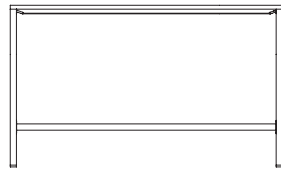

H95 cm

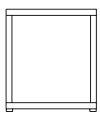

H38,5 cm

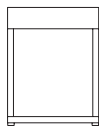

H44,5 cm



H74 cm



H79,5 cm

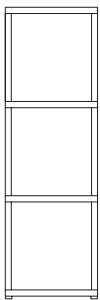

H110 cm

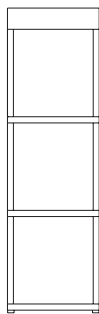

H115 cm



H250 cm

SHELF TOP | 34 | 100 | 150

23 mm shelf. Powder coated extruded aluminium. End parts in die cast aluminium.
Please note that wall- or floor safety brackets are needed above a certain height.
Please see the New Order instruction manuals for further information or contact our sales team.

Stock item



MATERIAL	COLOUR			
	Army	Charcoal	Light grey	Red
Powder coated extruded aluminium	•	•	•	•

VARIANT	DIMENSION	BOX DIMENSION WEIGHT	PACKAGING	PRICE
W34	W34 x D34 x H2,3 W13.39" x D13.39" x H0.91"	1 pcs. W39 x D39.5 x H10.5 2.31 kg	1 box 1 pcs.	90.00
W100	W100 x D34 x H2,3 W39.37" x D13.39" x H0.91"	1 pcs. W105 x D39.5 x H10.5 6.4 kg	1 box 1 pcs.	175.00
W150	W150 x D34 x H2,3 W59.06" x D13.39" x H0.91"	1 pcs. W155 x D39.5 x H10.5 9.1 kg	1 box 1 pcs.	250.00

SHELF MIDDLE | 34 | 100 | 150

23 mm shelf. Powder coated extruded aluminium. End parts in die cast aluminium.
Please note that wall- or floor safety brackets are needed above a certain height.
Please see the New Order instruction manuals for further information or contact our sales team.

Stock item

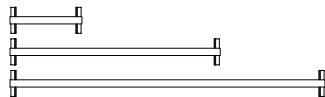

MATERIAL	COLOUR			
	Army	Charcoal	Light grey	Red
Powder coated extruded aluminium	•	•	•	•

VARIANT	DIMENSION	BOX DIMENSION WEIGHT	PACKAGING	PRICE
W34	W34 x D34 x H2,3 W13.39" x D13.39" x H0.91"	1 pcs. W39 x D39.5 x H14 2.46 kg	1 box 1 pcs.	90.00
W100	W100 x D34 x H2,3 W39.37" x D13.39" x H0.91"	1 pcs. W105 x D39.5 x H14 6.63 kg	1 box 1 pcs.	175.00
W150	W150 x D34 x H2,3 W59.06" x D13.39" x H0.91"	1 pcs. W155 x D39.5 x H14 9.18 kg	1 box 1 pcs.	250.00

SHELF BOTTOM | 34 | 100 | 150

23 mm shelf. Powder coated extruded aluminium. End parts in die cast aluminium.
Incl. adjustable feet. Please note that wall- or floor safety brackets are needed above a certain height.
Please see the New Order instruction manuals for further information or contact our sales team.

Stock item

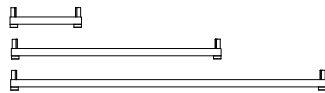

MATERIAL	COLOUR			
	Army	Charcoal	Light grey	Red
Powder coated extruded aluminium	•	•	•	•

VARIANT	DIMENSION	BOX DIMENSION WEIGHT	PACKAGING	PRICE
W34	W34 x D34 x H2,3 W13.39" x D13.39" x H0.91"	1 pcs. W39 x D39.5 x H10.5 2.42 kg	1 box 1 pcs.	90.00
W100	W100 x D34 x H2,3 W39.37" x D13.39" x H0.91"	1 pcs. W105 x D39.5 x H10.5 6.21 kg	1 box 1 pcs.	175.00
W150	W150 x D34 x H2,3 W59.06" x D13.39" x H0.91"	1 pcs. W155 x D39.5 x H10.5 9 kg	1 box 1 pcs.	250.00

TRAY TOP | 100 | 150

80 mm tray. Powder coated aluminum sides with steel bottom. End parts in die cast aluminium.
 Please note that wall- or floor safety brackets are needed above a certain height.
 Please see the New Order instruction manuals for further information or contact our sales team.

Stock item

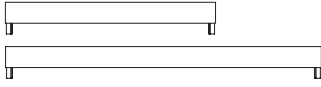

MATERIAL	COLOUR			
	Amy	Charcoal	Light grey	Red
Powder coated extruded aluminium	•	•	•	•

VARIANT	DIMENSION	BOX DIMENSION WEIGHT	PACKAGING	PRICE
W100	W100 x D34 x H8 W39.37" x D13.39" x H3.15"	1 pcs. W105 x D39.5 x H16 5.92 kg	1 box 1 pcs.	190.00
W150	W150 x D34 x H8 W59.06" x D13.39" x H3.15"	1 pcs. W155 x D39.5 x H16 8.3 kg	1 box 1 pcs.	265.00

SINGLE PROFILE | SET OF 4

Powder coated extruded aluminium. Incl. Premounted set screws. Single or double height.

Stock item

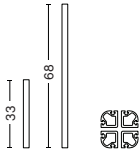

MATERIAL	COLOUR			
	Army	Charcoal	Light grey	Red
Powder coated extruded aluminium	•	•	•	•

VARIANT	DIMENSION	BOX DIMENSION WEIGHT	PACKAGING	PRICE
H33	W2,2 x D2,2 x H33 W0.87" x D0.87" x H12.99"	1 pcs. W34.5 x D5.5 x H5.5 0.87 kg	1 box 1 pcs.	40.00
H68	W2,2 x D2,2 x H68 W0.87" x D0.87" x H26.77"	1 pcs. W70 x D5.5 x H5.5 1.8 kg	1 box 1 pcs.	75.00

DOUBLE PROFILE | SET OF 2

Powder coated extruded aluminium. Incl. premounted set screws. Single or double height.

Stock item

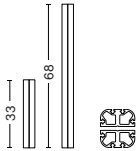

MATERIAL	COLOUR			
	Army	Charcoal	Light grey	Red
Powder coated extruded aluminium	•	•	•	•

VARIANT	DIMENSION	BOX DIMENSION WEIGHT	PACKAGING	PRICE
H33	W2,2 x D2,2 x H33 W0.87" x D0.87" x H12.99"	1 pcs. W34.5 x D5.5 x H5.5 0.87 kg	1 box 1 pcs.	40.00
H68	W2,2 x D2,2 x H68 W0.87" x D0.87" x H26.77"	1 pcs. W70 x D5.5 x H5.5 1.8 kg	1 box 1 pcs.	75.00

CORNER PROFILE | SET OF 1 + 1

Powder coated extruded aluminium. Incl. Premounted set screws. Single or double height.

Set of 1 x single + 1 x triple.

Stock item

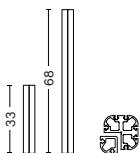

MATERIAL	COLOUR			
	Army	Charcoal	Light grey	Red
Powder coated extruded aluminium	•	•	•	•

VARIANT	DIMENSION	BOX DIMENSION WEIGHT	PACKAGING	PRICE
H33	W2,2 x D2,2 x H33 W0.87" x D0.87" x H12.99"	1 pcs. W34.5 x D5.5 x H5.5 0.87 kg	1 box 1 pcs.	40.00
H68	W2,2 x D2,2 x H68 W0.87" x D0.87" x H26.77"	1 pcs. W70 x D5.5 x H5.5 1.8 kg	1 box 1 pcs.	75.00

BENCHTOP | 34 | 100 | 150

MDF board with foam top upholstered with fabric or leather. Premounted with velcro for mounting. Please note shelving below benchtop should be open without panels, drawers or doors.

Order produced

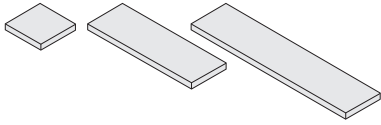

VARIANT	DIMENSION	BOX DIMENSION WEIGHT	PACKAGING	FABRIC	PRICE
	W34 x D34 x H2,3 W13.39" x D13.39" x H0.91"	1 pcs. W39 x D36 x H30 2 kg	1 box 1 pcs.	Remix Surface By HAY Steelcut Steelcut Trio Canvas Sierra Black Sense Cognac	100.00 100.00 100.00 100.00 110.00 145.00 180.00

VARIANT	DIMENSION	BOX DIMENSION WEIGHT	PACKAGING	FABRIC	PRICE
	W100 x D34 x H2,3 W39.37" x D13.39" x H0.91"	1 pcs. W105 x D36 x H5 3 kg	1 box 1 pcs.	Remix Surface By HAY Steelcut Steelcut Trio Canvas Sierra Black Sense Cognac	200.00 200.00 210.00 210.00 220.00 270.00 340.00

VARIANT	DIMENSION	BOX DIMENSION WEIGHT	PACKAGING	FABRIC	PRICE
	W150 x D34 x H2,3 W59.06" x D13.39" x H0.91"	1 pcs. W155 x D36 x H5 3.5 kg	1 box 1 pcs.	Remix Surface By HAY Steelcut Steelcut Trio Canvas Sierra Black Sense Cognac	280.00 280.00 295.00 295.00 320.00 400.00 500.00

WOODEN PANELS AND DOOR | 100 | 150

Set of doors and panels. 6 mm MDF with front and back veneer. 100 cm | Set of 1 sliding door, 2 side panels and 1 back panel. Opening right. 150 cm | Set of 2 doors, 2 sides panels and 1 back panel. Opening right and left. Incl. handle in Army, Light Grey or Charcoal. Please note that wooden panels and doors are not suitable for hard contract use.

Order produced



FINISH	SIZE	
	W100	W150
Untreated oak veneer	•	•
Untreated ash veneer	•	•

VARIANT	DIMENSION	BOX DIMENSION WEIGHT	PACKAGING	PRICE
W100	DOOR 100 W95,5 x D0,7 x H33 cm W37.6" x D0.28" x H12.99"	W108,5 x D43 x H4,2 cm 7,50 kg	1 box 1 pcs.	260.00
	BACK PANEL 100 W95 x D0,7 x H33 cm W37.40" x D0.28" x H12.99"			
	SIDE PANEL W29,5 x D0,7 x H33 cm W11.61" x D0.28" x H12.99"			

VARIANT	DIMENSION	BOX DIMENSION WEIGHT	PACKAGING	PRICE
W150	DOOR 150 W145,5 x D0,7 x H33 cm W57.29" x D0.28" x H12.99"	W163,50 x D45 x H4,2 cm 10 kg	1 box 1 pcs.	520.00
	BACK PANEL 150 W145 x D0,7 x H33 cm W57.09" x D0.28" x H12.99"			
	SIDE PANEL W29,5 x D0,7 x H33 cm W11.61" x D0.28" x H12.99"			

WOODEN PANELS AND DOOR | 100 LEFT

6 mm MDF with front and back veneer. Set of 1 sliding door, 2 side panels and 1 back panel. Opening Left. Incl. handle in Army, Light Grey or Charcoal. Please note that wooden panels and doors are not suitable for hard contract use.

Order produced



FINISH	SIZE	
	W100	
Untreated oak veneer	•	
Untreated ash veneer	•	

VARIANT	DIMENSION	BOX DIMENSION WEIGHT	PACKAGING	PRICE
W100	DOOR 100 W95,5 x D0,7 x H33 cm W37.6" x D0.28" x H12.99"	W108,5 x D43 x H4,2 cm 7,50 kg	1 box 1 pcs.	260.00
	BACK PANEL 100 W95 x D0,7 x H33 cm W37.40" x D0.28" x H12.99"			
	SIDE PANEL W29,5 x D0,7 x H33 cm W11.61" x D0.28" x H12.99"			

WOODEN WALL PANELS AND DOOR | 100 | 150

Set of doors and panels. 6 mm MDF with front and back veneer.

100 cm | Set of 1 sliding door, 2 side panels and 1 wall panel. Opening right. 150 cm | Set of 2 doors, 2 sides panels and 1 wall panel. Opening right and left. Incl. handle in Army, Light Grey or Charcoal. Wall brackets are sold separately. Please note that wooden panels and doors are not suitable for hard contract use.

Order produced

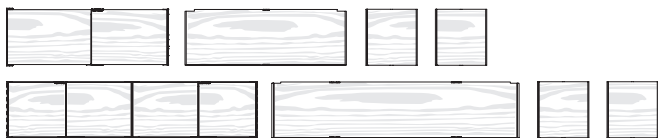

FINISH	SIZE	
	W100	W150
Untreated oak veneer	•	•
Untreated ash veneer	•	•

VARIANT	DIMENSION	BOX DIMENSION WEIGHT	PACKAGING	PRICE
W100	DOOR 100 W95,5 x D0,7 x H33 cm W37.6" x D0.28" x H12.99"	W108,5 x D43 x H4,2 cm 7,50 kg	1 box 1 pcs.	270.00
	BACK PANEL 100 W95 x D0,7 x H33 cm W37.40" x D0.28" x H12.99"			
	SIDE PANEL W29,5 x D0,7 x H33 cm W11.61" x D0.28" x H12.99"			

VARIANT	DIMENSION	BOX DIMENSION WEIGHT	PACKAGING	PRICE
W150	DOOR 150 W145,5 x D0,7 x H33 cm W57.29" x D0.28" x H12.99"	W163,50 x D45 x H4,2 cm 10 kg	1 box 1 pcs.	530.00
	BACK PANEL 150 W145 x D0,7 x H33 cm W57.09" x D0.28" x H12.99"			
	SIDE PANEL W29,5 x D0,7 x H33 cm W11.61" x D0.28" x H12.99"			

WOODEN WALL PANELS AND DOOR | 100 LEFT

Set of doors and panels. 6 mm MDF with front and back veneer.

Set of 1 sliding door, 2 side panels and 1 wall panel. Opening Left. Incl. handle in Army, Light Grey or Charcoal. Wall brackets are sold separately. Please note that wooden panels and doors are not suitable for hard contract use.

Order produced



FINISH	SIZE	
	W100	W150
Untreated oak veneer	•	•
Untreated ash veneer	•	•

VARIANT	DIMENSION	BOX DIMENSION WEIGHT	PACKAGING	PRICE
W100	DOOR 100 W95,5 x D0,7 x H33 cm W37.6" x D0.28" x H12.99"	W108,5 x D43 x H4,2 cm 7,50 kg	1 box 1 pcs.	270.00
	BACK PANEL 100 W95 x D0,7 x H33 cm W37.40" x D0.28" x H12.99"			
	SIDE PANEL W29,5 x D0,7 x H33 cm W11.61" x D0.28" x H12.99"			

STEEL SIDE PANEL | 34

STEEL SIDE PANEL DOUBLE HEIGHT 34

Powder coated steel.

Order produced

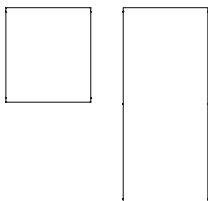

MATERIAL	COLOUR		
	Army	Charcoal	Light grey
Powder coated steel	•	•	•

VARIANT	DIMENSION	BOX DIMENSION WEIGHT	PACKAGING	PRICE
H33	W29,5 x D1,6 x H33 W11.61" x D0.63" x H12.99"	1 pcs. W29.5 x D1.6 x H33 1.5 kg	1 box 1 pcs.	40.00
H68	W29,5 x D1,6 x H68 W11.61" x D0.63" x H26.77"	1 pcs. W29.5 x D1.6 x H68 3 kg	1 box 1 pcs.	60.00

STEEL SIDE PANEL DOUBLE HEIGHT FOR ADJUSTABLE SHELF | 34

Powder coated steel. Adjustable shelves are ordered separately.

Order produced

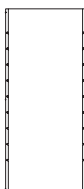

MATERIAL	COLOUR		
	Army	Charcoal	Light grey
Powder coated steel	•	•	•

VARIANT	DIMENSION	BOX DIMENSION WEIGHT	PACKAGING	PRICE
W100	W95,5 x D34 x H2,2 W37.60" x D13.39" x H0.87"	1 pcs. W95.5 x D34 x H2.2 4.5 kg	1 box 1 pcs.	80.00

STEEL SHELF FOR ADJUSTABLE PANELS | 100

1,25 mm shelf in powder coated steel. Incl. 4 pins in POM.

Order produced

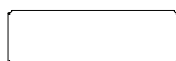

MATERIAL	COLOUR		
	Army	Charcoal	Light grey
Powder coated steel	•	•	•

VARIANT	DIMENSION	BOX DIMENSION WEIGHT	PACKAGING	PRICE
	W95,5 x D34 x H2,2 W37.60" x D13.39" x H0.87"	1 pcs. W95.5 x D34 x H2.2 4.5 kg	1 box 1 pcs.	80.00

PINS FOR ADJUSTABLE SHELF | SET OF 4

Set of 4 pins in POM

Order produced



MATERIAL	COLOUR		
	Army	Charcoal	Light grey
POM	•	•	•

VARIANT	DIMENSION	BOX DIMENSION WEIGHT	PACKAGING	PRICE
SET OF 4	W5 x D5 x H1 W1.97" x D1.97" x H0.39"	1 pcs. W5 x D5 x H1 0.04 kg	1 box 1 pcs.	11.00

STEEL BACK PANEL | 100 | 150

Powder coated steel.

Order produced



MATERIAL	COLOUR		
	Army	Charcoal	Light grey
Powder coated steel	•	•	•

VARIANT	DIMENSION	BOX DIMENSION WEIGHT	PACKAGING	PRICE
W100	W95,5 x D1,6 x H33 W37.60" x D0.63" x H12.99"	1 pcs. W95.5 x D1.6 x H33 4.5 kg	1 box 1 pcs.	60.00
W150	W145,5 x D1,6 x H33 W57.28" x D0.63" x H12.99"	1 pcs. W145.5 x D1.6 x H33 7 kg	1 box 1 pcs.	130.00

STEEL BACK PANEL DOUBLE HEIGHT | 100

Powder coated steel

Order produced



MATERIAL	COLOUR		
	Army	Charcoal	Light grey
Powder coated steel	•	•	•

VARIANT	DIMENSION	BOX DIMENSION WEIGHT	PACKAGING	PRICE
W100	W95,5 x D1,6 x H68 W37.60" x D0.63" x H26.77"	1 pcs. W95.5 x D1.6 x H68 9 kg	1 box 1 pcs.	100.00

STEEL WALL BACK PANEL | 100 | 150

Powder coated steel. With cutouts for wall brackets.

Order produced



MATERIAL	COLOUR		
	Army	Charcoal	Light grey
Powder coated steel	•	•	•

VARIANT	DIMENSION	BOX DIMENSION WEIGHT	PACKAGING	PRICE
W100	W95,5 x D1,6 x H33 W37.60" x D0.63" x H12.99"	1 pcs. W95.5 x D1.6 x H33 4.5 kg	1 box 1 pcs.	80.00
W150	W145,5 x D1,6 x H33 W57.28" x D0.63" x H12.99"	1 pcs. W145.5 x D1.6 x H33 7 kg	1 box 1 pcs.	145.00

STEEL WALL BACK PANEL DOUBLE HEIGHT | 100

Powder coated steel.

Order produced



MATERIAL	COLOUR		
	Army	Charcoal	Light grey
Powder coated steel	•	•	•

VARIANT	DIMENSION	BOX DIMENSION WEIGHT	PACKAGING	PRICE
H68	W95,5 x D1,6 x H68 cm W37.60" x D0.63" x H26.77"	W95,5 x D1,6 x H68 cm 9 kg	1 box 1 pcs.	115.00

STEEL TABLE PANEL | 34

STEEL TABLE PANEL DOUBLE HEIGHT | 34

Powder coated steel. Used under the tables when connecting tables with shelf or tray units. Incl. cutout for cables.

Order produced

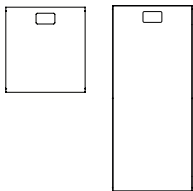

MATERIAL	COLOUR		
	Army	Charcoal	Light grey
Powder coated steel	•	•	•

VARIANT	DIMENSION	BOX DIMENSION WEIGHT	PACKAGING	PRICE
H32	W29,5 x D1,6 x H32 W11.61" x D0.63" x H12.60"	1 pcs. W29.5 x D1.6 x H32 1.5 kg	1 box 1 pcs.	50.00
H67	W29,5 x D1,6 x H67 W11.61" x D0.63" x H26.38"	1 pcs. W29.5 x D1.6 x H67 3 kg	1 box 1 pcs.	90.00

STEEL TABLE PANEL DOUBLE HEIGHT FOR ADJUSTABLE SHELF | 34

Powder coated steel. Used under the tables when connecting tables with shelf or tray units. Incl. cutout for cables.

Order produced

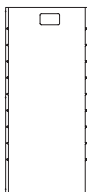

MATERIAL	COLOUR		
	Army	Charcoal	Light grey
Powder coated steel	•	•	•

VARIANT	DIMENSION	BOX DIMENSION WEIGHT	PACKAGING	PRICE
H67	W29,5 x D1,6 x H67 W11.61" x D0.63" x H26.38"	1 pcs. W29.5 x D1.6 x H67 3 kg	1 box 1 pcs.	80.00

STEEL TABLE BACK PANEL | 100 | 150

Powder coated steel. Used under the tables when connecting tables with shelf or tray units. Incl. cutout for cables.

Order produced



MATERIAL	COLOUR		
	Army	Charcoal	Light grey
Powder coated steel	•	•	•

VARIANT	DIMENSION	BOX DIMENSION WEIGHT	PACKAGING	PRICE
W100	W95,5 x D1,6 x H33 W37.60" x D0.63" x H12.99"	1 pcs. W95.5 x D1.6 x H33 4.5 kg	1 box 1 pcs.	80.00
W150	W145,5 x D1,6 x H33 W57.28" x D0.63" x H12.99"	1 pcs. W145.5 x D1.6 x H33 7 kg	1 box 1 pcs.	145.00

STEEL TABLE BACK PANEL DOUBLE HEIGHT | 100

Powder coated steel. Used under the tables when connecting tables with shelf or tray units. Incl. cutout for cables.

Order produced

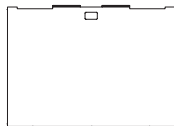

MATERIAL	COLOUR		
	Army	Charcoal	Light grey
Powder coated steel	•	•	•

VARIANT	DIMENSION	BOX DIMENSION WEIGHT	PACKAGING	PRICE
W100	W95,5 x D1,6 x H68 W37.60" x D0.63" x H26.77"	1 pcs. W95.5 x D1.6 x H68 9 kg	1 box 1 pcs.	115.00

STEEL PERFORATED BACK PANEL | 100 | 150

Powder coated steel

Order produced



MATERIAL	COLOUR		
	Army	Charcoal	Light grey
Powder coated steel	•	•	•

VARIANT	DIMENSION	BOX DIMENSION WEIGHT	PACKAGING	PRICE
W100	W95,5 x D1,6 x H33 W37.60" x D0.63" x H12.99"	1 pcs. W95.5 x D1.6 x H33 4.5 kg	1 box 1 pcs.	115.00
W150	W145,5 x D1,6 x H33 W57.28" x D0.63" x H12.99"	1 pcs. W145.5 x D1.6 x H33 7 kg	1 box 1 pcs.	200.00

STEEL PERFORATED BACK PANEL DOUBLE HEIGHT | 100

Powder coated steel.

Order produced

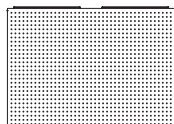

MATERIAL	COLOUR		
	Army	Charcoal	Light grey
Powder coated steel	•	•	•

VARIANT	DIMENSION	BOX DIMENSION WEIGHT	PACKAGING	PRICE
W100	W95,5 x D1,6 x H68 W37.60" x D0.63" x H26.77"	1 pcs. W95.5 x D1.6 x H68 9 kg	1 box 1 pcs.	180.00

MOUNTING ADAPTER TRAY

Plastic

Stock item

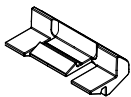

MATERIAL	COLOUR		
	Army	Charcoal	Light grey
Plastic	•	•	•

VARIANT	DIMENSION	BOX DIMENSION WEIGHT	PACKAGING	PRICE
PLASTIC	W4 x D1 x H1 W1.57" x D0.39" x H0.39"	1 pcs. W5 x D1 x H1 0.02 kg	1 box 1 pcs.	4.00

BACK PANEL FASTENER ADAPTER TRAY

Plastic

Stock item

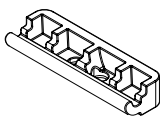

MATERIAL	COLOUR		
	Army	Charcoal	Light grey
Plastic	•	•	•

VARIANT	DIMENSION	BOX DIMENSION WEIGHT	PACKAGING	PRICE
PLASTIC	W4 x D1 x H1 W1.57" x D0.39" x H0.39"	1 pcs. W4 x D1 x H1 0.02 kg	1 box 1 pcs.	4.00

TEXTILE PANEL | 34 | 100 | 150

A foam-filled textile panel insert is mounted with fixed velcro onto a powder coated steel cover used on the outside or inside of the shelving. Textile on one side. Steel cover in army, charcoal or light grey.

Order produced

VARIANT	DIMENSION	BOX DIMENSION WEIGHT	PACKAGING	FABRIC	PRICE	COVER	
						COLOUR	Army Charcoal Light grey
						Powder coated steel	• • •
W34	W29,5 x D1,6 x H68 cm W11.61" x D0.63" x H26.77"	W29,5 x D1,6 x H33 cm 1,50 kg W29 x D1 x H32,5 cm 0,20 kg	1 box 1 pcs.	Remix Surface By HAY Steelcut Steelcut Trio Canvas	140.00 140.00 160.00 160.00 165.00		
W100	W95,5 x D1,6 x H33 cm W37.6" x D0.63" x H12.99"	W95,5 x D1,6 x H33 cm 4,5 kg W95 x D1 x H32,5 cm 0,80 kg	1 box 1 pcs.	Remix Surface By HAY Steelcut Steelcut Trio Canvas	250.00 250.00 290.00 290.00 300.00		
W150	W145,5 x D1,6 x H33 cm W57.28" x D0.637" x H12.99"	W145,5 x D1,6 x H33 cm 7 kg W145 x D1 x H32,5 cm 1,20 kg	1 box 1 pcs.	Remix Surface By HAY Steelcut Steelcut Trio Canvas	365.00 365.00 415.00 415.00 435.00		

INSIDE TEXTILE PANEL | 34 | 100 | 150

A foam-filled textile panel insert is mounted with fixed velcro onto a powder coated steel cover used on the outside or inside of the shelving. Textile on one side. Steel cover in army, charcoal or light grey.

Order produced

VARIANT	DIMENSION	BOX DIMENSION WEIGHT	PACKAGING	FABRIC	PRICE	COVER	
						COLOUR	Army Charcoal Light grey
						Powder coated steel	• • •
W34	W29,5 x D1,6 x H68 cm W11.61" x D0.63" x H26.77"	W29,5 x D1,6 x H33 cm 1,50 kg W29 x D1 x H32,5 cm 0,20 kg	1 box 1 pcs.	Remix Surface By HAY Steelcut Steelcut Trio Canvas	130.00 130.00 150.00 150.00 155.00		
W100	W95,5 x D1,6 x H33 cm W37.6" x D0.63" x H12.99"	W95,5 x D1,6 x H33 cm 4,5 kg W95 x D1 x H32,5 cm 0,80 kg	1 box 1 pcs.	Remix Surface By HAY Steelcut Steelcut Trio Canvas	230.00 230.00 270.00 270.00 280.00		
W150	W145,5 x D1,6 x H33 cm W57.28" x D0.637" x H12.99"	W145,5 x D1,6 x H33 cm 7 kg W145 x D1 x H32,5 cm 1,20 kg	1 box 1 pcs.	Remix Surface By HAY Steelcut Steelcut Trio Canvas	350.00 350.00 400.00 400.00 420.00		

TEXTILE SIDE PANEL DOUBLE HEIGHT | 34

A foam-filled textile panel insert is mounted with fixed velcro onto a powder coated steel cover used on the outside or inside of the shelving. Textile on one side. Steel cover in army, charcoal or light grey.

Order produced



COVER	COLOUR		
	Army	Charcoal	Light grey
Powder coated steel	•	•	•

VARIANT	DIMENSION	BOX DIMENSION WEIGHT	PACKAGING	FABRIC	PRICE
H68	W29,5 x D1,6 x H68 cm W11.61" x D0.63" x H26.77"	W29,5 x D1,6 x H68 cm 3 kg W29 cm xD1 x H67,5 cm 0,50 kg	1 box 1 pcs.	Remix Surface By HAY Steelcut Steelcut Trio Canvas	190.00 190.00 210.00 210.00 220.00

INSIDE TEXTILE SIDE PANEL DOUBLE HEIGHT | 34

A foam-filled textile panel insert is mounted with fixed velcro onto a powder coated steel cover used on the outside or inside of the shelving. Textile on one side. Steel cover in army, charcoal or light grey.

Order produced



COVER	COLOUR		
	Army	Charcoal	Light grey
Powder coated steel	•	•	•

VARIANT	DIMENSION	BOX DIMENSION WEIGHT	PACKAGING	FABRIC	PRICE
H68	W29,5 x D1,6 x H68 cm W11.61" x D0.63" x H26.77"	W29,5 x D1,6 x H68 cm 3 kg W29 cm xD1 x H67,5 cm 0,50 kg	1 box 1 pcs.	Remix Surface By HAY Steelcut Steelcut Trio Canvas	170.00 170.00 190.00 190.00 200.00

TEXTILE BACK PANEL DOUBLE HEIGHT | 100

A foam-filled textile panel insert is mounted with fixed velcro onto a powder coated steel cover used on the outside or inside of the shelving. Textile on one side. Steel cover in army, charcoal or light grey.

Order produced



COVER	COLOUR		
	Army	Charcoal	Light grey
Powder coated steel	•	•	•

VARIANT	DIMENSION	BOX DIMENSION WEIGHT	PACKAGING	FABRIC	PRICE
W100	W95,5 x D1,6 x H68 cm W37.6" x D0.63" x H26.77"	W95,5 x D1,6 x H68 cm 9 kg W95 x D1 x 67,5 cm 1,70 kg	1 box 1 pcs.	Remix Surface By HAY Steelcut Steelcut Trio Canvas	305.00 305.00 345.00 345.00 355.00

INSIDE TEXTILE BACK PANEL DOUBLE HEIGHT | 100

A foam-filled textile panel insert is mounted with fixed velcro onto a powder coated steel cover used on the outside or inside of the shelving. Textile on one side. Steel cover in army, charcoal or light grey.

Order produced



COVER	COLOUR		
	Army	Charcoal	Light grey
Powder coated steel	•	•	•

VARIANT	DIMENSION	BOX DIMENSION WEIGHT	PACKAGING	FABRIC	PRICE
W100	W95,5 x D1,6 x H68 cm W37.6" x D0.63" x H26.77"	W95,5 x D1,6 x H68 cm 9 kg W95 x D1 x 67,5 cm 1,70 kg	1 box 1 pcs.	Remix Surface By HAY Steelcut Steelcut Trio Canvas	290.00 290.00 330.00 330.00 340.00

STEEL SLIDING DOOR | 100 | 150

Powder coated steel. Incl. handle in extruded powder coated aluminium.

100 cm | 1 sliding door opening right.

150 cm | 2 sliding doors opening right and left.

Order produced



MATERIAL	COLOUR		
	Army	Charcoal	Light grey
Powder coated steel	•	•	•

VARIANT	DIMENSION	BOX DIMENSION WEIGHT	PACKAGING	PRICE
W100	W95,5 x D2,7 x H33 W37.60" x D1.06" x H12.99"	1 pcs. W95.5 x D2.7 x H33 6 kg	1 box 1 pcs.	180.00
W150	2 x W72,75 x D2,7 x H33 cm 2 x W28.64" x D1.06" x H12.99"	2 pcs. W72,75 x D2,7 x H33 cm 4,50 kg	1 box 1 pcs.	258.00

STEEL SLIDING DOOR | 100 LEFT

Powder coated steel. Incl. handle in extruded powder coated aluminium.

1 sliding door opening left.

Order produced



MATERIAL	COLOUR		
	Army	Charcoal	Light grey
Powder coated steel	•	•	•

VARIANT	DIMENSION	BOX DIMENSION WEIGHT	PACKAGING	PRICE
W100	W95,5 x D33 x H2,7 W37.60" x D12.99" x H1.06"	1 pcs. W95.5 x D33 x H2.7 6 kg	1 box 1 pcs.	180.00

STEEL SLIDING DOOR PREPARED FOR LOCK | 100 | 150

Powder coated steel. Incl. handle in extruded powder coated aluminium.

100 cm | 1 sliding door opening right.

150 cm | 2 sliding doors opening right and left.

Prepared for Häfele Symo Universal HS 3 locking system, Type 0601-0700. The lock cylinder is packed separately. To be mounted by customer. Master key 210.113 is an option. Please specify the number of the lock cylinder and the key between 0601-700.

Please note that 2 cylinders are needed for 1 set of 150 cm doors.

Order produced



MATERIAL	COLOUR		
	Army	Charcoal	Light grey
Powder coated steel	•	•	•

VARIANT	DIMENSION	BOX DIMENSION WEIGHT	PACKAGING	PRICE
W100	W95,5 x D2,7 x H33 W37.60" x D1.06" x H12.99"	1 pcs. W95.5 x D2.7 x H33 6 kg	1 box 1 pcs.	245.00
W150	2 x W72,75 x D2,7 x H33 cm 2 x W28.64" x D1.06" x H12.99"	2 pcs. W72,75 x D2,7 x H33 cm 4,50 kg	1 box 1 pcs.	380.00
ADD-ON FOR LOCK				
Lock cylinder - keys not incl. 210.41.603	W2,5 x D1,5 x H1,5 W0.98" x D0.59" x H0.59"	1 pcs. W5 x D2 x H2 0.1 kg	1 box 1 pcs.	+ 20.00
Extra Key for lock cylinder 210.11.058	W2,5 x D1,5 x H0,2 W0.98" x D0.59" x H0.08"	1 pcs. W4 x D1 x H1 0.02 kg	1 box 1 pcs.	+ 10.00

STEEL SLIDING DOOR PREPARED FOR LOCK | 100 LEFT

Powder coated steel. Incl. handle in extruded powder coated aluminium.

1 sliding door opening left.

Prepared for Häfele Symo Universal HS 3 locking system, Type 0601-0700. The lock cylinder is packed separately. To be mounted by customer. Master key 210.113 is an option. Please specify the number of the lock cylinder and the key between 0601-700.

Order produced

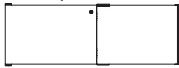

MATERIAL	COLOUR		
	Army	Charcoal	Light grey
Powder coated steel	•	•	•

VARIANT	DIMENSION	BOX DIMENSION WEIGHT	PACKAGING	PRICE
W100	W95,5 x D2,7 x H33 W37.60" x D1.06" x H12.99"	1 pcs. W95.5 x D2.7 x H33 6 kg	1 box 1 pcs.	245.00
ADD-ON FOR LOCK				
Lock cylinder - keys not incl. 210.41.603	W2,5 x D1,5 x H1,5 W0.98" x D0.59" x H0.59"	1 pcs. W5 x D2 x H2 0.1 kg	1 box 1 pcs.	+ 20.00
Extra Key for lock cylinder 210.11.058	W2,5 x D1,5 x H0,2 W0.98" x D0.59" x H0.08"	1 pcs. W4 x D1 x H1 0.02 kg	1 box 1 pcs.	+ 10.00

STEEL SLIDING DOOR DOUBLE HEIGHT | 100

Powder coated steel. Incl. handle in extruded powder coated aluminium. 1 sliding door opening right. Adjustable screw in the bottom to make sure you get the best fit.

Order produced

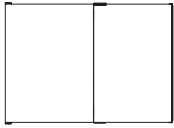

MATERIAL	COLOUR		
	Army	Charcoal	Light grey
Powder coated steel	•	•	•

VARIANT	DIMENSION	BOX DIMENSION WEIGHT	PACKAGING	PRICE
W100	W95,5 x D2,7 x H68 W37.60" x D1.06" x H26.77"	1 pcs. W95.5 x D2.7 x H68 12 kg	1 box 1 pcs.	280.00

STEEL SLIDING DOOR DOUBLE HEIGHT | 100 LEFT

Powder coated steel. Incl. handle in extruded powder coated aluminium. 1 sliding door opening left. Adjustable screw in the bottom to make sure you get the best fit.

Order produced

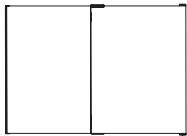

MATERIAL	COLOUR		
	Army	Charcoal	Light grey
Powder coated steel	•	•	•

VARIANT	DIMENSION	BOX DIMENSION WEIGHT	PACKAGING	PRICE
W100	W95,5 x D2,7 x H68 W37.60" x D1.06" x H26.77"	1 pcs. W95.5 x D2.7 x H68 12 kg	1 box 1 pcs.	280.00

STEEL SLIDING DOOR PREPARED FOR LOCK DOUBLE HEIGHT | 100

Powder coated steel. Incl. handle in extruded powder coated aluminium. 1 sliding door opening right. Adjustable screw in the bottom to make sure you get the best fit. Prepared for Häfele Symo Universal HS 3 locking system, Type 0601-0700. The lock cylinder is packed separately. To be mounted by customer. Master key 210.113 is an option. Please specify the number of the lock cylinder and the key between 0601-700.

Order produced

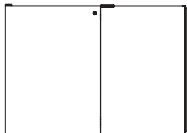

MATERIAL	COLOUR		
	Army	Charcoal	Light grey
Powder coated steel	•	•	•

VARIANT	DIMENSION	BOX DIMENSION WEIGHT	PACKAGING	PRICE
W100	W100 x D1 x H68 W39.37" x D0.39" x H26.77"	1 pcs. W100 x D1 x H68 12 kg	1 box 1 pcs.	345.00

ADD-ON FOR LOCK

Lock cylinder - keys not incl. 210.41.603	W2,5 x D1,5 x H1,5 W0.98" x D0.59" x H0.59"	1 pcs. W5 x D2 x H2 0.1 kg	1 box 1 pcs.	+ 20.00
Extra Key for lock cylinder 210.11.058	W2,5 x D1,5 x H0,2 W0.98" x D0.59" x H0.08"	1 pcs. W4 x D1 x H1 0.02 kg	1 box 1 pcs.	+ 10.00

STEEL SLIDING DOOR PREPARED FOR LOCK DOUBLE HEIGHT | 100 LEFT

Powder coated steel. Incl. handle in extruded powder coated aluminium. 1 sliding door opening left. Adjustable screw in the bottom to make sure you get the best fit. Prepared for Häfele Symo Universal HS 3 locking system, Type 0601-0700. The lock cylinder is packed separately. To be mounted by customer. Master key 210.113 is an option. Please specify the number of the lock cylinder and the key between 0601-700.

Order produced

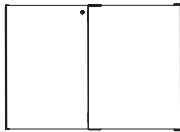

MATERIAL	COLOUR		
	Army	Charcoal	Light grey
Powder coated steel	•	•	•

VARIANT	DIMENSION	BOX DIMENSION WEIGHT	PACKAGING	PRICE
W100	W100 x D1 x H68 W39.37" x D0.39" x H26.77"	1 pcs. W100 x D1 x H68 12 kg	1 box 1 pcs.	345.00
ADD-ON FOR LOCK				
Lock cylinder - keys not incl. 210.41.603	W2,5 x D1,5 x H1,5 W0.98" x D0.59" x H0.59"	1 pcs. W5 x D2 x H2 0.1 kg	1 box 1 pcs.	+ 20.00
Extra Key for lock cylinder 210.11.058	W2,5 x D1,5 x H0,2 W0.98" x D0.59" x H0.08"	1 pcs. W4 x D1 x H1 0.02 kg	1 box 1 pcs.	+ 10.00

HIGH DRAWER INCL. MOUNTING SET | 34 | SET OF 1 OR DOUBLE HEIGHT | SET OF 2

Powder coated steel. It is possible to post mount lock bar or middle bar on double height drawers set of 2. Set of 2 drawers is used with double height profiles. Set of 1 drawer is used with single height profiles. Please note that all shelving units with drawers require wall- or floor safety brackets. Max load 15 kg. pr. drawer.

Order produced

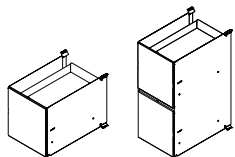

MATERIAL	COLOUR		
	Army	Charcoal	Light grey
Powder coated steel	•	•	•

VARIANT	DIMENSION	BOX DIMENSION WEIGHT	PACKAGING	PRICE
H33	W34 x D48 x H33 cm W13.39" x D18.90" x H12.99"		1 box 1 pcs.	540.00
H68	W34 x D48 x H68 cm W13.39" x D18.90" x H26.77"		1 box 1 pcs.	1,000.00

HIGH DRAWER INCL. MOUNTING SET100 | SET OF 1 OR DOUBLE HEIGHT | SET OF 2

Powder coated steel. It is possible to post mount lock bar or middle bar on double height drawers set of 2. Set of 2 drawers is used with double height profiles. Set of 1 drawer is used with single height profiles. Please note that all shelving units with drawers require wall- or floor safety brackets. Max load 15 kg. pr. drawer.

Order produced

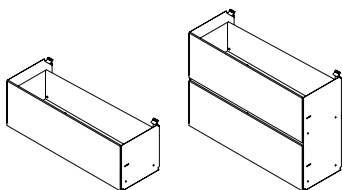

MATERIAL	COLOUR		
	Army	Charcoal	Light grey
Powder coated steel	•	•	•

VARIANT	DIMENSION	BOX DIMENSION WEIGHT	PACKAGING	PRICE
H33	W100 x D34 x H33 cm W39.37" x D13.36" x H12.99"		1 box 1 pcs.	600.00
H68	W100 x D34 x H68 cm W39.37" x D13.36" x H26.77"		1 box 1 pcs.	1,200.00

DRAWER INCL. MOUNTING SET 34 | SET OF 2 OR DOUBLE HEIGHT | SET OF 4

Powder coated steel. It is possible to post mount lock bar or middle bar. Set of 2 drawers is used with single height profiles. Set of 4 drawers is used with double height profiles. Please note that all shelving units with drawers require wall- or floor safety brackets. Max load 15 kg. pr. drawer.

Order produced

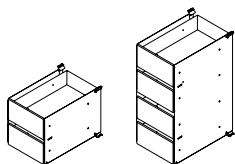

MATERIAL	COLOUR		
	Army	Charcoal	Light grey
Powder coated steel	•	•	•

VARIANT	DIMENSION	BOX DIMENSION WEIGHT	PACKAGING	PRICE
H33	W34 x D48 x H33 cm W13.39" x D18.90" x H12.99"		1 box 1 pcs.	820.00
H68	W34 x D48 x H68 cm W13.39" x D18.90" x H26.77"		1 box 1 pcs.	1,590.00

DRAWER INCL. MOUNTING SET 100 | SET OF 2 OR DOUBLE HEIGHT | SET OF 4

Powder coated steel. It is possible to post mount lock bar or middle bar. Set of 2 drawers is used with single height profiles. Set of 4 drawers is used with double height profiles. Please note that all shelving units with drawers require wall- or floor safety brackets. Max load 15 kg. pr. drawer.

Order produced

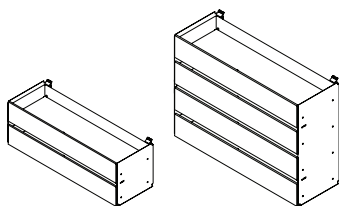

MATERIAL	COLOUR		
	Army	Charcoal	Light grey
Powder coated steel	•	•	•

VARIANT	DIMENSION	BOX DIMENSION WEIGHT	PACKAGING	PRICE
H33	W100 x D34 x H33 cm W39.37" x D13.36" x H12.99"		1 box 1 pcs.	940.00
H68	W100 x D34 x H68 cm W39.37" x D13.36" x H26.77"		1 box 1 pcs.	1,830.00

MIDDLE BAR FOR DRAWER | 34 | 100

Powder coated steel. Can be used to close the gap between two drawers. To be mounted by customer.

Order produced



MATERIAL	COLOUR		
	Army	Charcoal	Light grey
Powder coated steel	•	•	•

VARIANT	DIMENSION	BOX DIMENSION WEIGHT	PACKAGING	PRICE
W34	W29,5 x D6,8 x H2,6 W11.61" x D2.68" x H1.02"	1 pcs. W29.5 x D6.8 x H2.6 1 kg	1 box 1 pcs.	60.00
W100	W95,5 x D6,8 x H2,6 W37.60" x D2.68" x H1.02"	1 pcs. W95.5 x D6.8 x H2.6 2.5 kg	1 box 1 pcs.	80.00

LOCK BAR DRAWER PREPARED FOR LOCK 34 | 100

Powder coated steel. Can be used to close the gap between two drawers. Please note for set of 4 drawers only 2 lock bars and 1 middle bar. Prepared for Häfele Symo Universal HS 3 locking system, Type 0601-0700. The lock cylinder is packed separately. To be mounted by customer. Master key 210.113 is an option. Please specify the number of the lock cylinder and the key between 0601-700.

Order produced



MATERIAL	COLOUR		
	Army	Charcoal	Light grey
Powder coated steel	•	•	•

VARIANT	DIMENSION	BOX DIMENSION WEIGHT	PACKAGING	PRICE
W34	W29,5 x D6,8 x H2,6 W11.61" x D2.68" x H1.02"	1 pcs. W29.5 x D6.8 x H2.6 1 kg	1 box 1 pcs.	100.00
W100	W95,5 x D6,8 x H2,6 W37.60" x D2.68" x H1.02"	1 pcs. W95.5 x D6.8 x H2.6 2.5 kg	1 box 1 pcs.	120.00
ADD-ON FOR LOCK				
Lock cylinder - keys not incl. 210.41.603	W2,5 x D1,5 x H1,5 W0.98" x D0.59" x H0.59"	1 pcs. W5 x D2 x H2 0.1 kg	1 box 1 pcs.	+ 20.00
				+ 10.00

EXTRA LOCK CYLINDER

Lock cylinder core for left or right hand use. Nickel plated zinc alloy housing, brass plate levers. Standard locking system - Häfele Symo Universal HS 3, Type 0601-0700. Häfele item no. 210.41.603. Please specify the number of the lock cylinder and the key between 0601-700. Master key is an option.

Order produced



VARIANT	DIMENSION	BOX DIMENSION WEIGHT	PACKAGING	PRICE
EXTRA LOCK CYLINDER	W2,5 x D1,5 x H1,5 W0.98" x D0.59" x H0.59"	1 pcs. W5 x D2 x H2 0.1 kg	1 box 1 pcs.	20.00

EXTRA KEY FOR LOCK CYLINDER

Key for lock cylinder. Nickel-plated steel. Standard locking system - Häfele Symo Universal HS 3, Type 0601-0700. Häfele item no 210.11.058. Please specify the number of the lock cylinder and the key between 0601-700. Master key is an option.

Order produced



VARIANT	DIMENSION	BOX DIMENSION WEIGHT	PACKAGING	PRICE
EXTRA KEY FOR LOCK CYLINDER	W2,5 x D1,5 x H0,2 W0.98" x D0.59" x H0.08"	1 pcs. W4 x D1 x H1 0.02 kg	1 box 1 pcs.	10.00

MASTER KEY

Master key for Symo Universal cylinder core SYMO 3000-, HS3. Nickel plated steel. Häfele item no. 210.11.003

Order produced

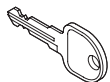

VARIANT	DIMENSION	BOX DIMENSION WEIGHT	PACKAGING	PRICE
MASTER KEY	W2,5 x D1,5 x H0,2 W0.98" x D0.59" x H0.08"	1 pcs. W0 x D0 x H0 0 kg	1 box 1 pcs.	20.00

EXCHANGE KEY FOR LOCK CYLINDER

Exchange key for removing the lock cylinder. Nickel plated steel. Häfele item no. 210.11.090

Order produced



VARIANT	DIMENSION	BOX DIMENSION WEIGHT	PACKAGING	PRICE
EXCHANGE KEY FOR LOCK CYLINDER	W2,5 x D1,5 x H0,2 W0.98" x D0.59" x H0.08"	1 pcs. W4 x D1 x H1 0.02 kg	1 box 1 pcs.	20.00

WALL BRACKET SHELF | SET OF 2

WALL BRACKET FOR DOUBLE HEIGHT SHELF | SET OF 2

Shelf bottom requires shelf wall bracket. Available for wooden- and steel wall panels.

Stock item

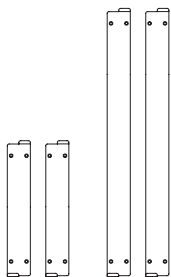

MATERIAL	COLOUR		
	Army	Charcoal	Light grey
Powder coated steel	•	•	•

VARIANT	DIMENSION	BOX DIMENSION WEIGHT	PACKAGING	PRICE
H36	W6 x D2,5 x H36 W2.36" x D0.98" x H14.17"	1 pcs. W44 x D6 x H2,5 1.70 kg	1 box 1 pcs.	20.00
H71	W6 x D2,5 x H71 cm W2.36" x D0.98" x H27.95"	1 pcs. W79 x D6 x H2,5 3.30 kg	1 box 1 pcs.	40.00

WALL SAFETY BRACKETS FOR SHELVING SYSTEM | SET OF 2

Powder coated steel and aluminium. Works with both shelf and tray. Can be used together with wooden wall panels or steel wall panels. Please follow the guidelines in our instruction manuals. It does not work with textile panels. wall screws and plugs are not incl. Max. 40 mm from the wall.

Stock item

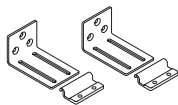

MATERIAL	COLOUR		
	Army	Charcoal	Light grey
Powder coated steel	•	•	•

VARIANT	DIMENSION	BOX DIMENSION WEIGHT	PACKAGING	PRICE
	W4 x D5,5 x H5 W1.57" x D2.17" x H1.97"	1 pcs. W4 x D5.5 x H5 12 kg	1 box 1 pcs.	20.00

FLOOR SAFETY BRACKETS FOR SHELVING SYSTEM | SET OF 2

Powder coated steel. Works with both shelf and tray. Please follow the guidelines in our instruction manuals. Floor screws and plugs are not incl.

Stock item

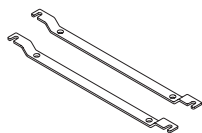

MATERIAL	COLOUR		
	Army	Charcoal	Light grey
Powder coated steel	•	•	•

VARIANT	DIMENSION	BOX DIMENSION WEIGHT	PACKAGING	PRICE
	W40 x D2 x H3 W15.75" x D0.79" x H1.18"	1 pcs. W40 x D2 x H3 0.7 kg	1 box 1 pcs.	40.00

REPAIR KIT

Laquer
Sales QTY.: min. 10 pcs. mix

Stock item



MATERIAL	COLOUR		
	Army	Charcoal	Light grey
Laquer	•	•	•

VARIANT	DIMENSION	BOX DIMENSION WEIGHT	PACKAGING	PRICE
	W2 x D2 x H6,5 W0.79" x D0.79" x H2.56"	1 pcs. W2 x D2 x H6.5 0.1 kg	1 box 1 pcs.	20.00

WHEELS | SET OF 4

Ø55 mm. Max. height with wheels is 2 layers - 1 bottom and 1 top. Can be mounted on both shelf and tray bottom.

Set of 4 (2 wheels with brake and 2 wheels without).

Stock item

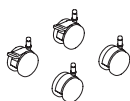

MATERIAL	COLOUR	
	Black	
Plastic	•	

VARIANT	DIMENSION	BOX DIMENSION WEIGHT	PACKAGING	PRICE
	W5,5 x D5,5 x H3,6 W2.17" x D2.17" x H1.42"	1 pcs. W18.5 x D16 x H4.5 0.4 kg	1 box 1 pcs.	40.00

SHELF BOOK DIVIDER | LEFT OR RIGHT

Book dividers in powder coated steel.

Stock item

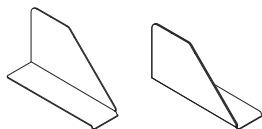

MATERIAL	COLOUR		
	Army	Charcoal	Light grey
Powder coated steel	•	•	•

VARIANT	DIMENSION	BOX DIMENSION WEIGHT	PACKAGING	PRICE
LEFT	W14 x D9 x H31,3 W5.51" x D3.54" x H12.32"	1 pcs. W35 x D20 x H10 0.7 kg	1 box 1 pcs.	30.00
RIGHT	W14 x D9 x H31,3 W5.51" x D3.54" x H12.32"	1 pcs. W35 x D20 x H10 0.7 kg	1 box 1 pcs.	30.00

TROLLEY A | 1 DRAWER & TRAY TOP

Trolley in powder coated steel, die cast extruded aluminium. Incl. 4 x Ø55 mm wheels, 2 with brake.
Incl. Standard locking system - Häfele Symo Universal HS, unsorted numbers.

Stock item

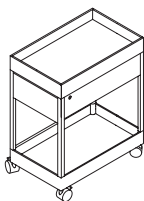

MATERIAL	COLOUR		
	Army	Charcoal	Light grey
Powder coated steel	•	•	•

VARIANT	DIMENSION	BOX DIMENSION WEIGHT	PACKAGING	PRICE
TROLLEY A	W34 x D55 x H67,5 W13.39" x D21.65" x H26.57"	1 pcs. W45 x D66 x H78 20 kg	1 box 1 pcs.	710.00

TROLLEY B | 3 DRAWER & TRAY TOP

Trolley in powder coated steel, die cast extruded aluminium. Incl. 4 x Ø55 mm wheels, 2 with brake.
Incl. Standard locking system - Häfele Symo Universal HS, unsorted numbers.

Stock item



MATERIAL	COLOUR		
	Army	Charcoal	Light grey
Powder coated steel	•	•	•

VARIANT	DIMENSION	BOX DIMENSION WEIGHT	PACKAGING	PRICE
TROLLEY B	W34 x D55 x H67,5 W13.39" x D21.65" x H26.57"	1 pcs. W45 x D66 x H78 27 kg	1 box 1 pcs.	970.00

TABLE | 4 LEGS

12 mm tabletop in MDF with linoleum or 10 mm tabletop in MDF with veneer.

Tabletop is placed inside the table frame. 4 legs incl. adjustable gliders.

Requires assembly.

Order produced

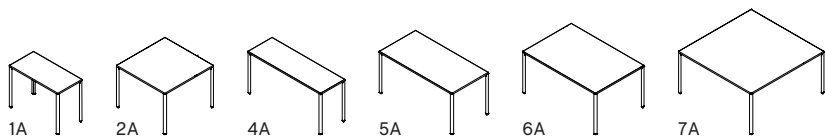

VARIANT	DIMENSION	BOX DIMENSION WEIGHT	PACKAGING	PRICE
1A	L100 x W50 x H74 cm L39.37" x W19.69" x 29.13"	W163 x D42 x H7,5 cm 7,0 kg W120 x D70 x H2,5 cm 7,3 kg W75 x D27 x H8 cm 11 kg	3 box 1 pcs.	1,010.00
2A	L100 x W100 x H74 cm L39.37" x W39.37" x 29.13"	W160 x D42 x H16 cm 12 kg W120 x D120 x H2,5 cm 12,9 kg W75 x D27 x H8 cm 11 kg	3 box 1 pcs.	1,180.00
4A	L150 x W50 x H74 cm L59.06 x W19.69 x 29.13"	W42 x D163 x H15,5 cm 8,5 kg W163,5 x D63,5 x H2,5 cm 9,8 kg W75 x D27 x H8 cm 11 kg	3 box 1 pcs.	1,280.00
5A	L150 x W75 x H74 cm L59.06 x W29.53 x 29.13"	W160 x D42 x H16 cm 9 kg W163,5 x D88,5 x H2,5 cm 14,6 kg W75 x D27 x H8 cm 11 kg	3 box 1 pcs.	1,390.00
6A	L150 x W100 x H74 cm L59.06 x W39.37" x 29.13"	W160 x D42 x H16 cm 14 kg W163,5 x D113,5 x H2,5 cm 19,3 kg W75 x D27 x H8 cm 11 kg	3 box 1 pcs.	1,385.00
7A	L150 x W150 x H74 cm L59.06 x W59.06 x 29.13"	W160 x D42 x H16 cm 18 kg W163,5 x D163,5 x H2,5 cm 28,7 kg W75 x D27 x H8 cm 11 kg	3 box 1 pcs.	1,625.00

FRAME & LEGS	TABLETOP			
Army powder coated aluminium	Cloud grey linoleum	Dark grey linoleum	Green linoleum	Grey linoleum
Charcoal powder coated aluminium	•	•	•	•
Light grey powder coated aluminium	•	•	•	•

TABLE | 4 LEGS

12 mm tabletop in MDF with linoleum or 10 mm tabletop in MDF with veneer.

Tabletop is placed inside the table frame. 4 legs incl. adjustable gliders.

Requires assembly.

Order produced

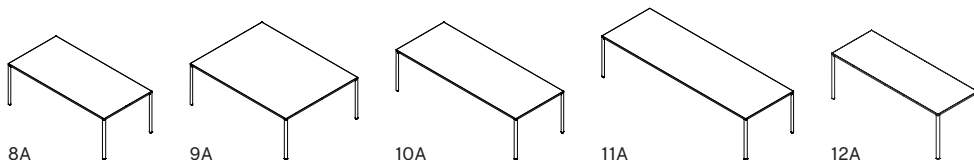

VARIANT	DIMENSION	BOX DIMENSION WEIGHT	PACKAGING	PRICE
8A	L200 x W100 x H74 cm L78.74" x W39.37" x 29.13"	W210 x D42 x H16 cm 18 kg W214 x D114 x H4,5 cm 32 kg W75 x D27 x H8 cm 6 kg	3 box 1 pcs.	1,615.00
9A	L200 x W75 x H74 cm L78.74" x W29.53" x 29.13"	W210 x D42 x H16 cm 16 kg W213,5 x D88,5 x H2,5 cm 19,1kg W79 x D27 x H8 cm 11 kg	3 box 1 pcs.	1,860.00
10A	L250 x W100 x H74 cm L78.74" x W39.37" x 29.13"	W252 x D42 x H16 cm 22 kg W264 x D114 x H4,5 cm 38 kg W75 x D27 x H8 cm 11 kg	3 box 1 pcs.	2,140.00
11A	L300 x W100 x H74 cm L98.43" x W39.37" x 29.13"	W320 x D20 x H14,5 cm 20 kg W314 x D114 x H4,5 cm 41 kg W75 x D27 x H8 cm 6 kg	3 box 1 pcs.	2,300.00
12A	L200 x W75 x H74 cm L78.74" x W29.53" x 29.13"	W210 x D42 x H16 cm 16 kg W213,5 x D88,5 x H2,5 cm 19,1kg W79 x D27 x H8 cm 11 kg	3 box 1 pcs.	1,585.00

FRAME & LEGS	TABLETOP			
Army powder coated aluminium	Cloud grey linoleum	Dark grey linoleum	Green linoleum	Grey linoleum
Charcoal powder coated aluminium	•	•	•	•
Light grey powder coated aluminium	•	•	•	•

TABLE INCL. SINGLE PLUG & PLAY | 4 LEGS

12 mm tabletop in MDF with linoleum or 10 mm tabletop in MDF with veneer. Incl. 2 x Single Plug & Play Center. Tabletop is placed inside the table frame. 4 legs incl. adjustable gliders. Requires assembly. STEP modules not included.

Order produced

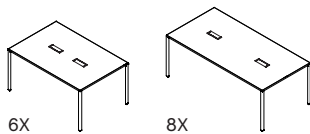

FRAME & LEGS		TABLETOP			
Army powder coated aluminium		Cloud grey linoleum			
Charcoal powder coated aluminium		Dark grey linoleum			
Light grey powder coated aluminium		Green linoleum			
		Grey linoleum			
		Water-based lacquered oak veneer			

VARIANT	DIMENSION	BOX DIMENSION WEIGHT	PACKAGING	PRICE
6X	L150 x W100 x H74 cm L59,06 x W39.37" x 29.13"	W160 x D42 x H16 cm 14 kg W163,5 x D113,5 x H2,5 cm 19,3 kg W75 x D27 x H8 cm 11 kg	3 box 1 pcs.	1,905.00
8X	L200 x W100 x H74 cm L78.74" x W39.37" x 29.13"	W210 x D42 x H16 cm 18 kg W214 x D114 x H4,5 cm 32 kg W75 x D27 x H8 cm 6 kg	3 box 1 pcs.	2,215.00

TABLE INCL. CABLE MANAGEMENT EDGE | 4 LEGS

12 mm tabletop in MDF with linoleum or 10 mm tabletop in MDF with veneer. Incl. 40 mm cable management cover. Tabletop is placed inside the table frame. 4 legs incl. adjustable gliders. Requires assembly. STEP modules not included.

Order produced

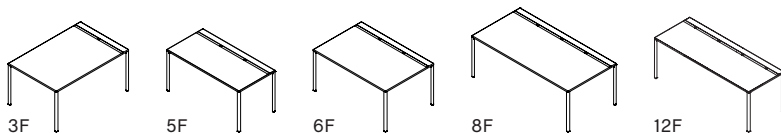

FRAME & LEGS		TABLETOP			
Army powder coated aluminium		Cloud grey linoleum			
Charcoal powder coated aluminium		Dark grey linoleum			
Light grey powder coated aluminium		Green linoleum			
		Grey linoleum			
		Water-based lacquered oak veneer			

VARIANT	DIMENSION	BOX DIMENSION WEIGHT	PACKAGING	PRICE
3F	L100 x W50 x H74 cm L39.37" x W19.69" x 29.13"	W160 x D42 x H16 cm 14 kg W164 x D114 x H4,5 cm 26 kg W75 x D27 x H8 cm 6 kg	3 box 1 pcs.	1,600.00
5F	L150 x W75 x H74 cm L59.06 x W29.53 x 29.13"	W160 x D42 x H16 cm 17 kg W75 x D27 x H8 cm 11 kg W164 x D89 x H4,5 cm 27 kg	3 box 1 pcs.	1,780.00
6F	L150 x W100 x H74 cm L59,06 x W39.37" x 29.13"	W160 x D42 x H16 cm 16 kg W75 x D27 x H8 cm 11 kg W164 x D114 x H4,5 cm 26 kg	3 box 1 pcs.	1,775.00
8F	L200 x W100 x H74 cm L78.74" x W39.37" x 29.13"	W202 x D42 x H14,5 cm 16 kg W75 x D27 x H8 cm 6 kg W214 x D114 x H4,5 cm 32 kg	3 box 1 pcs.	1,770.00
12F	L200 x W75 x H74 cm L78.74" x W29.53 x 29.13"	W210 x D42 x H16 cm 16 kg W213,5 x D88,5 x H2,5 cm 19,1kg W79 x D27 x H8 cm 11 kg	3 box 1 pcs.	2,060.00

TABLE INCL. PLUG & PLAY CABLE MANAGEMENT EDGE | 4 LEGS

12 mm tabletop in MDF with linoleum or 10 mm tabletop in MDF with veneer. Incl. 80 mm plug & play cable management cover. Tabletop is placed inside the table frame. 4 legs incl. adjustable gliders. Requires assembly. STEP modules not included.

Order produced

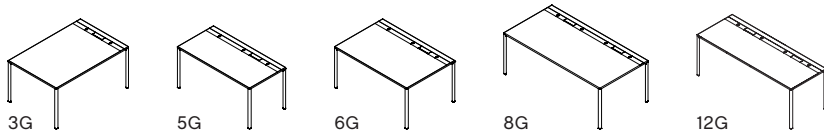

FRAME & LEGS	TABLETOP				
	Cloud grey linoleum	Dark grey linoleum	Green linoleum	Grey linoleum	Water-based lacquered oak veneer
Army powder coated aluminium	•	•	•	•	•
Charcoal powder coated aluminium	•	•	•	•	•
Light grey powder coated aluminium	•	•	•	•	•

VARIANT	DIMENSION	BOX DIMENSION WEIGHT	PACKAGING	PRICE
3G	L100 x W50 x H74 cm L39.37" x W19.69" x 29.13"	W160 x D42 x H16 cm 14 kg W164 x D114 x H4,5 cm 26 kg W75 x D27 x H8 cm 6 kg	3 box 1 pcs.	1,775.00
5G	L150 x W75 x H74 cm L59.06" x W29.53" x 29.13"	W160 x D42 x H16 cm 17 kg W75 x D27 x H8 cm 11 kg W164 x D89 x H4,5 cm 27 kg	3 box 1 pcs.	1,910.00
6G	L150 x W100 x H74 cm L59,06" x W39.37" x 29.13"	W160 x D42 x H16 cm 16 kg W75 x D27 x H8 cm 11 kg W164 x D114 x H4,5 cm 26 kg	3 box 1 pcs.	1,905.00
8G	L200 x W100 x H74 cm L78.74" x W39.37" x 29.13"	W202 x D42 x H14,5 cm 16 kg W75 x D27 x H8 cm 6 kg W214 x D114 x H4,5 cm 32 kg	3 box 1 pcs.	2,215.00
12G	L200 x W75 x H74 cm L78.74" x W29.53" x 29.13"	W210 x D42 x H16 cm 16 kg W213,5 x D88,5 x H2,5 cm 19,1kg W79 x D27 x H8 cm 11 kg	3 box 1 pcs.	2,190.00

TABLE INCL. CABLE MANAGEMENT EDGE 34 CM | 4 LEGS

12 mm tabletop in MDF with linoleum or 10 mm tabletop in MDF with veneer. Incl. 40 mm cable management cover. Tabletop is placed inside the table frame. 4 legs incl. adjustable gliders. Requires assembly. STEP modules not included.

Order produced

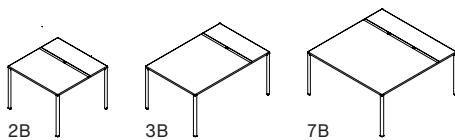

FRAME & LEGS	TABLETOP				
	Cloud grey linoleum	Dark grey linoleum	Green linoleum	Grey linoleum	Water-based lacquered oak veneer
Army powder coated aluminium	•	•	•	•	•
Charcoal powder coated aluminium	•	•	•	•	•
Light grey powder coated aluminium	•	•	•	•	•

VARIANT	DIMENSION	BOX DIMENSION WEIGHT	PACKAGING	PRICE
2B	L100 x W100 x H74 cm L39.37" x W39.37" x 29.13"	W160 x D42 x H16 cm 12 kg W114 x D114 x H4,5 cm 22 kg W75 x D27 x H8 cm 11 kg	3 box 1 pcs.	1,455.00
3B	L100 x W150 x H74 cm L39.37" x W59.06" x 29.13"	W160 x D42 x H16 cm 14 kg W164 x D114 x H4,5 cm 26 kg W75 x D27 x H8 cm 6 kg	3 box 1 pcs.	1,600.00
7B	L150 x W150 x H74 cm L59.06 x W59.06 x 29.13"	W160 x D42 x H16 cm 21 kg W164 x D89 x H9 cm 48 kg W75 x D27 x H8 cm 11 kg	3 box 1 pcs.	1,775.00

TABLE INCL. PLUG & PLAY CABLE MANAGEMENT EDGE 34 CM | 4 LEGS

12 mm tabletop in MDF with linoleum or 10 mm tabletop in MDF with veneer. Incl. 80 mm plug & play cable management cover. Tabletop is placed inside the table frame. 4 legs incl. adjustable gliders. Requires assembly. STEP modules not included.

Order produced

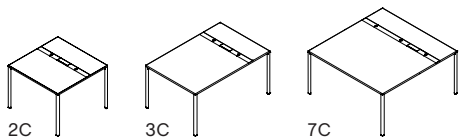

FRAME & LEGS	TABLETOP				
	Army powder coated aluminium	Cloud grey linoleum	Dark grey linoleum	Green linoleum	Grey linoleum
Charcoal powder coated aluminium	•	•	•	•	•
Light grey powder coated aluminium	•	•	•	•	•

VARIANT	DIMENSION	BOX DIMENSION WEIGHT	PACKAGING	PRICE
2C	L100 x W100 x H74 cm L39.37" x W39.37" x 29.13"	W160 x D42 x H16 cm 12 kg W114 x D114 x H4,5 cm 22 kg W75 x D27 x H8 cm 11 kg	3 box 1 pcs.	1,565.00
3C	L100 x W150 x H74 cm L39.37" x W59.06" x 29.13"	W160 x D42 x H16 cm 14 kg W164 x D114 x H4,5 cm 26 kg W75 x D27 x H8 cm 6 kg	3 box 1 pcs.	1,775.00
7C	L150 x W150 x H74 cm L59.06 x W59.06 x 29.13"	W160 x D42 x H16 cm 21 kg W164 x D89 x H9 cm 48 kg W75 x D27 x H8 cm 11 kg	3 box 1 pcs.	2,160.00

TABLE INCL. CABLE MANAGEMENT EDGE 34 CM | PREPARED FOR TOP TRAY DIVIDER | 4 LEGS

12 mm tabletop in MDF with linoleum or 10 mm tabletop in MDF with veneer. Incl. 40 mm cable management cover prepared for top divider edge. Tabletop is placed inside the table frame. 4 legs incl. adjustable gliders. Requires assembly. STEP modules, top tray and single profiles not included.

Order produced

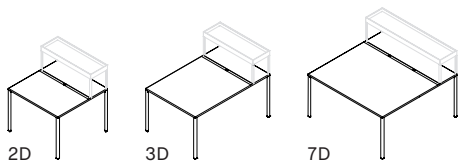

FRAME & LEGS	TABLETOP				
	Army powder coated aluminium	Cloud grey linoleum	Dark grey linoleum	Green linoleum	Grey linoleum
Charcoal powder coated aluminium	•	•	•	•	•
Light grey powder coated aluminium	•	•	•	•	•

VARIANT	DIMENSION	BOX DIMENSION WEIGHT	PACKAGING	PRICE
2D	L100 x W100 x H74 cm L39.37" x W39.37" x 29.13"	W160 x D42 x H16 cm 12 kg W114 x D114 x H4,5 cm 22 kg W75 x D27 x H8 cm 11 kg	3 box 1 pcs.	1,520.00
3D	L100 x W150 x H74 cm L39.37" x W59.06" x 29.13"	W160 x D42 x H16 cm 14 kg W164 x D114 x H4,5 cm 26 kg W75 x D27 x H8 cm 6 kg	3 box 1 pcs.	1,670.00
7D	L150 x W150 x H74 cm L59.06 x W59.06 x 29.13"	W160 x D42 x H16 cm 21 kg W164 x D89 x H9 cm 48 kg W75 x D27 x H8 cm 11 kg	3 box 1 pcs.	1,845.00

TABLE INCL. PLUG & PLAY CABLE MANAGEMENT EDGE 34 CM | PREPARED FOR TOP TRAY DIVIDER | 4 LEGS

12 mm tabletop in MDF with linoleum or 10 mm tabletop in MDF with veneer. Incl. 80 mm plug & play cable management cover prepared for top divider edge. Tabletop is placed inside the table frame. 4 legs incl. adjustable gliders. Requires assembly. STEP modules, top tray and single profiles not included.

Order produced

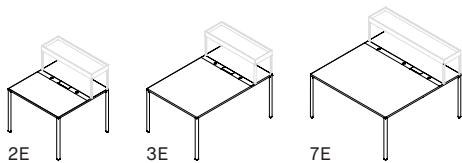

FRAME & LEGS		TABLETOP			
Army powder coated aluminium		Cloud grey linoleum			
Charcoal powder coated aluminium		Dark grey linoleum			
Light grey powder coated aluminium		Green linoleum			
		Grey linoleum			
		Water-based lacquered oak veneer			

VARIANT	DIMENSION	BOX DIMENSION WEIGHT	PACKAGING	PRICE
2E	L100 x W100 x H74 cm L39.37" x W39.37" x 29.13"	W160 x D42 x H16 cm 12 kg W114 x D114 x H4,5 cm 22 kg W75 x D27 x H8 cm 11 kg	3 box 1 pcs.	1,630.00
3E	L100 x W150 x H74 cm L39.37" x W59.06" x 29.13"	W160 x D42 x H16 cm 14 kg W164 x D114 x H4,5 cm 26 kg W75 x D27 x H8 cm 6 kg	3 box 1 pcs.	1,835.00
7E	L150 x W150 x H74 cm L59.06 x W59.06 x 29.13"	W160 x D42 x H16 cm 21 kg W164 x D89 x H9 cm 48 kg W75 x D27 x H8 cm 11 kg	3 box 1 pcs.	2,230.00

TABLE INCL. CABLE MANAGEMENT | PREPARED FOR TOP TRAY DIVIDER AND TABLE SCREENS EDGE | 4 LEGS

12 mm tabletop in MDF with linoleum or 10 mm tabletop in MDF with veneer. Incl. 40 mm cable management cover and prepared for top divider and table screens edge. Tabletop is placed inside the table frame. 4 legs incl. adjustable gliders. Requires assembly. Table screens, STEP modules, top tray and single profiles not included.

Order produced

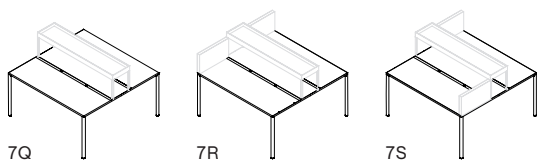

FRAME & LEGS		TABLETOP			
Army powder coated aluminium		Cloud grey linoleum			
Charcoal powder coated aluminium		Dark grey linoleum			
Light grey powder coated aluminium		Green linoleum			
		Grey linoleum			
		Water-based lacquered oak veneer			

VARIANT	DIMENSION	BOX DIMENSION WEIGHT	PACKAGING	PRICE
7Q	L150 x W150 x H74 cm L59.06 x W59.06 x 29.13"	W160 x D42 x H16 cm 21 kg W164 x D89 x H9 cm 48 kg W75 x D27 x H8 cm 11 kg	3 box 1 pcs.	2,120.00
7R	L150 x W150 x H74 cm L59.06 x W59.06 x 29.13"	W160 x D42 x H16 cm 21 kg W164 x D89 x H9 cm 48 kg W75 x D27 x H8 cm 11 kg	3 box 1 pcs.	2,310.00
7S	L150 x W150 x H74 cm L59.06 x W59.06 x 29.13"	W160 x D42 x H16 cm 21 kg W164 x D89 x H9 cm 48 kg W75 x D27 x H8 cm 11 kg	3 box 1 pcs.	2,310.00

TABLE INCL. PLUG & PLAY CABLE MANAGEMENT | PREPARED FOR TOP TRAY DIVIDER AND TABLE SCREENS EDGE | 4 LEGS

12 mm tabletop in MDF with linoleum or 10 mm tabletop in MDF with veneer. Incl. 80 mm plug & play cable management cover and prepared for top divider and table screens edge. Tabletop is placed inside the table frame. 4 legs incl. adjustable gliders. Requires assembly. Table screens, STEP modules, top tray and single profiles not included.

Order produced

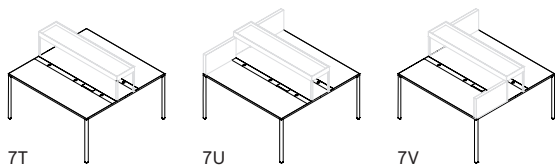

FRAME & LEGS		TABLETOP				
Army powder coated aluminium		Cloud grey linoleum				
Charcoal powder coated aluminium		Dark grey linoleum				
Light grey powder coated aluminium		Green linoleum				
		Grey linoleum				
		Water-based lacquered oak veneer				

VARIANT	DIMENSION	BOX DIMENSION WEIGHT	PACKAGING	PRICE
7T	L150 x W150 x H74 cm L59.06 x W59.06 x 29.13"	W160 x D42 x H16 cm 21 kg W164 x D89 x H9 cm 48 kg W75 x D27 x H8 cm 11 kg	3 box 1 pcs.	2,250.00
7U	L150 x W150 x H74 cm L59.06 x W59.06 x 29.13"	W160 x D42 x H16 cm 21 kg W164 x D89 x H9 cm 48 kg W75 x D27 x H8 cm 11 kg	3 box 1 pcs.	2,435.00
7V	L150 x W150 x H74 cm L59.06 x W59.06 x 29.13"	W160 x D42 x H16 cm 21 kg W164 x D89 x H9 cm 48 kg W75 x D27 x H8 cm 11 kg	3 box 1 pcs.	2,435.00

TABLE INCL. CABLE MANAGEMENT CENTER OR PREPARED FOR TABLE SCREENS | 4 LEGS

12 mm tabletop in MDF with linoleum or 10 mm tabletop in MDF with veneer. Incl. 40 mm cable management cover or prepared for table screens. Tabletop is placed inside the table frame. 4 legs incl. adjustable gliders. Requires assembly. Table screens and STEP modules not included.

Order produced

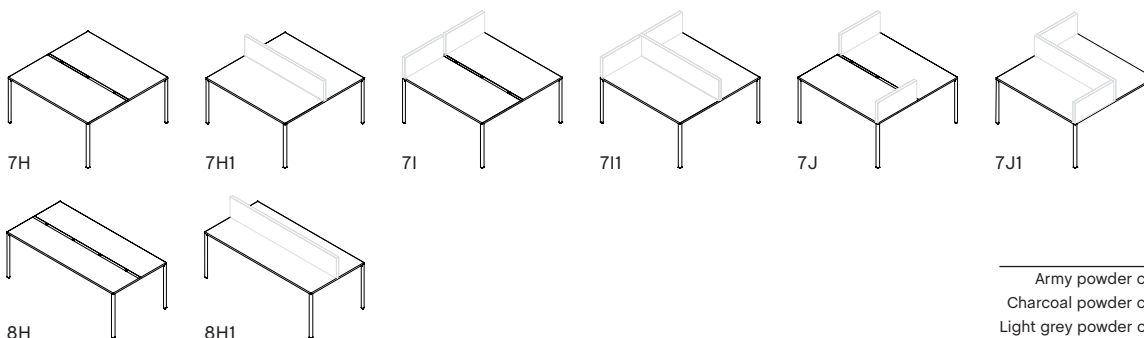

FRAME & LEGS		TABLETOP				
Army powder coated aluminium		Cloud grey linoleum				
Charcoal powder coated aluminium		Dark grey linoleum				
Light grey powder coated aluminium		Green linoleum				
		Grey linoleum				
		Water-based lacquered oak veneer				

VARIANT	DIMENSION	BOX DIMENSION WEIGHT	PACKAGING	PRICE
7H	L150 x W150 x H74 cm L59.06 x W59.06 x 29.13"	W160 x D42 x H16 cm 21 kg W164 x D89 x H9 cm 48 kg W75 x D27 x H8 cm 11 kg	3 box 1 pcs.	1,775.00
7H1	L150 x W150 x H74 cm L59.06 x W59.06 x 29.13"	W160 x D42 x H16 cm 21 kg W164 x D89 x H9 cm 48 kg W75 x D27 x H8 cm 11 kg	3 box 1 pcs.	1,775.00
7I	L150 x W150 x H74 cm L59.06 x W59.06 x 29.13"	W160 x D42 x H16 cm 21 kg W164 x D89 x H9 cm 48 kg W75 x D27 x H8 cm 11 kg	3 box 1 pcs.	2,230.00
7I1	L150 x W150 x H74 cm L59.06 x W59.06 x 29.13"	W160 x D42 x H16 cm 21 kg W164 x D89 x H9 cm 48 kg W75 x D27 x H8 cm 11 kg	3 box 1 pcs.	2,230.00
7J	L150 x W150 x H74 cm L59.06 x W59.06 x 29.13"	W160 x D42 x H16 cm 21 kg W164 x D89 x H9 cm 48 kg W75 x D27 x H8 cm 11 kg	3 box 1 pcs.	2,230.00
7J1	L150 x W150 x H74 cm L59.06 x W59.06 x 29.13"	W160 x D42 x H16 cm 21 kg W164 x D89 x H9 cm 48 kg W75 x D27 x H8 cm 11 kg	3 box 1 pcs.	2,230.00
8H	L200 x W100 x H74 cm L78.74" x W39.37" x 29.13"	W75 x D27 x H8 cm 11 kg W202 x D42 x H14,5 cm 16 kg W214 x D114 x H4,5 cm 32 kg	3 box 1 pcs.	1,770.00
8H1	L200 x W100 x H74 cm L78.74" x W39.37" x 29.13"	W75 x D27 x H8 cm 11 kg W202 x D42 x H14,5 cm 16 kg W214 x D114 x H4,5 cm 32 kg	3 box 1 pcs.	1,770.00

TABLE INCL. CABLE MANAGEMENT CENTER OR PREPARED FOR TABLE SCREENS | 4 LEGS

12 mm tabletop in MDF with linoleum or 10 mm tabletop in MDF with veneer. Incl. 40 mm cable management cover or prepared for table screens. Tabletop is placed inside the table frame. 4 legs incl. adjustable gliders. Requires assembly. Table screens and STEP modules not included.

Order produced

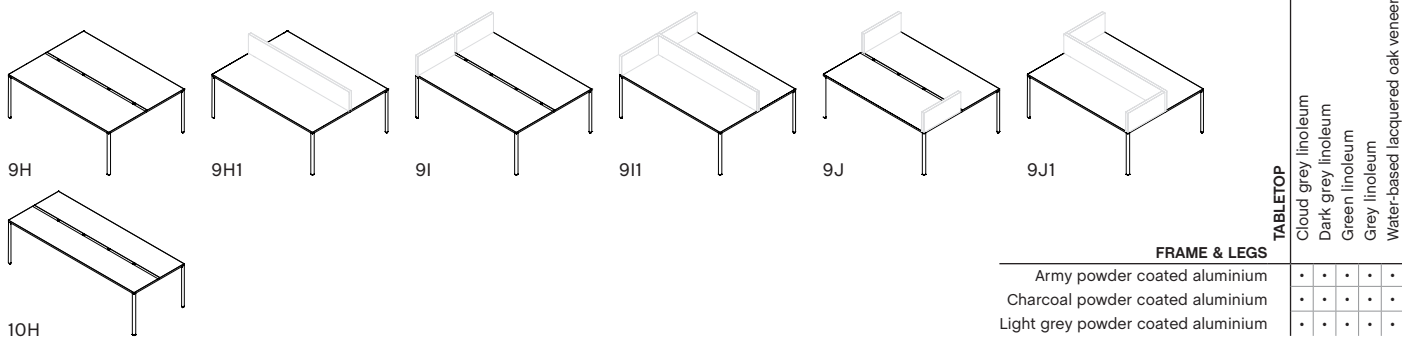

VARIANT	DIMENSION	BOX DIMENSION WEIGHT	PACKAGING	PRICE
9H	L200 x W150 x H74 cm L78.74" x W150 x H74 cm	W252 x D42 x H16 cm 22 kg W214 x D89 x H9 cm 38 kg W75 x D27 x H8 cm 6 kg	3 box 1 pcs.	2,010.00
9H1	L200 x W150 x H74 cm L78.74" x W150 x H74 cm	W252 x D42 x H16 cm 22 kg W214 x D89 x H9 cm 38 kg W75 x D27 x H8 cm 6 kg	3 box 1 pcs.	2,010.00
9I	L200 x W150 x H74 cm L78.74" x W150 x H74 cm	W252 x D42 x H16 cm 22 kg W214 x D89 x H9 cm 38 kg W75 x D27 x H8 cm 6 kg	3 box 1 pcs.	2,530.00
9I1	L200 x W150 x H74 cm L78.74" x W150 x H74 cm	W252 x D42 x H16 cm 22 kg W214 x D89 x H9 cm 38 kg W75 x D27 x H8 cm 6 kg	3 box 1 pcs.	2,530.00
9J	L200 x W150 x H74 cm L78.74" x W150 x H74 cm	W252 x D42 x H16 cm 22 kg W214 x D89 x H9 cm 38 kg W75 x D27 x H8 cm 6 kg	3 box 1 pcs.	2,530.00
9J1	L200 x W150 x H74 cm L78.74" x W150 x H74 cm	W252 x D42 x H16 cm 22 kg W214 x D89 x H9 cm 38 kg W75 x D27 x H8 cm 6 kg	3 box 1 pcs.	2,530.00
10H	L250 x W100 x H74 cm L98.43" x W39.37" x 29.13"	W252 x D42 x H16 cm 20 kg W264 x D114 x H4,5 cm 38 kg W75 x D27 x H8 cm 6 kg	3 box 1 pcs.	2,300.00

TABLE INCL. PLUG & PLAY CABLE MANAGEMENT CENTER OR PREPARED FOR TABLE SCREENS | 4 LEGS

12 mm tabletop in MDF with linoleum or 10 mm tabletop in MDF with veneer. Incl. 80 mm plug & play cable management cover or prepared for table screens. Tabletop is placed inside the table frame. 4 legs incl. adjustable gliders. Requires assembly. Table screens and STEP modules not included.

Order produced

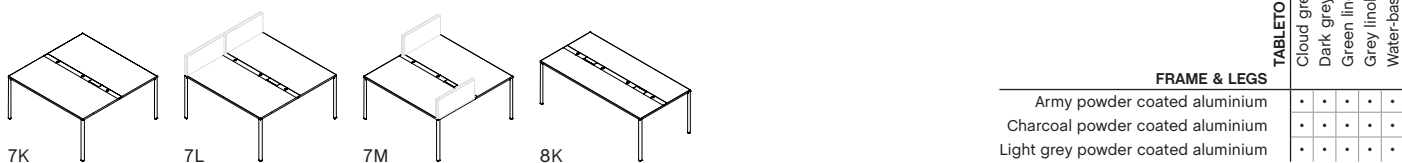

VARIANT	DIMENSION	BOX DIMENSION WEIGHT	PACKAGING	PRICE
7K	L150 x W150 x H74 cm L59.06 x W59.06 x 29.13"	W252 x D42 x H16 cm 22 kg W214 x D89 x H9 cm 38 kg W75 x D27 x H8 cm 6 kg	3 box 1 pcs.	2,160.00
7L	L150 x W150 x H74 cm L59.06 x W59.06 x 29.13"	W252 x D42 x H16 cm 22 kg W214 x D89 x H9 cm 38 kg W75 x D27 x H8 cm 6 kg	3 box 1 pcs.	2,360.00
7M	L150 x W150 x H74 cm L59.06 x W59.06 x 29.13"	W252 x D42 x H16 cm 22 kg W214 x D89 x H9 cm 38 kg W75 x D27 x H8 cm 6 kg	3 box 1 pcs.	2,360.00
8K	L250 x W100 x H74 cm L98.43" x W39.37" x 29.13"	W252 x D42 x H16 cm 20 kg W264 x D114 x H4,5 cm 38 kg W75 x D27 x H8 cm 6 kg	3 box 1 pcs.	2,215.00

TABLE INCL. PLUG & PLAY CABLE MANAGEMENT CENTER OR PREPARED FOR TABLE SCREENS | 4 LEGS

12 mm tabletop in MDF with linoleum or 10 mm tabletop in MDF with veneer. Incl. 80 mm plug & play cable management cover or prepared for table screens. Tabletop is placed inside the table frame. 4 legs incl. adjustable gliders. Requires assembly. Table screens and STEP modules not included.

Order produced

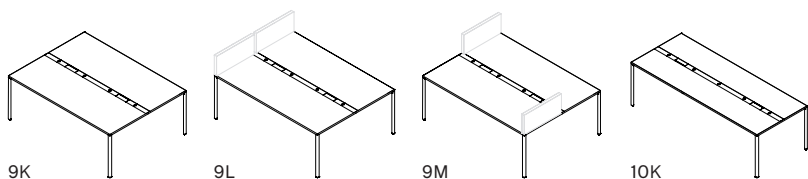

FRAME & LEGS	TABLETOP			
	Army powder coated aluminium	Cloud grey linoleum	Dark grey linoleum	Green linoleum
Charcoal powder coated aluminium	•	•	•	•
Light grey powder coated aluminium	•	•	•	•

VARIANT	DIMENSION	BOX DIMENSION WEIGHT	PACKAGING	PRICE
9K	L200 x W150 x H74 cm L78.74" x W150 x H74 cm	W202 x D42 x H14,5 cm 16 kg W75 x D27 x H8 cm 6 kg W214 x D114 x H4,5 cm 32 kg	3 box 1 pcs.	2,460.00
9L	L200 x W150 x H74 cm L78.74" x W150 x H74 cm	W202 x D42 x H14,5 cm 16 kg W75 x D27 x H8 cm 6 kg W214 x D114 x H4,5 cm 32 kg	3 box 1 pcs.	2,660.00
9M	L200 x W150 x H74 cm L78.74" x W150 x H74 cm	W160 x D42 x H16 cm 21 kg W164 x D89 x H9 cm 48 kg W75 x D27 x H8 cm 11 kg	3 box 1 pcs.	2,660.00
10K	L150 x W150 x H74 cm L59.06 x W59.06 x 29.13"	W202 x D42 x H14,5 cm 16 kg W75 x D27 x H8 cm 6 kg W214 x D114 x H4,5 cm 32 kg	3 box 1 pcs.	2,815.00

TABLE INCL. DOUBLE PLUG & PLAY CABLE MANAGEMENT CENTER IN COMBINATION WITH TABLE SCREENS | 4 LEGS

12 mm tabletop in MDF with linoleum or 10 mm tabletop in MDF with veneer. Incl. 80 mm plug & play cable management cover and prepared for table screens. Tabletop is placed inside the table frame. 4 legs incl. adjustable gliders. Requires assembly. Table screens and STEP modules not included.

Order produced

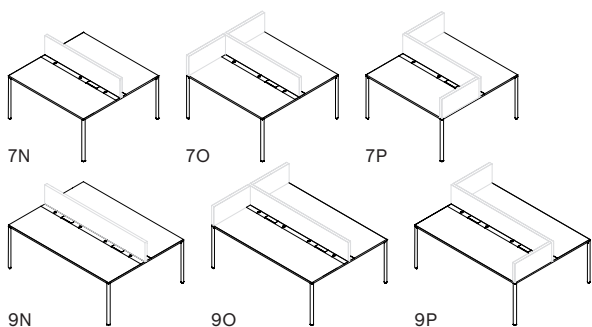

FRAME & LEGS	TABLETOP			
	Army powder coated aluminium	Cloud grey linoleum	Dark grey linoleum	Green linoleum
Charcoal powder coated aluminium	•	•	•	•
Light grey powder coated aluminium	•	•	•	•

VARIANT	DIMENSION	BOX DIMENSION WEIGHT	PACKAGING	PRICE
7N	L150 x W150 x H74 cm L59.06 x W59.06 x 29.13"	W160 x D42 x H16 cm 21 kg W164 x D89 x H9 cm 48 kg W75 x D27 x H8 cm 11 kg	3 box 1 pcs.	2,290.00
7O	L150 x W150 x H74 cm L59.06 x W59.06 x 29.13"	W160 x D42 x H16 cm 21 kg W164 x D89 x H9 cm 48 kg W75 x D27 x H8 cm 11 kg	3 box 1 pcs.	2,495.00
7P	L150 x W150 x H74 cm L59.06 x W59.06 x 29.13"	W160 x D42 x H16 cm 21 kg W164 x D89 x H9 cm 48 kg W75 x D27 x H8 cm 11 kg	3 box 1 pcs.	2,495.00
9N	L150 x W150 x H74 cm L59.06 x W59.06 x 29.13"	W202 x D42 x H14,5 cm 16 kg W75 x D27 x H8 cm 6 kg W214 x D114 x H4,5 cm 32 kg	3 box 1 pcs.	2,540.00
9O	L200 x W150 x H74 cm L78.74" x W150 x H74 cm	W252 x D42 x H16 cm 22 kg W214 x D89 x H9 cm 38 kg W75 x D27 x H8 cm 6 kg	3 box 1 pcs.	2,735.00
9P	L200 x W150 x H74 cm L78.74" x W150 x H74 cm	W252 x D42 x H16 cm 22 kg W214 x D89 x H9 cm 38 kg W75 x D27 x H8 cm 6 kg	3 box 1 pcs.	2,735.00

TABLE SCREEN EDGE | 58 | 73

Wood structure with MDF panels, 3 mm foam layer upholstered with textile. Incl. integrated brackets for mounting on the frame. Table screen edge can be mounted on tables in width 150 cm. Table screen edge 58 to be used in combination with top tray dividers.

Order produced



VARIANT	DIMENSION	BOX DIMENSION WEIGHT	PACKAGING	FABRIC	PRICE
W58	W58 x D5 x H75 W22.83" x D1.97" x H29.53"	1 pcs. W58 x D5 x H33 3.6 kg	1 box 1 pcs.	Remix	375.00
				Surface By HAY	375.00
				Steelcut	415.00
				Steelcut Trio	415.00
Canvas	425.00				

VARIANT	DIMENSION	BOX DIMENSION WEIGHT	PACKAGING	FABRIC	PRICE
W73	W73 x D4 x H33 W28.74" x D1.57" x H12.99"	1 pcs. W73 x D4 x H33 4.3 kg	1 box 1 pcs.	Remix	375.00
				Surface By HAY	375.00
				Steelcut	415.00
				Steelcut Trio	415.00
Canvas	425.00				

TABLE SCREEN MIDDLE | 100 | 150 | 200

Wood structure with MDF panels, 3 mm foam layer upholstered with textile. Incl. integrated brackets for mounting into the frame. Table screen middle is mounted on the support bar.

Order produced



VARIANT	DIMENSION	BOX DIMENSION WEIGHT	PACKAGING	FABRIC	PRICE
W100	W100 x D4 x H33 W39.37" x D1.57" x H12.99"	1 pcs. W100 x D4 x H33 5.5 kg	1 box 1 pcs.	Remix	375.00
				Surface By HAY	375.00
				Steelcut	415.00
				Steelcut Trio	415.00
Canvas	425.00				

VARIANT	DIMENSION	BOX DIMENSION WEIGHT	PACKAGING	FABRIC	PRICE
W150	W150 x D4 x H33 W59.06" x D1.57" x H12.99"	1 pcs. W150 x D4 x H33 7.2 kg	1 box 1 pcs.	Remix	500.00
				Surface By HAY	500.00
				Steelcut	555.00
				Steelcut Trio	555.00
Canvas	565.00				

VARIANT	DIMENSION	BOX DIMENSION WEIGHT	PACKAGING	FABRIC	PRICE
W200	W200 x D4 x H33 W78.74" x D1.57" x H12.99"	1 pcs. W200 x D4 x H33 10.8 kg	1 box 1 pcs.	Remix	695.00
				Surface By HAY	695.00
				Steelcut	745.00
				Steelcut Trio	745.00
Canvas	760.00				

TABLE LEGS

Powder coated extruded aluminium. Incl. adjustable gliders.

Stock item

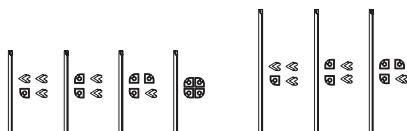

MATERIAL	COLOUR		
	Army	Charcoal	Light grey
Powder coated extruded aluminium	•	•	•

VARIANT	BOX DIMENSION WEIGHT	PACKAGING	PRICE
H74 SET OF 1	1 pcs. W79 x D27 x H8 7.5 kg	1 box 1 pcs.	210.00
H74 SET OF 2	1 pcs. W79 x D27 x H8 8.5 kg	1 box 1 pcs.	285.00
H74 SET OF 3	1 pcs. W79 x D27 x H8 10 kg	1 box 1 pcs.	370.00
H74 SET OF 4	1 pcs. W79 x D27 x H8 11 kg	1 box 1 pcs.	440.00
H110 SET OF 1	1 pcs. W115 x D27 x H8 11 kg	1 box 1 pcs.	220.00
H110 SET OF 2	1 pcs. W115 x D27 x H8 13 kg	1 box 1 pcs.	310.00
H110 SET OF 3	1 pcs. W115 x D27 x H8 15 kg	1 box 1 pcs.	400.00

DOUBLE TABLE LEGS

Powder coated extruded aluminium. Incl. adjustable gliders.

Stock item

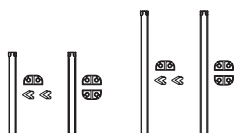

MATERIAL	COLOUR		
	Army	Charcoal	Light grey
Powder coated extruded aluminium	•	•	•

VARIANT	BOX DIMENSION WEIGHT	PACKAGING	PRICE
H74 SET OF 1	1 pcs. W79 x D27 x H8 8.5 kg	1 box 1 pcs.	285.00
H74 SET OF 2	1 pcs. W79 x D27 x H8 11 kg	1 box 1 pcs.	440.00
H110 SET OF 1	1 pcs. W115 x D27 x H8 13 kg	1 box 1 pcs.	310.00
H110 SET OF 2	1 pcs. W115 x D27 x H8 X kg	1 box 1 pcs.	490.00

TABLE CONNECTORS

Powder coated steel

Stock item

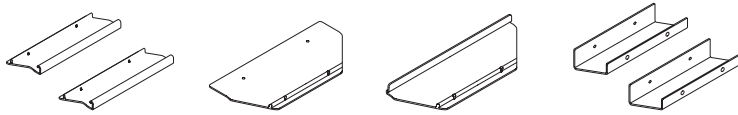

MATERIAL	COLOUR		
	Army	Charcoal	Light grey
Powder coated steel	•	•	•

VARIANT	BOX DIMENSION WEIGHT	PACKAGING	PRICE
FRONT SET OF 2	1 pcs. W26.5 x D15 x H7.5 0.5 kg	1 box 1 pcs.	30.00
END SHELF	1 pcs. W28 x D10 x H1.5 0.25 kg	1 box 1 pcs.	30.00
END TRAY	1 pcs. W28 x D13.5 x H1.5 0.25 kg	1 box 1 pcs.	30.00
WALL SET OF 2	1 pcs. W26 x D15.5 x H7.5 0.7 kg	1 box 1 pcs.	60.00

CABLE CLIP | SET OF 2

Black PP plastic. To be mounted in the frame channel underneath the table or in a support bar to hold cables. Max. 3 standard cables.

Stock item

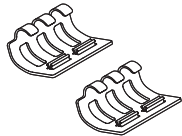

MATERIAL	COLOUR
	Black
PP Plastic	•

VARIANT	DIMENSION	BOX DIMENSION WEIGHT	PACKAGING	PRICE
SET OF 2	W6 x D4 x H3 W2.36" x D1.57" x H1.18"	1 pcs. W6.5 x D4.5 x H3.5 0.05 kg	1 box 1 pcs.	4.00

CABLE GUIDE FOR TABLE LEG | H74

ABS plastic. Recommended for maximum 3 standard cables.

Stock item

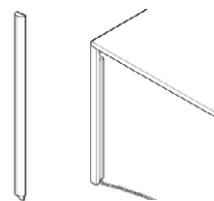

MATERIAL	COLOUR		
	Army	Charcoal	Light grey
ABS Plastic	•	•	•

VARIANT	DIMENSION	BOX DIMENSION WEIGHT	PACKAGING	PRICE
H74	W3,30 x D2,2 x H64 cm W1,3" x D0,87" x H25,2"	1 pcs. W3,30 x D2,2 x H64 cm 0,05 kg	1 box 1 pcs.	4.00

HIGH TABLE HT-5 | H90 CM

12 mm tabletop in MDF with linoleum or 10 mm tabletop in MDF with veneer.
Tabletop is placed inside the table frame. 4 legs in two heights incl. adjustable gliders. STEP modules not included. Requires assembly.

Order produced

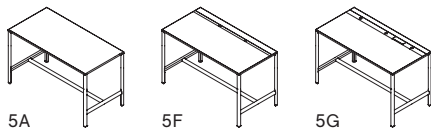

FRAME & LEGS	TABLETOP			
	Cloud grey linoleum	Dark grey linoleum	Green linoleum	Grey linoleum
Army powder coated aluminium	•	•	•	•
Charcoal powder coated aluminium	•	•	•	•
Light grey powder coated aluminium	•	•	•	•

VARIANT	DIMENSION	BOX DIMENSION WEIGHT	PACKAGING	PRICE
HT90-5A	L150 x W75 x H90 cm L59.06" x W29.53" x 35.43"	W163 x D88,5 x H2,5 cm 14,6 kg W160 X D85 X H8 cm 12 kg W115 x D27 x H8 cm 16 kg W163 x D42 x H16 cm 9 kg	4 box 1 pcs.	1,850.00
HT90-5F CABLEM. EDGE	L150 x W75 x H90 cm L59.06" x W29.53" x 35.43"	W163 x D88,5 x H2,5 cm 14,6 kg W160 X D85 X H8 cm 12 kg W115 x D27 x H8 cm 16 kg W163 x D42 x H16 cm 17 kg	4 box 1 pcs.	2,240.00
HT90-5G PLUG & PLAY CABLEM. EDGE	L150 x W75 x H90 cm L59.06" x W29.53" x 35.43"	W163 x D88,5 x H2,5 cm 14,6 kg W160 X D85 X H8 cm 12 kg W115 x D27 x H8 cm 16 kg W163 x D42 x H16 cm 12 kg	4 box 1 pcs.	2,370.00

HIGH TABLE HT-12 | H90 CM

12 mm tabletop in MDF with linoleum or 10 mm tabletop in MDF with veneer.
Tabletop is placed inside the table frame. 4 legs in two heights incl. adjustable gliders. STEP modules not included. Requires assembly.

Order produced

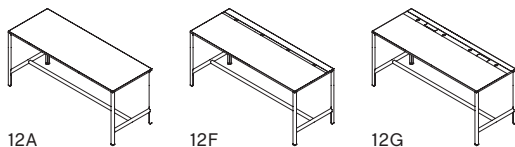

FRAME & LEGS	TABLETOP			
	Cloud grey linoleum	Dark grey linoleum	Green linoleum	Grey linoleum
Army powder coated aluminium	•	•	•	•
Charcoal powder coated aluminium	•	•	•	•
Light grey powder coated aluminium	•	•	•	•

VARIANT	DIMENSION	BOX DIMENSION WEIGHT	PACKAGING	PRICE
HT90-12A	L200 x W75 x H90 cm L78.74" x W29.53" x 35.43"	W213,5 x D88,5 x H2,5 cm 19,1 kg W210 x D85 x H8 cm 15 kg W115 x D27 x H8 cm 16 kg W210 x D42 x H16 cm 15 kg	4 box 1 pcs.	2,045.00
HT90-12F CABLEM. EDGE	L200 x W75 x H90 cm L78.74" x W29.53" x 35.43"	W213,5 x D88,5 x H2,5 cm 19,1 kg W210 x D85 x H8 cm 15 kg W115 x D27 x H8 cm 16 kg W210 x D42 x H16 cm 17 kg	4 box 1 pcs.	2,520.00
HT90-12G PLUG & PLAY CABLEM. EDGE	L200 x W75 x H90 cm L78.74" x W29.53" x 35.43"	W213,5 x D88,5 x H2,5 cm 19,1 kg W210 x D85 x H8 cm 15 kg W115 x D27 x H8 cm 16 kg W210 x D42 x H16 cm 17,5 kg	4 box 1 pcs.	2,650.00

HIGH TABLE HT-6 | H90 CM

12 mm tabletop in MDF with linoleum or 10 mm tabletop in MDF with veneer. Tabletop is placed inside the table frame. 4 legs in two heights incl. adjustable gliders. STEP modules not included. Requires assembly.

Order produced

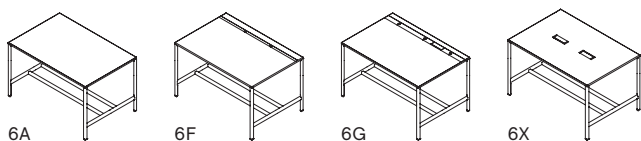

FRAME & LEGS		TABLETOP			
Army powder coated aluminium		Cloud grey linoleum	Dark grey linoleum	Green linoleum	Grey linoleum
Charcoal powder coated aluminium					Water-based lacquered oak veneer
Light grey powder coated aluminium					

VARIANT	DIMENSION	BOX DIMENSION WEIGHT	PACKAGING	PRICE
HT90-6A	L150 x W100 x H90 cm L59.06" x W39.37" x 35.43"	W163 x D113,5 x H2,5 cm 19,3 kg W160 x D110 x H8 cm 13 kg W115 x D27 x H8 cm 16 kg W163 x D42 x H16 cm 14 kg	4 box 1 pcs.	1,845.00
HT90-6F CABLEM. EDGE	L150 x W100 x H90 cm L59.06" x W39.37" x 35.43"	W163 x D113,5 x H2,5 cm 19,3 kg W160 x D110 x H8 cm 13 kg W115 x D27 x H8 cm 16 kg W163 x D42 x H16 cm 16 kg	4 box 1 pcs.	2,235.00
HT90-6G PLUG & PLAY CABLEM. EDGE	L150 x W100 x H90 cm L59.06" x W39.37" x 35.43"	W163 x D113,5 x H2,5 cm 19,3 kg W160 x D110 x H8 cm 13 kg W115 x D27 x H8 cm 16 kg W163 x D42 x H16 cm 14,5 kg	4 box 1 pcs.	2,365.00
HT90-6X SINGLE PLUG & PLAY X 2 CENTER	L150 x W100 x H90 cm L59.06" x W39.37" x 35.43"	W163 x D113,5 x H2,5 cm 19,3 kg W160 x D110 x H8 cm 13 kg W115 x D27 x H8 cm 16 kg W163 x D42 x H16 cm 14 kg	4 box 1 pcs.	2,365.00

HIGH TABLE HT-3 | H90 CM

12 mm tabletop in MDF with linoleum or 10 mm tabletop in MDF with veneer. Tabletop is placed inside the table frame. 4 legs in two heights incl. adjustable gliders. STEP modules, top tray and single profiles not included. Requires assembly.

Order produced

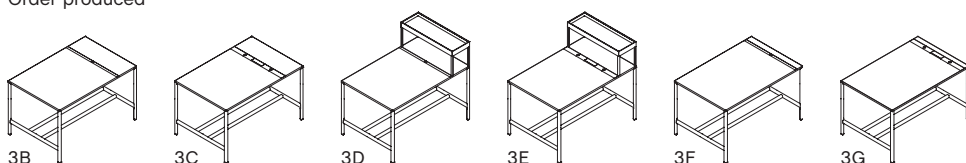

FRAME & LEGS		TABLETOP			
Army powder coated aluminium		Cloud grey linoleum	Dark grey linoleum	Green linoleum	Grey linoleum
Charcoal powder coated aluminium					Water-based lacquered oak veneer
Light grey powder coated aluminium					

VARIANT	DIMENSION	BOX DIMENSION WEIGHT	PACKAGING	PRICE
HT90-3B CABLEM. EDGE 34 CM	L100 x W150 x H90 cm L39.37" x W59.06" x 35.43"	W163 x D113,5 x H2,5 cm 19,3 kg W160 x D110 x H8 cm 13 kg W115 x D27 x H8 cm 16 kg W163 x D42 x H16 cm 13 kg	4 box 1 pcs.	2,060.00
HT90-3C PLUG & PLAY CABLEM. EDGE 34 CM	L100 x W150 x H90 cm L39.37" x W59.06" x 35.43"	W163 x D113,5 x H2,5 cm 19,3 kg W160 x D110 x H8 cm 13 kg W115 x D27 x H8 cm 16 kg W163 x D42 x H16 cm 12 kg	4 box 1 pcs.	2,235.00
HT90-3D CABLEM. EDGE 34 CM + TRAY DIVIDER	L100 x W150 x H90 cm L39.37" x W59.06" x 35.43"	W163 x D113,5 x H2,5 cm 19,3 kg W160 x D110 x H8 cm 13 kg W115 x D27 x H8 cm 16 kg W163 x D42 x H16 cm 13 kg	4 box 1 pcs.	2,130.00
HT90-3E PLUG & PLAY CABLEM. EDGE 34 CM + TRAY DIVIDER	L100 x W150 x H90 cm L39.37" x W59.06" x 35.43"	W163 x D113,5 x H2,5 cm 19,3 kg W160 x D110 x H8 cm 13 kg W115 x D27 x H8 cm 16 kg W163 x D42 x H16 cm 12 kg	4 box 1 pcs.	2,295.00
HT90-3F CABLEM. EDGE	L100 x W150 x H90 cm L39.37" x W59.06" x 35.43"	W163 x D113,5 x H2,5 cm 19,3 kg W160 x D110 x H8 cm 13 kg W115 x D27 x H8 cm 16 kg W163 x D42 x H16 cm 13 kg	4 box 1 pcs.	2,060.00
HT90-3G PLUG & PLAY CABLEM. EDGE	L100 x W150 x H90 cm L39.37" x W59.06" x 35.43"	W163 x D113,5 x H2,5 cm 19,3 kg W160 x D110 x H8 cm 13 kg W115 x D27 x H8 cm 16 kg W163 x D42 x H16 cm 12 kg	4 box 1 pcs.	2,235.00

HIGH TABLE HT-8 | H90 CM

12 mm tabletop in MDF with linoleum or 10 mm tabletop in MDF with veneer.
Tabletop is placed inside the table frame. 4 legs in two heights incl. adjustable gliders. STEP modules not included. Requires assembly.

Order produced

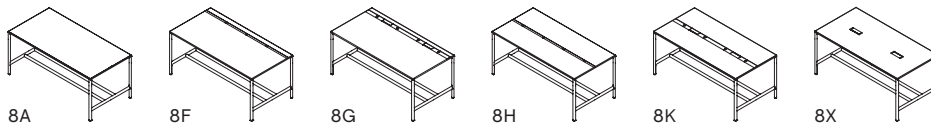

FRAME & LEGS	TABLETOP				
	Army powder coated aluminium	Cloud grey linoleum	Dark grey linoleum	Green linoleum	Grey linoleum
Charcoal powder coated aluminium	•	•	•	•	•
Light grey powder coated aluminium	•	•	•	•	•

VARIANT	DIMENSION	BOX DIMENSION WEIGHT	PACKAGING	PRICE
HT90-8A	L200 x W100 x H90 cm L78.74" x W39.37" x 35.43"	W213,5 x D113,5 x H2,5 cm 25,6 kg W210 x D110 x H8 cm 16 kg W115 x D27 x H8 cm 16 kg W213 x D42 x H16 cm 18 kg	4 box 1 pcs.	2,075.00
HT90-8F CABLEM. EDGE	L200 x W100 x H90 cm L78.74" x W39.37" x 35.43"	W213,5 x D113,5 x H2,5 cm 25,6 kg W210 x D110 x H8 cm 16 kg W115 x D27 x H8 cm 16 kg W213 x D42 x H16 cm 19,5 kg	4 box 1 pcs.	2,230.00
HT90-8G PLUG & PLAY CABLEM. EDGE	L200 x W100 x H90 cm L78.74" x W39.37" x 35.43"	W213,5 x D113,5 x H2,5 cm 25,6 kg W210 x D110 x H8 cm 16 kg W115 x D27 x H8 cm 16 kg W213 x D42 x H16 cm 19,5 kg	4 box 1 pcs.	2,675.00
HT90-8H CABLEM. CENTER	L200 x W100 x H90 cm L78.74" x W39.37" x 35.43"	W213,5 x D113,5 x H2,5 cm 25,6 kg W210 x D110 x H8 cm 16 kg W115 x D27 x H8 cm 16 kg W213 x D42 x H16 cm 16 kg	4 box 1 pcs.	2,230.00
HT90-8K PLUG & PLAY CABLEM. CENTER	L200 x W100 x H90 cm L78.74" x W39.37" x 35.43"	W213,5 x D113,5 x H2,5 cm 25,6 kg W210 x D110 x H8 cm 16 kg W115 x D27 x H8 cm 16 kg W213 x D42 x H16 cm 22 kg	4 box 1 pcs.	2,675.00
HT90-8X SINGLE PLUG & PLAY X 2 CENTER	L200 x W100 x H90 cm L78.74" x W39.37" x 35.43"	W213,5 x D113,5 x H2,5 cm 25,6 kg W210 x D110 x H8 cm 16 kg W115 x D27 x H8 cm 16 kg W213 x D42 x H16 cm 19 kg	4 box 1 pcs.	2,675.00

HIGH TABLE HT-5 | H105 CM

12 mm tabletop in MDF with linoleum or 10 mm tabletop in MDF with veneer.
Tabletop is placed inside the table frame. 4 legs in two heights incl. adjustable gliders. STEP modules not included. Requires assembly.

Order produced

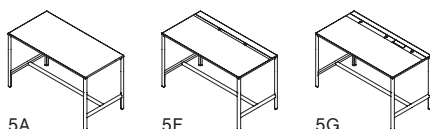

FRAME & LEGS	TABLETOP				
	Army powder coated aluminium	Cloud grey linoleum	Dark grey linoleum	Green linoleum	Grey linoleum
Charcoal powder coated aluminium	•	•	•	•	•
Light grey powder coated aluminium	•	•	•	•	•

VARIANT	DIMENSION	BOX DIMENSION WEIGHT	PACKAGING	PRICE
HT105-5A	L150 x W75 x H105 cm L59.06" x W29.53" x 41.34"	W163 x D88,5 x H2,5 cm 14,6 kg W160 x D85 x H8 cm 12 kg W115 x D27 x H8 cm 17 kg W213 x D42 x H16 cm 9 kg	4 box 1 pcs.	1,865.00
HT105-5F CABLEM. EDGE	L150 x W75 x H105 cm L59.06" x W29.53" x 41.34"	W163 x D88,5 x H2,5 cm 14,6 kg W160 x D85 x H8 cm 12 kg W115 x D27 x H8 cm 17 kg W213 x D42 x H16 cm 17 kg	4 box 1 pcs.	2,255.00
HT105-5G PLUG & PLAY CABLEM. EDGE	L150 x W75 x H105 cm L59.06" x W29.53" x 41.34"	W163 x D88,5 x H2,5 cm 14,6 kg W160 x D85 x H8 cm 12 kg W115 x D27 x H8 cm 17 kg W213 x D42 x H16 cm 12 kg	4 box 1 pcs.	2,385.00

HIGH TABLE HT-12 | H105 CM

12 mm tabletop in MDF with linoleum or 10 mm tabletop in MDF with veneer. Tabletop is placed inside the table frame. 4 legs in two heights incl. adjustable gliders. STEP modules not included. Requires assembly.

Order produced

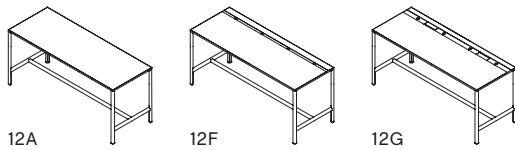

VARIANT	DIMENSION	BOX DIMENSION WEIGHT	PACKAGING	PRICE
HT105-12A	L200 x W75 x H105 cm L78.74" x W29.53" x 41.34"	W213,5 x D88,5 x H2,5 cm 19,1 kg W210 x D85 x H8 cm 15 kg W115 x D27 x H8 cm 16 kg W210 x D42 x H16 cm 16 kg	4 box 1 pcs.	2,060.00
HT105-12F CABLEM. EDGE	L200 x W75 x H105 cm L78.74" x W29.53" x 41.34"	W213,5 x D88,5 x H2,5 cm 19,1 kg W210 x D85 x H8 cm 15 kg W115 x D27 x H8 cm 16 kg W210 x D42 x H16 cm 17 kg	4 box 1 pcs.	2,535.00
HT105-12G PLUG & PLAY CABLEM. EDGE	L200 x W75 x H105 cm L78.74" x W29.53" x 41.34"	W213,5 x D88,5 x H2,5 cm 19,1 kg W210 x D85 x H8 cm 15 kg W115 x D27 x H8 cm 16,17,5 kg	4 box 1 pcs.	2,665.00

FRAME & LEGS	TABLETOP
Army powder coated aluminium	Cloud grey linoleum
Charcoal powder coated aluminium	Dark grey linoleum
Light grey powder coated aluminium	Green linoleum
	Grey linoleum
	Water-based lacquered oak veneer

HIGH TABLE HT-6 | H105 CM

12 mm tabletop in MDF with linoleum or 10 mm tabletop in MDF with veneer. Tabletop is placed inside the table frame. 4 legs in two heights incl. adjustable gliders. STEP modules not included. Requires assembly.

Order produced

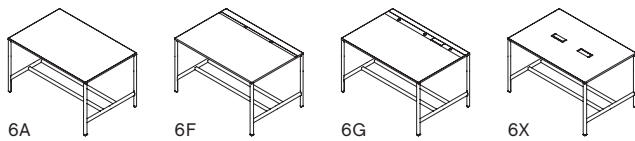

VARIANT	DIMENSION	BOX DIMENSION WEIGHT	PACKAGING	PRICE
HT105-6A	L150 x W100 x H105 cm L59.06" x W39.37" x 41.34"	W163 x D113,5 x H2,5 cm 19,3 kg W160 x D110 x H8 cm 13 kg W115 x D27 x H8 cm 16 kg W163 x D42 x H16 cm 19,3 kg	4 box 1 pcs.	1,860.00
HT105-6F CABLEM. EDGE	L150 x W100 x H105 cm L59.06" x W39.37" x 41.34"	W163 x D113,5 x H2,5 cm 19,3 kg W160 x D110 x H8 cm 13 kg W115 x D27 x H8 cm 16 kg W163 x D42 x H16 cm 16 kg	4 box 1 pcs.	2,250.00
HT105-6G PLUG & PLAY CABLEM. EDGE	L150 x W100 x H105 cm L59.06" x W39.37" x 41.34"	W163 x D113,5 x H2,5 cm 19,3 kg W160 x D110 x H8 cm 13 kg W115 x D27 x H8 cm 16 kg W163 x D42 x H16 cm 14,5 kg	4 box 1 pcs.	2,380.00
HT105-6X SINGLE PLUG & PLAY X 2 CENTER	L150 x W100 x H105 cm L59.06" x W39.37" x 41.34"	W163 x D113,5 x H2,5 cm 19,3 kg W160 x D110 x H8 cm 13 kg W115 x D27 x H8 cm 16 kg W163 x D42 x H16 cm 14 kg	4 box 1 pcs.	2,380.00

FRAME & LEGS	TABLETOP
Army powder coated aluminium	Cloud grey linoleum
Charcoal powder coated aluminium	Dark grey linoleum
Light grey powder coated aluminium	Green linoleum
	Grey linoleum
	Water-based lacquered oak veneer

HIGH TABLE HT-3 | H105 CM

12 mm tabletop in MDF with linoleum or 10 mm tabletop in MDF with veneer.
Tabletop is placed inside the table frame. 4 legs in two heights incl. adjustable gliders. STEP modules, top tray and single profiles not included. Requires assembly.

Order produced

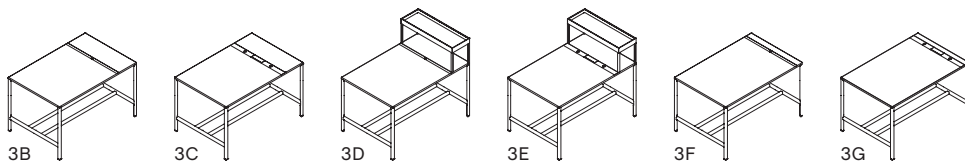

FRAME & LEGS	TABLETOP			
	Army powder coated aluminium	Cloud grey linoleum	Dark grey linoleum	Green linoleum
Charcoal powder coated aluminium	•	•	•	•
Light grey powder coated aluminium	•	•	•	•

Water-based lacquered oak veneer

VARIANT	DIMENSION	BOX DIMENSION WEIGHT	PACKAGING	PRICE
HT105-3B CABLEM. EDGE 34 CM	L100 x W150 x H105 cm L39.37" x W59.06" x 41.34"	W163 x D113,5 x H2,5 cm 19,3 kg W160 x D110 x H8 cm 13 kg W115 x D27 x H8 cm 16 kg W163 x D42 x H16 cm 13 kg	4 box 1 pcs.	2,075.00
HT105-3C PLUG & PLAY CABLEM. EDGE 34 CM	L100 x W150 x H105 cm L39.37" x W59.06" x 41.34"	W163 x D113,5 x H2,5 cm 19,3 kg W160 x D110 x H8 cm 13 kg W115 x D27 x H8 cm 16 kg W163 x D42 x H16 cm 12 kg	4 box 1 pcs.	2,250.00
HT105-3D CABLEM. EDGE 34 CM + TRAY DIVIDER	L100 x W150 x H105 cm L39.37" x W59.06" x 41.34"	W163 x D113,5 x H2,5 cm 19,3 kg W160 x D110 x H8 cm 13 kg W115 x D27 x H8 cm 16 kg W163 x D42 x H16 cm 13 kg	4 box 1 pcs.	2,145.00
HT105-3E PLUG & PLAY CABLEM. EDGE 34 CM + TRAY DIVIDER	L100 x W150 x H105 cm L39.37" x W59.06" x 41.34"	W163 x D113,5 x H2,5 cm 19,3 kg W160 x D110 x H8 cm 13 kg W115 x D27 x H8 cm 16 kg W163 x D42 x H16 cm 12 kg	4 box 1 pcs.	2,310.00
HT105-3F CABLEM. EDGE	L100 x W150 x H105 cm L39.37" x W59.06" x 41.34"	W163 x D113,5 x H2,5 cm 19,3 kg W160 x D110 x H8 cm 13 kg W115 x D27 x H8 cm 16 kg W163 x D42 x H16 cm 13 kg	4 box 1 pcs.	2,075.00
HT105-3G PLUG & PLAY CABLEM. EDGE	L100 x W150 x H105 cm L39.37" x W59.06" x 41.34"	W163 x D113,5 x H2,5 cm 19,3 kg W160 x D110 x H8 cm 13 kg W115 x D27 x H8 cm 16 kg W163 x D42 x H16 cm 12 kg	4 box 1 pcs.	2,250.00

HIGH TABLE HT-8 | H105 CM

12 mm tabletop in MDF with linoleum or 10 mm tabletop in MDF with veneer. Tabletop is placed inside the table frame. 4 legs in two heights incl. adjustable gliders. STEP modules not included. Requires assembly.

Order produced

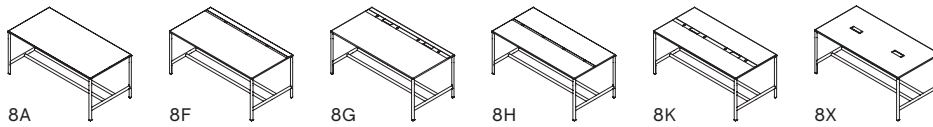

FRAME & LEGS	TABLETOP			
	Army powder coated aluminium	Cloud grey linoleum	Dark grey linoleum	Green linoleum
Charcoal powder coated aluminium	•	•	•	•
Light grey powder coated aluminium	•	•	•	•

VARIANT	DIMENSION	BOX DIMENSION WEIGHT	PACKAGING	PRICE
HT105-8A	L200 x W100 x H105 cm L78.74" x W39.37" x 41.34"	W213,5 x D113,5 x H2,5 cm 25,6 kg W210 x D110 x H8 cm 16 kg W115 x D27 x H8 cm 16 kg W213 x D42 x H16 cm 18 kg	4 box 1 pcs.	2,090.00
HT105-8F CABLEM. EDGE	L200 x W100 x H105 cm L78.74" x W39.37" x 41.34"	W213,5 x D113,5 x H2,5 cm 25,6 kg W210 x D110 x H8 cm 16 kg W115 x D27 x H8 cm 16 kg W213 x D42 x H16 cm 19,5 kg	4 box 1 pcs.	2,245.00
HT105-8G PLUG & PLAY CABLEM. EDGE	L200 x W100 x H105 cm L78.74" x W39.37" x 41.34"	W213,5 x D113,5 x H2,5 cm 25,6 kg W210 x D110 x H8 cm 16 kg W115 x D27 x H8 cm 16 kg W213 x D42 x H16 cm 19,5 kg	4 box 1 pcs.	2,690.00
HT105-8H CABLEM. CENTER	L200 x W100 x H105 cm L78.74" x W39.37" x 41.34"	W213,5 x D113,5 x H2,5 cm 25,6 kg W210 x D110 x H8 cm 16 kg W115 x D27 x H8 cm 16 kg W213 x D42 x H16 cm 16 kg	4 box 1 pcs.	2,245.00
HT105-8K PLUG & PLAY CABLEM. CENTER	L200 x W100 x H105 cm L78.74" x W39.37" x 41.34"	W213,5 x D113,5 x H2,5 cm 25,6 kg W210 x D110 x H8 cm 16 kg W115 x D27 x H8 cm 16 kg W213 x D42 x H16 cm 22 kg	4 box 1 pcs.	2,690.00
HT105-8X SINGLE PLUG & PLAY X 2 CENTER	L200 x W100 x H105 cm L78.74" x W39.37" x 41.34"	W213,5 x D113,5 x H2,5 cm 25,6 kg W210 x D110 x H8 cm 16 kg W115 x D27 x H8 cm 16 kg W213 x D42 x H16 cm 19 kg	4 box 1 pcs.	2,690.00

CABLE TRAY | 35

Powder coated steel.

Stock item

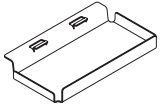

MATERIAL	COLOUR
Powder coated steel	Charcoal

VARIANT	DIMENSION	BOX DIMENSION WEIGHT	PACKAGING	PRICE
W35	W35 x D21 x H4,2 W13.78" x D8.27" x H1.65"	1 pcs. W38 x D23 x H6 1 kg	1 box 1 pcs.	40.00

CABLE TRAY FOR STEP MODULE | 35

Powder coated steel. Prepared for STEP Module.

Stock item

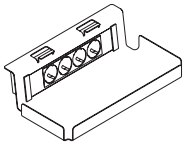

MATERIAL	COLOUR
Powder coated steel	Army Charcoal Light grey

VARIANT	DIMENSION	BOX DIMENSION WEIGHT	PACKAGING	PRICE
W35	W35 x D21 x H7 W13.78" x D8.27" x H2.76"	1 pcs. W38 x D23 x H9 1.2 kg	1 box 1 pcs.	50.00

STEP MODULES FOR CABLE MANAGEMENT

STEP BASE in plastic and STEP ALU in aluminium. NO STEP module power strip profile with 3 or 4 outlets. Customer outlets CAT6 or HDMI are sold separately. The custom module fits two customer outlets. The STEP Module fits into NO support bar or cable tray prepared for STEP module.

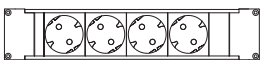
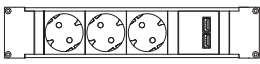
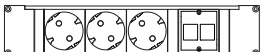

Stock item

	COLOUR
	Charcoal
	MATERIAL
	Powder coated steel

CEE/GE++ PLUG TYPE F	VARIANT	DIMENSION	BOX DIMENSION WEIGHT	PACKAGING	PRICE
	4 OUTLETS	W30 x D5,5 x H4,5 W11.81" x D2.17" x H1.77"	1 pcs. W32 x D7.5 x H6.5 0.35 kg1 box 1 pcs.		60.00
	3 OUTLETS + 1 DOUBLE USB	W30 x D5,5 x H4,5 W11.81" x D2.17" x H1.77"	1 pcs. W32 x D7.5 x H6.5 0.35 kg1 box 1 pcs.		100.00
	3 OUTLETS + 1 CUSTOMER MODULE W/2 OUTLET	W30 x D5,5 x H4,5 W11.81" x D2.17" x H1.77"	1 pcs. W32 x D7.5 x H6.5 0.35 kg1 box 1 pcs.		70.00

PLUG TYPE F (CEE GE++)

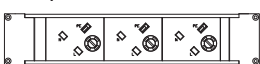
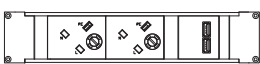
AD, AF, AL, AM, AN (CW, SX, BQ), AS, AT, AW, AZ, BA, BG, BT, BY, CV, DE, DK, DZ, EE, EG, ES, ET, FI, FO, GE, GL, GN, GR, HR, HU, ID, IS, IR, IT, JO, KG, KP, KR, KZ, LA, LR, LT, LU, LV, LY, MC, MD, ME, MF, MK, MM, MO, MZ, NC, NE, NL, NO, PT, RO, RS, RU, SE, SI, SM, SR, ST, TD, TH, TJ, TL, TM, TR, UA, UY, VN

UK++ PLUG TYPE G	VARIANT	DIMENSION	BOX DIMENSION WEIGHT	PACKAGING	PRICE
	3 OUTLES	W30 x D5,5 x H4,5 W11.81" x D2.17" x H1.77"	1 pcs. W32 x D7.5 x H6.5 0.35 kg1 box 1 pcs.		60.00
	2 OUTLETS + 1 DOUBLE USB	W30 x D5,5 x H4,5 W11.81" x D2.17" x H1.77"	1 pcs. W32 x D7.5 x H6.5 0.35 kg1 box 1 pcs.		100.00
	2 OUTLETS + 1 CUSTOMER MODULE W/2 OUTLET	W30 x D5,5 x H4,5 W11.81" x D2.17" x H1.77"	1 pcs. W32 x D7.5 x H6.5 0.35 kg1 box 1 pcs.		70.00

PLUG TYPE G (UK++)

AE, BD, BH, BN, BT, BW, BZ, CY, DM, FK, GB, GD, GH, GI, GM, GY, HK, IE, IM, IQ, JO, KE, KH, KN, KW, LB, LC, LK, MM, MO, MT, MU, MV, MW, MY, NG, OM, PK, QA, SA, SB, SC, SG, SL, TZ, UG, VC, VU, YE, ZM, ZW

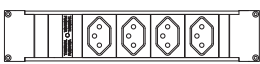
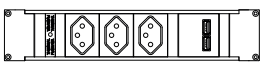
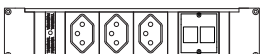
CH++ PLUG TYPE J	VARIANT	DIMENSION	BOX DIMENSION WEIGHT	PACKAGING	PRICE
	4 OUTLETS	W30 x D5,5 x H4,5 W11.81" x D2.17" x H1.77"	1 pcs. W32 x D7.5 x H6.5 0.35 kg1 box 1 pcs.		60.00
	3 OUTLETS + 1 DOUBLE USB	W30 x D5,5 x H4,5 W11.81" x D2.17" x H1.77"	1 pcs. W32 x D7.5 x H6.5 0.35 kg1 box 1 pcs.		100.00
	3 OUTLETS + 1 CUSTOMER MODULE W/2 OUTLET	W30 x D5,5 x H4,5 W11.81" x D2.17" x H1.77"	1 pcs. W32 x D7.5 x H6.5 0.35 kg1 box 1 pcs.		70.00

PLUG TYPE J (CH++)

CH, JO, LI, MG, MV, RW

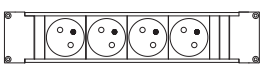
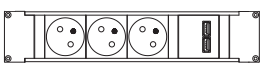
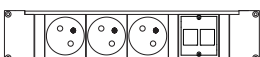
FR++ PLUG TYPE E	VARIANT	DIMENSION	BOX DIMENSION WEIGHT	PACKAGING	PRICE
	4 OUTLETS	W30 x D5,5 x H4,5 W11.81" x D2.17" x H1.77"	1 pcs. W32 x D7.5 x H6.5 0.35 kg1 box 1 pcs.		60.00
	3 OUTLETS + 1 DOUBLE USB	W30 x D5,5 x H4,5 W11.81" x D2.17" x H1.77"	1 pcs. W32 x D7.5 x H6.5 0.35 kg1 box 1 pcs.		100.00
	3 OUTLETS + 1 CUSTOMER MODULE W/2 OUTLET	W30 x D5,5 x H4,5 W11.81" x D2.17" x H1.77"	1 pcs. W32 x D7.5 x H6.5 0.35 kg1 box 1 pcs.		70.00

PLUG TYPE E (FR++)

BE, BF, BI, BJ, CD, CF, CG, CI, CM, CZ, DK, DJ, ET, FO, FR, GF, GL, GP, GQ, KM, LA, LR, MA, MC, MG, ML, MN, MQ, NE, PL, RE, SK, SN, SY, TD, TL, TN, VC

STEP MODULES FOR CABLE MANAGEMENT

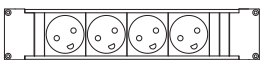
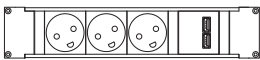
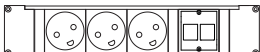

STEP BASE in plastic and STEP ALU in aluminium. NO STEP module power strip profile with 3 or 4 outlets. Customer outlets CAT6 or HDMI are sold separately. The custom module fits two customer outlets. The STEP Module fits into NO support bar or cable tray prepared for STEP module.

Stock item

DK++ PLUG TYPE K	VARIANT	DIMENSION	BOX DIMENSION WEIGHT	PACKAGING	PRICE
	4 OUTLETS	W30 x D5,5 x H4,5 W11.81" x D2.17" x H1.77"	1 pcs. W32 x D7.5 x H6.5 0.35 kg1 box 1 pcs.		60.00
	3 OUTLETS + 1 DOUBLE USB	W30 x D5,5 x H4,5 W11.81" x D2.17" x H1.77"	1 pcs. W32 x D7.5 x H6.5 0.35 kg1 box 1 pcs.		100.00
	3 OUTLETS + 1 CUSTOMER MODULE W/2 OUTLET	W30 x D5,5 x H4,5 W11.81" x D2.17" x H1.77"	1 pcs. W32 x D7.5 x H6.5 0.35 kg1 box 1 pcs.		70.00

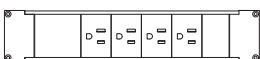

PLUG TYPE K (DK++)

BD, DK, FO, GL, GN, MG, MV, SN, VC

US++ PLUG TYPE A	VARIANT	DIMENSION	BOX DIMENSION WEIGHT	PACKAGING	PRICE
	4 OUTLETS	W30 x D5,5 x H4,5 W11.81" x D2.17" x H1.77"	1 pcs. W32 x D7.5 x H6.5 0.35 kg1 box 1 pcs.		60.00
	3 OUTLETS + 1 DOUBLE USB	W30 x D5,5 x H4,5 W11.81" x D2.17" x H1.77"	1 pcs. W32 x D7.5 x H6.5 0.35 kg1 box 1 pcs.		100.00
	3 OUTLETS + 1 CUSTOMER MODULE W/2 OUTLET	W30 x D5,5 x H4,5 W11.81" x D2.17" x H1.77"	1 pcs. W32 x D7.5 x H6.5 0.35 kg1 box 1 pcs.		70.00

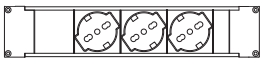
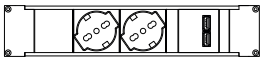

PLUG TYPE A (US++)

AG, AI, AN (CW, SX, BQ), AS, AW, BB, BM, BO, BS, BZ, CA, CN, CO, CR, CU, DO, EC, FM, GT, GU, GY, HN, HT, JM, JP, KH, KN, KP, KY, LA, LB, LR, SV, MS, MV, MX, MY, NE, NI, PA, PE, PH, PR, PW, TC, TH, TT, TW, US, VC, VE, VG, VI, VN, YE

IT++ PLUG TYPE L	VARIANT	DIMENSION	BOX DIMENSION WEIGHT	PACKAGING	PRICE
	3 OUTLETS	W30 x D5,5 x H4,5 W11.81" x D2.17" x H1.77"	1 pcs. W32 x D7.5 x H6.5 0.35 kg1 box 1 pcs.		60.00
	2 OUTLETS + 1 DOUBLE USB	W30 x D5,5 x H4,5 W11.81" x D2.17" x H1.77"	1 pcs. W32 x D7.5 x H6.5 0.35 kg1 box 1 pcs.		100.00
	2 OUTLETS + 1 CUSTOMER MODULE W/2 OUTLET	W30 x D5,5 x H4,5 W11.81" x D2.17" x H1.77"	1 pcs. W32 x D7.5 x H6.5 0.35 kg1 box 1 pcs.		70.00

PLUG TYPE L (IT++)

CL, ER, ET, IT, MV, SM, SY, UY

ALL COUNTRIES	VARIANT	DIMENSION	BOX DIMENSION WEIGHT	PACKAGING	PRICE
	CUSTOMER OUTLET CAT6	W2,5 x D5,5 x H4,5 W0.98" x D2.17" x H1.77"	1 pcs. W4.5 x D7.5 x H6.5 0.1 kg 1 box 1 pcs.		50.00
	CUSTOMER OUTLET HDMI	W2,5 x D5,5 x H4,5 W0.98" x D2.17" x H1.77"	1 pcs. W4.5 x D7.5 x H6.5 0.1 kg 1 box 1 pcs.		50.00

STEP MODULE EXTENSION CABLE

L200 cm

Stock item

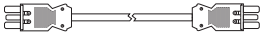
EXTENSION CABLE	VARIANT	DIMENSION	BOX DIMENSION WEIGHT	PACKAGING	PRICE
	ALL COUNTRIES	W25 x D5 x H5 W9.84" x D1.97" x H1.97"	1 pcs. W27 x D7 x H7 0.5 kg	1 box 1 pcs.	30.00

STEP MODULES SUPPLY CABLES

L500 cm

Stock item

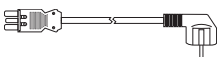
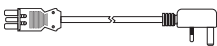
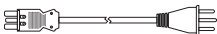
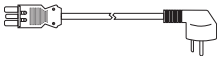
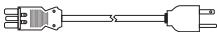
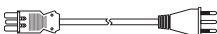
EXTENSION CABLE	VARIANT	DIMENSION	BOX DIMENSION WEIGHT	PACKAGING	PRICE
	TYPE E (FR++) / TYPE F (CEE/GE++)	W25 x D5 x H5 W9.84" x D1.97" x H1.97"	1 pcs. W27 x D7 x H7 0.5 kg	1 box 1 pcs.	35.00
	TYPE G (UK++)	W25 x D5 x H5 W9.84" x D1.97" x H1.97"	1 pcs. W27 x D7 x H7 0.5 kg	1 box 1 pcs.	35.00
	TYPE J (CH++)	W25 x D5 x H5 W9.84" x D1.97" x H1.97"	1 pcs. W27 x D7 x H7 0.5 kg	1 box 1 pcs.	35.00
	TYPE K (DK++)	W25 x D5 x H5 W9.84" x D1.97" x H1.97"	1 pcs. W27 x D7 x H7 0.5 kg	1 box 1 pcs.	35.00
	TYPE A (US++)	W25 x D5 x H5 W9.84" x D1.97" x H1.97"	1 pcs. W27 x D7 x H7 0.5 kg	1 box 1 pcs.	115.00
	TYPE L (IT++)	W25 x D5 x H5 W9.84" x D1.97" x H1.97"	1 pcs. W27 x D7 x H7 0.5 kg	1 box 1 pcs.	35.00

COVER FOR CABLE MANAGEMENT W. PEN HOLDER | MODULE SIZE 50 CM

Powder coated aluminium

Stock item

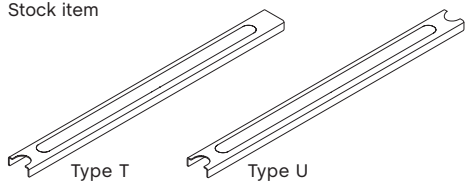

MATERIAL	COLOUR		
	Army	Charcoal	Light grey
Powder coated aluminium	•	•	•

VARIANT	DIMENSION	BOX DIMENSION WEIGHT	PACKAGING	PRICE
END - TYPE T	W50 x D4 x H1 W19.69" x D1.57" x H0.39"	1 pcs. W52 x D42 x H3 0.4 kg	1 box 1 pcs.	11.00
MIDDLE - TYPE U	W50 x D4 x H1 W19.69" x D1.57" x H0.39"	1 pcs. W52 x D42 x H3 0.41 kg	1 box 1 pcs.	11.00

COVER FOR CABLE MANAGEMENT | MODULE SIZE 25 CM

Powder coated aluminium

Stock item

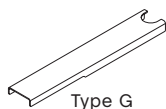

MATERIAL	COLOUR		
	Army	Charcoal	Light grey
Powder coated aluminium	•	•	•

VARIANT	DIMENSION	BOX DIMENSION WEIGHT	PACKAGING	PRICE
END - TYPE G	W25 x D4 x H1 W9.84" x D1.57" x H0.39"	1 pcs. W27 x D42 x H3 0.1 kg	1 box 1 pcs.	18.00

COVER FOR CABLE MANAGEMENT | MODULE SIZE 50 CM

Powder coated aluminium

Stock item

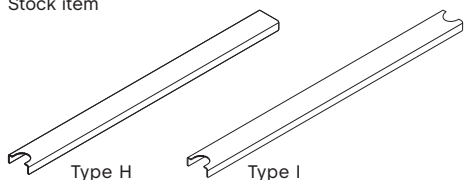

MATERIAL	COLOUR		
	Army	Charcoal	Light grey
Powder coated aluminium	•	•	•

VARIANT	DIMENSION	BOX DIMENSION WEIGHT	PACKAGING	PRICE
END - TYPE H	W50 x D4 x H1 W19.69" x D1.57" x H0.39"	1 pcs. W52 x D42 x H3 0.18 kg	1 box 1 pcs.	18.00
MIDDLE - TYPE I	W50 x D4 x H1 W19.69" x D1.57" x H0.39"	1 pcs. W52 x D42 x H3 0.6 kg	1 box 1 pcs.	18.00

COVER FOR PLUG AND PLAY | DOUBLE P&P CABLE MANAGEMENT | MODULE SIZE 25 CM

Powder coated aluminium

Stock item

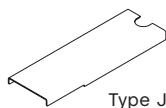

MATERIAL	COLOUR		
	Army	Charcoal	Light grey
Powder coated aluminium	•	•	•

VARIANT	DIMENSION	BOX DIMENSION WEIGHT	PACKAGING	PRICE
END - TYPE J	W25 x D8 x H1 W9.84" x D3.15" x H0.39"	1 pcs. W27 x D82 x H3 0.2 kg	1 box 1 pcs.	23.00

COVER FOR PLUG AND PLAY | DOUBLE P&P CABLE MANAGEMENT | MODULE SIZE 50 CM

Powder coated aluminium

Stock item

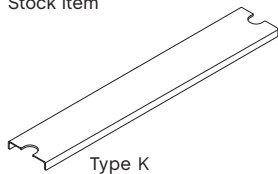

MATERIAL	COLOUR		
	Army	Charcoal	Light grey
Powder coated aluminium	•	•	•

VARIANT	DIMENSION	BOX DIMENSION WEIGHT	PACKAGING	PRICE
MIDDLE - TYPE K	W50 x D8 x H1 W19.69" x D3.15" x H0.39"	1 pcs. W52 x D82 x H3 0.4 kg	1 box 1 pcs.	30.00

FLIP COVER FOR PLUG AND PLAY | DOUBLE P&P CABLE MANAGEMENT | MODULE SIZE 50 CM | MIDDLE

Powder coated aluminium

Stock item

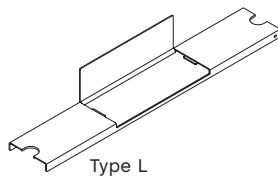

MATERIAL	COLOUR		
	Army	Charcoal	Light grey
Powder coated aluminium	•	•	•

VARIANT	DIMENSION	BOX DIMENSION WEIGHT	PACKAGING	PRICE
MIDDLE - TYPE L	W50 x D8 x H1 W19.69" x D3.15" x H0.39"	1 pcs. W52 x D82 x H3 0.4 kg	1 box 1 pcs.	50.00

NO COMBINATION 101

ITEM LIST

- 1 x NO Shelf Bottom 100 cm
- 1 x NO Tray Top 100 cm
- 1 x NO Single Profile | Set of 4
- 1 x NO Wheels 34 mm Black | Set of 4

Stock item

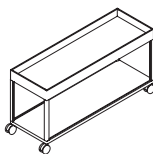

MATERIAL	COLOUR			
	Army	Charcoal	Light grey	Red
Powder coated aluminium	•	•	•	•

VARIANT

W100

DIMENSION

W100 x D34 x H49,9 cm
W39.37" x D13.39" x H19.65"

PRICE

445.00

NO COMBINATION 102

ITEM LIST

- 1 x NO Tray Top 150 cm
- 1 x NO Shelf Bottom 150 cm
- 1 x NO Single Profile | Set of 4
- 1 x NO Wheels 34 mm Black | Set of 4

Stock item

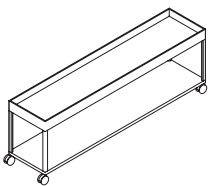

MATERIAL	COLOUR			
	Army	Charcoal	Light grey	Red
Powder coated aluminium	•	•	•	•

VARIANT

W150

DIMENSION

W150 x D34 x H49,9 cm
W59.06" x D13.39" x H19.65"

PRICE

580.00

NO COMBINATION 103

ITEM LIST

- 2 x NO Shelf Bottom 100 cm
- 2 x NO Tray Top 100 cm
- 1 x NO Single Profile | Set of 4
- 1 x NO Double Profile | Set of 2
- 2 x NO Wheels 34 mm Black | Set of 4

Stock item

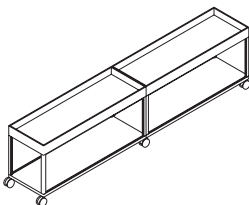

MATERIAL	COLOUR			
	Army	Charcoal	Light grey	Red
Powder coated aluminium	•	•	•	•

VARIANT

W200

DIMENSION

W200 x D34 x H49,9 cm
W78.74" x D13.39" x H19.65"

PRICE

890.00

NO BENCH COMBINATION 100

ITEM LIST

- 1 x NO Shelf Top 100 cm
- 1 x NO Shelf Bottom 100 cm
- 1 x NO Single Profile | Set of 4
- 1 x NO Benchtop 100 cm

Order produced

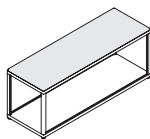

MATERIAL	COLOUR			
	Army	Charcoal	Light grey	Red
Powder coated aluminium	•	•	•	•

VARIANT	DIMENSION	FABRIC	PRICE
W100	W100 x D34 x H41,7 cm	Remix	590,00
	W39.37" x D13.39" x H16.42"	Surface By HAY	590,00
		Steelcut	600,00
		Steelcut Trio	600,00
		Canvas	610,00
		Sierra black leather	620,00
		Sense cognac leather	710,00

NO BENCH COMBINATION 150

ITEM LIST

- 1 x NO Shelf Top 150 cm
- 1 x NO Shelf Bottom 150 cm
- 1 x NO Single Profile | Set of 4
- 1 x NO Benchtop 150 cm

Order produced

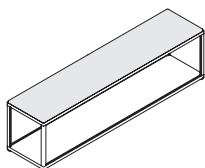

MATERIAL	COLOUR			
	Army	Charcoal	Light grey	Red
Powder coated aluminium	•	•	•	•

VARIANT	DIMENSION	FABRIC	PRICE
W150	W150 x D34 x H41,7 cm	Remix	820,00
	W59.06" x D13.39" x H16.42"	Surface By HAY	820,00
		Steelcut	835,00
		Steelcut Trio	835,00
		Canvas	860,00
		Sierra black leather	880,00
		Sense cognac leather	990,00

NO COMBINATION 201

ITEM LIST

- 1 x NO Shelf Top 100 cm
 - 1 x NO Shelf Middle 100 cm
 - 1 x NO Shelf Bottom 100 cm
 - 1 x NO Single Profile | Set of 4
 - 2 x NO Steel shelf 100 cm | Incl. pin 4 pcs. for adjustable side panels | Powder coated steel
 - 2 x NO Steel side panel double height 34 cm for adjustable shelf | Powder coated steel
 - 1 x NO Steel wall back panel double height 100 cm | Powder coated steel
 - 1 x NO Single Profile for double height | Set of 4
 - 1 x NO Steel sliding door double height 100 cm | Incl. handle, powder coated steel
- Please remember to specify wall- or floor safety brackets when ordering this combination.

Order produced

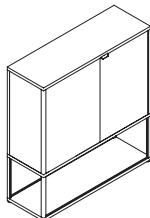

MATERIAL	COLOUR		
	Army	Charcoal	Light grey
Powder coated aluminium	•	•	•

VARIANT	DIMENSION	PRICE
W. WALL SAFETY BRACKET	W100 x D34 x H109,3 cm W39.37" x D13.39" x H43.03"	1,360.00
W. FLOOR SAFETY BRACKET	W100 x D34 x H109,3 cm W39.37" x D13.39" x H43.03"	1,380.00

NO COMBINATION 202

ITEM LIST

- 1 x NO Shelf Top 150 cm
- 1 x NO Shelf Middle 150 cm
- 1 x NO Shelf Bottom 150 cm
- 2 x NO Single Profile | Set of 4

Stock item

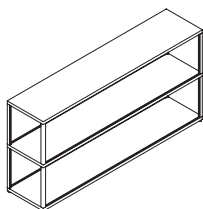

MATERIAL	COLOUR			
	Army	Charcoal	Light grey	Red
Powder coated aluminium	•	•	•	•

VARIANT	DIMENSION	PRICE
W150	W150 x D34 cm x H74 cm W59.06" x D13.39" x H29.13"	830.00

NO COMBINATION 203

ITEM LIST

- 2 x NO Shelf Middle 100 cm
- 2 x NO Shelf Bottom 100 cm
- 2 x NO Tray Top 100 cm
- 2 x NO Single Profile | Set of 4
- 2 x NO Double Profile | Set of 2
- 4 x NO Steel side panel 34 cm | Powder coated steel
- 2 x NO Steel back panel 100 cm | Powder coated steel
- 2 x NO Steel sliding door 100 cm | Incl. handle, powder coated steel

Order produced

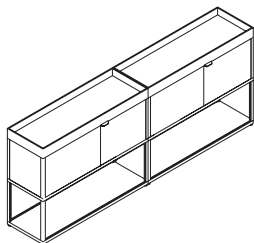

MATERIAL	COLOUR		
	Army	Charcoal	Light grey
Powder coated aluminium	•	•	•

VARIANT	DIMENSION	PRICE
W200	W200 x D34 x H79,7 cm W78.74" x D13.39" x H31.38"	1,880.00

NO COMBINATION 204

ITEM LIST

- 1 x NO Shelf Middle 100 cm
 - 1 x NO Shelf Bottom 100 cm
 - 1 x NO Tray Top 100 cm
 - 1 x NO Single Profile | Set of 4
 - 2 x NO Steel side panel double height 34 cm | For adjustable shelf powder coated steel
 - 1 x NO Steel back panel double height 100 cm | Powder coated steel
 - 1 x NO Single Profile for double height | Set of 4
 - 2 x NO Steel shelf 100 cm | Incl. pin 4 pcs. for adjustable side panels powder coated steel
 - 1 x NO Steel sliding door double height 100 cm | Incl. handle powder coated steel
- Please remember to specify wall- or floor safety brackets when ordering this combination.

Order produced

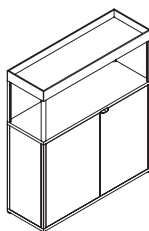

MATERIAL	COLOUR		
	Army	Charcoal	Light grey
Powder coated aluminium	•	•	•

VARIANT	DIMENSION	PRICE
W. WALL SAFETY BRACKET	W100 x D34 x H115 cm W39.37" x D13.39" x H45.28"	1,375.00
W. FLOOR SAFETY BRACKET	W100 x D34 x H115 cm W39.37" x D13.39" x H45.28"	1,395.00

NO COMBINATION 205

ITEM LIST

- 1 x NO Shelf Top 100 cm
- 1 x NO Shelf Middle 100 cm
- 1 x NO Shelf Bottom 100 cm
- 1 x NO High drawer incl. Mounting set 100 cm
- 2 x NO Steel Side panel 34 cm
- 1 x NO Steel Back panel 100 cm
- 2 x NO Single profile | Set of 4

Please remember to specify wall- or floor safety brackets when ordering this combination.

Order produced

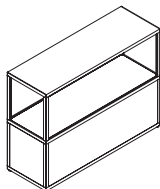

MATERIAL	COLOUR		
	Army	Charcoal	Light grey
Powder coated aluminium	•	•	•

VARIANT	DIMENSION	PRICE
W. WALL SAFETY BRACKET	W100 x D34 cm x H74 cm W39,37" x D13.39" x H29.13"	1,220.00
W. FLOOR SAFETY BRACKET	W100 x D34 cm x H74 cm W39,37" x D13.39" x H29.13"	1,380.00

NO COMBINATION 301

ITEM LIST

- 1 x NO Shelf Top 100 cm
- 2 x NO Shelf Middle 100 cm
- 1 x NO Shelf Bottom 100 cm
- 3 x NO Single Profile | Set of 4

Please remember to specify wall- or floor safety brackets when ordering this combination.

Stock item

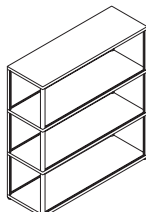

MATERIAL	COLOUR			
	Army	Charcoal	Light grey	Red
Powder coated aluminium	•	•	•	•

VARIANT	DIMENSION	PRICE
W. WALL SAFETY BRACKET	W100 x D34 x H109,3 cm W39.37" x D13.39" x H43.03"	840.00
W. FLOOR SAFETY BRACKET	W100 x D34 x H109,3 cm W39.37" x D13.39" x H43.03"	860.00

NO COMBINATION 303

ITEM LIST

- 2 x NO Shelf Middle 100 cm
- 1 x NO Shelf Bottom 100 cm
- 1 x NO Tray Top 100 cm
- 3 x NO Single Profile | Set of 4

Please remember to specify wall- or floor safety brackets when ordering this combination.

Stock item

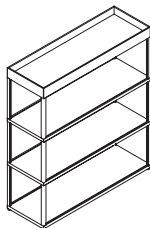

MATERIAL	COLOUR			
	Army	Charcoal	Light grey	Red
Powder coated aluminium	•	•	•	•

VARIANT	DIMENSION	PRICE
W. WALL SAFETY BRACKET	W100 x D34 x H115 cm W39.37" x D13.39" x H45.28"	855.00
W. FLOOR SAFETY BRACKET	W100 x D34 x H115 cm W39.37" x D13.39" x H45.28"	875.00

NO COMBINATION 401

ITEM LIST

- 1 x NO Wooden panel and door set incl. handle 100 cm
- 1 x NO Shelf Top 100 cm
- 3 x NO Shelf Middle 100 cm
- 1 x NO Shelf Bottom 100 cm
- 4 x NO Single Profile | Set of 4

Please remember to specify floor safety brackets when ordering this combination.

Order produced

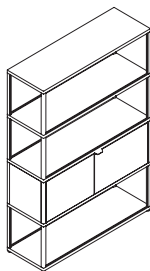

MATERIAL	COLOUR			
	Army	Charcoal	Light grey	Red
Powder coated aluminium	•	•	•	•

VARIANT	DIMENSION	PRICE
W. WALL SAFETY BRACKET	W100 x D34 x H144,6 cm W39.37" x D13.39" x H56.93"	1,315.00
W. FLOOR SAFETY BRACKET	W100 x D34 x H144,6 cm W39.37" x D13.39" x H56.93"	1,335.00

NO COMBINATION 501

ITEM LIST

- 1 x NO Shelf Top 100 cm
- 4 x NO Shelf Middle 100 cm
- 1 x NO Shelf Bottom 100 cm
- 5 x NO Single Profile | Set of 4

Please remember to specify wall- or floor safety brackets when ordering this combination.

Stock item

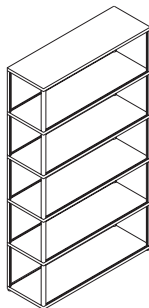

MATERIAL	COLOUR		
	Army	Charcoal	Light grey
Powder coated aluminium	•	•	•

VARIANT	DIMENSION	PRICE
W. WALL SAFETY BRACKET	W100 x D34 x H179,9 cm W39.37" x D13.39" x H70.83	1,270.00
W. FLOOR SAFETY BRACKET	W100 x D34 x H179,9 cm W39.37" x D13.39" x H70.83	1,290.00

NO COMBINATION 502

ITEM LIST

- 1 x NO Shelf Top 100 cm
- 4 x NO Shelf Middle 100 cm
- 1 x NO Shelf Bottom 100 cm
- 5 x NO Single Profile | Set of 4
- 2 x NO Steel side panel 34 cm | Powder coated steel
- 1 x NO Steel back panel 100 cm | Powder coated steel
- 1 x NO Steel sliding door 100 cm | Incl. handle powder coated steel

Please remember to specify wall- or floor safety brackets when ordering this combination.

Order produced

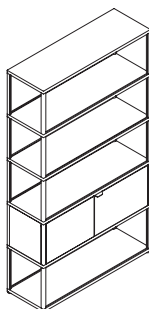

MATERIAL	COLOUR		
	Army	Charcoal	Light grey
Powder coated aluminium	•	•	•

VARIANT	DIMENSION	PRICE
W. WALL SAFETY BRACKET	W100 x D34 cm x H179,9 cm W39.37" x D13.39" x H70,83"	1,590.00
W. FLOOR SAFETY BRACKET	W100 x D34 cm x H179,9 cm W39.37" x D13.39" x H70,83"	1,610.00

NO COMBINATION 701

ITEM LIST

- 1 x NO Shelf Top 100 cm
- 6 x NO Shelf Middle 100 cm
- 1 x NO Shelf Bottom 100 cm
- 7 x NO Single Profile | Set of 4

Please remember to specify wall- or floor safety brackets when ordering this combination.

Stock item

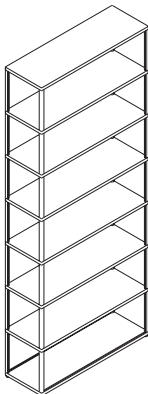

MATERIAL	COLOUR			
	Army	Charcoal	Light grey	Red
Powder coated aluminium	•	•	•	•

VARIANT	DIMENSION	PRICE
W. WALL SAFETY BRACKET	W100 x D34 x H250,5 cm W39.37" x D13.39" x H98.62"	1,700.00
W. FLOOR SAFETY BRACKET	W100 x D34 x H250,5 cm W39.37" x D13.39" x H98.62"	1,720.00

NO COMBINATION 702

ITEM LIST

- 1 x NO Shelf Top 150 cm
 - 6 x NO Shelf Middle 150 cm
 - 1 x NO Shelf Bottom 150 cm
 - 7 x NO Single Profile | Set of 4
 - 4 x NO Steel side panel 34 cm | Powder coated steel
 - 2 x NO Steel back panel 150 cm | Powder coated steel
 - 2 x NO Steel sliding door 150 cm | Incl. handle, powder coated steel
- Please remember to specify wall- or floor safety brackets when ordering this combination.

Order produced

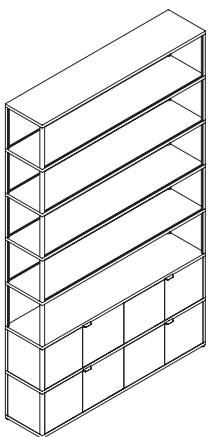

MATERIAL	COLOUR			
	Army	Charcoal	Light grey	
Powder coated aluminium	•	•	•	•

VARIANT	DIMENSION	PRICE
W. WALL SAFETY BRACKET	W150 x D34 x H250,5 cm W59.06" x D13.39" x H98.62"	3,236.00
W. FLOOR SAFETY BRACKET	W150 x D34 x H250,5 cm W59.06" x D13.39" x H98.62"	3,256.00

NO TABLE COMBINATION 401

ITEM LIST

- 1 x NO Legs H74 Army | Set of 2 w. 2 flat knots
- 1 x NO Table Connector Front 20 cm | Set of 2
- 1 x NO Shelf Top 100 cm
- 3 x NO Shelf Middle 100 cm
- 1 x NO Shelf Bottom 100 cm
- 3 x NO Single Profile | Set of 4
- 2 x NO Steel side panel double height 34 cm | For adjustable shelf | Powder coated steel
- 1 x NO Steel table back panel double height 100 cm | Powder coated steel
- 1 x NO Single Profile for double height | Set of 4
- 2 x NO Steel shelf 100 cm | Incl. pin 4 pcs. for adjustable side panels, powder coated steel
- 1 x NO Steel sliding door double height 100 cm | Incl. handle, powder coated steel
- 1 x NO Frame L100 x W100 F2
- 1 x NO Tabletop 100x100 L994 x W994 B

Please remember to specify wall- or floor safety brackets when ordering this combination.

Order produced

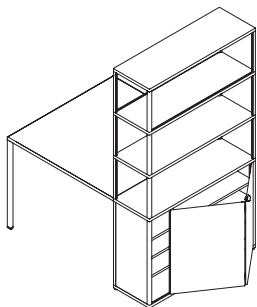

MATERIAL	COLOUR		
	Army	Charcoal	Light grey
Powder coated aluminium	•	•	•

VARIANT

W. FLOOR SAFETY
BRACKET

DIMENSION

W100 x D134 x H179,9 cm
W39.37" x D52.76" x H70.83"

PRICE

2,880.00

COLOURS & MATERIALS

SHELVING SYSTEM & TABLE FRAME

Powder-coated aluminium & steel



ARMY

CHARCOAL

LIGHT GREY

RED

*Not available for table frame and steel

TABLETOPS

Linoleum

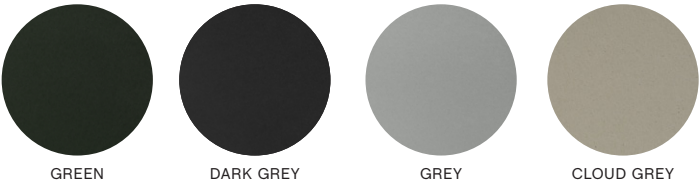

GREEN

DARK GREY

GREY

CLOUD GREY

Veneer



WATER-BASED LACQUERED OAK

WOODEN PANELS AND DOORS

Veneer



UNTREATED OAK VENEER

UNTREATED ASH VENEER

TEXTILE PANELS, TABLE SCREENS AND BENCHTOP

All textile colours available from each of the selected collections



SURFACE BY HAY

STEELCUT TRIO

STEELCUT

CANVAS

REMIX

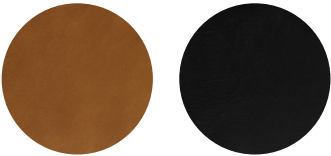

LEATHER SENSE COGNAC (Benchtop only)

LEATHER SIERRA BLACK S11001 (Benchtop only)

GENERAL TERMS OF SALE AND DELIVERY

All sales are subject to our Sales Procedures for Dealers which can be found at hayb2b.com or be requested from your HAY sales contact person.

[LINK TO SALES PROCEDURES](#)

FABRIC & LEATHER UPHOLSTERY

Please see our Fabric Overview for approved standard fabrics.

[LINK TO OVERVIEW](#)

CARE & MAINTENANCE

Our Care & Maintenance offers guidance for optimal maintenance of your HAY product. It includes advice and instructions on cleaning and caring for specific materials to prolong the life of your furniture. Find the guide

[LINK TO CARE & MAINTENANCE](#)

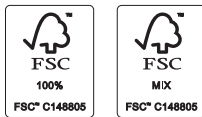

FSC™ CERTIFICATION

HAY is FSC™ certified. FSC (Forest Stewardship Council) is an international non-profit organisation and a labelling system for wood and paper that originate from certified forestry and other controlled sources. HAY's FSC license code is: FSC™-C148805. Only products that are identified as FSC™ are made from FSC-certified materials.

ECOLABELS

The Nordic Swan Ecolabel is the official ecolabel in the Nordics and the EU Ecolabel is the official ecolabel in Europe. They work to reduce the overall environmental impact from production and consumption. To ensure maximum environmental impact, the Nordic Swan Ecolabel and the EU Ecolabel take an entire life cycle approach and look at the full product journey. This means that the ecolabels evaluate the environmental impact of the specific product type and set requirements in all relevant stages of the product life cycle – from raw materials, production and use, to waste, re-use and recycling.

Both the Nordic Swan Ecolabel and the EU Ecolabel promote circular economy and are powerful tools for securing a sustainable future. HAY supports this by developing sustainable, quality products that are designed to last. All constructed with the focus on the disassembly and recycling of the product at the end of its life.

SUSTAINABILITY

HAY focuses on developing long-lasting products that minimise our environmental impact. We optimise the use of sustainable materials such as recycled materials, FSC-certified wood and water-based lacquer, with a growing number of eco-certified products. We have strict regulatory requirements, and the majority of our products are tested to comply with international standards for strength, durability and safety.

[LINK TO ENVIRONMENTAL PROFILE](#)

DOWNLOADS

Packshots and lifestyle photos, 2D / 3D files, care and maintenance, instructions, test certificates, product fact sheets, and product presentations are available in our Image Bank at hay.com.

[LINK TO IMAGE BANK](#)