

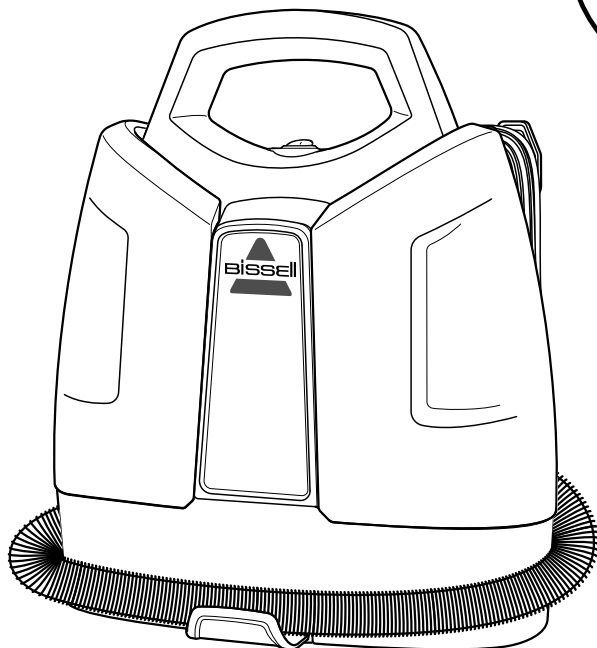

SPOTCLEAN AUTO

USER GUIDE
4720K



IMPORTANT SAFETY INSTRUCTIONS

READ ALL INSTRUCTIONS BEFORE USING YOUR APPLIANCE.

When using an electrical appliance, basic precautions should be observed, including the following:



WARNING

TO REDUCE THE RISK OF FIRE, ELECTRIC SHOCK OR INJURY:

- » This appliance can be used by children aged from 8 years and above and persons with reduced physical, sensory or mental capabilities or lack of experience and knowledge if they have been given supervision or instruction concerning use of the appliance in a safe way and understand the hazards involved. Cleaning and user maintenance shall not be made by children without supervision.
- » Children should be supervised to ensure that they do not play with the appliance.
- » Unplug from electrical socket when not in use, before cleaning, maintaining, or servicing the appliance.
- » Do not immerse in water or liquid.
- » Keep hair, loose clothing, fingers, and all parts of body away from openings and moving parts of the appliance and its accessories
- » If the supply cable is damaged, it must be replaced by the manufacturer, its service agent or similarly qualified person in order to avoid a hazard.
- » Do not run appliance over cable.
- » Do not use with damaged cable or plug.
- » Do not pull or carry by cable, use cable as a handle, close door on cable, or pull cable around sharp edges or corners.
- » Keep cable away from heated surfaces.
- » If the appliance has a hand-held accessory like pet brush, motor driven head, etc., the user shall avoid entrapment.
- » Do not leave appliance when plugged in.
- » Do not immerse. Use only on surfaces moistened by the cleaning process. Use only BISSELL® cleaning products intended for use with this machine.
- » Use only the type and amount of liquids specified under the operations section of this guide.
- » Use only on carpet moistened by the cleaning process.
- » Liquid must not be directed towards equipment containing electrical components.
 - » Always connect to a properly earthed electrical socket. Do not modify earthed plug.
 - » Always install float before any wet pick-up operation.
 - » To unplug, grasp the plug, not the cable.
 - » Do not handle plug or appliance with wet hands.
 - » Turn OFF all controls before unplugging.
 - » CAUTION: The handle contains electrical connections. The handle is not a serviceable part.
 - » Plastic film can be dangerous. To avoid danger of suffocation, keep away from children.
 - » Use only as described in this user guide.
 - » Use only manufacturer's recommended attachments.
 - » If appliance is not working as it should, has been dropped, damaged, left outdoors, or dropped into water; do not attempt to operate it and have it repaired at an authorised service center.
 - » Do not put any object into openings.
 - » Do not use with any opening blocked; keep free of dust, lint, hair, and anything that may reduce air flow.
 - » Use extra care when cleaning on stairs.
 - » Do not use to pick up flammable or combustible liquids, such as petroleum, or use in areas where they may be present.
 - » Do not pick up toxic material (chlorine bleach, ammonia, drain cleaner, etc.).
 - » Do not use appliance in an enclosed space filled with vapours given off by oil-based paint, paint thinner, some moth-proofing substances, flammable dust, or other explosive or toxic vapours.
 - » Do not pick up hard or sharp objects such as glass, nails, screws, coins, etc.
 - » Do not pick up anything that is burning or smoking, such as cigarettes, matches or hot ashes.
 - » Use indoors only.

SAVE THESE INSTRUCTIONS

ORIGINAL INSTRUCTIONS.

FOR OPERATION ON A 220-240 VOLT A.C. 50-60 HZ POWER SUPPLY ONLY.

THIS MODEL IS FOR HOUSEHOLD USE ONLY.

IMPORTANT INFORMATION

- » Keep appliance on a level surface.
- » To reduce the risk of a leaking condition, do not store unit where freezing may occur. Damage to internal components may result.

Thanks for buying a BISSELL® portable carpet cleaner!

We love to clean and we're excited to share one of our innovative products with you. We want your portable carpet cleaner to work like new for the years to come, so this guide has tips on how to use, maintain and, if there's a problem, troubleshoot.

Your portable carpet cleaner needs a little assembly before getting to work, so flip to the "Assembly" section and let's get started!

What's In The Box?

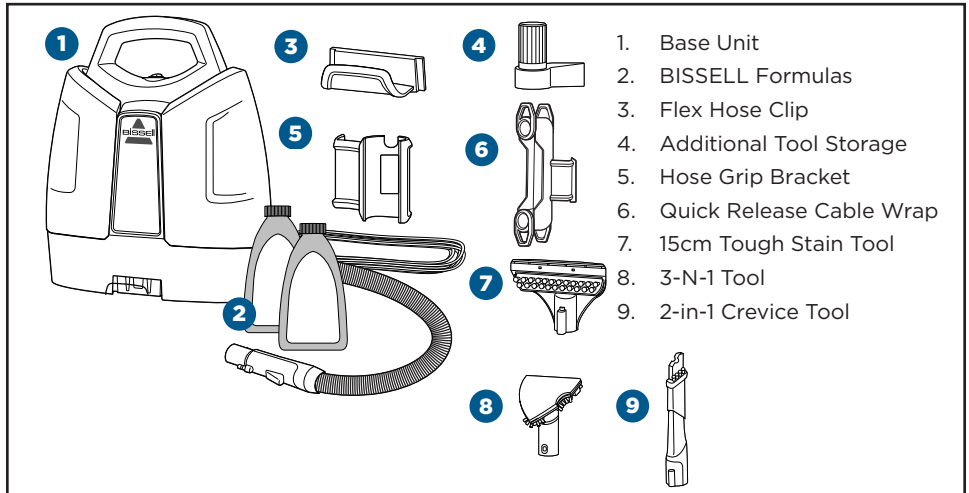

Safety Instructions.....	2
Product View.....	4
Cleaning Formula.....	4
Assembly	5
Operations	6-7

Maintenance & Care	8-10
Troubleshooting	11
Guarantee.....	12
Consumer Care.....	12

Product View

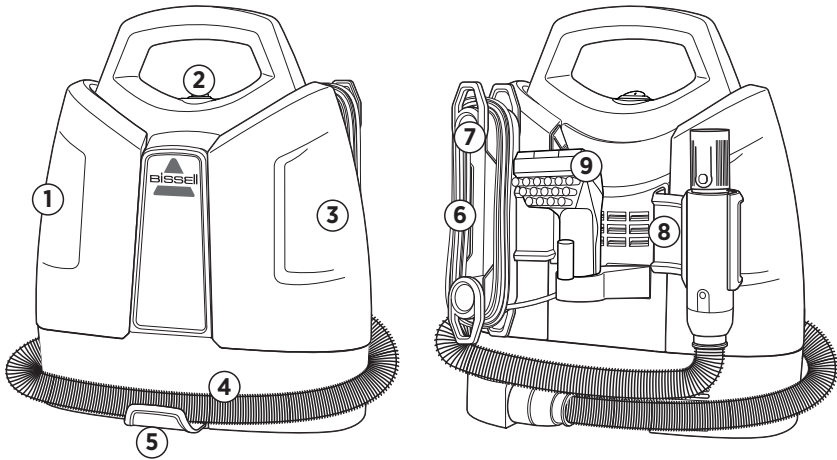

- | | |
|--|---|
| <ul style="list-style-type: none"> 1. Clean Water/Formula Tank 2. Power Button 3. Dirty Water Tank 4. Flex Hose 5. Flex Hose Clip | <ul style="list-style-type: none"> 6. Power Cable 7. Quick Release Cable Wrap 8. Hose Grip Bracket 9. Additional Tool Storage |
|--|---|

Cleaning Formula

WARNING To reduce the risk of fire and electric shock due to internal component damage, use only BISSELL® cleaning formula intended for use with this machine.

Keep plenty of genuine BISSELL Spot & Stain Cleaner formula for portable carpet cleaning machines on hand so you can clean whenever it fits your schedule. Always use genuine BISSELL cleaning formulas.

PRETREAT PRETREAT SPOTS AND STAINS TO IMPROVE CARPET CLEANING		BOOST CARPET CLEANING FORMULA ENHANCER	2X* CONCENTRATED CLEANING FORMULAS	
				
Tough Stain Pretreat	Pet Stain Pretreat	Oxy Boost	Spot & Stain	Pet Stain & Odour
Pretreat to penetrate and loosen tough stains	Pretreat to help remove tough pet stains and odours	Removes old, set-in stains permanently	Specially formulated for fast, effective carpet cleaning of stains and small high traffic areas	Effectively eliminates difficult pet odours from carpets and upholstery

*60 mL of 2X concentrated formula is equivalent to 120 mL of non-concentrated formula.

NOTICE: Use of cleaning formulas which contain lemon, pine or eucalyptus oil may damage this appliance and void the warranty. Chemical spot cleaners or solvent-based soil removers also should not be used. These products may react with the plastic materials used in your cleaner, causing cracking or pitting.

Assembly

WARNING

Do not plug in your cleaner until you are familiar with all instructions and operating procedures.

1

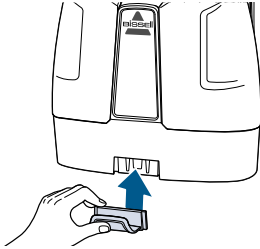

Slide the Flex Hose Clip into the opening on the front of the machine. You will hear a “snap” when it is locked into place.

2

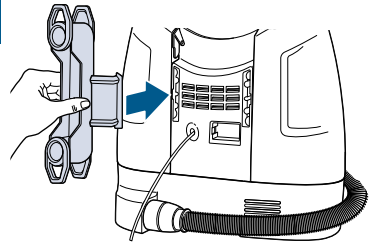

Attach Quick Release Cable Wrap by snapping it into place on the Dirty Water Tank side of the machine.

3

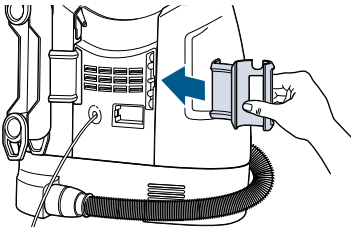

Snap the Hose Grip Bracket into the back of the machine on the Clean Water/Formula Tank side.

4

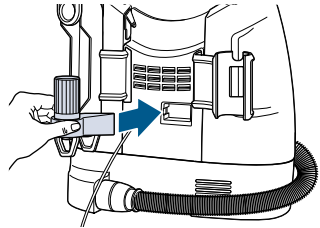

Snap the second tool storage (select models) into the back between the cable wrap and hose grip bracket.

5

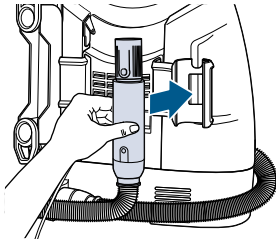

Then wrap the Flex Hose around the unit and snap hose grip into bracket.

6

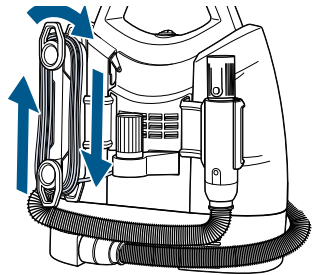

Wrap the Power Cable around the Quick Release Cable Wrap.

Filling the Clean Water/Formula Tank

1

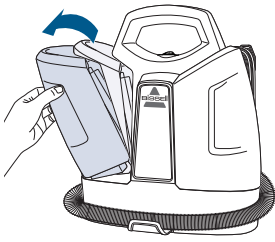

Remove the tank by pulling the top of the tank away from the unit.

2

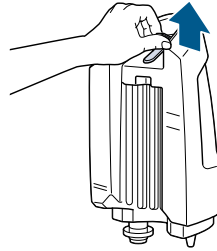

Pull black tab to reveal tank opening. The plug rotates out of the way for easy filling.

3

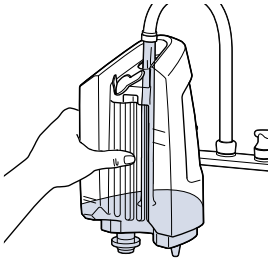

Add water to the indicated fill line on the tank.

4

FORMULA

BOOST

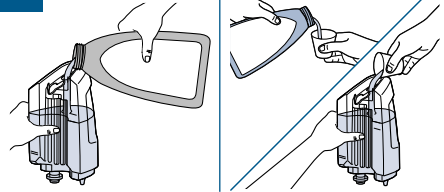

Add formula to the indicated fill line on the tank. Add 29.5ml of BISSELL® Boost, if desired.

NOTE: Follow the fill lines on your Clean Water/Formula Tank to add the correct amount of warm tap water (140° F / 60° C MAX) and portable machine formula. Note: There are different directions on the tank for small and large messes. **DO NOT BOIL OR MICROWAVE WATER.**

5

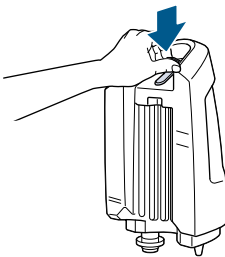

Replace the plug by rotating into place and pressing gently onto tank.

6



Replace tank by lining the bottom with indentations on machine. Push the top of the tank into place until you hear a "click".

Pretreating

IMPORTANT: Check the manufacturer's tag before cleaning upholstery. If tag is coded "Dry Clean Only" do not proceed. If manufacturer's tag is missing or not coded, check with your furniture dealer.

WHY PRETREAT? Cleaning effectiveness will be enhanced if you pretreat heavily stained or highly soiled areas.

1

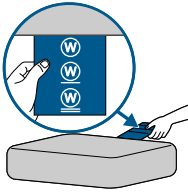

Check the manufacturer's tag before cleaning upholstery.

2

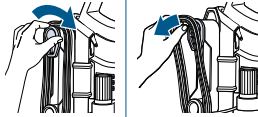

Twist the Quick Release Cable Wrap clockwise to quickly unwrap power cable. Plug in unit and press Power Button beneath the handle to turn it ON.

3

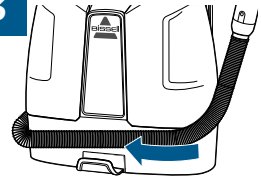

Release the Flex Hose from the Hose Clip. Unwrap Flex Hose completely from around the unit.

4

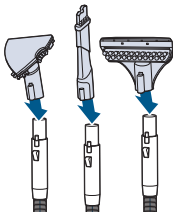

Select desired tool for spot cleaning, insert tool on end of hose until it clicks into place.

5

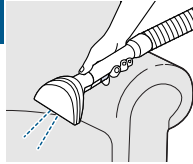

Hold the tool just above the carpet or upholstery to be cleaned. Press the trigger to mist formula over the soiled area.

6



Let cleaning formula set for 5 minutes before cleaning.

Cleaning with Tools

WARNING

Keep spray away from face. Failure to do so may result in personal injury.

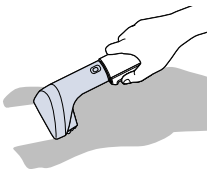

Attach the selected tool to the Flex Hose. Press the spray trigger to mist formula over and onto the soiled area. Release spray trigger and gently scrub the stain.

To lift the stain away, apply downward pressure on the tool and slowly pull it toward you. Then use "drying strokes" (by not pressing down trigger) to remove remaining moisture. Repeat as needed.

NOTE: Ensure cleaning formula and water are in the tank before use.

Emptying the Dirty Water Tank

WARNING

To reduce the risk of electric shock, turn power OFF and disconnect from electrical outlet before performing maintenance or troubleshooting.

1

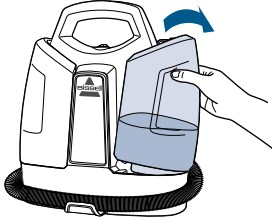

To remove the Dirty Water Tank simply pull the top of the tank to the right.

2

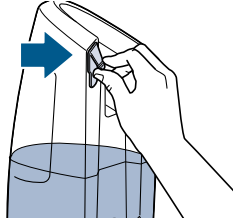

Pull tab to remove plug from tank.

3

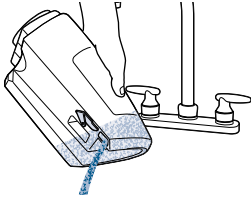

Carefully empty Dirty Water Tank, as some water may potentially enter/drain from center Float Stack.

4

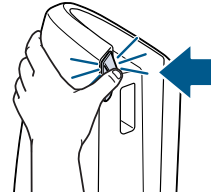

Close the tank plug and return tank to unit. Ensure tank is secure before use.

5

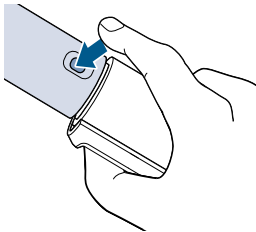

To disconnect the cleaning tools from the hose grip, push down on the button and pull straight off. (Do NOT twist tool to remove it.)

NOTE: Store unit in protected, dry area at room temperature (40° F to 110° F or 4° C to 43° C).

NOTICE

To reduce the risk of a leaking condition, do not store unit where freezing may occur. Damage to internal components may result.

Cleaning the Float Stack

WARNING

To reduce the risk electric shock, turn power OFF and disconnect from electrical outlet before performing maintenance or troubleshooting.

1

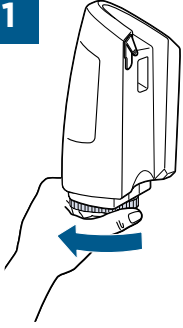

The Float Stack can be removed from the Dirty Water Tank for cleaning. Turn it counter-clockwise to remove it.

2

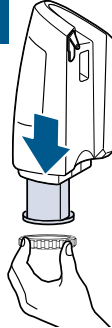

Remove the Float Stack Cap and Float Stack from the Dirty Water Tank.

3

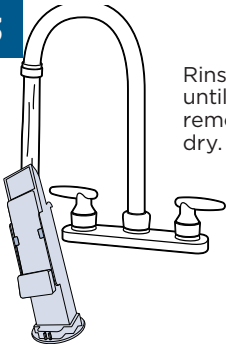

Rinse with water until all debris is removed and let air dry.

4

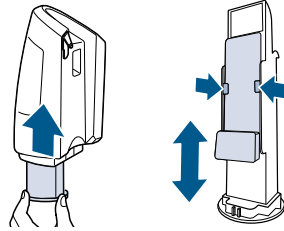

Return the Float Stack to the Dirty Water Tank. Ensure float is installed before returning it to the Dirty Water Tank.

5

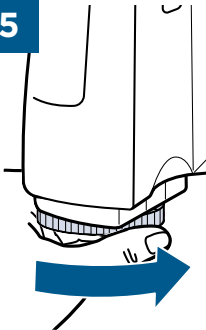

Turn the Float Stack Cap clockwise to lock.

Thermal Protector

An internal thermal protector has been designed into your carpet cleaner to protect it from overheating. When the thermal protector activates, the suction motor will stop operating. If this happens proceed as follows:

1

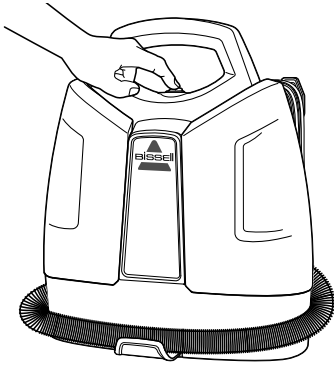

Turn the cleaner OFF.

2

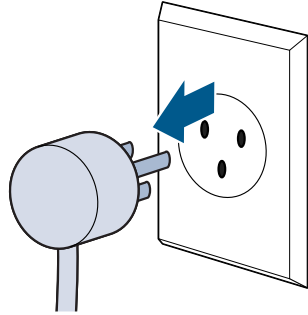

Unplug cleaner from the electrical outlet.

3

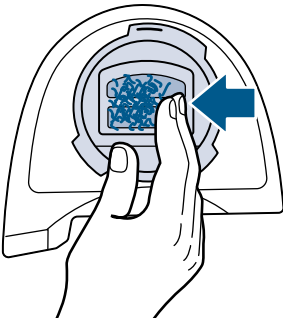

Check the end of the Flex Hose and tool for blockages and remove if necessary. Check the Float Stack for clogs and remove debris.

4

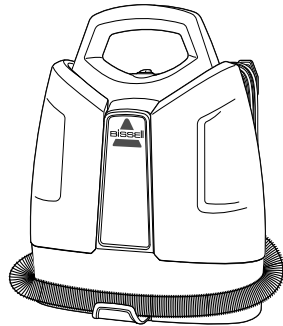

Let the motor cool for approximately 30 minutes. The thermal protector will automatically reset and cleaning may continue once plugged back in.

NOTE: If the thermal protector continues to activate after following the above steps, your cleaner may need servicing. Call BISSELL® Consumer Care or visit the website.

Troubleshooting

WARNING

To reduce the risk of electric shock, turn power OFF and disconnect from electrical outlet before performing maintenance or troubleshooting checks.

Problem	Possible causes	Remedies
Reduced Spray or No Spray	Spray nozzle clogged.	Clean spray nozzle using an unfolded paper clip.
	Clean Water/Formula Tank empty.	Check/fill tank.
	Clean Water/Formula Tank insert clogged.	Clean insert at bottom of tank.
	Pump needs priming.	Gently lift Clean Water/Formula Tank while pressing the spray trigger OR gently squeeze clean tank while pressing spray trigger.
	Clean Water/Formula Tank not fully seated.	Remove and reinstall tank.
Carpet Cleaner Won't Pick Up Cleaning Formula	Poor upholstery/carpet tool position.	Reposition upholstery/carpet tool on surface, follow recommended cleaning procedures.
	Dirty Water Tank is full.	Empty tank.
	Excess formula in Flex Hose.	Lift tool and point upwards to allow water in hose to flow into the Dirty Water Tank.
	Incorrect cleaning formula.	Use BISSELL® 2X Portable Machine formulas only.
	Dirty Water Tank is improperly seated onto base.	Remove tank and reseal onto unit.
	Dirty Water Tank plug is unplugged.	Push in tank plug until properly sealed.
Dirty Water Tank Leaking	Duckbill valve is dirty.	Clean the duckbill valve that is located at the bottom of the Dirty Water Tank. Once cleaned, make sure it is placed securely back in place.
	Float Stack not fully locked on Dirty Water Tank.	Remove Float Stack and twist until arrow is aligned with lock symbol on Dirty Water Tank (see pg. 12).
	Dirty Water Tank not properly seated onto machine.	Remove and reseal onto unit.

Consumer Guarantee

This guarantee gives you specific legal rights, in addition to rights you may have under the Australian Consumer Law. If you need additional instruction regarding this guarantee or have questions regarding what it may cover, please contact your local BISSELL Consumer Services on the details set out below.

Limited 2-Year Guarantee (from the date of purchase by original purchaser)

Subject to the *CONDITIONS identified below, BISSELL will repair or replace (with new, refurbished, lightly used, or remanufactured components or products), at BISSELL's option, free of charge, any defective or malfunctioning part due to manufacturer defect. This guarantee applies to product used for personal purposes, and not commercial or rental service. This guarantee does not apply to fans or routine maintenance or consumable components such as filters, belts, brush rolls, etc., damage or malfunction caused by negligence, abuse, neglect, unauthorized repair, or any other use not in accordance with the user guide. BISSELL recommends that the original packaging be kept for the duration of the guarantee period in case such need arises within the guarantee period that the item needs re-packing and transportation.

It may be necessary to obtain some of your personal information, such as a mailing address, to fulfill terms of this guarantee. Any personal data will be handled pursuant to BISSELL's Privacy Policy, which can be found at www.BISSELL.eu.

*CONDITIONS OF THE GUARANTEE

Subject to whether such loss is reasonably foreseeable, BISSELL and its in-country distributors are not liable for incidental or consequential damages of any nature associated with the use of this product.

FOR AUSTRALIAN CONSUMERS ONLY:

OUR GOODS COME WITH GUARANTEES THAT CANNOT BE EXCLUDED UNDER THE AUSTRALIAN CONSUMER LAW. YOU ARE ENTITLED TO A REPLACEMENT OR REFUND FOR A MAJOR FAILURE AND FOR COMPENSATION FOR ANY OTHER REASONABLY FORESEEABLE LOSS OR DAMAGE. YOU ARE ALSO ENTITLED TO HAVE THE GOODS REPAIRED OR REPLACED IF THE GOODS FAIL TO BE OF ACCEPTABLE QUALITY AND THE FAILURE DOES NOT AMOUNT TO A MAJOR FAILURE.

THIS GUARANTEE IS IN ADDITION TO OTHER RIGHTS OR REMEDIES UNDER LAW. NOTHING IN THIS GUARANTEE EXCLUDES, LIMITS OR MODIFIES ANY LIABILITY OF BISSELL WHICH IS IMPOSED BY LAW, OR LIMITS OR MODIFIES ANY REMEDY AVAILABLE TO THE CONSUMER WHICH IS GRANTED BY LAW. TO MAKE A CLAIM UNDER THIS GUARANTEE CONTACT BISSELL AUSTRALIA PTY LTD (DETAILS ABOVE). CONTACT BISSELL PRIOR TO RETURNING ANY GOODS. WHERE AGREED, BISSELL WILL REIMBURSE REASONABLE POSTAGE / HANDLING COSTS (IF ANY) FOR RETURNING GOODS TO BISSELL. TO CLAIM EXPENSES INCURRED IN MAKING A CLAIM UNDER THIS GUARANTEE PLEASE PROVIDE BISSELL WITH A COPY OF THE RECEIPT OF THE EXPENSES BY EMAIL OR POST.

Consumer Care

If your BISSELL® product should require service or to claim under our limited guarantee, please contact us as follows:

Website and Email:

www.bissell.com.au
www.bissell.co.nz

Telephone:

Australia: 1300-247-735

New Zealand: 0800-247-735

Replacement parts and accessories are available for purchase.
To purchase visit www.BISSELL.com.au.

Write:

BISSELL AUSTRALIA PTY LIMITED
42 Rocco Dr.
Scoresby 3179
Victoria
Australia

Visit the BISSELL website: www.BISSELL.com.au

When contacting BISSELL, have model number of cleaner available.

Please record your Model Number: _____

Please record your Purchase Date: _____

NOTE: Please keep your original sales receipt. It provides proof of the date of purchase in the event of a Guarantee claim. See Guarantee for details.



©2019 BISSELL Inc.
Grand Rapids, Michigan
All rights reserved. Printed in China.
Part Number 161-8405 01/19 Rev A
Visit our website at: www.BISSELL.com