

A photograph of a red, rectangular light source, possibly a lamp or a light fixture, sitting on a dark wooden table. The light source is illuminated from within, casting a warm glow. A black power cord with a small black switch is visible on the table to the left of the light source. The background is a soft, out-of-focus light source, possibly a window with blinds, creating a warm, ambient atmosphere.

LIGHT SOURCE

OVERVIEW

HAY

LIGHT SOURCE OVERVIEW

HAY recommends using the lamps with LED bulbs only

PRODUCT / BULB NOT INCLUDED

RECOMMENDED LIGHT SOURCE

Pao Steel Pendant 230

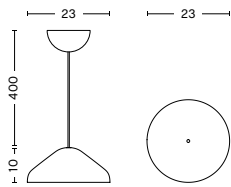

2 x LED G9, 3-5W (max. 5W), 300-600lm, 2700-3000K warm white



Pao Steel Pendant 350

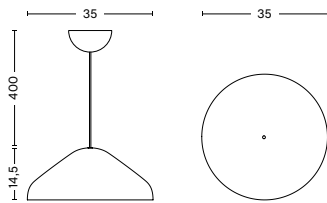

2 x LED E14 (A15), 5-8W (max. 8W), 500-800lm, 2700-3000K warm white

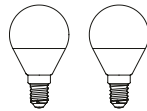

Pao Steel Pendant 470

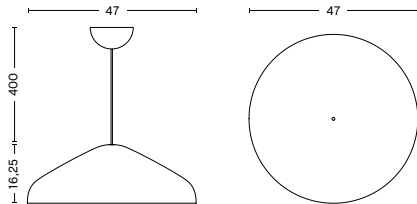

2 x LED E27 (A19), 10-13W (max. 13W), 1000-1500lm, 2700-3000K warm white

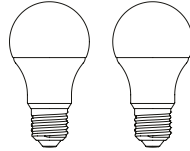

Matin Flush Mount 380

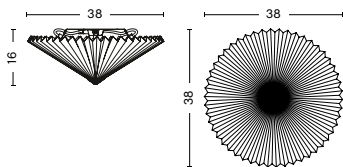

2 x LED E14 (A15 or B8), 5-8W (max. 8W), 500-800lm, 2700-3000K warm white

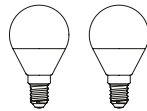

Matin Flush Mount 500

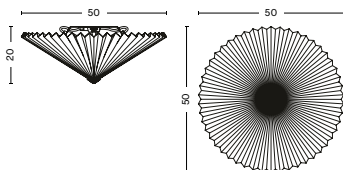

2 x LED E14 (A15 or B8), 5-8W (max. 8W), 500-800lm, 2700-3000K warm white

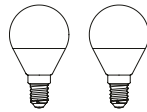

LIGHT SOURCE OVERVIEW

HAY recommends using the lamps with LED bulbs only

PRODUCT / BULB NOT INCLUDED

RECOMMENDED LIGHT SOURCE

PC Pendant S

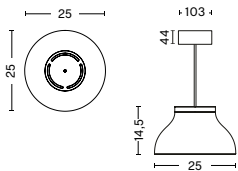

3 x LED G9, 3-5W (max. 5W), 300-600lm, 2700-3000K warm white

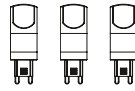

PC Pendant M

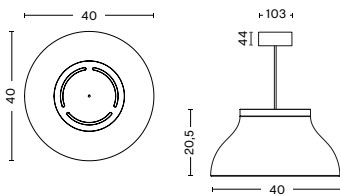

1 x LED E27 (A19), 10-13W (max. 13W), 1000-1500lm, 2700-3000K warm white



PC Pendant L

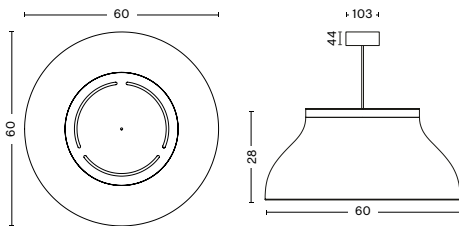

3 x LED E27 (A19), 10-13W (max. 13W), 1000-1500lm, 2700-3000K warm white

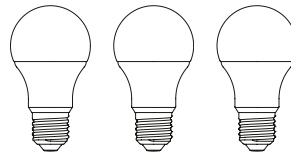

PC Table S

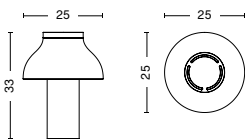

1 x LED E27 (A19), 10-13W (max. 13W), 1000-1500lm, 2700-3000K warm white, Dimmable

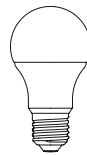

PC Table L

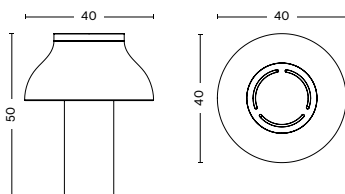

1 x LED E27 (A19), 10-13W (max. 13W), 1000-1500lm, 2700-3000K warm white, Dimmable

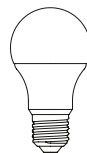

LIGHT SOURCE OVERVIEW

HAY recommends using the lamps with LED bulbs only

PRODUCT / BULB NOT INCLUDED

RECOMMENDED LIGHT SOURCE

Bonbon Shade 320

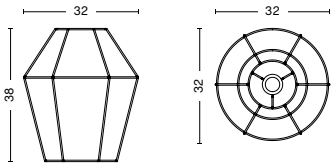

1 x LED E27 (A19), 10-13W (max. 15W), 1000-1500lm, 2700K warm white

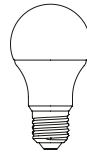

Bonbon Shade 380

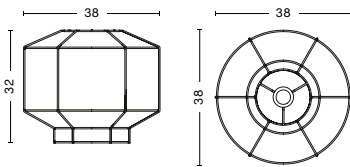

1 x LED E27 (A19), 10-13W (max. 15W), 1000-1500lm, 2700K warm white

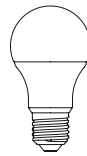

Bonbon Shade 500

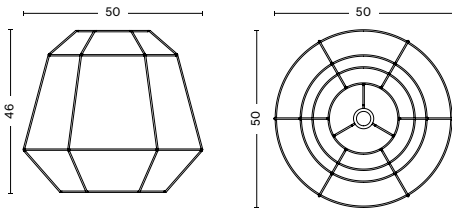

1 x LED E27 (A21 or G30), 10-13W (max. 15W), 1000-1500lm, 2700K warm white

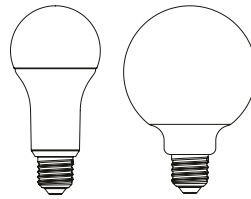

Cord Set Pendant

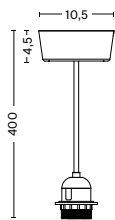

1 x LED E27, MAX 15W

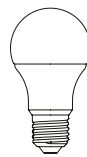

Cord Set Table

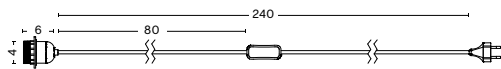

1 x LED E27, MAX 15W



LIGHT SOURCE OVERVIEW

HAY recommends using the lamps with LED bulbs only

PRODUCT / BULB NOT INCLUDED

RECOMMENDED LIGHT SOURCE

Nelson Ball Bubble Pendant S

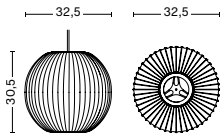

1 x LED E27 (A15), 5-8W (max. 8W), 500-800lm, 2700-3000K warm white



Nelson Ball Bubble Pendant M

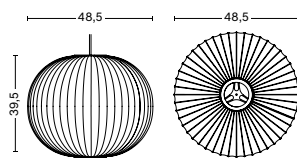

1 x LED E27 (A19), 10-13W (max. 13W), 1000-1500lm, 2700K warm white

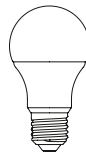

Nelson Ball Bubble Pendant L

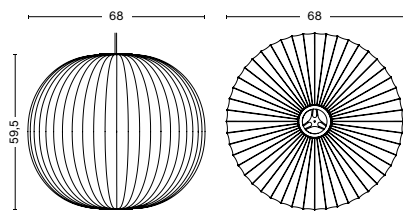

1 x LED E27 (A21 or G30), 10-13W (max. 13W), 1000-1500lm, 2700K warm white

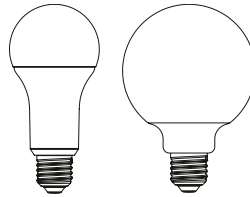

Nelson Cigar Bubble Pendant S

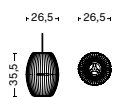

1 x LED E27 (A15), 5-8W (max. 8W), 500-800lm, 2700-3000K warm white



Nelson Cigar Bubble Pendant M

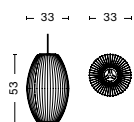

1 x LED E27 (A19), 10-13W (max. 13W), 1000-1500lm, 2700K warm white

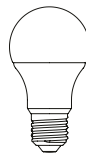

LIGHT SOURCE OVERVIEW

HAY recommends using the lamps with LED bulbs only

PRODUCT / BULB NOT INCLUDED

RECOMMENDED LIGHT SOURCE

Nelson Cigar Bubble Pendant L

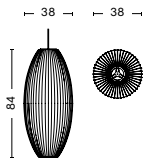

1 x LED E27 (A21 or G30), 10-13W (max. 13W), 1000-1500lm, 2700K warm white

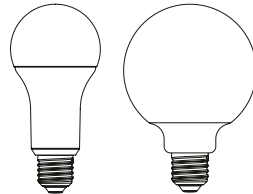

Nelson Cigar Bubble Pendant XL

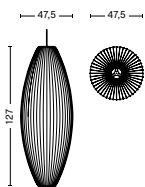

1 x LED E27 (A21 or G30), 10-13W (max. 13W), 1000-1500lm, 2700K warm white

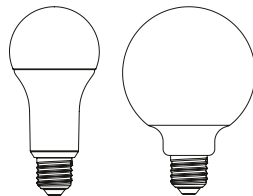

Nelson Saucer Bubble Pendant S

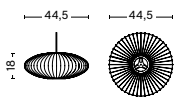

1 x LED E27 (A15), 5-8W (max. 8W), 500-800lm, 2700-3000K warm white



Nelson Saucer Bubble Pendant M

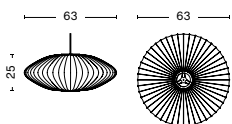

1 x LED E27 (A19), 10-13W (max. 13W), 1000-1500lm, 2700K warm white

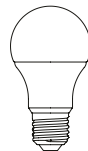

Nelson Saucer Bubble Pendant L

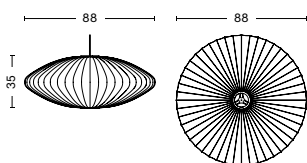

1 x LED E27 (A21 or G30), 10-13W (max. 13W), 1000-1500lm, 2700K warm white

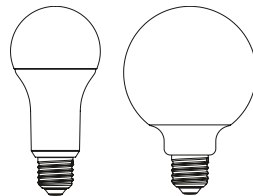

Nelson Saucer Bubble Pendant XL

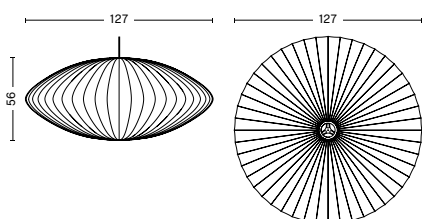

1 x LED E27 (A21 or G30), 10-13W (max. 13W), 1000-1500lm, 2700K warm white

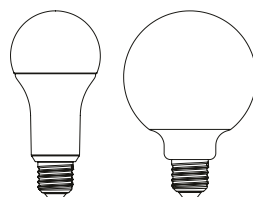

LIGHT SOURCE OVERVIEW

HAY recommends using the lamps with LED bulbs only

PRODUCT / BULB NOT INCLUDED

RECOMMENDED LIGHT SOURCE

Nelson Saucer Crisscross Bubble Pendant S

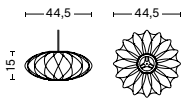

1 x LED E27 (A15), 5-8W (max. 8W), 500-800lm, 2700-3000K warm white



Nelson Saucer Crisscross Bubble Pendant M

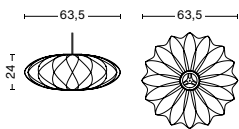

1 x LED E27 (A19), 10-13W (max. 13W), 1000-1500lm, 2700K warm white

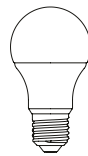

Nelson Ball Crisscross Bubble Pendant S

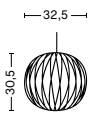

1 x LED E27 (A15), 5-8W (max. 8W), 500-800lm, 2700-3000K warm white



Nelson Ball Crisscross Bubble Pendant M

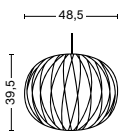

1 x LED E27 (A19), 10-13W (max. 13W), 1000-1500lm, 2700K warm white

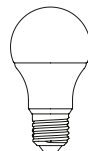

Nelson Cigar Crisscross Bubble Pendant S

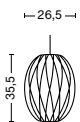

1 x LED E27 (A15), 5-8W (max. 8W), 500-800lm, 2700-3000K warm white



Nelson Cigar Crisscross Bubble Pendant M

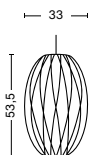

1 x LED E27 (A19), 10-13W (max. 13W), 1000-1500lm, 2700K warm white

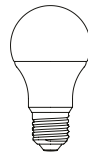

LIGHT SOURCE OVERVIEW

HAY recommends using the lamps with LED bulbs only

PRODUCT / BULB NOT INCLUDED

RECOMMENDED LIGHT SOURCE

Nelson Pear Crisscross Bubble Pendant S

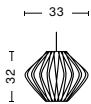

1 x LED E27 (A15), 5-8W (max. 8W), 500-800lm, 2700-3000K warm white



Nelson Pear Crisscross Bubble Pendant M

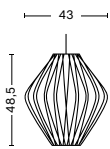

1 x LED E27 (A19), 10-13W (max. 13W), 1000-1500lm, 2700K warm white

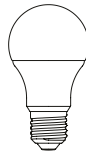

Nelson Pear Bubble Pendant S

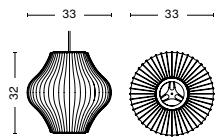

1 x LED E27 (A15), 5-8W (max. 8W), 500-800lm, 2700-3000K warm white



Nelson Pear Bubble Pendant M

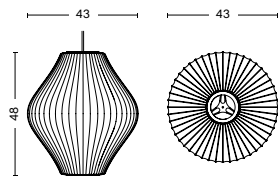

1 x LED E27 (A19), 10-13W (max. 13W), 1000-1500lm, 2700K warm white

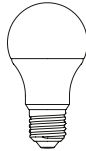

Nelson Apple Bubble Pendant M

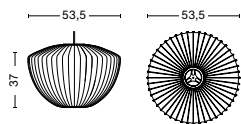

1 x LED E27 (A19), 10-13W (max. 13W), 1000-1500lm, 2700K warm white

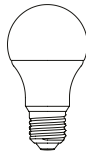

Nelson Bell Bubble Pendant XL

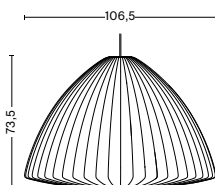

1 x LED E27 (A21 or G30), 10-13W (max. 13W), 1000-1500lm, 2700K warm white

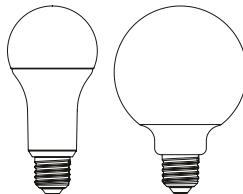

LIGHT SOURCE OVERVIEW

HAY recommends using the lamps with LED bulbs only

PRODUCT / BULB NOT INCLUDED

RECOMMENDED LIGHT SOURCE

Nelson Propeller Bubble Pendant M

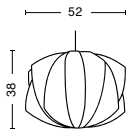

1 x LED E27 (A19), 10-13W (max. 13W), 1000-1500lm, 2700K warm white

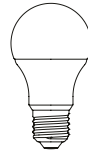

Nelson Lantern Bubble Pendant S

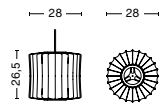

1 x LED E27 (A15), 5-8W (max. 8W), 500-800lm, 2700-3000K warm white



Nelson Ball Wall Sconce Cabled S

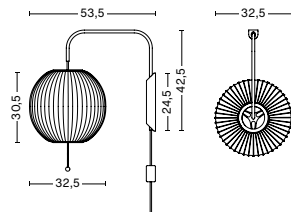

1 x LED E27 (A15), 5-8W (max. 8W), 500-800lm, 2700-3000K warm white



Nelson Cigar Wall Sconce Cabled S

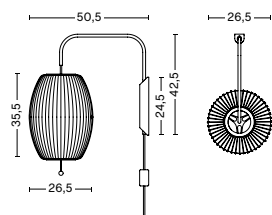

1 x LED E27 (A15), 5-8W (max. 8W), 500-800lm, 2700-3000K warm white



Nelson Saucer Wall Sconce Cabled S

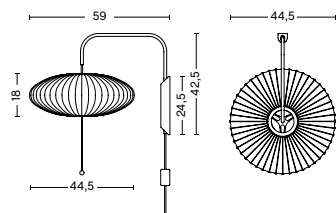

1 x LED E27 (A15), 5-8W (max. 8W), 500-800lm, 2700-3000K warm white



LIGHT SOURCE OVERVIEW

HAY recommends using the lamps with LED bulbs only

PRODUCT / BULB NOT INCLUDED

RECOMMENDED LIGHT SOURCE

Nelson Pear Wall Sconce Cabled S

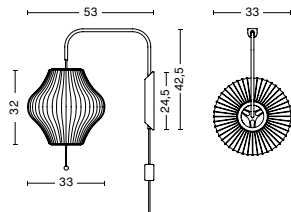

1 x LED E27 (A15), 5-8W (max. 8W), 500-800lm, 2700-3000K warm white



30 Degrees S

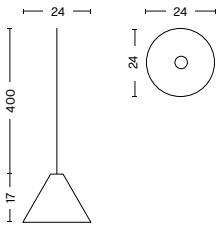

1 x LED E27 (A15), 5-8W (max. 15W), 470lm, 2700K warm white



30 Degrees M

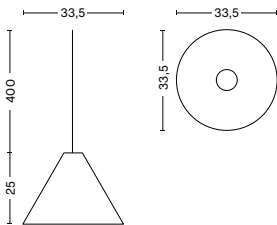

1 x LED E27 (A19), 10-13W (max. 15W), 810lm, 2700K warm white

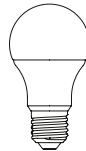

30 Degrees L

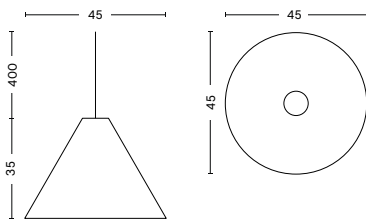

1 x LED E27 (A19), 10-13W (max. 15W), 810lm, 2700K warm white

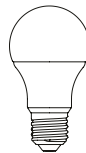

LIGHT SOURCE OVERVIEW

HAY recommends using the lamps with LED bulbs only

PRODUCT / BULB NOT INCLUDED

RECOMMENDED LIGHT SOURCE

Arcs Shade

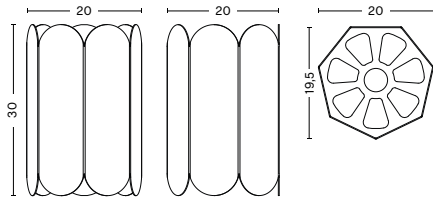

1 x LED E27 (A15 or A19), 10-13W (max. 15W), 1000-1500lm, 2700K warm white



Arcs Wall Sconce

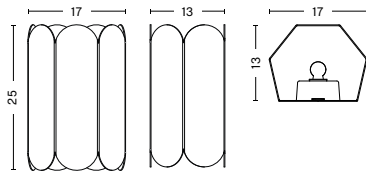

1 x LED E14 (A15 or A19), 5-8W (max. 8W), 500-800lm, 2700-3000K warm white



Arcs Wall Switch

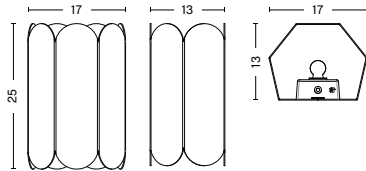

1 x LED E14 (A15 or A19), 5-8W (max. 8W), 500-800lm, 2700-3000K warm white



Slant

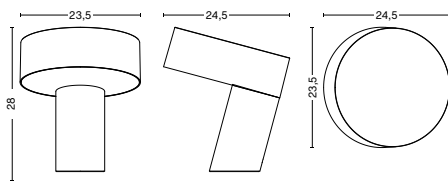

1 x LED E27 (A15 or A19), 10-13W (max. 15W), 1000-1500lm, 2700K warm white

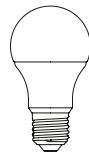

Cloche

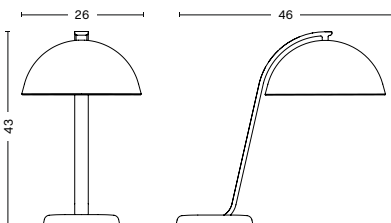

1 x LED E14 (A15), 5.5W (max. 8W), 470lm, 2800K warm white



LIGHT SOURCE OVERVIEW

HAY recommends using the lamps with LED bulbs only

PRODUCT / BULB NOT INCLUDED

RECOMMENDED LIGHT SOURCE

Noc Clip

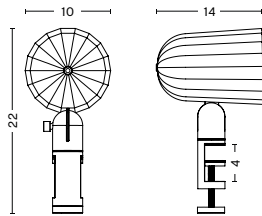

1 x LED E14 (A15), 5.5W (max. 5,5W), 470lm, 2800K warm white



Noc Wall

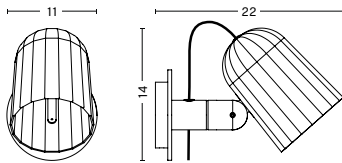

1 x LED E14 (A15), 5.5W (max. 5,5W), 470lm, 2800K warm white



Noc Wall Button

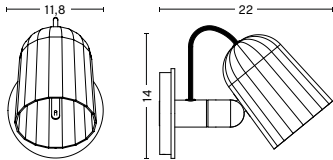

1 x LED E14 (A15), 5.5W (max. 5,5W), 470lm, 2800K warm white

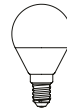

Apollo Table Lamp Shade

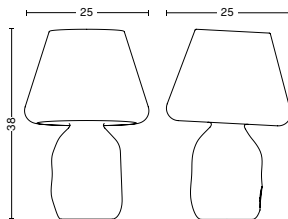

1 x LED E27 (A19), 10-15W (max. 15W), 1000-1500lm, 2700K warm white

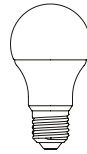

Anagram Table Lamp

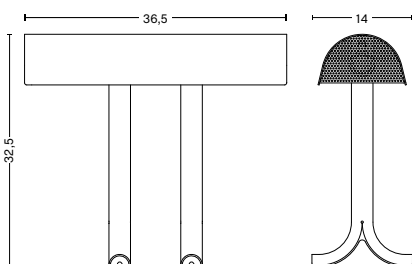

2 x LED E14 (B10), 5-8W (max. 8W), 500-800lm, 2700-3000K warm white

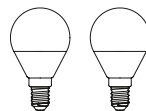

LIGHT SOURCE OVERVIEW

HAY recommends using the lamps with LED bulbs only

PRODUCT / BULB NOT INCLUDED

RECOMMENDED LIGHT SOURCE

Apollo Table Lamp Shade

1 x LED E27 (A19), 10-15W (max. 15W), 1000-1500lm, 2700K warm white

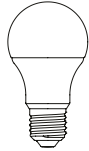
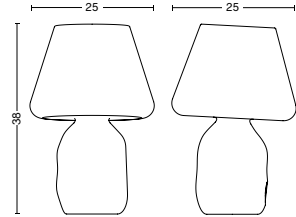

Pao Steel Floor Lamp

2 x LED E27 (A19), 10-13W (max. 13W), 1000-1500lm, 2700-3000K warm white

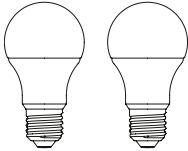
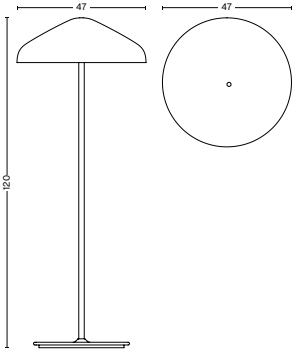

LIGHT SOURCE OVERVIEW

HAY recommends using the lamps with LED bulbs only

PRODUCT / BULB NOT INCLUDED

RECOMMENDED LIGHT SOURCE

Common Table Lamp Base

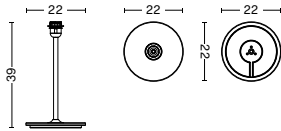

1 x LED E14 (A15), 8-13W (max. 13W), 1000-1500lm, 2700K warm white

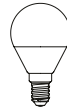

Common Floor Lamp Base

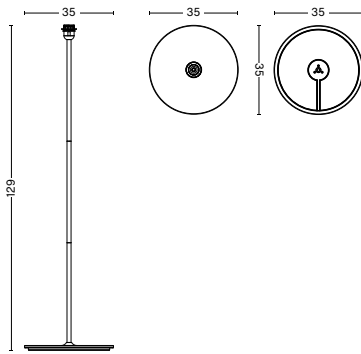

1 x LED E14 (A15), 8-13W (max. 13W), 1000-1500lm, 2700K warm white



Paper Cube Table Lamp

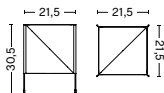

1 x LED E14 (A15), 5-8W (max. 8W), 500-800lm, 2700K warm white



Paper Cube Floor Lamp

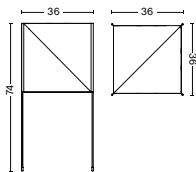

1 x LED E27 (A19), 10-13W (max. 13W), 500-00lm, 2700-3000K warm white

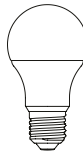

LIGHT SOURCE OVERVIEW

HAY recommends using the lamps with LED bulbs only

PRODUCT / BULB INCLUDED

LIGHT SOURCE

Apollo Portable Lamp

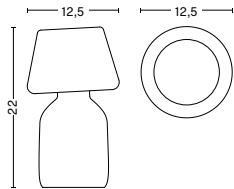

1 x LED G4, 3W, 220lm, 2800K warm white



Micro USB cable included for charging with a standard USB outlet

Pao Portable Lamp

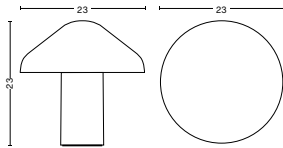

1 x LED G4, 3W, 220lm, 2800K warm white



Micro USB cable included for charging with a standard USB outlet

PC Portable

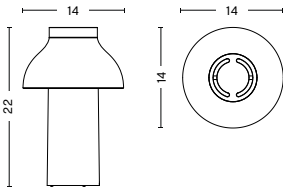

1 x LED G4, 3W, 220lm, 2800K warm white



Micro USB cable included for charging with a standard USB outlet

LIGHT SOURCE OVERVIEW

PRODUCT / INTEGRATED LED

LIGHT SOURCE

Pao Glass Pendant 350

Integrated LED, 10W, 690lm 2600K warm white

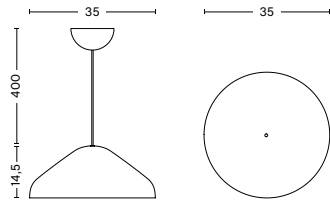

Pao Glass Table Lamp

Integrated LED, 11W, 700lm 2600K warm white

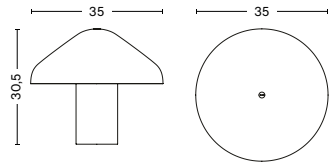

PC Linear

Integrated LED, 28W, 2300lm, 3000K warm white

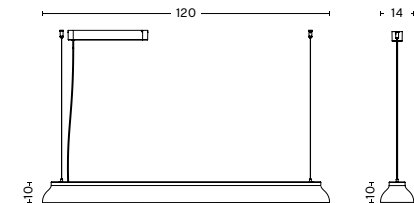

Factor Linear Suspension Lamp

Integrated LED, 38W, 2300lm (Diffused), 3600lm (Directional), 2600K (Diffused), 3500K (Directional) warm white

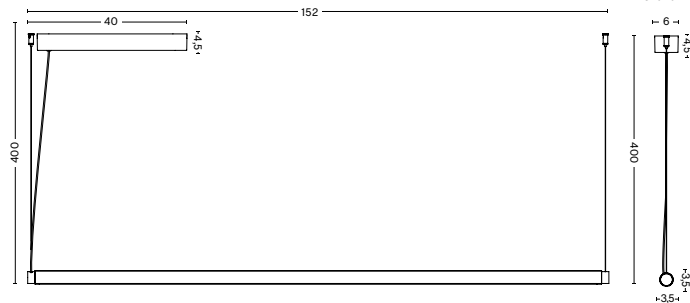

LIGHT SOURCE OVERVIEW

PRODUCT / INTEGRATED LED

LIGHT SOURCE

PC Task Double arm w. clamp

Integrated LED, 5.7W, 407lm, 3100K cool white

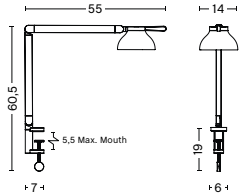

PC Double arm w. wall bracket

Integrated LED, 5.7W, 407lm, 3100K cool white

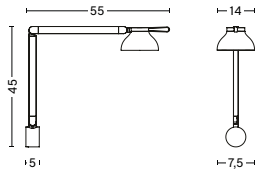

PC Task Double arm w. table insert

Integrated LED, 5.7W, 407lm, 3100K cool white

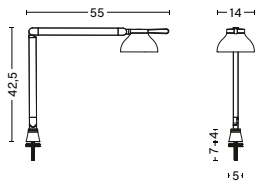

PC Task Double arm w. table base

Integrated LED, 5.7W, 407lm, 3100K cool white

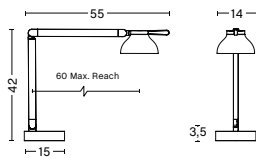

LBM Table Lamp

Integrated LED, 8W, 360lm, 2800K warm white

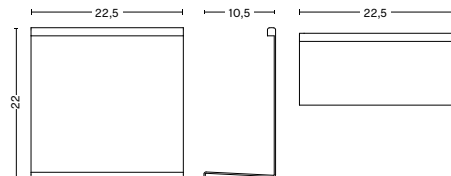

LBM Table Lamp

Integrated LED, 3W, 157lm, 2550K warm white

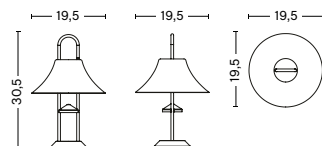

LIGHT SOURCE OVERVIEW

PRODUCT / INTEGRATED LED

LIGHT SOURCE

Matin Table Lamp S

Integrated LED, 5W, 150lm, 2800K warm white

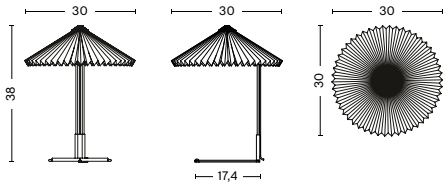

Matin Table Lamp M

Integrated LED, 5W, 150lm, 2800K warm white

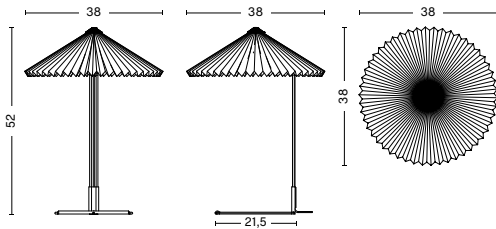

Matin Wall 300

Integrated LED, 5W, 150lm, 2800K warm white

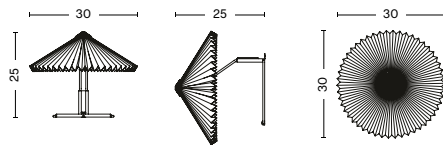

Matin Wall 380

Integrated LED, 5W, 150lm, 2800K Warm white

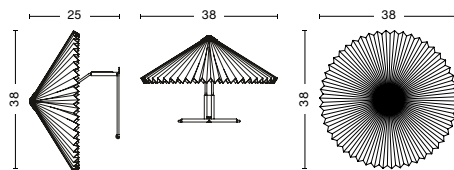

Matin Wall 380

Integrated LED, 12W, 420lm, 2600K Warm white

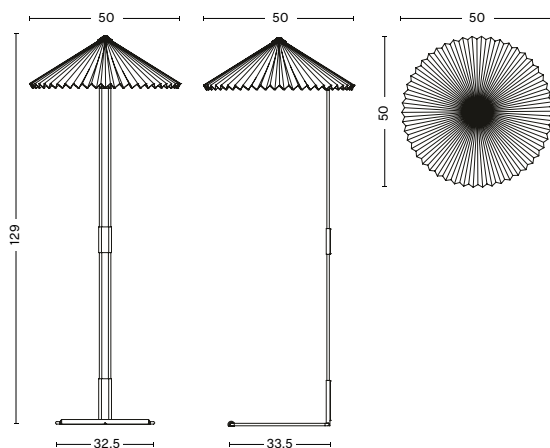

LIGHT SOURCE OVERVIEW

PRODUCT / INTEGRATED LED

LIGHT SOURCE

Fifty-Fifty Wall

Integrated LED, 7,7W, 700lm, 3100K cool white

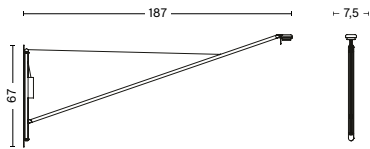

Fifty-Fifty Mini

Integrated LED, 4W, 360lm, 3000K warm white

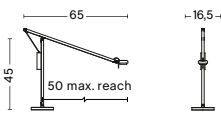

Fifty-Fifty Table Lamp

Integrated LED, 4W, 360lm, 3000K warm white

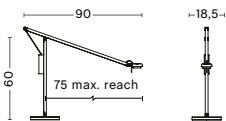

Fifty-Fifty Floor Lamp

Integrated LED, 4W, 360lm, 3000K warm white

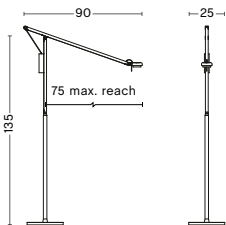

Marselis Table Lamp

Integrated LED, 4W, 213lm 2700K warm white

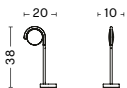

Marselis Floor Lamp

Integrated LED, 4W, 213lm 2700K warm white

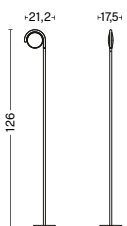

LIGHT SOURCE OVERVIEW

PRODUCT / INTEGRATED LED

LIGHT SOURCE

Turn on

Integrated LED, 4.5W, 250lm, 2700K warm white

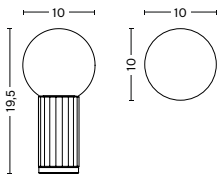

Rope Trick

Integrated LED, 10W, 410lm, 3000K warm white

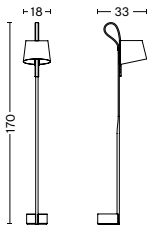

Parade Table Lamp | 160

Integrated LED, 5W, 150lm, 2800K warm white

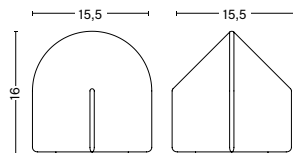

Parade Table Lamp | 240

Integrated LED, 5W, 150lm, 2800K warm white

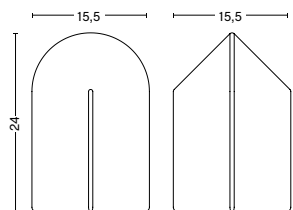

Parade Table Lamp | 320

Integrated LED, 5W, 150lm, 2800K warm white

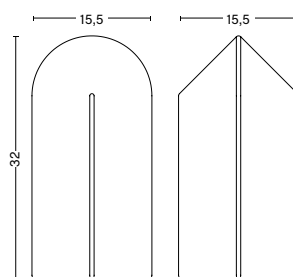

LIGHT SOURCE OVERVIEW

PRODUCT / INTEGRATED LED

LIGHT SOURCE

Neon Tube LED

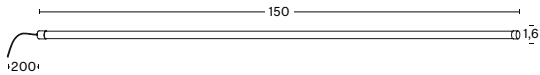

WARM WHITE | Integrated LED, 14W, 1463lm, 3000K warm white

RED | Integrated LED, 11W, 202lm, 1000K warm white

ICE BLUE | Integrated LED, 15W, 987lm, 3000K warm white

PINK | Integrated LED, 15W, 596lm, 1970K warm white

YELLOW | Integrated LED, 14W, 1111lm, 2000K warm white

Not dimmable, not connectable, no replaceble light source

Neon Tube LED Slim 50

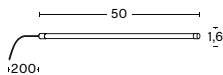

WARM WHITE | Integrated LED, 3,5W, 208lm, 3000K warm white

BLUE | Integrated LED, 3,5W, 117lm, 3000K warm white

PINK | Integrated LED, 3,5W, 75lm, 1970K warm white

YELLOW | Integrated LED, 3,5W, 190lm, 2000K warm white

Not dimmable, not connectable, no replaceble light source

Neon Tube LED Slim 120

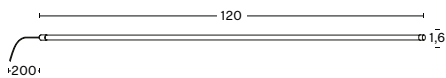

WARM WHITE | Integrated LED, 7,5W, 486lm, 3000K warm white

BLUE | Integrated LED, 7,5W, 117lm, 3000K warm white

PINK | Integrated LED, 7,5W, 144lm, 1970K warm white

YELLOW | Integrated LED, 7,5W, 375lm, 2000K warm white

Not dimmable, not connectable, no replaceble light source

HAY

COPYRIGHT / HAY 2021

WWW.HAY.COM