

Caméra - Camera - Kamera - Camera
Cámara - Videocamera - Câmara - Kamera

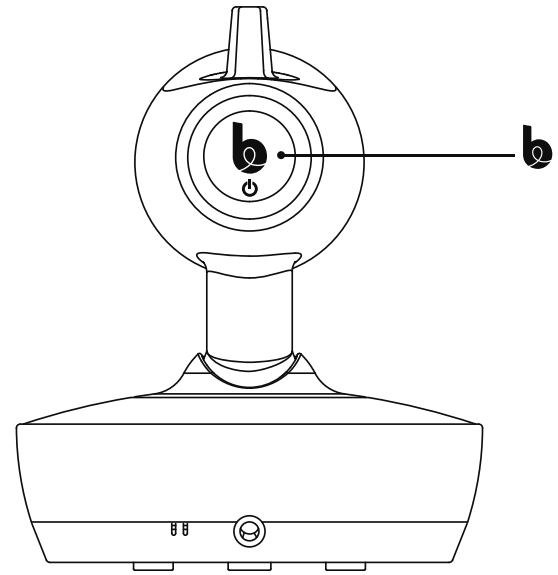
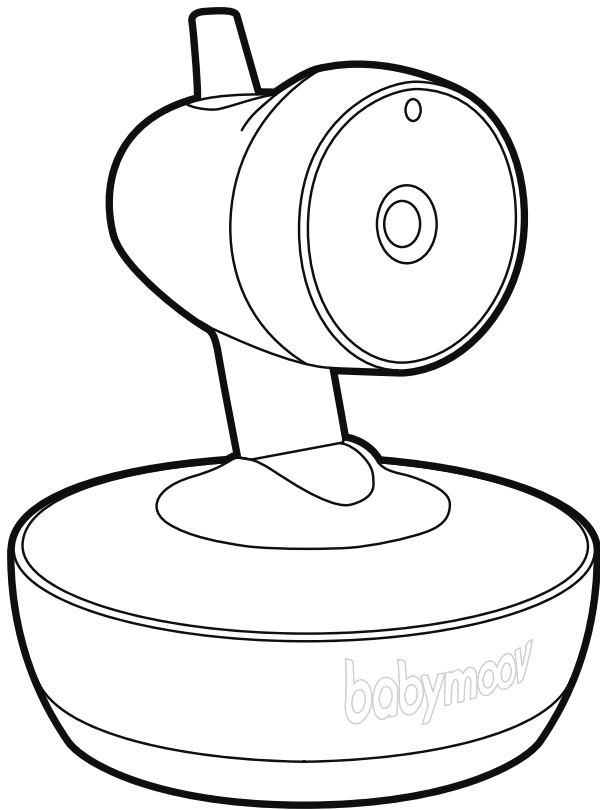

Récepteur - Receiver - Empfänger - Ontvanger
Receptor - Ricevitore - Receptor - Prijímač

Caméra additionnelle YOO Moov • Notice d'utilisation
Additional camera YOO Moov • Instructions for use
Zusatzkamera YOO Moov • Benutzungsanleitung
Extra camera YOO Moov • Gebruikshandleiding
Cámara adicional YOO Moov • Instrucciones de uso
Camera aggiuntiva YOO Moov • Istruzioni per l'uso
Cámara adicional YOO Moov • Instruções de uso
Přídavná kamera YOO Moov • Návod k použití

Réf. : A014418

Babymoov
Parc Industriel des Gravanches
16, rue Jacqueline Auriol
63051 Clermont-Ferrand 2 - France

Babymoov UK Ltd
3rd Floor, East Reach House
East Reach
Taunton - TA1 3EN - ENGLAND

Designed and engineered
by Babymoov in France



www.babymoov.com

A014418-Manual-Artwork-03

Illustrations et photographies non contractuelles

FR.

CONNEXION DE LA CAMÉRA AU RÉCEPTEUR

A. CONNEXION ENTRE LA CAMÉRA ET LE RÉCEPTEUR

Le processus de connexion (appairage) permet de connecter le récepteur avec la caméra de façon à ce qu'ils communiquent sans que d'autres appareils (même d'autres caméras YOO Moov) ne puissent interférer avec le récepteur ou recevoir votre signal.

1. Accédez au menu principal.
2. Sélectionnez la rubrique « Caméra ». Utilisez les boutons flèches ◀▶ présents sur le récepteur pour naviguer.

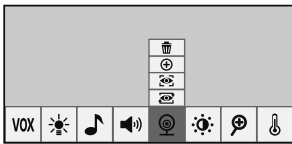

3. Sélectionnez la rubrique « Ajouter Caméra ». Utilisez les boutons flèches ▲▼ présents sur le récepteur pour naviguer.

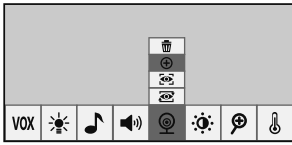

4. Appuyez sur le bouton Ⓢ pour valider.

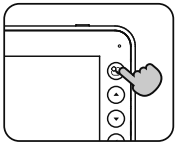

5. Choisissez cam1, cam2, cam3 ou cam4. Appuyez sur le bouton Ⓢ pour valider.

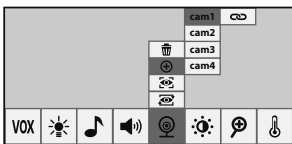

6. Allumez la caméra et appuyez 5 s sur b. Le bouton se met à clignoter et le « bip » signifie que la caméra est connectée au récepteur.

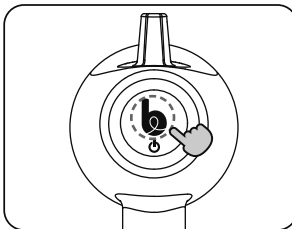

Félicitations ! Votre caméra est connectée!

N.B. : vous ne pouvez connecter au récepteur que des caméras YOO Moov. En cas d'échec de connexion, supprimez la caméra et refaites les étapes 1 à 6.

B. DÉCONNECTER UNE OU PLUSIEURS CAMÉRAS

1. Sélectionnez « Supprimer Caméra ».
2. Sélectionnez la caméra à supprimer.

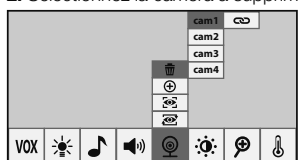

3. Appuyez sur le bouton Ⓢ pour valider.

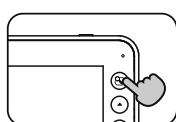

Valeurs de sortie nominales : 5.0 VDC - 1 000 mA

EN.

CONNECTING THE CAMERA TO THE RECEIVER

A. CONNECTION BETWEEN THE CAMERA AND THE RECEIVER

The connection process (pairing) links the receiver to the camera so that they can communicate without the risk of other appliances (even other YOO Moov cameras) interfering with the receiver or receiving your signal.

1. Access the main menu.
2. Select 'Camera'. Use the arrow buttons ◀▶ on the receiver to navigate.

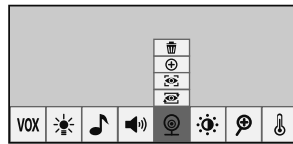

3. Select 'Add camera'. Use the arrow buttons on the receiver to navigate.

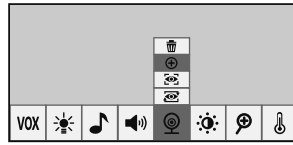

4. Press the Ⓢ button to confirm.

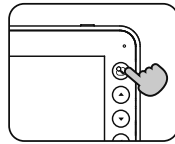

5. Select cam1, cam2, cam3 or cam4. Press the Ⓢ button to confirm.

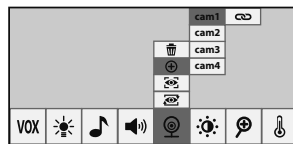

6. Turn on the camera and press for 5 seconds b. The button starts to flash and a 'beep' sound means the camera is connected to the receiver.

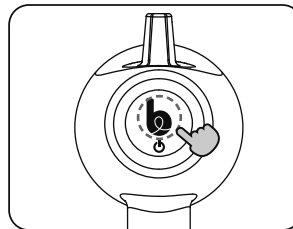

Congratulations!
Your camera is now connected!

N.B. You can only connect YOO Moov cameras to the receiver. If connection fails, delete the camera and repeat steps 1 to 6.

B. DISCONNECTING ONE OR MORE CAMERAS

1. Select 'Delete camera'.
2. Select the camera to be deleted.

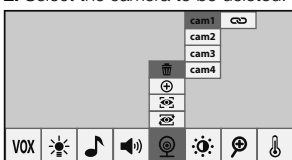

3. Press the Ⓢ button to confirm.

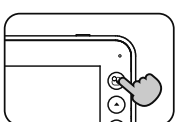

Nominal output values: 5.0 V DC - 1000 mA

DE.

VERBINDUNG DER KAMERA MIT DEM EMPFÄNGER HERSTELLEN

A. VERBINDUNG ZWISCHEN DER KAMERA UND DEM EMPFÄNGER HERSTELLEN

Mit dem Verbindungsprozess (Pairing) wird der Empfänger mit der Kamera verbunden, so dass sie kommunizieren, ohne dass andere Geräte (auch keine anderen YOO Moov-Kameras) mit dem Empfänger interferieren oder ihr Signal empfangen können.

1. Das Hauptmenü aufrufen.
2. Wählen sie die Rubrik "Kamera". Benutzen Sie die Pfeiltasten am Empfänger zum Navigieren ◀▶.

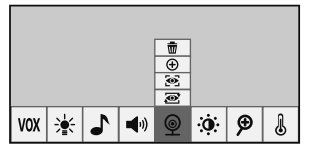

3. Wählen Sie den Abschnitt "Kamera hinzufügen". Benutzen Sie die Pfeiltasten am Empfänger zum Navigieren ◀▶.

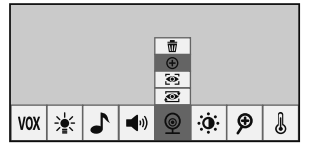

4. Drücken Sie die Taste Ⓢ, um zu bestätigen.

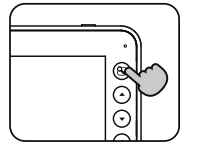

5. Wählen Sie cam1, cam2, cam3 oder cam4... Drücken Sie die Taste Ⓢ, um zu bestätigen.

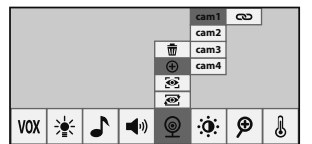

6. Schalten sie die Kamera ein und drücken Sie 5 sec b. Die Taste beginnt zu blinken und der Piepton zeigt an, dass die Kamera mit dem Empfänger verbunden ist.

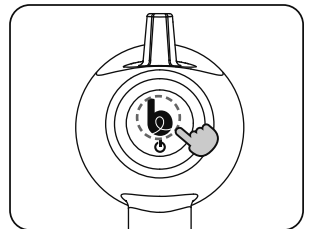

Bravo! Ihre Kamera ist verbunden!

Hinweis : Sie können nur YOO Moov-Kameras mit dem Empfänger verbinden. Wenn die Verbindung scheitert, löschen Sie die Kamera und wiederholen die Schritte 1 bis 6.

B. EINE KAMERA ODER MEHRERE KAMERAS TRENNEN

1. Wählen Sie „Kamera löschen“.
2. Wählen Sie die zu löschende Kamera.

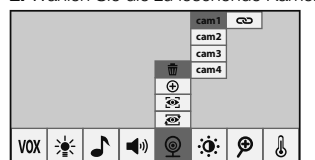

3. Drücken Sie die Taste Ⓢ, um zu bestätigen.

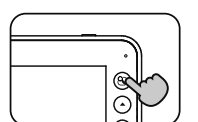

Ausgangswerte: 5.0 VDC - 1 000 mA



VAN DE CAMERA OP DE ONTVANGER

A. AANSLUITING TUSSEN DE CAMERA EN DE ONTVANGER

D.m.v. het verbindingproces (pairing) kan de ontvanger zodanig verbonden worden met de camera, dat deze met elkaar communiceren zonder dat andere apparaten (zelfs andere YOO Moov camera's) de ontvanger kunnen storen of uw signaal kunnen ontvangen.

1. Ga naar het hoofdmenu .

2. Selecteer de categorie "Camera".
Gebruik de pijltoetsen op de ontvanger om te scrollen.  .

3. Selecteer het gedeelte 'camera toevoegen'. Gebruik de pijltoetsen op de ontvanger om te scrollen.  .

4. Druk op de knop  om te valideren.

5. Kies **cam1**, **cam2**, **cam3** of **cam4**.
Druk op de knop  om te valideren.

6. Schakel de camera in en houd deze 5 seconden ingedrukt . De knop begint te knipperen en de pieptoon geeft aan dat de camera is aangesloten op de ontvanger.

Gefeliciteerd! Uw camera is aangesloten!

N.B. : u kunt uitsluitend YOO-Moov camera's aansluiten op de ontvanger. Als het aansluiten niet lukt, verwijder de camera dan en voer opnieuw de stappen 1 t/m 6 uit.

B. EEN OF MEERDERE CAMERA'S LOSMAKEN

1. Selecteer "Camera verwijderen".

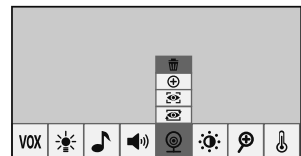

3. Druk op de knop  om te valideren.



Nominale uitgangswaarden: 5,0 VDC - 1 000 mA



LIGAÇÃO DA CÂMARA AO RECETOR

A. LIGAÇÃO ENTRE A CÂMERA E O RECETOR

O processo de ligação (emparelhamento) permite ligar o recetor à câmara de modo a comunicarem sem que outros dispositivos (inclusive outras câmaras YOO Moov) possam interferir com o recetor ou receber o seu sinal.

1. Aceda ao menu principal .

2. Selecciona a secção Utilize os botões das setas presentes no recetor para navegar  .

3. Selecciona a secção "adicionar câmara". Utilize os botões das setas presentes no recetor para navegar  .

4. Prima o botão  para validar.

5. Selecciona **cam1**, **cam2**, **cam3** ou **cam4**.
Prima o botão  para validar.

6. Ligue a câmara e pressione durante 5 segundos o botão . O botão começa a piscar e o "apito" indica que a câmara está ligada ao recetor.

Parabéns! A sua câmara está ligada!

N.B. : Você só pode conectar câmaras YOO MOOV ao receptor. Em caso de falha de conexão, apague a câmara e repita os passos 1 a 6.

B. DESLIGAR UMA OU MAIS CÂMARAS

1. Selecciona "Eliminar câmara".

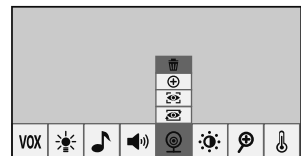

3. Prima o botão  para validar.



Valores de saída nominais: 5,0 VCC - 1.000 mA



CONEXIÓN DE LA CÁMARA AL RECEPTOR

A. CONEXIÓN ENTRE LA CÁMARA Y EL RECEPTOR

El proceso de conexión (vinculación) permite conectar el receptor con la cámara de forma que ambos se comuniquen sin que otros aparatos (incluidas otras cámaras YOO Moov) puedan interferir en el receptor o recibir la señal.

1. Acceda al menú principal .

2. Selecciona el apartado "Cámara".
Utilice los botones con flechas situados en el receptor para navegar  .

3. Selecciona la sección "agregar cámara". Utilice los botones con flechas situados en el receptor para navegar  .

4. Pulse el botón  para validar.

5. Selecciona **cam1**, **cam2**, **cam3** o **cam4**.
Pulse el botón  para validar.

6. Encienda la cámara y presione durante 5 segundos el botón . El botón empezará a parpadear. El pitido significa que la cámara está conectada al receptor.

*¡Enhorabuena! ;
Ya está conectada la cámara!*

Atención : solo puede conectar cámaras YOO Moov al receptor. En caso de que falle la conexión, elimine la cámara y repita los pasos del 1 al 6.

B. DESCONEXIÓN DE UNA O VARIAS CÁMARAS

1. Selecciona la opción "Eliminar cámara".

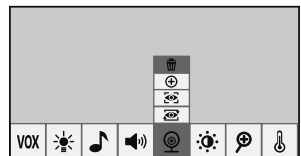

3. Pulse el botón  para validar.



Valores de salida nominales: 5,0 V CC - 1 000 mA

PROPOJENÍ KAMERY S PŘIJÍMAČEM

A. PROPOJENÍ MEZI KAMEROU A PŘIJÍMAČEM

Proces propojení (spárování) umožní propojit přijímač s kamerou takovým způsobem, že spolu komunikují, aniž by jiné přístroje (i kdyby šlo o jiné kamery YOO Moov) mohly interferovat s přijímačem nebo přijímat váš signál.

1. Vstupte do hlavního menu .

2. Vyberte sekci "přidat fotoaparát".
Použijte tlačítka se šipkami na přijímači  .

3. Pro procházení jednotlivými menu.
Použijte tlačítka se šipkami na přijímači  .

4. Pro potvrzení stiskněte tlačítko .

5. Zvolte **cam1**, **cam2**, **cam3** nebo **cam4**.
Pro potvrzení stiskněte tlačítko .

6. Zapněte aparát a během 5 sekund stiskněte tlačítko . Tlačítko začne blikat a „pípnutí“ potvrzuje, že kamera byla připojena k přijímači.

Gratulujeme! Vaše kamera je připojena.

Pozn. : k přijímači můžete připojit pouze kamery YOO Moov. V případě neúspěšného připojení odstraňte kameru a znovu proveďte etapy 1 až 6.

B. ODPOJENÍ JEDNÉ NEBO VÍCE KAMER

1. Vyberte „Odstranit kameru“.

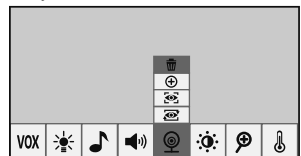

3. Pro potvrzení stiskněte tlačítko .



Jmenovité výstupní hodnoty: 5,0 VDC - 1 000 mA



CONNESSIONE DELLA VIDEOCAMERA AL RICEVITORE

A. COLLEGAMENTO TRA LA VIDEOCAMERA A IL RICEVITORE

Il processo di collegamento (abbinamento) permette di collegare il ricevitore con la videocamera in modo che comunichino senza che altri apparecchi (anche altre videocamere YOO Moov) possano interferire con il ricevitore o ricevere il vostro segnale.

1. Accedere al menu principale .

2. Selezionare la sezione "Videocamera".
Utilizzare i tasti freccia presenti sul ricevitore per navigare  .

3. Seleziona la sezione "aggiungi videocamera". Utilizzare i tasti freccia presenti sul ricevitore per navigare  .

4. Premere il tasto  per confermare.

5. Scegliere **cam1**, **cam2**, **cam3** o **cam4**.
Premere il tasto  per confermare.

6. Accendi la camera e premi per 5 secondi il pulsante . Il tasto si mette a lampeggiare e il "bip" indica che la videocamera è connessa al ricevitore.

*Congratulazioni!
La videocamera è collegata!*

N.B. : al ricevitore si possono collegare solo videocamere YOO Moov. In caso di collegamento fallito, eliminare la videocamera e ripetere i passaggi da 1 a 6.

B. SCOLLEGARE UNA O PIÙ VIDEOCAMERE

1. Selezionare "Eliminare videocamera".

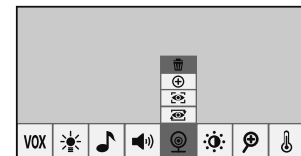

3. Premere il tasto  per confermare.

Valori nominali di uscita: 5,0 VDC - 1.000 mA



FR.
* **Garantie à vie.** Enregistrement sous 2 mois. Voir conditions sur le site web Babymoov.

EN.
* **Lifetime warranty.** Register within 2 months. See conditions at babymoov.co.uk.

DE.
* **Lebenslange Garantie.** Registrierung innerhalb von 2 Monaten. Nähere Informationen entnehmen Sie der Babymoov-Website.

NL.
* **Levenslange garantie.** Registratie binnen de 2 maanden. Voorwaarden beschikbaar op de Babymoov website.

ES.
* **Garantía de por vida.** Registrar en los 2 meses posteriores a la fecha de compra. Consulte las condiciones en la web de Babymoov.

IT.
* **Garanzia a vita.** La presente garanzia è subordinata a determinate condizioni. Elenco degli Paesi interessati, tempi di attivazione e informazioni on-line al seguente indirizzo: www.service-babymoov.com

PT.
* **Garantia vitalícia.** Esta garantia é subordinada a determinadas condições. A lista de países envolvidos, prazos de ativação e informações online no seguinte endereço: www.service-babymoov.com

CZ.
* **Doživotní záruka.** Tato záruka podléhá určitým podmínkám. Seznam zainteresovaných zemí, lhůta pro aktivaci záruky a on-line informace na adrese: www.service-babymoov.com